



This is a digital copy of a book that was preserved for generations on library shelves before it was carefully scanned by Google as part of a project to make the world's books discoverable online.

It has survived long enough for the copyright to expire and the book to enter the public domain. A public domain book is one that was never subject to copyright or whose legal copyright term has expired. Whether a book is in the public domain may vary country to country. Public domain books are our gateways to the past, representing a wealth of history, culture and knowledge that's often difficult to discover.

Marks, notations and other marginalia present in the original volume will appear in this file - a reminder of this book's long journey from the publisher to a library and finally to you.

Usage guidelines

Google is proud to partner with libraries to digitize public domain materials and make them widely accessible. Public domain books belong to the public and we are merely their custodians. Nevertheless, this work is expensive, so in order to keep providing this resource, we have taken steps to prevent abuse by commercial parties, including placing technical restrictions on automated querying.

We also ask that you:

- + *Make non-commercial use of the files* We designed Google Book Search for use by individuals, and we request that you use these files for personal, non-commercial purposes.
- + *Refrain from automated querying* Do not send automated queries of any sort to Google's system: If you are conducting research on machine translation, optical character recognition or other areas where access to a large amount of text is helpful, please contact us. We encourage the use of public domain materials for these purposes and may be able to help.
- + *Maintain attribution* The Google "watermark" you see on each file is essential for informing people about this project and helping them find additional materials through Google Book Search. Please do not remove it.
- + *Keep it legal* Whatever your use, remember that you are responsible for ensuring that what you are doing is legal. Do not assume that just because we believe a book is in the public domain for users in the United States, that the work is also in the public domain for users in other countries. Whether a book is still in copyright varies from country to country, and we can't offer guidance on whether any specific use of any specific book is allowed. Please do not assume that a book's appearance in Google Book Search means it can be used in any manner anywhere in the world. Copyright infringement liability can be quite severe.

About Google Book Search

Google's mission is to organize the world's information and to make it universally accessible and useful. Google Book Search helps readers discover the world's books while helping authors and publishers reach new audiences. You can search through the full text of this book on the web at <http://books.google.com/>

Gift of

John Rawlings



STANFORD UNIVERSITY LIBRARIES

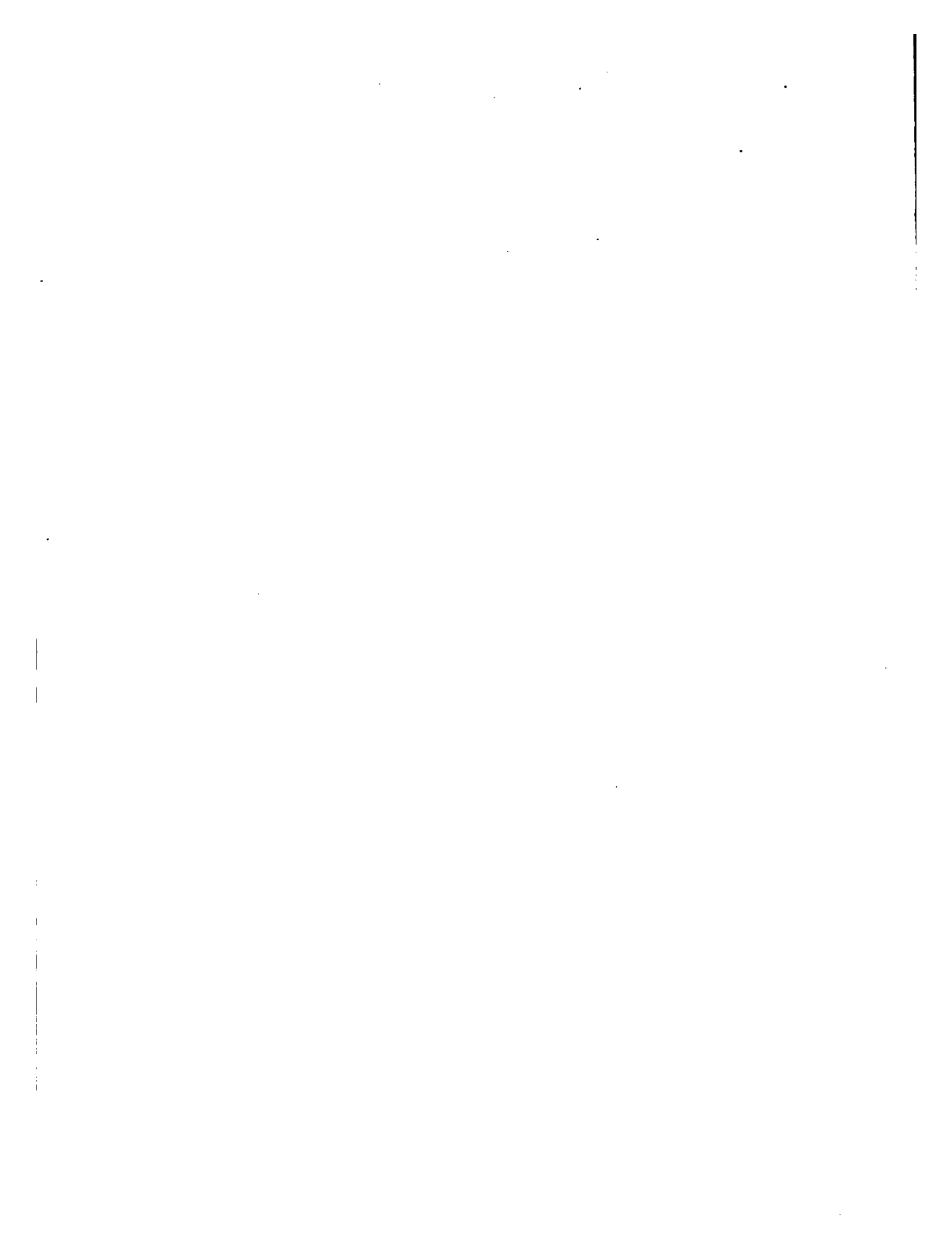

THE ENCYCLOPÆDIA BRITANNICA

ELEVENTH EDITION

FIRST	edition, published in three	volumes,	1768—1771.
SECOND	” ” ten	”	1777—1784.
THIRD	” ” eighteen	”	1788—1797.
FOURTH	” ” twenty	”	1801—1810.
FIFTH	” ” twenty	”	1815—1817.
SIXTH	” ” twenty	”	1823—1824.
SEVENTH	” ” twenty-one	”	1830—1842.
EIGHTH	” ” twenty-two	”	1853—1860.
NINTH	” ” twenty-five	”	1875—1889.
TENTH	” ninth edition and eleven supplementary volumes,		1902—1903.
ELEVENTH	” published in twenty-nine volumes,		1910—1911.

17

18

19

20

21

22

23

24

25

26

27

28

29

30

31

32

33

34

35

36

37

38

39

40

41

42

43

44

45

46

47

48

49

50

51

52

53

54

55

56

57

58

59

60

61

62

63

64

65

66

67

68

69

70

71

72

73

74

75

76

77

78

79

80

81

82

83

84

85

86

87

88

89

90

91

92

93

94

95

96

97

98

99

100

101

102

103

104

105

106

107

108

109

110

111

112

113

114

115

116

117

118

119

120

121

122

123

124

125

126

127

128

129

130

131

132

133

134

135

136

137

138

139

140

141

142

143

144

145

146

147

148

149

150

151

152

153

154

155

156

157

158

159

160

161

162

163

164

165

166

167

168

169

170

171

172

173

174

175

176

177

178

179

180

181

182

183

184

185

186

187

188

189

190

191

192

193

194

195

196

197

198

199

200

201

202

203

204

205

206

207

208

209

210

211

212

213

214

215

216

217

218

219

220

221

222

223

224

225

226

227

228

229

230

231

232

233

234

235

236

237

238

239

240

241

242

243

244

245

246

247

248

249

250

251

252

253

254

255

256

257

258

259

260

261

262

263

264

265

266

267

268

269

270

271

272

273

274

275

276

277

278

279

280

281

282

283

284

285

286

287

288

289

290

291

292

293

294

295

296

297

298

299

300

301

302

303

304

305

306

307

308

309

310

311

312

313

314

315

316

317

318

319

320

321

322

323

324

325

326

327

328

329

330

331

332

333

334

335

336

337

338

339

340

341

342

343

344

345

346

347

348

349

350

351

352

353

354

355

356

357

358

359

360

361

362

363

364

365

366

367

368

369

370

371

372

373

374

375

376

377

378

379

380

381

382

383

384

385

386

387

388

389

390

391

392

393

394

395

396

397

398

399

400

401

402

403

404

405

406

407

408

409

410

411

412

413

414

415

416

417

418

419

420

421

422

423

424

425

426

427

428

429

430

431

432

433

434

435

436

437

438

439

440

441

442

443

444

445

446

447

448

449

450

451

452

453

454

455

456

457

458

459

460

461

462

463

464

465

466

467

468

469

470

471

472

473

474

475

476

477

478

479

480

481

482

483

484

485

486

487

488

489

490

491

492

493

494

495

496

497

498

499

500

501

502

503

504

505

506

507

508

509

510

511

512

513

514

515

516

517

518

519

520

521

522

523

524

525

526

527

528

529

530

531

532

533

534

535

536

537

538

539

540

541

542

543

544

545

546

547

548

549

550

551

552

553

554

555

556

557

558

559

560

561

562

563

564

565

566

567

568

569

570

571

572

573

574

575

576

577

578

579

580

581

582

583

584

585

586

587

588

589

590

591

592

593

594

595

596

597

598

599

600

601

602

603

604

605

606

607

608

609

610

611

612

613

614

615

616

617

618

619

620

621

622

623

624

625

626

627

628

629

630

631

632

633

634

635

636

637

638

639

640

641

642

643

644

645

646

647

648

649

650

651

652

653

654

655

656

657

658

659

660

661

662

663

664

665

666

667

668

669

670

671

672

673

674

675

676

677

678

679

680

681

682

683

684

685

686

687

688

689

690

691

692

693

694

695

696

697

698

699

700

701

702

703

704

705

706

707

708

709

710

711

712

713

714

715

716

717

718

719

720

721

722

723

724

725

726

727

728

729

730

731

732

733

734

735

736

737

738

739

740

741

742

743

744

745

746

747

748

749

750

751

752

753

754

755

756

757

758

759

760

761

762

763

764

765

766

767

768

769

770

771

772

773

774

775

776

777

778

779

780

781

782

783

784

785

786

787

788

789

790

791

792

793

794

795

796

797

798

799

800

801

802

803

804

805

806

807

808

809

810

811

812

813

814

815

816

817

818

819

820

821

822

823

824

825

826

827

828

829

830

831

832

833

834

835

836

837

838

839

840

841

842

843

844

845

846

847

848

849

850

851

852

853

854

855

856

857

858

859

860

861

862

863

864

865

866

867

868

869

870

871

872

873

874

875

876

877

878

879

880

881

882

883

884

885

886

887

888

889

890

891

892

893

894

895

896

897

898

899

900

901

902

903

904

905

906

907

908

909

910

911

912

913

914

915

916

917

918

919

920

921

922

923

924

925

926

927

928

929

930

931

932

933

934

935

936

937

938

939

940

941

942

943

944

945

946

947

948

949

950

951

952

953

954

955

956

957

958

959

960

961

962

963

964

965

966

967

968

969

970

971

972

973

974

975

976

977

978

979

980

981

982

983

984

985

986

987

988

989

990

991

992

993

994

995

996

997

998

999

1000

1000

**THE
ENCYCLOPÆDIA BRITANNICA**

**A
DICTIONARY
OF
ARTS, SCIENCES, LITERATURE AND GENERAL
INFORMATION**

ELEVENTH EDITION

**VOLUME XXI
PAYN to POLKA**

**NEW YORK
THE ENCYCLOPÆDIA BRITANNICA COMPANY
1911**

1911

AGRICULTURE AND RURAL ECONOMY

NEW YORK

1911

THE ENCYCLOPEDIA BRITANNICA COMPANY
PUBLISHERS

Copyright, in the United States of America, 1911,

by

The Encyclopedia Britannica Company.

PRINTED IN GREAT BRITAIN

BY RICHARD CLAY AND COMPANY

THE ENCYCLOPEDIA BRITANNICA COMPANY
108 N. ZEEB ROAD, CHICAGO, ILL.
1911

INITIALS USED IN VOLUME XXI TO IDENTIFY INDIVIDUAL
CONTRIBUTORS, WITH THE HEADINGS OF THE
ARTICLES IN THIS VOLUME SO SIGNED.

A. B. R.	ALBERT BARTON RENDLE, M.A., D.Sc., F.R.S., F.L.S. Keeper, Department of Botany, British Museum. Author of <i>Text Book on Classification of Flowering Plants</i> ; &c.	Plants: Classification.
A. F. P.	ALBERT FREDERICK POLLARD, M.A., F.R.HIST.S. Professor of English History in the University of London. Fellow of All Souls' College, Oxford. Assistant Editor of the <i>Dictionary of National Biography</i> , 1893-1901. Lothian Prizeman, Oxford, 1892; Arnold Prizeman, 1898. Author of <i>England under the Protector Somerset</i> ; <i>Henry VIII.</i> ; <i>Life of Thomas Cromwell</i> ; &c.	Peter, Andrew.
A. G.	MAJOR ARTHUR GEORGE FREDERICK GRIFFITHS (d. 1908). H.M. Inspector of Prisons, 1878-1896. Author of <i>The Chronicles of Newgate</i> ; <i>Secrets of the Prison House</i> ; &c.	Palace.
A. G. T.	ARTHUR GEORGE TANSLEY, M.A., F.L.S. Lecturer in Botany in the University of Cambridge. Formerly Assistant Professor of Botany, University College, London.	Plants: Anatomy.
A. H.*	ALBERT HAUCK, D.Th., D.Ph. Professor of Church History in the University of Leipzig, and Director of the Museum of Ecclesiastical Archaeology. Geheimer Kirchenrat of the Kingdom of Saxony. Member of the Royal Saxon Academy of Sciences and Corresponding Member of the Academies of Berlin and Munich. Author of <i>Kirchengeschichte Deutschlands</i> ; &c. Editor of the new edition of Herzog's <i>Realencyclopädie für protestantische Theologie und Kirche</i> .	Pilgrimage.
A. H. G.	SIR ARTHUR HERBERT CHURCH, M.A., D.Sc., F.R.S., F.S.A. Professor of Chemistry, Royal Academy of Arts, London. Author of <i>Chemistry of Paints and Painting</i> ; <i>English Earthenware</i> ; <i>English Porcelain</i> ; &c.	Pigments.
A. H. H.	ARTHUR HORSLEY HINTON (1863-1908). Editor of <i>The Amateur Photographer</i> , 1897-1908, and the <i>Photographic Trades Gazette</i> , 1904-1908. Author of <i>Practical Pictorial Photography</i> ; &c.	Photography: Pictorial.
A. H.-S.	SIR A. HOUTUM-SCHINDLER, C.I.E. General in the Persian Army. Author of <i>Eastern Persian Irak</i> .	Persia: Geography and Statistics.
A. H. S.	REV. ARCHIBALD HENRY SAYCE, D.D., LL.D., Litt.D. See the biographical article: SAYCE, A. H.	Persopolis (in part).
A. J. G.	REV. ALEXANDER JAMES GNEVE, M.A., B.D. Professor of New Testament and Church History, Yorkshire United Independent College, Bradford. Sometime Registrar of Madras University, and Member of Mysore Educational Service.	Plymouth Brethren (in part).
A. J. H.	ALFRED J. HIPPINS, F.S.A. (1826-1902). Formerly Member of Council and Hon. Curator of the Royal College of Music, London. Member of Committee of the Inventions and Music Exhibition, 1886; of the Vienna Exhibition, 1892; and of the Paris Exhibition, 1900. Author of <i>Musical Instruments</i> ; &c.	Pianoforte (in part); Pich, Musical.
A. J. L.	ANDREW JACKSON LAMOUREUX. Librarian, College of Agriculture, Cornell University. Editor of the <i>Rio News</i> (Rio de Janeiro), 1879-1901.	Peru: Geography and Statistics.
A. Ma.	ALEXANDER MACALISTER, M.A., LL.D., M.D., D.Sc., F.R.S. Professor of Anatomy in the University of Cambridge, and Fellow of St John's College. Author of <i>Text Book of Human Anatomy</i> ; &c.	Phrenology; Physiognomy.
A. N.	ALFRED NEWTON, F.R.S. See the biographical article: NEWTON, ALFRED.	Pheasant; Pelican; Penguin; Petrel; Pheasant; Pigeon; Pipit; Pitta; Plover; Pochard.

* A complete list, showing all individual contributors, appears in the final volume.

INITIALS AND HEADINGS OF ARTICLES

- A. Sa.*** ADAM SEDGWICK, M.A., F.R.S.
Professor of Zoology at the Imperial College of Science and Technology, London. Fellow, and formerly Tutor, of Trinity College, Cambridge. Professor of Zoology in the University of Cambridge, 1907-1909. } **Peripatet.**
- A. Sl.** ARTHUR SHADWELL, M.A., M.D., LL.D.
Member of Council of Epidemiological Society. Author of *The London Water-Supply; Industrial Efficiency; Drink, Temperance and Legislation.* } **Fungus (in part),**
- A. S. P.-P.** ANDREW SETH PRINGLE-PATTISON, M.A., LL.D., D.C.L.
Professor of Logic and Metaphysics in the University of Edinburgh. Gifford Lecturer in the University of Aberdeen, 1911. Fellow of the British Academy. Author of *Man's Place in the Cosmos; The Philosophical Radicals; &c.* } **Philosophy.**
- A. S. Wo.** ARTHUR SMITH WOODWARD, LL.D., F.R.S.
Keeper of Geology, Natural History Museum, South Kensington. Secretary of the Geological Society of London. } **Pliosaurus.**
- A. T. L.** ALEXANDER TAYLOR INNES, M.A., LL.D.
Scotch Advocate. Author of *Johs Knox; Law of Credits in Scotland; Studies in Scottish History; &c.* } **Pilate, Pontius.**
- B. R.** SIR BOVERTON REDWOOD, D.Sc., F.R.S.(Edin.), F.I.C., ASSOC.INST.C.E., M.INST.M.E.
Adviser on Petroleum to the Admiralty, Home Office, India Office, Corporation of London, and Port of London Authority. President of the Society of Chemical Industry. Member of the Council of the Chemical Society. Member of Council of Institute of Chemistry. Author of "Cantor" *Lectures on Petroleum; Petroleum and its Products; Chemical Technology; &c.* } **Petroleum.**
- C. Bl.** REV. CHARLES BIGG, M.A., D.D. (1840-1908).
Regius Professor of Ecclesiastical History in the University of Oxford, and Canon of Christ Church, 1901-1908. Formerly Senior Student and Tutor of Christ Church. Headmaster of Brighton College. Author of *The Christian Platonists of Alexandria; &c.* } **Philo (in part).**
- C. E.*** CHARLES EVERITT, M.A., F.C.S., F.G.S., F.R.A.S.
Sometime Scholar of Magdalen College, Oxford. } **Phosphates.**
- C. E. A.** CHARLES EDWARD AKERS.
Formerly Times Correspondent in Buenos Aires. Author of *A History of South America, 1854-1904.* } **Peru: History (in part).**
- C. E. M.** CHARLES EDWARD MOSS, D.Sc.
Emmanuel College, Cambridge. Curator of the University Herbarium. } **Plants: Ecology.**
- C. G. K.** CARROLL GILSTON KNOTT, D.Sc.
Lecturer on Applied Mathematics, Edinburgh University. Professor of Physics, Imperial University of Japan, Tokyo, 1883-1891. Author of *Electricity and Magnetism; Physics; &c.* } **Photometry.**
- C. L. K.** CHARLES LETHBRIDGE KINGSFORD, M.A., F.R.HIST.S., F.S.A.
Assistant Secretary to the Board of Education. Author of *Life of Henry V. Editor of Chronicles of London and Stow's Survey of London.* } **Payne, Peter.**
- C. M.** CARL THEODOR MIRST, D.TH.
Professor of Church History in the University of Marburg. Author of *Publizistik im Zeitalter Gregor VII.; Quellen zur Geschichte des Papsttums; &c.* } **Pius IX.;
Poincy, Colloquy of.**
- C. Pl.** CHRISTIAN PILSTER, D. ÈS. L.
Professor at the Sorbonne, Paris. Chevalier of the Legion of Honour. Author of *Études sur le règne de Robert le Pieux.* } **Pippin I-III.**
- C. P. J.** CHARLES PIERPOINT JOHNSON (1791-1880).
Lecturer on Botany, Guy's Hospital, London, 1830-1873. Editor of *J. A. Sowerby's English Botany; &c.* Author of *Ferns of Great Britain; &c.* } **Pine.**
- C. R. M.** SIR CLEMENTS ROBERT MARSHAM, K.C.B., F.R.S.
See the biographical article: MARSHAM, SIR CLEMENTS ROBERT. } **Peru: History (in part).**
- C. S. P.** THE RT. HON. CHARLES STUART PARKER, LL.D., D.C.L. (1829-1910).
M.P. for Perthshire, 1868-1874; M.P. for Perth City, 1878-1892. Honorary Fellow, formerly Fellow of University College, Oxford. Author of *Life of Sir Robert Peel; &c.* } **Peel, Sir Robert.**
- C. T.*** REV. CHARLES TAYLOR, M.A., D.D., LL.D. (1840-1908).
Master of St John's College, Cambridge, 1881-1908. Vice-Chancellor, 1887-1888. Author of *Geometrical Conics; &c.* } **Pirke Abeth.**
- C. W. R.** MAJOR-GENERAL CHARLES WALKER ROBINSON, C.B., D.C.L.
Assistant Military Secretary, Headquarters of the Army, 1890-1892. Lieut.-Governor and Secretary, Royal Military Hospital, Chelsea, 1895-1898. Author of *Strategy of the Peninsular War; &c.* } **Peninsular War.**
- D. G. H.** DAVID GEORGE HOGARTH, M.A.
Keeper of the Ashmolean Museum, Oxford. Fellow of Magdalen College, Oxford. Fellow of the British Academy. Excavated at Paphos, 1888; Naucratis, 1899 and 1903; Ephesus, 1904-1905; Assiut, 1906-1907. Director, British School at Athens, 1897-1900. Director, Cretan Exploration Fund, 1899. } **Perga;
Pergamum;
Phoenax.**

- D. H.** DAVID HANNAY.
Formerly British Vice-Consul at Barcelona. Author of *Short History of the Royal Navy; Life of Emilio Castelar; &c.*
- E. A. J.** E. ALFRED JONES.
Author of *Old English Gold Plate; Old Church Plate of the Isle of Man; Old Silver Sacramental Vessels of Foreign Protestant Churches in England; Illustrated Catalogue of Leopold de Rothschild's Collection of Old Plate; A Private Catalogue of the Royal Plate at Windsor Castle; &c.*
- E. A. So.** EDWARD ADOLF SONNENSCHNEN, M.A., LITT.D.
Professor of Greek and Latin in the University of Birmingham. Hon. Secretary of the Classical Association. Professor of Greek and Latin in Mason College, Birmingham, 1883-1900. Editor of several of the plays of Plautus.
- E. B.** ERNEST BAKER, M.A.
Fellow and Lecturer in Modern History, St John's College, Oxford. Formerly Fellow and Tutor of Merton College. Craven Scholar, 1893.
- E. G.** EDMUND GOSSE, LL.D., D.C.L.
See the biographical article: GOSSE, EDMUND.
- E. Gr.** ERNEST ARTHUR GARDNER, M.A.
See the biographical article: GARDNER, PERCY.
- E. J. D.** EDWARD JOSEPH DENT, M.A., MUS.BAC.
Formerly Fellow of King's College, Cambridge.
- Ed. M.** EDUARD MEYER, PH.D., D.LITT., LL.D.
Professor of Ancient History in the University of Berlin. Author of *Geschichte des Alterthums; Geschichte des alten Aegypten; Die Israeliten und ihre Nachbarstämme.*
- E. M. H.** EDWARD MORELL HOLMES.
Curator of the Museum of the Pharmaceutical Society, London.
- E. O.°** EDMUND OWEN, F.R.C.S., LL.D., D.Sc.
Consulting Surgeon to St Mary's Hospital, London, and to the Children's Hospital, Great Ormond Street, London. Chevalier of the Legion of Honour. Late Examiner in Surgery at the Universities of Cambridge, London and Durham. Author of *A Manual of Anatomy for Senior Students.*
- E. O'N.** ELIZABETH O'NEILL, M.A. (MRS H. O. O'NEILL).
Formerly University Fellow and Jones Fellow of Manchester University.
- E. Pr.** EDGAR PRESTAGE.
Special Lecturer in Portuguese Literature in the University of Manchester. Examiner in Portuguese in the Universities of London, Manchester, &c. Commandador, Portuguese Order of S. Thiago. Corresponding Member of Lisbon Royal Academy of Sciences, Lisbon Geographical Society; &c. Editor of *Letters of a Portuguese Nun; Azurara's Chronicle of Guinea; &c.*
- E. R. B.** EDWYN ROBERT BEVAN, M.A.
New College, Oxford. Author of *The House of Seleucus; Jerusalem under the High Priests.*
- E. S.°** EMIL SCHÜRER, D.Ph. (1844-1910).
Formerly Professor of New Testament Exegesis in the Universities of Giessen, Kiel and Göttingen. Author of *Geschichte des jüdischen Volkes im Zeitalter Jesu Christi; &c.*
- E. Th.** REV. ETHELRED LUKE TAUNTON (d. 1907).
Author of *The English Black Monks of St Benedict; History of the Jesuits in England.*
- F. A. P.** FREDERICK ANTHONY PALEY, LL.D.
See the biographical article, PALEY, F. A.
- F. G. P.** FREDERICK GYMER PARSONS, F.R.C.S., F.Z.S., F.R.ANTHROP.INST.
Vice-President, Anatomical Society of Great Britain and Ireland. Lecturer on Anatomy at St Thomas's Hospital and the London School of Medicine for Women, London. Formerly Hunterian Professor at the Royal College of Surgeons.
- F. J. G.** MAJOR-GENERAL SIR FREDERIC JOHN GOLDSMID.
See the biographical article: GOLDSMID (family).
- F. LL. G.** FRANCIS LLEWELLYN GRIFFITH, M.A., PH.D., F.S.A.
Reader in Egyptology, Oxford University. Editor of the Archaeological Survey and Archaeological Reports of the Egypt Exploration Fund. Fellow of Imperial German Archaeological Institute. Formerly Assistant Professor of Egyptology in University College, London. Author of *Stories of the High Priests of Memphis; &c.*
- F. N.** FRIDTJOF NANSEN.
See the biographical article: NANSEN, FRIDTJOF.
- F. W. G.** FREDERICK WILLIAM GAMBLE, D.Sc., M.Sc., F.R.S.
Professor of Zoology, Birmingham University. Formerly Assistant Director of the Zoological Laboratories, and Lecturer in Zoology, University of Manchester. Author of *Animal Life. Editor of Marshall and Hurst's Practical Zoology; &c.*
- Penn, Admiral; Peppys;
Pescara, Marquis of;
Peter I-IV. of Aragon;
Peter of Castile;
Pirate and Piracy; History;
Poe, Edgar Allan;
Poland; History (in part).
- Plate (in part).
- Plautus.
- Peter the Hermit.
- Pindarus.
- Phigalia.
- Pergolesi.
- Perù;
Persia; Ancient History;
Persia; Pharnabazus;
Pharates; Pharoetes.
- Pharmacopoeia;
Pharmacy.
- Peritonitis;
Pharyngitis;
Phlebitis.
- Pockham, John.
- Pina, Ray de;
Pinto, Fernão Mendes.
- Perdiccas;
Philip I., II., and V. of Macedonia.
- Philo (in part).
- Pole, Cardinal.
- Plutarch (in part).
- Pharynx;
Plicata.
- Persia; History, 1495-1824 (in part).
- Palusium;
Pharaoh;
Philoæ;
Pithon.
- Polar Regions (in part).
- Planarians;
Platyhelms.

- F. W. E.*** **FREDERICK WILLIAM RUDLER, I.S.O., F.G.S.**
Curator and Librarian of the Museum of Practical Geology, London, 1879-1902.
President of the Geologists' Association, 1887-1889. { **Periodot; Phosphates;**
Mineral Phosphates (in part).
- G. A. C.*** **REV. GEORGE ALBERT COOKE, D.D.**
Oriol Professor of the Interpretation of Holy Scripture, Oxford, and Fellow of Oriol College. Canon of Rochester. Hon. Canon of St Mary's Cathedral, Edinburgh. Author of *Text Book of North Semitic Inscriptions*; &c. { **Petra;**
Phoenicia.
- G. A. Gr.** **GEORGE ABRAHAM GRIERSON, C.I.E., PH.D., D.LITT.**
Indian Civil Service, 1873-1903. In charge of Linguistic Survey of India, 1898-1902. Gold Medalist, Royal Asiatic Society, 1909. Vice-President of the Royal Asiatic Society. Formerly Fellow of Calcutta University. Author of *The Languages of India*; &c. { **Pisaca Languages.**
- G. Ch.** **GEORGE CRYSTAL, M.A., LL.D.**
Professor of Mathematics and Dean of the Faculty of Arts, Edinburgh University. Hon. Fellow and formerly Fellow and Lecturer, Corpus Christi College, Cambridge. { **Perpetual Motion.**
- G. C. W.** **GEORGE CHARLES WILLIAMSON, LITT.D.**
Chevalier of the Legion of Honour. Author of *Portrait Miniatures: Life of Richard Cosway, R.A.*; *George Engleheart; Portrait Drawings*; &c. Editor of New Edition of Bryan's *Dictionary of Painters and Engravers*. { **Petitot, Jean; Petitot, J. Louis;**
Pinwell, George John;
Pinzer, Andrew;
Pinzer, Nathaniel;
Pinzango Drawings.
- G. E.** **REV. GEORGE EDMUNDSON, M.A., F.R.HIST.S.**
Fellow and Tutor of Brasenose College, Oxford. Ford's Lecturer, 1909. Hon. Member, Dutch Historical Society; and Foreign Member, Netherlands Association of Literature. { **Pensionary;**
Peru: History (in part).
- G. E.*** **ROBERT GEOFFREY ELLIS.**
Peterhouse, Cambridge. Barrister-at-Law, Inner Temple. Joint-editor of *English Reports*. Author of *Peerage Law and History*. { **Peerage.**
- G. E. C.** **GEORGE EARL CHURCH.**
See the biographical article: CHURCH, G. E. { **Plata, Ho de la.**
- G. G. P.*** **GEORGE GRENVILLE PHILLMORE, M.A., B.C.L.**
Christ Church, Oxford. Barrister-at-Law, Middle Temple. { **Pilot (in part).**
- G. H. Bo.** **REV. GEORGE HERBERT BOX, M.A.**
Rector of Sutton Sandy, Beds. Formerly Hebrew Master, Merchant Taylors' School, London. Lecturer in Faculty of Theology, University of Oxford, 1908-1909. Author of *Translation of Book of Isaiah*; &c. { **Phylactery (in part).**
- G. H. Fo.** **GEORGE HERBERT FOWLER, F.Z.S., F.L.S., PH.D.**
Formerly Berkeley Research Fellow, Owens College, Manchester, and Assistant Professor of Zoology at University College, London. { **Planktion.**
- G. W. R.** **GEORGE WILLIAM REDWAY.**
Author of *The War of Secession, 1861-1862*; *Fredericksburg: a Study in War*, { **Petersburg Campaign:**
(1862-1865).
- H. B.** **HIRAM BINGHAM, A.M., PH.D.**
Assistant Professor of Latin-American History, Yale University. Albert Shaw Lecturer on Diplomatic History, Johns Hopkins University. Author of *Journal of an Expedition across Venezuela and Colombia*; &c. { **Philippine Islands: History.**
- H. Cl.** **SIR HUGH CHARLES CLIFFORD, K.C.M.G.**
Colonial Secretary, Ceylon. Fellow of the Royal Colonial Institute. Formerly Resident, Pahang. Colonial Secretary, Trinidad and Tobago, 1903-1907. Author of *Studies in Borneo Humanity; Further India*; &c. Joint-author of *A Dictionary of the Malay Language*. { **Penang.**
- H. De.** **HIPPOLYTE DELEHAYE, S.J.**
Assistant in the compilation of the Bollandist publications: *Analecta Bollandiana* and *Acta Sanctorum*. { **Polegis, St.**
- H. E.** **KARL HERMANN ETHE, M.A., PH.D.**
Professor of Oriental Languages, University College, Aberystwyth (University of Wales). Author of *Catalogue of Persian Manuscripts in the India Office Library, London* (Clarendon Press); &c. { **Persia: Literature.**
- H. F. G.** **HANS FRIEDRICH GADOW, F.R.S., PH.D.**
Strickland Curator and Lecturer on Zoology in the University of Cambridge. Author of "Amphibia and Reptiles" in the *Cambridge Natural History*. { **Phororhænes.**
- H. G. de W.** **HERMANN G. DE WATTEVILLE.**
Instructor, Staff College, Camberley, Surrey. { **Plymouth (England).**
- H. H. T.** **HERBERT HALL TURNER, M.A., D.Sc., D.C.L., F.R.S.**
Savilian Professor of Astronomy in the University of Oxford and Fellow of New College. President of the Royal Astronomical Society, 1903-1904. Author of *Modern Astronomy*; &c. { **Photography, Celestial;**
Photometry, Celestial.
- H. L. H.** **HARRIET L. HENNESSY, M.D. (BRIT.), L.R.C.P.I., L.R.C.S.I.** { **Pharmacology: Terminology;**
Plague (in part).
- H. M. W.** **HARRY MARSHALL WARD, M.A., D.Sc., F.R.S. (d. 1905).**
Formerly Professor of Botany, University of Cambridge, and Fellow of Sidney Sussex College. President of the British Mycological Society. Author of *Timber and Some of its Diseases; The Oak; Sack's Lectures on the Physiology of Plants; Diseases in Plants*; &c. { **Plants: Pathology.**

INITIALS AND HEADINGS OF ARTICLES

IX

H. R. H.	<p>HARRY REGINALD HOLLAND HALL, M.A. Assistant in the Department of Egyptian and Assyrian Antiquities, British Museum. Author of <i>The Oldest Civilisation of Greece</i>; &c.</p>	}	Plate (in part).
H. R. K.	<p>HARRY ROBERT KEMPE, M.INST.C.E. Electrician to the General Post Office, London. Author of <i>The Engineer's Year Book</i>; &c.</p>	}	Pneumatic Despatch.
H. R. M.	<p>HUGH ROBERT MILL, D.Sc., LL.D. Director of British Rainfall Organization. Editor of <i>British Rainfall</i>. President of the Royal Meteorological Society, 1907-1908. Hon. Member of Vienna Geographical Society. Hon. Corresponding Member of Geographical Societies of Paris, Berlin, Budapest, St Petersburg, Amsterdam, &c. Author of <i>The Realm of Nature</i>; <i>The International Geography</i>; &c.</p>	}	Polar Regions.
H. R. T.	<p>HENRY RICHARD TEDDER, F.S.A. Secretary and Librarian of the Athenaeum Club, London.</p>	}	Periodicals.
H. Sc.	<p>HENRY SCHERREN, F.Z.S. Assistant Natural History Editor of <i>The Field</i>. Author of <i>Popular History of Animals for Young People</i>; <i>Pond and Rock Pools</i>; &c.</p>	}	Platypus (in part).
H. Sw.	<p>HENRY SWEET, M.A., PH.D., LL.D. University Reader in Phonetics, Oxford. Corresponding Member of the Academies of Munich, Berlin, Copenhagen and Helsinki. Author of <i>A History of English Sounds since the Earliest Period</i>; <i>A Primer of Phonetics</i>; &c.</p>	}	Phonetics.
H. S.-K.	<p>SIR HENRY SETON-KARR, C.M.G., M.A. M.P. for St Helen's, 1885-1906. Author of <i>My Sporting Holidays</i>; &c.</p>	}	Pistol.
H. S. J.	<p>HENRY STUART JONES, M.A. Formerly Fellow and Tutor of Trinity College, Oxford, and Director of the British School at Rome. Member of the German Imperial Archaeological Institute. Author of <i>The Roman Empire</i>; &c.</p>	}	Plate (in part).
H. W. A.	<p>HAROLD W. T. WAGER, F.R.S. H.M. Inspector of Secondary Schools, Board of Education, London. President, Botanical Section, British Association, 1905. Author of <i>Memoirs on the Structure of the Ferns</i>; &c.</p>	}	Plants: Cytology.
H. W. G. D.	<p>HENRY WILLIAM CARLESS DAVIS, M.A. Fellow and Tutor of Balliol College, Oxford. Fellow of All Souls' College, Oxford, 1895-1902. Author of <i>England under the Normans and Angevins</i>; <i>Charlemagne</i>.</p>	}	Peter des Roches.
I. A.	<p>ISRAEL ABRAHAMS, M.A. Reader in Talmudic and Rabbinic Literature in the University of Cambridge. Formerly President, Jewish Historical Society of England. Author of <i>A Short History of Jewish Literature</i>; <i>Jewish Life in the Middle Ages</i>; <i>Judaism</i>; &c.</p>	}	Peries, Joseph.
I. G.	<p>ISRAEL GOLLANZ, M.A., LITT.D. Professor of English Language and Literature, King's College, London, and Dean of the Faculty of Arts, University of London. Fellow and Secretary of the British Academy. Editor of <i>The Pearl</i>; The "Temple" Shakespeare; &c.</p>	}	Pearl, The.
J. A. H.	<p>JOHN ALLAN HOWE, B.Sc. Curator and Librarian of the Museum of Practical Geology, London. Author of <i>The Geology of Building Stones</i>.</p>	}	Permian; Pleistocene; Pliocene.
J. A. S.	<p>JOHN ADDINGTON SYMONDS, LL.D., D.C.L. See the biographical article: SYMONDS, J. A.</p>	}	Petrarch; Poggio; Pellikan.
J. Bt.	<p>JAMES BARTLETT. Lecturer on Construction, Architecture, Sanitation, Quantities, &c., at King's College, London. Member of Society of Architects. Member of Institute of Junior Engineers. Author of <i>Quantities</i>.</p>	}	Plaster-work.
J. D. B.	<p>JAMES DAVID BOURCHIER, M.A., F.R.G.S. King's College, Cambridge. Correspondent of <i>The Times</i> in South-Eastern Europe. Commander of the Order of Prince Danilo of Montenegro and of the Saviour of Greece, and Officer of the Order of St Alexander of Bulgaria.</p>	}	Philippl.
J. E. S. ^a	<p>JOHN EDWIN SANDYS, M.A., LITT.D., LL.D. Public Orator in the University of Cambridge, and Fellow of St John's College. Fellow of the British Academy. Author of <i>History of Classical Scholarship</i>; &c.</p>	}	Pliny the Elder; Pliny the Younger.
J. F.-K.	<p>JAMES FITZMAURICE-KELLY, LITT.D., F.R.HIST.S. Gilmour Professor of Spanish Language and Literature, Liverpool University. Norman McColl Lecturer, Cambridge University. Fellow of the British Academy. Member of the Royal Spanish Academy. Knight Commander of the Order of Alphonso XII. Author of <i>A History of Spanish Literature</i>; &c.</p>	}	Pareda, José Maria de; Pérez Galdos, Benito; Piscataqua Novel, The.
J. F. P.	<p>JOSEPH FRANK PAYNE, M.D., F.R.C.P. (1840-1910). Formerly Harveian Librarian, Royal College of Physicians. Hon. Fellow of Magdalen College, Oxford. Fellow of University of London. Author of <i>Lectures on Anglo-Saxon Medicine</i>; &c.</p>	}	Plague (in part).
J. Ga.	<p>JAMES GAIRDNER, C.B., LL.D. See the biographical article: GAIRDNER, JAMES.</p>	}	Perey: family (in part).
J. G. C. A.	<p>JOHN GEORGE CLARE ANDERSON, M.A. Student, Censor and Tutor of Christ Church, Oxford. Formerly Fellow of Lincoln College. Craven Fellow (Oxford), 1896. Coington Prizeman, 1893.</p>	}	Pessinus.

INITIALS AND HEADINGS OF ARTICLES

- J. G. Fr.** JAMES GEORGE FRAZER, M.A., D.C.L., LL.D., LITT.D.
Professor of Social Anthropology, Liverpool University, and Fellow of Trinity College, Cambridge. Fellow of the British Academy. Author of *The Golden Bough*; &c.
- J. H. A. H.** JOHN HENRY ARTHUR HART, M.A.
Fellow, Theological Lecturer and Librarian, St John's College, Cambridge.
- J. H. M.** JOHN HENRY MIDDLETON, M.A., LITT.D., F.S.A., D.C.L. (1846-1896).
Slade Professor of Fine Art in the University of Cambridge, 1886-1895. Director of the Fitzwilliam Museum, Cambridge, 1889-1892. Art Director of the South Kensington Museum, 1892-1896. Author of *The Engraved Gems of Classical Times; Illuminated Manuscripts in Classical and Medieval Times*.
- J. H. R.** JOHN HORACE ROUND, M.A., LL.D.
Balliol College, Oxford. Author of *Federal England; Studies in Peerage and Family History; Peerage and Pedigree*.
- J. H. V. G.** JOHN HENRY VERRINDER CROWE.
Lieut.-Colonel, Royal Artillery. Commandant of the Royal Military College of Canada. Formerly Chief Instructor in Military Topography and Military History and Tactics at the Royal Military Academy, Woolwich. Author of *Epitome of the Russo-Turkish War, 1877-1878*; &c.
- J. L. M.** JOHN LINTON MYRES, M.A., F.S.A., F.R.G.S.
Wyleham Professor of Ancient History in the University of Oxford, and Fellow of Magdalen College. Formerly Gladstone Professor of Greek and Lecturer in Ancient Geography, University of Liverpool. Lecturer in Classical Archaeology in University of Oxford, and Student and Tutor of Christ Church. Author of *A History of Rome*; &c.
- J. L. W.** JESSIE LADLAY WESTON.
Author of *Arthurian Romances unrepresented in Malory*.
- J. M.** JAMES MOFFATT, M.A., D.D.
Minister of the United Free Church of Scotland. Author of *Historical New Testament*; &c.
- J. M. M.** JOHN MALCOLM MITCHELL.
Sometime Scholar of Queen's College, Oxford. Lecturer in Classics, East London College (University of London). Joint-editor of Grote's *History of Greece*.
- J. P. P.** JOHN PERCIVAL POSTGATE, M.A., LITT.D.
Professor of Latin in the University of Liverpool. Fellow of Trinity College, Cambridge. Fellow of the British Academy. Editor of the *Classical Quarterly*. Editor-in-chief of the *Corpus Poetarum Latinorum*; &c.
- J. R. C.** JOSEPH ROGERSON COTTER, M.A.
Assistant to the Professor of Natural and Experimental Philosophy, Trinity College, Dublin. Editor of 2nd edition of Preston's *Theory of Heat*.
- J. R. Gr.** JOSEPH REYNOLDS GREEN, M.A., D.Sc., F.L.S., F.R.S.
Fellow, Lecturer and Librarian of Downing College, Cambridge. Formerly Hartley Lecturer on Plant Physiology, University of Liverpool. Author of *History of Botany*; &c.
- J. S. F.** JOHN SMITH FLETT, D.Sc., F.G.S.
Petrographer to the Geological Survey of the United Kingdom. Formerly Lecturer on Petrology in Edinburgh University. Neill Medallist of the Royal Society of Edinburgh. Bigsby Medallist of the Geological Society of London.
- J. T. Ba.** JOHN THOMAS BEALBY.
Joint-author of Stanford's *Europe*. Formerly Editor of the *Scottish Geographical Magazine*. Translator of Sven Hedin's *Through Asia, Central Asia and Tibet*; &c.
- J. T. C.** JOSEPH THOMAS CUNNINGHAM, M.A., F.Z.S.
Lecturer on Zoology at the South-Western Polytechnic, London. Formerly Fellow of University College, Oxford. Assistant Professor of Natural History in the University of Edinburgh. Naturalist to the Marine Biological Association.
- J. W.** JAMES WILLIAMS, M.A., D.C.L., LL.D.
All Souls' Reader in Roman Law in the University of Oxford, and Fellow of Lincoln College. Barrister of Lincoln's Inn. Author of *Wills and Succession*; &c.
- J. Wa.** JAMES WATERHOUSE.
Major-General, Indian Army (retired). Assistant Surveyor-General of India in charge of Photographic and Lithographic Branch, Calcutta, 1866-1897. President of the Royal Photographic Society, 1905-1906. Author of *The Preparation of Drawings for Photographic Purposes*; &c.
- J. Wal.*** JAMES WALKER, M.A.
Christ Church, Oxford. Demonstrator in the Clarendon Laboratory. Formerly Vice-President of the Physical Society. Author of *The Analytical Theory of Light*; &c.
- J. W. D.** J. WHITLY DIXON.
Captain, R.N. Nautical Assessor to the Court of Appeal.
- Ponatus (in part).**
- Pharisees.**
- Phigalia (in part);
Pinturicchio.**
- Percy; family (in part);
Plantagenet.**
- Plevna.**
- Pelasgians.**
- Perceval.**
- Philemon;
Philippans, Epistle to the.**
- Polistratus;
Peloponnesian War;
Persia: History (Transition
Period);
Plutarch (in part).**
- Phaedrus.**
- Phosphorescence.**
- Plants: Physiology.**
- Pegmatite; Peridotite;
Perlite; Petrology; Phonolite;
Phosphates; Mineral Phos-
phates (in part); Phyllite;
Pierite; Pitchstone;
Pneumatolysis.**
- Perm (in part);
Podolia (in part);
Poland, Russian (in part).**
- Pearl;
Pilschard.**
- Personal Property.**
- Photography: Apparatus.**
- Polarization of Light.**
- Pilot (in part).**

INITIALS AND HEADINGS OF ARTICLES:

xi

K. G.	<p>KARL FRIEDRICH GEIDNER, PH.D. Professor of Sanskrit and Comparative Philology in the University of Marburg. Author of <i>Vedische Studien</i>; &c.</p>	<p>Persia: <i>Language</i>.</p>
K. L.	<p>REV. KIRSOPP LAKE, M.A. Lincoln College, Oxford. Professor of Early Christian Literature and New Testament Exegesis in the University of Leiden. Author of <i>The Text of the New Testament, The Historical Evidence for the Resurrection of Jesus Christ</i>; &c.</p>	<p>Peter, Saint; Peter, Epistles of.</p>
K. S.	<p>KATHERINE SCHLESINGER. Editor of the <i>Portfolio of Musical Archaeology</i>. Author of <i>The Instruments of the Orchestra</i>.</p>	<p>Pedal Clarinet; Pharmel; Physarmonica; Pianoforte (<i>in part</i>); Piccob; Pipo; and Tabor; Piatropiel.</p>
L.	<p>COUNT LÜTZOW, LITT D., PH.D., F.R.G.S. Chamberlain of H.M. the Emperor of Austria, King of Bohemia. Hon. Member of the Royal Society of Literature. Member of the Bohemian Academy, &c. Author of <i>Bohemia, a Historical Sketch</i>; <i>The Historians of Bohemia</i> (Ichester Lecture, Oxford, 1904); <i>The Life and Times of John Hus</i>; &c.</p>	<p>Podsbura, George of.</p>
L. G.	<p>REV. LEWIS CAMPBELL, D.C.L., LL.D. See the biographical article: CAMPBELL, LEWIS.</p>	<p>Plato.</p>
L. F. V.-H.	<p>LEVESON FRANCIS VERNON-HARCOURT, M.A., M.INST.C.E. (1839-1907). Professor of Civil Engineering at University College, London, 1882-1905. Author of <i>Rivers and Canals</i>; <i>Harbours and Docks: Civil Engineering as applied in Construction</i>; &c.</p>	<p>Flar.</p>
L. J. S.	<p>LEONARD JAMES SPENCER, M.A. Assistant in Department of Mineralogy, British Museum. Formerly Scholar of Sidney Sussex College, Cambridge, and Harkness Scholar. Editor of the <i>Mineralogical Magazine</i>.</p>	<p>Perovskite; Petalite; Pharmacosiderite; Phenacite; Phillipinite; Phlogopite; Phosgenite; Pitchblende; Plagioclase.</p>
M.	<p>LORD MACAULAY. See the biographical article: MACAULAY, THOMAS BARRINGTON MACAULAY, BARON.</p>	<p>Pitt.</p>
M. Be.	<p>MALCOLM BELL. Author of <i>Pewter Plates</i>; &c.</p>	<p>Pewter.</p>
M. D.	<p>REV. MARCUS DODS, D.D. See the biographical article: DODS, MARCUS.</p>	<p>Pelagius.</p>
M. N. T.	<p>MARCUS NIEBUHR TOD, M.A. Fellow and Tutor of Oriol College, Oxford. University Lecturer in Epigraphy. Joint-author of <i>Catalogue of the Sparta Museum</i>.</p>	<p>Pachbeel.</p>
M. O. B. G.	<p>MAXIMILIAN OTTO BISMARCK CASPARI, M.A. Reader in Ancient History at London University. Lecturer in Greek at Birmingham University, 1905-1908.</p>	<p>Pelopidas; Perlander; Pericles; Phocion; Phots; Pintaes.</p>
M. V.	<p>MAX VERWOERN, D.Sc., M.D., PH.D. Professor of Physiology and Director of the Physiological Institute in the University of Bonn. Author of <i>Allgemeine Physiologie</i>; &c.</p>	<p>Physiology.</p>
N. D. M.	<p>NEWTON DENNISON MERENESS, A.M., PH.D. Author of <i>Maryland as a Proprietary Province</i>.</p>	<p>Philippine Islands: <i>Geography and Statistics</i>.</p>
N. M.	<p>NORMAN MCLEAN, M.A. Lecturer in Aramaic, Cambridge University. Fellow and Hebrew Lecturer, Christ's College, Cambridge. Joint-editor of the larger Cambridge-Septuagint.</p>	<p>Philozenus.</p>
N. V.	<p>JOSEPH MARIE NOEL VALOIS. Member of Académie des Inscriptions et Belles-Lettres, Paris. Honorary Archivist at the Archives Nationales. Formerly President of the Société de l'Histoire de France and the Société de l'École des Chartes. Author of <i>La France et le grand schisme d'Occident</i>; &c.</p>	<p>Pisa, Council of.</p>
N. W. T.	<p>NORTHCOTE WHITEEDGE THOMAS, M.A. Government Anthropologist to Southern Nigeria. Corresponding Member of the Société d'Anthropologie de Paris. Author of <i>Thought Transference; Kinship and Marriage in Australia</i>; &c.</p>	<p>Physical Phenomena.</p>
O. A.	<p>OSWALD AERT, M.A., LL.D. H.M. Inspector of Schools and Inspector of Training Colleges. Board of Education London. Author of <i>Louis XIV. and the English Restoration; Charles II.</i>; &c. Editor of the <i>Lauderdale Papers</i>; &c.</p>	<p>Penn, William.</p>
O. Ba.	<p>OSWALD BARRON, F.S.A. Editor of <i>The Ancestor</i>, 1902-1905. Hon. Genealogist to Standing Council of the Honourable Society of the Baronetage.</p>	<p>Pole (<i>family</i>).</p>
O. C. W.	<p>REV. OWEN CHARLES WHITEHOUSE, M.A., D.D. Senior Theological Tutor and Lecturer in Hebrew, Cheahunt College, Cambridge. Principal of the Countess of Huntingdon's College, Cheahunt, 1895-1905.</p>	<p>Pentecost.</p>
O. H.	<p>OLAVS MAGNUS FRIEDRICH HENRICH, PH.D., LL.D., F.R.S. Professor of Mechanics and Mathematics in the Central Technical College of the City and Quilda of London Institute. Author of <i>Vectors and Rotors; Congruent Figures</i>; &c.</p>	<p>Perspective.</p>
P. A. K.	<p>PRINCE PETER ALEKSEVITCH KROPOTKIN. See the biographical article: KROPOTKIN, PRINCE P. A.</p>	<p>Parm (<i>in part</i>); Podolia (<i>in part</i>); Poland, Russian (<i>in part</i>).</p>

INITIALS AND HEADINGS OF ARTICLES

- P. A. T.** P. A. TIELE.
Formerly Librarian, Utrecht University. Author of *Biographical and Historical Memoir on the Voyages of the Dutch Navigators*, &c.
- P. C. M.** PETER CHALMERS MITCHELL, M.A., F.R.S., F.Z.S., D.Sc., LL.D.
Secretary of the Zoological Society of London. University Demonstrator in Comparative Anatomy and Assistant to Linacre Professor at Oxford, 1888-1891. Author of *Outlines of Biology*; &c.
- P. G.** PERCY GARDNER, LL.D., F.S.A., D.LITT.
See the biographical article: GARDNER, PERCY.
- P. GL.** PETER GILES, M.A., LL.D., LITT.D.
Fellow and Classical Lecturer of Emmanuel College, Cambridge, and University Reader in Comparative Philology Formerly Secretary of the Cambridge Philological Society.
- P. LA.** PHILIP LAKE, M.A., F.G.S.
Lecturer on Physical and Regional Geography in Cambridge University Formerly of the Geological Survey of India Author of *Monograph of British Cambrian Trilobites*. Translator and Editor of Keyser's *Comparative Geology*.
- P. SM.** PRESERVED SMITH, PH.D.
Rufus B. Kellogg University Fellow, Amherst College, U.S.A.
- P. V.** PASQUALE VILLARI.
See the biographical article: VILLARI, PASQUALE.
- R. G. J.** SIR RICHARD CLAVERHOUSE JEBB, LL.D., D.C.L.
See the biographical article: JEBB, SIR RICHARD CLAVERHOUSE.
- R. G.** RICHARD GARNETT, LL.D.
See the biographical article: GARNETT, RICHARD.
- R. I. P.** REGINALD INNES POCOCK, F.Z.S.
Superintendent of the Zoological Gardens, London.
- R. K. D.** SIR ROBERT KENWAY DOUGLAS.
Formerly Professor of Chinese, King's College, London. Keeper of Oriental Printed Books and MSS. at British Museum, 1892-1907. Member of the Chinese Consular Service, 1898-1896. Author of *The Language and Literature of China; China; Europe and the Far East*; &c.
- R. L.*** RICHARD LYDEKKEER, F.R.S., F.Z.S., F.G.S.
Member of the Staff of the Geological Survey of India, 1874-1882. Author of *Catalogues of Fossil Mammals, Reptiles and Birds in the British Museum: The Deer of all Lands*; &c.
- R. N. B.** ROBERT NISBET BAIN (d. 1909).
Assistant Librarian, British Museum, 1883-1909. Author of *Scandinavia; the Political History of Denmark, Norway and Sweden, 1513-1900; The First Romanovs, 1613-1725; Slavonic Europe: The Political History of Poland and Russia from 1469 to 1796*; &c.
- R. Po.** RENÉ POUFARDIN, D. ÈS L.
Secretary of the École des Chartes. Honorary Librarian at the Bibliothèque Nationale, Paris. Author of *Le Royaume de Provence sous les Carolingiens; Recueil des chartes de Saint-Germain*; &c.
- R. P. S.** R. PHENÉ SPIERS, F.S.A., F.R.I.B.A.
Formerly Master of the Architectural School, Royal Academy, London. Past President of Architectural Association. Associate and Fellow of King's College, London. Corresponding Member of the Institute of France. Editor of Fergusson's *History of Architecture*. Author of *Architecture: East and West*; &c.
- R. S.*** RALPH STOCKMAN, M.D., F.R.S.(Edin.), F.R.C.P.(Edin.).
Professor of Materia Medica and Therapeutics in the University of Glasgow.
- R. S. C.** ROBERT SEYMOUR CONWAY, M.A., D.LITT.
Professor of Latin and Indo-European Philology in the University of Manchester. Formerly Professor of Latin in University College, Cardiff, and Fellow of Gonville and Caius College, Cambridge. Author of *The Italic Dialects*.
- R. W.** ROBERT WALLACE, F.R.S.(Edin.), F.L.S.
Professor of Agriculture and Rural Economy at Edinburgh University, and Garton Lecturer on Colonial and Indian Agriculture. Professor of Agriculture, R.A.C., Cirencester, 1882-1885. Author of *Farm Live Stock of Great Britain; The Agriculture and Rural Economy of Australia and New Zealand; Farming Industries of Cape Colony*; &c.
- S. A. G.** STANLEY ARTHUR COOK, M.A.
Lecturer in Hebrew and Syriac, and formerly Fellow, Gonville and Caius College, Cambridge. Editor for the Palestine Exploration Fund. Examiner in Hebrew and Aramaic, London University, 1904-1908. Author of *Gleanings of Aramaic Inscriptions; The Law of Moses and the Code of Hammurabi; Critical Notes on Old Testament History; Religion of Ancient Palestine*; &c.
- S. F. H.** SIDNEY FREDERIC HARMER, M.A., D.Sc., F.R.S., F.Z.S.
Keeper of Zoology, Natural History Department, British Museum. Fellow, formerly Tutor and Lecturer, King's College, Cambridge. Joint-editor of *The Cambridge Natural History*.

Plantin.

Phosphorescence: in Zoology.

Phœnias.

Philology (in part).

Persia: Geology.

Pius I. and II.

Pisa.

Pindar (in part).

Peacock, Thomas Lov.

Pedipalpi; Pentastomida.

Peking.

Peccary; Peccora;
Père David's Deer;
Perissodactyla;
Phalanger; Phenacofus;
Pica; Polecat.
Paxmány; Pechlin;
Peter I. and III. of Russia;
Petőfi, Alexander; Philaret;
Piper, Carl;
Poland: History (in part).

Philip the Bold;
Philip the Good.

Pier (in architecture).

Pharmacology.

Pisium (in part).

Pig (in part).

Philistines.

Phoronides.

- S. H. V.*** SYDNEY HOWARD VINES, M.A., D.Sc., F.R.S.
 Sherardian Professor of Botany, University of Oxford and Fellow of Magdalen College. Fellow of the University of London. President of the Linnean Society, 1900-1904. Formerly Reader in Botany in the University of Cambridge and Fellow and Lecturer of Christ's College. Author of *A Student's Textbook of Botany*; &c.
- S. N.** SIMON NEWCOMB, D.Sc., LL.D.
 See the biographical article: NEWCOMB, SIMON.
- T. AS.** THOMAS ASHBY, M.A., D.Litt.
 Director of British School of Archaeology at Rome. Formerly Scholar of Christ Church, Oxford. Craven Fellow, 1897. Conington Prizeman, 1906. Member of the Imperial German Archaeological Institute. Author of *The Classical Topography of the Roman Campagna*.
- T. BA.** SIR THOMAS BARCLAY.
 Member of the Institute of International Law. Officer of the Legion of Honour. Author of *Problems of International Practice and Diplomacy*; &c. M.P. for Blackburn, 1910.
- T. F. C.** THEODORE FREYLINGHUYSEN COLLIER, PH.D.
 Assistant Professor of History, Williams College, Williamstown, Mass., U.S.A.
- T. G. BR.** THOMAS GREGOR BRODIE, M.D., F.R.S.
 Professor Superintendent, Brown Animal Sanatory Institution, University of London. Professor of Physiology, Royal Veterinary College, London. Lecturer on Physiology, London School of Medicine for Women. Fellow of King's College, London. Author of *Essentials of Experimental Physiology*.
- T. M. L.** REV. THOMAS MARTIN LINDSAY, LL.D., D.D.
 Principal of the United Free Church College, Glasgow. Formerly Assistant to the Professor of Logic and Metaphysics in the University of Edinburgh. Author of *History of the Reformation*; *Life of Luther*; &c.
- TH. N.** THEODOR NÖLDEKE, PH.D.
 See the biographical article: NÖLDEKE, THEODOR.
- T. S.*** SIR THOMAS STEVENSON, M.D., F.R.C.P. (1838-1908).
 Formerly Senior Scientific Analyst to the Home Office. Lecturer on Chemistry and Forensic Medicine at Guy's Hospital, London.
- T. W.-D.** WALTER THEODORE WATTS-DUNTON.
 See the biographical article: WATTS-DUNTON, WALTER THEODORE.
- T. W. H.** THOMAS WENTWORTH HIGGINSON, A.M., LL.D.
 Author of *Atlantic Essays*; *Cheerful Yesterdays*; *History of the United States*; &c.
- T. W. R. D.** THOMAS WILLIAM RHYNS DAVIDS, LL.D., PH.D.
 Professor of Comparative Religion, Manchester University. President of the Pali Text Society. Fellow of the British Academy. Secretary and Librarian of Royal Asiatic Society, 1885-1902. Author of *Buddhism*; *Sacred Books of the Buddhists*; *Early Buddhism*; *Buddhist India*; *Dialogues of the Buddha*; &c.
- W. C. SA.** WALTER COVENTRY SUMMERS, M.A.
 Professor of Latin in the University of Sheffield. Formerly Fellow of St John's College, Cambridge. Craven Scholar, 1890. Chancellor's Medallist, 1892. Author of *A Study of Valerius Flaccus*; &c.
- W. D. C.** WILLIAM DOUGLAS CAROE, M.A., F.S.A., F.R.I.B.A.
 Trinity College, Cambridge. Architect to the Ecclesiastical Commission and the Charity Commission, London.
- W. D. W.** WILLIAM DWIGHT WHITNEY.
 See the biographical article: WHITNEY, WILLIAM DWIGHT.
- W. de W. A.** SIR WILLIAM DE WIVELESIE ABNEY, K.C.B., D.C.L., D.Sc., F.R.S.
 Adviser in Science to the Board of Education for England. Member of the Advisory Council for Education to the War Office. Formerly President of Royal Astronomical Society, Physical Society and Royal Photographic Society. Author of *Instruction in Photography*; *Colour Vision*; &c.
- W. E. G. F.** WILLIAM EDWARD GARRETT FISHER, M.A.
 Author of *The Transvaal and the Boers*.
- W. FR.** WILLIAM FREEM, LL.D. (d. 1906).
 Formerly Lecturer on Agricultural Entomology, University of Edinburgh, and Agricultural Correspondent of *The Times*.
- W. F. C.** WILLIAM FEILDEN CRATES, M.A.
 Barrister-at-Law, Inner Temple and Lecturer on Criminal Law, King's College, London. Editor of Archbold's *Criminal Pleading* (23rd edition).
- W. GA.** WALTER GARSTANG, M.A., D.Sc.
 Professor of Zoology in the University of Leeds. Formerly Fellow of Lincoln College, Oxford. Scientific Adviser to H.M. Delegates on the International Council for the Exploration of the Sea, 1901-1907. Author of *The Impoverishment of the Sea*; &c.
- W. HL.** WHEELTON HIND, M.D., F.R.C.S., F.G.S.
 Surgeon, North Staffs Infirmary. Lyell Medallist, Geological Society, 1902. Author of *British Carboniferous Lambedibranchiata*; &c.
- W. H. F.** SIR WILLIAM HENRY FLOWER, F.R.S.
 See the biographical article: FLOWER, SIR W. H.
- Plants: Morphology.**
- Planet;**
Planets, Minor.
- Ferugia;**
Pleenum (in part);
Piperno.
- Peace;**
Peace Conferences;
Pirate and Piracy: Law.
- Plus III, IV, and V.**
- Phagocytosis.**
- Plymouth Brethren (in part)**
- Porosolis (in part).**
- Poison.**
- Poetry.**
- Phillips, Wendell.**
- Piprwa.**
- Perialus;**
Petronius (in part).
- Pearson, John Loughborough.**
- Philology (in part).**
- Photography.**
- Phylloxera.**
- Pig (in part).**
- Pleading.**
- Pisciculture.**
- Pandicide Series.**
- Pistypus (in part).**

INITIALS AND HEADINGS OF ARTICLES

W. M. R.	WILLIAM MICHAEL ROSSETTI. See the biographical article: ROSSETTI, DANTE G.	{ Perino del Vaga; Perugino, Pietro.
W. M. Ra.	SIR WILLIAM MITCHELL RAMSAY, LL.D., D.C.L., D.LITT. See the biographical article: RAMSAY, SIR W. M.	{ Phrygia; Plaidia.
W. P. C.	WILLIAM PRIDEAUX COURTNEY. See the article: COURTNEY, Baron.	{ Peterborough and Monmouth, Earl of.
W. R. M.	WILLIAM RICHARD MORFILL, M.A. (d. 1910). Formerly Professor of Russian and the other Slavonic Languages in the University of Oxford. Curator of the Taylorian Institution, Oxford. Author of <i>Russia; Slavonic Literature</i> ; &c.	{ Poland: <i>Literature</i> .
W. R. S.	WILLIAM ROBERTSON SMITH, LL.D. See the biographical article: SMITH, WILLIAM ROBERTSON.	{ Phylometry (<i>in part</i>).
W. R. S.*	WILLIAM ROY SMITH, M.A., PH.D. Associate Professor of History, Bryn Mawr College, Pennsylvania. Author of <i>Sectionalism in Pennsylvania during the Revolution</i> ; &c.	{ Folk, James Knox.
W. S. R.	WILLIAM SMYTH ROCKSTRO. Author of <i>A Great History of Music from the Infancy of the Greek Drama to the Present Period</i> ; and other works on the history of music.	{ Plain Song.
W. T. T.-D.	SIR WILLIAM TURNER TRISELTON-DYER, F.R.S., K.C.M.G., C.I.E., D.Sc., LL.D., P.B.D., F.L.S. Hon. Student of Christ Church, Oxford. Director, Royal Botanic Gardens, Kew, 1885-1905. Botanical Adviser to Secretary of State for Colonies, 1902-1906. Joint-author of <i>Flora of Middlesex</i> .	{ Plants: <i>Distribution</i> .
W. W. R.*	WILLIAM WALKER ROCKWELL, LIC.THEOL. Assistant Professor of Church History, Union Theological Seminary, New York.	{ Pius VI., VII., and VIII.
W. Y. S.	WILLIAM YOUNG SELLAR, LL.D. See the biographical article: SELLAR, W. Y.	{ Petronius (<i>in part</i>).

PRINCIPAL UNSIGNED ARTICLES.

Pea.	Pepper.	Philostratus.	Piquet.
Peach.	Peppermint.	Phonograph.	Pistoia.
Pear.	Pertumery.	Phormium.	Pitchee Plants.
Peat.	Périer.	Phosphorus.	Pittsburg.
Pecblesshire.	Perigoux.	Photius.	Plantation.
Pembroke, Earls of.	Peripatetics.	Photochemistry.	Platinum.
Pembroke.	Perjury.	Physiocratic School.	Pleurisy.
Pembrokeshire.	Pernambuco.	Physiologist.	Pleuro-Pneumonia.
Pen.	Perrault.	Piacenza.	Plock.
Pencil.	Perrot.	Picardy.	Plough and Ploughing.
Penitential.	Personality.	Picecolomini.	Plum.
Peonine Chain.	Perth (N.B.).	Ptolegru.	Plymouth (U.S.A.).
Pennsylvania.	Pertshire.	Pietism.	Pneumatic Gun.
Pennsylvania, University of.	Pessimism.	Pigeon-flying.	Pneumonia.
Pensacola.	Peterborough.	Pilgrim.	Pnom-Penh.
Pension.	Petition.	Pin.	Poitiers.
Penzance.	Philadelphia.	Pink.	Poker.
Peoria.	Philately.	Pipe.	Pola.

ENCYCLOPÆDIA BRITANNICA

ELEVENTH EDITION

VOLUME XXI

PAYN, JAMES (1830-1898), English novelist, was born at Cheltenham, on the 28th of February 1830, his father being clerk to the Thames Commissioners and treasurer to the county of Berkshire. He was educated at Eton, and afterwards entered the Military Academy at Woolwich; but his health was not equal to the demands of a military career, and he proceeded in 1847 to Trinity College, Cambridge. He was among the most popular men of his time, and served as president of the Union. Before going to Cambridge he had published some verses in Leigh Hunt's *Journal*, and while still an undergraduate put forth a volume of *Stories from Boccaccio* in 1852, and in 1853 a volume of *Poems*. In the same year he left Cambridge, and shortly afterwards married Miss Louisa Adelaide Edlin, sister of Sir Peter Edlin. He then settled down in the Lake district to a literary career and contributed regularly to *Household Words* and *Chambers's Journal*. In 1858 he removed to Edinburgh to act as joint-editor of the latter periodical. He became sole editor in 1859, and conducted the magazine with much success for fifteen years. He removed to London in 1861. In the pages of the *Journal* he published in 1864 his most popular story, *Lost Sir Massingberd*. From this time he was always engaged in novel-writing, among the most popular of his productions being *Married Beneath Him* (1865), *Carlyon's Year* (1868), *By Proxy* (1878), and *The Talk of the Town* (1885). In 1883 he succeeded Leslie Stephen as editor of the *Cornhill Magazine* and continued in the post until the breakdown of his health in 1896. He was also literary adviser to Messrs Smith, Elder & Company. His publications included a *Handbook to the English Lakes* (1859), and various volumes of occasional essays, *Maxims by a Man of the World* (1869), *Some Private Views* (1881), *Some Literary Recollections* (1884). A posthumous work, *The Backwater of Life* (1899), revealed much of his own personality in a mood of kindly, sensible reflection upon familiar topics. He died in London, on the 25th of March 1898.

A biographical introduction to *The Backwater of Life* was furnished by Sir Leslie Stephen.

PAYNE, PETER (c. 1380-1455), English Lollard and Taborite, the son of a Frenchman by an English wife, was born at Hough-on-the-Hill near Grantham, about 1380. He was educated at Oxford, where he adopted Lollard opinions, and had graduated as a master of arts before the 6th of October 1406, when he was concerned in the irregular proceedings through which a letter declaring the sympathy of the university was addressed to the Bohemian reformers. From 1410 to 1414 Payne was principal of St Edmund Hall, and during these years was engaged in controversy with Thomas Netter of Walden, the Carmelite defender of Catholic doctrine. In 1414 he was compelled to leave Oxford and taught for a time in London. Ultimately

he had to flee from England, and took refuge in Bohemia, where he was received by the university of Prague on the 13th of February 1417, and soon became a leader of the reformers. He joined the sect of the "Orphans," and had a prominent part in the discussions and conferences of the ten years from 1420 to 1430. When the Bohemians agreed to send representatives to the Council of Basel, Payne was naturally chosen to be one of their delegates. He arrived at Basel, on the 4th of January 1433, and his unyielding temper and bitter words probably did much to prevent a settlement. The Bohemians left Basel in April. The party of the nobles, who had been ready to make terms, were attacked in the Diet at Prague, by the Orphans and Taborites. Next year the dispute led to open war. The nobles were victorious at Lipau on the 29th of May 1434, and it was reported in England that Payne was killed. When soon afterwards the majority of the Orphans joined the moderate party, Payne allied himself with the more extreme Taborites. Nevertheless his reputation was so great that he was accepted as an arbitrator in doctrinal disputes amongst the reformers. In February 1437 the pope desired the emperor Sigismund to send Payne to be tried for heresy at Basel. Payne had to leave his pastorate at Saas, and took refuge with Peter Chelcicky, the Bohemian author. Two years later he was captured and imprisoned at Gutenstein, but was ransomed by his Taborite friends. Payne took part in the conferences of the Bohemian parties in 1443-1444, and again in 1452. He died at Prague in 1455. He was a learned and eloquent controversialist, and a faithful adherent to Wycliffe's doctrine. Payne was also known as Clerk at Oxford; as Peter English in Bohemia, and as Freyng, after his French father, and Hough from his birth place.

BIBLIOGRAPHY.—The chief facts of Payne's English career are given in the *Loci e libro veritatum* of T. Gascoigne (ed. Thorold Rogers, Oxford, 1881). For his later life the principal sources are contained in the *Monumenta conciliorum generalium saeculi v., Saeculi xv., or saeculi quintodecimi*, vols. i.-iii. (Vienna, 1857-1894). For modern authorities consult Palacky, *Geschichte von Böhmen*, vii.-ix., and Creighton's *History of the Papacy*. The biography by James Baker, *A Forgotten Great Englishman* (London, 1894) is too partial. (C. L. K.)

PAYNTER (or **PAINTER**), **WILLIAM** (c. 1540-1594), English author, was a native of Kent. He matriculated at St John's College, Cambridge, in 1554. In 1561 he became clerk of the ordinance in the Tower of London, a position in which he appears to have amassed a fortune out of the public funds. In 1586 he confessed that he owed the government a thousand pounds, and in the next year further charges of speculation were brought against him. In 1591 his son Anthony owned that he and his father had abused their trust, but Paynter retained his office until his death. This event probably followed

Immediately upon his will, which was nuncupative and was dated the 14th of February 1594. The first volume of his *Palace of Pleasure* appeared in 1566, and was dedicated to the earl of Warwick. It included sixty tales, and was followed in the next year by a second volume containing thirty-four new ones. A second improved edition in 1575 contained seven new stories. Paynter borrows from Herodotus, Plutarch, Aulus Gellius, Aelian, Livy, Tacitus, Quintus Curtius; from Giraldo Cinthio, Matteo Bandello, Ser Giovanni Fiorentino, Straparola, Queen Margaret of Navarre and others. To the vogue of this and similar collections we owe the Italian setting of so large a proportion of the Elizabethan drama. The early tragedies of *Appius and Virginia*, and *Tancred and Gismund* were taken from *The Palace of Pleasure*; and among better-known plays derived from the book are the Shakespearian *Timon of Athens*, *All's Well that Ends Well* (from Giletta of Narbonne), Beaumont and Fletcher's *Triumph of Death* and Shirley's *Love's Cruelty*.

The Palace of Pleasure was edited by Joseph Haslewood in 1813. This edition was collated (1890) with the British Museum copy of 1575 by Mr Joseph Jacobs, who added further prefatory matter, including an introduction dealing with the importance of Italian *novelle* in Elizabethan drama.

PAYSANDÚ, or **PAISANDÚ**, a town and river port of Uruguay and capital of a department of the same name, on the left bank of the Uruguay River about 214 m. N.W. of Montevideo, with which it is connected by rail. Pop. (1908 estimate), 15,000. It has railway connexion with Rio Negro and Montevideo to the south-east, and with Salto and Santa Rosa, on the Brazilian frontier, on the north; it is at the head of low water navigation on the Uruguay River, and is in regular steamer communication with Montevideo and Buenos Aires.

There are some good public buildings, including two churches, a hospital, a theatre and the government offices. Paysandú exports cattle and sheep and salted meats, hides, ox tongues, wool and other animal products. There is a meat-curing establishment (*saladero*) at Guaviyú, in the vicinity. The town was named in honour of Pay, or Pai (Father) Sandú, a priest who settled there in 1772. It has suffered severely from revolutionary outbreaks, was bombarded by Rivera in 1846, and was partly destroyed in 1865 by a Brazilian bombardment, after which its gallant defenders, Leandro Gomez and his companions, were butchered in cold blood.

The department of Paysandú—area 5117 sq. m.; pop. (1907, estimate), 54,097—is one of the richest stock-raising regions of the republic.

PAYSON, EDWARD (1783-1827), American Congregational preacher, was born on the 25th of July 1783 at Rindge, New Hampshire, where his father, Seth Payson (1758-1820), was pastor of the Congregational Church. His uncle, Phillips Payson (1736-1801), pastor of a church in Chelsea, Massachusetts, was a physicist and astronomer. Edward Payson graduated at Harvard in 1803, was then principal of a school at Portland, Maine, and in 1807 became junior pastor of the Congregational Church at Portland, where he remained, after 1811, as senior pastor, until his death on the 22nd of October 1827.

The most complete collection of his sermons, with a memoir by Asa Cummings originally published in 1828, is the *Memoir, Selected Thoughts and Sermons of the late Rev. Edward Payson* (3 vols., Portland, 1846; Philadelphia, 1850). Based on this is the volume, *Mementos of Edward Payson* (New York, 1873), by the Rev. E. L. Janes of the Methodist Episcopal Church.

PÁZMÁNY, PÉTER (1570-1637), Hungarian cardinal and statesman, was born at Nagyvárád on the 4th of October 1570, and educated at Nagyvárád and Kolozsvár, at which latter place he quitted the Calvinist confession for the Roman communion (1583). In 1587 he entered the Jesuit order. Pázmány went through his probation at Cracow, took his degree at Vienna, and studied theology at Rome, and finally completed his academic course at the Jesuit college at Graz. In 1601 he was sent to the order's establishment at Sellye, where his eloquence and dialectic won back hundreds to Rome, including many of the noblest families. Prince Nicholas Esterházy and Paul Rákóczy were among his converts. In 1607 he was attached

to the archbishop of Esztergom, and in the following year attracted attention by his denunciation, in the Diet, of the 8th point of the peace of Vienna, which prohibited the Jesuits from acquiring landed property in Hungary. At about the same time the pope, on the petition of the emperor Matthias II., released Pázmány from his monkish vows. On the 25th of April 1616 he was made dean of Turóc, and on the 28th of September became primate of Hungary. He received the red hat from Urban VIII. in 1620. Pázmány was the soul of the Roman Catholic reaction in Hungary. Particularly remarkable is his *Igazságos veszté Kalous (Guide to Truth)*, which appeared in 1613. This manual united all the advantages of scientific depth, methodical arrangement and popular style. As the chief pastor of the Hungarian church Pázmány used every means in his power, short of absolute contravention of the laws, to obstruct and weaken Protestantism, which had risen during the 16th century. In 1619 he founded a seminary for theological candidates at Nagyszombat, and in 1623 laid the foundations of a similar institution at Vienna, the still famous Pazmanaeum, at a cost of 200,000 florins. In 1635 he contributed 100,000 florins towards the foundation of a Hungarian university. He also built Jesuit colleges and schools at Pressburg, and Franciscan monasteries at Erekújvár and Körmöcbánya. In politics he played a considerable part. It was chiefly due to him that the diet of 1618 elected the archduke Ferdinand to succeed the childless Matthias II. He also repeatedly thwarted the martial ambitions of Gabriel Bethlen, and prevented George Rákóczy I., over whom he had a great influence, from combining with the Turks and the Protestants. But Pázmány's most unforgettable service to his country was his creation of the Hungarian literary language. As an orator he well deserved the epithet of "the Hungarian purple Cicero." Of his numerous works the chief are: *The Four Books of Thomas à Kempis on the imitation of Christ* (Hung., 1603), of which there are many editions; *Diatribe theologica de visibili Christi in terris ecclesia* (Graz, 1615); *Vindiciae ecclesiasticae* (Vienna, 1620); *Sermons for every Sunday in the Year* (Hung., Pressburg, 1636); *The Triumph of Truth* (Hung., Pressburg, 1614).

See Vilmós Fraknói, *Péter Pázmány and his Times* (Hung. Pest, 1868-1872); *Correspondence of Pázmány* (Hung. and Latin), published by the Hungarian Academy (Pest, 1873). (R. N. B.)

PAZ SOLDAN, MARIANO FELIPE (1821-1886), Peruvian historian and geographer, was born at Arequipa, on the 22nd of August 1821. He studied law, and after holding some minor judicial offices, was minister to New Granada in 1853. After his return he occupied himself with plans for the establishment of a model penitentiary at Lima, which he was enabled to accomplish through the support of General Castilla. In 1860 Castilla made him director of public works, in which capacity he superintended the erection of the Lima statue of Bolívar. He was also concerned in the reform of the currency by the withdrawal of the debased Bolivian coins. In 1861 he published his great atlas of the history of the republic of Peru, and in 1868 the first volume of his history of Peru after the acquisition of her independence. A second volume followed, and a third, bringing the history down to 1839, was published after his death by his son. In 1870 he was minister of justice and worship under President Balta, but shortly afterwards retired from public life to devote himself to his great geographical dictionary of Peru, which was published in 1877. During the disastrous war with Chile he sought refuge at Buenos Aires, where he was made professor in the National College, and where he wrote and published a history of the war (1884). He died on the 31st of December 1886.

PEA (*Pisum*), a genus of the order Leguminosae, consisting of herbs with compound pinnate leaves ending in tendrils, by means of which the weak stems are enabled to support themselves, and with large leafy stipules at the base. The flowers (fig. 1) are typically "papilionaceous," with a "standard" or large petal above, two side petals or wings, and two front petals below forming the keel. The stamens are ten—nine united, the tenth usually free or only slightly joined to the others.

This separation allows approach to the honey which is secreted at the base of the staminal tube. The ovary is prolonged into a long, thick, bent style, compressed from side to side at the tip and fringed with hairs. The fruit is a characteristic "legume" or pod (fig. 2), bursting when ripe into halves, which bear the large globular seeds (peas) on their edges. These seeds are on short stalks, the upper extremity of which is dilated into a shallow cup (aril); the two seed-leaves (cotyledons) are thick and fleshy, with a radicle bent along their edges on one side. The genus is exceedingly close to *Lathyrus*, being only distinguished technically by the style, which in the latter genus is compressed from above downwards and not thick.

FIG. 1.—Flower of Pea.
c, Calyx.
s, Standard.
a, Alae, or wings.
car, Carina, or Keel.

The genus is exceedingly close to *Lathyrus*, being only distinguished technically by the style, which in the latter genus is compressed from above downwards and not thick.

It is not surprising, therefore, that under the general name "pea" species both of *Pisum* and of *Lathyrus* are included. The common field pea with tan-coloured or compressed mottled seeds, and two to four leaflets is *Pisum arvense*, which is cultivated in all temperate parts of the globe, but which, according to the Italian botanists, is truly a native of central and southern Italy: it has purple flowers. The garden pea, *P. sativum*, which has white flowers, is more tender than the preceding, and its origin is not known. It has not been found in a wild state anywhere, and it is considered that it may be a form of *P. arvense*, having, however, from four to six leaflets to each leaf and globular seeds of uniform colour.

From Vine's *Students' Text-book of Botany*, by permission of Swan, Sonenschein & Co.

FIG. 2.—The Pod (legume) of the Pea.
r, The dorsal suture.
v, The ventral suture.
c, Calyx.
s, Seeds.

In the Swiss lake-dwellings of the bronze period. The garden peas differ considerably in size, shape of pod, degree of productiveness, form and colour of seed, &c. The sugar peas are those in which the inner lining of the pod is very thin instead of being somewhat horny, so that the whole pod can be eaten. Unlike most papilionaceous plants, peaflowers are perfectly fertile without the aid of insects, and thus do not intercross so freely as most similar plants do. On the other hand, a case is known wherein the pollen from a purple-podded pea applied to the stigma of one of the green-podded sugar peas produced a purple pod, showing that, not only the ovule but even the ovary was affected by the cross. The numerous varieties of peas in cultivation have been obtained by cross-fertilization, but chiefly by selection. Peas constitute a highly nutritious article of diet from the large quantity of nitrogenous materials they contain in addition to starchy and saccharine matters.

The sweet pea, cultivated for the beauty and fragrance of its flowers, is a species of the allied genus *Lathyrus* (*L. odoratus*), a native of southern Europe. The chick pea (*Pis. a.*) (*Cicer arietinum*), not cultivated in England, is still farther removed from the true peas. The everlasting pea of gardens is a species of *Lathyrus* (*L. latifolius*) with very deep fleshy roots, bold foliage, and beautiful but scentless flowers; the field pea (*Pisum arvense*) is better adapted than the bean to light soils, and is best cultivated in rows of such a width as to admit of horse-hoeing. The early stage at which the plants fall over, and forbid further culture, renders it even more needful than in the case of beans to sow them only on land already clean. If annual weeds can be kept in check until the peas once get a close cover, they then occupy the ground so completely that nothing else can live under them; and the ground, after their removal, is found in the choicest condition. A thin crop of peas should never be allowed to stand, as the land is sure to get perfectly wild. The

difficulty of getting this crop well harvested renders it peculiarly advisable to sow only the early varieties.

The pea prefers a friable calcareous loam, deeply worked, and well enriched with good hotbed or farm-yard manure. The early crops require a warm sheltered situation, but the later are better grown 6 or 8 ft. apart, or more, in the open quarters, dwarf crops being introduced between the rows. The dwarf or early sorts may be sown 3 or 4 ft. apart. The deep working of the soil is of importance, lest the plants should suffer in hot dry weather from mildew or arrest of growth. The first sowing may be made about the beginning or middle of November, in front of a south wall, the plants being defended by spruce fir branches or other spray throughout the winter. In February sowings are sometimes made in private gardens, in flower-pots or boxes, and the young plants afterwards planted out. The main crop should be sown towards the end of February, and moderate sowings should be made twice a month afterwards, up to the beginning of July for the north, and about the third week in July for warmer districts. During dry hot weather late peas derive great benefit from mulching and watering. The latest sowings, at the middle or end of August, should consist of the best early sorts, as they are not so long in producing pods as the larger and finer sorts, and by this means the supply may be prolonged till October or November. As they grow the earth is drawn up to the stems, which are also supported by stakes, a practice which in a well-kept garden is always advisable, although it is said that the early varieties arrive sooner at maturity when recumbent.

Peas grown late in autumn are subject to mildew, to obviate which it has been proposed to dig over the ground in the usual way, and to soak the spaces to be occupied by the rows of peas thoroughly with water—the earth on each side to be then collected so as to form ridges 7 or 8 in. high, these ridges being well watered, and the seed sown on them in single rows. If dry weather at any time set in, water should be supplied profusely once a week.

To produce very early crops the French market-gardeners used to sow early in November, in frames, on a border having a good aspect, the seeds being covered very slightly. The young plants are transplanted into other frames in December, the ground inside being dug out so as to be 18 or 20 in. below the sashes, and the earth thus removed placed against the outside of the frames. The young plants, when 3 or 4 in. high, are planted in patches of three or four, 8 in. asunder, in four longitudinal rows. The sashes are covered at night with straw mats, and opened whenever the weather is sufficiently mild. When 8 or 10 in. high the stems are inclined towards the back of the frame, a little earth being drawn to their base, and when the plants come into blossom the tops are pinched out above the third or fourth flower to force them into bearing. As soon as they begin to pod, the soil may have a gentle watering, whenever sufficiently warmed by the sun, but a too vigorous growth at an earlier period would be detrimental. Thus treated the plants bear pods fit for gathering in the first fortnight in April.

A very convenient means of obtaining an early crop is to sow in 5-in. pots, a few seeds in each, the plants to be ultimately planted out on a warm border. Peas may also be obtained early if gently forced in frames, in the same way as kidney beans, the dwarfest varieties being preferable.

For the very early peas the rows should range east and west, but for the main crops north and south. The average depth of the drills should be about 2 in. for small sorts, and a trifle more for the larger kinds. The drills should be made wide and flat at bottom so that the seeds may be better separated in sowing. The large sorts are the better for being sown 3 in. apart. Chopped furze may be advantageously scattered in the drill before covering in, to check the depredations of mice, and before levelling the surface the soil should be gently trodden down over the seeds.

A good selection of sorts may be made from the following:—

Early.—William Hurst; Chelsea Gem; Sutton's Bountiful and Excelsior; Gradus.

Second Early.—Stragem; Telephone; Telegraph; Carter's Daisy; Duke of York; Veitch's Autocrat.

Late.—Veitch's Perfection; Ne Plus Ultra, the finest of all late peas, but a little delicate in cold wet soils and seasons; British Queen; Champion of England; Duke of Albany.

PEABODY, ANDREW PRESTON (1811-1893), American clergyman and author, was born in Beverly, Massachusetts, on the 19th of March 1811, and was descended from Lieut. Francis Peabody of St. Albans, who emigrated to Massachusetts in 1635. He learned to read before he was three years old, entered Harvard College at the age of twelve, and graduated in 1826, with the single exception of Paul Dudley (class of 1690) the youngest graduate of Harvard. In 1833 he became assistant pastor of the South Parish (Unitarian) of Portsmouth, New Hampshire; the senior pastor died before Peabody had been preaching a month, and he succeeded to the charge of the church, which he held until 1860. In 1857-1860 he was proprietor and editor of the *North American Review*. He was preacher to

Harvard University and Plummer professor of Christian morals from 1860 to 1881, and was professor emeritus from 1881 until his death in Boston, Massachusetts, on the 10th of March 1893. On the walls of Appleton Chapel, Cambridge, U.S.A., is a bronze tablet to his memory.

Besides many brief memoirs and articles, he wrote: *Christianity the Religion of Nature* (2nd ed., 1864), Lowell Institute Lectures; *Reminiscences of European Travel* (1868); *A Manual of Moral Philosophy* (1873); *Christian Belief and Life* (1875), and *Harvard Reminiscences* (1888). See the *Memoir* (Cambridge, 1896) by Edward J. Young.

PEABODY, ELIZABETH PALMER (1804-1894), American educationist, was born at Billerica, Massachusetts, on the 16th of May 1804. Early in life she was assistant in A. Bronson Alcott's school in Boston, Mass., the best account of which is probably her *Record of Mr Alcott's School* (1835). She had been instructed in Greek by Emerson at Concord when she was eighteen years old. She became interested in the educational methods of Froebel, and in 1860 opened in Boston a small school resembling a kindergarten. In 1867 she visited Germany for the purpose of studying Froebel's methods. It was largely through her efforts that the first public kindergarten in the United States was established in Boston in 1870. She died at Jamaica Plain, Boston, on the 3rd of January 1894. She was the sister-in-law of Nathaniel Hawthorne and of Horace Mann.

Among her publications are: *Kindergarten in Italy* (1872); *Reminiscences of William Ellery Channing* (1880); *Lectures in the Training Schools for Kindergarteners* (1888); and *Last Evening with Alston, and other Papers* (1886).

PEABODY, GEORGE (1795-1866), American philanthropist, was descended from an old yeoman family of Hertfordshire, England, named Peabody or Pebody. He was born in the part of Danvers which is now Peabody, Mass., on the 18th of February 1795. When eleven years old he became apprentice at a grocery store. At the end of four years he became assistant to his brother, and a year afterwards to his uncle, who had a business in Georgetown, District of Columbia. After serving as a volunteer at Fort Warburton, Maryland, in the War of 1812, he became partner with Elisha Riggs in a dry goods store at Georgetown, Riggs furnishing the capital, while Peabody was manager. Through his energy and skill the business increased with astounding rapidity, and on the retirement of Riggs about 1830 Peabody found himself at the head of one of the largest mercantile concerns in the world. About 1837 he established himself in London as merchant and money-broker at Wanford Court, in the city, and in 1843 he withdrew from the American business. The number of his benefactions to public objects was very large. He gave £50,000 for educational purposes at Danvers; £200,000 to found and endow a scientific Institute in Baltimore; various sums to Harvard University; £700,000 to the trustees of the Peabody Educational Fund to promote education in the southern states; and £500,000 for the erection of dwelling-houses for the working-classes in London. He received from Queen Victoria the offer of a baronetcy, but declined it. In 1867 the United States Congress awarded him a special vote of thanks. He died in London on the 4th of November 1866; his body was carried to America in a British warship, and was buried in his native town.

See the *Life* (Boston, 1870) by Phebe A. Hanaford.

PEABODY, a township of Essex county, Massachusetts, U.S.A., in the eastern part of the state, 2 m. N.W. of Salem. Pop. (1905) 13,098; (1910) 15,721. It is served by the Boston & Maine railroad. The township covers an area of 17 sq. m. Its principal village is also known as Peabody. It contains the Peabody institute (1852), a gift of George Peabody; in 1909 the institute had a library of 43,200 vols., and in connexion with it is the Eben Dale Sutton reference library, containing 4100 vols. in 1909. In the institute is the portrait of Queen Victoria given by her to Mr Peabody. Among the places of interest in the township are the birthplace of George Peabody, the home of Rufus Choate (who lived here from 1823 to 1828), and the old burying-ground, where many soldiers of the War of Independence are buried; and the town has a Lexington monument,

dedicated in 1835, and a soldiers' monument, dedicated in 1863. Manufacturing is the principal industry, and leather is the principal product; among other manufactures are shoes, gloves, glue and carriages. The value of the factory products in 1905 was \$10,236,669, an increase of 47.4% over that for 1900, and of the total the leather product represented 77.3%.

Peabody was originally a part of the township of Salem. In 1752 the district of Danvers was created, and in 1757 this district was made a separate township. In 1855 the township was divided into Danvers and South Danvers, and in 1868 the name of South Danvers was changed to Peabody, in honour of George Peabody. See *Old Nausmbeug* (Salem, 1877), by C. H. Webber and W. H. Nevins.

PEACE, a river of western Canada. It rises in the Rocky Mountains near 55° N., and breaking through the mountains, flows N.E. into Slave River, near lake Athabasca. The district between 56° 40' and 60° N., and between 112° W. and the Rocky Mountains is usually known as the Peace River district.

PEACE (Lat. *pax*; Fr. *paix*; Ger. *Friede*), the contrary of war, conflict or turmoil, and the condition which follows their cessation. Its sense in international law is the condition of not being at war. The word is also used as an abridgment for a treaty of peace, in such cases as the Peace of Utrecht (1713) and the Peace of Amiens (1802).

Introduction.—Peace until quite recently was merely the political condition which prevailed in the intervals between wars. It was a purely negative condition. Even Grotius, who reduced the tendencies existing in his time to a sort of orderly expression, addressed himself to the law of war as the positive part of international jurisprudence and dealt only with peace as its negative alternative. The very name of his historic treatise, *De jure belli ac pacis* (1625), shows the subordination of peace to the main subject of war. In our own time peace has attained a higher status. It is now customary among writers on international law to give peace at any rate a volume to itself. Peace in fact has become a separate branch of the subject. The rise of arbitration as a method of settling international difficulties has carried it a step further, and now the Hague Peace Conventions have given pacific methods a standing apart from war, and the preservation of peace has become an object of direct political effort. The methods for ensuring such preservation are now almost as precise as the methods of war. However reluctant some states may be to bind themselves to any rules excluding recourse to brute force when diplomatic negotiations have failed, they have nevertheless unanimously at the Hague Conference of 1907 declared their "firm determination to co-operate in the maintenance of general peace" (*la ferme volonté de concourir au maintien de la paix générale*), and their resolution "to favour with all their efforts the amicable settlement of international conflicts" (preamble to Peace Convention). The offer of mediation by independent powers is provided for (Peace Convention: art. 3), and it is specifically agreed that in matters of a "legal character" such as "questions of interpretation and application" of international conventions, arbitration is the "most efficacious and at the same time most equitable method" of settling differences which have not been solved by diplomacy (Peace Convention: art. 38). In the final act, the conference went farther in agreeing to the "principle of compulsory arbitration," declaring that "certain disputes, in particular those relating to the interpretation and application of the provisions of international agreements, are suitable (susceptible) to be submitted to compulsory arbitration without any restriction."

These declarations were obviously a concession to the widespread feeling, among civilized nations, that peace is an object in itself, an international political condition requiring its code of methods and laws just as much as the domestic political conditions of nations require their codes of methods and laws. In other words peace among nations has now become, or is fast becoming, a positive subject of international regulation, while war is

¹This has been incorrectly rendered in the English official translation as "the sincere desire to work for the maintenance of general peace."

cooling, among progressive peoples, to be regarded merely as an accidental disturbance of that harmony and concord among mankind which nations require for the fostering of their domestic welfare.

Though the idea of preserving peace by general international regulation has had several exponents in the course of ages, no deliberate plan has ever yet been carried into effect. Indirectly, however, there have been many agencies which have operated towards this end. The earliest, known to history, is the Amphictyonic Council (q.v.) which grew out of the common worship of the Hellenes. It was not so much a political as a religious body. "If it had any claim," says Freeman,¹ "to the title of a general council of Greece, it was wholly in the sense in which we speak of general councils in modern Europe. The Amphictyonic Council represented Greece as an ecclesiastical synod represented western Christendom. Its primary business was to regulate the concerns of the temple of Apollo at Delphi. The Amphictyonic Council which met at Delphi was only the most famous of several bodies of the same kind." "It is easy, however," adds Freeman, "to understand how the religious functions of such a body might assume a political character. Thus the old Amphictyonic oath forbade certain extreme measures of hostility against any city sharing in the common Amphictyonic worship, and it was forbidden to raise any Amphictyonic city or to cut off its water. As the only deliberative body in which most Greek communities were represented, its decisions were those of the bulk of the Hellenic people. It sank eventually into a mere political tool in the hands first of Thebes, and then under Philip of Macedonia."

The so-called *pax romana* was merely peace within an empire governed from a central authority, the constituent parts of which were held together by a network of centralized authority.

The feudal system again was a system of offence and defence, and its object was efficiency for war, not the organised regulation of peace. Yet it had elements of federation within the bonds of its hierarchy.

The spiritual influence of the Church again was exerted to preserve relative peace among feudal princes. The "Truce of God" was established by the clergy (originally in Guyenne in 1031) to take advantage of holy days and festivals for the purpose of restricting the time available for bloodshed.

The "grand design" of Henry IV. (France), which some historians regard merely as the fantastic idea of a visionary, was probably a scheme of his great minister Sully to avert by a federation the conflict which he probably foresaw would break out sooner or later between Catholic and Protestant Europe, and which, in fact, broke out some fifteen years later in the Thirty Years' War.

The Holy Roman Empire itself was in some respects an agent for the preservation of peace among its constituent states. In the same way the federation of Swiss cantons, of the states of the North American Union and of the present German Empire have served as means of reducing the number of possible parties to war, and consequently that of its possible occasions.

Not only the number of possible war-making states but also the territorial area over which war can be made has been reduced in recent times by the creation of neutralized states such as Switzerland, Belgium, Luxemburg and Norway, and areas such as the Congo basin, the American lakes and the Suez Canal.

The "balance of power," which has played in the history of modern Europe such an important part, is inherent in the notion of the independence and stability of states. Just as in Italy the common weal of the different republics which were crowded within the limited area of the peninsula required that no one of them should become so powerful as to threaten the independence of the others, so western Europe had a similar danger to counteract. France, Spain and the Empire were competing with each other in power to the detriment of smaller states. Great Britain and the Netherlands, Prussia and Russia,

¹ *History of Federal Government in Greece and Italy* (2nd ed., London, 1893), p. 97.

had interests in the preservation of the *status quo*, and wars were waged and treaties concluded to adjust the strength of states in the common interest of preventing any one of them from obtaining undue predominance. Then came the break up of what remained of feudal Europe and a readjustment under Napoleon, which left the western world with five fairly balanced homogeneous nations. These now took the place of the old heterogeneous areas, governed by their respective sovereigns without reference to any idea of nationality or of national representation. The leading nations assumed the hegemony of the west, and in more recent times this combination has become known as the "concert of Europe." This concert of the great powers, as its name implies, in contradistinction to the "balance of power," was essentially a factor for the preservation of peace. For a century back it has played the part of an upper council in the management of Europe. In all matters affecting the Near East, it considers itself supreme. In matters of general interest it has frequently called conferences to which the minor states have been invited, such as the West African Conference in Berlin in 1885, and the Anti-Slavery Conference at Brussels in 1889-1890, and the Conference of Algeciras in 1906. Meanwhile the concert has admitted among its members first in 1856 Turkey, later in 1878 at the Congress of Berlin the United States, and now undoubtedly Japan will expect to be included as a great power in this controlling body. The essential feature of the concert has been recognition of the advantage to all the great powers of common action in reference to territorial changes in the Near East, of meeting together as a council, in preference to unconcerted negotiation by the powers acting severally.

A departure of more recent origin has been the calling together of the smaller powers for the settlement of matters of general administrative interest, conferences such as those which led to the conclusion of the conventions creating the Postal Union, the Copyright and Industrial Property Unions, &c.

These conferences of all the powers serve in practice as a sort of common council in the community of states, just as the concert of the great powers acts as a kind of senate. We have thus the nucleus of that international parliament which idealist peacemakers have dreamt of since the time of Henry IV.'s "grand design."

This brings us down to the greatest deliberate effort ever made to secure the peace of the world by a general convention. It was due to the initiative of the young tsar Nicolas II., who, in his famous rescript of the 24th of August 1908, stated that he thought that the then moment was "very favourable for seeking, by means of international discussion, the most effectual means of assuring to all peoples the benefits of a real and durable peace." "In the course of the last twenty years," added the rescript, "the preservation of peace had become an object of international policy." Economic crises, due in great part to the existing system of excessive armaments, were transforming armed peace into a crushing burden, which peoples had more and more difficulty in bearing. He therefore proposed that there should be an international conference for the purpose of focusing the efforts of all states which were "sincerely seeking to make the great idea of universal peace triumph over the elements of trouble and discord." The first conference was held in 1899, and another followed it in 1907; at the earlier one twenty-six powers were represented; at that of 1907 there were forty-four, this time practically the whole world. The conventions drawn up at the second conference were a deliberate codification of many branches of international law. By them a written law has been substituted for that unwritten law which nations had been wont to construe with a latitude more or less corresponding to their power. At the conference of 1899, moreover, a court of arbitration was instituted for the purpose of dealing judicially with such matters in dispute as the powers agreed to submit to it.

In the interval between the two Hague Conferences, Great Britain and France concluded the first treaty applicable to future difficulties, as distinguished from the treaties which had preceded it, treaties which related in all cases to difficulties already

existing and confined to them. This treaty made arbitration applicable to all matters not affecting "national honour or vital interests." Since then a network of similar treaties, adopted by different nations with each other and based on the Anglo-French model, has made reference to the Hague Court of Arbitration practically compulsory for all matters which can be settled by an award of damages or do not affect any vital national interest.

The third Hague Conference is timed to be held in 1917. Meanwhile a conference of the maritime powers was held in London in 1908-1909 for the elaboration of a code of international maritime law in time of war, to be applied in the international Court of Prize, which had been proposed in a convention signed *ad referendum* at the Hague Conference of 1907.

A further development in the common efforts which have been made by different powers to assure the reign of justice and judicial methods among the states of the world was the proposal of Secretary Knox of the United States to insert in the instrument of ratification of the International Prize Court Convention (adopted at the Hague in 1897) a clause stating that the International Prize Court shall be invested with the duties and functions of a court of arbitral justice, such as recommended by the first *Voew* of the Final Act of the conference. The object of this proposal was to give effect to the idea that the existing "permanent" court lacked the essential characteristics of national courts of justice in not being ready at all times to hear cases, and in needing to be specially constituted for every case submitted to it. The new court would be permanently in session at the Hague, the full panel of judges to assemble in ordinary or extraordinary session once a year.

Thus, while armaments are increasing, and wars are being fought out in the press and in public discussion, the great powers are steadily working out a system of written law and establishing a judiciary to adjust their differences in accordance with it.¹

The Current Grouping of Mankind and Nation-making.—In the consolidation of peace one of the most important factors is unquestionably the grouping of mankind in accordance with the final territorial and racial limitations of their apparent destiny. Language has played a vital part in the formation of Germany and Italy. The language question still disturbs the tranquillity of the Near East. The Hungarian government is regarded by the Slav, Ruman and German inhabitants of the monarchy as an oppressor for endeavouring to force everybody within the realm to learn the Magyar language. The "Young Turkish" government has problems to face which will be equally difficult, if it insists on endeavouring to institute centralized government in Turkey on the French model.

Whereas during the 19th century states were being cut out to suit the existing distribution of language, in the 20th the tendency seems to be to avoid further rearrangement of boundaries, and to complete the homogeneity, thus far attained, by the artificial method of forcing reluctant populations to adopt the language of the predominant or governing race. In the United States this artificial method has become a necessity, to prevent the upgrowth of alien communities, which might at some later date cause domestic trouble of a perilous character. For example, when a community of French Canadians, discontented with British rule, many years ago migrated and settled in Massachusetts, they found none of the tolerance they had been enjoying in Canada for their French schools and the French language they wished to preserve. In Alsace-Lorraine German-speaking immigrants are gradually displacing, under

government encouragement, the French-speaking population. Poland is another case of the difficulty of managing a population which speaks a language not that of the governing majority, and Russia, in trying to solve one problem by absorbing Finland into the national system, is burdening herself with another which may work out in centuries of unrest, if not in domestic violence. Not very long ago Pan-Germans were paying much attention to the German settlers in the Brazilian province of Rio Grande do Sul, where large villages spoke nothing but German, and German, as the only language known on the spot, had become the tongue in which municipal business was transacted. The Brazilian government, in view of the danger to which such a state of things might give rise, followed the example of the United States in dealing with the language question.

Thus while in the one case homogeneity of language within state boundaries seems to be one of the conditions making for peace, the avoidance of interference with a well-marked homogeneous area like Finland would seem to contribute equally to the same end.

Meanwhile the difficulties in the way of contemporary nation-making are fostered by many extraneous influences, as well as by dogged resistance of the races in question. Not the least important of these influences is the sentimental sympathy felt for those who are supposed to be deprived of the use of their mother-tongue, and who are subjected to the hardship of learning an alien one. The hardship inflicted on those who have to learn a second language is very easily exaggerated, though it is to be regretted that in the case of Hungary the second language is not one more useful for international purposes.

Contemporary Statecraft.—Nation-making has hitherto been more or less unconscious—the outcome of necessity, a natural growth due to the play of circumstance and events. But in our own age conscious statecraft is also at work, as in Canada, where the genius of statesmen is gradually endowing that dominion with all the attributes of independence and power. Australia has not learnt the lesson of Canada in vain. Whatever value may attach to the consolidation of the British Empire itself as a factor in spreading the peace which reigns within it, it is also a great contribution to the peace of the world that the British race should have founded practically independent states like the Dominion of Canada, the Commonwealth of Australia, the South African Union and the Dominion of New Zealand. These self-governing colonies with their spheres of influence, with vast areas still unpeopled, have a future before them which is dissociated from the methods of an over-peopled Europe, and among them the preservation of peace is the direct object and condition of their progressive development. Like the United States, they have or will have their Monroe doctrine. Colonized by the steady industrial peoples of northern Europe, there is no danger of the turbulence of the industrially indolent but more passionate peoples of Central and South America. As in Europe, these northern peoples will hold the power which intelligent democracies are consciously absorbing, and the British faculty for statecraft is gradually welding new nations on the British model, without the obsolete traditions and without that human sediment which too frequently chokes the currents of national vitality in the older communities of Europe.

Militarism.—It is often stated, as if it were incontrovertible, that conscription and large standing armies are a menace to peace, and yet, although throughout the civilized world, except in the British Empire and the United States, conscription is the system employed for the recruiting of the national forces of both defence and offence, few of these countries show any particular disposition to make war. The exceptional position of the United States, with a population about equal to that of the rest of the American continent, and of Great Britain, an island state but little exposed to military invasion, places both beyond absolute need of large standing armies, and renders an enlisting system feasible which would be quite inadequate for the recruitment of armies on the French or German scale. Democratic progress on the Continent has, however, absorbed

¹ Schemes of thinkers, like William Penn's European Parliament (1693); the Abbé St Pierre's elaboration (c. 1700) of Henry IV.'s "grand design" (see *supra*); Jeremy Bentham's *International Tribunal* (1786-1789); Kant's *Perpetual Congress of Nations and Perpetual Peace* (1796); John Stuart Mill's *Federal Supreme Court*; Sealey's, Bluntschli's, David Dudley Field's, Professor Leone Levi's, Sir Edmund Hornby's co-operative schemes for promoting law and order among nations, have all contributed to popularizing in different countries the idea of a federation of mankind for the preservation of peace.

conscription as a feature in the equalization of the citizen's rights and liabilities. Just as in Anglo-Saxon lands a national ideal is gradually materializing in the principle of the equalization of chances for all citizens, so in continental Europe, along with this equalization of chances, has still more rapidly developed the ideal of an equalization of obligations, which in turn leads to the claim for an enlargement of political rights co-extensive with the obligations. Thus universal conscription and universal suffrage tend to become in continental political development complementary conditions of the citizen's political being. In Germany, moreover, the military service is designed not only to make the recruit a good soldier, but also to give him a healthy physical, moral and mental training. German statesmen, under the powerful stimulus of the emperor William II., have, in the eyes of some critics, carried this secondary object of conscript training to such excess as to be detrimental to military efficiency. To put it shortly, the Germans have taught their soldiers to think, and not merely to obey. The French, who naturally looked to German methods for inspiration, have come to apply them more particularly in the development of their cavalry and artillery, especially in that of the former, which has taken in the French army an ever higher place as its observing and thinking organ.

Militarism on the Continent has thus become allied with the very factors which made for the reign of reason. No agitation for the development of national defences, no beating of drums to awaken the military spirit, no anti-foreign clamour or invasion panic, no parading of uniforms and futile clash of arms, are necessary to entice the groundling and the bumpkin into the service. In Germany patriotic waving of the flag, as a political method, is directed more especially to the strengthening of imperial, as distinguished from local, patriotism. Where conscription has existed for any appreciable time it has sunk into the national economy, and men do their military service with as little concern as if it were a civil apprenticeship.

As implied above, military training under conscription does not by any means necessarily tend to the promotion of the military spirit. In France, so far from taking this direction, it has resulted, under democratic government and universal suffrage, in a widespread abhorrence of war, and, in fact, has converted the French people from being the most militant into being the most pacific nation in Europe. The fact that every family throughout the land is a contributory to the military forces of the country has made peace a family, and hence a national, ideal. Paradoxical as it may seem, it is the logical conclusion of such comparisons that militarism only exists in countries where there are no citizen armies, and that, where there are citizen armies, they are one of the elements which make for permanent peace.

Normal Nature of Peace.—America has been the pioneer of the view that peace is the normal condition of mankind, and that, when the causes of war are eliminated, war ceases to have a *raison d'être*. The objects and causes of war are of many kinds. War for fighting's sake, although in the popular mind there may be, during most wars, only the excitement and the emotion of a great gamble, has no conscious place among the motives of those who determine the destinies of peoples. Apart, however, from self-defence, the main causes of war are four: (1) The desire for territorial expansion, due to the overgrowth of population, and insufficiency of the available food-supply; if the necessary territory cannot be obtained by negotiation, conquest becomes the only alternative to emigration to foreign lands. (2) The prompting of national ambition or a desire to wipe out the record of a humiliating defeat. (3) Ambitious potentates again may seek to deflect popular tendencies into channels more satisfactory for their dynasty. (4) Nations, on the other hand, may grow jealous of each other's commercial success or material power. In many cases the apparent cause may be of a nobler character, but historians have seldom been content to accept the allegations of those who have claimed to carry on war from disinterested motives.

On the American continent South and Central American

states have had many wars, and the disastrous effects of them not only in retarding their own development, but in impairing their national credit, have led to earnest endeavours on the part of their leading statesmen to arrive at such an understanding as will banish from their international polity all excuses for resorting to armed conflicts. In 1881 Mr Blaine, then U.S. secretary of state, addressed an instruction to the ministers of the United States of America accredited to the various Central and South American nations, directing them to invite the governments of these countries to participate in a congress, to be held at Washington in 1882, "for the purpose of considering and discussing the methods of preventing war between the nations of America." Owing to different circumstances the conference was delayed till the autumn of 1889. At this conference a plan of arbitration was drawn up, under which arbitration was made obligatory in all controversies whatever their origin, with the single exception that it should not apply where, in the judgment of any one of the nations involved in the controversy, its national independence was imperilled, and even in this case arbitration, though optional for the nation so judging, was to be obligatory for the adversary power. At the second International Conference of American States, which sat in the city of Mexico from the 22nd of October 1901 to the 31st of January 1902, the same subject was again discussed, and a scheme was finally adopted as a compromise which conferred authority on the government of Mexico to ascertain the views of the different governments represented in the conference, regarding the most advanced form in which a general arbitration convention could be drawn up that would meet with the approval and secure ratification by all the countries represented, and afterwards to prepare a plan for such a general treaty. The third Pan-American Conference was held in the months of July and August 1906, and was attended by the United States, Argentina, Bolivia, Brazil, Chile, Colombia, Costa Rica, Cuba, the Dominican Republic, Ecuador, Guatemala, Honduras, Mexico, Nicaragua, Panama, Paraguay, Peru, Salvador and Uruguay. Only Haiti and Venezuela were absent. The conference, being held only a year before the time fixed for the second Hague Conference, applied itself mainly to the question of the extent to which force might be used for the collection of pecuniary claims against defaulting governments, and the forwarding of the principle of arbitration under the Hague Conventions. The possible causes of war on the American continent had meanwhile been considerably reduced. Different states had adjusted their frontiers, Great Britain in British Guiana had settled an outstanding question with Venezuela, France in French Guiana another with Brazil, Great Britain in Newfoundland had removed time-honoured grievances with France, Great Britain in Canada others with the United States of America, and now the most difficult kind of international questions which can arise, so far as the American continent is concerned, have been removed from among existing dangers to peace. Among the Southern Republics Argentina and Chile concluded in 1902 a treaty of arbitration, for the settlement of all difficulties without distinction, combined with a disarmament agreement of the same date, to which more ample reference will be made hereafter. Thus in America progress is being rapidly made towards the realization of the idea that war can be superannuated by elimination of its causes and the development of positive methods for the preservation of peace (see PAN-AMERICAN CONFERENCES).

With the American precedent to inspire him, the emperor Nicolas II. of Russia in 1898 issued his invitation to the powers to hold a similar conference of European states, with a more or less similar object. In 1899 twenty-six states met at the Hague and began the work, which was continued at the second conference in 1907, and furthered by the Maritime Conference of London of 1908-1909. The creation of the Hague Court and of a code of law to be applied by it have further eliminated causes of difference.

These efforts in the two hemispheres are based on the idea

that international differences can be adjusted without war, where the parties are honestly aggrieved. With this adjustment of existing cases the number of possible pretexts for the employment of force is being rapidly diminished.

Peace Procedure under the Hague Conventions.—The Hague Peace Convention of 1907, which re-enacts the essential parts of the earlier one of 1899, sets out five ways of adjusting international conflicts without recourse to war. Firstly, the signatory powers have undertaken to use their best efforts to ensure the pacific settlement of international difficulties. This is a general declaration of intention to lend themselves to the peaceable adjustment of difficulties and employ their diplomacy to this end. Secondly, in case of serious disagreement, diplomacy having failed, they agree to have recourse, as far as circumstances allow, to the good offices or mediation of one or more friendly powers. Thirdly, the signatory powers agree that it shall not be regarded as an unfriendly act if one or more powers, strangers to the dispute, on their own initiative offer their good offices or mediation to the states in disagreement, or even during hostilities, if war has already broken out. Fourthly, the convention recommends that in disputes of an international nature, involving neither national honour nor vital interests, and arising from a difference of opinion on points of fact, the parties who have not been able to come to an agreement by means of diplomacy should institute an international commission of inquiry to facilitate a solution of these disputes by an investigation of the facts. Lastly, the high contracting parties have agreed that in questions of a legal nature, and especially in interpretation or application of international conventions, arbitration is recognized as the most effective, and at the same time the most equitable, means of settling disputes which diplomacy has failed to adjust.

Down to 1910 no suggestion of mediation had actually been carried out, but a number of cases of arbitration had been tried by the Hague Court, created by the Hague Peace Convention (see ARBITRATION, INTERNATIONAL), and one case, viz. that of the Dogger Bank incident, was submitted to a commission of inquiry, which sat in January 1905.¹

If Secretary Knox's proposal (see *supra*) to convert the International Prize Court into a permanently sitting court of arbitration is adopted, a detailed procedure and jurisprudence will no doubt grow out of a continuity which is lacking in the present system, under which the court is recruited from a large panel for each special case. Secretary Knox's idea, as expressed in the identical circular note addressed by him on the 18th of October 1909 to the powers, was to invest the International Prize Court, proposed to be established by the convention of the 18th of October 1907, with the functions of a "court of arbitral justice." The court contemplated by the convention was a court of appeal for reviewing prize decisions of national courts both as to facts and as to the law applied, and, in the exercise of its judicial discretion, not only to confirm in whole or in part the national decision or the contrary, but also to certify its judgment to the national court for enforcement thereof. The adoption of this jurisdiction would have involved a revision of the judicial systems of probably every country accepting it. The United States government therefore proposed that the signatories should insert in the act of ratification a reservation to the effect that resort to the International Prize Court, in respect of decisions of their national tribunals, should take the form of a direct claim for compensation. This in any case would remove the United States' constitutional objection to the establishment of the proposed court. In connexion with this enabling clause Mr

¹The procedure adopted by the commission was afterwards incorporated in the convention of 1907. Under the rules adopted, the examination of witnesses is conducted by the president in accordance with the system prevailing in most continental countries; members of the commission may only put questions to witnesses for the eliciting of further information; and they may not interrupt the witness when he is in course of making his statement, but they may ask the president to put any additional questions. This seems likely to become the procedure also in cases before the Hague Court, where witnesses are examined.

Secretary Knox also proposed that a further enabling clause be inserted providing that the International Court of Prize be competent to accept jurisdiction in all matters, arising between signatories, submitted to it, the Court to sit at fixed periods every year and to be composed according to the panel which was drawn up at the Hague. This court, which the American government proposed to call a "Court of Arbitral Justice," would take the place of that which it was proposed to institute under *Vas* No. 1 of the Final Act of the conference of 1907. The intention of the Hague draft annexed to the *Vas* was to create a permanent court as distinguished from that established in 1899, which, though called permanent, was not so, having to be put together *ad hoc* as the occasion arose. The new court, if adopted, would hold regular and continuous sessions, consist of the same judges, and pay due heed to the precedents created by its prior decisions. The two courts would have separate spheres of activity, and litigants would practically have the option of submitting their differences to a judicial court which would regard itself as being bound by the letter of the law and by judicial methods or to a special court created *ad hoc* with a purely arbitral character.

The Place of Diplomacy.—The utility of the diplomatic service has been considerably diminished through the increasing efficiency of the public press as a medium of information. It is not too much to say that at the present day an experienced journalist, in a place like Vienna or Berlin, can give more information to an ambassador than the ambassador can give to him. It is even true to say that an ambassador is practically debarred from coming into actual touch with currents of public feeling and the passing influences which, in this age of democracy, determine the course of events in the political life of peoples. The diplomatist has therefore lost one of his chief functions as an informant of the accrediting government. The other chief function of diplomacy is to be the courteous medium of conveying messages from one government to another. Even this function is losing its significance. The ciphered telegram leaves little discretion to the envoy, and written notes are exchanged which are practically a mere transcription of the deciphered telegram or draft prepared at the instructing foreign office. Nevertheless, the personality of an ambassador can play a great part, if he possesses charm, breadth of understanding and interest in the social, intellectual and industrial life of the country to which he is accredited. There are several instances of such men in Europe and America, but they are so rare that some reformers consider them as hardly justifying the large expenditure necessary to maintain the existing system. On the other hand, the utility of the consular service has concurrently increased. Administrative indifference to the eminently useful officials forming the service has led, in many cases, to diminishing instead of increasing their number and their salaries, but it is obvious that the extension of their duties and a corresponding raising of their status would be much more in accordance with the national interest. The French, with that practical sense which distinguishes so much of their recent administrative work, have connected the two services. A consul-general can be promoted to a diplomatic post, and take with him to his higher office the practical experience a consul gains of the material interests of the country to which he belongs.

There is thus still good work for diplomacy to do, and if, in the selection of diplomatic representatives, states followed on the one hand the above-mentioned French example, and on the other hand the American example of selecting for the heads of diplomatic missions men who are not necessarily *de la carrière*, diplomacy might obtain a new lease of activity, and become once more an extremely useful part of the administrative machinery by which states maintain good business relations as well as friendly political intercourse with one another.

International Regulation by Treaty.—It seems a truism to say that among the agencies which most effectively tend to the preservation of peace are treaties which regulate the relations of states in their intercourse with other states. Such treaties, however, are of quite recent origin. The first of a comprehensive

character was the *general act* adopted at the South African Conference at Berlin in 1885, which laid down the principle, which has since become of still wider application, that "any Power which henceforth takes possession of a tract of land on the coast of the African continent outside of its present possessions or which, being hitherto without such possessions, shall acquire them . . . shall accompany the act relating to it with a notification thereof, addressed to the other Signatory Powers of the present act, in order to enable them, if need be, to make good any claims of their own," and, furthermore, that "the Signatory Powers of the present act recognize the obligation to ensure the establishment of authority in the regions occupied by them on the coasts of the African continent sufficient to protect existing rights, and, as the case may be, freedom of trade and transit under the conditions agreed upon." Under these articles occupation of unoccupied territory to be legal had to be effective. This led to the creation and determination of *spheres of influence*. By fixing the areas of these spheres of influence rival states in western and central Africa avoided conflicts and preserved their rights until they were able to take a more effective part in their development. The idea of "spheres of influence" has in turn been applied even to more settled and civilized countries, such as China and Persia.

Other cases of regulation by treaty are certain contractual engagements which have been entered into by states for the preservation of the *status quo* of other states and territories.

The Anglo-Japanese Treaty of the 12th of August 1905 sets out its objects as follows:—

a. "The consolidation and maintenance of the general peace in the regions of Eastern Asia and India."

b. "The preservation of the common interests of the Powers in China, of insuring the independence and the integrity of the Chinese empire, and the principle of equal opportunities for the commerce and industry of all nations in China."

c. "The maintenance of the territorial rights of the high contracting parties in the regions of Eastern Asia and of India, and the defence of their special interests in such regions."

It is a treaty for the maintenance of the *status quo* in certain parts of Asia in which the parties to it have dominant interests. The same principle underlies different other self-denying arrangements and declarations made by the powers with reference to Chinese integrity.

The Treaty of Algéciras is essentially a generalization of the Franco-German agreement of the 28th of September 1905. By it all the powers represented agree to respect the territorial integrity of Morocco, subject to a possible intervention limited to the purpose of preserving order within it.

Differing from these *general acts* in not being contractual is the Monroe doctrine, which is a *policy* of ensuring the maintenance of the territorial *status quo* as regards non-American powers throughout the American continent. If necessary, the leading republics of South and Central America would no doubt, however, further ensure respect for it by treaty.

With these precedents and current instances of tendency to place the territorial relations of the powers on a permanent footing of respect for the existing *status quo*, it seems possible to go beyond the mere enunciation of principles, and to take a step towards their practical realization, by agreeing to respect the territorial *status quo* throughout still larger tracts of the world, neutralize them, and thus place them outside the area of possible wars.

A third contractual method of avoiding conflicts of interest has been the signing of agreements for the maintenance of the "open-door." The discussion on the question of the "open-door" in connexion with the Morocco difficulty was useful in calling general public attention once more to the undesirability of allowing any single power to exclude other nations from trading on territory over which it may be called to exercise a protectorate, especially if equality of treatment of foreign trade had been practised by the authority ruling over the territory in question before its practical annexation under the name of protectorate. The habitable parts of the world are a limited area, exclusion from any of which is a diminution of

the available markets of the nations excluded. Every power, is, therefore, rightfully interested in the prevention of such exclusion.

The United States government in 1899 called attention to the subject as regards China, without, however, going into any question of principle. It thought that danger of international irritation might be removed by each power making a declaration respecting the "sphere of interest" in China to which it laid claim. Lord Salisbury informed Mr Choate that H.M. government were prepared to make a declaration in the sense desired. All the powers concerned eventually subscribed to the declaration proposed by the United States government.

The principle of the "open-door" in fact has already been consistently applied in connexion with certain non-European areas. As these areas are practically the only areas which of late years have come within the scope of European regulation, the time seems to be approaching when the principle may be declared to be of general application. From the point of view of diminishing the possible causes of conflict among nations, the adoption of this principle as one of international contractual obligation would be of great utility. While putting an end to the injustice of exclusion, it would obviously reduce the danger of nations seeking colonial aggrandizement with a view to imposing exclusion, and thus one of the chief temptations to colonial adventure would be eliminated.

In the fourth place, there is the self-denying ordinance against employment of arms for the enforcement of contractual obligations adopted at the Hague Conference of 1907. Under it the high contracting powers have agreed not to have recourse to armed force for the recovery of contractual debts claimed from the government of one country by the government of another country as due to its subjects. The only qualification admitted under the new convention is that it shall not apply when the debtor-state refuses or leaves unanswered an offer of arbitration, or in case of acceptance renders the settlement of the terms of arbitration impossible, or, after arbitration, fails to comply with the award. The theory on which this convention is based is known as the Drago theory, having taken a practical form during the administration of Dr L. M. Drago, when he filled the post of Argentine minister of foreign affairs. The doctrine, however, is not new, having already been enunciated a century before by Alexander Hamilton and reiterated since then by several American statesmen, such as Albert Gallatin, William L. Marcy and F. T. Frelinghuysen, as the view prevailing at Washington during their respective periods of office.

Limitations of Disarmament.—Disarmament, or to speak more correctly, the contractual limitation of armaments, has become, of late years, as much an economic as a humanitarian peace-securing object.

"The maintenance of universal peace and a possible reduction of the excessive armaments which weigh upon all nations, represent, in the present condition of affairs all over the world, the ideal towards which the efforts of all governments should be directed," were the opening words of the Note which the Russian Minister of Foreign Affairs, Count Mouraviev, handed to the diplomatic representatives of the different powers suggesting the first Hague Conference.

"The ever-increasing financial burdens," the Note went on, "strike at the root of public prosperity. The physical and intellectual forces of the people, labour and capital, are diverted for the greater part from their natural application and wasted unproductively. Hundreds of millions are spent in acquiring terrible engines of destruction, which are regarded to-day as the latest inventions of science, but are destined to-morrow to be rendered obsolete by some new discovery. National culture, economic progress and the production of wealth are either paralysed or developed in a wrong direction. Therefore the more the armaments of each power increase the less they answer to the objects aimed at by the governments. Economic disturbances are caused in great measure by this system of excessive armaments; and the constant danger involved in this accumulation of war material renders the armed peace of to-day a crushing

burden more and more difficult for nations to bear. It consequently seems evident that if this situation be prolonged it will inevitably result in the very disaster it is sought to avoid, and the thought of the horrors of which makes every humane mind shudder. It is the supreme duty, therefore, of all states to place some limit on these increasing armaments, and find some means of averting the calamities which threaten the whole world."

A further Note submitting the programme proposed gave more precision to this item, which thereupon took the following form: "An understanding not to increase for a fixed period the present effectives of the armed military and naval forces, and at the same time not to increase the budgets pertaining thereto; and a preliminary examination of the means by which even a reduction might be effected in future in the forces and budgets above mentioned."

When the subject came on for discussion at the conference the German military delegate stated his view that the question of effectives could not be discussed by itself, as there were many others to which it was in some measure subordinated, such, for instance, as the length of service, the number of cadres whether existing in peace or made ready for war, the amount of training received by reserves, the situation of the country itself, its railway system, and the number and position of its fortresses. In a modern army all these questions went together, and national defence included them all. In Germany, moreover, the military system "did not provide for fixed numbers annually, but increased the numbers each year."

After many expressions of regret at finding no method of giving effect to the proposal, the commission confined itself to recording its opinion that "a further examination of the question by the Powers would prove a great benefit to humanity."

The Conference, however, were unanimous in the adoption of the following resolution:—

"The Conference is of opinion that the restriction of military budgets, which are at present a heavy burden on the world, is extremely desirable for the increase of the material and moral welfare of mankind;"

and it passed also the following *view*:—

"That governments, taking into account the proposals made at the Conference, should examine the possibility of an understanding concerning the limitation of military and naval armaments, and of war budgets."

The general public, more particularly in Great Britain and France, shows an ever-increasing distrust of the rapid growth of armaments as a possible cause of grave economic troubles. A high state of military preparedness of any one state obliges all the others to endeavour to be prepared on the same level. This process of emulation, very appropriately called by the late Sir H. Campbell-Bannerman "a policy of huge armaments," unfortunately is a policy from which it is impossible for any country to extricate itself without the co-operation, direct or indirect, of other nations.

The subject was brought forward in view of the second Hague Conference in both the French and Italian parliaments.

The declaration of the French government stated that:—

"France hoped that other nations would grow, as she had done, more and more attached to solutions of international difficulties based upon the respect of justice, and she trusted that the progress of universal opinion in this direction would enable nations to regard the lessening of the present military budgets, declared by the states represented at the Hague to be greatly desirable for the benefit of the material and moral state of humanity, as a practical possibility." (Chamber of Deputies, June 12, 1906.)

In the Italian Chamber of Deputies, an interpellation was addressed to the minister of foreign affairs about the same time asking "whether the Government had knowledge of the motion approved by the British House of Commons, and of the undertaking of the British government that, in the programme of the coming Hague Conference, the question of the reduction of armaments should be inserted, and in what spirit the Italian government had taken or proposed to take the propositions of the British government, and what instructions it would give to the Italian representatives at the conference."

The minister of foreign affairs, M Tittoni, in reply expressed the adhesion of the Italian government to the humanitarian ideas which had met with such enthusiasm in the historic House of Parliament at Westminster. "I have always believed," he said, "that, as far as we are concerned, it would be a national crime to weaken our own armaments while we are surrounded by strongly armed European nations who look upon the improvement of armaments as a guarantee of peace. Nevertheless, I should consider it a crime against humanity not to sincerely co-operate in an initiative having for object a simultaneous reduction of armaments of the great powers. Italian practice has always aimed at the maintenance of peace; therefore, I am happy to be able to say that our delegates at the coming Hague Conference will be instructed to further the English initiative."

The only existing case of contractual reduction of armaments is that of the Disarmament Agreement of the 28th of May 1902 between the Chilean and Argentine republics, adopted "owing to the initiative and good offices of His Britannic Majesty," which is as follows:—

Art. I.—In order to remove all cause of fear and distrust between the two countries, the governments of Chile and of the Argentine Republic agree not to take possession of the warships which they are having built, or for the present to make any other acquisitions. The two governments furthermore agree to reduce their respective fleets, according to an arrangement establishing a reasonable proportion between the two fleets. This reduction to be made within one year from the date at which the present agreement shall be ratified.

Art. II.—The two governments respectively promise not to increase their maritime armaments during five years, unless the one who shall wish to increase them shall give the other eighteen months' notice in advance. This agreement does not include any armaments for the purpose of protecting the shore and ports, and each party will be at liberty to acquire any vessels (*maquina flotante*) intended for the protection thereof, such as submarines, &c.

Art. III.—The reductions (*i.e.* ships disposed of) resulting from this agreement will not be parted with to countries having any dispute with either of the two contracting parties.

Art. IV.—In order to facilitate the transfer of the pending orders the two governments agree to increase by two months the time stipulated for the beginning of the construction of the respective ships. They will give instructions accordingly.

An agreement of this kind is obviously more feasible as among states whose navies are small and of comparatively recent origin than among states whose navies are composed of vessels of many and widely different ages. It may be difficult to agree in the latter case on a principle for assessment of the proportionate fighting value of the respective fleets. The break-up or sale of obsolete warships is a diminution of the paper effective of a navy, and their purchase by another state a paper increase of theirs. Even comparatively slight differences in the ages of ships may make great differences in their fighting value. It would be a hard, though probably not insurmountable, task to establish "a reasonable proportion," such as provided for in Art. II. of the Chile-Argentina Agreement, as between large and old-standing navies like those of Europe.

On the other hand, as regards military power, it seems sometimes forgotten in the discussion of the question of armaments, that the conditions of the present age differ entirely from those of the time of the Napoleonic wars. With conscription a national army corresponds more or less numerically to the proportion of males in the national population. Great Britain, without conscription, has no means of raising troops in any such proportion. Thus, so long as she refrains from adopting conscription, she can only carry on defensive warfare. The object of her navy is therefore necessarily defensive, unless it act in co-operation with a foreign conscript army. As there are practically only three great armies available for the purpose of a war of aggression, the negotiation of contingent arrangements does not seem too remote for achievement by skilful and really well-meaning negotiation. The Hague Conference of 1907, owing to difficulties which occurred in the course of the preliminary negotiations for the conference, did not deal with the subject.

Principle and Capabilities of Neutralization.—Among the different methods which have grown up practically in our own

time for the exclusion of war is neutralization. We have been dealing hitherto with the elimination of the causes of war; neutralization is a curtailment of the areas of war and of the factors in warfare, of territory on the one hand and states on the other. The neutralization of territory belonging to states which are not otherwise neutralized includes the neutralization of waterways such as the Suez and Panama canals.

Under the General Act of Berlin of the 26th of February 1855, "in case a power exercising rights of sovereignty or protectorate" in any of the regions forming the basin of the Congo and its affluents, including Lake Tanganyika, and extending away to the Indian Ocean, should be involved in a war, the parties to the General Act bound themselves to lend their good offices in order that the territories belonging to this power be placed during the war "under the rule of neutrality and considered as belonging to a neutral state, the belligerents thenceforth abstaining from extending hostilities to the territories thus neutralized, and from using them as a basis for warlike operations" (art. 2).

Neutralization is not necessarily of general application. Thus two states can agree to neutralize specific territory as between them. For example between Costa Rica and Nicaragua by a treaty of the 15th of April 1858 the parties agreed that "on no account whatever, not even in case of war," should "any act of hostility be allowed between them in the port of San Juan del Norte nor on the river of that name nor on Lake Nicaragua" (art. 2).¹

Again, the Straits of Magellan are neutralized as between Argentina and Chile under a treaty of the 23rd of July 1881. Article 5 provides that they are "neutralized for ever and their free navigation is guaranteed to the flags of all nations. To ensure this neutrality and freedom it is agreed that no fortifications or military defences which might interfere therewith shall be erected."

Luxemburg was declared by the Treaty of London of the 11th of May 1867 (art. 1) to be a perpetually neutral state under the guarantee of Great Britain, Austria, Prussia and Russia. Switzerland, by a declaration confirmed by the Treaty of Vienna, of 1815 (art. 84), likewise enjoys perpetual neutrality. And now Norway has placed herself under a neutral régime of a similar character.

A neutralized state does not mean a state which is forbidden to have fortifications or an army; in this it differs from neutralized territory of a state not otherwise neutralized. Thus Belgium, which is a neutralized state, not only has an army but has fortifications, although by the treaties of 1831 and 1839 she was recognized as a "perpetually neutral state, bound to observe the same neutrality with reference to other states."

Of waterways, international rivers have been the chief subject of neutralization. It has long been an established principle in the intercourse of nations, that where the navigable parts of a river pass through different countries their navigation is free to all. The rivers Scheldt and Meuse were opened up in this way to riparian states by a decree of the French Convention of the 16th of November 1792. By the treaty of Vienna of the 9th of June 1815, the powers whose territories were separated or traversed by the same navigable river, undertook to regulate by common consent all that regarded its navigation, and for this purpose to name commissioners who should adopt as the bases of their proceedings the principle that the navigation of such rivers along their whole course "from the point where each of them becomes navigable to its mouth, shall be entirely free, and shall not in respect of commerce be prohibited to anyone." The only case in Europe in which this internationalization of rivers has been maintained is that of the Danube. On the other hand neutralization has made progress in respect of waterways,

¹ Under the treaty of the 29th of March 1864, the courts of Great Britain, France and Russia in their character of guaranteeing powers of Greece declared with the assent of the courts of Austria and Prussia that the islands of Corfu and Paxos as well as their dependencies should, after their union to the Hellenic kingdom, enjoy the advantages of perpetual neutrality, and the King of the Hellenes undertook on his part to maintain such neutrality. (Art. 2).

natural as well as artificial. Thus the Bosphorus and Dardanelles under the Treaty of Paris of 1856 and by the Treaty of London 1871 were and remain closed to the passage of foreign armed vessels in time of war, though the Porte may permit their passage in time of peace in certain cases. The Suez and the Panama canals have been permanently neutralized, the former by a convention among the great powers, and the latter by a treaty between Great Britain and the United States.

Alongside this neutralization has grown up a collateral institution, the purpose of which is in some respects similar. We refer to "buffer" zones. "Buffer" zones are of quite recent origin as a political creation,² i.e. where their object is to establish upon the territory of two contiguous states a strip or zone on either side of the frontier which the respective states agree to regard as neutral, on which the parties undertake to erect no fortifications, and maintain no armed forces but those necessary to enforce the ordinary respect of government. The word "neutral" does not correctly describe the character of the zone. It is not neutral in the sense of being recognized as such by any third state, and it necessarily ceases to be neutral in case of war between the states concerned. The word "buffer" comes nearest to the object, but even this term implies more than is meant. Between Spain and Morocco a treaty of the 5th of March 1894 established between the Camp of Medilla and Moroccan territory a zone within which no new roads were to be made, no herds to be allowed to graze, no land to be cultivated, no troops of either party, or even private persons carrying arms, to set foot, no inhabitants to dwell, and all habitations to be razed. The zone between Burma and Siam, established by an agreement between Great Britain and France dated the 15th of January 1896, declared "the portion of Siam which is comprised within the drainage basin of the Menam, and of the coast streams of a corresponding longitude," neutral as between them. Within this area the two powers undertook not to "operate by their military or naval forces, except in so far as they might do so in concert for any purpose requisite for maintaining the independence of Siam." They also undertook not to acquire within that area any privileges or commercial facilities not extended to both of them.

"Buffer" zones might fulfil a useful purpose even in Europe. They would obviously react against the feeling known as "esprit de frontière," and diminish the danger of incidents arising out of this feeling, and might attenuate the rivalry of neighbouring counter-armaments.

These considerations no doubt led the Swedish and Norwegian governments, in their settlement of September 1905, to establish a "buffer" zone of 15 kilometres on either side of the frontier between the two states in question. Within these 30 kilometres all existing fortresses are dismantled,³ no new ones are to be erected, and no armed troops to be maintained; any question between the two states relative to the provisions respecting the "buffer" zone to be decided by arbitration.

A rather special case of neutralization of a territorial area

² The institution of "buffer" zones in a more strictly correct sense of the term is of very ancient origin. One is mentioned in the annals of China two centuries before our era, between the territories of the Huns in the west and those of the Tunguses in the east—a vast area of some 300 to 400 m. on the opposite margin of which the two peoples kept watch. In Europe, bands of territory from time to time have been made desert to better establish separation. The Romans and Germans protected themselves in this way. In the middle ages the Teutonic Order established a frontier belt on the side of Lithuania. Later, Austria dealt in the same way in her policy in regard to Turkey in the organization of a "military frontier." See Nys, *Droit International* (Brussels, 1904), i. 418.

³ It was stipulated that the dismantling should be controlled by a technical commission of three officers of foreign nationality, to be chosen, one by each of the contracting powers and the third by the two officers thus appointed, or, in default of an agreement on their part, by the president of the Swiss Confederation. The dismantling of the forts in question has now been carried out. The Commission was composed on the part of Sweden of an engineer on the staff of the Austrian army, and on the part of Norway of a colonel in the German army, and, by agreement of these, of a colonel in the Dutch army.

is that of the practical neutralization of the Great Lakes in America. In 1817, at the instance of John Quincy Adams, the United States and Great Britain entered into a compact whereby the Great Lakes, and the waterways from them to the ocean by the St Lawrence river, which divide the United States from the Dominion of Canada, were practically excluded from any possible hostilities. Through a simple agreement, "conditions which make for peace and prosperity, and the absence of those which so often lead to disastrous war, have for nearly a century reigned over these great inland waters, whose commerce, conducted for the benefit of the states and nations of Europe and America, rivals that which passes through the Suez Canal or over the Mediterranean Sea, and with a result foreshadowed in these words of President Monroe in his communication to the Senate commending the proposed agreement: 'In order to avoid collision and save expense.' Forts which had been erected at salient points on either side of the lakes and rivers dividing the United States from Canada, which but for this agreement would, in the natural course of events, have been enlarged, increasingly garrisoned, and provided with modern implements of destruction, at large expense, have remained substantially as when the agreement was made, or now constitute but interesting or picturesque ruins; and the great cost of constructing and maintaining, through a long series of years, naval armaments of ever-increasing power has been avoided."¹

As we have already said, the Monroe doctrine is a means of excluding European warfare from the American continent and therefore is in the nature of a form of neutralization. A sort of Monroe doctrine is growing into popular favour also throughout the Australian Commonwealth, where it is felt that a continent so far removed from European rivalries ought not to be exposed to complications on account of them.

From time to time questions of adding to existing neutralized areas are raised. When it was announced in 1905 that a British fleet was about to manoeuvre in the Baltic Sea, several German newspapers suggested that Germany should combine with other Baltic powers to assure its neutralization.² No official observation on the subject, however, was made on the part of any Baltic power. The Baltic is still an open sea for the whole world, without restriction of any kind; and even hostilities between any two non-Baltic powers could be carried on in the Baltic, as elsewhere on the high sea, under the existing practice.

When the Dogger Bank incident occurred, the possibility of operations of war being carried on within a few miles of British home ports, and amid the busy traffic of the North Sea, was brought vividly home to British minds.

A movement set on foot at the instance of Edward Atkinson, the well-known Boston economist, and warmly supported by the Massachusetts State Board of Trade, seeks to establish by treaty neutral zones from the ports of North America to the ports of Great Britain and Ireland and the continent of Europe, within which zones steamship and sailing vessels in the conduct of lawful commerce should be free to pass without seizure or interruption in time of war. There is however no precedent of neutralization of any such area of the high sea, and international rivers, ocean canals and neutralized states are obviously no criterion in discussing a proposal to neutralize a strip of the ocean, which may be defined accurately enough on the map and which skilful navigators could approximately determine, but which might be violated without any practical means of detection by a belligerent commander whenever he misread, or it suited him to misread, his bearings.

Connected with the principle of neutralization is that of guaranteeing the integrity of states. Several such guarantees have been given in quite recent times. In November 1907 a treaty was concluded between France, Germany, Great Britain and Russia on the one part and Norway on the other, for the maintenance of the integrity of Norway. This treaty differed

from the older one of 1855 in which France and Great Britain guaranteed the integrity of Norway and Sweden, in the fact that whereas the older treaty was for the protection of these two states against Russia, the new treaty is intended, if it is to serve at all as a protection against invasion, to protect Norway against Sweden.

Another such guarantee of a vaguer character is that which the North Sea powers recently entered into for the maintenance of the *status quo* of their respective North Sea territories; and the similar one entered into by the Mediterranean powers for the same objects in the Mediterranean. Lastly in the same order of ideas Austria-Hungary and Russia are said to have concluded an arrangement between them for the maintenance of the *status quo* in the Balkans.

The future has no doubt still other extensions of the principle of neutralization in store for us. Not the least interesting of existing possibilities is the limitation of the area of visit and search in time of war itself, as a restriction of belligerent right. It seems contrary to common sense that neutral ships should be exposed to being detained, taken out of their course, and overhauled on mere suspicion of carrying contraband, when they are so far from the seat of war that there can be no presumption as to their destination. Neutrals have a right to carry on their ordinary business unmolested in so far as they do nothing to assist either belligerent. When they are beyond a certain distance from the seat of war it seems reasonable that the presumption that they are merely carrying on their legitimate business should be considered absolute. Such a limitation of the area of hostilities is not only feasible, but it was actually put in practice by the British government during the Boer War.³

In the course of the Russo-Japanese War the question came up again, being raised this time by Great Britain. Lord Lansdowne called the attention of the Russian foreign office to the extreme inconvenience to neutral commerce of the Russian search for contraband not only in the proximity of the scene of war, but over all the world, and especially at places at which neutral commerce could be most effectually intercepted. H.M. Government had become aware that a large addition was likely to be made to the number of Russian cruisers employed in this manner, and they had, therefore, to contemplate the possibility that such vessels would shortly be found patrolling the narrow seas which lie on the route from Great Britain to Japan in such a manner as to render it virtually impossible for any neutral vessel to escape their attention. The effect of such interference with neutral trade, he said, would be disastrous to legitimate commerce passing from a British port in the United Kingdom to a British port in the Far East. The British government had no desire to place obstacles in the way of a belligerent desiring to take reasonable precautions in order to prevent the enemy from receiving supplies, but they insisted that the right of taking such precautions did not imply a "consequential right to intercept at any distance from the scene of operations and without proof that the supplies in question were really destined for use of the enemy's forces, any articles which that belligerent might determine to regard as contraband of war."

¹ In January 1900 it was reported that the British government had issued instructions to British naval commanders not to stop or search German merchant vessels at any places not in the vicinity of the seat of war. There is no proper statement of the British position on this subject, the only official information having been given by the German chancellor in a speech to the Reichstag. According to this information, the area was ultimately limited as north of Aden, and afterwards it was agreed that the immunity from search should be extended to all places beyond a distance from the seat of war equal to the distance from it of Aden. This was substantially correct, though the telegrams sent by the Admiralty can hardly be said to have fixed any precise area. As a fact, the commanders-in-chief on the East Indies and Cape of Good Hope stations were instructed that in consequence of the great practical difficulty of proving—at ports so remote from the scene of war operations as Aden and Perim—the real destination of contraband of war carried by vessels visiting those parts, directions were to be given to the officers concerned to cease to search such vessels, and to merely report to the commander-in-chief at the Cape the names of ships suspected of carrying contraband, and the date of clearance.

¹ *Memoir of Massachusetts State Board of Trade* (Feb. 13, 1905).

² This was merely reviving an idea which had come and gone many times before. See Barclay, *Problems of International Practice and Diplomacy* (1907).

The position thus assumed is not clear. On the one hand the British claim did not, it is seen, go the length of the restriction Great Britain consented to place on her own right of search during the Boer War, seeming to apply only to the case of ships carrying conditional contraband. On the other, the complaint is based on the "interference" with neutral trade, which means the stoppage and search of vessels to ascertain whether they have contraband of any kind on board or not.

It must not be forgotten in this connexion that restriction of the rights of the belligerent necessarily entails extension of the duties of the neutral. The belligerent has an unquestioned right to "interfere" with all neutral vessels navigating in the direction of the seat of war, for the purpose of ascertaining whether they are carrying any kind of contraband or not. Under the Declaration of London of the 26th of February 1909 it is provided under arts. 32 and 35 that a ship's papers are conclusive proof as to the voyage on which she is engaged unless she is clearly out of the course indicated by her papers and is unable to give adequate reasons to justify her deviation. Thus the interference, if the declaration is ratified, will be confined to an examination of the ship's papers where the ship is not bound for a belligerent port (cf. art. 30 of the same convention).

Standing Peace Agreements.—Foremost among standing peace agreements are, of course, the International Hague Conventions relating directly to peace, agreements which have not only created a special peace jurisdiction for the settlement of international difficulties by judicial methods but also a written law to apply within the scope of this jurisdiction.

Alongside the Hague Peace Conventions and more or less connected with them are standing treaties of arbitration which have been entered into by different nations for terms of years separately. The first of what may be called a new series was that between Great Britain and France. It has now been followed by over a hundred others forming a network of international relationships which shows that, at any rate, the wish for peace is universal among mankind.¹

¹ The following list of standing arbitration treaties concluded after the signing of the Anglo-French treaty of October 14th 1903 is as complete as possible down to June 1910:—

- Argentina—Brazil, September 7, 1905.
- Portugal, August 27, 1909.
- Austria-Hungary—Switzerland, December 3, 1904.
- Belgium—Denmark, April 26, 1905.
- Greece, May 2, 1905.
- Norway and Sweden, November 30, 1904.
- Rumania, May 27, 1905.
- Russia, October 30, 1904.
- Spain, January 23, 1905.
- Switzerland, November 15, 1904.
- Brazil—Portugal, March 25, 1909.
- Spain, April 8, 1909.
- Mexico, April 11, 1909.
- Honduras, April 26, 1909.
- Venezuela, April 30, 1909.
- Panama, May 1, 1909.
- Ecuador, May 13, 1909.
- Costa Rica, May 18, 1909.
- Cuba, June 19, 1909.
- Bolivia, June 25, 1909.
- Nicaragua, June 28, 1909.
- Norway, July 13, 1909.
- China, August 3, 1909.
- Salvador, September 3, 1909.
- Peru, December 7, 1909.
- Sweden, December 14, 1909.
- Colombia—Peru, September 12, 1905.
- France, December 16, 1908.
- Denmark—France, September 15, 1905.
- Italy, December 16, 1905.
- Netherlands, February 12, 1904.
- Russia, March 1, 1905.
- Spain, December 1, 1905.
- Norway, October 8, 1908.
- France—Italy, December 26, 1903.
- Netherlands, April 6, 1904.
- Norway and Sweden, July 9, 1904.
- Spain, February 26, 1904.

There are, however, a large number of conventions which, although not concluded with the direct object of assuring peace where difficulties have arisen, tend in a very practical manner to contract the area of possible difficulties. These are conventions for the regulation of intercourse between the subjects and citizens of different states. Such conventions obviously remove occasions for friction and are therefore among the most effective agencies contributing to the preservation of peace among civilized peoples. In most cases such conventions have created international unions of states for all matters which lend themselves to international co-operation. The first in order of date was the postal union. The system it inaugurated has now extended its scope to telegraphs, copyright, industrial property, railway traffic, the publication of customs tariffs, metric measures, monetary systems and agriculture. Berne, being the capital of the most central of the neutral European states, is the administrative centre of most of these unions. Customs tariffs and the monetary unions, however, are centralized at Brussels,

- France—Sweden and Norway, July 9, 1904.
- Switzerland, December 14, 1904.
- Brazil, April 7, 1909.
- Great Britain—France, October 14, 1903.
- Germany, July 12, 1904.
- Italy, February 1, 1907.
- Austria-Hungary, January 11, 1905.
- Netherlands, February 15, 1905.
- Colombia, December 30, 1908.
- Sweden and Norway, August 11, 1904.
- Denmark, October 25, 1904.
- Portugal, November 16, 1904.
- Spain, February 27, 1904.
- Switzerland, November 16, 1904.
- United States, April 4, 1908.
- Brazil, June 18, 1909.
- Honduras—Spain, May 13, 1905.
- Italy—Argentina, September 18, 1907.
- Mexico, October 1, 1907.
- Peru, April 18, 1907.
- Portugal, May 11, 1905.
- Switzerland, November 23, 1904.
- Netherlands, November 21, 1909.
- Netherlands—Portugal, October 26, 1905.
- Norway—Sweden, October 26, 1905.
- Norway and Sweden—Russia, December 9, 1904.
- Spain, January 23, 1905.
- Switzerland, December 17, 1904.
- Portugal—Spain, May 31, 1904.
- Austria-Hungary, February 13, 1906.
- Denmark, March 20, 1907.
- France, June 29, 1906.
- Italy, May 11, 1905.
- Netherlands, October 1, 1904.
- Norway and Sweden, May 6, 1905. (Suspended for Norway by a new one dated December 8, 1908.)
- Spain, May 31, 1904.
- Switzerland, August 18, 1905.
- Nicaragua, July 17, 1909.
- Russia—Norway and Sweden, November 26, 1904.
- Spain—Greece, December 3-16, 1909.
- Switzerland, May 14, 1907.
- United States—Spain, April 20, 1908.
- Denmark, May 18, 1908.
- Italy, March 28, 1908.
- Japan, May 5, 1908.
- Netherlands, May 2, 1908.
- Portugal, April 6, 1908.
- Sweden, May 2, 1908.
- Switzerland, February 29, 1908.
- Argentina, December 23, 1908.
- Peru, December 3, 1908.
- Salvador, December 21, 1908.
- Norway, April 4, 1908.
- Mexico, March 24, 1908.
- France, February 2, 1908.
- Ecuador, January 7, 1909.
- Bolivia, January 7, 1909.
- Haiti, January 7, 1909.
- Uruguay, January 9, 1909.
- Chile, January 13, 1909.
- Costa Rica, January 13, 1909.
- Austria-Hungary, January 15, 1909.
- Brazil, January 23, 1909.
- Paraguay, March 13, 1909.
- China, October 8, 1908.

the weights and measures union in Paris and the agricultural institute at Rome.

The general postal union was created by a convention signed at Berne in 1874. A convention for a similar union for telegraphs was signed in Paris in 1875 (revised at St Petersburg and replaced by another the same year). Both unions issue monthly bulletins and other publications giving useful information about these two services.¹

The international bureau of weights and measures at Paris was created by a convention signed there in 1875, for the purpose of comparing and verifying weights and measures on the metric system, and preserving their identity for the contracting states.

The double-standard Latin union monetary system was founded by a convention of 1865, between Belgium, France, Italy and Switzerland. In 1868 it was joined by Greece. A single standard union exists between Sweden, Norway and Denmark under a convention of 1873.

The copyright union was created by an international convention signed in 1874. The official bureau of the union is at Berne. It issues a periodical publication called *Le Droit d'auteur* giving information respecting the laws of different states relating to published matter of all kinds.

The term "industrial property" covers patents, trade marks, merchandise marks, trade names, designs and models. The convention dealing with them signed in 1883 created a union with its central office at Berne. It, too, issues a bulletin and other publications which help to prevent misunderstandings.

The railway traffic union was formed by a convention of 1890. The central bureau at Berne issues a monthly bulletin. A subsequent convention was signed at Berne in 1886 relating to matters of technical unification.

A subsidiary convention not quite falling within the scope of the above convention is the submarine telegraphs convention, which was signed in 1884. It applies outside territorial waters to all legally established submarine cables landed on the territories, colonies or possessions of one or more of the high contracting parties. Under its provisions it is a punishable offence "to break or injure a submarine cable wilfully or by culpable negligence in such manner as might interrupt or obstruct telegraphic communication either wholly or partially, such punishment being without prejudice to any civil action for damages. It also provides that:—

"Vessels engaged in laying or repairing submarine cables shall conform to the regulations as to signals which have been, or may be, adopted by mutual agreement among the high contracting parties with the view of preventing collisions at sea. When a ship engaged in repairing a cable exhibits the said signals, other vessels which see them or are able to see them shall withdraw to or keep beyond a distance of one nautical mile at least from the ship in question so as not to interfere with her operations" (art. 5). "Owners of ships or vessels who can prove that they have sacrificed an anchor, a net or other fishing-gear in order to avoid injuring a submarine cable shall receive compensation from the owner of the cable," and "in order to establish a claim to such compensation a statement supported by the evidence of the crew should whenever possible be drawn up immediately after the occurrence and the master must within twenty-four hours after his return to or next putting into port make a declaration to the proper authorities" (art. 7). "The tribunals competent to take cognizance of infractions of the present convention are those of the country to which the vessel on board of which the offence was committed belongs" (art. 8). By art. 15 it is provided that the stipulations of the convention do not in any way restrict the action of belligerents. It may be remarked that the British representative at the time of signing the convention declared that his government understood that in the time of war a belligerent would be free to act in regard to submarine cables as though the convention did not exist. The act to carry into effect the above convention is the Submarine Telegraph Act 1885 (48 & 49 Vict. c. 49) which was slightly modified by 50 Vict. c. 3. Section 3 of the earlier act provides that a person who injures the cable either wilfully or by culpable negligence is "guilty of a misdemeanour and on conviction: (a) if he acted wilfully, shall be liable to penal servitude for a term not exceeding five years, or to imprisonment with or without hard labour for a term not exceeding two years, and to a fine either in lieu of or in addition to such penal servitude or imprisonment; and (b) if he acted by culpable negligence shall be liable to imprisonment for a term not exceeding three months without hard labour, and to a fine not exceeding £100 either in lieu of or in addition to such imprisonment."

See Board of Trade Correspondence on Protection of Submarine Cables, printed on the 24th of July 1882; and Parliamentary Paper C. 5910: 1890.

Under the convention creating the customs tariffs union, signed in 1890, thirty states, including Great Britain and most British colonies, are associated for the purpose of prompt publication of custom tariffs and their modifications.

The agricultural institute, created by a convention of 1905 with its seat at Rome, as the latest in date is perhaps the most interesting of the series. It shows how deep and widespread the sense of the utility of international state co-operation has become. The convention sets out the scope and objects of the institute, which a recent British official publication states has been joined by 38 states, including Great Britain and all other great powers, as follows:—

Whilst limiting its action to international questions, it shall be the duty of the institute: (a) To collect, elaborate and publish, with as little delay as possible, statistical, technical, or economic information regarding the cultivation of the soil, its productions, whether animal or vegetable, the trade in agricultural products, and the prices obtained on the various markets. (b) To communicate to interested parties, also without delay, full information of the nature above mentioned. (c) To indicate the wages of rural labour. (d) To notify all new diseases of plants which may appear in any part of the world, indicating the districts affected, the spread of the disease, and, if possible, the efficacious means of resistance. (e) To consider questions relating to agricultural co-operation, insurance and credit, in all their forms, collecting and publishing information which may be useful in the various countries for the organization of undertakings relating to agricultural co-operation, insurance and credit. (f) To present, if expedient, to the governments, for their approval, measures for the protection of the common interests of agriculturists and for the improvement of their condition, after having previously taken every means of obtaining the necessary information, e.g. resolutions passed by international congresses or other congresses relating to agriculture or to sciences applied to agriculture, agricultural societies, academies, learned societies, &c.

All questions relating to the economic interests, the legislation and administration of any particular state, must be excluded from the sphere of the institute. (Art. 9).

Lastly, there is a class of difficulties which might arise from preferential treatment of trade from different countries. To obviate them statesmen have been led to adopt the principle of the "most-favoured-nation-clause"—that is to say, a clause providing that if any reductions of tariff or other advantages are granted by either contracting state to any third state, the others shall have the benefit of it. In Europe this clause has been uniformly treated as applying to all reductions of tariff without distinction. The United States interpretation, on the other hand, distinguishes between reductions of a general character and reductions made specifically in return for reductions by some other state. The latter do not come within the operation of the clause, and a co-contracting state is only entitled to obtain extension of them to itself on granting similar concessions. In other words, concessions to any co-contracting state are only allowed gratuitously to a third co-contracting state when nothing has been given for them, the clause not covering advantages granted in return for advantages. It is to be hoped that this special view of the meaning of the clause will be met in the future, as in some recent treaties, by specifically dealing with the exceptions.²

The Utility of Popular Effort.—Until quite recently it had been a distinctive mark of practical wisdom to treat private efforts for the improvement of international relations for the preservation of peace, with the patronizing tolerance courteous people of the world extend to half-crazy idealists. Since the opening of the century, an immense change has taken place in the attitude of the leaders of popular opinion towards the advocacy of peace. This new attitude has been contemporary with the greater interest displayed by the mercantile classes of England and the United States in the improvement of their political relations with their neighbours. It may be said to have begun with the visit of the Association of British Chambers of Commerce to Paris in 1900, at a time when France was still smarting from the humiliation of the Fashoda affair, and the Boer War was exciting hostile demonstrations against Great Britain throughout the continent of Europe. That some four hundred British manufacturers

¹ See Barclay, *Problems of International Practice and Diplomacy* (1907), p. 137 seq.

and merchants, representing about eighty chambers of commerce of the United Kingdom, should have swept aside all political objections, and have boldly trusted to the efficacy of friendly advances as between man and man, appealed to the French people. It seems to have been the first great popular effort ever made deliberately by a representative body of the middle class of a nation for the promotion of international friendship without the aid of diplomacy and without official assistance or even countenance of any kind.

Otherwise, private agencies of a standing character which contribute towards the promotion of peace may be divided into four classes, viz. (1) those which, without having peace for their direct object, promote friendship among men of different races and nationalities; (2) those which directly address themselves to the promoting of friendship and goodwill among peoples; (3) those which regarding peace as the immediate object of their efforts, endeavour to educate democracy in this sense; (4) those which endeavour to remove the causes of international friction by the codification of international law and the promotion of the international regulation of common interests. Lastly, there are two agencies which cannot be classed among the foregoing; one is the International Parliamentary Union and the other the Nobel Prize Committee.

1. Agencies which are indirectly making for peace are of many kinds. Science and medicine now bring men of all nations together in periodical congresses. Technology, electricity, mining, railways, navigation and many other subjects are now dealt with in international congresses. International exhibitions are always used as an occasion for holding many such meetings.

2. One of the most notable efforts directed to the deliberate cementing of friendship has been the interchange of official visits by municipal bodies. In the course of the Anglo-French agitation which culminated in March 1903 with the visit of King Edward to Paris, the French municipal councils passed many resolutions in favour of the *entente*. After the conclusion of the Anglo-French standing treaty of arbitration (Oct. 14, 1903) and the arrangements for the general settlement of outstanding difficulties with France (April 8, 1904), the municipal bodies in France were prepared to go a step farther, and in 1906 the Municipal Council of Paris was invited by the London County Council to pay an official visit to England. This visit was followed by a return visit to Paris and a similar exchange of visits between the London City Corporation and the Paris Municipal Council, exchange visits of the city corporations of Manchester, Glasgow and Edinburgh and Lyons, and a visit of the Manchester Corporation to Düsseldorf, Barmen and Cologne. A society, numbering many thousands of working men among its members, which has set itself the more special task of promoting the interchange of visits between working men of different nations, is called the "International Brotherhood Alliance," or, after the initials of its motto, *Fraternitas inter gentes*, the F.I.G. Another agency, called the "American Association for International Conciliation," seeks by the publication of essays on the different aspects of international friendship to promote the same cause.

3. The "peace societies," which are scattered over the whole world, number several hundreds.¹ Their first International Congress was held in London at the suggestion of Joseph Sturge in 1843. In 1848 a second congress was held at Brussels. The third in 1849 took place in Paris, and was presided over by Victor Hugo. Other congresses were held at Frankfurt, again in London, and in 1853 at Manchester, where Richard Cobden and John Bright took part in the discussions. Then followed an interval of wars during which the Pacifists were unable to raise their voices. At length in 1873 a congress was held at the Paris International Exhibition of that year, but it was not till the next Paris International Exhibition of 1889 that these international peace congresses became periodical. Since then numerous congresses have been held, the seventeenth having sat in London in 1908, and the eighteenth at Stockholm in 1910. These congresses have been supplemented by national congresses in

¹ See *Annuaire du mouvement pacifiste pour l'année 1910*, published by the Bureau International de la Paix, at Bern.

both Great Britain and France. Such congresses are doing admirable work in the popularizing of thought upon the numerous questions which are discussed at the meetings, such as compulsory arbitration, the restriction of armaments, private property at sea in time of war, the position of subject races, airships in war, &c.²

4. First among the bodies which try to remove the causes of international friction is the Institute of International Law. This is a body of international lawyers, consisting of sixty members and sixty associates recruited by election—the members from those who "have rendered services to international law in the domain of theory or practice," and associates from those "whose knowledge may be useful to the Institute." It was formed in 1873, chiefly through the efforts of M. Jolin-Jacquemyns. The official language of the Institute is French, and its annual meetings are held wherever the members at the previous meeting decide to assemble. Its mode of operation is to work out the matters it deals with during the intervals between the sessions, in permanent commissions, among which the whole domain of international law is divided up. The commissions, under the direction of their *rapporteurs* or conveners, prepare reports and proposals, which are printed and distributed among the members some time before the plenary sittings at which they are to be discussed. If the members are not agreed, the subject is adjourned to another session, and still another, until they do agree. Thus the resolutions of the Institute have the authority attaching to a mature expression of the views of the leading international jurists of Europe. Another body having a more or less similar purpose is the International Law Association, which was founded in 1873 as the "Association for the Reform and Codification of the Law of Nations," with practically the same objects as those which led to the constitution of the Institute of International Law. It also meets in different countries, but it differs from the Institute in the number of its members being unlimited and in all respectable persons being eligible for membership. A report is published after each meeting. There are now numerous volumes of such reports, many of them containing most valuable materials for international jurists. In 1895 the name was changed to International Law Association.

A new society was recently (1906) formed in America called the American Society of International Law, "to foster the study of international law and promote the establishment of international relations on the basis of law and justice." "Membership in the society is not restricted to lawyers, and any man of good moral character interested in the objects of the society may be admitted to membership." The publications of this society have already taken an important place among the literature of international law.

Still more recently yet another society came into being in Switzerland with objects which seem to be similar to those of the Institute of International Law.

The Inter-Parliamentary Union, which dates back to 1887, owes its origin to the initiative of the late Sir W. R. Cremer. It is composed of groups of the different parliaments of the world, who meet periodically to "bring about the acceptance in their respective countries, by votes in parliament and by means of arbitration treaties, of the principle that differences between nations should be submitted to arbitration and to consider other questions of international importance."³ The sixteenth conference was held at Brussels in August–September, 1910.

² At the third congress of the new series, held at Rome in 1891, was created the Bureau International de la Paix. This most useful institution, which has its office at Bern, serves as a means of bringing and keeping together all the known peace societies. Its *Correspondance bimensuelle* and *Annuaire du mouvement pacifiste* are well known, and its obliging hon. secretary, Dr A. Gobat, is always ready to supply information from the now considerable archives of the Bureau. In this connexion we may mention that the secretary of the London Peace Society, Dr Evans Darby, has edited an exhaustive collection of materials called *International Tribunals*. His statements every two years on the progress of arbitration at the International Law Association meetings also form an excellent source of materials for reference.

³ Art. 1 of Statutes revised Sept. 1908.

The Nobel Committee owes its existence to the will of the late Alfred B. Nobel (1833-1896), the inventor of dynamite, who left a considerable fortune for the encouragement of men who work for the benefit of humanity. The interest of this money was to be divided into five equal parts, to be distributed every year as rewards to the persons who had deserved best of mankind in five departments of human activity. The clauses of the will governing the distribution of these prizes are as follows:—

"The entire sum shall be divided into five equal parts, one to go to the man who shall have made the most important discovery or invention in the domain of physical science; another to the man who shall have made the most important discovery or introduced the greatest improvement in chemistry; the third to the author of the most important discovery in the domain of physiology or medicine; the fourth to the man who shall have produced the most remarkable work of an idealistic nature; and, finally, the fifth to the man who shall have done the most or best work for the fraternity of nations, the suppression or reduction of standing armies, and the formation and propagation of peace congresses. The prizes shall be awarded as follows: For physical science and chemistry, by the Swedish Academy of Sciences; for physiological or medical work, by the Caroline Institution at Stockholm; for literature, by the Stockholm Academy, and for peace work, by a committee of five members elected by the Norwegian Storting. It is my express desire that, in awarding the prizes, no account shall be taken of nationality, in order that the prize may fall to the lot of the most deserving, whether he be Scandinavian or not."

Peace v. War.—Peace is the ultimate object of all statecraft—peace in the development of the domestic activities of the nation administered, and peace in the relations of states with one another. For the purpose of ensuring peace an expensive diplomacy is maintained by all states, and to perpetuate it treaties are entered into by states with one another. Even war has no other avowed purpose than that of placing specific international relations on a definite footing. Ultimate peace is uniformly proclaimed by every dictator at home, by every conqueror abroad, as the goal to which he is directing his efforts. And yet dissentient voices are sometimes heard defending war as if it were an end in itself. Without going back to the well-known reply of Count Moltke to Professor Bluntschli respecting the *Manual of the Laws of War* drawn up by the Institute of International Law in 1880,¹ we need only quote that highly up-to-date philosopher, Nietzsche: "It is mere illusion and pretty sentiment," he observes, "to expect much (even anything at all) from mankind if it forgoes how to make war. As yet no means are known which call so much into action as a great war, that rough energy born of the camp, that deep impersonality born of hatred, that conscience born of murder and cold-bloodedness, that fervour born of effort in the annihilation of the enemy, that proud indifference to loss, to one's own existence, to that of one's fellows, to that earthquake-like soul-shaking which a people needs when it is losing its vitality."²

It is pleasant to contrast this neurotic joy of one onlooker with the matter-of-fact reflexions of another, the late W. E. H. Lecky. "War" he says "is not, and never can be a mere passionless discharge of a painful duty. It is in its essence, and it is a main condition of its success, to kindle into fierce exercise among great masses of men the destructive and combative passions—passions as fierce and as malevolent as that with which the hound hunts the fox to its death or the tiger springs upon its prey. Destruction is one of its chief ends. Deception is one of its chief means, and one of the great arts of skillful generalship is to deceive in order to destroy. Whatever other elements may mingle with and dignify war, this at least is never absent; and however reluctantly men may enter into war, however conscientiously they may endeavour to avoid it, they must know that when the scene of carnage has once opened, these things must be not only accepted and condoned, but stimulated, encouraged and applauded. It would be difficult to conceive a disposition more remote from the morals of ordinary life, not to speak of Christian ideals, than that with

¹ "Perpetual peace," he said, "is a dream, and it is not even a beautiful dream. War is an element in the order of the world ordained by God . . . Without war the world would stagnate and lose itself in materialism."

² *Menschliches, Allzumenschliches*, No. 477.

which the soldiers most animated with the fire and passion that lead to victory rush forward to bayonet the foe. . . . It is allowable to deceive an enemy by fabricated despatches purporting to come from his own side; by tampering with telegraph messages; by spreading false intelligence in newspapers; by sending pretended spies and deserters to give him untrue reports of the numbers or movements of the troops; by employing false signals to lure him into an ambushade. On the use of the flag and uniform of an enemy for purposes of deception there has been some controversy, but it is supported by high military authority. . . . Hardly any one will be so confident of the virtue of his rulers as to believe that every war which his country wages in every part of its dominions with uncivilized as well as civilized populations, is just and necessary, and it is certainly *prima facie* not in accordance with an ideal morality that men should bind themselves absolutely for life or for a term of years to kill without question, at the command of their superiors, those who have personally done them no wrong."³

Surely with all the existing activity in the removal of causes of war, in the reduction to precise expression of the rules of law governing the relations of states with one another, in the creation of international judicatures for the application of these rules, in the concluding of treaties specifically framed to facilitate the pacific settlement of difficulties diplomacy may have failed to adjust, in the promotion of democratic civilian armies with everything to lose by war, and all the other agencies which have been described above, the hope seems warranted that, in no distant future, life among nations will become still more closely assimilated to life among citizens of the same nation, with legislation, administration, reform all tending to the one great object of law, order and peace among men. (T. BA.)

PEACE, BREACH OF THE. Theoretically all criminal offences cognizable by English law involve a breach of the king's peace, and all indictments whether for offences against the common law or by statute conclude "against the peace of our lord the king, his crown and dignity." Historically this phrase, now legally superfluous, represents the last trace of the process by which the royal courts assume jurisdiction over all offences, and gradually extruded the jurisdiction of the sheriff and of lords of manors and franchises, making crime a matter of national concern as distinguished from civil wrongs or infractions of the rights of local magnates, or of the rights of the tribal chiefs of the Teutonic conquerors of Britain. The peace of the king was sworn on his accession or full recognition, and the jurisdiction of his courts to punish all violations of that peace was gradually asserted. The completion of this process is marked by the institution of the office of justice of the peace.

In modern times the expression "breach of the peace" is usually limited to offences involving actual tumult, disturbances or disorder. As regards such offences, although they do not fall into the class of grave crimes described as felonies, officers of police and even private persons have larger powers and duties, as to immediate arrest without waiting for judicial warrant, than they possess as to other minor offences (see ARREST). Justices of the peace have under early statutes and the commission of the peace power to take sureties of the peace from persons who are threatening to commit a breach of the peace, and it is within the power of any court on conviction of any misdemeanour and of many felonies to require the offender to enter into a recognizance (*g.v.*) to keep the peace.

PEACE CONFERENCES, the official title of the two international conferences held at the Hague in 1899 and 1907. Both were organized at the instance of the emperor Nicholas II. of Russia. The chief object of the first conference, as set out in the note of Count Mouraviev, the Russian minister of foreign affairs (Jan. 11, 1899), was to arrive at an "understanding not to increase for a fixed period the present effectives of the armed military and naval forces, and at the same time not to increase the budgets pertaining thereto; and a preliminary examination of the means by which even a reduction might be effected in future in the forces and budgets above

³ *The Map of Life*, 1902, pp. 92-97.

mentioned."¹ The conference, which was attended by representatives of 26 states, sat from the 18th of May to the 29th of July 1899.

When the subject of excessive armaments came up for discussion, the objections of the German military delegate led to its abandonment. Other very important matters, however, were dealt with, and three momentous conventions were adopted, viz.—

I. A convention for the pacific settlement of international disputes.

II. A convention relating to the laws and customs of war by land.

III. A convention for the adaptation to maritime warfare of the principles of the Geneva Convention of the 22nd of August 1864.

Three declarations on the following matters were also adopted:—

a. Prohibition of the launching of projectiles and explosives from balloons or by other similar new methods.²

b. Prohibition of the use of projectiles the only object of which is the diffusion of asphyxiating or deleterious gases.

c. Prohibition of the use of bullets which expand or flatten easily in the human body, such as bullets with a hard envelope, of which the envelope does not entirely cover the core, or is pierced with incisions.

The conference furthermore passed the following resolutions:—

"The Conference is of opinion that the restriction of military budgets, which are at present a heavy burden on the world, is extremely desirable for the increase of the material and moral welfare of mankind."

"The Conference, taking into consideration the preliminary steps taken by the Swiss Federal Government for the revision of the Geneva Convention, expresses the wish that steps may be shortly taken for the assembling of a special Conference, having for its object the revision of that Convention."

The following *vases* were adopted, but not unanimously:—

"1. The Conference expresses the wish that the question of the rights and duties of neutrals may be inserted in the programme of a conference in the near future.

"2. The Conference expresses the wish that the questions with regard to rifles and naval guns, as considered by it, may be studied by the Governments with the object of coming to an agreement respecting the employment of new types and calibres.

"3. The Conference expresses the wish that the Governments, taking into consideration the proposals made at the Conference, may examine the possibility of an agreement as to the limitation of armed forces by land and sea, and of war budgets.

"4. The Conference expresses the wish that the proposals which contemplate the declaration of the inviolability of private property in naval warfare may be referred to a subsequent conference for consideration.

"5. The Conference expresses the wish that the proposal to settle the question of the bombardment of ports, towns and villages by naval forces may be referred to a subsequent conference for consideration."

Great Britain signed and became a party to the three Conventions, but not to all the declarations, &c.

The Conference of 1907, which was attended by representatives of forty-four states, sat from the 15th of June to the 18th of October. Again, in spite of the resolution and *vase* on armaments handed down from the Conference of 1899 this subject was waived, but still more important conventions than in 1899 were adopted on other matters. These were as follows:—

I. Convention for the pacific settlement of international disputes.³

II. Convention respecting the limitation of the employment of force for the recovery of contract debts.

III. Convention relative to the commencement of hostilities.

IV. Conventions concerning the laws and customs of war on land.⁴

V. Convention respecting the rights and duties of neutral powers and persons in war on land.

VI. Convention relative to the status of enemy merchant-ships at the outbreak of hostilities.

¹ At the Conference the Russian government, further developing the proposal, submitted the following details:—

"1. Establishment of an international understanding for a term of five years, stipulating non-increase of the present figures of the peace effective of the troops kept up for home use.

"2. Fixation, in case of this understanding being arrived at, and, if possible, of the figures of the peace effective of all the powers excepting colonial troops.

"3. Maintenance for a like term of five years of the amount of the military budgets at present in force."

² This Conference was held at Geneva in June-July 1906. The revised Convention, composed of 33 articles, is dated July 6, 1906.

³ This is an amended edition of that of 1899.

VII. Convention relative to the conversion of merchant-ships into war-ships.

VIII. Convention relative to the laying of automatic submarine contact mines.

IX. Convention respecting bombardment by naval forces in time of war.

X. Conventions for the adaptation of the principles of the Geneva Convention to maritime war.⁴

XI. Convention relative to certain restrictions on the exercise of the right of capture in maritime war.⁴

XII. Convention relative to the establishment of an international prize court.

XIII. Convention respecting the rights and duties of neutral powers in maritime war.

XIV. Declaration prohibiting discharge of projectiles, &c., from balloons.⁵

A draft Convention relative to the creation of a judicial arbitration court was also drawn up in connexion with the first of the four following *vases*:—

1. The Conference calls the attention of the signatory powers to the advisability of adopting the annexed draft convention for the creation of a judicial arbitration court, and of bringing it into force as soon as an agreement has been reached respecting the selection of the judges and the constitution of the court.

2. The Conference expresses the opinion that, in case of war, the responsible authorities, civil as well as military, should make it their special duty to ensure and safeguard the maintenance of pacific relations, more especially of the commercial and industrial relations between the inhabitants of the belligerent states and neutral countries.

3. The Conference expresses the opinion that the powers should regulate, by special treaties, the position, as regards military charges, of foreigners residing within their territories.

4. The Conference expresses the opinion that the preparation of regulations relative to the laws and customs of naval war should figure in the programme of the next conference,⁶ and that in any case the powers may apply, as far as possible, to war by sea the principles of the Convention relative to the laws and customs of war on land.

Finally, the Conference recommended to the powers the assembly of a Third Peace Conference, and it called their attention to the necessity of preparing the programme of this Third Conference a sufficient time in advance to ensure its deliberations being conducted with the necessary authority and expedition.

In order to attain this object the Conference considered that it "would be very desirable that, some two years before the probable date of the meeting, a preparatory committee should be charged by the governments with the task of collecting the various proposals to be submitted to the Conference, of ascertaining what subjects are ripe for embodiment in an international regulation, and of preparing a programme which the governments should decide upon in sufficient time to enable it to be carefully examined by the countries interested," and that this committee should further be entrusted with the task of proposing a system of organization and procedure for the Conference itself. (T. BA.)

PEACH, CHARLES WILLIAM (1800-1886), British naturalist and geologist, was born on the 30th of September 1800 at Wansford in Northamptonshire; his father at the time was a saddler and harness-maker, and afterwards became an innkeeper farming about 80 acres of land. He received an elementary education at Wansford and at Folkingham in Lincolnshire; and assisted for several years in the inn and farm. In 1824 he was appointed riding officer in the Revenue Coast-guard at Weybourn in Norfolk. Sea-weeds and other marine organisms now attracted his attention, and these he zealously collected. His duties during the next few years led him to remove successively to Sheringham, Hasboro (Happisburgh), Cromer and Cley, all in Norfolk. In the course of his rambles he met the Rev. James Layton, curate at Catfield, who lent him books and assisted in laying the foundations of accurate knowledge. About the year 1830 he was transferred to Charmouth in Dorset, thence to Beer, and Paignton in Devon, and to Gorran Haven near Mevagissey in Cornwall. Here he continued to pursue his zoological studies

⁴ This is an amended edition of that of 1899.

⁵ This was practically a re-enactment of that of 1899.

⁶ This has since been done to a large extent by the Conference of London (1908-1909). See BLOCKADE, CONTRABAND, INTERNATIONAL LAW PEACE.

and supplied many specimens to G. Johnston, who was then preparing his *History of the British Zoophytes* (1838). It was here too that he first found fossils in some of the older rocks previously regarded as unfossiliferous—the discovery of which proved the presence of Bala Beds (Ordovician or Lower Silurian) in the neighbourhood of Gorran Haven. In 1841 he read a paper before the British Association at Plymouth "On the Fossil Organic Remains found on the south-east coast of Cornwall," and in 1843 he brought before the Royal Geological Society of Cornwall an account of his discovery of fish remains in the Devonian slates near Polperro. Peach was transferred for a time to Fowey; and in 1849 to Scotland, first to Peterhead and then to Wick (1853), where he made acquaintance with Robert Dick of Thurso. He collected the old red Sandstone fishes, and during a sojourn at Durness he first found fossils in the Cambrian limestone (1854). Peach retired from the government service in 1861, and died at Edinburgh on the 28th of February 1886.

Biographical notice, with portrait, in S. Smiles's *Robert Dick, Baker, of Thurso, Geologist and Botanist* (1878).

PEACH, the name of a fruit tree which is included by Bentham and Hooker (*Genera plantarum*, i. 610) under the genus *Prunus* (*Prunus persica*), its resemblance to the plum is indeed obvious. Others have classed it with the almond as a distinct genus, *Amygdalus*; while others again have considered it sufficiently distinct to constitute a separate genus, *Persica*.

In general terms the peach may be said to be a medium-sized tree, with lanceolate, stipulate leaves, borne on long, slender, relatively unbranched shoots, and with the flowers arranged singly, or in groups of two or more, at intervals along the shoots of the previous year's growth. The flowers have a hollow tube at the base bearing at its free edge five sepals, an equal number of petals, usually concave or spoon-shaped, pink or white, and a great number of stamens. The pistil consists of a single carpel with its ovary, style, stigma and solitary ovule or twin ovules. The fruit is a drupe (fig. 1) having a thin outer skin (epicarp) enclosing the flesh of the peach (mesocarp), the inner layers of the carpel becoming woody to form the stone, while the ovule ripens into the kernel or seed. This is exactly the structure of

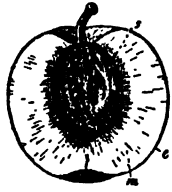

FIG. 1.—Fruit (drupe) of Peach cut lengthwise.
a, Skin or epicarp.
b, Flesh or mesocarp.
c, Stone or endocarp, within which is the seed or kernel.

the plum or apricot, and differs from that of the almond, which is identical in the first instance, only in the circumstance that the fleshy part of the latter eventually becomes dry and leathery and cracks open along a line called the suture.

The nectarine is a variation from the peach, mainly characterized by the circumstance that, while the skin of the ripe fruit is downy in the peach, it is shining and destitute of hairs in the nectarine. That there is no essential difference between the two is, however, shown by the facts that the seeds of the peach will produce nectarines, and vice versa, and that it is not very uncommon, though still exceptional, to see peaches and nectarines on the same branch, and fruits which combine in themselves the characteristics of both nectarines and peaches. The blossoms of the peach are formed the autumn previous to their expansion, and this fact, together with the peculiarities of their form and position, requires to be borne in mind by the gardener in his pruning and training operations. The only point of practical interest requiring mention here is the very singular fact attested by all peach-growers, that, while certain peaches are liable to the attacks of mildew, others are not. In the case of the peach this peculiarity is in some way connected with the presence of small glandular outgrowths on the stalk, or at the base of the leaf. Some peaches have globular, others reniform glands, others none at all, and these latter trees are much more subject to mildew than are those provided with glands.

The history of the peach, almond and nectarine is interesting and important as regards the question of the origin of species and

the production and perpetuation of varieties. As to the origin of the peach two views are held, that of Alphonse de Candolle, who attributes all cultivated varieties to a distinct species, probably of Chinese origin, and that adopted by many naturalists, but more especially by Darwin, who looks upon the peach as a modification of the almond.

In the first place, the peach as we now know it has been nowhere recognized in the wild state. In the few instances where it is said to have been found wild the probabilities are that the tree was an escape from cultivation. Aitchison, however, gathered in the Hazardarakht ravine in Afghanistan a form with different-shaped fruit from that of the almond, being larger and flatter. "The surface of the fruit," he observes, "resembles that of the peach in texture and colour; and the nut is quite distinct from that of the wild almond." The whole shrub resembles more what one might consider a wild form of the peach than that of the almond. It is admitted, however, by all competent botanists that the almond is wild in the hotter and drier parts of the Mediterranean and Levantine regions. Aitchison also mentions the almond as wild in some parts of Afghanistan, where it is known to the natives as "bedām," the same word that they apply to the cultivated almond. The branches of the tree are carried by the priests in religious ceremonies. It is not known as a wild plant in China or Japan. As to the nectarine, of its origin as a variation from the peach there is abundant evidence, as has already been mentioned; it is only requisite to add the very important fact that the seeds of the nectarine, even when that nectarine has been produced by bud-variation from a peach, will generally produce nectarines, or, as gardeners say, "come true." Darwin brings together the records of several cases, not only of gradations between peaches and nectarines, but also of intermediate forms between the peach and the almond. So far as we know, however, no case has yet been recorded of a peach or a nectarine producing an almond, or vice versa, although if all have had a common origin such an event might be expected. Thus the botanical evidence seems to indicate that the wild almond is the source of cultivated almonds, peaches and nectarines, and consequently that the peach was introduced from Asia Minor or Persia, whence the name *Persica* given to the peach; and Aitchison's discovery in Afghanistan of a form which reminded him of a wild peach lends additional force to this view.

On the other hand, Alphonse de Candolle, from philological and other considerations, considers the peach to be of Chinese origin. The peach has not, it is true, been found wild in China, but it has been cultivated there from time immemorial; it has entered into the literature and folk-lore of the people; and it is designated by a distinct name, "to" or "tao," a word found in the writings of Confucius five centuries before Christ, and even in other writings dating from the sixth century before the Christian era. Though now cultivated in India, and almost wild in some parts of the north-west, and, as we have seen, probably also in Afghanistan, it has no Sanskrit name; it is not mentioned in the Hebrew text of the Scriptures, nor in the earliest Greek times. Xenophon makes no mention of the peach, though the Ten Thousand must have traversed the country where, according to some, the peach is native; but Theophrastus, a hundred years later, does speak of it as a Persian fruit, and De Candolle suggests that it might have been introduced into Greece by Alexander. According to his view, the seeds of the peach, cultivated for ages in China, might have been carried by the Chinese into Kashmir, Bokhara, and Persia between the period of the Sanskrit emigration and the Graeco-Persian period. Once established, its cultivation would readily extend westward, or, on the other hand, by Cabul to north-western India, where its cultivation is not ancient. While the peach has been cultivated in China for thousands of years, the almond does not grow wild in that country and its introduction is supposed not to go back farther than the Christian era.

On the whole, greater weight is due to the evidence from botanical sources than to that derived from philology, particularly since the discovery both of the wild almond and of a form like a wild peach in Afghanistan. It may, however, well be that both peach and almond are derived from some pre-existing and now extinct form whose descendants have spread over the whole geographic area mentioned; but this is a mere speculation, though indirect evidence in its support might be obtained from the nectarine, of which no mention is made in ancient literature, and which, as we have seen, originates from the peach and reproduces itself by seed, thus offering the characteristics of a species in the act of developing itself.

The treatment in horticulture of the peach and nectarine is the same in every respect. To perpetuate and multiply the choicer varieties, peaches and nectarines are budded upon plum or almond stocks. For dry situations almond stocks are preferable, but they are not long-lived, while for damp or clayey loams it is better to use certain kinds of plums. Double-working is sometimes beneficial; thus an almond budded on a plum stock may be rebudded with a tender peach, greatly to the advantage of the latter. The peach border should be composed of turfy mellow

loam, such as is suitable for the vine and the fig; this should be used in as rough a state as possible, or not broken small and fine. The bottom should slope towards the outer edge, where a drain should be cut, with an outlet, and on this sloping bottom should be laid a thickness of from 9 in. to 12 in. of rough materials, such as broken bricks or mortar rubbish, over which should be placed a layer of rough turf with the grassy side downwards, and then the good loamy soil to form the border, which should have a depth of about 2 ft. 6 in. The peach-tree is most productive when the roots are kept near the surface, and the borders, which should be from 8 ft. to 12 ft. wide, should not be cropped heavily with culinary vegetables, as deep trenching is very injurious. Sickly and unfruitful trees may often be revived by bringing up their roots within 5 or 6 in. of the surface. It is questionable whether it is not better, in cold soils and bleak situations, to abandon outdoor peach culture, and to cover the walls with a casing of glass, so that the trees may be under shelter during the unseasonal spring weather.

The fruit of the peach is produced on the ripened shoots of the preceding year. If these be too luxuriant, they yield nothing but leaves; and if too weak, they are incapable of developing flower buds. To furnish young shoots in sufficient abundance, and of requisite strength, is the great object of peach training and pruning. Trees of slender-growing, twiggy habit naturally fall most readily into the fan form of training, and accordingly this has generally been

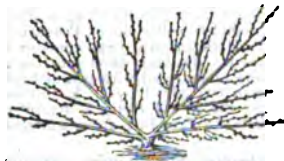

FIG. 2.—Montreuil Fan Training.

adopted in the culture of peaches and nectarines (fig. 2). The young tree is, in many cases, procured when it has been trained for two or three years in the nursery; but it is generally better to begin with a maiden plant—that is, a plant of the first year after it has been budded. It is then in ordinary practice headed down to five or six buds, and in the following summer from two to four shoots, according to the vigour of the plant, are trained in, the laterals from which, if any, are thinned out and nailed to the wall. If there are four branches, the two central ones are shortened back at the subsequent winter pruning so as to produce others, the two lower ones being laid in nearly at full length. In the following season additional shoots are sent forth; and the process is repeated till eight or ten principal limbs or mother branches are obtained, forming, as it were, the frame-work of the future tree. The branches may be depressed or elevated, so as to check or encourage them, as occasion may arise; and it is highly advantageous to keep them thin, without their becoming in any part deficient of young shoots. Sometimes a more rapid mode of formation is now adopted, the main shoots being from the first laid in nearly at full length, instead of being shortened. The pruning for fruit consists in shortening back the laterals which had been nailed in at the disbudding, or summer pruning, their length depending on their individual vigour and the luxuriance of the tree. In well-developed shoots the buds are generally double, or rather triple, a wood bud growing between two fruit buds; the shoot must be cut back to one of these, or else to a wood bud alone, so that a young shoot may be produced to draw up the sap beyond the fruit, this being generally desirable to secure its proper swelling. The point of this leading shoot is subsequently pinched off, that it may not draw away too much of the sap. If the fruit sets too abundantly, it must be thinned, first when as large as peas, reducing the clusters, and then when as large as nuts to distribute the crop equally; the extent of the thinning must depend on the vigour of the tree, but one or two fruits ultimately left to each square foot of wall is a full average crop. The final thinning should take place after stoning.

The best-placed healthy young shoot produced from the wood buds at the base of the bearing branch is to be carefully preserved and in due time nailed to the wall. In the following winter this will take the place of the branch which has just borne, and which is to be cut out. If there be no young shoot below, and the bearing branch is short, the shoot at the point of the latter may sometimes be preserved as a fruit bearer, though if the bearing branch be long it is better to cut it back for young wood. It is the neglect of this which constitutes the principal fault in carrying out the English fan system, as it is usually practised. Several times during summer the trees ought to be regularly examined, and the young shoots respectively topped or thinned out; those that remain are to be nailed to the wall, or braced in with pieces of slender twigs, and the trees ought occasionally to be washed with the garden engine or thoroughly syringed, especially during very hot summers. After gathering the fruit all the wood not needed for extending the tree

or for fruit bearing next season should be cut out so as to give the shoots left full exposure to air and light.

The Montreuil form of training is represented by fig. 2. The principal feature is the suppression of the direct channel of the sap, and the substitution of four, or more commonly two, mother branches, so laid to the wall that the central angle contains about 90°. The other branches are all treated as subordinate members. This form is open to the objection that, if the under branch should die, the upper one cannot be brought down into its place.

The form à la Dumoutier (fig. 3), so called from its inventor, is merely a refinement on the Montreuil method. The formation



FIG. 3.—Dumoutier's Fan Training.

of the tree begins with the inferior limbs and proceeds towards the centre, the branches being lowered from time to time as the tree acquires strength. What is most worthy of notice in this method is the management of the subordinates in the pruning for fruit.

When a shoot promises blossom, it is generally at some distance from the point of insertion into the old wood, and the intermediate space is covered with wood buds. All the latter, therefore, which are between the old wood *e* and the blossoms *c* in fig. 4, except the lowest *b*, are carefully removed by rubbing them off with the finger. This never fails to produce a shoot *d*, the growth of which is favoured by destroying the useless spray *e* above the blossoms, and pinching off the points of those which are necessary to perfect the fruit. A replacing shoot is thus obtained, to which the whole is invariably shortened at the end of the year.

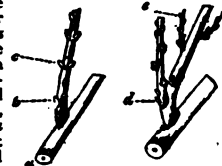

FIG. 4.—Pruning à la Dumoutier.

Seymour's form (fig. 5) approaches more nearly to the French method than any other practised in England; but the direct channel



FIG. 5.—Seymour's Fan Training.

of the sap is not suppressed, and this results in the production of branches of unequal vigour, which is very undesirable.

For cold and late situations, Thomas Andrew Knight recommended the encouragement of spurs on the young wood, as such spurs, when close to the wall, generate the best organized and most vigorous blossoms, and generally ensure a crop of fruit. They may be produced, by taking care, during the summer pruning or disbudding, to preserve a number of the little shoots emitted by the yearly wood, only pinching off the minute succulent points. On the spurs thus formed blossom buds will be developed early in the following season. This practice is well adapted to cold situations. Peach-trees require protection, especially at the period of blossoming, particularly in the north of England and in Scotland. Canvas or bunting screens are most effectual. By applying these early in the season, great benefit may be derived from retarding the blossom till the frosty nights of spring have passed. Wooden and glass copings are also very useful in warding off frosts. Care must be taken that the roots always have a sufficient supply of moisture and that the soil is moist wherever the roots run.

Forcing.—The pruning and training of the trees in the peach house do not differ materially from the methods practised out of doors. It may also be stated here that when occasion arises peach-trees well furnished with buds may be transplanted and forced immediately without risking the crop of fruit, a matter of some importance when, as sometimes happens, a tree may accidentally fall. In the forcing of peaches fire heat is commonly applied about December or January; but it may, where there is a demand, begin a month sooner. The trees must be got to start growth very

gradually, and at first the house should be merely kept closed at a temperature of about 45°, but the heat should gradually increase to 50° at night by the time the trees are in flower, and to 60° when the fruit is set, after which the house should be kept moist by sprinkling the walls and paths, or by placing water troughs on the return pipes, and the temperature should range from 65° by day to 70° or more with sun heat. After the fruit has set, the foliage should be refreshed and cleansed by the daily use of the syringe or garden engine. When the fruit has stoned—that is, as soon as the kernels have been formed—the temperature should be raised to about 65° as a minimum, and to 70°, with 75° by sun heat, as a maximum. Water must now be copiously supplied to the border, and air admitted in abundance, but cold draughts which favour the attack of mildew must be avoided. After the end of April little fire heat is required. When the fruit begins to ripen, syringing must be discontinued till the crop is gathered, after which the syringe must be again occasionally used. If the leaves should happen to shade the fruit, not only during the ripening process but at any time after the stoning period, they should be gently turned aside, for, in order that the fruit may acquire good colour and flavour, it should be freely exposed to light and air when ripening; it will bear the direct rays of the sun, even if they should rise to 100°, but nectarines are much more liable to damage than peaches. The trees often suffer from mildew, which is best prevented by keeping the borders of the peach house clear and sufficiently moist and the house well ventilated, and if it should appear the trees should be sprayed with 1 oz. potassium sulphide dissolved in 3 gallons of water. Care must be taken in using this fungicide not to wet the painted wood, as it is sure to become discoloured.

Peaches and nectarines are frequently cultivated in well-drained pots, and are then usually trained as pyramids, and in some cases as half-standards. The potting must be done very firmly, using turfy loam with which a little mortar rubble has been mixed. The trees are to be top-dressed from time to time with well-decayed manure and turfy loam, and considerable space must be left in the pots for this and the watering.

The following are some of the best peaches and nectarines, arranged in the order of the times of their ripening:—

Peaches.

Early Beatrice	m.	July	Royal George	e.	Aug.
Early Louise	e.	July		b.	Sept.
Hals's Early	b.	Aug.	Bellegarde	b.m.	Sept.
Rivers's Early York	b.m.	Aug.	Belle Baucé	m.	Sept.
A'bec	m.	Aug.	Dymond	m.	Sept.
Crimson Galande	e.	Aug.	Late Admirable	m.e.	Sept.
Crawford's Early	e.	Aug.	Sea Eagle	e.	Sept.
	b.	Sept.	Walburton Admirable	b.	Sept.
Grosse Mignonne	e.	Aug.		b.	Oct.
	b.	Sept.	Salwey	b.	Nov.
Noblesse	e.	Sept.	Princess of Wales	e.	Oct.

Nectarines.

Cardinal (under glass)	e.	July	Pitmaston Orange	e.	Aug.
Lord Napier	b.	Aug.		b.	Sept.
Darwin	m.	Aug.	Violette Hâtive	e.	Aug.
Early Rivers	m.	Aug.		b.	Sept.
Balgowan	e.	Aug.	Victoria (under glass)	b.	Sept.
	b.	Sept.	Pineapple	b.	Sept.
Elruge	e.	Aug.	Stanwick Elruge	b.	Sept.
	b.	Sept.	Humbolt	m.	Sept.
Stanwick (under glass)	m.e.	Sept.			

PEACHAM, HENRY (c. 1576-c. 1643), English writer, was the son of Henry Peacham, curate of North Mimms, Hertfordshire, and author of a book on rhetoric called the *Garden of Rhetoric* (1577). The elder Peacham became in 1597 rector of Leverton, Lincolnshire. The son was educated at Trinity College, Cambridge, where he graduated B.A. in 1594-1595 and M.A. in 1598. He was for some time a schoolmaster at Wymondham, Norfolk, but settled in London in 1612, earning his living as tutor to young men preparing for the universities. His first book was *Graphice* (1606), a treatise on pen and water-colour drawing, which, as *The Gentleman's Exercise*, passed through three editions. The years 1613-1614 he spent abroad, part of the time as tutor to the three young sons of Thomas Howard (1585-1646), earl of Arundel, and partly on his own account. He travelled in Italy, France, Westphalia and the Netherlands. The table of Sir John Ogle, English governor of Utrecht, was, he says, a "little academy," where he met soldiers and scholars of all nationalities. When he returned to London he was accused of libel on the king. Incriminating papers had been discovered in the house of Edmond Peacham, rector of Hinton Saint George, who, on being charged with an attack on the king denied the

authorship, stating that they were written by a namesake, "a divine, a scholar and a traveller." The change was, however, easily rebutted. Peacham had many friends in London, among them Thomas Dowland the musician, Inigo Jones, and Edward Wright the mathematician. In 1622 appeared Peacham's magnum opus, the *Compleat Gentleman*. Enlarged editions appeared in 1626 and 1627. The 1627 edition was reprinted in 1634, and a third, with additional notes on blazonry by Thomas Blount (1617-1679), appeared in 1661. The book is a text-book of manners and polite learning; it includes chapters on cosmography, geometry, poetry, music, antiquities, painting, the lives of the painters, the "art of limming" (Peacham himself was a proficient engraver), and the military art, including the order of "a maine battaille or pitched field in eight severall wayes." The book differs from the *Courtier* of Castiglione, which had been the guide of an earlier generation. Peacham was a Cavalier, even an ardent polemist in the royal cause, but the central point of his book is a more or less Puritan sentiment of duty. In his later years Peacham was reduced to extreme poverty, and is said to have written children's books at a penny each. His last book was published in 1642, and it may be concluded that he died soon afterwards.

His other works include: *Minerva Britanna* (1612), dedicated to Henry, prince of Wales; *The Period of Mourning* (1613), in honour of the same prince; *Thalia's Banquet* (1620), a book of epigrams; *The Art of Living in London* (1642), and *The Worth of a Penny* (1641), &c. There is a nearly complete collection of Peacham's works in the Bodleian, Oxford. Harleian MS. 6855 contains a translation by Peacham of James I.'s *Basiliicon doron* into Latin verse, written in his own hand and ornamented with pen and ink drawings. His *Compleat Gentleman* was edited by G. S. Gordon in 1906 for the Clarendon Press; the *Art of Living* is reprinted in the *Harleian Misc.* ix. *The Worth of a Penny* in *E. Arber's English Garner* (vol. vi. 1883).

PEACOCK, SIR BARNES (1810-1890), English judge, was born in 1810, the son of Lewis Peacock, a solicitor. After practising as a special pleader, he was called to the bar in 1836, and in 1844 obtained great reputation by pointing out the flaw which invalidated the conviction of Daniel O'Connell and his fellow defendants. In 1852 he went to India as legal member of the governor-general's council. He here displayed great activity as a law reformer, but sometimes manifested too little consideration for native susceptibilities. The legislative council was established soon after his arrival, and although no orator, he was so frequent a speaker that legislation enjoining councillors to deliver their speeches sitting was said to have been devised with the sole object of restraining him. As a member of Lord Dalhousie's council he supported the annexation of Oudh, and he stood by Lord Canning all through the Mutiny. In 1859 he became chief justice of the Supreme Court. He returned to England in 1870, and in 1872 was placed upon the judicial committee of the privy council, where his Indian experience rendered him invaluable. He died on the 3rd of December 1890.

PEACOCK, GEORGE (1791-1858), English mathematician, was born at Thornton Hall, Denton, near Darlington, on the 9th of April 1791. He was educated at Richmond, Yorkshire, and entered Trinity College, Cambridge, in 1809. He was second wrangler in 1812 (Sir J. F. W. Herschel being senior), was elected fellow of his college in 1814, became assistant tutor in 1815 and full tutor in 1823. While still an undergraduate he formed a league with John Herschel and Charles Babbage, to conduct the famous struggle of "d-ism versus dot-age," which ended in the introduction into Cambridge of the continental notation in the infinitesimal calculus to the exclusion of the fluxional notation of Sir Isaac Newton. This was an important reform, not so much on account of the mere change of notation (for mathematicians follow J. L. Lagrange in using both these notations), but because it signified the opening to the mathematicians of Cambridge of the vast storehouse of continental discoveries. The analytical society thus formed in 1813 published various memoirs, and translated S. F. Lacroix's *Differential Calculus* in 1816. Peacock powerfully aided the movement by publishing in 1820 *A Collection of Examples of the Application of the Differential and Integral Calculus*. In 1841 he published a pamphlet on the

university statutes, in which he indicated the necessity for reform; and in 1850 and 1855 he was a member of the commission of inquiry relative to the university of Cambridge. In 1837 he was appointed Lowndean professor of astronomy. In 1839 he took the degree of D.D., and the same year was appointed by Lord Melbourne to the deanery of Ely. Peacock threw himself with characteristic ardour into the duties of this new position. He improved the sanitation of Ely, published in 1840 *Observations on Plans for Cathedral Reform*, and carried out extensive works of restoration in his own cathedral. He was twice prolocutor of the lower house of convocation for the province of Canterbury. He was also a prime mover in the establishment of the Cambridge Astronomical Observatory, and in the founding of the Cambridge Philosophical Society. He was a fellow of the Royal, Royal Astronomical, Geological and other scientific societies. In 1838, and again in 1843, he was one of the commissioners for standards of weights and measures; and he also furnished valuable information to the commissioners on decimal coinage. He died on the 8th of November 1868.

Peacock's original contributions to mathematical science were concerned chiefly with the philosophy of its first principles. He did good service in systematizing the operational laws of algebra, and in throwing light upon the nature and use of imaginaries. He published, first in 1830, and then in an enlarged form in 1842, a *Treatise on Algebra*, in which he applied his philosophical ideas concerning algebraical analysis to the elucidation of its elements. A second great service was the publication in the *British Association Reports* for 1833 of his "Report on the Recent Progress and Present State of certain branches of Analysis." Modern mathematicians may find on reading this brilliant summary a good many dicta which they will call in question, but, whatever its defects may be, Peacock's report remains a work of permanent value. In 1895 he published a memoir of Thomas Young, and about the same time there appeared Young's collected works in three volumes, for the first two of which Peacock was responsible.

PEACOCK, THOMAS LOVE (1785-1866), English novelist and poet, was born at Weymouth on the 18th of October 1785. He was the only son of a London glass merchant, who died soon after the child's birth. Young Peacock was educated at a private school at Englefield Green, and after a brief experience of business determined to devote himself to literature, while living with his mother (daughter of Thomas Love, a naval man) on their private means. His first books were poetical, *The Monks of St Mark* (1804), *Palmyra* (1806), *The Genius of the Thames* (1810), *The Philosophy of Melancholy* (1812)—works of no great merit. He also made several dramatic attempts, which were never acted. He served for a short time as secretary to Sir Home Popham at Flushing, and paid several visits to Wales. In 1812 he became acquainted with Shelley. In 1815 he evinced his peculiar power by writing his novel *Headlong Hall*. It was published in 1816, and *Melincourt* followed in the ensuing year. During 1817 he lived at Great Marlow, enjoying the almost daily society of Shelley, and writing *Nightmare Abbey* and *Rhododaphne*, by far the best of his long poems. In 1819 he was appointed assistant examiner at the India House. Peacock's nomination appears to have been due to the influence of his old schoolfellow Peter Auber, secretary to the East India Company, and the papers he prepared as tests of his ability were returned with the comment, "Nothing superfluous and nothing wanting." This was characteristic of the whole of his intellectual work; and equally characteristic of the man was his marriage about this time to Jane Griffith, to whom he proposed by letter, not having seen her for eight years. They had four children, only one of whom, a son, survived his father; one daughter was the first wife of George Meredith. His novel *Maid Marian* appeared in 1822, *The Misfortunes of Elphin* in 1820, and *Crotchet Castle* in 1831; and he would probably have written more but for the death in 1833 of his mother. He also contributed to the *Westminster Review* and the *Examiner*. His services to the East India Company, outside the usual official routine, were considerable. He defended it successfully against the attacks of James Silk

Buckingham and the Liverpool salt interest, and made the subject of steam navigation to India peculiarly his own. He represented the company before the various parliamentary committees on this question; and in 1839 and 1840 superintended the construction of iron steamers, which not only made the voyage round the Cape successfully, but proved very useful in the Chinese War. He also drew up the instructions for the Euphrates expedition of 1835, subsequently pronounced by its commander, General F. R. Chesney, to be models of sagacity. In 1836 he succeeded James Mill as chief examiner, and in 1856 he retired upon a pension. During his later years he contributed several papers to *Fraser's Magazine*, including reminiscences of Shelley, whose executor he was. He also wrote in the same magazine his last novel, *Cryll Grange* (1860), inferior to his earlier writings in humour and vigour, but still a surprising effort for a man of his age. He died on the 23rd of January 1866 at Lower Halliford, near Chertsey, where, so far as his London occupations would allow him, he had resided for more than forty years.

Peacock's position in English literature is unique. There was nothing like his type of novel before his time; though there might have been if it had occurred to Swift to invent a story as a vehicle for the dialogue of his *Polite Conversation*. Peacock speaks as well in his own person as through his puppets; and his pithy wit and sense, combined with remarkable grace and accuracy of natural description, atone for the primitive simplicity of plot and character. Of his seven fictions, *Nightmare Abbey* and *Crotchet Castle* are perhaps on the whole the best, the former displaying the most *vis comica* of situation, the latter the fullest maturity of intellectual power and the most skilful grouping of the motley crowd of "perfectibilians, deteriorationists, statuquo-ites, phrenologists, transcendentalists, political economists, theorists in all sciences, projectors in all arts, morbid visionaries, romantic enthusiasts, lovers of music, lovers of the picturesque and lovers of good dinners," who constitute the dramatic personae of the Peacockian novel. *Maid Marian* and *The Misfortunes of Elphin* are hardly less entertaining. Both contain descriptive passages of extraordinary beauty. *Melincourt* is a comparative failure, the excellent idea of an orang-outang mimicking humanity being insufficient as the sole groundwork of a novel. *Headlong Hall*, though more than foreshadowing the author's subsequent excellence, is marred by a certain bookish awkwardness characteristic of the recluse student, which reappears in *Cryll Grange* as the pedantry of an old-fashioned scholar, whose likes and dislikes have become inveterate and whose sceptical liberalism, always rather inspired by hatred of cant than enthusiasm for progress, has petrified into only too earnest conservatism. The book's quaint resolute paganism, however, is very refreshing in an age eaten up with introspection; it is the kindest of Peacock's writings, and contains the most beautiful of his poems, "Years Ago," the reminiscence of an early attachment. In general the ballads and songs interspersed through his tales are models of exact and melodious diction, and instinct with true feeling. His more ambitious poems are worth little, except *Rhododaphne*, attractive as a story and perfect as a composition, but destitute of genuine poetical inspiration. His critical and miscellaneous writings are always interesting, especially the restorations of lost classical plays in the *Horae dramaticae*, but the only one of great mark is the witty and crushing exposure in the *Westminster Review* of Thomas Moore's ignorance of the manners and belief he has ventured to portray in his *Epicurean*. Peacock resented the misrepresentation of his favourite sect, the good and ill of whose tenets were fairly represented in his own person. Somewhat sluggish and self-indulgent, incapable of enthusiasm or self-sacrifice, he yet possessed a deep undemonstrative kindness of nature; he could not bear to see anyone near him unhappy or uncomfortable; and his sympathy, no less than his genial humour, gained him the attachment of children, dependants, and friends. In official life he was upright and conscientious; his judgment was shrewd and robust. What Shelley justly termed "the lightness, strength and chastity" of his diction secures him an honourable rank among those English writers whose claims to remembrance depend not only upon matter but upon style.

Peacock's works were collected, though not completely, and published in three volumes in 1875, at the expense of his friend and former protégé, Sir Henry Cole, with an excellent memoir by his granddaughter Mrs. Clarke, and a critical essay by Lord Houghton. His prose works were collected by Richard Garnett in ten volumes (1891). Separate novels are included in "Macmillan's Illustrated Standard Novels," with introductions by Mr. Saintsbury. For an interesting personal notice, see *A Peal's Sketch Book*, by R. W. Buchanan (1884).

PEACOCK (Lat. *Pavo*, O. Eng. *Pawe*, Du. *pauwro*, Ger. *Pfau*, Fr. *Paon*), the bird so well known from the splendid plumage of the male, and as the proverbial personification of pride. It is a native of the Indian peninsula and Ceylon, in some parts of which it is very abundant. Setting aside its importation to Palestine by Solomon (1 Kings x. 22; 2 Chron. ix. 21), its assignment in classical mythology as the favourite bird of Hera testifies to the early acquaintance the Greeks must have had with it; but, though it is mentioned by Aristophanes and other older writers, their knowledge of it was probably very slight until after the conquests of Alexander. Throughout all succeeding time, however, it has never very freely rendered itself to domestication, and, though in earlier days highly esteemed for the table,¹ it is no longer considered the delicacy it was once thought; the young of the wild birds are, however, still esteemed in the East.



Japan or "black-shouldered" Peafowls.

As in most cases of domestic animals, pied or white varieties of the ordinary peacock, *Pavo cristatus*, are not infrequently to be seen, and they are valued as curiosities. Greater interest, however, attends what is known as the Japanese or Japan peacock, a form which has received the name of *P. nigripennis*, as though it were a distinct species. In this form the cock, besides other less conspicuous differences, has all the upper wing-coverts of a deep lustrous blue instead of being mottled with brown and white, while the hen is of a more or less grizzled-white. It "breeds true"; but occasionally a presumably pure stock of birds of the usual coloration throws out one or more having the Japan plumage. It is to be observed that the male has in the coloration of the parts mentioned no little resemblance to that of the second indubitably good species, the *P. muticus* (or *P. spicifer* of some writers) of Burma and Java, though the character of the latter's crest—the feathers of which are barbed along their whole length instead of at the tip only—and its

¹ Classical authors contain many allusions to its high appreciation at the most sumptuous banquets; and medieval bills of fare on state occasions nearly always include it. In the days of chivalry one of the most solemn oaths was taken "on the peacock," which seems to have been served up garnished with its gaudy plumage.

golden-green neck and breast furnish a ready means of distinction. Sir R. Heron was confident that the Japan breed had arisen in England within his memory,² and C. Darwin (*Animals and Plants under Domestication*, i. 290-292) was inclined to believe it only a variety; but its abrupt appearance, which rests on indisputable evidence, is most suggestive in the light that it may one day throw on the question of evolution as exhibited in the origin of "species." It should be stated that the Japan bird is not known to exist anywhere as a wild race, though apparently kept in Japan. The accompanying illustration is copied from a plate drawn by J. Wolf, given in D. G. Elliot's *Monograph of the Phasianidae*.

The peafowls belong to the group *Gallinae*, from the normal members of which they do not materially differ in structure; and, though by some systematists they are raised to the rank of a family, *Pavonidae*, most are content to regard them as a sub-family of *Phasianidae* (PHEASANT, *q.v.*). Akin to the genus *Pavo* is *Polyplectrum*, of which the males are armed with two or more spurs on each leg, and near them is generally placed the genus *Argusianus*, containing the argus-pheasants, remarkable for their wonderfully ocellated plumage, and the extraordinary length of the secondary quills of their wings, as well as of the tail-feathers. It must always be remembered that the so-called "tail" of the peacock is formed not by the rectrices or true tail-feathers, but by the singular development of the tail-coverts. (A. N.)

PEAK, THE, a high table-land in the north of Derbyshire, England, included in the Pennine range of hills. The name, however, is extended, without definite limits, to cover the whole of the hilly district north of Buxton. The table-land reaches an elevation of 2088 ft. in Kinder Scout. The geological formation is millstone-grit, and the underlying beds are not domed, but cup-shaped, dipping inward from the flanks of the mass. The summit is a peaty moorland, through which masses of rock project at intervals. The name of this high plateau has from the 17th century been identified with "peak," the pointed or conical top of a mountain, but the very early references to the district and certain places in it show clearly, as the *New English Dictionary* points out, that this connexion is unwarranted. The name appears in the *Old English Chronicle* (924) as *Peacowd*, of the district governed from the castle of Peveril of the Peak (see DERBYSHIRE), and also in the name of the cavern under the hill at Castleton, *Péac's Arse*. *Péac*, it has been suggested, is the name of a local deity or demon, and possibly may be identified with Puck. For the etymology of "peak," point, &c., and its variants or related words, "pick" and "pike," see **PIKE**.

PEALE, CHARLES WILLSON (1741-1826), American portrait painter, celebrated especially for his portraits of Washington, was born in Queen Anne county, Maryland, on the 16th of April 1741. During his infancy the family removed to Chestertown, Kent county, Maryland, and after the death of his father (a country schoolmaster) in 1750 they removed to Annapolis. Here, at the age of 13, he was apprenticed to a saddler. About 1764 he began seriously to study art. He got some assistance from Gustavus Hesselius, a Swedish portrait painter then living near Annapolis, and from John Singleton Copley in Boston; and in 1767-1770 he studied under Benjamin West in London. In 1770 he opened a studio in Philadelphia, and met with immediate success. In 1772, at Mount Vernon, Peale painted a three-quarters-length study of Washington (the earliest known portrait of him), in the uniform of a colonel of Virginia militia. This canvas is now in the Lee Memorial Chapel of Washington and Lee University. He painted various other portraits of Washington; probably the best known in a full-length, which was made in 1778, and of which Peale made many copies. This portrait had been ordered by the Continental Congress, which, however, made no appropriation for it, and eventually it was bought for a private collection in Philadelphia. Peale painted two miniatures of Mrs. Washington (1772 and 1777), and portraits of many of the famous men of the time, a number of which are in Independence Hall, Philadelphia. His portraits of Washington do not appeal so strongly to Americans as do those of Gilbert Stuart, but his admitted skill as a draughtsman gives to all of his work considerable historical value. Peale removed to

² A. Newton himself regarded this as probably incorrect.

Philadelphia in 1777, and served as a member of the committee of public safety; he aided in raising a militia company, became a lieutenant and afterwards a captain, and took part in the battles of Trenton, Princeton and Germantown. In 1779-1780 he was a member of the Pennsylvania assembly, where he voted for the abolition of slavery—he freed his own slaves whom he had brought from Maryland. In 1801 he undertook, largely at his own expense, the excavation of the skeletons of two mastodons in Ulster and Orange counties, New York, and in 1802 he established at Philadelphia Peale's Museum. He was one of the founders, in 1805, of the Pennsylvania Academy of the Fine Arts at Philadelphia. At the age of eighty-one Peale painted a large canvas, "Christ Healing the Sick at Bethesda," and at eighty-three a full-length portrait of himself, now in the Academy of the Fine Arts. He died at his country home, near Germantown, Pennsylvania, on the 22nd of February 1826.

His brother, JAMES PEALE (1749-1831), also an artist, painted two portraits of Washington (one now the property of the New York Historical Society, and the other in Independence Hall, Philadelphia), besides landscapes and historical compositions.

PEALE, REMBRANDT (1778-1860), American artist, was born in Bucks county, Pennsylvania, on the 22nd of February 1778, the son of Charles Willson Peale (q.v.). He studied under his father, under Benjamin West in London (1802-1803), and in Paris in 1807 and 1809. As early as 1795 he had begun from life a portrait of Washington. Of this he made many replicas, the latest in 1823, purchased by the United States government in 1832, and now in the Capitol of Washington. Peale was one of the first of American lithographers. He was an excellent draughtsman, but in colour his work cannot rank with his father's. In 1843 he devised for the Philadelphia public schools a system of teaching drawing and penmanship. His portraits include those of President Jefferson, Mrs Madison, Commodore Perry, Decatur, and Bainbridge, Houdon, the sculptor, General Armstrong, and an equestrian portrait of General Washington, now in Independence Hall, Philadelphia. His "Court of Death" (1820) is in the Detroit Art Gallery. In 1825 Peale succeeded John Trumbull as president of the American Academy of Fine Arts (founded in 1802 as the New York Academy of Fine Arts), and he was one of the original members of the National Academy of Design. He wrote several books, among them *Notes on Italy* (1831), *Reminiscences of Art and Artists* (1845). He died in Philadelphia on the 3rd of October 1860.

A brother, RAPHAËLLE PEALE (1774-1825), was one of the earliest of American still-life painters; and another brother, TITIAN RAMSEY PEALE (1800-1885), made numerous drawings, some of them in water-colour, in illustration of animal life.

See "Rembrandt Peale," partly autobiographical, in C. E. Lester's *The Artists of America* (New York, 1846).

PEAR (*Pyrus communis*), a member of the natural order Rosaceae, belonging to the same genus as the apple (*P. malus*), which it resembles in floral structure. In both cases the so-called fruit is composed of the receptacle or upper end of the flower-stalk (the so-called calyx tube) greatly dilated, and enclosing within its cellular flesh the five cartilaginous carpels which constitute the "core" and are really the true fruit. From the upper rim of the receptacle are given off the five sepals, the five petals, and the very numerous stamens. The form of the pear and of the apple respectively, although usually characteristic enough, is not by itself sufficient to distinguish them, for there are pears which cannot by form alone be distinguished from apples, and apples which cannot by superficial appearance be recognized from pears. The main distinction is the occurrence in the tissue of the fruit, or beneath the rind, of clusters of cells filled with hard woody deposit in the case of the pear, constituting the "grit," while in the apple no such formation of woody cells takes place. The appearance of the tree—the bark, the foliage, the flowers—is, however, usually quite characteristic in the two species. Cultivated pears, whose number is enormous, are without doubt derived from one or two wild species widely distributed throughout Europe and western Asia, and sometimes forming part of the natural vegetation of the forests. In England,

where the pear is sometimes considered wild, there is always the doubt that it may not really be so, but the produce of some seed of a cultivated tree deposited by birds or otherwise, which has degenerated into the wild spine-bearing tree known as *Pyrus communis*.

The cultivation of the pear extends to the remotest antiquity. Traces of it have been found in the Swiss lake-dwellings; it is mentioned in the oldest Greek writings, and was cultivated by the Romans. The word "pear" or its equivalent occurs in all the Celtic languages, while in Slavonic and other dialects different appellations, but still referring to the same thing, are found—a diversity and multiplicity of nomenclature which led Alphonse de Candolle to infer a very ancient cultivation of the tree from the shores of the Caspian to those of the Atlantic. A certain race of pears, with white down on the under surface of their leaves, is supposed to have originated from *P. nivalis*, and their fruit is chiefly used in France in the manufacture of Perry (see CMEZ). Other small-fruited pears, distinguished by their precocity and apple-like fruit, may be referred to *P. cordata*, a species found wild in western France, and in Devonshire and Cornwall.

Karl Koch considered that cultivated pears were the descendants of three species—*P. persica* (from which the bergamots have descended), *P. elaeagnifolia* and *P. sinensis*. J. Decaisne, who made the subject one of critical study for a number of years, and not only investigated the wild forms, but carefully studied the peculiarities of the numerous varieties cultivated in the Jardin des Plantes at Paris, refers all cultivated pears to one species, the individuals of which have in course of time diverged in various directions, so as to form now six races: (1) the Celtic, including *P. cordata*; (2) the Germanic, including *P. communis*, *P. achrata*, and *P. piraster*; (3) the Hellenic, including *P. parviflora*, *P. siraica* and others; (4) the Pontic, including *P. elaeagnifolia*; (5) the Indian, comprising *P. Paschae*; and (6) the Mongolic, represented by *P. sinensis*. With reference to the Celtic race, *P. cordata*, it is interesting to note its connexion with Arthurian legend and the Isle of Avalon or Isle of Apples. An island in Loch Awe has a Celtic legend containing the principal features of Arthurian story; but in this case the word is "berries" instead of "apples." Dr. Phénix visited Armorica (Brittany) with a view of investigating these matters, and brought thence fruits of a small berry-like pear, which were identified with the *Pyrus cordata* of western France.

Cultivation.—The pear may be readily raised by sowing the seeds of ordinary cultivated or of wilding kinds, these forming what are known as free or pear stocks, on which the choicer varieties are grafted for increase. For new varieties the flowers should be fertilized with a view to combine, in the seedlings which result from the union, the desirable qualities of the parents. The dwarf and pyramid trees, more usually planted in gardens, are obtained by grafting on the quince stock, the Portugal quince being the best; but this stock, from its surface-rooting habit, is most suitable for soils of a cold damp nature. The pear-stock, having an inclination to send its roots down deeper into the soil, is the best for light dry soils, as the plants are not then so likely to suffer in dry seasons. Some of the finer pears do not unite readily with the quince, and in this case double working is resorted to; that is to say, a vigorous-growing pear is first grafted on the quince, and then the choicer pear is grafted on the pear introduced as its foster parent.

In selecting young pear trees for walls or espaliers, some persons prefer plants one year old from the graft, but trees two or three years trained are equally good. The trees should be planted immediately before or after the fall of the leaf. The wall trees require to be planted from 25 to 30 ft. apart when on free stocks, and from 15 to 20 ft. when dwarfed. Where the trees are trained as pyramids or columns they may stand 8 or 10 ft. apart, but standards in orchards should be allowed at least 30 ft., and dwarf bush trees half that distance.

In the formation of the trees the same plan may be adopted as in the case of the apple. For the pear orchard a warm situation is very desirable, with a soil deep, substantial, and thoroughly drained. Any good free loam is suitable, but a calcareous loam is the best. Pear trees worked on the quince should have the stock covered up to its junction with the graft. This is effected by raising up a small mound of rich compost around it, a contrivance which induces the graft to emit roots into the surface soil.

and also keeps the stock from becoming hard or bark-bound. The fruit of the pear is produced on spurs, which appear on shoots more than one year old. The mode most commonly adopted of training wall pear-trees is the horizontal. For the slender twiggy sorts the fan form is to be preferred, while for strong growers the half-fan or the horizontal is more suitable. In the latter form old trees, the summer pruning of which has been neglected, are apt to acquire an undue projection from the wall and become scraggy, to avoid which a portion of the old spurs should be cut out annually.

The summer pruning of established wall or espalier-rail trees consists chiefly in the timely displacing, shortening back, or rubbing off of the superfluous shoots, so that the winter pruning, in horizontal training, is little more than adjusting the leading shoots and thinning out the spurs, which should be kept close to the wall and allowed to retain but two or at most three buds. In fan-training the subordinate branches must be regulated, the spurs thinned out, and the young laterals finally established in their places. When horizontal trees have fallen into disorder, the branches may be cut back to within 9 in. of the vertical stem and branch, and trained in afresh, or they may be grafted with other sorts, if a variety of kinds is wanted.

Summer and autumn pears should be gathered before they are fully ripe, otherwise they will not in general keep more than a few days. The Jargonelle should be allowed to remain on the tree and be pulled daily as wanted, the fruit from standard trees thus succeeding the produce of the wall trees. In the case of the Crassane the crop should be gathered at three different times, the first a fortnight or more before it is ripe, the second a week or ten days after that, and the third when fully ripe. The first gathering will come into eating latest, and thus the season of the fruit may be considerably prolonged. It is evident that the same method may be followed with other sorts which continue only a short time in a mature state.

Diseases.—The pear is subject to several diseases caused by fungi. *Gymnosporangium sabiniae*, one of the rusts (Uredineae) passes one stage of its life-history on living pear leaves, forming large raised spots or patches which are at first yellow but soon become red and are visible on both faces; on the lower face of each patch is a group of cluster-cups or acidia containing spores which escape when ripe. This stage in the life-history was formerly regarded as a distinct fungus with the name *Roestelia cancellata*; it is now known, however, that the spores germinate on young juniper leaves, in which they give rise to this other stage in the plant's history known as *Gymnosporangium*. The gelatinous, generally reddish-brown masses of spores—the teliospores—formed on the juniper in the spring germinate and form minute spores—*sporidia*—which give rise to the acidium stage on the pear. Diseased pear leaves should be picked off and destroyed before the spores are scattered and the various species of juniper on which the alternate stage is developed should not be allowed near the pear trees.

Pear scab is caused by a parasitic fungus, *Fusicladium pyramum*, very closely allied and perhaps merely a form of the apple scab fungus, *F. dendriticum*. As in the case of the apple disease it forms large irregular blackish blotches on the fruit and leaves, the injury being often very severe especially in a cool, damp season. The fungus mycelium grows between the cuticle and the epidermis, the former being ultimately ruptured by numerous short branches bearing spores (conidia) by means of which the disease is spread. As a preventive repeated spraying with dilute Bordeaux mixture is recommended, during the flowering season and early development of the fruit. Similar spraying is recommended for pear-leaf blister caused by *Taphrina bullata*, which forms swollen areas on the leaves. Pear trees may also be attacked by a great variety of insect pests. Thus the younger branches are often injured by the pearl oyster scale (*Aspidiotus ostryaeformis*), which

(From a specimen in the British Museum.)

Pear Scab (*Fusicladium pyramum*).

1, Leaf showing diseased areas.

2, Section of leaf surface showing the spores or conidia, c, borne on long stalks (conidiophores)

injured by the pearl oyster scale (*Aspidiotus ostryaeformis*), which

may be removed by washing in winter with soft soap and hot water. A number of larvae of *Lepidoptera* feed on the leaves—the remedy is to capture the mature insects when possible. The winter moth (*Cheimatobia brumata*) must be kept in check by putting greasy bands round the trunks from October till December or January, to catch the wingless females that crawl up and deposit their eggs in the cracks and crevices in the bark. The caterpillars of the leopard moth (*Zeuzera pyrina*) and of the goat moth (*Cossus ligniperda*) sometimes bore their way into the trunks and destroy the sap channels. If badly bored, the trees are useless; but in



Pear-leaf Cluster-cups (*Gymnosporangium sabiniae*).

1, Leaf showing groups of cups or acidia. 2, Early stage of disease. 3, Cups.

the early stages if the entrance of the caterpillars has been detected, a wire should be pushed into the hole. One of the worst pests of pear trees is the pear midge, known as *Diplosis pyrina* or *Cecidomyia nigra*, the females of which lay their eggs in the flower-buds before they open. The yellow maggots devour the seeds and thus ruin the crop. When deformed fruits are noticed they should be picked off and burned immediately. Species of aphides may be removed by tobacco infusion, soapsuds or other solutions. A gall mite (*Phytoptus pyri*) sometimes severely injures the leaves, on which it forms blisters—the best remedy is to cut off and burn the diseased leaves.

The Alligator or Avocado Pear is *Persea gratissima*, a member of the natural order Lauraceae, and a native of the West Indies and other parts of tropical America. It is a tree of 25 to 30 ft. high and bears large pear-shaped fruits, green or deep purple in colour, with a firm yellowish-green marrow-like pulp surrounding a large seed. The pulp is much esteemed in the West Indies and is eaten as a salad, usually with the addition of pepper, salt and vinegar. The pulp contains much oil, which is used for lighting and soap-making, and the seeds yield a deep indelible black stain which is used for marking linen.

Prickly pear is the popular name for species of *Opuntia* (see CACTUS).

The name wooden pear is applied to the fruits of *Xylometum* (nat. ord. Proteaceae), an Australian genus of trees with very thick, woody, inversely pear-shaped fruits which split into two parts when ripe.

PEARCE, CHARLES SPRAGUE (1851—), American artist, was born at Boston, Massachusetts, on the 13th of October 1851. In 1873 he became a pupil of Léon Bonnat in Paris, and after 1885 he lived in Paris and at Auvers-sur-Oise. He painted Egyptian and Algerian scenes, French peasants, and portraits, and also decorative work, notably for the Congressional Library at Washington. He received medals at the Paris Salon and elsewhere, and was decorated with the Legion of Honour, the order of Leopold, Belgium, the order of the Red Eagle, Prussia, and the order of Dannebrog, Denmark. Among his best known paintings are "The Decapitation of St John the Baptist" (1881), in the Art Institute of Chicago; "Prayer" (1884), owned by the Massachusetts Charitable Mechanic Association; "The Return of the Flock," in the Bohemian Club, San Francisco; and "Meditation," in the New York Metropolitan Museum.

PEARL. Pearls are calcareous concretions of peculiar lustre, produced by certain molluscs, and valued as objects of personal ornament. The experience of pearl-fishers shows that those shells which are irregular in shape and stunted in growth, or

which bear encrustations, or are honeycombed by boring parasites, are those most likely to yield pearls.

The substance of a pearl is essentially the same as that which lines the interior of many shells and is known as "mother-of-pearl." Sir D. Brewster first showed that the iridescence of this substance was an optical phenomenon due to the interference of rays of light reflected from microscopic corrugations of the surface—an effect which may be imitated by artificial striations on a suitable medium. When the inner laminated portion of a nacreous shell is digested in acid the calcareous layers are dissolved away, leaving a very delicate membranous pellicle, which, as shown by Dr Carpenter, may retain the iridescence as long as it is undisturbed, but which loses it when pressed or stretched.

It is obvious that if a pearl presents a perfectly spherical form it must have remained loose in the substance of the muscles or other soft tissues of the mollusc. Frequently, however, the pearl becomes cemented to the interior of the shell, the point of attachment thus interfering with its symmetry. In this position it may receive successive nacreous deposits, which ultimately form a pearl of hemispherical shape, so that when cut from the shell it may be flat on one side and convex on the other, forming what jewelers know as a "perle bouton." In the course of growth the pearl may become involved in the general deposit of mother-of-pearl, and be ultimately buried in the substance of the shell. It has thus happened that fine pearls have occasionally been unexpectedly brought to light in cutting up mother-of-pearl in the workshop.

When a pearl oyster is attacked by a boring parasite the mollusc protects itself by depositing nacreous matter at the point of invasion, thus forming a hollow body of irregular shape known as a "blister pearl." Hollow warty pearl is sometimes termed in trade "coq de perle." Solid pearls of irregular form are often produced by deposition on rough objects, such as small fragments of wood, and these, and in fact all irregular-shaped pearls, are termed "perles baroques," or "barok pearls." It appears that the Romans in the period of the Decline restricted the name *ussio* to the globular pearl, and termed the baroque *margaritum*. It was fashionable in the 16th and 17th centuries to mount curiously shaped baroques in gold and enamel so as to form ornamental objects of grotesque character. A valuable collection of such mounted pearls by Dinglinger is preserved in the Green vaults at Dresden.

A pearl of the first water should possess, in jewelers' language, a perfect "skin" and a fine "orient"; that is to say, it must be of delicate texture, free from speck or flaw, and of clear almost translucent white colour, with a subdued iridescent sheen. It should also be perfectly spherical, or, if not, of a symmetrical pear-shape. On removing the outer layer of a pearl the subjacent surface is generally dull, like a dead fish-eye, but it occasionally happens that a poor pearl encloses a "lively kernel," and may therefore be improved by careful peeling. The most perfect pearl in existence is said to be one, known as "La Pellegrina," in the museum of Zosima in Moscow; it is a perfectly globular Indian pearl of singular beauty, weighing 28 carats. The largest known pearl is one of irregular shape in the Beresford Hope collection at the Victoria and Albert Museum. This magnificent pearl weighs 3 oz., has a circumference of $4\frac{1}{2}$ in., and is surmounted by an enamelled and jewelled gold crown, forming a pendant of great value.

Pearl Fisheries.—The ancients obtained their pearls chiefly from India and the Persian Gulf, but at the present time they are also procured from the Sulu seas, the coast of Australia, the shores of Central America and some of the South Pacific Islands. The ancient fisheries of Ceylon (Taprobane) are situated in the Gulf of Manaar, the fishing-banks lying from 6 to 8 m. off the western shore, a little to the south of the Isle of Manaar. The Tinnevely fishery is on the Madras side of the strait, near Tuticorin. These Indian fishing-grounds are under the control of government inspectors, who regulate the fisheries. The oysters yield the best pearls at about four years of age. Fishing generally commences in the second week in March, and lasts for from four to six weeks, according to the season. The boats are grouped in fleets

of from sixty to seventy, and start usually at midnight so as to reach the oyster-banks at sunrise. Each boat generally carries ten divers. On reaching the bank a signal-gun is fired, and diving commences. A stone weighing about 40 lb is attached to the cord by which the diver is let down. The divers work in pairs, one man diving while the other watches the signal-cord, drawing up the sink-stone first, then hauling up the baskets of oysters, and finally raising the diver himself. On an average the divers remain under water from fifty to eighty seconds, though exceptional instances are cited of men remaining below for as long as six minutes. After resting for a minute or two at the surface, the diver descends again; and so on, until exhausted, when he comes on board and watches the rope, while his comrade relieves him as diver. The native descends naked, carrying only a girdle for the support of the basket in which he places the pearl oysters. In his submarine work the diver makes skilful use of his toes. To arm himself against the attacks of the sharks and other fishes which infest the Indian waters he carries spikes of iron-wood; and the genuine Indian diver never descends without the incantations of shark-charmers, one of whom accompanies the boat while others remain on shore. As a rule the diver is a short-lived man.

The diving continues from sunrise to about noon, when a gun is fired. On the arrival of the fleet at shore the divers carry their oysters to a shed, where they are made up into four heaps, one of which is taken by the diver. The oysters are then sold by auction in lots of 1000 each. The pearls, after removal from the dead oysters, are "classified" by passing through a number of small brass colanders, known as "baskets," the holes in the successive vessels being smaller and smaller. Having been sized in this way, they are sorted as to colour, weighed and valued.

Since the days of the Macedonians pearl-fishing has been carried on in the Persian Gulf. It is said that the oyster-beds extend along the entire Arabian coast of the gulf, but the most important are on sandbanks off the islands of Bahrein. The chief centre of the trade is the port of Lingah. Most of the products of this fishery are known as "Bombay pearls," from the fact that many of the best are sold there. The shells usually present a dark colour about the edges, like that of "smoked pearl." The yellow-tinted pearls are sent chiefly to Bombay, while the whitest go to Bagdad. Very small pearls, much below a pea in size, are generally known as "seed-pearls," and these are valued in India and China as constituents of certain electuaries, while occasionally they are calcined for *chessam*, or lime, used with betel as a masticatory. There is a small pearl-fishery near Karachi on the coast of Bombay.

From the time of the Ptolemies pearl-fishing has been prosecuted along the coast of the Red Sea, especially in the neighbourhood of Jiddah and Koseir. This fishery is now insignificant, but the Arabs still obtain from this district a quantity of mother-of-pearl shells, which are shipped from Alexandria, and come into the market as "Egyptians."

Very fine pearls are obtained from the Sulu Archipelago, on the north-east of Borneo. The mother-of-pearl shells from the Sulu seas are characterized by a yellow colour on the border and back, which unfits them for many ornamental purposes. Pearl oysters are also abundant in the seas around the Aru Islands to the south-west of New Guinea. From Labuan a good many pearl-shells are occasionally sent to Singapore. They are also obtained from the neighbourhood of Timor, and from New Caledonia. The pearl oyster occurs throughout the Pacific, mostly in the clear water of the lagoons within the atolls, though fine shells are also found in deep water outside the coral reefs. The Polynesian divers do not employ sink-stones, and the women are said to be more skilful than the men. They anoint their bodies with oil before diving. Fine pearl-shells are obtained from Navigators' Islands, the Society Islands, the Low Archipelago or Paumotu Isles and the Gambier Islands. Many of the Gambier pearls present a bronzy tint.

Pearl-fishing is actively prosecuted along the western coast of Central America, especially in the Gulf of California, and to a less extent around the Pearl Islands in the Bay of Panama. The

fishing-grounds are in water about 40 ft. deep, and the season lasts for four months. An ordinary fishing-party expects to obtain about three tons of shells per day, and it is estimated that one shell in a thousand contains a pearl. The pearls are shipped in barrels from San Francisco and Panama. Some pearls of rare beauty have been obtained from the Bay of Mulege, near Los Coyetes, in the gulf of California; and in 1882 a pearl of 75 carats, the largest on record from this district, was found near La Paz in California. The coast of Guayaquil also yields pearls. Columbus found that pearl-fishing was carried on in his time in the Gulf of Mexico, and pearls are still obtained from the Caribbean Sea. In the West Indies the best pearls are obtained from St Thomas and from the island of Margarita, off the coast of Venezuela. From Margarita Philip II. of Spain is said to have obtained in 1579 a famous pearl of 250 carats.

Of late years good pearls have been found in Shark's Bay, on the coast of West Australia, especially in an inlet termed Useless Harbour. Mother-of-pearl shells are also fished at many other points along the western coast, between the 15th and 25th parallels of south latitude. An important pearl-fishery is also established in Torres Strait and on the coast of Queensland. The shells occur in water from four to six fathoms deep, and the divers are generally Malays and Papuans, though sometimes native Australians. On the western coast of Australia the pearl-shells are obtained by dredging rather than by diving. Pearl-shells have also been found at Port Darwin and in Oakley Creek, New Zealand.

River pearls are produced by the species of *Unio* and *Anodonta*, especially by *Unio margaritifera*. These species belong to the family Unionidae, order Lamellibranchia. They inhabit the mountain-streams of temperate climates in the northern hemisphere—especially in Scotland, Wales, Ireland, Saxony, Bohemia, Bavaria, Lapland and Canada. The pearls of Britain are mentioned by Tacitus and by Pliny, and a breastplate studded with British pearls was dedicated by Julius Caesar to Venus Genetrix. As early as 1355 Scotch pearls are referred to in a statute of the goldsmiths of Paris; and in the reign of Charles II. the Scotch pearl trade was sufficiently important to attract the attention of parliament. The Scotch pearl-fishery, after having declined for years, was revived in 1860 by a German named Moritz Unger, who visited Scotland and bought up all the pearls he could find in the hands of the peasantry, thus leading to an eager search for more pearls the following season. It is estimated that in 1865 the produce of the season's fishing in the Scotch rivers was worth at least £12,000. This yield, however, was not maintained, and at the present time only a few pearls are obtained at irregular intervals by an occasional fisherman.

The principal rivers in Scotland which have yielded pearls are the Spey, the Tay and the South Esk; and to a less extent the Doon, the Dee, the Don, the Ythan, the Teith, the Forth and many other streams. In North Wales the Conway was at one time celebrated for its pearls; and it is related that Sir Richard Wynn, chamberlain to the queen of Charles II., presented her with a Conway pearl which is believed to occupy a place in the British crown. In Ireland the rivers of Donegal, Tyrone and Wexford have yielded pearls. It is said that Sir John Hawkins the circumnavigator had a patent for pearl-fishing in the Irt in Cumberland. Although the pearl-fisheries of Britain are now neglected, it is otherwise with those of Germany. The most important of these are in the forest-streams of Bavaria, between Ratisbon and Passau. The Saxon fisheries are chiefly confined to the basin of the White Elster, and those of Bohemia to the Horazdowitz district of Wotawa. For more than two centuries the Saxon fisheries have been carefully regulated by inspectors, who examine the streams every spring, and determine where fishing is to be permitted. After a tract has been fished over, it is left to rest for ten or fifteen years. The fisher-folk open the valves of the mussels with an iron instrument, and if they find no pearl restore the mussel to the water.

River pearls are found in many parts of the United States, and have been systematically worked in the Little Miami river, Warren county, Ohio, and also on the Mississippi, especially about Muscatine, Iowa. The season extends from June to October. Japan produces fresh-water pearls, found especially in the *Anodonta japonica*. But it is in China that the culture of the pearl-mussel is carried to the greatest perfection. The Chinese also obtain marine pearls, and use a large quantity of mother-of-pearl for decorative purposes. More than twenty-two centuries before our era pearls are enumerated as a tribute or tax in China; and they are mentioned as products of the western part of the empire in the *Rû'yo*, a dictionary compiled earlier than 1000 B.C. A process for promoting the artificial formation of pearls in the Chinese river-mussels was discovered by Ye-jin-yang, a native of Hoochow, in the 13th century; and this process is still extensively carried on near the city

of Teh-king, where it forms the staple industry of several villages, and is said to give employment to about 5000 people. Large numbers of the mussels are collected in May and June, and the valves of each are gently opened with a spatula to allow of the introduction of various foreign bodies, which are inserted by means of a forked bamboo stick. These "matrices" are generally pellets of prepared mud, but may be small bosses of bone, brass or wood. After a number of these objects have been placed in convenient positions on one valve, the unfortunate mollusc is turned over and the operation is repeated on the other valve. The mussels are then placed in shallow ponds connected with the canals, and are nourished by tubs of night-soil being thrown in from time to time. After several months, in some cases two or three years, the mussels are removed, and the pearls which have formed over the matrices are cut from the shells, while the molluscs themselves serve as food. The matrix is generally extracted from the pearl and the cavity filled with white wax, the aperture being neatly sealed up so as to render the appearance of the pearl as perfect as possible. Millions of such pearls are annually sold at Soo-chow. The most curious of these Chinese pearls are those which present the form of small seated images of Buddha. The figures are cast in very thin lead, or stamped in tin, and are inserted as previously described. Specimens of these Buddha pearls in the British Museum are referred to the species *Dipsas picala*. It should be mentioned that Linnaeus, probably ignorant of what had long been practised in China, demonstrated the possibility of producing artificial pearls in the fresh-water mussel of Sweden.

Pink pearls are occasionally found in the great conch or fountain shell of the West Indies, *Strombus gigas*, L.; but these, though much prized, are not nacreous, and their tint is apt to fade. They are also produced by the chank shell, *Turbinella scotymus*, L.¹ Yellowish-brown pearls, of little or no value, are yielded by the *Pincta squamosa*, and bad-coloured concretions are formed by the *Placuna placenta*.² Black pearls, which are very highly valued, are obtained chiefly from the pearl oyster of the Gulf of Mexico. The common marine mussel *Mytilus edulis* also produces pearls, which are, however, of little value.

According to the latest researches the cause of pearl-formation is in most cases, perhaps in all, the dead body of a minute parasite within the tissues of a mollusc, around which nacreous deposit is secreted. The parasite is a stage in the life history of a Trematode in some cases, in others of a Cestode; that is to say of a form resembling the common liver-fluke of the sheep, or of a tape-worm. As long ago as 1852 Filippi of Turin showed that the species of Trematode *Distomum duplicatum* was the cause of a pearl formation in the fresh-water mussel *Anodonta*. Kuchenmeister subsequently investigated the question at Elster in Saxony and came to a different conclusion, namely that the central body of the pearl was a small specimen of a species of water mite which is a very common parasite of *Anodonta*. Filippi however states that the mite is only rarely found within a pearl, the Trematode occurring in the great majority of cases. R. Dubois and Dr H. Lyster Jameson have made special investigations of the process in the common mussel *Mytilus edulis*. The latter states that the pearl is produced in a sac which is situated beneath the epidermis of the mantle and is lined by an epithelium. This epithelium is not derived from the cells of the epidermis but from the internal connective-tissue cells. This statement, if correct, is contrary to what would be expected, for calcareous matter is usually secreted by the external epidermis only. The sac or cyst is formed by the larva of a species of Trematode belonging to the genus *Leucithodendrium*, a species closely resembling and probably identical with *L. somateriae*, which lives in the adult state in the eider duck. At Billiers, Morbihan, in France, the host of the adult Trematode is another species of duck, namely the common Scoter, *Oedemia nigra*, which is notorious in the locality for its avidity for mussels. Trematodes of the family Distomidae, to which the parasite under consideration belongs, usually have three hosts in each of which they pass different stages of the life history. In this case the first host at Billiers is a species of bivalve called *Tapes decussatus*, but at Plel in Lancashire there are no Tapes and the first stages of the parasite are found in the common cockle. The Trematode enters the first host as a minute newly hatched embryo and

¹ *Strombus gigas*, L., is a Gastropod belonging to the family Strombidae, of the order Pectinibranchia. *Turbinella scotymus*, Lam., is a Gastropod of the same order.

² *Placuna placenta*, L., belongs to the family Anomiidae; it is found on the shores of North Australia. *Pincta squamosa*, Gmelin, belongs to the Ostreae; it occurs in the Mediterranean. Both are Lamellibranchia.

leaves it in the form called Cercaria, which is really an immature condition of the adult. The Cercaria makes its way into the tissues of a mussel and there becomes enclosed in the cyst previously described. If the mussel is then swallowed by the duck the Cercariae develop into adult Trematodes or flukes in the liver or intestines of the bird. In the mussels which escape being devoured the parasites cannot develop further, and they die and become embedded in the nacreous deposit which forms a pearl. Dr Jameson points out that, as in other cases, pearls in *Mytilus* are common in certain special localities and rare elsewhere, and that the said localities are those where the parasite and its hosts are plentiful.

The first suggestion that the most valuable pearls obtained from pearl oysters in tropical oceans might be due to parasites was made by Kelaart in reports to the government of Ceylon in 1857-1859. Recently a special investigation of the Ceylon pearl fishery has been organized by Professor Herdman. Herdman and Hornell find that in the pearl oyster of Ceylon *Margaritifera vulgaris*, Schum, the nucleus of the pearl is, in all specimens examined, the larva of a Cestode or tapeworm. This larva is of globular form and is of the type known as a cysticercus. As in the case of the mussel the larva dies in its cyst and its remains are enshrined in nacreous deposit, so that, as a French writer has said, the ornament associated in all ages with beauty and riches is nothing but the brilliant sarcophagus of a worm.

The cysticercus described by Herdman and Hornell has on the surface a muscular zone within which is a depression containing a papilla which can be protruded. It was at first identified as the larva of a tapeworm called Tetrarhynchus, and Professor Herdman concluded that the life-history of the pearl parasite consisted of four stages, the first being exhibited by free larvae which were taken at the surface of the sea, the second that in the pearl oyster, the third a form found in the bodies of file-fishes which feed on the oysters, and the fourth or adult stage living in some species of large ray. It has not however been proved that the pearl parasite is a Tetrarhynchus, nor that it is connected with the free larva or the form found in the file-fish, Balistes; nor has the adult form been identified. All that is certain is that the pearls are due to the presence of a parasite which is the larva of a Cestode; all the rest is probability or possibility. A French naturalist, M. Seurat, studying the pearl oyster of the Gambier Archipelago in the Pacific, found that pearl formation was due to a parasite quite similar to that described by Herdman and Hornell. This parasite was described by Professor Giard as characterized by a rostrum armed with a single terminal sucker and he did not identify it with Tetrarhynchus.

Genuine precious pearls and the most valuable mother-of-pearl are produced by various species and varieties of the genus *Melagrina* of Lamarck, for which Dr Jameson in his recent revision of the species prefers the name *Margaritifera*. The genus is represented in tropical regions in all parts of the world. It belongs to the family Aviculidae, which is allied to the Pectens or scallop shells. In this family the hinge border is straight and prolonged into two auriculae; the foot has a very stout bysuss. *Melagrina* is distinguished by the small size or complete absence of the posterior auricula. The species are as follows. The type species is *Melagrina margaritifera*, which has no teeth on the hinge. Geographical races are distinguished by different names in the trade. Specimens from the Malay Archipelago have a dark band along the margin of the nacre and are known as black-edged Banda shell; those from Australia and New Guinea and the neighbouring islands of the western Pacific are called Australian and New Guinea black-lip. Another variety occurs in Tahiti, Gambier Islands and Eastern Polynesia generally, yielding both pearls and shell. It occurs also in China, Ceylon, the Andaman Islands and the Maldives. Another form is taken at Zanzibar, Madagascar, and the neighbouring islands, and is called Zanzibar and Madagascar shell. Bombay shell is another local form fished in the Persian Gulf and shipped via Bombay. The Red Sea variety is known as Egyptian shell. Another variety occurs along the west coast of America and from Panama to Vancouver, and supplies Panama shell and some pearls. A larger form, attaining a foot in diameter and a weight of 10 lb per pair of shells, is considered as a distinct species by Dr Jameson and named *Margaritifera maxima*. It is found along the north coast of Australia and New Guinea and the Malay Archipelago. The nacreous surface of this shell is white, without the black or dark margin of the common species; it is known in the trade as the silver-lip, gold-lip and by other names. It is the most valuable species of mother-of-pearl oyster.

Dr Jameson distinguishes in addition to the above thirty-two species of *Margaritifera* or *Melagrina*; all these have rudimentary teeth on the hinge. The most important species is *Melagrina vulgaris*, to which belong the pearl oyster of Ceylon and southern India, the lingah shell of the Persian Gulf and the pearl oyster of the Red Sea. Since the opening of the Suez Canal the latter form has invaded the Mediterranean, specimens having been taken at Alexandria and at Malta, and attempts have been made to cultivate it on the French coast. The species occurs also on the coasts of the Malay Peninsula, Australia and New Guinea, where it is fished both for its shells (Australian lingah) and for pearls. Two species occur on the coasts of South Africa but have no market value. *Melagrina carcharium* is the Shark's Bay shell of the London market. It is taken in large quantities at Shark's Bay, Western Australia, and is of rather small value; it also yields pearls of inferior quality. The pearl oyster of Japan, known as Japan lingah, is probably a variety of *Melagrina vulgaris*. *Melagrina radiata* is the West Indian pearl oyster.

The largest and steadiest consumption of mother-of-pearl is in the button trade, and much is also consumed by cutlers for handles of fruit and dessert knives and forks, pocket-knives, &c. It is also used in the inlaying of Japanese and Chinese lacquers. European lacquered paper-maché work, trays, &c., and as an ornamental inlay generally. The carving of pilgrim shells and the elaboration of crucifixes and ornamental work in mother-of-pearl is a distinctive industry of the monks and other inhabitants of Bethlehem. Among the South Sea Islands the shell is largely fashioned into fishing-hooks. Among shells other than those of *Melagrina margaritifera* used as mother-of-pearl may be mentioned the Green Ear or Ormer shell (*Heliotis tuberculata*) and several other species of *Heliotis*, besides various species of *Turbo*.

Artificial pearls were first made in western Europe in 1680 by Jacquin, a rosary-maker in Paris, and the trade is now largely carried on in France, Germany and Italy. Spheres of thin glass are filled with a preparation known as "essence d'orient," made from the silvery scales of the bleak or "ablette," which is caused to adhere to the inner wall of the globe, and the cavity is then filled with white wax. Many imitation pearls are now formed of an opaline glass of nacreous lustre, and the soft appearance of the pearl obtained by the judicious use of hydrofluoric acid. An excellent substitute for black pearl is found in the so-called "ironstone jewelry," and consists of close-grained haematite, not too highly polished; but the great density of the haematite immediately destroys the illusion. Pink pearls are imitated by turning small spheres out of the rosy part of the conch shell, or even out of pink coral.

See Clements R. Markham, "The Tinnevely Pearl Fishery," in *Journ. Soc. Arts* (1867), xv, 256; D. T. Macgowan, "Pearls and Pearl-making in China," *ibid.* (1854), li, 72; F. Hague, "On the Natural and Artificial Production of Pearls in China," in *Journ. Roy. Asiatic Soc.* (1856), vol. xvi, 1; H. J. Le Beck, "Pearl Fishery in the Gulf of Mannar," in *Asiatic Researches* (1798), v, 393; K. Möbius, *Die echten Perlen* (Hamburg, 1857); H. Lyster Jameson, "Formation of Pearls," *Proc. Zool. Soc.* (1902), pl. 1; *idem*, "On the Identity and Distribution of Mother-of-Pearl Oysters," *Proc. Zool. Soc.* (1901), pl. 1, pp. 372-394; Herdman and Hornell, *Rep. Ceylon Pearl Fisheries* (London, Royal Soc., 1903); and Kunz and Stevenson, *Book of the Pearl* (New York, 1908), with bibliography. (J. T. C.)

PEARL, THE. The Middle-English poem known as *Pearl*, or *The Pearl*, is preserved in the unique manuscript Cotton Nero Ax at the British Museum; in this volume are contained also the poems *Cleanness*, *Patience*, and *Sir Gawayne and the Green Knight*. All the pieces are in the same handwriting, and from internal evidences of dialect, style and parallel references, it is now generally accepted that the poems are all by the same author. The MS., which is quaintly illustrated, belongs to the end of the 14th or the beginning of the 15th century, and appears to be but little later than the date of composition; no line of *Pearl* or of the other poems is elsewhere to be found.

Pearl is a poet's lament for the loss of a girl-child, "who lived not upon earth two years"—the poet is evidently the child's father. In grief he visits the little grave, and there in a vision beholds his Pearl, now transfigured as a queen of heaven—he sees her beneath "a crystal rock," beyond a stream; the dreamer would fain cross over, but cannot. From the opposite bank Pearl, grown in wisdom as in stature, instructs him in lessons of faith and resignation, expounds to him the mystery of her transfiguration, and leads him to a glimpse of the New Jerusalem. Suddenly the city is filled with glorious maidens, who in long procession glide towards the throne, all of them clad in white, pearl-bedecked robes as Pearl herself. And there he sees, too, "his little queen." A great love-longing possesses him to be by her. He must needs plunge

into the stream that keeps him from her. In the very effort the dreamer awakes, to find himself resting upon the little mound where his Pearl had "strayed below":—

"I roused me, and fell in great dismay,
And, sighing, to myself I said:
Now all be to that Prince's pleasure."

The poem consists of one hundred and one stanzas, each of twelve lines, with four accents, rhymed *ab, ab, ab, bc, bc*; the versification combines rhyme with alliteration; trisyllabic effects add to the easy movement and lyrical charm of the lines. Five stanzas (in one case six), with the same refrain, constitute a section, of which accordingly there are twenty in all, the whole sequence being linked together by the device of making the first line of each stanza catch up the refrain of the previous verse, the last line of the poem re-echoing the first line. The author was not the creator of this form, nor was he the last to use it. The extant pieces in the metre are short religious poems, some of the later (e.g. *God's Complaint*, falsely attributed to Scottish authorship) revealing the influence of *Pearl*.

The dialect is West Midland, or rather North-West Midland, and the vocabulary is remarkable for the blending of native speech with Scandinavian and Romance elements, the latter partly Anglo-French, and partly learned French, due to the author's knowledge of French literature.

"While the main part of the poem," according to Gollancz, "is a paraphrase of the closing chapters of the Apocalypse and the parable of the Vineyard, the poet's debt to the *Romanz of the Rose* is noteworthy, more particularly in the description of the wonderful land through which the dreamer wanders; and it can be traced throughout the poem, in the personification of *Pearl* as Reason, in the form of the colloquy, in the details of dress and ornament, in many a characteristic word, phrase and reference. 'The river from the throne,' in the Apocalypse, here meets 'the waters of the wells' devised by Sir Mirth for the Garden of the Rose. From these two sources, the Book of Revelation, with its almost Celtic glamour, and *The Romanz of the Rose*, with its almost Oriental allegory, are derived much of the wealth and brilliancy of the poem. The poet's fancy revels in the richness of the heavenly and the earthly paradise, but his fancy is subordinated to his earnestness and intensity."

The leading motifs of *Pearl* are to be found in the Gospel—in the allegory of the merchant who sold his all to purchase one pearl of great price, and in the words, so fraught with solace for the child-bereft, "for of such is the Kingdom of Heaven." Naturally arising from the theme, and from these motifs, some theological problems of the time are touched upon, or treated somewhat too elaborately perhaps, and an attempt has been made to demonstrate that *Pearl* is merely allegorical and theological, and not really a lament. Those who hold this view surely ignore or fail to recognize the subtle personal touches whereby the poem transcends all its theological interests, and makes its simple and direct appeal to the human heart. Herein, too, lies its abiding charm, over and above the poetical talent, the love of nature, colour and the picturesque, the technical skill, and the descriptive power, which in a high degree belonged to the unknown poet.

Various theories have been advanced as to the authorship of *Pearl* and the other poems in the manuscript. The claims of Huchown "of the Awle Ryale" have been vigorously (but unsuccessfully) advocated; the case in favour of Ralph Strode (Chaucer's "philosophical Strode")—the most attractive of all the theories—is still, unfortunately, "not proven." By piecing together the personal indications to be found in the poems an imaginary biography of the poet may be constructed. It may safely be inferred that he was born about 1330, somewhere in Lancashire, or a little to the north; that he delighted in open-air life, in woodcraft and sport; that his early life was passed amid the gay scenes that brightened existence in medieval hall and bower; that he availed himself of opportunities of study, theology and romance alike claiming him; that he wedded, and had a child named Margery or Marguerite—the Daisy, or the

Pearl—at whose death his happiness drooped and life's joy ended.

The four poems are closely linked and belong to one period of the poet's career. In *Gawayne*, probably the first of the four, the poet is still the minstrel rejoicing in the glamour of the Arthurian tale, but using it, in almost Spenserian spirit, to point a moral. In *Pearl* the minstrel has become the elegiac poet, harmonizing the old Teutonic form with the newer Romance rhyme. In *Cleanness* he has discarded all attractions of form, and writes, in direct alliterative metre, a stern homily on chastity. In *Patience*—a homiletic paraphrase of Jonah—he appears to be autobiographical, reminding himself, while teaching others, that "Poverty and Patience are needs playfellows." He had evidently fallen on evil days.

It is noteworthy that soon after 1358 Boccaccio wrote his Latin eclogue *Olympia* in memory of his young daughter Violante. A comparative study of the two poems is full of interest; the direct influence of the Latin on the English poem is not so clear as has been maintained. *Pearl* cannot be placed earlier than 1360; it is most probably later than *Olympia*.

BIBLIOGRAPHY.—*Texts and Translations: Early Alliterative Poems in the West Midland Dialect of the Fourteenth Century* (edited by Richard Morris, Early English Text Society 1, 1864; revised, 1869, 1885, 1896, 1901); *Pearl, an English Poem of the Fourteenth Century, edited, with a Modern Rendering, by Israel Gollancz* (with frontispiece by Holman Hunt, and prefatory lines, sent to the editor by Tennyson); revised edition of the text, privately printed, 1897; new edition of text and translation, "King's Classics," 1910-1911; Facsimile of MS. Cotton Nero A. x. 1910-1911; *The Pearl*, (edited by C. G. Osgood, Boston, 1906). Translations by Gollancz (as above); G. C. Coulton (1906); Osgood (1907); Miss Mead (1908); Miss Jewett (1908); part of the poem, by S. Weir Mitchell (1906).

Literary History: Tenbrink, *History of English Literature* (translated by H. M. Kennedy, 1889, i. 336-351); G. Nelson, *Huchown of the Awle Ryale* (Glasgow, 1902); Carleton Brown, *The Author of the Pearl, considered in the Light of his Theological Opinions* (publications of the Modern Languages Association of America, xix. 115-153; 1904); W. G. Schofield, *The Nature and Fabric of the Pearl* (ibid. pp. 154-215; 1904); also *Symbolism, Allegory and Autobiography* (ibid. xxiv. 585-675; 1909); I. Gollancz, *Cambridge History of English Literature*, vol. i. ch. xv.

Works connected with Pearl: *Sir Gawayne, a Collection of Ancient Romance Poems* (edited by Sir F. Madden; London, 1839); *Sir Gawayne* (re-edited by Richard Morris, E.E.T.S., 1864, 1869; text revised by I. Gollancz, 1893); *The Parlement of the Three Ages, and Wynnyere and Wastoure* (edited by I. Gollancz; London, 1897); *Hymns to the Virgin and Christ* (edited by F. J. Furnivall, E.E.T.S., 1867); *Political, Religious and Love Poems* (edited by F. J. Furnivall, E.E.T.S., 1866, 1903).

Metre.—Clark S. Northup, *Study of the Metrical Structure of the Pearl* (publications of the Modern Languages Association, xii. 326-340).

Phonology.—W. Fick, *Zum mittellenglischen Gedächtnis von der Perle* (Kiel, 1885).

PEARSALL, ROBERT LUCAS DE (1795-1856), English composer, was born on the 14th of March 1795, at Clifton. Educated for the bar, he practised till 1825, when he left England for Germany and studied composition under Panny of Mainz; with the exception of three comparatively short visits to England, during one of which he made the acquaintance of the English school of madrigals, he lived abroad, selling his family property of Willsbridge and settling in the castle of Wartensee, on the lake of Constance. He produced many works of lasting beauty, nearly all of them for voices in combination: from his part songs, such as "Oh, who will o'er the downs?" to his elaborate and scholarly madrigals, such as the admirable eight-part compositions, "Great God of Love" and "Lay a Garland," or the beautiful "Light of my Soul." His reception into the Roman Church in his later years may have suggested the composition of some beautiful sacred music, among other things a fine "Salve Regina." He wrote many valuable treatises on music, and edited a Roman Catholic hymn-book. He died on the 5th of August 1856.

PEARSON, CHARLES HENRY (1830-1894), British historian and colonial statesman, was born in London on the 7th of September 1830. After receiving his early education at Rugby and King's College, London, he went up to Oxford, where he

was generally regarded as the most brilliant of an exceptionally able set, and in 1854 obtained a fellowship at Oriel College. His constitutional weakness and bad eyesight forced him to abandon medicine, which he had adopted as a career, and in 1855 he returned to King's College as lecturer in English language and literature, a post which he almost immediately quitted for the professorship of modern history. He made numerous journeys abroad, the most important being his visit to Russia in 1858, his account of which was published anonymously in 1859 under the title of *Russia, by a Recent Traveller*; an adventurous journey through Poland during the insurrection of 1863, of which he gave a sympathetic and much praised account in the *Spectator*; and a visit to the United States in 1868, where he gathered materials for his subsequent discussion of the negro problem in his *National Life and Character*. In the meantime, besides contributing regularly, first to the *Saturday Review* and then to the *Spectator*, and editing the *National Review*, he wrote the first volume of *The Early and Middle Ages of England* (1861). The work was bitterly attacked by Freeman, whose "extravagant Saxonism" Pearson had been unable to adopt. It appeared in 1868 in a revised form with the title of *History of England during the Early and Middle Ages*, accompanied by a second volume which met with general recognition. Still better was the reception of his admirable *Maps of England in the First Thirteen Centuries* (1870). But as the result of these labours he was threatened with total blindness; and, disappointed of receiving a professorship at Oxford, in 1871 he emigrated to Australia. Here he married and settled down to the life of a sheep-farmer; but finding his health and eyesight greatly improved, he came to Melbourne as lecturer on history at the university. Soon afterwards he became head master of the Presbyterian Ladies' College, and in this position practically organized the whole system of higher education for women in Victoria. On his election in 1878 to the Legislative Assembly he definitely adopted politics as his career. His views on the land question and secular education aroused the bitter hostility of the rich squatters and the clergy; but his singular nobility of character, no less than his powers of mind, made him one of the most influential men in the Assembly. He was minister without portfolio in the Berry cabinet (1880-1881), and as minister of education in the coalition government of 1886 to 1890 he was able to pass into law many of the recommendations of his report. His reforms entirely remodelled state education in Victoria. In 1892 a fresh attack of illness decided him to return to England. Here he published in 1893 the best known of his works, *National Life and Character*. It is an attempt to show that the white man can flourish only in the temperate zones, that the yellow and black races must increase out of all proportion to the white, and must in time crush out his civilization. He died in London on the 29th of May 1894.

A volume of his *Reviews and Critical Essays* was published in 1896, and was followed in 1900 by his autobiography, a work of great interest.

PEARSON, JOHN (1612-1686), English divine and scholar, was born at Great Snoring, Norfolk, on the 28th of February 1612. From Eton he passed to Queen's College, Cambridge, and was elected a scholar of King's in April 1632, and a fellow in 1634. On taking orders in 1639 he was collated to the Salisbury prebend of Nether-Avon. In 1640 he was appointed chaplain to the lord-keeper Finch, by whom he was presented to the living of Thorington in Suffolk. In the Civil War he acted as chaplain to George Goring's forces in the west. In 1654 he was made weekly preacher at St Clement's, Eastcheap, in London. With Peter Gunning he disputed against two Roman Catholics on the subject of schism, a one-sided account of which was printed in Paris by one of the Roman Catholic disputants, under the title *Scisma Unmask't* (1658). Pearson also argued against the Puritan party, and was much interested in Brian Walton's polyglot Bible. In 1659 he published in London his celebrated *Exposition of the Creed*, dedicated to his parishioners of St Clement's, Eastcheap, to whom the substance of the work had been preached several years before. In the same year he

published the *Golden Remains of the ever-memorable Mr John Hales of Eton*, with an interesting memoir. Soon after the Restoration he was presented by Juxon, bishop of London, to the rectory of St Christopher-le-Stocks; and in 1660 he was created doctor of divinity at Cambridge, appointed a royal chaplain, prebendary of Ely, archdeacon of Surrey, and master of Jesus College, Cambridge. In 1661 he was appointed Lady Margaret professor of divinity; and on the first day of the ensuing year he was nominated one of the commissioners for the review of the liturgy in the conference held at the Savoy. There he won the esteem of his opponents and high praise from Richard Baxter. On the 14th of April 1662 he was made master of Trinity College, Cambridge. In 1667 he was admitted a fellow of the Royal Society. In 1672 he published at Cambridge *Vindiciæ epistolæ S. Ignatii*, in 4to, in answer to Jean Daille. His defence of the authenticity of the letters of Ignatius has been confirmed by J. B. Lightfoot and other recent scholars. Upon the death of John Wilkins in 1672, Pearson was appointed to the bishopric of Chester. In 1682 his *Annales cypriciæ* were published at Oxford, with John Fell's edition of that father's works. He died at Chester on the 16th of July 1686. His last work, the *Two Dissertations on the Succession and Times of the First Bishops of Rome*, formed with the *Annales Paulini* the principal part of his *Opera posthuma*, edited by Henry Dodwell in 1688.

See the memoir in *Biographia Britannica*, and another by Edward Churton, prefixed to the edition of Pearson's *Minor Theological Works* (2 vols., Oxford, 1844). Churton also edited almost the whole of the theological writings.

PEARSON, JOHN LOUGHBROUGH (1817-1897), English architect, son of William Pearson, etcher, of Durham, was born in Brussels on the 5th of July 1817. He was articled at the age of fourteen to Ignatius Bonomi, architect, of Durham, but soon removed to London, and worked under the elder Hardwicke. He revived and practised largely the art of vaulting, and acquired in it a proficiency unrivalled in his generation. He was, however, by no means a Gothic purist, and was also fond of Renaissance and thoroughly grounded in classical architecture. From the erection of his first church of Ellerker, in Yorkshire, in 1843, to that of St Peter's, Vauxhall, in 1864, his buildings are Geometrical in manner and exhibit a close adherence to precedent, but elegance of proportion and refinement of detail lift them out of the commonplace of mere imitation. Holy Trinity, Westminster (1848), and St Mary's, Dalton Holme (1858), are notable examples of this phase. St Peter's, Vauxhall (1864), his first groined church, was also the first of a series of buildings which brought Pearson to the forefront among his contemporaries. In these he applied the Early English style to modern needs and modern economy with unrivalled success. St Augustine's, Kilburn (1871), St John's, Red Lion Square, London (1874), St Alban's, Birmingham (1880), St Michael's, Croydon (1880), St John's, Norwood (1881), St Stephen's, Bournemouth (1889), and All Saints', Hove (1889), are characteristic examples of his matured work. He is best known by Truro Cathedral (1880), which has a special interest in its apt incorporation of the south aisle of the ancient church. Pearson's conservative spirit fitted him for the reparation of ancient edifices, and among cathedrals and other historical buildings placed under his care were Lincoln, Chichester, Peterborough, Bristol and Exeter Cathedrals, St George's Chapel, Windsor, Westminster Hall and Westminster Abbey, in the surveyorship of which last he succeeded Sir G. G. Scott. Except as to the porch, the work of Scott, he re-faced the north transept of Westminster Abbey, and also designed the vigorous organ cases. In his handling of ancient buildings he was repeatedly opposed by the ultra anti-restorers (as in the case of the west front of Peterborough Cathedral in 1896), but he generally proved the soundness of his judgment by his executed work. Pearson's practice was not confined to church building. Treberfydd House (1850), Quar Wood (1858), Lechlade Manor, an Elizabethan house (1873), Westwood House, Sydenham, in the French Renaissance style (1880), the Astor estate offices (1892) upon the Victoria

Embankment, London, the remodelling of the interiors of Cliveden House (1893) and No. 18 Carlton House Terrace (1894), with many parsonages, show his aptitude for domestic architecture. In general design he first aimed at form, embracing both proportion and contour; and his work may be recognized by accurate scholarship coupled with harmonious detail. Its key-notes are cautiousness and refinement rather than boldness. He died on the 11th of December 1897, and was buried in the nave of Westminster Abbey, where his grave is marked by the appropriate motto *Sustinuit et abstinuit*. He was elected A.R.A. in 1874, R.A. in 1880, was a fellow of the Society of Antiquaries, and a fellow and member of the Council of the Royal Institute of British Architects.

The following are some of Pearson's more important works, not already named: Ferriby church (1846); Stow, Lincolnshire (restoration, 1850); Weybridge, St James's (1853); Freeland church, parsonage and schools (1866); Killburn, St Peter's Home (1868); Wentworth church (1872); Horsforth church (1874); Cullercoats, St George's (1882); Chiswick, St Michael's (restoration, 1882); Great Yarmouth church (restoration, 1883); Liverpool, St Agnes' (1883); Woking Convalescent Home (1884); Headingley church (1884); Torquay, All Saints (1884); Maidstone, All Saints (restoration, 1885); Shrewsbury Abbey (1886); Ayr, Holy Trinity (1886); Hythe church (restoration, 1887); Oxford, New College, reredos (completion, 1889); Cambridge University Library (additions, 1889); Friern Barnet, St John's (1890); Cambridge, Sidney Sussex College (additions, 1890); Middlesex Hospital chapel (1890); Bishopsgate, St Helen's (restoration, 1891); Maida Hill (Irvingite) church (1891); Barking, All Hallows (restoration, 1893); Cambridge, Emmanuel College (additions, 1893); Ledbury, St Michael's (restoration, 1894); Malta, Memorial church (1894); Port Talbot church (1895). (W. D. C.)

PEARY, ROBERT EDWIN (1856—), American Arctic explorer, was born at Cresson, Pennsylvania, on the 6th of May 1856. He graduated at Bowdoin College in 1877, and in 1881 became a civil engineer in the U.S. navy with the rank of lieutenant. In 1884 he was appointed assistant-engineer in connexion with the surveys for the Nicaragua Ship Canal, and in 1887-1888 he was in charge of these surveys. In 1886 he obtained leave of absence for a summer excursion to Disco Bay on the west coast of Greenland. From this point he made a journey of nearly a hundred miles into the interior, and the experience impressed him with the practicability of using this so-called inland ice-cap as a highway for exploration. In 1891 he organized an expedition under the auspices of the Academy of Natural Sciences of Philadelphia. The party of seven included Lieut. Peary's wife, the first white woman to accompany an Arctic expedition. After wintering in Ingfield Gulf on the north-west coast of Greenland, in the following spring Lieut. Peary, with a young Norwegian, Eivind Astrup, crossed the inland ice-cap along its northern limit to the north-east of Greenland and back. The practical geographical result of this journey was to establish the insularity of Greenland. Valuable work was also performed by the expedition in the close study which was made of the isolated tribe of the Cape York or Smith Sound Eskimos, the most northerly people in the world.¹ Lieut. Peary was able to fit out another Arctic expedition in 1893, and was again accompanied by Mrs Peary, who gave birth to a daughter at the winter quarters in Ingfield Gulf. The expedition returned in the season of 1894, leaving Peary with his coloured servant Henson and Mr Hugh G. Lee to renew the attempt to cross the inland ice in the next year. This they succeeded in doing, but without being able to carry the work of exploration any farther on the opposite side of Greenland. During a summer excursion to Melville Bay in 1894, Peary discovered three large meteorites, which supplied the Eskimos with the material for their iron implements, as reported by Sir John Ross in 1818, and on his return in 1895 he brought the two smaller ones with him. The remaining meteorite was brought to New York in 1897. In 1898 Lieut. Peary published *Northward over the Great Ice*, a record of all his expeditions up to that time, and in the same year he started

¹ A narrative of the expedition written by Mrs Peary, and containing an account of the "Great White Journey across Greenland," by her husband, was published under the title of *My Arctic Journal*.

on another expedition to the Arctic regions. In this and subsequent expeditions he received financial aid from Mr Morris Jesup and the Peary Arctic Club. The greatest forethought was bestowed upon the organization of the expedition, a four-years' programme being laid down at the outset and a system of relief expeditions provided for. A distinctive feature was the utilization of a company of Eskimos. Although unsuccessful as regards the North Pole, the expedition achieved the accurate survey (1900) of the northern limit of the Greenland continent and the demonstration that beyond it lay a Polar ocean. In 1902 Peary with Henson and an Eskimo advanced as far north as lat. 84° 17' 27", the highest point then reached in the western hemisphere. Lieut. Peary had now been promoted to the rank of Commander, and on his return he was elected president of the American Geographical Society. In November 1903 he went to England on a naval commission to inquire into the system of naval barracks in Great Britain, and was presented with the Livingstone Gold Medal of the Royal Scottish Geographical Society. Commander Peary then began preparations for another expedition by the construction of a special ship, named the "Roosevelt," the first ever built in the United States for the purpose of Arctic exploration. He sailed from New York on the 16th of July 1905, having two years' supplies on board. The "Roosevelt" wintered on the north coast of Grant Land, and on the 21st of February a start was made with sledges. The party experienced serious delay owing to open water between 84° and 85°, and farther north the ice was opened up during a six days' gale, which cut off communications and destroyed the dépôts which had been established. A steady easterly drift was experienced. But on the 21st of April, 1906, 87° 6' was reached—the "farthest north" attained by man—by which time Peary and his companions were suffering severe privations, and had to make the return journey in the face of great difficulties. They reached the north coast of Greenland and subsequently rejoined the ship, from which, after a week's rest, Peary made a sledge journey along the north coast of Grant Land. Returning home, the expedition reached Hebron, Labrador, on the 13th of October, the "Roosevelt" having been nearly wrecked *en route*. In 1907 the narrative of this journey, *Nearest the Pole*, was published.

In 1908 Peary started in the "Roosevelt" on the journey which was to bring him his final success. He left Etah on the 18th of August, wintered in Grant Land, and set forward over the ice from Cape Columbia on the 1st of March 1909. A party of six started with him, and moved in sections, one in front of another. They were gradually sent back as supplies diminished. At the end of the month Captain Bartlett was the only white man left with Peary, and he turned back in 87° 48' N., the highest latitude then ever reached. Peary, with his negro servant and four Eskimos, pushed on, and on the 6th of April 1909 reached the North Pole. They remained some thirty hours, took observations, and on sounding, a few miles from the pole, found no bottom at 1500 fathoms. The party, with the exception of one drowned, returned safely to the "Roosevelt," which left her winter quarters on the 18th of July and reached Indian Harbour on the 5th of September. Peary's *The North Pole: Its Discovery in 1909* was published in 1910.

Just before the news came of Peary's success another American explorer, Dr F. A. Cook (b. 1865), returning from Greenland to Europe on a Danish ship, claimed that he had reached the North Pole on the 21st of April 1908. He had accompanied an expedition northward in 1907, prepared to attempt to reach the Pole if opportunity offered, and according to his own story had done so, leaving his party and taking only some Eskimos, early in 1908. Nothing had been heard of him since March of that year, and it was supposed that he had perished. Cook's claim to have forestalled Peary was at first credited in various circles, and he was given a rapturous reception at Copenhagen; but scientific opinion in England and America was more reserved, and eventually, after a prolonged dispute, a special committee of the university of Copenhagen, to whom his documents were submitted, declared that they

contained no proof that he had reached the Pole. By that time most other people had come to an adverse conclusion and the sensation was over.

PEASANT (O. Fr. *paysan*, Mod. *paysan*; Lat. *pagensis*, belonging to the *pagus* or country; cf. "pagan"), a countryman or rustic, either working for others, or, more specifically, owning or renting and working by his own labour a small plot of ground. Though a word of not very strict application, it is now frequently used of the rural population of such countries as France, where the land is chiefly held by small holders, "peasant proprietors." (See ALLOTMENTS and METAYAGE).

PEASE, EDWARD (1767-1858), the founder of a famous industrial Quaker family in the north of England, was born at Darlington on the 31st of May 1767, his father, Joseph Pease (1737-1808), being a woollen manufacturer in that town. Having retired from this business Edward Pease made the acquaintance of George Stephenson, and with him took a prominent part in constructing the railway between Stockton and Darlington. He died at Darlington on the 31st of July 1858. His second son, Joseph Pease (1799-1872), who assisted his father in his railway enterprises, was M.P. for South Durham from 1832 to 1847, being the first Quaker to sit in parliament. He was interested in collieries, quarries and ironstone mines in Durham and North Yorkshire, as well as in cotton and woollen manufactures; and he was active in educational and philanthropic work. Another son, Henry Pease (1807-1881), was M.P. for South Durham from 1857 to 1865. Like all the members of his family he was a supporter of the Peace Society, and in its interests he visited the emperor Nicholas of Russia just before the outbreak of the Crimean War, and later the emperor of the French, Napoleon III.

Joseph Pease's eldest son, Sir Joseph Whitwell Pease (1828-1903), was made a baronet in 1882. He was M.P. for South Durham from 1865 to 1885 and for the Barnard Castle division of Durham from 1885 to 1903. His elder son, Sir Alfred Edward Pease (b. 1857), who succeeded to the baronetcy, became famous as a hunter of big game, and was M.P. for York from 1885 to 1892 and for the Cleveland division of Yorkshire from 1897 to 1902. A younger son, Joseph Albert Pease (b. 1860), entered parliament in 1892, and in 1908 became chief Liberal whip, being advanced to the cabinet as chancellor of the duchy of Lancaster in 1910.

Another son of Joseph Pease was Arthur Pease (1837-1898), member of parliament from 1880 to 1885 and again from 1895 to 1898. His son, Herbert Pike Pease (b. 1867), M.P. for Darlington 1898-1910, was one of the Unionist Whips.

The *Diaries of Edward Pease* were edited by Sir Alfred Pease in 1907.

PEAT (possibly connected with Med. Lat. *petio*, *petia*, piece, ultimately of Celtic origin; cf. O. Celt. *pet*, O. Ir. *pit*, Welsh *peth*, portion), a product of decayed vegetation found in the form of bogs in many parts of the world. The continent of Europe is estimated to contain 212,700 sq. m. of bog; Ireland has 2,858,150 acres, Canada 30,000,000 acres, and the United States 20,000,000 acres. The plants which give origin to these deposits are mainly aquatic, including reeds, rushes, sedges and mosses. *Sphagnum* is present in most peats, but in Irish peat *Thacomitrium lanuginosum* predominates. It seems that the disintegration of the vegetable tissues is effected partly by moist atmospheric oxidation and partly by anaerobic bacteria, yeasts, moulds and fungi, in depressions containing fairly still but not stagnant water, which is retained by an impervious bed or underlying strata. As decomposition proceeds the products become waterlogged and sink to the bottom of the pool; in the course of time the deposits attain a considerable thickness, and the lower layers, under the superincumbent pressure of the water and later deposits, are gradually compressed and carbonized. The most favourable conditions appear to be a moist atmosphere, and a mean annual temperature of about 45° F.; no bogs are found between latitudes 45° N. and 45° S.

Peat varies from a pale yellow or brown fibrous substance, resembling turf or compressed hay, containing conspicuous plant

remains, to a compact dark brown material, resembling black clay when wet, and some varieties of lignite when dry. Two typical forms may be noticed: "Hill peat" (the mountain or brown bogs of Ireland), found in mountainous districts, and consisting mainly of *Sphagnum* and *Andromeda*; and "Bottom peat" (the lowland or red bogs of Ireland), found in lakes, rivers, and brooks, and containing *Hypnum*. It always contains much water, up to 90%, which it is necessary to remove before the product can be efficiently employed as a fuel, and for most other purposes. A specimen dried at 100° C. had the composition: carbon=60.48%, hydrogen=6.10%, oxygen=32.55%, nitrogen=0.88%, ash=3.30%; the ash is very variable—from 1 to 65%—and consists principally of clay and sand, with lesser amounts of ferric oxide, lime, magnesia, &c. The specific gravity has been variously given, owing to the variable water content and air spaces; when dried and compressed, however, it is denser than water.

Peat-winning presents certain special features. The general practice is to cut a trench about a foot deep with a peculiarly shaped spade, termed in Ireland a "slane," and remove sods from 3 to 4 ft. long. When one layer has been removed, the next is attacked, and so on. If the deposit be more solid step-working may be adopted, and should water be reached recourse may be had to long-handled slanes. The sods are allowed to drain, and then stacked for drying in the air, being occasionally turned so as to dry equally; this process may require about six weeks. The dried sods are known as "dug peat." Excavators and dredges are now extensively used, and the drying is effected in heated chambers, both fixed and revolving.

The low value of ordinary dug peat as a fuel has led to processes for obtaining a more useful product. In M. Ekenberg's process the wet peat is pulped and milled so as to make it of uniform composition, and the pulp passed into an oven maintained at 180°-200° F., where it is carbonized by superheated water. The pressed product, which resembles lignite, still contains 8 to 14% of water; this is driven off by heat, and the residue briquetted. The final product is nearly equal to coal in calorific value, and has the additional advantage of a lower sulphur content—0.2 to 0.4% against about 2% in ordinary coal. M. Zeigler's method leads to the production of a useful coke. Both these processes permit the recovery of valuable by-products, especially ammonium sulphate. Experiments for obtaining a gas suitable for consumption in gas-engines have been followed by commercial processes devised by the Mond Gas Corporation, London, and Crossley Bros. of Manchester, and by Caro and Frank in Germany. The processes essentially consist in destructively distilling peat in special retorts and under specified conditions, and, in addition to the gas, there is recovered a useful coke and also the nitrogen as ammonium sulphate.

The conversion of the nitrogen into ammonia has been the subject of much work, and is commercially pursued at a works at Carnalough, Co. Antrim, under patents held by H. C. Wolterreck. The peat is treated with a mixture of air and water vapour in special furnaces, and the gaseous products, including paraffin tar, acetic acid and ammonia, are led through a special scrubber to remove the tar, then through a tower containing milk of lime to absorb the acid (the calcium acetate formed being employed for the manufacture of acetone, &c.), and finally through a sulphuric acid tower, where the ammonia is converted into ammonium sulphate which is recovered by crystallization.

Peat has also been exploited as a source of commercial alcohol, to be employed in motors. In the process founded on the experiments of R. W. Wallace and Sir W. Ramsay, which gives 25 to 26 gallons of spirit from a ton of peat, the peat is boiled with water containing a little sulphuric acid, the product neutralized with lime and then distilled; the ammonia is also recovered. In another process a yield of 40 gallons of spirit and 66 lb. of ammonium sulphate per ton of peat is claimed.

Of other applications we may notice C. E. Nelson's process for making a paper, said to be better than ordinary wrapping; the first factory to exploit this idea was opened at Casp, Michigan, in 1906. Peat has been employed as a manure for many years, and recently attempts have been made to convert artificially its nitrogen into assimilable nitrates; such a process was patented by A. Müntz and A. G. Girard of Paris, in 1907.

See P. R. Björling and F. T. Gissing, *Peat and its Manufacture* (1907); F. T. Gissing, *Commercial Peat* (1909); E. Nystrom, *Peat and Lignite* (1908), published by Department of Mines of Canada.

PÉCAUT, FELIX (1808-1898), French educationalist, member of an old Huguenot family, was born at Saïes de Béarn, in 1808. He was for some months evangelical pastor at Saïes, but he had no pretence of sympathy with ecclesiastical authority.

He was consequently compelled to resign his pastorate, and for some years occupied himself by urging the claims of a liberal Christianity. In 1879 he conducted a general inspection of primary education for the French government, and several similar missions followed. His fame chiefly rests in his successful organization of the training school for women teachers at Fontenoy-aux-Roses, to which he devoted fifteen years of ceaseless toil. He died on the 31st of July 1898.

A summary of his educational views is given in his *Public Education and National Life* (1897).

PECCARY, the name of the New World representatives of the swine (*Suidae*) of the E. hemisphere, of which they constitute the sub-family *Dicotylinae* (or *Tagassuinae*). (See *ARTIODACTYLA* and *SWINE*.)

The teeth of the peccaries differ from those of the typical Old World pigs (*Sus*), numerically, in wanting the upper outer incisor and the anterior premolar on each side of each jaw, the dental formula being: i. $\frac{3}{2}$, c. $\frac{1}{1}$, p. $\frac{3}{3}$, m. $\frac{3}{3}$, total 38. From those of all Old World swine or *Suinae*, the upper canines, or tusks, differ in having their points directed downwards, not outwards or



The Collared Peccary (*Dicotyles tajacu*).

upwards; these being very sharp, with cutting hinder edges, and completely covered with enamel until worn. The lower canines are large and directed upwards and outwards, and slightly curved backwards. The cheek-teeth form a continuous series, gradually increasing in size from the first to the last: the molars having square four-cusped crowns. The stomach is much more complex than in the true pigs, almost approaching that of a ruminant. In the feet the two middle (third and fourth) metacarpal and metatarsal bones, which are completely separate in the pigs, are united at their upper ends. On the fore-foot the two (second and fifth) outer toes are equally developed as in pigs, but on the hind-foot, although the inner (or second) is present, the outer or fifth toe is entirely wanting. As in all *Suidae* the snout is truncated, and the nostrils are situated in its flat, expanded, disk-like termination. The ears are rather small, ovate and erect; and there is no external appearance of a tail.

Peccaries, which range from New Mexico and Texas to Patagonia, are represented by two main types, of which the first is the collared peccary, *Dicotyles* (or *Tagassu*) *tajacu*, which has an extensive range in South America. Generally it is found singly or in pairs, or at most in small herds of from eight to ten, and is not inclined to attack other animals or human beings. Its colour is dark grey, with a white or whitish band passing across the chest from shoulder to shoulder. The length of the head and body is about 36 in. The second form is typified by the white-lipped peccary or warri, *D.* (or *T.*) *labiatus*, or *pecari*, representing the sub-genus *Otidossus*. Typically it is rather larger than the collared species, being about 40 in. in length, of a blackish colour, with the lips and lower jaw white. It is

not found farther north than Guatemala, or south of Paraguay. Generally met with in large droves of from fifty to a hundred, it is of a more pugnacious disposition than the former species, and a hunter who encounters a herd in a forest has often to climb a tree as his only chance of safety. Peccaries are omnivorous, living on roots, fallen fruits, worms and carrion, and often inflict great devastation upon crops. Both types are so nearly allied that they will breed together freely in captivity. Unlike pigs, they never appear to produce more than two young ones at a birth.

Remains of extinct peccaries referable to the modern genus occur in the caverns and superficial deposits of South America, but not in the earlier formations. This, coupled with the occurrence of earlier types in North America, indicates that the group is a northern one. Of the extinct North American peccaries, the typical *Dicotyles* occur in the Pliocene while the Miocene *Bothriolabis*, which has tusks of the peccary type, approximates in the structure of its cheek-teeth to the European Miocene genus among the *Suinae*. From this it may be inferred that the ancestral peccaries entered America in the Upper Oligocene. *Platygonus* is an aberrant type which died out in the Pleistocene. (R. L.)

PECHLIN, KARL FREDRIK (1720-1796), Swedish politician and demagogue, son of the Holstein minister at Stockholm, was educated in Sweden, and entered the Swedish army. He rose to the rank of major-general, but became famous by being the type *par excellence* of the corrupt and egoistic Swedish parliamentarian of the final period of the Frihetstiden (see SWEDEN: *History*); he received for many years the sobriquet of "General of the Riksdag." Pechlin first appears prominently in Swedish politics in 1760, when by suddenly changing sides he contrived to save the "Hats" from impeachment. Enraged at being thus excluded from power by their former friend, the "Caps" procured Pechlin's expulsion from the two following Riksdags. In 1769 Pechlin sold the "Hats" as he had formerly sold the "Caps," and was largely instrumental in preventing the projected indispensable reform of the Swedish constitution. During the revolution of 1772 he escaped from Stockholm and kept quietly in the background. In 1786, when the opposition against Gustavus III. was gathering strength, Pechlin reappeared in the Riksdag as one of the leaders of the malcontents, and is said to have been at the same time in the pay of the Russian court. In 1789 he was one of the deputies whom Gustavus III. kept under lock and key till he had changed the government into a semi-absolute monarchy. It is fairly certain that Pechlin was at the bottom of the plot for murdering Gustavus in 1792. On the eve of the assassination (March 16) the principal conspirators met at his house to make their final preparations and discuss the form of government which should be adopted after the king's death. Pechlin undertook to crowd the fatal masquerade with accomplices, but took care not to be there personally. He was arrested on the 17th of March, but nothing definite could ever be proved against him. Nevertheless he was condemned to imprisonment in the fortress of Varberg, where he died four years later.

See R. N. Bain, *Gustavus III. and his Contemporaries* (London, 1905). (R. N. B.)

PECHORA, a river of N. Russia, rising in the Urals, almost on 62° N., in the government of Perm. It flows W. for a short distance, then turns N. and maintains that direction up to about 66° 20' N. It then describes a double loop, to N. and to S., and after that resumes its N. course, finally emptying into the Gulf of Pechora, situated between the White Sea and the Kara Sea. Its total length is 970 m. At its mouth it forms an elongated delta. Although frozen in its upper reaches for 190 days in the year and for 138 days in its lower reaches, it is navigable throughout the greater part of its course. Its drainage basin covers an area of 127,200 sq. m. The principal tributaries are, on the right, the Ilych and the Usa, and on the left the Izhma, the Tsylma and the Sula.

PECK, a dry measure of capacity, especially used for grain. It contains 8 quarts or 2 gallons, and is $\frac{1}{2}$ of a bushel. The

imperial peck contains 554.548 cub. in., in the United States of America 537.6 cub. in. The word is in M.E. *pek*, and is found latinized as *pecum* or *pekka*. In Med. Lat. are found *picotinus*, "mensura frumentaria," and *picotus*, "mensura liquidorum" (Du Cange, *Gloss. s.v.*). These words seem to be connected with the Fr. *picoter*, to peck, of a bird, and this would identify the word with "peck," a variant of "pick," a tap or stroke of the beak, especially used of the action of a bird in picking up grain or other food. The sense-development in this case is very obscure, and the name of the measure is found much earlier than "peck" as a variant form of "pick."

PECKHAM, JOHN (d. 1292), archbishop of Canterbury, was probably a native of Sussex, and received his early education from the Cluniac monks of Lewes. About 1250 he joined the Franciscan order and studied in their Oxford convent. Shortly afterwards he proceeded to the university of Paris, where he took his degree under St Bonaventure and became regent in theology. For many years Peckham taught at Paris, coming into contact with the greatest scholars of the day, among others St Thomas Aquinas. About 1270 he returned to Oxford and taught there, being elected in 1275 provincial minister of the Franciscans in England, but he was soon afterwards called to Rome as *lector sacri palatii*, or theological lecturer in the schools of the papal palace. In 1279 he returned to England as archbishop of Canterbury, being appointed by the pope on the rejection of Robert Burnell, Edward I.'s candidate. Peckham was always a strenuous advocate of the papal power, especially as shown in the council of Lyons in 1274. His enthronement in October 1279 marks the beginning of an important epoch in the history of the English primacy. Its characteristic note was an insistence on discipline which offended contemporaries. Peckham's zeal was not tempered by discernment, and he had little gift of sympathy or imagination. His first act on arrival in England was to call a council at Reading, which met in July 1279. Its main object was ecclesiastical reform, but the provision that a copy of Magna Carta should be hung in all cathedral and collegiate churches seemed to the king a political action, and parliament declared void any action of this council touching on the royal power. Nevertheless Peckham's relations with the king were often cordial, and Edward called on him for help in bringing order into conquered Wales. The chief note of his activity was, however, certainly ecclesiastical. The crime of "plurality," the holding by one cleric of two or more benefices, was especially attacked, as also clerical absenteeism and ignorance, and laxity in the monastic life. Peckham's main instrument was a minute system of "visitation," which he used with a frequency hitherto unknown. Disputes resulted, and on some points Peckham gave way, but his powers as papal legate complicated matters, and he did much to strengthen the court of Canterbury at the expense of the lower courts. The famous quarrel with St Thomas of Cantilupe, bishop of Hereford, arose out of similar causes. A more attractive side of Peckham's career is his activity as a writer. The numerous manuscripts of his works to be found in the libraries of Italy, England and France, testify to his industry as a philosopher and commentator. In philosophy he represents the Franciscan school which attacked the teaching of St Thomas Aquinas on the "Unity of Form." He wrote in a quaint and elaborate style on scientific, scriptural and moral subjects and engaged in much controversy in defence of the Franciscan rule and practice. He was "an excellent maker of songs," and his hymns are characterized by a lyrical tenderness which seems typically Franciscan. Printed examples of his work as commentator and hymn writer respectively may be found in the *Piramentum trium ordinum* (Paris, 1512), and his office for Trinity Sunday in the "unreformed" breviary.

The chief authority on Peckham as archbishop of Canterbury, is the *Registrum fratris Johannis Peckham*, edited by C. Trice Martin for the Rolls Series (London, 1882-1885). A sympathetic account of his life as a Franciscan is to be found in L. Wadding, *Annales minorum* (Lyons, 1625, 1654). See also the article by C. L. Kingsford in *Dict. Nat. Biog.*, and Wilkin's *Concilia magna Britanniae* (London, 1737). (E. O'N.)

PECOCK (or **PEACOCK**), **REGINALD** (c. 1395-c. 1460), English prelate and writer, was probably born in Wales, and was educated at Oriel College, Oxford. Having been ordained priest in 1421, he secured a mastership in London in 1431, and soon became prominent by his attacks upon the religious position of the Lollards. In 1444 he became bishop of St Asaph, and six years later bishop of Chichester. He was an adherent of the house of Lancaster and in 1454 became a member of the privy council. In attacking the Lollards Pecock put forward religious views far in advance of his age. He asserted that the Scriptures were not the only standard of right and wrong; he questioned some of the articles of the creed and the infallibility of the Church; he wished "bi cleer witte drawe men into consente of trewe feith otherwise than bi fire and swerd or hængement" and in general he exalted the authority of reason. Owing to these views the archbishop of Canterbury, Thomas Bourchier, ordered his writings to be examined. This was done and he was found guilty of heresy. He was removed from the privy council and he only saved himself from a painful death by privately, and then publicly (at St Paul's Cross, Dec. 4, 1457), renouncing his opinions. Pecock, who has been called "the only great English theologian of the 15th century," was then forced to resign his bishopric, and was removed to Thorney Abbey in Cambridgeshire, where he doubtless remained until his death. The bishop's chief work is the famous *Repressor of over-much weeding* [blaming] of the Clergie, which was issued about 1455. In addition to its great importance in the history of the Lollard movement the *Repressor* has an exceptional interest as a model of the English of the time, Pecock being one of the first writers to use the vernacular. In thought and style alike it is the work of a man of learning and ability.

A biography of the author is added to the edition of the *Repressor* published by C. Babington for the Rolls Series in 1860. Pecock's other writings include the *Book or Rule of Christian Religion*; the *Donet*, "an introduction to the chief truths of the Christian faith in the form of a dialogue between father and son"; a *d the Folewer to the Donet*. The two last works are extant in manuscript. His *Book of Faith* has been edited from the manuscript in the library of Trinity College, Cambridge, by J. L. Morison (Glasgow, 1909). See also John Lewis, *Life of Pecock* (1744; new ed., 1820).

PECORA (plural of Lat. *pecus*, cattle), a term employed—in a more restricted sense—in place of the older title Ruminantia, to designate the group of ruminating artiodactyle ungulates represented by oxen, sheep, goats, antelopes, deer, giraffes, &c.

The leading characteristics of the Pecora are given in some detail in the article *ARTIODACTYLA* (q.v.); but it is necessary to allude to a few of these here. Pecora, or true ruminants as they may be conveniently called, have complex stomachs and chew the cud; they have no upper incisor teeth; and the lower canines are approximated to the outer incisors in such a manner that the three incisors and the one canine of the two sides collectively form a continuous semicircle of four pairs of nearly similar teeth. In the cheek-teeth the component columns are crescent-shaped, constituting the selenodont type. In the forelimbs the bones corresponding to the third and fourth metacarpals of the pig's foot are fused into a cannon-bone; and a similar condition obtains in the case of the corresponding metatarsals in the hind-limbs. There is generally no sagittal crest to the skull; and the condyle of the lower jaw is transversely elongated. Another general, although not universal, characteristic of the Pecora is the presence of simple or complex appendages on the forehead commonly known as horns. In a few existing species, such as the musk-deer and the water-deer, these appendages are absent, and they are likewise lacking in a large number of extinct members of the group, in fact in all the earlier ones. They are, therefore, a specialized feature, which has only recently attained its full development.

These horns present several distinct structural types, which may be classified as follows:—

I. The simplest type is that of the giraffe, in which three bony prominences—a single one in front and a pair behind—quite separate from the underlying bones and covered during life with skin, occupy the front surface of the skull. The summits of the hind pair are surmounted by bristly hairs. In the extinct

Sinotherium there are two pairs of such appendages, of which the hinder are large and were probably covered during life either with skin or thin horn. In the giraffes the separation of the horns from the skull may be a degenerate character.

II. In the Asiatic muntjac deer we find a pair of skin-covered horns, or "pedicles," corresponding to the paired horns of the giraffe, although welded to the skull. From the summits of these



FIG. 1.—Head of Siamese Deer (*Cervus schomburgkii*), showing antlers.

pedicles arise secondary outgrowths, at first covered with skin, which (owing to the growth of a ring of bone at the base arresting the flow of blood) eventually dries up and leaves bare bone incapable of further growth. In the muntjac the bare bony part, or "antler," is small in proportion to the skin-covered pedicle, and simple in structure; but in the majority of deer the antler increases in size at the expense of the pedicle—which dwindles—and in some species, like the Siamese deer (fig. 1), the sambar and the red deer, becomes very large and more or less branched. Owing to liability to necrosis, the permanent retention of such a mass of dead bone would be dangerous; and the antlers are consequently shed annually (or every few years), to be renewed the following year, when, till the animal becomes past its prime, they are larger than their predecessors. The periodical shedding is also necessary in order to allow of this increase in size. With the exception of the reindeer, antlers are confined to the males.

III. The third type of horn is presented by the American prongbuck, or pronghorn, in which bony processes, or "cores," corresponding to the horns of the giraffe, have acquired a horny sheath, in place of skin; the sheath being in this instance forked, and annually shed and renewed, although the core is simple. The sheaths are akin to hair in structure, thus suggesting affinity with the hairs surmounting the giraffe's horns. Female prongbuck may or may not have horns.

IV. In the great majority of "Hollow-horned Ruminants," such as oxen, sheep, goats and antelopes (fig. 2), the horny sheath (or true "horn") forms a simple unbranched cone, which may be compressed, spirally twisted, or curved in one or more directions, but is permanently retained and continues to grow throughout life from the base, while it becomes worn away at the tip. Rarely, as in the four-horned antelope, there are two pairs of horns. In many cases these horns are present in both sexes.

Dr H. Gadow is of opinion that the antlers of the deer, the horn-like protuberances on the skull of the giraffe, and the true horns of the prongbuck and other hollow-horned ruminants (*Bovidae*) are all different stages of evolution from a single common type: the antlers of the deer being the most primitive, and the horns of the *Bovidae* the most specialized. From the fact that the bony horn-core of the hollow-horned ruminants first develops as a separate ossification, as do the horns of the giraffe, while the pedicle of the antlers of the deer grow direct from the frontal bone, it has been proposed to place the hollow-horned ruminants (inclusive of the prongbuck) and the giraffes in one group and the deer in another. This arrangement has the disadvantage of separating the deer from

the giraffes, to which they are evidently nearly related; but Dr Gadow's work brings them more into line. Whether he is right in regarding the hollow-horned ruminants as derived from the primitive deer may, however, be a matter of opinion. One very important fact recorded by Dr Gadow is that calves and lambs shed their horns at an early age. The *Bovidae* are thus brought into nearer relationship with the American prongbuck (the only living ruminant which sheds its horn-cover in the adult condition) than has generally been supposed.

The above-mentioned four types of skull appendages are generally regarded as severally characteristic of as many family groups, namely the *Giraffidae*, *Cervidae*, *Antilocapridae* and *Bovidae*. The two last are, however, much more closely connected than are either of the others, and should perhaps be united.

Giraffidae.—In the *Giraffidae*, which include not only giraffes (*Giraffa*) but also the okapi (*Ocapia*) and a number of extinct species from the Lower Pliocene Tertiary deposits of southern Europe, Asia and North Africa, the appendages on the skull are of type No. 1., and may well be designated "antler-horns." Another important feature is that the lower canine has a cleft or two-lobed crown, so that it is unlike the incisors to which it is approximated. There are no upper canines; and the cheek-teeth are short-crowned (brachyodont) with a peculiar grained enamel, resembling the skin of a slug in character. The feet have only two hoofs, all traces of the small lateral pair found in many other ruminants having disappeared.

The giraffes (*Giraffa*) are now an exclusively African genus, and have long legs and neck, and three horns—a single one in front and a pair behind—supplemented in some instances with a rudimentary pair on the occiput.

The okapi (*Ocapia*), which is also African but restricted to the tropical forest-region, in place of being an inhabitant of more or less open country, represents a second genus, characterized by the shorter neck and limbs, the totally different type of colouring, and the restriction of the horns to the male sex, in which they form a pair on the forehead; these horns being more compressed than



FIG. 2.—Head of Grant's Gazelle (*Gazella granti*), showing horns.

the paired horns of the giraffe, and penetrating the skin at their summits (see GIRAFFE and OKAPI). Remains of extinct species of giraffe occur in the Lower Pliocene formations of Greece, Hungary, Persia, Northern India and China. From deposits of the same age in Greece, Samos and elsewhere have been obtained skulls and other remains of *Palaeotragus* or *Samoitherium*, a ruminant closely allied to *Ocapia*, the males of which were armed with a very similar pair of dagger-shaped horns. *Halladotherium* was a much larger animal, known by a single hornless skull from the Pliocene of Greece, which may be that of a female. In the equally large

Brometherium and *Hydaspitherium* of India the horns of the males were complex, those of the former including an occipital pair, while those of the latter arise from a common base. In both genera, as in the okapi, there is a vacancy in front of the orbit. Largest of all is *Sivaltherium*, typically from the Lower Pliocene of Northern India, but also recorded from Adrianople, in which the skull of the male is short and wide, with a pair of simple conical horns above the eye, and a huge branching pair at the vertex. *Libytherium* is an allied form from North Africa. Whether the *Giraffidae* were originally an African or a Euro-Asiatic group there is not yet sufficient evidence to decide. The family is unrepresented in the western hemisphere.

Cervidae.—In the deer-tribe, or *Cervidae*, the lower canine, as in the two following families, is simple and similar to the incisors. The frontal appendages, when present, are confined (except in the case of the reindeer) to the males, and take the form of antlers, that is to say of type No. II. in the foregoing description. As a general rule, the molars, and more especially the first, are partially brachyodont (short-crowned); although they are taller in the chital (*Cervus axia*). In the skull there are two orifices to the lachrymal duct, situated on or inside the rim of the orbit. A preorbital vacuity of such dimensions as to exclude the lachrymal bone from articulation with the nasal. Upper canines usually present in both sexes, and sometimes attaining a very great size in the male (see fig. 3).



FIG. 3.—Skull of Chinese Water-Deer, *Hydralaphus inermis* (adult male), a Deer without Antlers, but with largely developed upper canine teeth.

Lateral digits of both fore and hind feet almost always present, and frequently the lower ends of the metacarpals and the metatarsals as well. Placenta with few cotyledons. Gall-bladder absent (except in the musk-deer, *Moschus*). This family contains numerous species, having a wide geographical distribution, ranging in the New World from the Arctic circle as far south as Patagonia, and in the Old World throughout the whole of Europe and Asia, but absent in Africa south of the Sahara, and, of course, Australasia. Evidently the family originated in the northern continent of the Old World, from which an entrance was effected by way of Bering Strait into America. Some of the more northern American deer, such as the wapiti, reindeer and elk (moose), are closely allied to Old World species; but there is also a group of exclusively American deer (*Masama*)—the only one found in Central and South America—the members of which are unlike any living Old World deer; and these must be regarded as having reached the western hemisphere at an earlier date than the wapiti, reindeer and elk (see DEER, ELK, FALLOW-DEER, MUNTJAC, MUSK-DEER, PÈRE DAVID'S DEER, REINDEER, ROEBUCK, WATER-DEER, &c.).

Remains of deer more or less nearly allied to species inhabiting the same districts are found over the greater part of the present habitat of the family. It is noteworthy, however, that certain Pliocene European deer (*Atelapha*) appear to be closely allied to the modern American deer (*Masama*). As we descend in the geological series the deer have simpler antlers, as in the European Miocene *Diceroscus*; while in the Oligocene *Amphitragulus*, *Drepanotherium* and *Palaomeryx*, constituting the family *Palaomerycidae*, antlers were absent, and the crowns of the molars so low that the whole depth of the hollows between the crescentic columns is completely visible. Most of these animals were of small size, and many had long upper canines, like those of the existing *Hydralaphus*; while in all there was no depression for a gland in front of the eyes.

From North America have been obtained remains of certain ruminants which seem in some degree intermediate between deer and the prongbuck. Of one of these a complete skeleton was obtained in 1901 from the Middle Miocene deposits of north-eastern Colorado, and as mounted stands 19 in. in height at the withers. With the exception that the right antler is malformed and partially aborted, and that the bones of the lateral toes have been lost, the skeleton is practically complete. The one complete antler has a well-marked burr and a long undivided beam, which eventually forks. After this there is a bifurcation of the hinder branch, thus producing three tines. From the presence of these well-marked antlers the skeleton would at first sight be set down as that of a small and primitive deer, conforming in regard to the structure of these appendages to the American type of the group. Mr W. D.

Matthew shows, however, that the skeleton of *Merycodus*, as the extinct ruminant is called, differs markedly from that of all deer. The most noteworthy point of distinction is in the skull, in which the facial portion is sharply bent down on the posterior basal axis in the fashion characteristic of the hollow-horned ruminants (oxen, antelopes, &c.), and the American prongbuck, instead of running more or less nearly parallel to the same, as in deer. Again, the cheek-teeth have the tall crowns characteristic of a large number of representatives of the first group and of the prongbuck, thereby showing that *Merycodus* can scarcely be regarded as a primitive type. As regards the general structure of the rest of the skeleton, it must suffice to say that this agrees closely with that of the antelope and the prongbuck, and differs markedly from the cervine type. In the absence of any trace of the lower extremities of the metacarpal and metatarsal bones of the lateral toes the skeleton differs from the American deer, and resembles those hollow-horned ruminants in which these toes persist.

As a whole *Merycodus* presents a curious mixture of cervine and antilopine character. To explain these, two alternatives are offered by the describer. Either we must regard *Merycodus* as a deer which parallels the antelopes and the prongbuck in every detail of skeletal structure, or else, like the prongbuck, an antelope separated from the main stock at a date sufficiently early to have permitted the development of a distinct type of cranial appendages, namely, antlers in place of true horns. The former alternative, it is urged, involves a parallelism too close and too uniform between unrelated types to have been probable. On the latter view *Merycodus*, the prongbuck (*Antilocapra*) and the antelopes must be regarded as representing three branches from an original common stock, divergent as regards the structure of their cranial appendages, but parallel in other respects. If, therefore, *Antilocapra* deserves to be separated as a family from the *Bovidae*, the same can scarcely be refused for *Merycodus*. But American extinct types appear to indicate signs of intimate relationship between antelopes, prongbuck and deer, and it may be necessary eventually to amend the current classification. As a temporary measure it seems preferable to regard *Merycodus* either as representing a distinct sub-family of *Antilocapridae* or a family by itself, the latter course being adopted by Mr Matthew.

Whatever be the ultimate verdict, the association of antlers—and these, be it noticed, conforming almost exactly with the forked type characteristic of American deer—with an antilopine type of skull, skeleton and teeth in *Merycodus* is a most interesting and unexpected feature. *Merycodus* was named many years ago by Professor J. Leidy on the evidence of imperfect materials, and other remains now known to belong to the same type were subsequently described as *Cosoryx*, to which *Blastomeryx* seems to be allied. Not till the discovery of the skeleton of the species described by Mr Matthew was it possible to arrive at an adequate conception of the affinities of this remarkable ruminant.

Antilocapridae.—By many modern writers the American prongbuck, pronghorn or "antelope," alone forming the genus *Antilocapra*, is regarded as representing merely a sub-family of the *Bovidae*, to which latter group the animal is structurally akin. In view of what has been stated in the preceding paragraph with regard to the extinct American genus *Merycodus*, it seems, however, at least provisionally advisable to allow the prongbuck to remain as the type of a family—*Antilocapridae*. The characteristic of this family—as represented by the prongbuck—is that the sheath of the horns is forked, and shed annually, or every few years. The cheek-teeth are tall-crowned (hypodont), and lateral hoofs are wanting (see PRONGBUCK).

Bovidae.—Lastly, we have the great family of hollow-horned ruminants or *Bovidae*, in which the horns (present in the males at least of all the existing species) take the form of simple non-deciduous hollow sheaths growing upon bony cores. As a rule the molars are tall-crowned (hypodont). Usually only one orifice to the lachrymal canal, situated inside the rim of the orbit. Lachrymal bone almost always articulating with the nasal. Canines absent in both sexes. The lateral toes may be completely absent, but more often are represented by the hoofs alone, supported sometimes by a very rudimentary skeleton, consisting of mere irregular nodules of bone. Lower ends of the lateral metacarpals and metatarsals never present. Gall-bladder almost always present. Placenta with many cotyledons.

The *Bovidae* form a most extensive family, with members widely distributed throughout the Old World, with the exception of the Australian region; but in America they are less numerous, and confined to the Arctic and northern temperate regions, no species being indigenous either to South or Central America. The home of the family was evidently the Old World, whence a small number of forms made their way into North America by way of what is now Bering Strait. It has already been pointed out that the *Cervidae* originated in the northern continent of the Old World; and it has been suggested that the *Bovidae* were developed in Africa. Unfortunately, we know at present practically nothing as to the past history of the group, all the fossil species at present discovered approximating more or less closely to existing types. While admitting, therefore, that there are several facts in favour of the theory of an African origin of the *Bovidae*, final judgment

must for the present be suspended. For the various generic types see BOVIDAE, and the special articles referred to under that heading. (R. L.)

PÉCS (Ger. *Fünfkirchen*), a town of Hungary, capital of the country of Baranya, 160 m. S.S.W. of Budapest by rail. Pop. (1900), 42,252. It lies on the outskirts of the Mecsek Hills, and is composed of the inner old town, which is laid out in an almost regular square, and four suburbs. Pécs is the see of a Roman Catholic bishop, and its cathedral, reputed one of the oldest churches in Hungary, is also one of the finest medieval buildings in the country. It was built in the 11th century in the Romanesque style with four towers, and completely restored in 1881-1891. In the Cathedral Square is situated the *Sacellum*, a subterranean brick structure, probably a burial-chapel, dating from the end of the 4th or the beginning of the 5th century. Other noteworthy buildings are the parish church, formerly a mosque of the Turkish period; the hospital church, also a former mosque, with a minaret 88 ft. high, and another mosque, the bishop's palace, and the town and county hall. Pécs has manufactories of woollens, porcelain, leather and paper, and carries on a considerable trade in tobacco, gall-nuts and wine. The hills around the town are covered with vineyards, which produce one of the best wines in Hungary. In the vicinity are valuable coal-mines, which since 1858 are worked by the Danube Steamship Company.

According to tradition Pécs existed in the time of the Romans under the name of *Sompiana*, and several remains of the Roman and early Christian period have been found here. In the Frankish-German period it was known under the name of *Quinque ecclesiae*; its bishopric was founded in 1009. King Ludwig I. founded here in 1367 a university, which existed until the battle of Mohács. In 1543 it was taken by the Turks, who retained possession of it till 1686.

PECTORAL, a word applied to various objects worn on the breast (Lat. *pectus*); thus it is the name of the ornamental plate of metal or embroidery formerly worn by bishops of the Roman Church during the celebration of mass, the breastplate of the Jewish high priest, and the metal plate placed on the breast of the embalmed dead in Egyptian tombs. The "pectoral cross," a small cross of precious metal, is worn by bishops and abbots of the Roman, and by bishops of the Anglican, communion. The term has also been used for the more general "poitreil" or "peitrel" (the French and Norman French forms respectively), the piece of armour which protected the breast of the war-horse of the middle ages.

PECULIAR, a word now generally used in the sense of that which solely or exclusively belongs to, or is particularly characteristic of, an individual; hence strange, odd, queer. The Lat. *peculiaris* meant primarily "belonging to private property," and is formed from *peculium*, private property, particularly the property given by a *paterfamilias* to his children, or by a master to his slave, to enjoy as their own. As a term of ecclesiastical law "peculiar" is applied to those ecclesiastical districts, parishes, chapels or churches, once numerous in England, which were outside the jurisdiction of the bishop of the diocese in which they were situated, and were subject to a jurisdiction "peculiar" to themselves. They were introduced originally, in many cases by papal authority, in order to limit the powers of the bishop in his diocese. There were royal peculiars, e.g. the Chapel Royal St James's, or St George's Windsor, peculiars of the archbishop, over certain of which the Court of Peculiars exercised jurisdiction (see ARCHES, COURT OF), and peculiars of bishops and deans (see DEAN). The jurisdiction and privileges of the "peculiars" were abolished by statutory powers given to the Ecclesiastical Commissioners, by the Ecclesiastical Commissioners Acts 1836 and 1850, by the Pluralities Act 1838, the Ecclesiastical Jurisdiction Act 1847, and other statutes.

PECULIAR PEOPLE, a small sect of Christian faith-healers founded in London in 1838 by John Banyard. They consider themselves bound by the literal interpretation of James v. 14, and in cases of sickness seek no medical aid but rely on oil, prayer and nursing. The community is in the main composed

of simple working people, who, apart from their peculiarity, have a good reputation; but their avoidance of professional medical attendance has led to severe criticism at inquests on children who have died for want of it.

PEDAGOGUE, a teacher or schoolmaster, a term usually now applied with a certain amount of contempt, implying pedantry, dogmatism or narrow-mindedness. The Gr. *παιδαγωγός* (*país*, boy, *αγωγός*, leader, *αγω*, to lead), from which the English word is derived, was not strictly an instructor. He was a slave in an Athenian household who looked after the personal safety of the sons of the master of the house, kept them from bad company, and took them to and from school and the gymnasium. He probably sat with his charges in school. The boys were put in his charge at the age of six. The *παιδαγωγός*, being a slave, was necessarily a foreigner, usually a Thracian or Asiatic. The Romans adopted the *paedagogus* or *pedagogus* towards the end of the republic. He probably took some part in the instruction of the boys (see SCHOOLS). Under the empire, the *paedagogus* was specifically the instructor of the boy slaves, who were being trained and educated in the household of the emperor and of the rich nobles and other persons; these boys lived together in a *paedagogium*, and were known as *puri paedagogiani*, a name which has possibly developed into "page" (q.v.).

PEDAL CLARINET, a contrabass instrument invented in 1891 by M. F. Besson to complete the quartet of clarinets, as the contrafagotto or double bassoon completes that of the oboe family; it is constructed on practically the same principles as the clarinet, and consists of a tube 10 ft. long, in which cylindrical and conical bores are so ingeniously combined that the acoustic principles remain unchanged. The tube is doubled up twice upon itself; at the upper end the beak mouthpiece stands out like the head of a viper, while at the lower a metal tube, in the shape of a U with a wide gloxinea-shaped bell, is joined to the wooden tube. The beak mouthpiece is exactly like that of the other clarinets but of larger size, and it is furnished with a single or beating reed. There are 13 keys and 2 rings on the tube, and the fingering is the same as for the B flat clarinet except for the eight highest semitones. The compass of the pedal clarinet is as follows:—

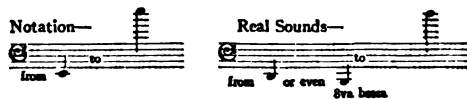

The instrument is in B flat two octaves below the B flat clarinet, and, like it, it is a transposing instrument, the music being written in a key a tone higher than that of the composition, and in order to avoid ledger lines a whole octave higher besides. The tone is rich and full except for the lowest notes, which are unavoidably a little rough in quality, but much more sonorous than the corresponding notes on the double bassoon. The upper register resembles the chalumeau register of the B flat clarinet, being reedy and sweet. The instrument is used as a fundamental bass for the wood wind at Kneller Hall, and it has also been used at Covent Garden to accompany the music of Falner and Hunding in the *Nibelungen Ring*.

Many attempts have been made since the beginning of the 19th century to construct contra clarinets, but all possessed inherent faults and have been discarded (see BARYPHONE). A contrabass clarinet in F, an octave below the basset horn, constructed by Albert of Brussels in 1890, was, we believe, considered successful, but it differed in design from the pedal clarinet. (K. S.)

PEDANT, one who exaggerates the value of detailed erudition for its own sake; also a person who delights in a display of the exact niceties of learning, in an excessive obedience to theory without regard to practical uses. The word came into English in the latter part of the 16th century in the sense of schoolmaster, the original meaning of Ital. *pedante*, from which it is derived. The word is usually taken to be an adaptation of Gr. *παιδαγωγός*,

to teach. Others connect with an O. Ital. *pedare*, to tramp about (Lat. *pes*, foot), of an usher tramping about with his pupils.

PEDEN, ALEXANDER (c. 1626-1686), Scottish divine, one of the leading forces in the Covenant movement, was born at Auchincloch, Ayrshire, about 1626, and was educated at Glasgow University. He was ordained minister of New Luce in Galloway in 1660, but had to leave his parish under Middleton's Ejectment Act in 1663. For 23 years he wandered far and wide, bringing comfort and succour to his co-religionists, and often very narrowly escaping capture. He was indeed taken in June 1673 while holding a conventicle at Knockdow, and condemned by the privy council to 4 years and 3 months' imprisonment on the Bass Rock and a further 15 months in the Tolbooth at Edinburgh. In December 1678 he was, with sixty others, sentenced to banishment to the American plantations, but the party was liberated in London, and Peden made his way north again to divide the remaining years of his life between his own country and the north of Ireland. His last days were spent in a cave in the parish of Sorn, near his birthplace, and there he died in 1686, worn out by hardship and privation.

See A. Smeltie, *Mens of the Covenant*, ch. xxxiv.

PEDERSEN, CHRISTIERN (c. 1480-1554), Danish writer, known as the "father of Danish literature," was a canon of the cathedral of Lund, and in 1510 went to Paris, where he took his master's degree in 1515. In Paris he edited the proverbs of Peder Laale and (1514) the *Historia danica* of Saxo Grammaticus. He showed signs of the spirit of reform, asserting that the gospels should be translated into the vernacular so that the common people might understand. He worked at a continuation of the history of Saxo Grammaticus, and became secretary to Christian II., whom he followed into exile in 1525. In Holland he translated the New Testament (1529) and the Psalms (1531) from the Vulgate, and, becoming a convert to the reformed opinion, he issued several Lutheran tracts. After his return to Denmark in 1532 he set up a printing press at Malmö. He published a Danish version (*Krønike om Holger Danske*) of the French romance of Ogier the Dane, and another of the Charlemagne legends, which is probably derived immediately from the Norwegian *Karlamagnus saga*. His greatest work, the Danish version of the Holy Scriptures, which is known generally as "Christian III.'s Bible," is an important landmark in Danish literature. It was founded on Luther's version, and was edited by Peder Palladius, bishop of Zealand, and others.

See C. Pedersen's *Danske Skrifter*, edited by C. J. Brandt and B. T. Fenger (5 vols., Copenhagen, 1850-1856).

PEDESTAL (Fr. *pedestal*, Ital. *pedestallo*, foot of a stall), a term generally applied to a support, square, octagonal or circular on plan, provided to carry a statue or a vase. Although in Syria, Asia Minor and Tunisia the Romans occasionally raised the columns of their temples or propylæa on square pedestals, in Rome itself they were employed only to give greater importance to isolated columns, such as those of Trajan and Antoninus, or as a *podium* to the columns employed decoratively in the Roman triumphal arches. The architects of the Italian revival, however, conceived the idea that no order was complete without a pedestal, and as the orders were by them employed to divide up and decorate a building in several storeys, the cornice of the pedestal was carried through and formed the sills of their windows, or, in open arcades, round a court, the balustrade of the arcade. They also would seem to have considered that the height of the pedestal should correspond in its proportion with that of the column of pilaster it supported, thus in the church of St John Lateran, where the applied order is of considerable dimensions, the pedestal is 13 ft high instead of the ordinary height of 3 to 5 ft.

PEDICULOSIS, or **PHTHIRIASIS**, the medical term for the pathological symptoms in man due to the presence of lice (*pediculi*), either on the head (*pediculus capitis*), body (*pediculus corporis*, or *vestimentorum*), or pubes (*pediculus pubis*)

PEDIGREE, a genealogical tree, a tabular statement of descent (see **GENEALOGY**). The word first appears at the beginning of the 15th century and takes an extraordinary variety of forms,

e.g. *pedicree*, *pe de gre*, *pediegrew*, *peygru*, &c. It is generally accepted that these point to a corruption of Fr. *ped de gram*, foot of a crane, and that the probable reference is to the marks resembling the claw of a bird found in old genealogies showing the lines of descent. Such etymologies as Minshew's *par degrés*, by *degrees*, or *par degrés*, descent by the father, are mere guesses.

PEDIMENT (equivalents, Gr. *ἀέρβς*, Lat. *fastigium*, Fr. *pouton*), in classic architecture the triangular-shaped portion of the wall above the cornice which formed the termination of the roof behind it. The projecting mouldings of the cornice which surround it enclose the tympanum, which is sometimes decorated with sculpture. The pediment in classic architecture corresponds to the gable in Gothic architecture, where the roof is of loftier pitch. It was employed by the Greeks only as the front of the roof which covered the main building; the Romans, however, adopted it as a decorative termination to a doorway, niche or window, and occasionally, in a row of windows or niches, alternated the triangular with a segmental pediment. It was reserved for the Italian architects of the decadence to break the pediment in the centre, thus destroying its original purpose. The earliest English form of the word is *periment* or *peremint*, probably a workman's corruption of "pyramid."

PEDIPALPI, Arachnida (q.v.) related to the spiders, and serving in a measure to bridge over the structural interval between the latter and the scorpions. The appendages of the second pair are large and prehensile, as in scorpions, but are armed with spines, to impale and hold prey. The appendages of the third pair, representing the first pair of walking legs in spiders and scorpions, are, on the contrary, long, attenuated and many-jointed at the end. Like the antennae of insects, they act as feelers. It is from this structural feature that the term "pedipalpi" has been derived. In the tailless division of the Pedipalpi,

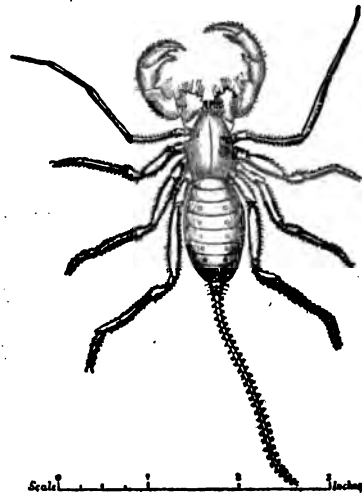

Mexican tailed Pedipalp (*Mastigoproetus giganteus*).

namely the Amblypygi of which *Phrynos* is a commonly cited type, these tactile appendages are exceedingly long and lash-like, whereas in the tailed division, the Uropygi, of which *Thelyphonus* is best known, the limb is much shorter and less modified. *Thelyphonus* and its allies, however, have a long tactile caudal flagellum, the homologue of the scorpion's sting; but its exact use is unknown. A third division, the Tartarides, a subordinate group of the Uropygi, contains minute Arachnida differing principally from the typical Uropygi in having the caudal process unjointed and short. Apart from the Tartarides, the Pedipalpi

are large or medium-sized Arachnida, nocturnal in habits and spending the day under stones, logs of wood or loosened bark. Some species of the Uropygi (Thelyphonidae) dig burrows; and in the east there is a family of Amblypygi, the Charontidae, of which many of the species live in the recesses of deep caves. Specimens of another species have been found under stones between tide marks in the Andaman Islands. The Pedipalpi feed upon insects, and like spiders, are oviparous. The eggs after being laid are carried about by the mother, adhering in a glutinous mass to the underside of the abdomen.

Pedipalpi date back to the Carboniferous Period, occurring in deposits of that age both in Europe and North America. Moreover, the two main divisions of the order, which were as sharply differentiated then as they are now, have existed practically unchanged from that remote epoch.

In spite of the untold ages they have been in existence, the Pedipalpi are more restricted in range than the scorpions. The Uropygi are found only in Central and South America and in south and eastern Asia, from India and south China to the Solomon Islands. The absence of the entire order from Africa is an interesting fact. The distribution of the Amblypygi practically covers that of the Uropygi, but in addition they extend from India through Arabia into tropical and southern Africa. Both groups are unknown in Madagascar, in Australia, with the exception possibly of the extreme north, and in New Zealand. Very little can be said with certainty about the distribution of the Tardigrades. They have been recorded from the Indian Region, West Africa and sub-tropical America. (R. I. P.)

PEDOMETER (Lat. *pēs*, foot, and Gr. *μέτρον*, measure), an apparatus in the form of a watch, which, carried on the person of a walker, counts the number of paces he makes, and thus indicates approximately the distance travelled. The ordinary form has a dial-plate marked for yards and miles. The registration is effected by the fall of a heavy pendulum, caused by the percussion of each step. The pendulum is forced back to a horizontal position by a delicate spring, and with each stroke a fine-toothed ratchet-wheel connected with it is moved round a certain length. The ratchet communicates with a train of wheels which work the dial-hands. In using the apparatus a measured mile or other known distance is walked and the indication thereby made on the dial-plate observed. According as it is too great or too small, the stroke of the pendulum is shortened or lengthened by a screw. Obviously the pedometer is little better than an ingenious toy, depending even for rough measurements on the uniformity of pace maintained throughout the journey measured.

PEDRO II. (1825-1891), emperor of Brazil, came to the throne in childhood, having been born on the 2nd of December 1825, and proclaimed emperor in April 1831, upon the abdication of his father. He was declared of full age in 1840. For a long period few thrones appeared more secure, and his prosperous and beneficent rule might have endured throughout his life but for his want of energy and inattention to the signs of the times. The rising generation had become honeycombed with republicanism, the prospects of the imperial succession were justly regarded as unsatisfactory, the higher classes had been estranged by the emancipation of the slaves, and all these causes of discontent found expression in a military revolt, which in November 1889 overthrew the seemingly solid edifice of the Brazilian Empire in a few hours. Dom Pedro retired to Europe, and died in Paris on the 5th of December 1891. The chief events of his reign had been the emancipation of the slaves, and the war with Paraguay in 1864-70. Dom Pedro was a model constitutional sovereign, and a munificent patron of science and letters. He travelled in the United States (1876), and thrice visited Europe (1871-1872, 1876-1877, 1886-1886).

PEEBLES, a royal and police burgh and county town of Peeblesshire, Scotland, situated at the junction of Eddleston Water with the Tweed. Pop. (1901), 5266. It is 27 m. south of Edinburgh by the North British Railway (22 m. by road), and is also the terminus of a branch line of the Caledonian system from Carstairs in Lanarkshire. The burgh consists of the new

town, the principal quarter, on the south of the Eddleston, and the old on the north, the Tweed is crossed by a handsome five-arched bridge. Peebles is a noted haunt of anglers, and the Royal Company of Archers shoot here periodically for the silver arrow given by the burgh. The chief public buildings are the town and county halls, the corn exchange, the hospital, and Chambers Institution. The last was once the town house of the earls of March, but was presented to Peebles by William Chambers, the publisher, in 1859. The site of the castle, which stood till the beginning of the 18th century, is now occupied by the parish church, built in 1887. Of St Andrew's Church, founded in 1195, nothing remains but the tower, restored by William Chambers, who was buried beside it in 1883. The church of the Holy Rood was erected by Alexander III. in 1261, to contain a supposed remnant of the true cross discovered here. The building remained till 1784, when it was nearly demolished to provide stones for a new parish church. Portions of the town walls still exist, and there are also vaulted cellars constructed in the 16th and 17th centuries as hiding-places against Border freebooters. The old cross, which had stood for several years in the quadrangle of Chambers Institution, was restored and erected in High Street in 1895. The industries consist of the manufactures of woollens and tweeds, and of meal and flour mills. The town is also an important agricultural centre.

The name of Peebles is said to be derived from the *pebblys*, or tents, which the Gadeni pitched here in the days of the Romans. The place was early a favourite residence of the Scots kings when they came to hunt in Eitrick forest. It probably received its charter from Alexander III., was created a royal burgh in 1367 and was the scene of the poem of *Peblis to the Play*, ascribed to James I. In 1544 the town sustained heavy damage in the expedition led by the 1st earl of Hertford; afterwards the protector Somerset, and in 1604 a large portion of it was destroyed by fire. Though James VI. extended its charter, Peebles lost its importance after the union of the Crowns.

On the north bank of the Tweed, one mile west of Peebles, stands Neidpath Castle. The ancient peel tower dates probably from the 13th century. Its first owners were Tweeddale Frazers or Frisels, from whom it passed, by marriage, to the Hays of Yester in Haddingtonshire, earls of Tweeddale. It was besieged and taken by Cromwell in 1650. The third earl of Tweeddale (1645-1713) sold it to the duke of Queensberry in 1686. The earl of Wemyss succeeded to the Neidpath property in 1810.

PEEBLESSHIRE, or **TWEEDDALE**, a southern inland county of Scotland, bounded N and N.E. by Edinburghshire, E. and S.E. by Selkirkshire, S. by Dumfriesshire, and W. by Lanarkshire. Its area is 222,599 acres or 547.8 sq. m. The surface consists of a succession of hills, which are highest in the south, broken by the vale of the Tweed and the glens formed by its numerous tributaries. South of the Tweed the highest points are Broad Law and Cramalt Crnig on the confines of Selkirkshire (each 2723 ft.), while north of the river are, in the west centre, Broughton Heights (1872), Trahenna Hill (1792), Penvalla (1764) and Ladyurd Hill (1724), and in the north-west the Pentland eminences of Mount Maw (1753), Byrchope Mount (1752) and King Seat (1521). The lowest point above sea-level is on the banks of the Tweed, where it passes into Selkirkshire (about 450 ft.). The principal river is the Tweed, and from the fact that for the first 36 m. of its course of 97 m. it flows through the south of the shire, the county derives its alternative name of Tweeddale. Its affluents on the right are the Stanhope, Drummelzier, Manor and Quair; on the left, the Biggar, Lyne, Eddleston and Leithen. The North Esk, rising in Cairnmuir, forms the boundary line between Midlothian and Peeblesshire for about four miles, during which it presents some very charming pictures, especially at Habbie's Howe, where Allan Ramsay laid the scene of the *Gentle Shepherd*. For 4 m. of its course the South Medwin divides the south-western part of the parish of Linton from Lanarkshire. Portmore Loch, a small sheet of water 2 m. north-east of Eddleston church, lies at a height of 1000 ft. above the sea, and is the only lake in the county. The shire is in favour with anglers, its streams being well stocked and unpolluted, and few restrictions being placed on the fishing.

Geology.—The southern elevated portion of the county is occupied by Silurian rocks, mainly by shales and grits or greywackes of Llandoverly age. Owing to the repeated folding and crumpling of the rocks in this region there are numerous elliptical exposures of Ordovician strata within the Silurian tract; but the principal area of Ordovician rocks lies north of a line running south-west from the Moorfoot Hills through Lyne and Stobo. Here these rocks form a belt some four to five miles in breadth; they are composed of radiolarian cherts and mudstones with associated contemporaneous volcanic rocks of Arenig age, and of shales, grits and limestones of Llandilo and Caradoc age. The general direction of strike of all these formations is south-west-north-east, but the dips are sometimes misleading through occasional inversion of the strata. Patches of higher Silurian, with Wenlock and Ludlow fossils, are found in the north of the country in the Pentland Hills, and resting conformably upon the Silurian in the same district is the Lower Old Red Sandstone. The Old Red Sandstone here consists of a lower division, red and chocolate marls and sandstones; a middle division, volcanic rocks, porphyrites, tuffs, &c., which are unconformable on the lower marls in this area; and an upper division, sandstones and conglomerates. The south-west extremity of the Edinburgh coalfield just enters this county over the north-west border where a slice of Carboniferous strata is found let down between Silurian and Old Red rocks by two important faults. Both Calcareous sandstone and Carboniferous limestone occur, with useful beds of coal, limestone, ironstone, fireclay and alum shale. An outlier of Carboniferous limestone, surrounded by Lower Old Red Sandstone, lies south of Linton. Much glacial boulder clay with gravel and sand rests upon the higher ground, while morainic deposits are found in the valleys.

Climate and Industries.—The annual rainfall averages from 33 to 41 in.; the mean temperature for the year is 47° F., for January 38° F., and for July 59° F. The character of the soil varies considerably, peat, gravel and clay being all represented. The low-lying lands consist generally of rich loam, composed of sand and clay. The farming is pastoral rather than arable. The average holding is about 200 acres of arable land, with pasturage for from 600 to 800 sheep. Roughly speaking, one-fifth of the total area is under cultivation. Oats are the chief grain and turnips the chief root crop. The hill pastures are better suited to sheep than to cattle, but both flocks and herds are comparatively large. Cheviots and half-breds are preferred for the grass lands, the heathery ranges being stocked with black-faced sheep. Crosses of Cheviots, black-faced and half-bred ewes with Leicestershire rams are common. The favourite breed of cattle is a cross between Ayrshires and shorthorns, the cows being Ayrshire. Many of the horses are Clydesdales bred in the county. Pig-keeping is on the decline. A few acres have been laid down as nurseries and market gardens, and about 10,000 acres are under wood, especially at Dalwick, where larch and horse-chestnut were first grown in Scotland. Apart from agriculture, the only industries are the woollen factories and flour mills at Peebles and Innerleithen.

The North British railway crosses the county in the north from Leadburn to Dolphinton, and runs down the Eddlestone valley from Leadburn to Peebles and Thornielee, while in the south the Caledonian railway connects the county town with Biggar in Lanarkshire.

Population and Administration.—In 1901 the population numbered 15,066 or 43 persons to the sq. m. In 1900 one person spoke Gaelic only, 73 Gaelic and English. The chief towns are Peebles (pop 5266) and Innerleithen (2181). West Linton, on Lyne Water, is a holiday resort. The shire combines with Selkirkshire to return one member to parliament, the electors of Peebles town voting with the county. Peebleshire forms a sheriffdom with the Lothians and a sheriff-substitute sits in the county town. There is a high school in Peebles, and one or more schools in the county usually earn grants for secondary education.

History.—The country was originally occupied by the Gadeni, a British tribe, of whom there are many remains in the shape of camps and sepulchral mounds (in which stone coffins, axes and hammers have been found), while several place-names (such as Peebles, Dalwick and Stobo) also attest their presence. The standing stones near the confluence of the Lyne and Tweed are supposed to commemorate a Cymric chief. The natives were reduced by the Romans, who have left traces of their military rule in the fine camp at Lyne, locally known as Randal's Walls.

The hill-side terraces at Romanno are conjectured, somewhat fancifully, to be remains of a Roman method of cultivation. On the retreat of the Romans the Gadeni came into their own again, and although they are said to have been defeated by King Arthur at Cademuir in 530, they held the district until the consolidation of the kingdom after Malcolm II.'s victory at Carham in 1018, before which the land, constantly harried by Danes, was nominally included in the territory of Northumbria. This tract of Scotland is closely associated with the legend of Merlin. David I. made the district a deanery in the archdeaconry of Peebles, and it afterwards formed part of the diocese of Glasgow. Towards the middle of the 12th century it was placed under the jurisdiction of two sheriffs; one of whom was settled at Traquair and the other at Peebles. At Happlew, in the valley of the Lyne, the English defeated Wallace in 1304. The Scottish sovereigns had a lodge at Polmoode, and often hunted in the uplands and the adjoining forests. English armies occasionally invaded the county, but more frequently the people were harried by Border raiders. Many castles and peels were erected in the valley of the Tweed from the Bield to Berwick. Several were renowned in their day, among them Oliver Castle (built by Sir Oliver Fraser in the reign of David I.), Drumelzier, Tinnis or Thane's Castle, and Neidpath. Three miles south of Romanno stand the ruins of Drochil Castle, designed for the Regent Morton who was beheaded at Edinburgh in 1581, and the building was never completed. Memories of the Covenanters cluster around Tweedhopefoot, Tweedsdaws, Corchead, Tweeds-muir, Talla Linn and other spots. In the churchyard of Tweeds-muir is the tombstone of John Hunter, the martyr, which was relettered by "Old Mortality." The "men of the moss hags" did little fighting in Peeblesshire, but Montrose first drew rein at Traquair House after he was defeated at Philiphaugh on the Yarrow in 1645. The plain of Sheriffmuir near Lyne is the place where the Tweeddale wapinschaws used to be held in the 17th century. The Jacobite risings left the county untouched, and since the beginning of the 19th century the shire has been more conspicuous in literature than in politics.

BIBLIOGRAPHY.—Pennecuik, *Description of Tweeddale* (1715); William Chambers, *History of Peeblesshire* (Edinburgh, 1864); Dr C. B. Gunn, *Innerleithen and Traquair* (Innerleithen, 1867); Sir George Reid, *The River Tweed from its Source to the Sea* (Text by Professor Veitch) (Edinburgh, 1884); Professor Veitch, *History and Poetry of the Scottish Border* (Edinburgh, 1893); *Border Essays* (Edinburgh, 1896); Rev W. S. Crockett, *The Scott Country* (Edinburgh, 1902).

PEEKSKILL, a village of Westchester county, New York, U.S.A., on the E. bank of the Hudson River, about 41 m. N. of New York City. Pop. (1910, census), 15,245. It is served by the New York Central & Hudson river railway, and by passenger and freight steamboat lines on the Hudson river. The village is the home of many New York business men. At Peekskill are the Peekskill military academy (1833, non-sectarian); St Mary's school, Mount St Gabriel (Protestant Episcopal), a school for girls established by the sisterhood of St Mary; the Field memorial library; St Joseph's home (Roman Catholic); the Peekskill hospital, and several sanatoria. Near the village is the state military camp, where the national guard of the state meets in annual encampment. Peekskill has many manufactures, and the factory products were valued in 1905 at \$7,251,897, an increase of 306.7% since 1900. The site was settled early in the 18th century, but the village itself dates from about 1760, when it took its present name from the adjacent creek or "kill," on which a Dutch trader, Jans Peck, of New York City, had established a trading post. During the latter part of the War of Independence Peekskill was an important outpost of the Continental Army, and in the neighbourhood several small engagements were fought between American and British scouting parties. The village was incorporated in 1816. Peekskill was the country home of Henry Ward Beecher.

PEEL, ARTHUR WELLESLEY PEEL, 1st Viscount (1820-), English statesman, youngest son of the great Sir Robert Peel, was born on the 3rd of August 1820, and was educated at Eton and Balliol College, Oxford. He unsuccessfully

contested Coventry in 1863; in 1865 he was elected in the liberal interest for Warwick, for which he sat until his elevation to the peerage. In December 1868 he was appointed parliamentary secretary to the poor law board. This office he filled until 1871, when he became secretary to the board of trade, an appointment which he held for two years. In 1873-1874 he was patronage secretary to the treasury, and in 1880 he became under-secretary for the home department. On the retirement of Mr Brand (afterwards Viscount Hampden) in 1884, Peel was elected Speaker. He was thrice re-elected to the post, twice in 1886, and again in 1892. Throughout his career as Speaker he exhibited conspicuous impartiality, combined with a perfect knowledge of the traditions, usages and forms of the house, soundness of judgment, and readiness of decision upon all occasions; and he will always rank as one of the greatest holders of this important office. On the 8th of April 1895 he announced that for reasons of health he was compelled to retire. The farewell ceremony was of a most impressive character, and warm tributes were paid from all parts of the house. He was created a viscount and granted a pension of £4000 for life. He was presented with the freedom of the City of London in July 1895. The public interest in the ex-Speaker's later life centred entirely in his somewhat controversial connexion with the drink traffic. A royal commission was appointed in April 1896 to inquire into the operation and administration of the licensing laws, and Viscount Peel was appointed chairman. In July 1898 Lord Peel drew up a draft report for discussion, in five parts. Some differences of opinion arose in connexion with the report, and at a meeting of the commissioners on the 12th of April 1899, when part 5 of the draft report was to be considered, a proposal was made to substitute an alternative draft for Lord Peel's, and also a series of alternative drafts for the four sections already discussed. Lord Peel declined to put these proposals, and left the room. Sir Algernon West was elected to the chair, and ultimately two main reports were presented, one section agreeing with Lord Peel, and the other—including the majority of the commissioners—presenting a report which differed from his in several important respects. The Peel report recommended that a large reduction in the number of licensed houses should be immediately effected, and that no compensation should be paid from the public rates or taxes, the money for this purpose being raised by an annual licence-rental levied on the rateable value of the licensed premises; it at once became a valuable weapon in the hands of advanced reformers.

Lord Peel married in 1862, and had four sons and two daughters (married to Mr J. Rochfort Maguire and to Mr C. S. Goldman). His eldest son, William Robert Wellesley Peel (b. 1866), married the daughter of Lord Ashton; he was Unionist M.P. for South Manchester from 1900 to 1905, and later for Taunton, and also acted as Municipal Reform leader on the London County Council.

PEEL, SIR ROBERT, BART. (1788-1850), English statesman, was born on the 5th of February 1788 at Chamber Hall, in the neighbourhood of Bury, Lancashire, or, less probably, at a cottage near the Hall. He was a scion of that new aristocracy of wealth which sprang from the rapid progress of mechanical discovery and manufactures in the latter part of the 18th century. His ancestors were Yorkshire yeomen in the district of Craven, whence they migrated to Blackburn in Lancashire. His grandfather, Robert Peel, first of Peel-fold, and afterwards of Brookside, near Blackburn, was a calico-printer, who, appreciating the discovery of his townsman Hargreaves, took to cotton-spinning with the spinning-jenny and grew a wealthy man. His father, Robert Peel (1750-1830), third son of the last-named, carried on the same business at Bury with still greater success, in partnership with his uncle, Mr Haworth, and Mr Yates, whose daughter, Ellen, he married. He made a princely fortune, became the owner of Drayton Manor and member of parliament for the neighbouring borough of Tamworth, was a trusted and honoured, as well as ardent, supporter of Pitt, contributed munificently towards the support of that leader's war policy, and was rewarded with a baronetcy (1800).

At Harrow, according to the accounts of his contemporaries, Peel was a steady industrious boy, the best scholar in the school, fonder of country walks with a friend than of school games, but reputed one of the best football players. At Christ Church, where he entered as a gentleman commoner, he was the first who, under the new examination statutes, took a first class both in classics and in mathematics. His examination for his B.A. degree in 1808 was an academical ovation in presence of a numerous audience, who came to hear the first man of the day. From his classical studies Robert Peel derived not only the classical, though somewhat pompous, character of his speeches and the Latin quotations with which they were often happily interspersed but something of his lofty ideal of political ambition. To his mathematical training, which was then not common among public men, he no doubt owed in part his method, his clearness, his great power of grasping steadily and working out difficult and complicated questions. His speeches show that, in addition to his academical knowledge, he was well versed in English literature, in history, and in the principles of law, in order to study which he entered at Lincoln's Inn. But while reading hard he did not neglect to develop his tall and vigorous frame, and, though he lost his life partly through his bad riding, he was always a good shot and an untiring walker after game. His Oxford education confirmed his attachment to the Church of England. His practical mind remained satisfied with the doctrines of his youth, and he never showed that he had studied the great religious controversies of his day.

In 1809, being then in his twenty-second year, he was brought into parliament for the close borough of Cashel, which he afterwards exchanged for Chippenham, and commenced his parliamentary career under the eye of his father, then member for Tamworth, who fondly saw in him the future leader of the Tory party. In that House of Commons sat Wilberforce, Windham, Tierney, Grattan, Perceval, Castlereagh, Plunkett, Romilly, Mackintosh, Burdett, Whitbread, Horner, Brougham, Parnell, Huskisson, and, above all, George Canning. Lord Palmerston entered the house two years earlier, and Lord John Russell three years later. Among these men young Peel had to rise. And he rose, not by splendid eloquence, by profound political philosophy or by great originality of thought, but by the closest attention to all his parliamentary duties, by a study of all the business of parliament, and by a style of speaking which owed its force not to high flights of oratory, but to knowledge of the subject in hand, clearness of exposition, close reasoning, and tact in dealing with a parliamentary audience. With the close of the struggle against revolutionary France, political progress in England was soon to resume the march which that struggle had arrested. Young Peel's lot, however, was cast, through his father, with the Tory party. In his maiden speech in 1810, seconding the address, he defended the Walcheren expedition, which he again vindicated soon afterwards against the report of Lord Porchester's committee. It is said that even then his father had discerned in him a tendency to think for himself, and told Lord Liverpool that to make sure of his support it would be well to place him early in harness. At all events he began official life in 1810 as Lord Liverpool's under-secretary for war and the colonies under the administration of Perceval. In 1812 he was transferred by Lord Liverpool to the more important but unhappy post of secretary for Ireland. There he was engaged till 1818 in maintaining English ascendancy over a country heaving with discontent, teeming with conspiracy, and ever ready to burst into rebellion. A middle course between Irish parties was impossible, and Peel plied the established engines of coercion and patronage with a vigorous hand. At the same time, it was his frequent duty to combat Grattan, Plunkett, Canning and the other movers and advocates of Roman Catholic emancipation in the House of Commons. He, however, always spoke on this question with a command of temper wonderful in hot youth, with the utmost courtesy towards his opponents, and with warm expressions of sympathy and even of admiration for the Irish people. He also, thus early, did his best to advocate and promote joint education in Ireland as a means of reconciling

sects and raising the character of the people. But his greatest service to Ireland as secretary was the institution of the regular Irish constabulary, nicknamed after him "Peelers," for the protection of life and property in a country where both were insecure. His moderation of tone did not save him from the violent abuse of O'Connell, whom he was ill advised enough to challenge—an affair which covered them both with ridicule. In 1817 he obtained the highest parliamentary distinction of the Tory party by being elected member for the university of Oxford—an honour for which he was chosen in preference to Canning on account of his hostility to Roman Catholic emancipation, Lord Eldon lending him his best support. In the following year he resigned the Irish secretaryship, of which he had long been very weary, and remained out of office till 1821. But he still supported the ministers, though in the affair of Queen Caroline he stood aloof, disapproving some steps taken by the government, and sensitive to popular opinion; and when Canning retired on account of this affair Peel declined Lord Liverpool's invitation to take the vacant place in the cabinet. During this break in his tenure of office he had some time for reflection, which there was enough in the aspect of the political world to move. But early office had done its work. It had given him excellent habits of business, great knowledge and a high position; but it had left him somewhat stiff and punctilious, too cold and reserved and over anxious for formal justifications when he might well have left his conduct to the judgment of men of honour and the heart of the people. At the same time he was no pedant in business; in corresponding on political subjects he loved to throw off official forms and communicate his views with the freedom of private correspondence; and where his confidence was given, it was given without reserve.

At this period he was made chairman of the bullion committee on the death of Horner. He was chosen for this important office by Huskisson, Ricardo and their fellow-economists, who saw in him a mind open to conviction, though he owed hereditary allegiance to Pitt's financial policy, and had actually voted with his Pittite father for a resolution of Lord Liverpool's government asserting that Bank of England notes were equivalent to legal coin. The choice proved judicious. Peel was converted to the currency doctrines of the economists, and proclaimed his conversion in a great speech on the 24th of May 1819, in which he moved and carried four resolutions embodying the recommendations of the bullion committee in favour of a return to cash payments. This laid the foundation of his financial reputation, and his co-operation with the economists tended to give a liberal turn to his commercial principles. In the course he took he somewhat diverged from his party, and particularly from his father, who remained faithful to Pitt's depreciated paper, and between whom and his schismatic son a solemn and touching passage occurred in the debate. The author of the Cash Payments Act had often to defend his policy, and he did so with vigour. The act is sometimes said to have been hard on debtors, including the nation as debtor, because it required debts to be paid in cash which had been contracted in depreciated paper; and Peel, as heir to a great fundholder, was even charged with being biased by his personal interests. But it is answered that the Bank Restriction Acts, under which the depreciated paper had circulated, themselves contained a provision for a return to cash payments six months after peace.

In 1820 Peel married Julia, daughter of General Sir John Floyd, who bore him five sons and two daughters. The writers who have most severely censured Sir Robert Peel as a public man have dwelt on the virtues and happiness of his private and domestic life. He was not only a most loving husband and father but a true and warm-hearted friend. In Whitehall Gardens or at Drayton Manor he gathered some of the most distinguished intellects of the day. He indulged in free and cheerful talk, and sought the conversation of men of science; he took delight in art, and was a great collector of pictures; he was fond of farming and agricultural improvements; he actively promoted useful works and the advancement of knowledge; he

loved making his friends, dependants, tenants and neighbours happy. And, cold as he was in public, few men could be more bright and genial in private than Sir Robert Peel.

In 1821 Peel consented to strengthen the enfeebled ministry of Lord Liverpool by becoming home secretary; and in that capacity he had again to undertake the office of coercing the growing discontent in Ireland, of which he remained the real administrator, and had again to lead in the House of Commons the opposition to the rising cause of Roman Catholic emancipation. In 1825, being defeated on the Roman Catholic question in the House of Commons, he wished to resign office, but Lord Liverpool pleaded that his resignation would break up the government. He found a congenial task in reforming and humanizing the criminal law, especially those parts of it which related to offences against property and offences punishable by death. The five acts in which Peel accomplished this great work, as well as the great speech of the 9th of March 1826, in which he opened the subject to the house, will form one of the most solid and enduring monuments of his fame. Criminal law reform was the reform of Romilly and Mackintosh, from the hands of the latter of whom Peel received it. But the mastery bills in which it was embodied were the bills of Peel—not himself a creative genius, but, like the founder of his house, a profound appreciator of other men's creations, and unrivalled in the power of giving them practical and complete effect.

In 1827 the Liverpool ministry was broken up by the fatal illness of its chief, and under the new premier, George Canning, Peel, like the duke of Wellington and other high Tory members of Lord Liverpool's cabinet, refused to serve. Canning and Peel were rivals; but we need not interpret as mere personal rivalry that which was certainly, in part at least, a real difference of connexion and opinion. Canning took a Liberal line, and was supported by many of the Whigs; the seceders were Tories, and it is difficult to see how their position in Canning's cabinet could have been otherwise than a false one. Separation led to public coolness and occasional approaches to bitterness on both sides in debate. But there seems no ground for exaggerated complaints against Peel's conduct. Canning himself said to a friend that "Peel was the only man who had behaved decently towards him." Their private intercourse remained uninterrupted to the end; and Canning's son afterwards entered public life under the auspices of Peel. The charge of having urged Roman Catholic emancipation on Lord Liverpool in 1825, and opposed Canning for being a friend to it in 1827, made against Sir Robert Peel in the fierce corn-law debates of 1846, has been withdrawn by those who made it.

In January 1828, after Canning's death, the duke of Wellington formed a Tory government, in which Peel was home secretary and leader of the House of Commons. This cabinet, Tory as it was, did not include the impracticable Lord Eldon, and did include Huskisson and three more friends of Canning. Its policy was to endeavour to stave off the growing demand for organic change by administrative reform, and by lightening the burdens of the people. The civil list was retrenched with an unsparring hand, the public expenditure was reduced lower than it had been since the Revolutionary war, and the import of corn was permitted under a sliding scale of duties. Peel also introduced into London the improved system of police which he had previously established with so much success in Ireland. But the tide ran too strong to be thus headed. First the government were compelled, after a defeat in the House of Commons, to acquiesce in the repeal of the Test and Corporation Acts, Peel bringing over their High Church supporters, as far as he could. Immediately afterwards the question of Roman Catholic emancipation was brought to a crisis by the election of O'Connell for the county of Clare. In August Peel expressed to the duke of Wellington his conviction that the question must be settled. He wrote that out of office he would co-operate in the settlement but in his judgment it should be committed to other hands than his. To this the duke assented, but in January 1829, owing to the declared opinions of the king, of the House of Lords, and of the Church against a change of policy, Wellington came to the

conclusion that without Peel's aid in office there was no prospect of success. Under that pressure Peel consented to remain, and all the cabinet approved. The consent of the king, which could scarcely have been obtained except by the duke and Peel, was extorted, withdrawn (the ministers being out for a few hours), and again extorted; and on the 5th of March 1829 Peel proposed Roman Catholic emancipation in a speech of more than four hours. The apostate was overwhelmed with obloquy. Having been elected for the university of Oxford as a leading opponent of the Roman Catholics, he had thought it right to resign his seat on being converted to emancipation. His friends put him again in nomination, but he was defeated by Sir R. H. Inglis. He took refuge in the close borough of Westbury, whence he afterwards removed to Tamworth, for which he sat till his death. Catholic emancipation was forced on Peel by circumstances; but it was mainly owing to him that the measure was complete, and based upon equality of civil rights. This great concession, however, did not save the Tory government. The French Revolution of July 1830 gave fresh strength to the movement against them, though, schooled by the past, they promptly recognized King Louis Philippe. The parliamentary reform movement was joined by some of their offended Protestant supporters. The duke of Wellington committed them fatally against all reform, and the elections went against them on the demise of the Crown; they were beaten on Sir H. Parnell's motion for a committee on the civil list, and Wellington took the opportunity to resign rather than deal with reform.

While in office, Peel succeeded to the baronetcy, Drayton Manor and a great estate by the death of his father (May 3, 1830). The old man had lived to see his fondest hopes fulfilled in the greatness of his son; but he had also lived to see that a father must not expect to fix his son's opinions—above all, the opinions of such a son as Sir Robert Peel, and in such an age as that which followed the French Revolution.

Sir Robert Peel's resistance to the Reform Bill won back for him the allegiance of his party. His opposition was resolute but it was temperate, and once only he betrayed the suppressed fire of his temper, in the historical debate of the 22nd of April 1831, when his speech was broken off by the arrival of the king to dissolve the parliament which had thrown out reform. He refused to join the duke of Wellington in the desperate enterprise of forming a Tory government at the height of the storm, when the Grey ministry had gone out on the refusal of the king to promise them an unlimited creation of peers. By this conduct he secured for his party the full benefit of the reaction which he no doubt knew was sure to ensue. The general election of 1832, after the passing of the Reform Bill, left him with barely 150 followers in the House of Commons; but this handful rapidly swelled under his management into the great Conservative party. He frankly accepted the Reform Act as irrevocable, taught his party to register instead of despairing, appealed to the intelligence of the middle classes, whose new-born power he appreciated, steadily supported the Whig ministers against the Radicals and O'Connell, and gained every moral advantage which the most dignified and constitutional tactics could afford. To this policy, and to the great parliamentary powers of his author, it was mainly due that, in the course of a few years, the Conservatives were as strong in the reformed parliament as the Tories had been in the unreformed. It is vain to deny the praise of genius to such a leader, though the skill of a pilot who steered for many years over such waters may sometimes have resembled craft. But the duke of Wellington's emphatic eulogy on him was, "Of all the men I ever knew, he had the greatest regard for truth." The duke might have added that his own question, "How is the king's government to be carried on in a reformed parliament?" was mainly solved by the temperate and constitutional policy of Sir Robert Peel, and by his personal influence on the debates and proceedings of the House of Commons during the years which followed the Reform Act.

In 1834, on the dismissal of the Melbourne ministry, power came to Sir Robert Peel before he expected or desired it. He hurried from Rome at the call of the duke of Wellington, whose

sagacious modesty yielded him the first place, and became prime minister, holding the two offices of first lord of the treasury and chancellor of the exchequer. He vainly sought to include in his cabinet two recent seceders from the Whigs, Lord Stanley and Sir James Graham. A dissolution gave him a great increase of strength in the house, but not enough. He was outvoted on the election of the speaker at the opening of the session of 1835, and, after struggling on for six weeks longer, resigned on that question of appropriating part of the revenues of the Church in Ireland to national education. His time had not yet come; but the capacity, energy and resource he displayed in this short tenure of office raised him immensely in the estimation of the house, his party and the country. Of the great budget of practical reforms which he brought forward, the plan for the commutation of tithes, the ecclesiastical commission, and the plan for settling the question of dissenters' marriages bore fruit.

From 1835 to 1840 he pursued the same course of patient and far-sighted opposition. In 1837 the Conservative members of the House of Commons gave their leader a grand banquet at Merchant Taylors' Hall, where he proclaimed in a great speech the creed and objects of his party. In 1839, the Whigs having resigned on the Jamaica Bill, he was called on to form a government, and submitted names for a cabinet, but resigned the commission owing to the young queen's persistent refusal to part with any Whig ladies of her bedchamber (see VICTORIA, QUEEN). In 1840 he was hurried into a premature motion of want of confidence. But in the following year a similar motion was carried by a majority of one, and the Whigs ventured to appeal to the country. The result was a majority of ninety-one against them on a motion of want of confidence in the autumn of 1841, upon which they resigned, and Sir Robert Peel became first lord of the treasury, with a commanding majority in both Houses of Parliament.

The crisis called for a master-hand. The finances were in disorder. For some years there had been a growing deficit, estimated for 1842 at more than two millions, and attempts to supply this by additions to assessed taxes and customs duties had failed. The great financier took till the spring of 1842 to mature his plans. He then boldly supplied the deficit by imposing an income-tax on all incomes above £150 a year. He accompanied this tax with a reform of the tariff, by which prohibitory duties were removed and other duties abated on a vast number of articles of import, especially the raw materials of manufactures and prime articles of food. The increased consumption, as the reformer expected, counterbalanced the reduction of duty. The income-tax was renewed and the reform of the tariff carried still farther on the same principle in 1845. The result was, in place of a deficit of upwards of two millions, a surplus of five millions in 1845, and the removal of seven millions and a half of taxes up to 1847, not only without loss, but with gain to the ordinary revenue of the country. The prosperous state of the finances and of public affairs also permitted a reduction of the interest on a portion of the national debt, giving a yearly saving at once of £625,000, and ultimately of a million and a quarter to the public. In 1844 another great financial measure, the Bank Charter Act, was passed and, though severely controverted and thrice suspended at a desperate crisis, has ever since regulated the currency of the country. In Ireland O'Connell's agitation for the repeal of the Union had now assumed threatening proportions, and verged upon rebellion. The great agitator was prosecuted, with his chief adherents, for conspiracy and sedition; and, though the conviction was quashed for informality, repeal was quelled in its chief. At the same time a healing hand was extended to Ireland. The Charitable Bequests Act gave Roman Catholics a share in the administration of charities and legal power to endow their own religion. The allowance to Maynooth was largely increased, notwithstanding violent Protestant opposition. Three queen's colleges, for the higher education of all the youth of Ireland, without distinction of religion, were founded, notwithstanding violent opposition, both Protestant and Roman Catholic. The principle of toleration once accepted, was thoroughly carried out. The last remnants of the penal laws

were swept from the statute-book, and justice was extended to the Roman Catholic Church in Canada and Malta. In the same spirit acts were passed for clearing from doubt Irish Presbyterian marriages, for settling the titles of a large number of dissenters' chapels in England, and removing the municipal disabilities of the Jews. The grant for national education was trebled, and an attempt was made, though in vain, to introduce effective education clauses into the factory bills. To the alienation of any part of the revenues of the Established Church Sir Robert Peel never would consent; but he had issued the ecclesiastical commission, and he now made better provision for a number of populous parishes by a redistribution of part of the revenues of the Church. The weakest part of the conduct of this great government, perhaps, was its failure to control the railway mania by promptly laying down the lines on a government plan. It passed an act in 1844 which gave the government a right of purchase, and it had prepared a palliative measure in 1846, but was compelled to sacrifice this, like all other secondary measures, to the repeal of the corn laws. It failed also, though not without an effort, to avert the great schism in the Church of Scotland. Abroad it was as prosperous as at home. It had found disaster and disgrace in Afghanistan. It speedily ended the war there, and in India the invading Sikhs were destroyed upon the Sutlej. The sore and dangerous questions with France, touching the right of search, the war in Morocco, and the Tahiti affair, and with the United States touching the Maine boundary and the Oregon territory, were settled by negotiation.

Yet there were malcontents in Sir Robert Peel's party. The Young Englanders disliked him because he had hoisted the flag of Conservatism instead of Toryism on the morrow of the Reform Bill. The strong philanthropists and Tory Chartists disliked him because he was a strict economist and an upholder of the new poor law. But the fatal question was protection. That question was being fast brought to a crisis by public opinion and the Anti-Corn-Law League. Sir Robert Peel had been recognized in 1841 by Cobden as a Free Trader, and after experience in office he had become in principle more and more so. Since his accession to power he had lowered the duties of the sliding scale, and thereby caused the secession from the cabinet of the duke of Buckingham. He had alarmed the farmers by admitting foreign cattle and meat under his new tariff, and by admitting Canadian corn. He had done his best in his speeches to put the maintenance of the corn laws on low ground, and to wean the landed interest from their reliance on protection. The approach of the Irish famine in 1845 turned decisively the wavering balance. When at first Sir Robert proposed to his cabinet the revision of the corn laws, Lord Stanley and the duke of Buccleuch dissented, and Sir Robert resigned. But Lord John Russell failed to form a new government. Sir Robert again came into office; and now, with the consent of all the cabinet but Lord Stanley, who retired, he, in a great speech on the 27th of January 1846, brought the repeal of the corn laws before the House of Commons. In the long and fierce debate that ensued he was assailed, both by political and personal enemies, with the most virulent invective, which he bore with his wonted calmness, and to which he made no retorts. His measure was carried; but immediately afterwards the offended protectionists, led by Lord George Bentinck and Benjamin Disraeli, coalesced with the Whigs, and threw him out on the Irish Coercion Bill. He went home from his defeat, escorted by a great crowd, who uncovered as he passed, and he immediately resigned. So fell a Conservative government which would otherwise have probably ended only with the life of its chief.

Though out of office he was not out of power. He had "lost a party, but won a nation." The Whig ministry which succeeded him lent much on his support, with which he never taxed them. He joined them in carrying forward free-trade principles by the repeal of the navigation laws. He helped them to promote the principle of religious liberty by the bill for the emancipation of the Jews. One important measure was his own. While in office he had probed, by the Devon commission of inquiry, the sores of Ireland connected with the ownership and occupation of

land. In 1849, in a speech on the Irish Poor Laws, he first suggested, and in the next year he aided in establishing, a commission to facilitate the sale of estates in a hopeless state of encumbrance. The Encumbered Estates Act made no attempt, like later legislation, to secure by law the uncertain customary rights of Irish tenants, but it transferred the land from ruined landlords to solvent owners capable of performing the duties of property towards the people. On the 28th of June 1850 Sir Robert Peel made a great speech on the Greek question against Lord Palmerston's foreign policy of interference. This speech was thought to show that if necessary he would return to office. It was his last. On the following day he was thrown from his horse on Constitution Hill, and mortally injured by the fall. Three days he lingered and on the fourth (July 2, 1850) he died. All the tributes which respect and gratitude could pay were paid to him by the sovereign, by parliament, by public men of all parties, by the country, by the press, and, above all, by the great towns and the masses of the people to whom he had given "bread unleavened with injustice." He would have been buried among the great men of England in Westminster Abbey, but his will desired that he might be laid in Drayton church. It also renounced a peerage for his family, as he had before declined the garter for himself when it was offered him by the queen through Lord Aberdeen.

Those who judge Sir Robert Peel will remember that he was bred a Tory in days when party was a religion; that he entered parliament a youth, was in office at twenty-four and secretary for Ireland at twenty-five; that his public life extended over a long period rife with change; and that his own changes were all forward and with the advancing intellect of the time. They will enumerate the great practical improvements and the great acts of legislative justice of those days, and note how large a share Sir Robert Peel had, if not in originating, in giving thorough practical effect to all. They will reflect that as a parliamentary statesman he could not govern without a party, and that it is difficult to govern at once for a party and for the whole people. They will think of his ardent love of his country, of his abstinence from intrigue, violence and faction, of his boundless labour through a long life devoted to the public service. Whether he was a model of statesmanship may be doubted. Models of statesmanship are rare, if by a model of statesmanship is meant a great administrator and party leader, a great political philosopher and a great independent orator, all in one. But if the question is whether he was a ruler loved and trusted by the English people there is no arguing against the tears of a nation.

Those who wish to know more of him will consult his own posthumous *Memoirs* (1856), edited by his literary executors Earl Stanhope and Viscount Cardwell; his private correspondence, edited by C. S. Parker (1891-1899); the four volumes of his speeches; a sketch of his life and character by Sir Lawrence Peel (1860); an historical sketch by Lord Dalling (1874); Guizot's *Sir Robert Peel* (1857); *Künzels Leben und Reden Sir Robert Peel's* (1851); *Disraeli's Life of Lord George Bentinck* (1858); *Morley's Life of Cobden*; monographs by F. C. Montague (1888), J. R. Thurstield (1891), and the earl of Rosebery (1899); *Peel and O'Connell*, by Lord Eversley; *The Life of Sir J. Graham* (1907), by C. S. Parker; *Lord Stanmore's Life of Lord Aberdeen* (1893); and the general histories of the time. (C. S. P.)

Four of Sir Robert's five sons attained distinction. The eldest, SIR ROBERT PEEL (1822-1895), who became the 3rd baronet on his father's death, was educated at Harrow and at Christ Church, Oxford. He was in the diplomatic service from 1844 to 1850, when he succeeded his father as member of parliament for Tamworth, and he was chief secretary to the lieutenant of Ireland from 1861 to 1865. He represented Tamworth until the general election of 1880; in 1884 he became member for Huntingdon and in 1885 for Blackburn, but after 1886 he ceased to sit in the House of Commons. Sir Robert described himself as a Liberal-Conservative, but in his later years he opposed the policy of Gladstone, although after 1886 he championed the cause of home rule for Ireland. In 1871 he sold his father's collection of pictures to the National Gallery for £75,000, and in his later life he was troubled by financial difficulties. Sir Robert was interested in racing, and was known on the

turf as Mr F. Robinson. He died in London on the 9th of May 1895, and was succeeded as 4th baronet by his son, Sir Robert Peel (b. 1867).

SIR FREDERICK PEEL (1823-1906), the prime minister's second son, was educated at Harrow and at Trinity College, Cambridge, becoming a barrister in 1849. He entered parliament in that year, and with the exception of the period between 1857 and 1859 he remained in the House of Commons until 1865. In 1851-1852 and again in 1853-1855 he was under-secretary for the colonies; from 1855 to 1857 he was under-secretary for war; and from 1859 to 1865 he was secretary to the treasury. He became a privy councillor in 1857 and was knighted in 1869. Sir Frederick Peel's chief service to the state was in connexion with the railway and canal commission. He was appointed a commissioner on the inception of this body in 1873, and was its president until its reconstruction in 1888, remaining a member of the commission until his death on the 6th of June 1906.

The third son was SIR WILLIAM PEEL (1824-1858), and the youngest VISCOUNT PEEL (q.v.). Sir William was a sailor, who distinguished himself in the Crimea, where he gained the Victoria Cross, and also during the Indian Mutiny, being wounded at the relief of Lucknow. He died on the 27th of April 1858. Sir William wrote *A Ride through the Nubian Desert* (1852), giving an account of his travels in 1851.

Two of Sir Robert Peel's brothers were also politicians of note. WILLIAM YATES PEEL (1789-1858), educated at Harrow and at St John's College, Cambridge, was a member of parliament from 1817 to 1837, and again from 1847 to 1852; he was under-secretary for home affairs in 1828, and was a lord of the treasury in 1830 and again in 1834-1835. JONATHAN PEEL (1799-1879) was first a soldier and then a member of parliament during the long period between 1826 and 1868, first representing Norwich and then Huntingdon. From 1841 to 1846 he was surveyor-general of the ordnance, and in 1858-1859 and again in 1866-1867 he was a very competent and successful secretary of state for war. General Peel was also an owner of racehorses, and in 1844 his horse Orlando won the Derby, after another horse, Running Rein, had been disqualified.

For the history of the Peel family see Jane Haworth, *A Memoir of the Family of Peel from the year 1600* (1836).

PEEL, a seaport and watering-place of the Isle of Man, on the W. coast, 11½ m. W.N.W. of Douglas by the Isle of Man railway. Pop. (1907), 3304. It lies on Peel Bay, at the mouth of the small river Neb, which forms the harbour. The old town consists of narrow streets and lanes, but a modern residential quarter has grown up to the east. On the west side of the river-mouth St Patrick's Isle is connected with the mainland by a causeway. It is occupied almost wholly by the ruins of Peel castle. St Patrick is said to have founded here the first church in Man, and a small chapel, dedicated to him, appears to date from the 8th or 10th century. There is a round tower, also of very early date, resembling in certain particulars the round towers of Ireland. The ruined cathedral of St German has a transitional Norman choir, with a very early crypt beneath, a nave with an early English triplet at the west end, transepts, and a low and massive central tower still standing. There are remains of the bishops' palace, of the so-called Fenella's tower, famous through Scott's *Peveril of the Peak*, of the palace of the Lords of Man, of the keep and guardroom above the entrance to the castle, and of the Moare or great tower, while the whole is surrounded by battlements. There are also a large artificial mound supposed to be a defensive earthwork of higher antiquity than the castle, and another mound known as the Giant's Grave. The guardroom is associated with the ghostly apparition of the Moddey Dhoo (black dog), to which reference is made in *Peveril of the Peak*. In 1307 Richard II. condemned the earl of Warwick to imprisonment in Peel Castle for conspiracy, and in 1444 Eleanor, duchess of Gloucester, received a like sentence on the ground of having compassed the death of Henry VI. by magic. Peel has a long-established fishing industry, which, however, has declined in modern times. In the town the most notable building is the church of St German, with a fine tower and spire. Peel was called by the Northmen *Hólen* (Island, i.e. St Patrick's Isle); the existing name is Celtic,

meaning "fort" (cf. the peel *tewens* of the borderland of England and Scotland).

PEEL. (1) The skin or rind of a fruit; thus "to peel" is to remove the outer covering of anything. The etymology of the word is closely connected with that of "pill," to plunder, surviving in "pillage." Both words are to be referred to French and thence to Latin. In French *peler* and *piller*, though now distinguished in meaning (the first used of stripping bark or rind, the second meaning to rob), were somewhat confused in application, and a similar confusion occurs in English till comparatively late. The Latin words from which they are derived are *pellis*, skin, and *pilare*, to strip of hair (*pilus*). (2) The name of a class of small fortified dwelling-houses built during the 16th century on the borders between Scotland and England. They are also known as "battel-houses," i.e. "bastille-houses," and consist of a square massive tower with high pitched roof, the lower part being vaulted, the upper part containing a few living rooms. The entrance is on the upper floor, access being gained by a movable ladder. The vaulted ground-floor chamber served for the cattle when there was danger of attack. The word appears in various forms, e.g. *pele*, *pell*, and Latinized as *pelum*, &c.; "pile" is also found used synonymously, but the *New English Dictionary* (s.v. *pile*) considers the two words distinct. It seems more probable that the word is to be identified with "pale," a stake (Lat. *palus*). The earlier meaning of "peel" is a palisaded enclosure used as an additional defence for a fortified post or as an independent stronghold.

PEELE, GEORGE (1558-*c.* 1598), English dramatist, was born in London in 1558. His father, who appears to have belonged to a Devonshire family, was clerk of Christ's Hospital, and wrote two treatises on book-keeping. George Peele was educated at Christ's Hospital, and entered Broadgates Hall (Pembroke College), Oxford, in 1571. In 1574 he removed to Christ Church, taking his B.A. degree in 1577, and proceeding M.A. in 1579. In 1579 the governors of Christ's Hospital requested their clerk to "discharge his house of his son, George Peele." It is not necessary to read into this anything more than that the governors insisted on his beginning to earn a livelihood. He went up to London about 1580, but in 1583 when Albertus Alasco (Albert Laski), a Polish nobleman, was entertained at Christ Church, Oxford, Peele was entrusted with the arrangement of two Latin plays by William Gager (*f.* 1580-1619) presented on the occasion. He was also complimented by Dr Gager for an English verse translation of one of the *Iphigenias* of Euripides. In 1585 he was employed to write the *Devise of the Pageant borne before Woolston Dixie*, and in 1591 he devised the pageant in honour of another lord mayor, Sir William Webbe. This was the *Descensus Astracae* (printed in the *Harleian Miscellany*, 1808), in which Queen Elizabeth is honoured as Astracae. Peele had married as early as 1583 a lady who brought him some property, which he speedily dissipated. Robert Greene, at the end of his *Great-worth of Wis*, exhorts Peele to repentance, saying that he has, like himself, "been driven to extreme shifts for a living." The sorry traditions of his reckless life were emphasized by the use of his name in connexion with the apocryphal *Morris concealed Jest* of George Peele (printed in 1607). Many of the stories had done service before, but there are personal touches that may be biographical. He died before 1598, for Francis Meres, writing in that year, speaks of his death in his *Palladis Tamia*.

His pastoral comedy of *The Araynement of Paris*, presented by the Children of the Chapel Royal before Queen Elizabeth perhaps as early as 1581, was printed anonymously in 1584. Charles Lamb, sending to Vincent Novello a song from this piece of Peele's, said that if it had been less uneven in execution Fletcher's *Faithful Shepherdess* "had been but a second name in this sort of writing." Peele shows considerable art in his flattery. Paris is arraigned before Jupiter for having assigned the apple to Venus. Diana, with whom the final decision rests, gives the apple to none of the competitors but to a nymph called Eliza, whose identity is confirmed by the further

explanation, "whom some Zabeta call." *The Famous Chronicle of King Edward the first, surnamed Edward Longshankes, with his returne from the holy land. Also the life of Llewellen, rebel in Wales. Lastly, the sinking of Queen Elinor, who suncke at Charingcross, and rose again at Potters-hill, now named Queenshith* (printed 1593). This "chronicle history," formless enough, as the rambling title shows, is nevertheless an advance on the old chronicle plays, and marks a step towards the Shakespearean historical drama. *The Ballet of Alcasar—with the death of Captaine Stukely* (acted 1588–1589, printed 1594), published anonymously, is attributed with much probability to Peele. *The Old Wives Tale*, registered in Stationers' Hall, perhaps more correctly, as "The Owld wives tale" (printed 1595), was followed by *The Love of King David and fair Bethsabe* (written c. 1588, printed 1599), which is notable as an example of Elizabethan drama drawn entirely from scriptural sources. Mr Fleay sees in it a political satire, and identifies Elizabeth and Leicester as David and Bathsheba, Mary Queen of Scots as Abesalom. *Sir Clyomon and Sir Clamydes* (printed 1599) has been attributed to Peele, but on insufficient grounds. Among his occasional poems are "The Honour of the Garter," which has a prologue containing Peele's judgments on his contemporaries, and "Polyhymnia" (1590), a blank-verse description of the ceremonies attending the retirement of the queen's champion, Sir Henry Lee. This is concluded by the "Sonnet," "His golden locks time hath to silver turn'd," quoted by Thackeray in the 76th chapter of *The Newcomes*. To the *Phoenix Nest* in 1593 he contributed "The Praise of Chastity." Mr F. G. Fleay (Biog. Chron. of the Drama) credits Peele with *The Wisdom of Doctor Doddipoll* (printed 1600), *Wily Beguiled* (printed 1606), *The Life and Death of Jack Straw, a notable rebel* (1587?), a share in the First and Second Parts of *Henry VI.*, and on the authority of Wood and Winstanley, *Alphonsus, Emperor of Germany*.

Peele belonged to the group of university scholars who, in Greene's phrase, "spent their wits in making plays." Greene went on to say that he was "in some things rarer, in nothing inferior," to Marlowe. Nashe in his preface to Greene's *Menaphon* called him "the chief supporter of pleasance now living, the *Atlas* of Poetrie and *primus verborum artifex*, whose first increase, the *Arraignement of Paris*, might plead to your opinions his pregnant dexterity of wit and manifold varietie of invention, wherein (*me iudice*) hee goeth a step beyond all that write." This praise was not unfounded. The credit given to Greene and Marlowe for the increased dignity of English dramatic diction, and for the new smoothness infused into blank verse, must certainly be shared by Peele. Professor F. B. Gummere, in a critical essay prefixed to his edition of *The Old Wives Tale*, puts in another claim for Peele. In the contrast between the romantic story and the realistic dialogue he sees the first instance of humour quite foreign to the comic "business" of earlier comedy. *The Old Wives Tale* is a play within a play, slight enough to be perhaps better described as an interlude. Its background of rustic folk-lore gives it additional interest, and there is much fun poked at Gabriel Harvey and Stanyhurst. Perhaps Huanebango,¹ who parodies Harvey's hexameters, and actually quotes him on one occasion, may be regarded as representing that arch-enemy of Greene and his friends.

Peele's Works were edited by Alexander Dyce (1828, 1829–1839 and 1861); by A. H. Bullen (2 vols., 1888). An examination of the metrical peculiarities of his work is to be found in F. A. R. Lämmerhirt's *Georg Peele. Untersuchungen über sein Leben und seine Werke* (Rostock, 1882). See also Professor F. B. Gummere, in *Representative English Comedies* (1903); and an edition of *The Ballet of Alcasar*, printed for the Malone Society in 1907.

PEEP-OF-DAY BOYS, an Irish Protestant secret society, formed about 1785. Its object was to protect the Protestant peasantry, and avenge their wrongs on the Roman Catholics. The "Boys" gained their name from the hour of dawn which

¹ Mr Fleay goes so far as to use in the preposterous names of Huanebango's kith and kin puns on Harvey's father's trade. "Polymachaeroplacidus" he interprets as "Polly-make-a-rope-lane"!

they chose for their raids on the Roman Catholic villages. The Roman Catholics in return formed the society of "The Defenders."

PEEPUL, or **PIPIUL** (*Ficus religiosa*), the "sacred fig" tree of India, also called the Bo tree. It is not unlike the banyan, and is venerated both by the Buddhists of Ceylon and the Vaishnavite Hindus, who say that Vishnu was born beneath its shade. It is planted near temples and houses; its sap abounds in caoutchouc, and a good deal of lac is obtained from insects who feed upon the branches. The fruit is about the size of a walnut and is not much eaten.

PEERAGE (Fr. *pairage*, med. Lat. *paragium*; M.E. *pere*, O. Fr. *per*, *peer*, later *pair*; Lat. *paris*, "equal"). Although in England the terms "peerage," "nobility," "House of Lords" are in common parlance frequently regarded as synonymous, in reality each expresses a different meaning. A man may be a peer and yet not a member of the House of Lords, a member of the House of Lords and yet not strictly a peer; though all peers (as the term is now understood) are members of the House of Lords either *in esse* or *in posse*. In the United Kingdom the rights, duties and privileges of peerage are centred in an individual; to the monarchical nations of the Continent nobility conveys the idea of family, as opposed to personal, privilege.

Etymologically "peers" are "equals" (*paris*), and in Anglo-Norman days the word was invariably so understood. The feudal tenants-in-chief of the Crown were all the peers of each other, whether lords of one manor or of a hundred; so too a bishop had his ecclesiastical peer in a brother bishop, and the tenants of a manor their peers in their fellow-tenants. That even so late as the reign of John the word was still used in this general sense is clear from Magna Carta, for the term "*judicium parium*" therein must be understood to mean that every man had a right to be tried by his equals. This very right was asserted by the barons as a body in 1233 on behalf of Richard, earl marshal, who had been declared a traitor by the king's command, and whose lands were forfeited without proper trial. In 1233 the French bishop Peter des Roches, Henry III.'s minister, denied the barons' right to the claim set up on the ground that the king might judge all his subjects alike, there being, he said, no peers in England (Math. Paris. 380). The English barons undoubtedly were using the word in the sense it held in Magna Carta, while the bishop probably had in his mind the French peers (*pairs de France*), a small and select body of feudatories possessed of exceptional privileges. In England the term was general, in France technical. The change in England was gradual, and probably gathered force as the gulf between the greater barons and the lesser widened, until in course of time, for judicial purposes, there came to be only two classes, the greater barons and the rest of the people. The barons remained triable by their own order (*i.e.* by their peers), whilst the rest of the people rapidly became subject to the general practice and procedure of the king's justices. The first use of the word "peers" as denoting those members of the baronage who were accustomed to receive regularly a writ of summons to parliament is found in the record of the proceedings against the Despensers in 1312 (Stubbs, *Const. Hist.* ii. 347), and from that time this restricted use of the word has remained its ordinary sense.

Properly to understand the growth and constitution of the peerage it is necessary to trace the changes which occurred in the position of the Anglo-Norman baronage, first through the gradual strengthening of royal supremacy with the consequent decay of baronial power locally, and subsequently by the consolidation of parliamentary institutions during the reigns of the first three Edwards.

Before the conquest the national assembly of England (see **PARLIAMENT**) was the Witan, a gathering of nobles owing their presence only to personal influence and standing. The Saracens The imposition of a modified feudal system resulted *Witan-* in a radical alteration. Membership of the Great *Sumet.* Councils of the Norman kings was primarily an incident of

Origin of Peerage.

Anglo-Norman Baronage.

tenure, one of the obligations the tenants-in-chief were bound to perform, although this membership gradually became restricted by the operation of the Royal prerogative to a small section of the Baronial class and eventually hereditary by custom. The Norman Councils may have arisen from the ashes of a Saxon Witenagemot, but there is little evidence of any historical continuity between the two. The Church in England, as in Christendom generally, occupied a position of paramount importance and far-reaching influence; its leaders, not alone from their special sanctity as ecclesiastics, but as practically the only educated men of the period, of necessity were among the chief advisers of every ruler in Western Europe. In England churchmen formed a large proportion of the Witan, the more influential of the great landowners making up the rest of its membership.

In place of the scattered individual and absolute ownership of Saxon days the Conqueror became practically the sole Norman owner of the soil. The change, though not immediately complete, followed rapidly as the country settled down and the power of the Crown extended to its outlying frontiers. As Saxon land gradually passed into Norman hands the new owners became direct tenants of the king. Provided their loyal and military obligations were duly performed they had fixity of tenure for themselves and their heirs. In addition fixed money payments were exacted on the succession of the heir, when the king's eldest son was knighted, his eldest daughter married, or his person ransomed from captivity. In like manner and under similar conditions the king's tenants, or as they were termed tenants-in-chief, sub-granted the greater portion of their holdings to their own immediate followers. Under Norman methods the manor was the unit of local government and jurisdiction, and when land was given away by the king the gift invariably took the form of a grant of one or more manors.

When he brought England into subjection the Conqueror's main idea was to exalt the central power of the Crown at the expense of its feudatories, and the first two centuries following the conquest tell one long tale of opposition by the great tenants-in-chief to a steadily growing and unifying royal pressure. With this idea of royal supremacy firmly fixed in his mind, William's grants, excepting outlying territory such as the marches of Wales or the debateable ground of the Scottish border, which needed special consideration, were seldom in bulk, but took the form of manors scattered over many counties. Under such conditions it was practically impossible for a great tenant to set up a powerful *imperium in imperio* (such as the fiefs of Normandy, Brittany and Burgundy), as his forces were distributed over the country, and could be reached by the long arm of royal power, acting through the sheriff of every county, long before they could effectively come together for fighting purposes. The tenants-in-chief were termed generally barons (see *BARON*) and may be regarded historically as the parents of the peers of later days. The pages of Domesday (1086), the early Norman fiscal record of England, show how unevenly the land was distributed; of the fifteen hundred odd tenants mentioned the majority held but two or three manors, while a favoured few possessed more than a hundred each. Land was then the only source of wealth, and the number of a baron's manors might well be regarded as a correct index of his importance.

The king's tenants owed yet another duty, the service of attending the King's Court (*curia regis*), and out of this custom grew the parliaments of later days. In theory all the king's tenants-in-chief, great and small, had a right to be present as incident to their tenure.

It has therefore been argued by some authorities that as the Conqueror's system of tenure constituted him the sole owner of the land, attendance at his courts was solely an incident of tenure, the Church having been compelled to accept the same conditions as those imposed on laymen. But, as already pointed out, the change in tenure had not been immediate, and there had been no general forfeiture suffered by ecclesiastical bodies;

consequently throughout the early years of William's reign some of the English bishops and abbots attended his courts as much by virtue of their personal and ecclesiastical importance as by-right of tenure. The King's Court was held regularly at the three great festivals of the Church and at such other times as were deemed advisable. The assembly for several generations neither possessed nor pretended to any legislative powers. Legislative power was a product of later years, and grew out of the custom of the Estates granting supplies only on condition that their grievances were first redressed. The great bulk of the tenants were present for the purpose of assenting to special taxation above and beyond their ordinary feudal dues. When necessary a general summons to attend was sent through the sheriff of every county, who controlled a system of local government which enabled him to reach every tenant. In course of time to a certain number of barons and high ecclesiastics, either from the great extent of their possessions, their official duties about the king or their personal importance, it became customary to issue a personal writ of summons, thus distinguishing them from the general mass summoned through the sheriff. That this custom was in being within a century of the Conquest is clear from an incident in the bitter fight for supremacy between Archbishop Becket and Henry II. in 1164 (Stubbs, *Const. Hist.* i. 504), it being recorded that the king withheld the Archbishop's personal summons to parliament, and put upon him the indignity of a summons through the sheriff. During the succeeding fifty years the line becomes even more definite, though it is evident that the Crown sometimes disregarded the custom, as the barons are found complaining that many of their number deemed entitled to a personal summons had frequently been overlooked.

The sequel to these complaints is found in Magna Carta, wherein it is provided that the archbishops, bishops, abbots, earls and greater barons are to be called up to the council by writ directed to each severally; and all who hold of the king in chief, below the rank of the greater barons, are to be summoned by a general writ addressed to the sheriff of their shire.¹ Magna Carta thus indicates the existence of two definite sections of the king's tenants, a division which had evidently persisted for some time. The "greater barons" are the immediate parents of the peerages of later days, every member of which for more than four centuries had a seat in the House of Lords. As for the rest of the tenants-in-chief, poorer in estate and therefore of less consequence, it is sufficient here to note that they fell back into the general mass of country families, and that their representatives, the knights of the shire, after some hesitation, at length joined forces with the city and burgher representatives to form the House of Commons.

In 1254, instead of the general summons through the sheriff to all the lesser tenants-in-chief, the king requires them to elect two knights for each shire to attend the council as the accredited representative of their fellows. In the closing days of 1264 Simon de Montfort summoned to meet him early in 1265 the first parliament worthy of the name, a council in which prelates, earls and greater barons, knights of the shire, citizens and burghers were present, thus constituting a representation of all classes of people. It has been argued that this assembly cannot be regarded as a full parliament, inasmuch as Simon de Montfort summoned personally only such members of the baronage as were favourable to his cause, and issued writs generally only to those counties and cities upon which he could rely to return representatives in support of his policy. Stubbs holds the view that the first assembly we ought to regard as a full parliament was the Model Parliament which met at Westminster in 1295. This parliament, unlike Simon's partisan assembly of 1265, was free and representative. To every spiritual

¹ Et ab habendum commune consilium regni . . . summoneri faciemus archiepiscopos, episcopos, abbates, comites et majores barones sigillatim per litteras nostras et praeterea faciemus summoneri in generali per vicecomes et ballivos nostros omnes illos qui de nobis tenent in capite (cited in Stubbs, *Const. Hist.* i. 547 n.).

and temporal baron accustomed to receive an individual writ, one was issued. Every county elected its knights and every city or borough of any importance was instructed by the sheriff to elect and to return its allotted number of representatives. Stubbs's view (*Const. Hist.* ii. 223) may probably be regarded as authoritative, inasmuch as it was adopted by Lord Ashbourne in the Norfolk peerage case of 1906 (*Law Reports* [1907], A.C. at p. 15). Edward I. held frequent parliaments throughout his reign, and although many must be regarded as merely baronial councils, nevertheless year after year, on all important occasions, the knights of the shire and the citizens appear in their places. The parliament of Shrewsbury in 1283, for instance, has been claimed as a full parliament in several peerage cases, but no clear decision on the point has ever been given by the Committee for Privileges. It may be taken for granted, however, that any assembly held since 1295, which did not conform substantially to the model of that year, cannot be regarded constitutionally as a full parliament. The point is even of modern importance, as in order to establish the existence of a barony by writ it must be proved that the claimant's ancestor was summoned by individual writ to a full parliament, and that either he himself or one of his direct descendants was present in parliament.

It is now convenient to consider the various grades into which the members of the peerage are grouped, and their relative positions. An examination of the early writs issued to individuals shows that the baronage consisted of archbishops, bishops, abbots, priors, earls and barons. In course of time every member of these classes came to hold his land by feudal tenure from the Crown, and eventually in every instance the writs issued as an incident of tenure. It is therefore necessary to discover, if possible, what combination of attributes clothed the greater baron with a right to receive the king's personal writ of summons. While the archbishops and bishops received their writs with regularity, the summonses to heads of ecclesiastical houses and greater barons were intermittent. The prelate held an office which lived on regardless of the fate of its temporary holder, and if by reason of death, absence or translation the office became vacant, a writ still issued to the "Guardian of the Spiritualities." The abbot, on the other hand, often outside the jurisdiction of the English Church, and owing allegiance to a foreign order, was but the personal representative of a land-holding community. It has already been pointed out that the amount of land held direct from the king by individuals varied greatly, and that the extent of his holding must have had something to do with a man's importance. A landless noble in those days was inconceivable. The conclusion, then, may be drawn that in theory the issue of a writ was at the pleasure of the Crown, and that in practice the moving factor in the case of the prelates was office and personal importance, and in the case of abbots and barons probably, in the main, extent of possession. There is nothing however to show that in the early years of the custom any person had a right to claim a writ if it were the king's pleasure or caprice to withhold it and to treat everyone not summoned individually as being duly summoned under the general writs issued to the sheriff of the county.

The next point for consideration is when did the peerage, as the baronage subsequently came to be called, develop into a body definitely hereditary? Here again growth was gradual and somewhat obscure. Throughout the reigns of the Edwards summonses were not always issued to the same individual for successive parliaments; and it is quite certain that the king never considered the issue of one writ to an individual bound the Crown to its repetition for the rest of his life, much less to his heirs in perpetuity. Again we must look to tenure for an explanation. The custom of primogeniture tended to secure estates in strict family succession, and if extent of possession had originally extracted the acknowledgment of a personal summons from the Crown it is more than probable that as successive heirs came into their inheritance they too would similarly be acknowledged. In

early days the summons was a burden to be suffered of necessity, an unpleasant incident of tenure, in itself undesirable, and probably so regarded by the majority of recipients during at least the two centuries following the Conquest. The age of the Edwards was in the main a rule of settled law, of increase in population generally, of growing power in the large landowners and of opportunities for those about the person of the king. The times were changing, and in place of the idea of the writ being a burden, its receipt gradually came to be looked upon as a mark of royal favour, a recognition of position and an opportunity leading on to fortune. Once such a view was established it is easy to understand how desirous any individual would be to preserve so valuable a privilege for his posterity; and primogeniture with its strict settlement of estates pointed out an easy way. The Crown was itself an hereditary dignity; and what more natural than that it should be surrounded by an hereditary peerage? Thus the free and indiscriminate choice of the Crown became fettered by the custom that once a summons had been issued to an individual to sit in parliament and he had obeyed that summons he thereby acquired a right of summons for the rest of his lifetime; and in later years when the doctrine of nobility of blood became established his descendants were held to have acquired the same privilege by hereditary right.

The earl's position in the baronage needs some explanation. Various suggestions have been made as to Saxon or Norman origin of a high official nature, but historical opinion seems generally to incline towards the theory that the term was a name of dignity conferred by royal prerogative on a person already classed among the greater barons. At first the dignity was official and certainly not hereditary, and the name of a county of which he is said to have been an officer in the king's name was not essential to his dignity as an earl. There were also men who, though Scottish and Norman earls, and commonly so addressed and summoned to parliament, were rated in England as barons (*Lords Reports*, ii. 116, 120; *Earldom of Norfolk Peerage Case*, *Law Reports* [1907], A.C. p. 18). Earls received individual summonses to parliament by the name of Earl (*q.v.*); but there is reason to believe, as already mentioned, that in early days at any rate they sat not in right of their earldoms but by tenure as members of the baronage.

If we review the political situation at the beginning of the 14th century a great change is evident. The line between those members of the baronage in parliament and the rest of the people is firmly and clearly drawn. Tenure as the sole qualification for presence in the national assembly has disappeared, and in its place there appears for the baronage a system of royal selection and for the rest of the people one of representation. The rules and customs of law relating to the baronage slowly crystallized so as to provide the House of Lords, the history of which for generations is the history of the peerage of England, whilst the representative part of parliament, after shedding the lower clergy, ultimately became the House of Commons.

Until the reign of Richard II. there is no trace of any use of the term baron (*q.v.*) as importing a personal dignity existing apart from the tenure of land, barons owing their seats in parliament to tenure and writ combined. This is borne out by the fact that a husband was often summoned to parliament in his wife's right and name, and while she lived fulfilled those feudal, military and parliamentary obligations attached to her lands which the physical disabilities of sex prevented her from carrying out in her own person (*Pike, House of Lords*, p. 103).

Primogeniture, a custom somewhat uncertain in early Anglo-Norman days, had rapidly developed into a definite rule of law. As feudal dignities were in their origin inseparable from the tenure of land it is not surprising that they too followed a similar course of descent, although as the idea of a dignity being exclusively personal gradually emerged, some necessary deviations from the rules of law relating to the descent of land inevitably resulted. In the eleventh year of his reign Richard II. created by letters patent

John Beauchamp "Lord de Beauchamp and baron of Kyddermynster, to hold to him and the heirs of his body." These letters patent were not founded on any right by tenure of land possessed by Beauchamp, for the king makes him "for his good services and in respect of the place which he had holden at the coronation (*i.e.* steward of the household) and might in future hold in the king's councils and parliaments, and for his noble descent, and his abilities and discretion, one of the peers and barons of the kingdom of England; willing that the said John and the heirs-male of his body issuing, should have the state of baron and should be called by the name of Lord de Beauchamp and Baron of Kyddermynster." The grant rested wholly on the grace and favour of the Crown and was a personal reward for services rendered. Here then is a barony entirely a personal dignity and quite unconnected with land. From Richard's reign to the present day baronies (and indeed all other peerage honours) have continued to be conferred by patent. The custom of summons by writ was not in any way interfered with, the patent operating merely to declare the dignity and to define its devolution. Summons alone still continued side by side for many generations with summons founded on patent; but after the reign of Henry VIII. the former method fell into disuse, and during the last two hundred and fifty years there have been no new creations by writ of summons alone.¹ So from the reign of Richard II. barons were of two classes, the older, and more ancient in lineage summoned by writ alone, the honours descending to heirs-general, and the newer created by letters patent, the terms of which governed the issue of the summons and prescribed the devolution of the peerage in the line almost invariably of the direct male descendants of the person first ennobled. The principle of hereditary succession so clearly recognized in the Beauchamp creation is good evidence to show that a prescriptive right of hereditary summons probably existed in those families whose members had long been accustomed to receive individual writs. By the time the House of Lancaster was firmly seated on the throne it may be taken that the peerage had become a body of men possessing well-defined personal privileges and holding personal dignities capable of descending to their heirs.

The early origin of peerages was so closely connected with the tenure of land that the idea long prevailed that there were originally peerages by tenure only, *i.e.* dignities or titles annexed to the possession (and so following it on alienation) of certain lands held in chief of the king. The older writers, Glanville (bk. ix. cc. 4, 6) and Bracton (bk. ii. c. 16), lend some colour to the view. They are followed, not very definitely, by Coke, Selden and Madox. Blackstone, who discusses the question in his *Commentaries* (bk. i. c. xii.), seems to believe that such dignities existed in pre-parliamentary days but says further: "When alienations grew to be frequent, the dignity of peerage was confined to the lineage of the party ennobled, and instead of territorial became personal." The Earldom of Arundel case, in 1433, at first sight seems to confirm the theory, but it may be noted that when in later years this descent came to be discussed the high authority of an act of parliament was found necessary to confirm the succession to the dignity. The case is discussed at some length in the *Lords Reports* (ii. 115), the committee regarding it as an anomaly from which no useful precedent can be drawn. Other cases discussed in the same *Report* are those of De Lisle, Abergavenny, Fitzwalter and Berkeley. The Berkeley case of 1858-1861 (better reported 8 H.L.C. 21) is essential for the student who wishes to examine the question carefully; and may be regarded as finally putting an end to any idea of bare tenure as an existing means of establishing a peerage right (see also Cruise on *Dignities*, 2nd ed. pp. 60 et seq.).

The main attribute of a peerage is that hereditary and inalienable. Not intentional at any rate. In some cases where it was intended to call a son up in his father's barony, a mistake in the name has been made with the result that a new peerage by writ of summons has been created. The barony of Buller, of Moore Park (cr. 1663), now in abeyance, is said to be an instance of such a mistake.

able quality which ennobles the blood of the holder and his heirs, or, as a great judge put it in 1625 in the Earldom of Oxford case, "he cannot alien or give away this inheritance because it is a personal dignity annexed to the posterity and fixed in the blood" (Dodridge, J., at p. 123, Sir W. Jones's *Reports*). Were the theory of barony by tenure accepted it would be possible for the temporary holder of such a barony to sell it or even to will it away to a stranger possessing none of the holder's blood, with the effect that, in the words of Lord Chancellor Campbell (Berkeley case, 8 H.L.C. 77), "there might be various individuals and various lines of peers successively ennobled and created peers of parliament by a subject," an impossible condition of affairs in a country where the sovereign has always been the fountain of honour. Moreover, while no peerage honour can be extinguished or surrendered, the owner of lands can freely dispose of such rights as he possesses by sale or transfer. Finally we may accept the verdict in the Fitzwalter case of 1669 (Cruise, *ibid.* p. 66), which was adopted by the House of Lords in the Berkeley case: "and the nature of a barony by tenure being discussed, it was found to have been discontinued for many ages, and not in being, and so not fit to be revived or to admit any pretence or right of succession thereupon."

Until the reign of Edward III. the peerage consisted only of high ecclesiastics, earls and barons. The earls were barons with their special name of dignity added, and their names always appear on the rolls before those of the barons. In 1337 King Edward created his son, the Black Prince, duke of Cornwall, giving him precedence over the rest of the peerage. The letters patent (under which the present heir to the throne now holds the dukedom) limited the dignity in perpetuity to the first-born son of the king of England.² Subsequently several members of the royal family were created dukes, but no subject received such an honour until fifty years later, when Richard II. created his favourite Robert de Vere, earl of Oxford, duke of Ireland (for life). The original intention may have been to confine the dignity to the blood royal, as with the exception of de Vere it was some years before a dukedom was again conferred on a subject.

In 1385 Richard II. had created Robert de Vere marquess of Dublin, thus importing an entirely new and unknown title into the peerage. The grant was, however, only for life, and was in fact resumed by the Crown in 1387, when its recipient was created duke of Ireland. It was not until 1397 that another creation was made, this time in favour of one of the blood royal, John de Beaufort, eldest legitimated son of John of Gaunt, who became marquess of Dorset. His title was shortly afterwards taken away by Henry IV.'s first parliament. Subsequently creations were made only at long intervals, that of Winchester (1551) being the only one (of old date) under which an English marquess at present sits in the House of Lords (see MARQUESS).

Under the name of viscount (*q.v.*) Henry VI. added yet another order, and the last in point of time, to the peerage, creating in 1440, John, Baron Beaumont, Viscount Beaumont and giving him precedence next above the barons. The name of this dignity was also borrowed from the Continent, having been in use for some time as a title of honour in the king's French possessions. None of the new titles above mentioned ever carried with them any official position; they were conferred originally as additional honours on men who were already members of the peerage.

The application of the hereditary principle to temporal peerages early differentiated their holders from the spiritual peers. Both spiritual and temporal peers were equally lords of parliament, but hereditary pretensions on the one side and ecclesiastical exclusiveness on the other soon drew a sharp line of division between the two orders. Gradually the temporal peers, strong in their doctrine of "ennobled" blood, came to consider that theirs was an order

² . . . principi et ipsius et haereditum suorum Regum Anglie filii primogenitiis (*The Prince's Case*, 8 Co. Rep. 27a; 77 E.R. 513).

above and beyond all other lords of parliament, and before long, arrogated to themselves the exclusive right to be called peers, and as such the only persons entitled to the privileges of peerage.

In early parliamentary days it had been the custom to summon regularly to attend the Lords for deliberative purposes another body of men—the judges. Less important than the prelates, they also owed their summons to official position, and like them were eventually overshadowed by the hereditary principle. The force of hereditary right gave to ennobled blood a position never possessed by either judge or prelate. It is true the prelate, in point of antiquity, was senior to both earl and baron, and in many cases superior in extent of possessions; but these attributes belonged to his office, the resignation or deprivation of which would at any time have caused him to lose his writ of summons. The writ issued really to the office. The judge's position was even worse. His judicial office evoked the writ, but at any moment he might be deprived of that office at the arbitrary pleasure of the Crown. It is doubtful whether the judges ever had voice and vote in the same sense as the other lords of parliament, and even if they had they soon came to be regarded merely as counsellors and assessors.

The pretensions of the lay-peers were not admitted without a struggle on the part of the prelates, who made the mistake of aiming at the establishment of a privileged position for their own order while endeavouring to retain every right possessed by their lay brethren. They fell between two stools, lost their position as peers, and were beaten back in their fight for ecclesiastical privilege. In the reign of Richard II. the prelates are found clearly defining their position. Neville, archbishop of York, de Vere, duke of Ireland and others, were "appealed" for treason, and the archbishop of Canterbury took the opportunity in parliament of making clear the rights of his order. He said "of right and by the custom of the realm of England it belongeth to the Archbishop of Canterbury for the time being as well as others his suffragans, brethren and fellow bishops, abbots and priors and other prelates whatsoever, holding of our lord the king by barony, to be present in person in all the king's parliaments whatsoever as Peers of the Realm aforesaid, and there with the other Peers of the Realm, and with other persons having the right to be there present, to advise, treat, ordain, establish and determine as to the affairs of the realm and other matters there wont to be treated and to do all else which there presses to be done." After this he went on to say that as to the particular matters in question they intended to be present and to take their part in all matters brought before parliament "save our estate and order and that of each of the prelates in all things. But because in the present parliament there is question of certain matters, in which it is not lawful for us or anyone of the prelates according to the institute of the Holy Canons in any manner, to take part personally" we intend to retire "saving always the rights of our peerage" (*Rot. Parl.* 11 Rich. II. No. 6—printed iii. 236—237). At the desire of the prelates this statement of their rights was duly enrolled in parliament, but their claim to be peers was neither denied nor admitted, and the proceedings went on without them. For themselves Churchmen never claimed the privilege of trial by peers. Whenever they were arraigned they claimed to be altogether outside secular jurisdiction, and it was therefore a matter of small concern to them whether they were in the hands of peers or peasants. Such was the attitude of Becket towards Henry II. (Stubbs, *Const. Hist.* i. 304), of Archbishop Stratford towards Edward III. (Pike, pp. 188 seq.), and it was probably with the history of these two cases in his mind that the archbishop of Richard II.'s reign speaks of the saving rights of his order. These rights were never willingly admitted in England, and as the pope's power for interference waned so the prelates were forced under the ordinary law of the land. Henry VIII. certainly never regarded ecclesiastics as peers, as may be gathered from a grant early in his reign to the then abbot of Tavistock for himself and each succeeding abbot the right to be "one of the spiritual and religious lords of parliament." As to abbots, the subsequent dissolution of the monasteries put an end to the

discussion. In this reign also Cramer and Fisher, though the former was archbishop of Canterbury, were tried by a common jury, and they certainly claimed no privilege of peerage. The Standing Orders of the House of Lords for 1625 contain the statement that "Bishops are only Lords of Parliament and not Peers" (*Lords Journals*, iii. 349). In 1640 the "Lords Spiritual" were altogether excluded from the House of Lords by act of parliament, and were not brought back until the second year of the Restoration. From that period there has been no question as to their position. Peers and holders by barony when parliaments first met, by the end of the 15th century they had put themselves outside the pale of the peerage. To-day their ancient lands are vested in trustees (Ecclesiastical Commissioners), and office alone constitutes a bishop's qualification, and that only if he occupies one of the five great sees of Canterbury, York, London, Durham and Winchester, or is of sufficient seniority in appointment to fill one of the remaining twenty-one places on the bench of bishops in the house—for there are now only twenty-six seats for thirty-six prelates.

The reign of Henry VIII. brought about far-reaching changes in the position of the peerage. When that king ascended the throne the hereditary element was in a decided *Henry VIII. minority*, but the balance was gradually redressed until at length a bare hereditary majority was secured and the dissolution of the monasteries made possible. The peers, many now grown fat on abbey lands, at once began to consolidate their position; precedents were eagerly sought for, and the doctrine of ennobled blood began to find definite and vigorous expression. So long, the peers declared, as there is any ennobled blood, a peerage must exist; and it can be extinguished only by act of parliament, failure of heirs, or upon corruption of blood by attainder. Stubbs writes with some contempt of the doctrine (*Const. Hist.* iii. 458 n.), apparently on the ground that it is absurd to speak of ennobled blood so long as the children of a peer still remain commoners. The doctrine is neither unreasonable nor illogical. By it is meant blood in which there always exists a capacity to inherit a particular peerage, and every person in whose veins the ennobled blood runs is competent to occupy the peerage if the chances of nature should remove those who are senior to him in the line of descent. A good illustration is the popular use of the term "blood royal," which of course does not mean that an individual of the blood royal necessarily occupies a throne but that he or she is in the line of succession to it. Similarly, persons of "ennobled blood" are not necessarily peers but in the line of descent to peerages, to which they may or may not succeed. (See NOBILITY.)

The English peer is not like the continental noble the member of a caste, but the holder for life of an office clothed with high and exceptional legislative and judicial attributes entirely dependent on his office and exercisable only in conjunction with his fellow peers in parliament assembled. Such privileges as he possesses are due primarily to his office rather than to his blood. His children are commoners, who though accorded courtesy titles by the usage of society have no legal privileges not shared with the humblest of British subjects. It is this peculiar official quality of an English peerage which saved England from the curse of a privileged noble caste such as that which so long barred all progress in France and Germany. As a result there are hundreds of families in the United Kingdom who, commoners there, would yet, from their purity of blood, position and influence, be accounted noble in any continental country.

From the doctrine of nobility of blood is derived the rule of law that no peerage (a Scots peerage is under Scots Law) can be surrendered, extinguished, or in any way got rid of unless the blood be corrupted. The rule is *Surrender of Peerage*, well illustrated by the earldom of Norfolk case (*Law Reports* [1907], A. C. 10) in which its development was traced, and the principle authoritatively confirmed. In 1302 the hereditary earldom of Norfolk (created in 1135) was in the possession of Hugh Bygod, one of the most powerful nobles of

Plantagenet days. The earl got into difficulties, and as some say, for a consideration, and others, to spite his brother and debtor, surrendered his earldom and all the lands thereto belonging, to King Edward I. from whom he subsequently received it back with an altered limitation to himself and the heirs of his body. As he was a childless old man this was practically a short life interest to the exclusion of all his relatives, the nearest of whom but for the surrender would have succeeded. Soon after Bygod died, and the earldom fell into the hands of Edward II. who granted it to his brother Thomas of Brotherton in 1312. Lord Mowbray, the lineal descendant of this Thomas, recently came forward and claimed the earldom, but in 1906 the House of Lords decided against his claim on the ground that in law Bygod's surrender was invalid, and that therefore Edward II. had no valid power to grant this particular earldom to Thomas of Brotherton. Historically there is little to support such a decision, and indeed this rigid application of the law is of comparatively recent date. Without doubt king, nobles and lawyers alike were all agreed, right down to Tudor days, that such surrenders were entirely valid. Many certainly were made, but, according to the decision of 1906, any living heirs of line of those nobles who thus got rid of their peerage honours can, if their pedigrees be provable, come to the House of Lords with a fair chance of reviving the ancient honours. Even as late as 1663 we find the Crown, naturally with the concurrence of its legal advisers, stating in the barony of Lucas patent (1663) that, on the appearance of co-heirs to a barony, the honour may be suspended or extinguished at the royal pleasure. The royal view of the law (at any rate as to extinction) was strongly objected to by the Lords, who guarded their privileges in Stuart days even more strictly than did the Commons. As early as 1626, in the celebrated dispute over the earldom of Oxford, the lord great chamberlainship and the baronies of Bolebec, Badlesmere and Sandford, Mr Justice Dodridge, who had been called in by the Lords to advise them, said that an earl could not give away or alien his inheritance, because it was "a personal dignity annexed to the posterity and fixed in the blood." Fourteen years later, in the Grey de Ruthyn case, the Lords solemnly resolved, "That no peer of the realm can drown or extinguish his honour (but that it descends unto his descendants), neither by surrender, grant, fine nor any other conveyance to the king." In 1678 the Lords became, if possible, even more definite, in view probably of the fact that the Crown had disregarded the Grey de Ruthyn resolution, having in 1660 taken into its hands, by surrender of Robert Villiers, 2nd viscount, the viscounty of Purbeck. In 1676 the son of the second viscount applied for his writ of summons, and on the advice of Sir William Jones, the attorney-general, who reported that "this (surrender) was a considerable question, never before resolved that he knew of," the king referred the whole matter to the Lords. The Lords were very explicit, being "unanimously of the opinion, and do resolve that no fine now levied, or at any time hereafter to be levied by the king, can bar such title of honour (i.e. of a peer of the realm), or the right of any person claiming under him that levied, or shall levy such fine." On these resolutions passed in the seventeenth century, the Lords of 1906 find illegal a surrender of 1302. The result seems strange, but it is, at any rate, logical from the legal point of view. It was urged that in 1302 no real parliament, in the sense applied to those of later years, was in existence; and consequently, a resolution founded on parliamentary principles should not apply. To this answer was made: Although it may be true that the law and practice of parliament had not then crystallized into the definite shape of even a hundred years later, the "Model Parliament" was summoned seven years before Bygod's surrender, and it is necessary to have some definite occurrence from which to date a legal beginning—a point of law with which an historian can have little sympathy.

Briefly, perhaps, from the teaching of the case it may be permissible to state the rule as follows: In early days the Norman and Plantagenet kings took upon themselves to deal with the barons in a manner which, though illegal, was suffered

because no one dared oppose them; but as time went on, becoming stronger and more determined to enforce their privileges and exalt their order the peers were able to compel recognition of their rights, and their resolutions in Stuart days were only declaratory of law which had always existed, but had been systematically disregarded by the Crown. This being so, resolutions of the peers deliberately and expressly laid down must, when in point, always be followed.

The application of the doctrine of corruption of blood to peerages arises out of their close connexion with the tenure of land, peerage dignities never having been regarded as personal until well on into the 14th century. Conviction for any kind of felony—and treason originally was a form of felony—was always followed by attainder. This resulted in the immediate corruption of the blood of the offender, and its capacity for inheritance was lost for ever. Such corruption with all its consequences could be set aside only by act of parliament. This stringent rule of forfeiture was to some extent mitigated by the passing in 1285 of the statute *De Donis Conditionalibus* (Blackstone's *Commentaries*, ii. 116) which made possible the creation of estates tail, and when a tenant-in-tail was attained forfeiture extended only to his life interest. The statute *De Donis* was soon applied by the judges to such dignities as were entailed (e.g. dignities conferred by patent with limitations in tail), but it never affected baronies by writ, which were not estates in tail but in the nature of estates in fee simple descendible to heirs general. In the reign of Henry VIII. an act was passed (1534) which brought estates tail within the law of forfeiture, but for high treason only. The position then became that peerages of any kind were forfeitable by attainder following on high treason, while baronies by writ remained as before forfeitable for attainder following on felony. In 1708, just after the Union with Scotland, an act was passed by which on the death of the Pretender and three years after Queen Anne's death the effects of corruption of blood consequent on attainder for high treason were to be abolished, and the actual offender only to be punished (stat. 7 Anne, c. 21, § 10). Owing to the 1745 rising, the operation of this act was postponed until the decease of the Pretender and all his sons (stat. 17 Geo. II. c. 39, § 3). In 1814 forfeiture for every crime other than high and petty treason and murder was restricted to the lifetime of the person attainted (stat. 54 Geo. III. c. 145). Finally in 1870 forfeiture, except upon outlawry, was altogether abolished and it was provided that "no judgment of or for any treason or felony should cause any attainder or corruption of blood, or any forfeiture or escheat." The necessity for ascertaining the exact condition of the law with regard to attainder throughout the whole period of English parliamentary history will be realized when it is remembered that there still exist dormant and abeyant peerages dating from 1205 onwards which may at any time be the subject of claim before the House of Lords, and if any attainders exist in the history of such peerages the law governing their consequences is not the law as it exists to-day but as it existed when the attainder occurred. The dukedom of Atholl case of 1764 is interesting as showing the effect of attainder on a peerage where the person attainted does not actually succeed. John first duke of Atholl died in 1725 leaving two sons James and George. George the younger was attainted of treason in 1745 and died in 1760, leaving a son John. James, the second son of the first duke, who had succeeded his father in 1725 died in 1764 without issue. John his nephew then claimed the dukedom, and was allowed it on the ground that his father never having been in the possession of the dukedom his attainder could not bar his son, who succeeds by reason of his heirship to his uncle. It would have been otherwise had the younger son outlived his brother, for he would then have succeeded to the dukedom and so destroyed it by his attainder.

In many cases there have been passed special parliamentary acts of attainder and forfeiture, and these, of course, operate apart from the general law. In any event, attainder and forfeiture of a dignity, whether resulting from the rules of the common law or from special or general acts of parliament can

Attainder and Corruption of Blood.

only be reversed by act of parliament. The procedure in reversing an attainder and recovering a dignity is as follows. The Crown signifies its pleasure that a bill of restoration shall be prepared and signs it. The bill is then brought in to the House of Lords, passed there, and sent to the Commons for assent. The last bills of the kind became law in 1876, when Earl Cowper procured the removal of the attainder on one of his Ormond ancestors and so by purging the blood of corruption became entitled to, and was allowed, the barony of Butler of Moore Park (created in 1663). There should also be noted the Earlom of Mar Restitution Act 1885, which, while mainly confirmatory of a disputed succession, at the same time reversed any attainders that existed.

The House of Lords grew steadily throughout the Tudor period, and during the reign of the first two Stuarts underwent a still greater increase. In the Great Rebellion the majority of the peers were the king's stoutest supporters and thus inevitably involved themselves in the ruin of the royal cause. Immediately after the execution of Charles I. the Republicans proceeded to sweep away everything which savoured of monarchy and aristocracy. The House of Commons voted the Lords "useless and dangerous," got rid of them as a part of parliament by the simple expedient of a resolution (*Comms. Journs.* 1648-1649, vi. 111) and placed the sole executive power in Cromwell's hands, but there was no direct abolition of the peerage as such. Evidently it took Cromwell but little time to realize the fallacy, in practice, of Cromwell's single-chamber government, as he is found ten years after the "useless and dangerous" resolution busy establishing a second chamber.¹ What to call it aroused much discussion, and eventually the unruly Commons consented to speak of and deal with "the other house." It is very difficult to realize what was the constitution of this body, so short was its life and so contemptuous its treatment by the Commons. The members of "the other house" were summoned by writs under the Great Seal, similar in form to those used to summon peers of past days. Some sixty writs were issued, and presumably their recipients were entitled thereby to sit for the duration of the parliament to which they were summoned; but it may be considered as certain that Cromwell's lords were never regarded as hereditary peers. They were entitled to the courtesy appellation "Lord" and appear to have been in the main substantial men—existing peers, judges, distinguished lawyers and members of well-known county families. Judging from Cromwell's speech at the opening of parliament, and subsequent entries in Whitelock's diaries, the new house appears to have had revising functions both of a legislative and judicial nature and also the duty of taking cognizance of foreign affairs. Cromwell certainly issued two patents of hereditary peerage—the barony of Burnell and the barony of Gilsland (with which went the viscounty of Howard of Morpeth), but neither title was recognized on the Restoration, and it does not appear that the possession of these titles ever conferred on their holders any hereditary right to a writ of summons to sit in "the other house." Whitelock himself was promised a viscounty by Cromwell, but no patent ever appears to have passed the Great Seal. Eventually business between the two houses grew impossible, and Cromwell was compelled to dissolve parliament. Richard's first parliament also contained Lords as well as Commons, the latter considerably voting "to transact business with the persons sitting in the other house as an House of Parliament, saving the right of the peers who had been faithful to the parliament," the saving clause evidently a loophole for the future. The dissolution of this parliament and the retirement of the protector Richard into private life preceded by only a few months the restoration to the throne of Charles II. With the king the peers returned to their ancient places.

From the reign of William of Orange the peerage has been freshened by a steady stream of men who as a rule have served

¹ Whitelock's *Memorials of English Affairs* (in the reign of Charles I. and up to the Restoration) (1853 ed. iv. 313).

their country as statesmen, lawyers and soldiers. Little of note occurred in the history of the peerage until the reign of Anne. By the Act of Union with Scotland (1707) Scottish the Scottish parliament was abolished; but the *Scottish Representative Peers.* Scottish peerage were given the privilege of electing, for each parliament of Great Britain, sixteen of their number to represent them in the House of Lords. Further creations in the Scottish peerage were no longer to be made. The effect of this act was to leave the great majority of the Scottish peers outside the House of Lords, as only sixteen of their number were to become lords of parliament. Close upon a hundred years later Ireland was united with Great Britain, the Irish parliament being merged in the *Irish Representative Peers.* Irish parliament of the United Kingdom of Great Britain and Ireland. Twenty-eight Irish peers were to be elected for life by their order to represent it in the House of Lords. One archbishop and three bishops were also chosen in turn to represent the Irish Church in the House of Lords, but when that Church was disestablished in 1867 the spiritual lords lost their seats. The merger of the three kingdoms had an important effect on their peerages. Every peer in his own country had been a lord of parliament by hereditary right. The English peer (and, as the Acts of Union were passed, the peer of Great Britain and the peer of the United Kingdom) continued by hereditary right a lord of parliament. The Scottish and Irish peers lost this right though by the two Acts of Union they retained every other privilege of peerage. Henceforth they were lords of parliament only as and when their fellow peers elected them. Thus though not all were lords of parliament *in esse*, every one was always so *in posse*, and in any case it was the hereditary quality of the peerage which either actually seated its holder in the House of Lords or made it possible for him to get there by the votes of his fellows.

It now becomes possible to arrive at the modern meaning of the term "a peerage," and we may define it as a dignity of England, Scotland or Ireland, which, by its hereditary quality, confers on its holder for the time being the right to be or not to be elected a lord of parliament. The term "peerage" is also used in a collective sense.

The reign of Anne is remarkable for an attempt made by the House of Lords to limit its numbers by law. The queen, in order to secure a majority for the court party, *Queen Anne and Peerage Limitation.* had created a batch of twelve peers at one time, a considerable number in relation to existing peerages; and it was feared this expedient might be used as a precedent. A peerage limitation bill was introduced into the House of Lords in 1719. Six new creations were to be allowed, but after these the Crown, except in the case of royal princes, was to create a new peerage only when an old one became extinct. Twenty-five hereditary peerages in Scotland were to take the place of the sixteen representative peers for all time. The bill passed the Lords, but was eventually thrown out in the House of Commons, though not by an overwhelming majority.

In 1856 it was desired to strengthen the judicial element in the House of Lords, and the Crown issued letters patent creating Sir James Parke, one of the barons of the exchequer, Baron Wensleydale and a peer "for *Wensleydale Case.* and during the term of his natural life." The burden of an hereditary peerage is heavy, and many men thoroughly well qualified in legal attainments have been known to refuse it on the ground of expense alone. This life-peerage was thought to be a way out of the difficulty, and it was on Lord Chancellor Cranworth's advice that the Crown issued the Wensleydale patent. The House of Lords at once realized that the creation of life-peers, at the will of the ministry of the day, might put the hereditary section into an absolute minority, and possibly in time, by form of law, get rid of it altogether. Eventually it was decided by the house that "neither the said letters patent nor the said letters patent with the usual writ of summons enable the grantee to sit and vote in parliament," a formal resolution which closed the door in the face of every

person whom the Crown might endeavour to make a life-peer. The government of the day accepted the situation, and soon afterwards a new patent was made out which followed the usual limitation to heirs-male. The precedents in favour of the Crown's action were not strong. The essential and outstanding attribute of the house was its hereditary character. The whole balance of the constitution worked on the pivot of the independence of the peers. They existed as a moderating force in the counsels of parliament, and the alteration of the hereditary character of the House of Lords might easily have rendered it amenable to whatever pressure the government of the day might see fit to exercise. In such circumstances its position as arbiter between people and government would tend to disappear. A change fraught with so many serious possibilities ought not, it was said, to be made by the simple prerogative of the Crown. If so far-reaching an alteration in the law were justifiable it was for parliament to make it. Further, it was pointed out, there had been no life-creations for centuries, and those that are recorded to have been conferred since the crystallization of our parliamentary system were of such a nature that the grantees never sat in the house by virtue of their life-honours, inasmuch as they were existing peers or women. Soon

Judicial Peers.

after the Wensleydale debates the government introduced a bill into the House of Lords to authorize the creation of two life-peers, who were to be persons of at least five years' standing as judges. They were to sit as lords of appeal but to be peers for life. Eventually the bill disappeared in the House of Commons. In 1869 Earl Russell introduced another life-peerage bill of far wider scope. Twenty-eight life-peers might be in existence at any one time, but not more than four were to be created in any one year. The life peers would be lords of parliament for life. They were to be selected by the Crown from the peerages of Scotland and Ireland, persons who had sat for ten years in the Commons, distinguished soldiers, sailors, civil servants and judges or persons distinguished in science, literature or art. The bill received a rough handling in committee of the Lords, and the time was evidently not ripe for change, as the bill failed to pass its third reading.

In 1870 attempts were made in the House of Lords to alter the position of the Scottish and Irish representative peers. In 1876 the need of further judicial strength in the *Suggested Reforms and Alterations* Lords was tardily admitted, and an act was passed authorizing the creation of two lords of appeal in ordinary, and power was reserved to appoint two more as certain judicial vacancies occurred. They were to be entitled to the rank of baron during their lives but were to sit and vote in parliament only so long as they held their judicial office. Their dignities lasted for life only. Eleven years later another act enabled all retired lords of appeal to sit and vote as members of the House of Lords for life. To those interested in House of Lords reform the pages of *Hansard's Parliamentary Debates* are the best authority. In 1888 reform bills were introduced by Lords Dunraven and Salisbury, and in 1907 by Lord Newton. In December 1908 the publication of a long report with sweeping recommendations for reform ended the labours of a House of Lords committee which had been appointed to consider the question in detail. In the session of 1910, following the general election, long discussions took place in both houses of parliament. Opinion generally was freely expressed that the time had arrived for diminishing the number of lords of parliament and for putting into practice the principle that hereditary right alone should no longer confer lordship of parliament. (See PARLIAMENT.)

The Scottish peerage, like that of England, owes its origin to feudalism. In Anglo-Norman days Scotland was a small country, and for some generations after England was settled the Scottish king's writ ran little beyond the foot of the Highlands, and even the Lord of the Isles reckoned himself an independent sovereign until the beginning of the 15th century. The weak and usually ineffective control of the Crown resulted in opportunities for acquiring personal power which the nobles were not slow to take advantage

of. Seldom accustomed to act in concert, they soon developed particularist tendencies which steadily increased the strength of their territorial position. These conditions of existence were entirely unfavourable to the establishment of any system of parliamentary government such as centralization had made possible in England, therefore it is not surprising to find that the lesser barons were not relieved of their attendance at the national assemblies until well on in the 15th century (Burton's *Scotland*, iii. 111). Again, when the Scottish earls and barons came to parliament, they did not withdraw themselves from the rest of the people, it being the custom for the estates of Scotland to deliberate together, and this custom persisted until the abolition of their parliament by the Act of Union in 1707. The territorial spirit of the nobles inevitably led them to regard the honour as belonging to, and inseparable from, their land, and until comparatively late in Scottish history there is nowhere any record of the conferment of a personal dignity unattached to land such as that conferred in England on Beauchamp by Richard II. This explains the frequent surrenders and altered grants which are so common in Scottish peerage history, and which, in sharp distinction to the English rule of law, are there regarded as perfectly legal. To-day there exists no Scottish dukedom (except the royal dukedom of Rothesay), marquessate or viscounty created before the reign of James VI. of Scotland (and I. of England). Of the existing Scottish peerages sixty-three were created in the period between James's accession to the English throne and the Act of Union. There are now only eighty-seven in all. Unlike one of the English peerages owing its origin exclusively to a writ of summons, ancient Scottish peerages do not fall into abeyance, and when there are only heirs-general, the eldest heir of line succeeds.

Whenever a new parliament is summoned, proclamation is made in Scotland summoning the peers to meet at Holyrood to elect sixteen of their number to represent them in such parliament. The Scottish peerages are recorded on a roll, and this is called over by the lord clerk register before the assembled peers seated at a long table. Each peer answers to the name of the peerage (it may be one or more) he possesses. The roll is then read again and each peer in turn (but only once) rises and reads out the list of those sixteen peers for whom he votes. Proxies are allowed for absent peers and are handed in after the second roll-call. The votes are counted and the lord clerk register reads out the names of those elected, makes a return, and signs and seals it in the presence of the peers assembled. The return eventually finds its way to the House of Lords. The Scottish representative peer so elected receives no writ of summons to parliament, but attends the House of Lords to take the oath, his right to sit being evidenced by the return made. It might be thought that the rules of election in so important a matter would be more stringent, but the fact remains that it is quite possible for an entirely unqualified person to attend and vote at Holyrood. No evidence of identity or of a man's right to be present is required and the lord clerk register is compelled to receive any vote tendered except in respect of peerages for which no vote has been given since 1800, these being struck off the roll (10 & 11 Vict. c. 52). Any person claiming to represent such a peerage must prove his right before the House of Lords, as was done in the case of the barony of Fairfax in 1908. It is true that by the act last cited any two peers may protest against a vote at Holyrood, and the lord clerk register thereupon reports the proceedings to the House of Lords, who will consider the question if application be made for an inquiry, but nothing is done unless an application is made. The right to vote certainly needs better proof than that now accepted. For many years the House of Lords maintained that the Crown could not confer a new peerage of Great Britain on a Scottish peer, the ground being that the Scottish peerage was only entitled to the sixteen representative peers given it by the Act of Union, but eventually in 1782 in the case of the duke of Hamilton this contention was given up.

The Anglo-Norman conquerors of Ireland carried with them the laws and the system of tenure to which they were accustomed

in England, and consequently the growth of the baronage and the establishment of parliamentary government in Ireland proceeded on parallel lines with the changes which occurred in England. Until the reign of Henry VIII. the Irish were without representation in parliament, but gradually the Irish were admitted, and by the creation of new parliamentary counties and boroughs were enabled to elect representatives. In 1613 the whole country shared in representation (Ball's *Legislative Systems of Ireland*). Just as James I. had added many members to the Scottish peerage, so he increased the number of Irish peers.

In 1800 the Union of Great Britain and Ireland abolished the parliament of Ireland. By the Act of Union the Irish peers became entitled to elect twenty-eight of their number to represent them in the House of Lords. The election is for life, and only those peers are entitled to vote at elections of representative peers who have proved their right of succession to the satisfaction of the lord chancellor, who issues his notice to that effect after each individual proof. The names of such peers are added to the voting-roll of the peerage, and when voting papers are distributed—the Irish peers do not meet for election purposes as do those of Scotland—they are sent only to those peers who have proved their right to vote. If any claim to the right to vote is rejected by the lord chancellor the claimant must prove his case before the Committee for Privileges (barony of Graves, 1907). When an Irish peer has been elected a representative peer he receives, as a matter of course, a writ of summons at the beginning of each parliament. The great bulk of the Irish peerage owes its existence to creations during the last two centuries, only seven of the existing peerages dating back beyond the 17th century; of the rest twenty-two were created during the year of Union, and thirty-three have been added since that date. Some hundred or more years ago ministers found the Irish peerage a useful means of political reward, in that it was possible to bestow a title of honour, with all its social prestige, and yet not to increase the numbers of the House of Lords.

On the death of a representative peer of Scotland or Ireland a vacancy occurs and a new election takes place, but in accordance with modern practice promotion to a United Kingdom peer does not vacate the holder's representative position (May's *Parliamentary Practice*, p. 11 n.). Scottish and Irish peers, if representative, possess all the privileges of peerage and parliament enjoyed by peers of the United Kingdom; if non-representative all privileges of peerage, except the right to a writ of summons to attend parliament and to be present at and vote in the trial of peers. A Scottish peer, if non-representative, is in the anomalous position of being disabled from serving his country in either house of parliament, but an Irish peer may sit for any House of Commons constituency out of Ireland, though while a member of the Commons his peerage privileges abate.

Though many peers possess more than one peerage, and frequently of more than one country, only that title is publicly used which is first in point of precedence. It was once argued that whenever a barony by writ came into the possession of a person already a peer of higher rank, the higher peerage "attracted" or overshadowed the lower, which thenceforth followed the course of descent of the dignity which had attracted it. This doctrine is now exploded and cannot be regarded as applying to any case except that of the Crown (*Baronies of Fitzwalter*, 1660, and *De Ros*, 1666; Collins's *Claims*, 168, 261). Every peerage descends according to the limitations prescribed in its patent of creation or its charter, and where these are non-existent (as in the case of baronies by writ) to heirs-general. (See ABEYANCE.)

In dealing with English dignities it is essential to realize the difference between a mere title of honour and a peerage. The Crown as the fountain of honour is capable of conferring upon a subject not only any existing title of honour, but may even invent one for the purpose. So James I. instituted an order of hereditary knights which he termed baronets,

and Edward VII. created the duchess of Fife "Princess Royal"—a life dignity. The dignities of prince of Wales, earl marshal and lord great chamberlain have been for centuries hereditary, and though of high court and social precedence, of themselves confer no right to a seat in the House of Lords—they are not peerages. Creations must be according to Law.

The grant of a peerage is a very different matter; its holder becomes thereby a member of the Upper House of Parliament, and therefore the prerogative of the Crown in creating such an office of honour must be exercised strictly in accordance with the law of the land. The Crown's prerogative is limited in several directions. The course of descent must be known to the law; and so, in the first place, it follows that a peer cannot be created for life with a denial of succession to his descendants (unless it be as one of the lords of appeal in ordinary under the acts of 1876 and 1887). The courses of descent of modern patents are invariably so marked out as ultimately to fix the peerage in some male line according to the custom of primogeniture, though the immediate successor of the first holder may be a woman or even a stranger in blood. The following instances may be cited; Amabell, Baroness Lucas, was in 1816 created Countess de Grey with a limitation to the heirs-male of her sister; a nephew afterwards succeeded her and the earldom is now held by the marquess of Ripon. Other courses of descent known to the law are as follows: Fee simple, which probably operates as if to heirs-general, earldoms of Oxford (1155) and Norfolk (1135), both probably now in abeyance; and Bedford (1367), extinct; to a second son, the eldest being alive, dukedom of Dover (1708), extinct, and earldom of Cromartie (1861) called out of abeyance in 1895; a son-in-law and his heirs-male by the daughter of the first grantee, earldom of Northumberland (1747); to an elder daughter and her heirs-male, earldom of Roberts (1901); to an elder or younger brother and his heirs-male, viscounty of Kitchener (1902) and barony of Grimthorpe (1886). It is, however, not lawful for the Crown to make what is called a shifting limitation to a peerage, i.e. one which might vest a peerage in an individual, and then on a certain event happening (e.g. his succession to a peerage of higher rank) shift it from him to the representative of some other line. Such a limitation was held illegal in the *Buckhurst* case (1864). A peerage may not be limited to the grantee and "his heirs-male for ever." Such a grant was that of the earldom of Wiltes in 1398. The original grantee died without issue, but left a male heir-at-law, whose descendants in 1869 claimed the earldom, but the original limitation was held invalid.

There is no limitation on the power of the Crown as to the number of United Kingdom peerages which may be created. As to Scotland, the Act of Union with that country operates to prevent any increase in the number of Scottish peerages, and consequently there have been no creations since 1707, with the result that the Scottish peerage, as a separate order, is gradually approaching extinction. The Irish peerage is supposed always to consist of one hundred exclusively Irish peers, and the Crown has power to grant Irish peerages up to the limit. When the limit is reached no more peerages may be granted until existing ones become extinct or their holders succeed to United Kingdom peerages. Only four lords of appeal in ordinary may hold office at any one time. The number of archbishops and bishops capable of sitting in the House of Lords is fixed by various statutes at twenty-six, but, as pointed out previously, the spiritual lords are not now regarded as peers.

Since party government became the rule, the new peerages have usually been created on the recommendation of the prime minister of the day, though the Crown, especially in considering the claims of royal blood, is believed Growth in Numbers. in some instances to take its own course; and constitutionally such action is entirely legal. By far the greater number of peerage honours granted during the last two centuries have been rewards for political services. Usually these services are well known, but there exists several instances in which the reasons for conferring the honour have not been quite clear. Until the reign of George III. the peerage was

comparatively small, but that monarch issued no fewer than 388 patents of peerage. Many of these have become extinct or obscured by higher titles, but the general tendency is in the direction of a steady increase, and where the peers of Tudor times might be counted by tens their successors of 1910 were numbered in hundreds. The full body would be 546 English peers. There are also 12 ladies holding English peerages. The Irish peerage has 175 members, but 82 of these are also peers of the United Kingdom, leaving 28 representative and 65 without seats in the House of Lords. Of 87 Scottish peers 51 hold United Kingdom peerages, the remainder consisting of 16 representative and 20 without seats.

As centuries have gone by and customs changed, many privileges once keenly asserted have either dropped out of use or been forgotten. The most important now in being are a seat in the House of Lords and the right to trial by peers. The right to a seat in parliament is one sanctioned by centuries of constitutional usage. The right of a peer in England to a seat in parliament was not, as pointed out in the early part of this article, entirely admitted by the Crown until late in the Plantagenet period, the king's pleasure as to whom he should summon always having been a very material factor in the question. Charles I. made a deliberate attempt to recover the ancient discretion of the Crown in the issue of writs of summons. The earl of Bristol was the subject of certain treasonable charges, and though he was never put on his trial the king directed that his writ of summons should not issue. The excluded peer petitioned the Lords, as for a breach of privilege, and a committee to whom the matter was referred reported that there was no instance on record in which a peer capable of sitting in parliament had been refused his writ. There was a little delay, but the king eventually gave in, and the earl had his writ (*Lords Journals*, iii. 544).

At the beginning of a new parliament every peer entitled receives a writ of summons issued under the authority of the Great Seal; he presents his writ at the table of the House of Lords on his first attendance, and before taking the oath. If the peer be newly created he presents his letters-patent creating the peerage to the lord chancellor on the woosack, together with the writ of summons which the patent has evoked. A peer on succession presents his writ in the ordinary way, the *Journals* recording, e.g. that Thomas Walter, Viscount Hampden, sat first in Parliament after the death of his father (*Lords Journals*, cxxxix. 4). The form of writ now issued (at the beginning of a parliament: for the variation when parliament is sitting see *Lords Journals*, cxxxix. 185) corresponds closely to that in use so long ago as the 14th century. It runs as follows:—

George the Fifth by the Grace of God of the United Kingdom of Great Britain and Ireland and of the British Dominions beyond the seas King Defender of the Faith to our right trusty and well-beloved Greeting Whereas by the advice and consent of our Council for certain arduous and urgent affairs concerning us the state and the defence of our said United Kingdom and the Church we have ordered a certain Parliament to be holden at our City of Westminster on the . . . day of . . . next ensuing and there to treat and have conference with the prelates great men and peers of our realm We strictly enjoining command you upon the faith and allegiance by which you are bound to us that the weightiness of the said affairs and imminent perils considered (waiving all excuses) you be at the said day and place personally present with us and with the said prelates great men and peers to treat and give your counsel upon the affairs aforesaid. And this as you regard us and our honour and the safety and defence of the said United Kingdom and Church and despatch of the said affairs in no wise do you omit.

Formerly all peers were required to attend parliament, and there are numerous recorded instances of special grants of leave of absence, but nowadays there is no compulsion.

After the right to a summons the principal privilege possessed by a peer is his right to be tried by his peers on a charge of treason or felony. Whatever the origin of this right, and some writers date it back to Saxon times (Trial of Lord Morley, 1678, *State Trials* vii.

145), Magna Carta has always been regarded as its confirmatory authority. The important words are:—

"nullus liber homo capiatur imprisonetur aut disseisnatur de libero tenemento suo vel libertatibus seu liberis consuetudinibus suis, aut utlagetur aut exuletur nec aliquo modo distringatur nec dominus rex super ipsum ibit nec super eum mittet nisi per legale iudicium parium suorum vel per legem terrae."

The peers have always strongly insisted on this privilege of trial by their own order, and several times the heirs of those wrongly condemned recovered their rights and heritage on the ground that there had been no proper trial by peers (*R.D.P.*, v. 24). In 1442 the privilege received parliamentary confirmation (stat. 20 Henry VI. c. 9). If parliament is sitting the trial takes place before the House of Lords in full session, i.e. the court of our lord the king in parliament, if not then before the court of the lord high steward. The office of lord high steward was formerly hereditary, but has not been so for centuries and is now only granted *pro hac vice*. When necessity arises the Crown issues a special commission naming some peer (usually the lord chancellor) lord high steward *pro hac vice* (*Blackstone's Comm.* iv. 258). When a trial takes place in full parliament a lord high steward is also appointed, but his powers there are confined to the presidency of the court, all the peers sitting as judges of law as well as of fact. Should the lord high steward be sitting as a court out of parliament he summons a number of peers to attend as a jury, but rules alone on all points of law and practice, the peers present being judges of fact only. Whichever kind of trial is in progress it is the invariable practice to summon all the judges to attend and advise on points of law. The distinction between the two tribunals was fully discussed and recognized in 1760 (Trial of Earl Ferrers, *Foster's Criminal Cases*, 139). The most recent trial was that of Earl Russell for bigamy (reported 1901, *A.C.* 446). Among others are the Kilmarnock, Cromarty and Balmerino treason trials in parliament in 1746 (*State Trials* xviii. 441), and in the court of the lord high steward, Lord Morley (treason, 1666, *State Trials* vi. 777), Lord Cornwallis (murder, 1678 *State Trials* vii. 145), Lord Delamere (1686, treason, *State Trials* xi. 510). Recently some doubt has been expressed as to the origin of the court of the lord high steward. It is said that the historical document upon which the practice is founded is a forgery. The conflicting views are set forth in Vernon Harcourt's *His Grace the Steward and Trial of Peers*, p. 429, and in Pike's *Constitutional History of the House of Lords*, p. 213. In any case, whatever its historical origin, the court for centuries as a matter of fact has received full legal recognition as part of the constitution. The right to trial by peers extends only to cases of treason and felony, and not to those of misdemeanour; nor can it be waived by any peer (*Co.* 3 *Inst.* 29; *Kelyng's Rep.* 56). In the case of *R. v. Lord Groves* (1887), discussed in *Hansard's Parliamentary Debates*, 3rd series, vol. cccx. p. 246, Lord Halsbury points out that the question of trial by peers is one of jurisdiction established by law rather than a claim of privilege in the discretion of the accused. Scottish and Irish peers, whether possessing seats in the House of Lords or not, are entitled to trial by peers, the same procedure being followed as in the case of members of the House of Lords.

Peers with a seat in the House of Lords possess practically the same parliamentary privileges as do members of the House of Commons. Among other privileges peculiar to themselves they have the right of personal access to the sovereign (*Anson's Law of the Constitution*, i. 227). In the House of Lords, when a resolution is passed contrary to his sentiments, any peer, by leave of the house, may "protest," that is, enter his dissent on the journals of the house (*Blackstone, Comm.* i. 262). Formerly a peer might vote by proxy (*Blackstone, ibid.*), but since 1868 there has been a standing order discontinuing this right. In accordance with resolutions passed by the two houses, neither house has power by any vote or declaration to clothe itself with new privileges unknown to the law and customs of parliament (*Commons Journal*, xiv. 555). Peeresses and non-representative peers of Ireland and Scotland have,

with the exception of the right to sit in the House of Lords and its attendant parliamentary privileges, every peerage privilege: a widowed peeress retains her privilege of peerage while unmarried, but loses it if she marries a commoner (Co. Litt. 166; *Cowley v. Cowley* [1901] A.C. 450). Dissolution of marriage probably deprives a peeress of all peerage privileges which she acquired by marriage.

The children of peers are commoners. The eldest son of a peer of the rank of earl (and above) is usually known socially by the name of his father's next peerage, but the courtesy *Position of Families of Peers.* nature of such title is clearly indicated in every public or legal document, the phraseology employed being

"John Smith, Esq., commonly known as Viscount Blackacre." Several cases are on record in which peers' eldest sons have actually borne courtesy titles not possessed as peerage honours by their fathers, but inasmuch as such are only accorded by courtesy, no question of peerage privilege arises. The younger sons of dukes and marquesses are entitled to the prefix "Lord" before their Christian names, and all the daughters of earls as well as of dukes and marquesses are entitled similarly to style themselves "Lady," on the principle that all the daughters are equal in rank and precedence. The younger sons of earls and all the younger children of viscounts and barons are entitled to the prefix "Honourable." Usually when the direct heir of a peer dies his children are given, by the Crown, on the death of the peer, the courtesy titles and precedence they would have enjoyed had their father actually succeeded to the peerage.

An alien may be created a peer, but while remaining an alien cannot sit in the House of Lords, nor, if a Scottish or Irish peer, can he vote at elections for representative peers. Peerages

Creation of Peers. may be created (1) by writ of summons, (2) by patent. The writ of summons method is not now used except in the case of calling up an eldest son in the barony of his father. This does not create a new peerage but only accelerates the heir's appearance in the House of Lords. On the father's death the peerage remains vested in the son. Should the son die without heir the peerage reverts in the father. The invariable method of creation in all ordinary cases is by patent. The letters patent describe the name of the dignity, the person upon whom it is conferred, and specify its course of descent.

Claims to peerages are of two kinds: (1) of right, (2) of grace. In theory the Crown, as the fountain of honour, might settle any claim without reference to the House of Lords and issue a writ of summons to its petitioner. This would not in any way prevent the House of Lords from examining the patent and writ of summons when the favoured petitioner or any heir claiming through him came to take his seat. If of opinion that the patent was illegal the house might refuse admittance, as it did in the *Wensleydale* case. In the case of a petitioner who has persuaded the Crown to terminate in his favour as a co-heir the abeyance of an ancient barony and who has received his writ of summons, the matter is more difficult. The house cannot refuse to admit any person properly summoned by the Crown, as the prerogative is unlimited in point of numbers; but it can take into account the precedence of the newcomer. If he has an old barony he naturally expects its proper place on the bench of barons; but if the house thought fit they might compel him to prove his pedigree before according any precedence. If he refused to do this they would still be bound to admit him, but it would be as the junior baron of the house with a peerage dating, for parliamentary purposes, from the day of his summons. The general result is that the Crown, unless there can be no question as to pedigree, seldom terminates an abeyance without referring the matter to the House of Lords, and invariably so refers all claims which are disputed or which involve any question of law.¹

The procedure is as follows: The claimant petitions the Crown through the home secretary, setting forth his pedigree and stating the nature of his claim. The Crown then refers the petition to its legal adviser, the attorney-general. The petitioner then in course of time appears before the attorney-general with his proofs. Finally the attorney-general reports that a prima facie case is, or is not, made out. If a case be made out, the Crown, if it does not take immediate action, refers the whole matter to the House of Lords, who pass it on to their Committee for Privileges for examination and report.

The Committee for Privileges, which for peerage claims is usually constituted of the law lords and one or two other lords interested in peerage history, sits as an ordinary court of justice *Committee for Privileges.* and follows all the rules of law and evidence. The attorney-general attends as adviser to the committee and to watch the interests of the Crown. According to the nature of the case the Committee reports to the house, and the house to the Crown, that the petitioner (if successful) (1) has made out his claim and is entitled to a writ of summons, or (2)

¹This was not done in the case of the earldom of Cromartie called out of abeyance in 1895. The holder of the title being a lady the house has had, as yet, no opportunity of considering the validity of the Crown's action.

has proved his co-heirship to an existing peerage, and has also proved the descent of all existing co-heirs. In the first case the writ of summons is issued forthwith, but the second, being one of abeyance, is a matter for the pleasure of the Crown, which need not be exercised at all, but, if exercised, may terminate the abeyance in favour of any one of the co-heirs. The seniority of a co-heir (though this alone is of little moment), his power to support the dignity, and the number of existing co-heirs, are all factors which count in the chances of success.

Reference has already been made in the earlier part of this article to the reply of Bishop Peter de Roches to the English barons who claimed trial by their peers, and, as was suggested *Peers of France.* the bishop probably had in his mind the peers of France. Possibly the word *peers*, as eventually used in England,

was borrowed from this source, but this is uncertain. The great men known originally as the twelve pairs de France, were the feudal holders of large territories under the nominal sway of the king of France. They were the (archbishop) duke of Rheims, the (bishop) dukes of Langres and Laon, the (bishop) counts of Beauvais, Noyon and Chalons, the dukes of Burgundy, Normandy and Aquitaine, and the counts of Flanders, Toulouse and Champagne. These magnates, nominally feudatories, were practically independent rulers, and their position can in no way be compared to that of the English baronage. It is said that this body of peers was instituted in the reign of Philip Augustus, though some writers even ascribe its origin to Charlemagne. Some of the peers were present at Philip's coronation in 1179, and later again at the alleged trial of John of England when his fief of Normandy was adjudged forfeit to the French Crown.

As the central power of the French kings grew, the various fiefs lost their independence and became united to the Crown, with the exception of Flanders which passed into the hands of the emperor Charles V. In the 14th century the custom arose for the sovereign to honour his more important nobles by granting them the title of Peer of France. At first the grant was confined to the royal dukes, but later it was conferred on others, amongst whom late in the 17th century appears the archbishop of Paris. To several counties and baronies the honour of a peerage was added, but most of these eventually became reunited with the Crown. As a legislative body a chamber of peers in France was first founded by Louis XVIII. in 1814; it was hereditary and modelled on the English House of Lords. The revolution of 1830 reduced its hereditary quality to life tenure, and in the troubles of 1848 the chamber itself finally disappeared.

Austria, Hungary and Portugal are other countries possessing peerages which to some extent follow the English model. In Austria there is a large hereditary nobility and those *Other Peerages.* members of it in whose families the legislative dignity is hereditary by nomination of the emperor sit in the Herrenhaus or Austrian Upper Chamber, together with certain prelates and a large number of nominated life-members. In Hungary all those nobles who possess the right of hereditary peerage (as admitted by the act of 1885 and subsequent acts) and who pay a land tax of certain value, are members of the House of Magnates, of which they form a large majority, the remainder of the members being Roman Catholic prelates, representatives of Protestant churches and life peers. In Portugal until recent years the House of Peers was an hereditary body, but it is now practically a chamber of life-peers. (G. E.⁴)

PEERLKAMP, PETRUS HOFMAN (1786-1865), Dutch classical scholar and critic, descended from a family of French refugees named Perlechamp, was born at Groningen on the 2nd of February 1786. He was professor of ancient literature and universal history at Leiden from 1822 to 1849, when he resigned his post and retired to Hilversum near Utrecht, where he died on the 27th of March 1865. He was the founder of the subjective method of textual criticism, which consisted in rejecting in a classical author whatever failed to come up to the standard of what that author, in the critic's opinion, ought to have written. His ingenuity in this direction, in which he went much farther than Bentley, was chiefly exercised on the *Odes* of Horace (the greater part of which he declared spurious), and the *Aeneid* of Virgil. He also edited the *Ars poetica* and *Satires* of Horace, the *Agricola* of Tacitus, the romance of Xenophon of Ephesus, and was the author of a history of the Latin poets of the Netherlands (*De vita, doctrina, et facultate Nederlandorum qui carmina latina composuerunt*, 1838).

See L. Müller, *Gesch. der klassischen Philologie in den Niederlanden* (1869), and J. E. Sandys, *Hist. of Class. Schol.* (1908), iii. 276.

PEESEMSKY, ALEXEY PEOFILACTOVICH (1820-1881), Russian novelist, was born on his father's estate, in the province of Kostroma, on the 10th/22nd of March 1820. In his autobiography he describes his family as belonging to the ancient

Russian nobility, but his more immediate progenitors were all very poor, and unable to read or write. His grandfather ploughed the fields as a simple peasant, and his father, as Peesemsky himself said, was washed and clothed by a rich relative, and placed as a soldier in the army, from which he retired as a major after thirty years' service. During childhood Peesemsky read eagerly the translated works of Walter Scott and Victor Hugo, and later those of Shakespeare, Schiller, Goethe, Rousseau, Voltaire and George Sand. From the gymnasium of Kostroma he passed through Moscow University, and in 1834 entered the government service as a clerk in the office of the Crown domains in his native province. Between 1854 and 1872, when he finally quitted the civil service, he occupied similar posts in St Petersburg and Moscow. His early works exhibit a profound disbelief in the higher qualities of humanity, and a disdain for the other sex, although he appears to have been attached to a particularly devoted and sensible wife. His first novel, *Boyarstchina*, was forbidden for its unflattering description of the Russian nobility. His principal novels are *Tufak* ("A Muff"), 1850; *Teesicha doush* ("A Thousand Souls"), 1862, which is considered his best work of the kind; and *Vzbalomouchenoe more* ("A Troubled Sea"), giving a picture of the excited state of Russian society about the year 1862. He also produced a comedy, *Gorkaya soudbina* ("A Bitter Fate"), depicting the dark sides of the Russian peasantry, which obtained for him the Ovaroff prize of the Russian Academy. In 1856 he was sent, together with other literary men, to report on the ethnographical and commercial condition of the Russian interior, his particular field of inquiry having been Astrakhan and the region of the Caspian Sea. His scepticism in regard to the liberal reforms of the 'sixties made him very unpopular among the more progressive writers of that time. He died at Moscow on the 2nd of February 1881 (Jan. 21, Russian style).

PEGASUS (from Gr. πηγῆς, compact, strong), the famous winged horse of Greek fable, said to have sprung from the trunk of the Gorgon Medusa when her head was cut off by Perseus. Bellerophon caught him as he drank of the spring Peirene on the Acrocorinthus at Corinth, or received him tamed and bridled at the hands of Athena (Pindar, *Ol.* xiii. 63; Pausanias ii. 4). Mounted on Pegasus, Bellerophon slew the Chimæra and overcame the Solymi and the Amazons, but when he tried to fly to heaven on the horse's back he threw him and continued his heavenward course (Apolodorus ii. 3). Arrived in heaven, Pegasus served Zeus, fetching for him his thunder and lightning (Hesiod, *Theog.* 281). Hence some have thought that Pegasus is a symbol of the thundercloud. According to O. Gruppe (*Griechische Mythologie*, i. 75, 123) Pegasus, like Arion the fabled offspring of Demeter and Poseidon, was a curse-horse, symbolical of the rapidity with which curses were fulfilled. In later legend he is the horse of Eos, the morning. The erroneous derivation from πηγή, "a spring of water," may have given birth to the legends which connect Pegasus with water; e.g. that his father was Poseidon, that he was born at the springs of Ocean, and that he had the power of making springs rise from the ground by a blow of his hoof. When Mt. Helicon, enchanted by the song of the Muses, began to rise to heaven, Pegasus stopped its ascent by stamping on the ground (Antoninus Liberalis 9), and where he struck the earth Hippocrene (horse-spring), the fountain of the Muses, gushed forth (Pausanias ii. 31, ix. 31). But there are facts that speak for an independent mythological connexion between horses and water, e.g. the sacredness of the horse to Poseidon, the epithets Hippios and Equester applied to Poseidon and Neptune, the Greek fable of the origin of the first horse (produced by Poseidon striking the ground with his trident), and the custom in Argolis of sacrificing horses to Poseidon by drowning them in a well. From his connexion with Hippocrene Pegasus has come to be regarded as the horse of the Muses and hence as a symbol of poetry. But this is a modern attribute of Pegasus, not known to the ancients, and dating only from the *Orlando innamorato* of Boiardo.

See monograph by F. Haunig, *Breslauer philologische Abhandlungen* (1902), vol. viii., pt. 4.

PEGAU, a town of Germany, in the kingdom of Saxony, situated in a fertile country, on the Elster, 18 m. S.W. from Leipzig by the railway to Zeitz. Pop. (1905), 5656. It has two Evangelical churches, that of St Lawrence being a fine Gothic structure, a 16th-century town-hall; a very old hospital and an agricultural school. Its industries embrace the manufacture of felt, boots and metal wares.

Pegaugrew up round a monastery founded in 1096, but does not appear as a town before the close of the 12th century. Markets were held here and its prosperity was further enhanced by its position on a main road running east and west. In the monastery, which was dissolved in 1539, a valuable chronicle was compiled, the *Annales pegavienses*, covering the period from 1039 to 1227.

See Füssel, *Anfang und Ende des Klosters St Jacob zu Pegau* (Leipzig, 1857); and Dillner, Grössel and Günther, *Atlas und neues aus Pegau* (Leipzig, 1905). The *Annales pegavienses* are published in Bd. XVI. of the *Monumenta Germaniae historica. Scriptores*.

PEGMATITE (from Gr. πηγμα, a bond), the name given by Hatly to those masses of graphic granite which frequently occur in veins. They consist of quartz and alkali feldspars in crystalline intergrowth (see PETROLOGY, Plate II. fig. 6). The term was subsequently used by Naumann to signify also the coarsely crystalline veins rich in quartz, feldspar and muscovite, which often in great numbers ramify through outcrops of granite and the surrounding rocks. This application of the name has now obtained general acceptance, and has been extended by many authors to include vein-rocks of similar structure and geological relationships, which occur with syenites, diorites and gabbros. Only a few of these pegmatites have graphic structure or mutual intergrowth of their constituents. Many of them are exceedingly coarse-grained; in granite-pegmatites the feldspars may be several feet or even yards in diameter, and other minerals such as apatite and tourmaline often occur in gigantic crystals. Pegmatites consist of minerals which are found also in the rocks from which they are derived, e.g. granite-pegmatites contain principally quartz and feldspar while gabbro-pegmatites consist of diallage and plagioclase. Rare minerals, however, often occur in these veins in exceptional amount and as very perfect crystals. The minerals of the pegmatites are always those which were last to separate out from the parent rock. As the basic minerals are the first formed the pegmatites contain a larger proportion of the acid or more siliceous components which were of later origin. In granite-pegmatites there is little hornblende, biotite or sphene, but white mica, feldspar and quartz make up the greater part of the veins. In gabbro-pegmatites olivine seldom occurs, but diallage and plagioclase occur in abundance. In this respect the pegmatites and apaites agree; both are of more acid types than the average rock from which they came, but the pegmatites are coarsely crystalline while the apaites are fine-grained. Segregations of the early minerals of a rock are frequent as nodules, lumps and streaks scattered through its mass, and often dikes of basic character (lamprophyres, &c.) are injected into the surrounding country. These have been grouped together as intrusions of *melanocratic facies* (μῆλας, black, κρῆσις, strength, predominance) because in them the dark basic minerals preponderate. The apaites and pegmatites, on the other hand, are *leucocratic* (λευκός, white), since they are of acid character and contain relatively large amounts of the white minerals quartz and feldspar.

Pegmatites are associated with plutonic or intrusive rocks and were evidently formed by slow crystallization at considerable depths below the surface: nothing similar to them is known in lavas. They are very characteristic of granites, especially those which contain muscovite and much alkali feldspar; in gabbros, diorites and syenites pegmatite dikes are comparatively rare. The coarsely crystalline structure may be ascribed to slow crystallization; and is partly the result of the rocks, in which the veins lie, having been at a high temperature when the minerals of the pegmatites separated out. In accordance with this we find that pegmatite veins are nearly always restricted

to the area occupied by the parent rock (e.g. the granite), or to its immediate vicinity, and within the zone which has been greatly heated by the plutonic intrusion, viz. the contact aureole. Another very important factor in producing the coarse crystallization of the pegmatite veins is the presence of abundant water vapour and other gases which served as mineralizing agents and facilitated the building together of the rock molecules in large crystalline individuals.

Proof that these vapours were important agents in the formation of pegmatites is afforded by many of the minerals contained in the veins. Boron, fluorine, hydrogen, chlorine and other volatile substances are essential components of some of these minerals. Thus tourmaline, which contains boron and fluorine, may be common in the pegmatites but rare in the granite itself. Fluorine or chlorine are present in apatite, another frequent ingredient of granite pegmatites. Muscovite and gilbertite both contain hydrogen and fluorine; topaz is rich in fluorine also and all of these are abundant in some pegmatites. The stimulating effect which volatile substances exert on crystallizing molten masses is well known to experimental geologists who, by mixing tungstates and fluorides with fused powders, have been able to produce artificial minerals which they could not otherwise obtain. Most pegmatites are truly igneous rocks so far as their composition goes, but in their structure they show relations to the aqueous mineral veins. Many of them for example have a comby structure, that is to say, their minerals are columnar and stand perpendicular to the walls of the fissure occupied by the vein. Sometimes they have a banding owing to successive deposits having been laid down of different character; mica may be external, then feldspar, and in the centre a leader or string of pure quartz. In pegmatite veins also there are very frequently cavities or vugs, which are lined by crystals with very perfect faces. These bear much resemblance to the microlitic or drusy cavities common in granite, and like them were probably filled with the residual liquid which was left over after the mineral substances were deposited in crystals.

Pegmatites are very irregular not only in distribution, width and persistence, but also in composition. The relative abundance of the constituent minerals may differ rapidly and much from point to point. Sometimes they are rich in mica, in enormous crystals for which the rock is mined or quarried (India). Other pegmatites are nearly pure feldspar, while others are locally (especially near their terminations) very full of quartz. They may in fact pass into quartz veins (alsakites) some of which are auriferous (N. America). Quartz veins of another type are very largely developed, especially in regions of slate and phyllite; they are produced by segregation of dissolved silica from the country rock and its concentration into cracks produced by stretching of the rock masses during folding. In these segregation veins, especially when the beds are of feldspathic nature, crystals of albite and orthoclase may appear, in large or small quantity. In this way a second type of pegmatite (segregation pegmatite) is formed which is very difficult to distinguish from true igneous veins. These two have, however, much in common as regards the conditions under which they were formed. Great pressures, presence of water, and a high though not necessarily very high temperature were the principal agencies at work.

Granite pegmatites are laid down after their parent mass had solidified and while it was cooling down: sometimes they contain such minerals as garnet, not found in the main mass, and showing that the temperature of crystallization was comparatively low. Another special feature of these veins is the presence of minerals containing precious metals or rare earths. Gold occurs in not a few cases; tin in others, while sulphides such as copper pyrites are found also. Beryl is the component of the minerals of the second group; spodumene is another example, and there is much reason to hold that diamond is a native of some of the pegmatites of Brazil and India, though this is not yet incontestably proved. The syenite-pegmatites of south Norway are remarkable both for their coarse crystallization and for the great number of rare minerals they have yielded. Among these may be mentioned laevenerite, rinkite, rosenbuschite, mosandrite, pyrochlore, pectolite and lampophyllite.

(J. S. F.)

PEGNITZ, a river of Germany. It rises near Lindenhard in Upper Franconia (Bavaria) from two sources. At first it is called the Fichtenöhe, but at Buchau it takes the name of the Pegnitz, and flowing in a south-westerly direction disappears below the small town of Pegnitz in a mountain cavern. It emerges through three orifices, enters Middle Franconia, and after flowing through the heart of the city of Nuremberg falls into the Regnitz at Fürth.

See Specht, *Das Pegnitzgebiet in Bezug auf seinen Wasserhaushalt* (Munich, 1905).

The *Pegnitz Order* (Order of the society of Pegnitz shepherds), also known as "the crowned flower order on the Pegnitz," was one of the societies founded in Germany in the course of the 17th century for the purification and improvement of the German language, especially in the domain of poetry. Georg Philipp Harsdörffer and Johann Klaj instituted the order in Nuremberg in 1644, and named it after the river. Its emblem was the passion flower with Pan's pipes, and the motto *Mit Nusen erfreulich, or Alle zu einem Ton einstimmig*. The members set themselves the task of counteracting the pedantry of another school of poetry by imagination and gaiety, but lacking imagination and broad views they took refuge in allegorical subjects and puerile trifling. The result was to debase rather than to raise the standard of poetic art in Germany. At first the meetings of the order were held in private grounds, but in 1681 they were transferred to a forest near Kraftshof or Naunhof. In 1794 the order was reorganized, and it now exists merely as a literary society.

See Tittman, *Die nürnbergische Dichterschule* (Göttingen, 1847); and the *Festschrift zur 250-jährigen Jubelfeier des pegnesischen Blumenordens* (Nuremberg, 1894).

PEGOLOTTI, FRANCESCO BALDUCCI (fl. 1315-1340), Florentine merchant and writer, was a factor in the service of the mercantile house of the Bardi, and in this capacity we find him at Antwerp from 1315 (or earlier) to 1317; in London in 1317 and apparently for some time after; in Cyprus from 1324 to 1327, and again (or perhaps in unbroken continuation of his former residence) in 1335. In this last year he obtained from the king of Little Armenia (i.e. medieval Cilicia, &c.) a grant of privileges for Florentine trade. Between 1335 and 1343, probably in 1339-1340, he compiled his *Libro di divisamenti di paesi e di misuri di mercantorie e d'altre cose bisognevoli di sapere a mercatanti*, commonly known as the *Pratica della mercatura* (the name given it by Pegnini). Beginning with a sort of glossary of foreign terms then in use for all kinds of taxes or payments on merchandise as well as for "every kind of place where goods might be bought or sold in cities," the *Pratica* next describes some of the chief trade routes of the 14th century, and many of the principal markets then known to Italian merchants; the imports and exports of various important commercial regions; the business customs prevalent in each of those regions; and the comparative value of the leading moneys, weights and measures. The most distant and extensive trade routes described by Pegolotti are: (1) that from Tana or Azov to Peking via Astrakhan, Khiva, Otrar, Kulja and Kanchow (Gittarchan, Organci, Ottrarre, Armalecto and Cameru in the *Pratica*); (2) that from Lajazzo on the Cilician coast to Tabriz in north Persia via Sivas, Erzangan and Erzerum (Salvastro, Arzinga and Arzerone); (3) that from Trebizond to Tabriz. Among the markets enumerated are: Tana, Constantinople, Alexandria, Damietta, and the ports of Cyprus and the Crimea. Pegolotti's notices of ports on the north of the Black Sea are very valuable; his works show us that Florentine exports had now gained a high reputation in the Levant. In other chapters an account is given of 14th-century methods of packing goods (ch. 29); of assaying gold and silver (ch. 35); of shipment; of "London in England in itself" (ch. 62); of monasteries in Scotland and England ("Scotland of England," *Scotia di Inghilterra*) that were rich in wool (ch. 63). Among the latter are Newbattle, Balmerino, Cupar, Dunfermline, Dundrennan, Glenluce, Coldingham, Kelso, Newminster near Morpeth, Furness, Fountains, Kirkstall, Kirstead, Swiashead, Sawley

and Calder. Pegolotti's interest in England and Scotland is chiefly connected with the wool trade.

There is only one MS. of the *Pratica*, viz. No. 2441 in the Riccardian Library at Florence (241 fols., occupying the whole volume), written in 1471; and one edition of the text, in vol. iii. of Gian Francesco Pagnini's *Della Decima e delle altre grappe imposte dal comune di Firenze* (Lisbon and Lucca—really Florence—1766); Sir Henry Yule, *Cathay*, ii. 279-308, translated into English the most interesting sections of Pegolotti, with valuable commentary (London, Hakluyt Society, 1866). See also W. Heyd, *Commerce du Levant*, ii. 12, 50, 58, 78-79, 85-86, 112-119 (Leipzig, 1886); H. Kiepert, in *Sitzungsberichte der philos.-hist. Cl. der Berliner Akad.*, p. 901, &c. (Berlin, 1881); C. R. Beazley, *Dawn of Modern Geography*, iii. 324-332, 350, 355 (Oxford, 1906).

PEGU, a town and former capital of Lower Burma, giving its name to a district and a division. The town is situated on a river of the same name, 47 m. N.E. of Rangoon by rail; pop. (1901), 14,132. It is still surrounded by the old walls, about 40 ft. wide, on which have been built the residences of the British officials. The most conspicuous object is the Shwemaw-daw pagoda, 324 ft. high, considerably larger and even more holy than the Shwe-dagon pagoda at Rangoon. Pegu is said to have been founded in 573, as the first capital of the Talaings; but it was as the capital of the Toungoo dynasty that it became known to Europeans in the 16th century. About the middle of the 18th century it was destroyed by Alompra; but it rose again, and was important enough to be the scene of fighting in both the first and second Burmese Wars. It gave its name to the province (including Rangoon) which was annexed by the British in 1852.

The district, which was formed in 1883, consists of an alluvial tract between the Pegu Yoma range and the Sittang river: area, 4276 sq. m.; pop. (1901), 339,572, showing an increase of 43 % in the decade. Christians numbered nearly 9000, mostly Karens. Almost the only crop grown is rice, which is exported in large quantities to Rangoon. The district is traversed by the railway, and also crossed by the Pegu-Sittang canal, navigable for 85 m., with locks.

The division of Pegu comprises the five districts of Rangoon city, Hanthawaddy, Tharrawaddy, Pegu and Prome, lying east of the Irrawaddy: area 13,084 sq. m.; pop. (1901), 1,820,638.

Pegu has also given its name to the Pegu Yoma, a range of hills running north and south for about 200 m., between the Irrawaddy and Sittang rivers. The height nowhere exceeds 5000 ft. but the slopes are steep and rugged. The forests yield teak and other valuable timber. The Pegu river, which rises in this range, falls into the Rangoon river just below Rangoon city, after a course of about 180 m.

PHILE, JOHN (1838-1910), English philologist, was born at Whitehaven on the 24th of April 1838. He was educated at Repton and Christ's College, Cambridge. After a distinguished career (Craven scholar, senior classic and chancellor's medallist), he became fellow and tutor of his college, reader of comparative philology in the university (1884-1891), and in 1887 was elected master of Christ's. He took a great interest in the higher education of women and became president of Newnham College. He was the first to introduce the great philological works of George Curtius and Wilhelm Corssen to the English student in his *Introduction to Greek and Latin Etymology* (1869). He died at Cambridge on the 9th of October 1910, leaving practically completed his exhaustive history of Christ's College.

PEINE, a town of Germany, in the Prussian province of Hanover, 16 m. by rail N.W. of Brunswick, on the railway to Hanover and Hamburg. Pop. (1905), 15,421. The town has a Roman Catholic and a Protestant church and several schools. Its industries include iron and steel works, breweries, distilleries and brickyards, and the manufacture of starch, sugar, malt, machinery and artificial manure. There are also large horse and cattle markets held here. Peine was at one time a strongly fortified place, and until 1803 belonged to the bishopric of Hildesheim.

PEINE FORTE ET DURE (French for "hard and severe punishment"), the term for a barbarous torture inflicted on those who, arraigned of felony, refused to plead and stood silent, or

challenged more than twenty jurors, which was deemed a contumacy equivalent to a refusal to plead. By early English law a prisoner, before he could be tried, must plead "guilty" or "not guilty." Before the 13th century it was usual to imprison and starve till submission, but in Henry IV.'s reign the *peine* was employed. The prisoner was stretched on his back, and stone or iron weights were placed on him till he either submitted or was pressed to death. Pressing to death was abolished in 1772; "standing mute" on an arraignment of felony being then made equivalent to conviction. By an act of 1828 a plea of "not guilty" was to be entered against any prisoner refusing to plead, and that is the rule to-day. An alternative to the *peine* was the tying of the thumbs tightly together with whipcord until pain forced the prisoner to speak. This was said to be a common practice at the Old Bailey up to the 19th century.

Among recorded instances of the infliction of the *peine* are: Juliana Quick (1442) for high treason in speaking derisively of Henry VI.; Margaret Clitherow, "the martyr of York" (1586); Walter Calverly, of Calverly, Yorks, for the murder of his children (1605); and Major Strangways at Newgate, charged with murder of his brother-in-law (1657). In this last case it is said that upon the weights being placed in position several cavalier friends of Strangways sprang on his body and put him out of his pain. In 1721 one Nathaniel Hawes lay under a weight of 250 lb for seven minutes, finally submitting. The *peine* was last employed in 1741 at Cambridge assizes, when a prisoner was so put to death; the penalty of thumb-tying having first been tried. In 1692 at Salem, Massachusetts, Giles Corey, accused of witchcraft, refusing to plead, was pressed to death. This is believed to be the only instance of the infliction of the *peine* in America.

PEIPUS, or ЧУДСКОЕ ОЗЕРО, a lake of north-west Russia, between the governments of St Petersburg, Pskov, Livonia and Esthonia. Including its southern extension, sometimes known as Lake Pskov, it has an area of 1356 sq. m. Its shores are flat and sandy, and in part wooded; its waters deep, and they afford valuable fishing. The lake is fed by the Velikaya, which enters it at its southern extremity, and by the Embach, which flows in half way up its western shore; it drains into the Gulf of Finland by the Narova, which issues at its north-east corner.

PEIRÆUS, or ΠΙΡÆΙΟΣ (Gr. Πειραιεύς), the port town of Athens, with which its history is inseparably connected. Pop. (1907), 67,982. It consists of a rocky promontory, containing three natural harbours, a large one on the north-west which is still one of the chief commercial harbours of the Levant, and two smaller ones on the east, which were used chiefly for naval purposes. Themistocles was the first to urge the Athenians to take advantage of these harbours, instead of using the sandy bay of Phaleron; and the fortification of the Peiræus was begun in 493 B.C. Later on it was connected with Athens by the Long Walls in 460 B.C. The town of Peiræus was laid out by the architect Hippodamus of Miletus, probably in the time of Pericles. The promontory itself consisted of two parts—the hill of Munychia, and the projection of Acte; on the opposite side of the great harbour was the outwork of Etioneia. The most stirring episode in the history of the Peiræus is the seizure of Munychia by Thrasylulus and the exiles from Phyle, and the consequent destruction of the "30 tyrants" in 404 B.C. The three chief arsenals of the Peiræus were named Munychia, Zea and Cantharus, and they contained galley slips for 82, 196 and 94 ships respectively in the 4th century B.C.

See under ATHENS. Also Angelopoulos, *Παρά Πειραιώς και τὸν ἄλκιον αἰῶνα* (Athens, 1898).

PEIRCE, BENJAMIN (1809-1880), American mathematician and astronomer, was born at Salem, Massachusetts, on the 4th of April 1809. Graduating at Harvard College in 1829, he became mathematical tutor there in 1831 and professor in 1833. He had already assisted Nathaniel Bowditch in his translation of the *Mécanique céleste*, and now produced a series of mathematical textbooks characterized by the brevity and terseness which made his teaching unattractive to inept pupils. Young men of talent, on the contrary, found his instruction most stimulating, and after Bowditch's death in 1838 Peirce stood first among American mathematicians. His researches into the perturbations of Uranus and Neptune (*Proc. Amer.*

Acad., 1848) gave him a wider fame; he became in 1849 consulting astronomer to the *American Nautical Almanac*, and for this work prepared new tables of the moon (1852). A discussion of the equilibrium of Saturn's rings led him to conclude in 1855 that they must be of a fluid nature. From 1867 to 1874 he was superintendent of the Coast Survey. In 1857 he published his best known work, the *System of Analytical Mechanics*, which was, however, surpassed in brilliant originality by his *Linear Associative Algebra* (lithographed privately in a few copies, 1870; reprinted in the *Amer. Journ. Math.*, 1882). He died at Cambridge, Mass., on the 6th of October 1880.

See *New Amer. Cyclopaedia* (Ripley and Dana), vol. xiii. (1861); T. J. J. See, *Popular Astronomy*, iii. 49; *Nature*, xxii. 607; R. Grant, *Hist. of Phys. Astronomy*, pp. 205, 292; J. C. Foggendorf, *Biog. lit. Handwörterbuch*; *Month. Notices Roy. Astr. Society*, xli. 191.

PEISANDER, of Camirus in Rhodes, Greek epic poet, supposed to have flourished about 640 B.C. He was the author of a *Heracleia*, in which he introduced a new conception of the hero, the lion's skin and club taking the place of the older Homeric equipment. He is also said to have fixed the number of the "labours of Hercules" at twelve. The work, which according to Clement of Alexandria (*Stromata*, vi. ch. 2) was simply a plagiarism from an unknown Pisinus of Lindus, enjoyed so high a reputation that the Alexandrian critics admitted the author to the epic canon. From an epigram (20) of Theocritus we learn that a statue was erected in honour of Peisander by his countrymen. He is to be distinguished from Peisander of Laranda in Lycia, who lived during the reign of Alexander Severus (A.D. 222-235), and wrote a poem on the mixed marriages of gods and mortals, after the manner of the *Loiai* of Hesiod.

See fragments in G. Kinkel, *Epicorum graecorum fragmenta* (1878); also F. G. Weicker, *Kleine Schriften*, vol. i. (1844), on the twelve labours of Hercules in Peisander.

PEISISTRATUS, (605?-527 B.C.), Athenian statesman, was the son of Hippocrates. He was named after Peisistratus, the youngest son of Nestor, the alleged ancestor of his family; he was second cousin on his mother's side to Solon, and numbered among his ancestors Codrus the last great king of Athens. Thus among those who became "tyrants" in the Greek world he gained his position as one of the old nobility, like Phalaris of Agrigentum, and Lydgamis of Naxos; but unlike Orthagoras of Sicily, who had previously been a cook. Peisistratus, though Solon's junior by thirty years, was his lifelong friend (though this is denied), nor did their friendship suffer owing to their political antagonism. From this widely accepted belief arose the almost certainly false statement that Peisistratus took part in Solon's successful war against Megara, which necessarily took place before Solon's archonship (probably in 600 B.C.). Aristotle's *Constitution of Athens* (ch. 17) carefully distinguishes Solon's Megarian War from a second in which Peisistratus was no doubt in command, undertaken between 570 and 565 to recapture Nisaea (the port of Megara) which had apparently been recovered by the Megarians since Solon's victory (see Sandys on *The Constitution of Athens*, ch. 14, 1, note, and E. Abbott, *History of Greece*, vol. i. app. p. 544). Whatever be the true explanation of this problem, it is certain (1) that Peisistratus was regarded as a leading soldier, and (2) that his position was strengthened by the prestige of his family. Furthermore (3) he was a man of great ambition, persuasive eloquence and wide generosity; qualities which especially appealed at that time to the classes from whom he was to draw his support—hence the warning of Solon (Frag. II. B): "Fools, you are treading in the footsteps of the fox; can you not read the hidden meaning of these charming words?" Lastly, (4) and most important, the times were ripe for revolution. In the article on SOLON (*ad fin.*) it is shown that the Solonian reforms, though they made a great advance in some directions, failed on the whole. They were too moderate to please the people, too democratic for the nobles. It was found that the government by Boule and Ecclesia did not mean popular control in the full sense; it meant government by the leisured classes, inasmuch as the industrious farmer or herdsmen could not leave his work to give his vote at the Ecclesia, or do his duty as a councillor. Partly owing to this, and partly to

ancient feuds whose origin we cannot trace, the Athenian people was split up into three great factions known as the Plain (*Pediis*) led by Lycurgus and Miltiades, both of noble families; the Shore (*Parali*) led by the Alcmaeonidae, represented at this time by Megacles, who was strong in his wealth and by his recent marriage with Agariste, daughter of Cleisthenes of Sicyon; the Hill or Upland (*Diacreis*, *Diacrii*) led by Peisistratus, who no doubt owed his influence among these hillmen partly to the possession of large estates at Marathon. In the two former divisions the influence of wealth and birth predominated; the hillmen were poorly housed, poorly clad and unable to make use of the privileges which Solon had given them.¹ Hence their attachment to Peisistratus, the "man of the people," who called upon them to sweep away the last barriers which separated rich and poor, nobles and commoners, city and countryside. Lastly, there was a class of men who were discontented with the Solonian constitution: some had lost by his Seisachtheia, others had vainly hoped for a general redistribution. These men saw their only hope in a revolution. Such were the factors which enabled him to found his tyranny.

To enter here into an exhaustive account of the various theories which even before, though especially after, the appearance of the *Constitution of Athens* have been propounded as to the chronology of the Peisistratean tyranny, is impossible. For a summary of these hypotheses see J. E. Sandys's edition of the *Constitution of Athens* (p. 56, c. 14 note). The following is in brief the sequence of events: In 560 B.C. Peisistratus drove into the market-place, showed to an indignant assembly marks of violence on himself and his mules, and claimed to be the victim of assault at the hands of political enemies. The people unhesitatingly awarded their "champion" a bodyguard of fifty men (afterwards four hundred) armed with clubs. With this force he proceeded to make himself master of the Acropolis and tyrant of Athens. The Alcmaeonids fled and Peisistratus remained in power for about five years, during which Solon's death occurred. In 555 or 554 B.C. a coalition of the Plain and the Coast succeeded in expelling him. His property was confiscated and sold by auction, but in his absence the strife between the Plain and the Coast was renewed, and Megacles, unable to hold his own, invited him to return. The condition was that their families should be allied by the marriage of Peisistratus to Megacles' daughter Coesyra. A second *coup d'état* was then effected. A beautiful woman, it is said, by name Phya, was disguised as Athena and drove into the Agora with Peisistratus at her side, while proclamations were made that the goddess herself was restoring Peisistratus to Athens. The ruse was successful, but Peisistratus soon quarrelled with Megacles over Coesyra. By a former marriage he already had two sons, Hippias and Hipparchus, now growing up, and in his first tyranny or his first exile he married an Argive, Timonassa, by whom he had two other sons Iophon and Hegesistratus, the latter of whom is said to be identical with Thessalus (*Ath. Pol.* c. 17), though from Thucydides and Herodotus we gather that they were distinct—e.g. Herodotus describes Hegesistratus as a bastard, and Thucydides says that Thessalus was legitimate. Further it is suggested that Peisistratus was unwilling to have children by one on whom lay the curse of the Cyclonian outrage. The result was that in the seventh year (or month, see *Ath. Pol.* c. 15, 1, Sandys's note) Megacles accused him of neglecting his daughter, combined once more with the third faction, and drove the tyrant into an exile lasting apparently for ten or eleven years. During this period he lived first at Rhacelus and later near Mt Pangaeus and on the Strymon collecting resources of men and money. He came finally to Eretria, and, with the help of the Thebans and Lydgamis of Naxos, whom he afterwards made ruler of that island, he passed over to Attica and defeated the Athenian forces at the battle of Pallenis or Pellene. From this time till his death he remained undisputed master of Athens. The Alcmaeonids were compelled to leave Athens, and from

¹ It is suggested with probability that the Diacrii were rather the miners of the Laurium district (P. M. Ure, *Journ. Hell. Stud.*, 1906, pp. 131-142).

the other noble families which remained he exacted 200 hostages whom he put in the care of his ally Lygdamis.

In the heyday of the Athenian democracy, citizens both conservative and progressive, politicians, philosophers and historians were unanimous in their denunciation of "tyranny." Yet there is no doubt that the rule of Peisistratus was most beneficial to Athens both in her foreign and in her internal relations. (1) During his enforced absence from Athens he had evidently acquired a far more extended idea of the future of Athens than had hitherto dawned on the somewhat parochial minds of her leaders. He was friendly with Thebes and Argos; his son Hegesistratus he set in power at Sigeum (see E. Abbott, *Hist. of Gr.* vol. i. xv. 9) and his friend Lygdamis at Naxos. From the mines of Thrace, and perhaps from the harbour dues and from the mines of Laurium, he derived a large revenue; under his encouragement, Miltiades had planted an Athenian colony on the shores of the Thracian Chersonese; he had even made friends with Thessaly and Macedonia, as is evidenced by the hospitality extended by them to Hippias on his final expulsion. Finally, he did not allow his friendliness with Argos to involve him in war with Sparta, towards whom he pursued a policy of moderation. (2) At home it is admitted by all authorities that his rule was moderate and beneficent, and that he was careful to preserve at least the form of the established constitution. It is even said that, being accused of murder, he was ready to be tried by the Areopagus. Everything which he did during his third period of rule was in the interests of discipline and order. Thus he hired a mercenary bodyguard, and utilized for his own purposes the public revenues; he kept the chief magistracies (through which he ruled) in the hands of his family; he imposed a general tax¹ of 10% (perhaps reduced by Hippias to 5%) on the produce of the land, and thus obtained control over the fleet and spread the burden of it over all the citizens (see the spurious letter of Peisistratus to Solon, *Diog. Laert.* i. 53; Thuc. vi. 54 and Arnold's note *ad loc.*; Boeckh iii. 6; Thirlwall c. xi., pp. 72-74; and Grote). But the great wisdom of Peisistratus is shown most clearly in the skill with which he blinded the people to his absolutism. Pretending to maintain the Solonian constitution (as he could well afford), he realized that people would never recognize the deception if a sufficient degree of prosperity were ensured. Secondly, he knew that the greater the proportion of the Athenians who were prosperously at work in the country and therefore did not trouble to interfere in the work of government the less would be the danger of sedition, whose seeds are in a crowded city. Hence he appears to have encouraged agriculture by abating the tax on small farms, and even by assisting them with money and stock. Secondly, he established deme law-courts to prevent people from having recourse to the city tribunals; it is said that he himself occasionally "went on circuit," and on one of these occasions was so struck by the complaints of an old farmer on Hymettus, that he remitted all taxation on his land. Thus Athens enjoyed immunity from war and internecine struggle, and for the first time for years was in enjoyment of settled financial prosperity (see *Constitution of Athens*, c. 16. 7 ὁ κρι Κόρου βίος).

The money which he accumulated he put to good use in the construction of roads and public buildings. Like Cleisthenes of Sicyon and Periander of Corinth, he realized that one great source of strength to the nobles had been their presidency over the local cults. This he diminished by increasing the splendour of the Panathenaic festival every fourth year and the Dionysiac² rites, and so created a national rather than a local religion. With the same idea he built the temple of the Pythian Apollo and began, though he did not finish, the temple of Zeus (the magnificent columns now standing belong to the age of Hadrian).

¹ It should be noted as against this, the general account, that Thucydides, speaking apparently with accuracy, describes the tax as *εὐνορία* (5%); the *Constitution of Athens* speaks of (the familiar) *ἀναρά* (10%).

² Dionysus, as the god of the rustics, was especially worshipped at Icaria, near Marathon, and so was the god of the Dacrii. It seems likely that Peisistratus, to please his supporters, originated the City-Dionysia.

To him are ascribed also the original Parthenon on the Acropolis, afterwards burned by the Persians, and replaced by the Parthenon of Pericles. It is said that he gave a great impetus to the dramatic representations which belonged to the Dionysiac cult, and that it was under his encouragement that Thespis of Icaria, by impersonating character, laid the foundation of the great Greek drama of the 5th and 4th centuries. Lastly, Peisistratus carried out the purification of Delos, the sacred island of Apollo of the Ionians; all the tombs were removed from the neighbourhood of the shrine, the abode of the god of light and joy.

We have spoken of his services to the state, to the poor, to religion. It remains to mention his alleged services to literature. All we can reasonably believe is that he gave encouragement to poetry as he had done to architecture and the drama; Onomacritus, the chief of the Orphic succession, and collector of the oracles of Musaeus, was a member of his household. Honestly, or to impress the people, Peisistratus made considerable use of oracles (e.g. at the battle of Pelene), and his descendants, by the oracles of Onomacritus, persuaded Darius to undertake their restoration. As to the library of Peisistratus, we have no good evidence; it may perhaps be a fiction of an Alexandrian writer. There is strong reason for believing the story that he first collected the Homeric poems and that his was the text which ultimately prevailed (see HOMER).

It appears that Peisistratus was benevolent to the last, and like Julius Caesar, showed no resentment against enemies and calumniators. What Solon said of him in his youth was true throughout, "there is no better-disposed man in Athens, save for his ambition." He was succeeded by his sons Hippias and Hipparchus, by whom the tyranny was in various ways brought into disrepute.

It should be observed that the tyranny of Peisistratus is one of the many epochs of Greek history on which opinion has almost entirely changed since the age of Grote. Shortly, his services to Greece and to the world may be summed up under three heads: In foreign policy, he sketched out the plan on which Athens was to act in her external relations. He advocated (a) alliances with Argos, Thessaly and Macedonia, (b) ascendancy in the Aegean (Naxos and Delos), (c) control of the Hellespontine route (Sigeum and the Chersonese), (d) control of the Strymon valley (Mt Pangaeus and the Strymon). Further, his rule exemplifies what is characteristic of all the Greek tyrannies—the advantage which the ancient monarchy had over the republican form of government. By means of his sons and his deputies (or viceroys) and by his system of matrimonial alliances he gave Athens a widespread influence in the centres of commerce, and brought her into connexion with the growing sources of trade and production in the eastern parts of the Greek world. (2) His importance in the sphere of domestic policy has been frequently underrated. It may fairly be held that the reforms of Solon would have been futile had they not been fulfilled and amplified by the genius of Peisistratus. (3) It was under his auspices that Athens began to take the lead in literature. From this period we must date the beginning of Athenian literary ascendancy. But see ATHENS.

AUTHORITIES.—Ancients: Herod. i. 59; Plut. *Solon* 30; Arist. *Politics*, v. 12, 5-1315 b.; *Constitution of Athens* (*Ath. Pol.*) cc. 14-19. On the chronological problems see also F. Meyer, *Arist. Pol. and the Ath. Pol.* pp. 46-9; Gomperz, *Die Schrift v. Staatswesen*, &c. (1891); Bauer, *Leh. und hist. Forsch. z. Arist. Ath. Pol.* (50 sqq.). On the characteristics of the Peisistratid tyranny see Greenidge, *Handbook of Greek Constitutional History*, pp. 26 sqq.; and the histories of Greece. On the question of the family of Peisistratus see Wilamowitz-Moellendorf, *Aristoteles und Athen* (Berlin, 1893) and a criticism by E. M. Walker in the *Classical Review*, vol. viii. p. 206, col. 2.

(J. M. M.)

PEKIN, a city and the county-seat of Tazewell county, Illinois, U.S.A., on the Illinois river, in the central part of the state, about 11 m. S. of Peoria, and about 56 m. N. of Springfield. Pop. (1910), 9897. It is served by the Atchison, Topeka & Santa Fé, the Chicago & Alton, the Chicago, Peoria & St. Louis, the Illinois Central, the Cleveland, Cincinnati, Chicago & St. Louis, the Peoria Railway Terminal Company, the Peoria

& Peking Union and (for freight between Peoria and Peking) the Illinois Valley Belt railways. Situated in a rich agricultural region and in the Illinois coalfields, Peking is a shipping point and grain market of considerable importance, and has various manufactures. The value of the factory products in 1905 was \$1,121,130. Peking was first settled about 1830, was incorporated in 1839, and re-incorporated in 1874.

PEKING, or PEKIN, the capital of the Chinese Empire, situated in 39° 57' N. and 116° 20' E., on the northern extremity of the great alluvial delta which extends southward from its walls for 700 m. For nine centuries Peking, under various names and under the dominion of successive dynasties, has, with some short intervals, remained an imperial city. Its situation near the northern frontier recommended it to the Tatar invaders as a convenient centre for their power, and its peculiarly fortunate position as regards the supernatural terrestrial influences pertaining to it has inclined succeeding Chinese monarchs to accept it as the seat of their courts. In 986 it was taken by an invading force of Khitan Tatars, who adopted it as their headquarters and named it Nanking, or the "southern capital." During the early part of the 12th century the Chinese recaptured it and reduced it from the rank of a metropolis to that of a provincial city of the first grade, and called it Yen-shan Fu. In 1151 it fell into the hands of the Kin Tatars, who made it a royal residence under the name of Chung-tu, or "central capital." Less than a century later it became the prize of Jenghiz Khan, who, having his main interests centred on the Mongolian steppes, declined to move his court southwards. His great successor, Kublai Khan (1280-1294), rebuilt the town, which he called Yenking, and which became known in Chinese as Ta-tu, or "great court," and in Mongolian as Khanbalik (Cambaluc), or "city of the khan." During the reign of the first emperor of the dynasty (1368-1399) which succeeded that founded by Jenghiz Khan the court resided at the modern Nanking, but the succeeding sovereign Yung-lo (1403-1425) transferred his court to Pe-king (i.e. "north-court"), which has ever since been the seat of government. For further history see CAMBALUC.

During the periods above mentioned the extent and boundaries of the city varied considerably. Under the Kin dynasty the walls extended to the south-west of the Tatar portion of the present city, and the foundations of the northern ramparts of the Khan-balik of Kublai Khan are still to be traced at a distance of about 2 m. north beyond the existing walls. The modern city consists of the *nei ch'êng*, or inner city, commonly known to foreigners as the "Tatar city," and the *wai ch'êng*, or outer city, known in the same way as the "Chinese city." These names are somewhat misleading, as the inner city is not enclosed within the outer city, but adjoins its northern wall, which, being longer than the *nei ch'êng* is wide, outflanks it considerably at both ends. The outer walls of the double city contain an area of about 25 sq. m., and measure 30 m. in circumference. Unlike the walls of most Chinese cities, those of Peking are kept in perfect order. Those of the Tatar portion, which is the oldest part of the city, are 50 ft. high, with a width of 60 ft. at the base and 40 ft. at the top, while those of the Chinese city, which were built by the emperor Kia-tsing in 1543, measure 30 ft. in height, and have a width of 25 ft. at the base and 15 ft. at the top. The terre-plein is well and smoothly paved, and is defended by a crenellated parapet. The outer faces of the walls are strengthened by square buttresses built out at intervals of 60 yds., and on the summits of these stand the guard-houses for the troops on duty. Each of the sixteen gates of the city is protected by a semi-circular enceinte, and is surmounted by a high tower built in galleries and provided with countless loopholes.

Peking suffered severely during the Boxer movement and the siege of the legations in the summer of 1900. Not only were most of the foreign buildings destroyed, but also a large number of important Chinese buildings in the vicinity of the foreign quarter, including the ancient Hanlin Yuen, the boards of war, rites, &c. Almost the whole of the business quarter, the wealthiest part of the Chinese city, was laid in ashes (see CHINA: History).

The population of Peking is reckoned to be about 1,000,000, a number which is out of all proportion to the immense area enclosed within its walls. This disparity is partly accounted for by the facts that large spaces, notably in the Chinese city, are not built over, and that the grounds surrounding the imperial palace, private residences and temples are very extensive. One of such enclosures constitutes the British legation, and most of the other foreign legations are similarly, though not so sumptuously, lodged. Viewed from the walls Peking looks like a city of gardens. Few crowded neighbourhoods are visible, and the characteristic features of the scene which meets the eye are the upturned roofs of temples, palaces, and mansions, gay with blue, green and yellow glazed tiles, glittering among the groves of trees with which the city abounds. It is fortunate that the city is not close-built or crowded, for since the first advent of foreigners in Peking in 1860 nothing whatever had been done until 1900 to improve the streets or the drainage. The streets as originally laid out were wide and spacious, but being unpaved and undrained they were no better than mud tracks diversified by piles of garbage and foul-smelling stagnant pools. Such drainage as had at one time existed was allowed to get choked up, giving rise to typhoid fever of a virulent type. Some attempt has been made to improve matters by macadamizing one of the principal thoroughfares, but it will be the labour of a Hercules to cleanse this vast city from the accumulated filth of ages of neglect.

Enclosed within the Tatar city is the *Hwang ch'êng*, or "Imperial city," which in its turn encloses the *Tao-hin ch'êng*, or "Forbidden city," in which stands the emperor's palace. On the north of the *Tao-hin ch'êng*, and separated from it by a moat, is an artificial mound known as the *King-shan*, or "Prospect Hill." This mound, which forms a prominent object in the view over the city, is about 150 ft. high, and is topped with five summits, on each of which stands a temple. It is encircled by a wall measuring upwards of a mile in circumference, and is prettily planted with trees, on one of which the last emperor of the Ming dynasty (1644), finding escape from the Manchu invaders impossible, hanged himself. On the west of Prospect Hill is the *Si yuan*, or "Western Park," which forms part of the palace grounds. This park is tastefully laid out, and is traversed by a lake, which is mainly noticeable from the remarkably handsome marble bridge which crosses it from east to west. Directly northwards from Prospect Hill stands the residence of the T'itu, or "governor of the city," and the Bell and the Drum Towers, both of which have attained celebrity from the nature of their contents—the first from the huge bell which hangs in it, and the second from the appliances it contains for marking the time. The bell is one of five which the emperor Yung-lo ordered to be cast. In common with the others, it weighs 120,000 lb, is 14 ft. high, 34 ft. in circumference at the rim, and 9 in. thick. It is struck by a wooden beam swung on the outside, and only at the changes of the night-watches, when its deep tone may be heard in all parts of the city. In the Drum Tower incense-sticks, specially prepared by the astronomical board, are kept burning to mark the passage of time, in which important duty their accuracy is checked by a clepsydra. Another of Yung-lo's bells is hung in a Buddhist temple outside the north-west angle of the city wall, and is covered both on the inside and outside with the Chinese texts of the *Lankavatara Sûtra*, and the *Saddharma pundarika Sûtra*.

Turning southwards we come again to the Forbidden City, the central portion of which forms the imperial palace, where, in halls which for the magnificence of their proportions and barbaric splendour are probably not to be surpassed anywhere, the Son of Heaven holds his court. In the eastern and western portions of this city are situated the residences of the highest dignitaries of the empire; while beyond its confines on the south stand the offices of the six official boards which direct the affairs of the eighteen provinces. It was in the "yamên" of one of these boards—the *Lî Pw* or board of rites—that Lord Elgin signed the treaty at the conclusion of the war in 1860—an event which derives especial interest from the fact of its having been the first

occasion on which a European plenipotentiary ever entered Peking accompanied by all the pomp and circumstance of his rank.

Outside the Forbidden City the most noteworthy building is the Temple of Heaven, which stands in the outer or Chinese city. Here at early morning on the 21st of December the emperor offers sacrifice on an open altar to Shang-ti, and at periods of drought or famine presents prayers for relief to the same supreme deity. The altar at which these solemn rites are performed consists of a triple circular marble terrace, 210 ft. wide at the base, 150 in the middle and 90 at the top. The uppermost surface is paved with blocks of the same material forming nine concentric circles, the innermost consisting of nine blocks, and that on the outside of eighty-one blocks. On the central stone, which is a perfect circle, the emperor kneels. In the same temple stands the altar of prayer for good harvests, which is surmounted by a triple-roofed circular structure 90 ft. in height. The tiles of these roofs are glazed porcelain of the most exquisite deep-blue colour, and add a conspicuous element of splendour to the shrine.

The other powers of nature have shrines dedicated to them in the altar: to the Earth on the north of the city, the altars to the Sun and Moon outside the north-eastern and north-western angles respectively of the Chinese city, and the altar of agriculture inside the south gate of the Chinese city. Next to these in religious importance comes the Confucian temple, known as the *Kwo-ise-hien*. Here there is no splendour; everything is quite plain; and one hall contains all that is sacred in the building. There the tablets of "the soul of the most holy ancestral teacher, Confucius," and of his ten principal disciples stand as objects of worship for their countless followers. In one courtyard of this temple are deposited the celebrated ten stone drums which bear poetical inscriptions commemorative of the hunting expeditions of King Sūn (827-781 B.C.), in whose reign they are believed, though erroneously, to have been cut; and in another stands a series of stone tablets on which are inscribed the names of all those who have obtained the highest literary degree of *Tsin-shi* for the last five centuries.

In the south-eastern portion of the Tatar city used to stand the observatory, which was built by order of Kublai Khan in 1296. During the period of the Jesuit ascendancy in the reign of K'ang-hi (1661-1721), the superintendence of this institution was confided to Roman Catholic missionaries, under whose guidance the bronze instruments formerly existing were constructed. The inhabitants of Peking being consumers only, and in no way producers, the trade of the city is very small, though the city is open to foreign commerce. In 1897 a railway was opened between Tientsin and Peking. This was only effected after great opposition from the ultra-Conservatives, but once accomplished the facilities were gladly accepted by all classes, and the traffic both in goods and passengers is already enormous. Out of deference to the scruples of the ultra-Conservatives, the terminus was fixed at a place called Lu-Kou-ch'iao, some 4 m. outside the walls, but this distance has since been covered by an electric tramway. The trunk line constructed by the Franco-Belgian syndicate connects Lu-Kou-ch'iao, the original terminus, with Hankow—hence the name Lu-Han by which this trunk line is generally spoken of, Lu being short for Lu-Kou-ch'iao and Han for Hankow.

BIBLIOGRAPHY.—A Williamson, *Journeys in North China, Manchuria and Eastern Mongolia* (2 vols., London, 1870); S. W. Williams, *The Middle Kingdom*, revised ed. (New York, 1883); A. Favier, *Peking, histoire et description* (Peking, 1900—contains over 800 illustrations, most of them reproductions of the work of Chinese artists); N. Oliphant, *A Diary of the Siege of the Legations in Peking during the Summer of 1900* (London, 1901); A. H. Smith, *China in Convulsion* (2 vols., Edinburgh, 1902). (R. K. D.)

PELAGIA, ST. An Antiochene saint of this name, a virgin of fifteen years, who chose death by a leap from the housetop rather than dishonour, is mentioned by Ambrose (*De virg.* iii. 7, 33; *Ep. xxviii. ad Simplic.*), and is the subject of two sermons by Chrysostom. Her festival was celebrated on the 8th of October (Wright's *Syriac Martyrology*). In the Greek *synaxaria*

the same day is assigned to two other saints of the name of Pelagia—one, also of Antioch, and sometimes called Margarito and also "the sinner"; the other, known as Pelagia of Tarsus, in Cilicia. The legend of the former of these two is famous. She was a celebrated dancer and courtesan, who, in the full flower of her beauty and guilty sovereignty over the youth of Antioch, was suddenly converted by the influence of the holy bishop Nonnus, whom she had heard preaching in front of a church which she was passing with her gay train of attendants and admirers. Seeking out Nonnus, she overcame his canonical scruples by her tears of genuine penitence, was baptized, and, disguising herself in the garb of a male penitent, retired to a grotto on the Mount of Olives, where she died after three years of strict penance. This story seems to combine with the name of the older Pelagia some traits from an actual history referred to by Chrysostom (*Hom. in Matth.* lvii. 3). In associating St Pelagia with St Marina, St Margaret (*q.v.*), and others of whom either the name or the legend recalls Pelagia, Hermann Usener has endeavoured to show by a series of subtle deductions that this saint is only a Christian travesty of Aphrodite. But there is no doubt of the existence of the first Pelagia of Antioch, the Pelagia of Ambrose and Chrysostom. The legends which have subsequently become connected with her name are the result of a very common development in literary history.

See *Acta sanctorum*, October, iv. 248 seq.; H. Usener, *Legenden der heiligen Pelagia* (Bonn, 1879); H. Delehaye, *The Legends of the Saints* (London, 1907), pp. 197-205. (H. DE.)

PELAGIUS, the name of two popes.

PELAGIUS I., pope from 555 to 561, was a Roman by birth, and first appears in history at Constantinople in the rank of deacon, and as apocrisiarius of Pope Silverius, whose overthrow in favour of Vigilius his intrigues promoted. Vigilius continued him in his diplomatic appointment, and he was sent by the emperor Justinian in 542 to Antioch on ecclesiastical business; he afterwards took part in the synod at Gaza which deposed Paul of Alexandria. He had amassed some wealth, which on his return to Rome he so employed among the poor as to secure for himself great popularity; and, when Vigilius was summoned to Byzantium in 544, Pelagius, now archdeacon, was left behind as his vicar, and by his tact in dealing with Totila, the Gothic invader, saved the citizens from murder and outrage. He appears to have followed his master to Constantinople, and to have taken part in the Three Chapters controversy; in 553, at all events, he signed the "constitutum" of Vigilius in favour of these, and for refusing, with him, to accept the decrees of the fifth general council (the 2nd of Constantinople, 553) shared his exile. Even after Vigilius had approved the condemnation of the Three Chapters, Pelagius defended them, and even published a book on the subject. But when Vigilius died (June 7, 555), he accepted the council, and allowed himself to be designated by Justinian to succeed the late pope. It was in these circumstances that he returned to Rome; but most of the clergy, suspecting his orthodoxy, and believing him to have had some share in the removal of his predecessor, shunned his fellowship. He enjoyed, however, the support of Narses, and, after he had publicly purged himself of complicity in Vigilius's death in the church of St Peter, he met with toleration in his own immediate diocese. The rest of the western bishops, however, still held aloof, and the episcopate of Tuscany caused his name to be removed from the diptychs. This elicited from him a circular, in which he asserted his loyalty to the four general councils, and declared that the hostile bishops had been guilty of schism. The bishops of Liguria and Aemilia, headed by the archbishop of Milan, and those of Istria and Venice, headed by Paulinus of Aquileia, also withheld their fellowship; but Narses resisted the appeals of Pelagius who would have invoked the secular arm. Childbert, king of the Franks, also refused to interfere. Pelagius died on the 4th of March 561, and was succeeded by John III.

PELAGIUS II., a native of Rome, but of Gothic descent, was pope from 579 to 590, having been consecrated successor of Benedict I., without the sanction of the emperor, on the 26th of

November. To make his apologies for this irregularity he sent Deacon Gregory, who afterwards became Pope Gregory the Great, as his apocryphary to Constantinople. In 585 he sought to heal the schism which had subsisted since the time of Pelagius I. in connexion with the Three Chapters, but his efforts were without success. In 588 John, patriarch of Constantinople, by reviving the old and disputed claim to the title of oecumenic patriarch, elicited a vigorous protest from Pelagius; but the decretal which professes to convey the exact words of the document is now known to be false. He died in January 590, and was succeeded by Gregory I.

PELAGIUS (c. 360- c. 420), early British theologian. Of the origin of Pelagius almost nothing is known. The name is supposed to be a graecized form of the Cymric *Morgan* (sea-begotten). His contemporaries understood that he was of British (probably of Irish) birth, and gave him the appellation *Britio*. He was a large ponderous person, heavy both in body and mind (Jerome, "stolidissimus et Scotorum pulvibus praegravatus"). He was influenced by the monastic enthusiasm which had been kindled in Gaul by Athanasius (336), and which, through the energy of Martin of Tours (361), rapidly communicated itself to the Britons and Scots. For, though Pelagius remained a layman throughout his life, and though he never appears in any strict connexion with a coenobite fraternity, he yet adhered to monastic discipline ("veluti monachus"), and distinguished himself by his purity of life and exceptional sanctity ("egregio Christianus"). He seems to have been one of the earliest, if not the very earliest, of that remarkable series of men who issued from the monasteries of Scotland and Ireland, and carried back to the Continent in a purified form the religion they had received from it. Coming to Rome in the beginning of the 5th century (his earliest known writing is of date 405), he found a scandalously low tone of morality prevalent. But his remonstrances were met by the plea of human weakness. To remove this plea by exhibiting the actual powers of human nature became his first object. It seemed to him that the Augustinian doctrine of total depravity and of the consequent bondage of the will both cut the sinew of all human effort and threw upon God the blame which really belonged to man. His favourite maxim was, "If I ought, I can."

The views of Pelagius did not originate in a conscious reaction against the influence of the Augustinian theology, although each of these systems was developed into its ultimate form by the opposition of the other. Neither must too much weight be allowed to the circumstance that Pelagius was a monk, for he was unquestionably alive to the delusive character of much that passed for monkish sanctity. Yet possibly his monastic training may have led him to look more at conduct than at character, and to believe that holiness could be arrived at by rigour of discipline. This view of things suited his matter-of-fact temperament. Judging from the general style of his writings, his religious development had been equable and peaceful, not marked by the prolonged mental conflict, or the abrupt transitions, which characterized the experience of his great opponent. With no great penetration he saw very clearly the thing before him, and many of his practical counsels are marked by sagacity, and are expressed with the succinctness of a proverb ("corpus non frangendum, sed regendum est"). His interests were primarily ethical; hence his insistence on the freedom of the will and his limitation of the action of divine grace.

The peculiar tenets of Pelagius, though indicated in the commentaries which he published at Rome previous to 409, might not so speedily have attracted attention had they not been adopted by Coelestius, a much younger and bolder man than his teacher. Coelestius, probably an Italian, had been trained as a lawyer, but abandoned his profession for an ascetic life. When Rome was sacked by the Goths (410) the two friends crossed to Africa. There Pelagius once or twice met with Augustine, but very shortly sailed for Palestine, where he justly expected that his opinions would be more cordially received. Coelestius remained in Carthage with the view of receiving ordination. But Aurelius, bishop of Carthage, being warned

against him, summoned a synod, at which Paulinus, a deacon of Milan, charged Coelestius with holding the following six errors: (1) that Adam would have died even if he had not sinned; (2) that the sin of Adam injured himself alone, not the human race; (3) that new-born children are in the same condition in which Adam was before the fall; (4) that the whole human race does not die because of Adam's death or sin, nor will the race rise again because of the resurrection of Christ; (5) that the law gives entrance to heaven as well as the gospel; (6) that even before the coming of Christ there were men who were entirely without sin. To these propositions a seventh is sometimes added, "that infants, though unbaptized, have eternal life," a corollary from the third. Coelestius did not deny that he held these opinions, but he maintained that they were open questions, on which the Church had never pronounced. The synod, notwithstanding, condemned and excommunicated him. Coelestius, after a futile appeal to Rome, went to Ephesus, and there received ordination.

In Palestine Pelagius lived unmolested and revered, until in 415 Orosius, a Spanish priest, came from Augustine, who in the meantime had written his *De peccatorum meritis*, to warn Jerome against him. The result was that in June of that year Pelagius was cited by Jerome before John, bishop of Jerusalem, and charged with holding that man may be without sin, if only he desires it. This prosecution broke down and in December of the same year Pelagius was summoned before a synod of fourteen bishops at Diospolis (Lydda). The prosecutors on this occasion were two deposed Gallican bishops, Heros of Arles and Lazarus of Aix, but on account of the illness of one of them neither could appear. The proceedings, being conducted in various languages and by means of interpreters, lacked certainty, and justified Jerome's application to the synod of the epithet "miserable." But there is no doubt that Pelagius repudiated the assertion of Coelestius, that "the divine grace and help is not granted to individual acts, but consists in free will, and in the giving of the law and instruction." At the same time he affirmed that a man is able, if he likes, to live without sin and keep the commandments of God, inasmuch as God gives him this ability. The synod was satisfied with these statements, and pronounced Pelagius to be in agreement with Catholic teaching. Pelagius naturally plumed himself on his acquittal, and provoked Augustine to give a detailed account of the synod, in which he shows that the language used by Pelagius was ambiguous, but that, being interpreted by his previous written statements, it involved a denial of what the Church understood by *grace* and by man's dependence on it. The North African Church as a whole resented the decisions of Diospolis, and in 416 sent up from their synods of Carthage and Mileve (in Numidia) an appeal to Innocent, bishop of Rome, who, flattered by the tribute thus paid to the see of Rome, decided the question in favour of the African synods. And, though his successor Zosimus wavered for some time, he at length fell in with what he saw to be the general mind of both the ecclesiastical and the civil powers. For, simultaneously with the largely attended African synod which finally condemned Pelagianism in the West, an imperial edict was issued at Ravenna by Honorius on the 30th of April 418, peremptorily determining the theological question and enacting that not only Pelagius and Coelestius but all who accepted their opinions should suffer confiscation of goods and irrevocable banishment. Thus prompted, Zosimus drew up a circular inviting all the bishops of Christendom to subscribe a condemnation of Pelagian opinions. Nineteen Italian bishops refused, among them Julian of Eclanum in Apulia, a man of good birth, approved sanctity and great capacity, who now became the recognized leader of the movement. But not even his acuteness and zeal could redeem a cause which was rendered hopeless when the Eastern Church (Ephesus, 431) confirmed the decision of the West. Pelagius himself disappears after 420; Coelestius was at Constantinople seeking the aid of Nestorius in 428.

Pelagianism.—The system of Pelagius is a consistent whole, each part involving the existence of every other. Starting from the idea that "ability limits obligation," and resolved that men

should feel their responsibility, he insisted that man is able to do all that God commands, and that there is, and can be, no sin where the will is not absolutely free—able to choose good or evil. The favourite Pelagian formula, "Si necessitatis est, peccatum non est; si voluntatis, vitari potest," had an appearance of finality which imposed on superficial minds. The theory of the will involved in this fundamental axiom of Pelagianism is that which is commonly known as the "liberty of indifference," or "power of contrary choice"—a theory which affirms the freedom of the will, not in the sense that the individual is self-determined, but in the sense that in each volition and at each moment of life, no matter what the previous career of the individual has been, the will is in equipoise, able to choose good or evil. We are born characterless (non pleni), and with no bias towards good or evil (ut sine virtute, ita et sine vitio). It follows that we are uninjured by the sin of Adam, save in so far as the evil example of our predecessors misleads and influences us (non propingie sed exemplo). There is, in fact, no such thing as original sin, sin being a thing of will and not of nature; for if it could be of nature our sin would be chargeable on God the creator. This will, capable of good as of evil, being the natural endowment of man, is found in the heathen as well as in the Christian, and the heathen may therefore perfectly keep such law as they know. But, if all men have this natural ability to do and to be all that is required for perfect righteousness, what becomes of grace, of the aid of the Holy Spirit, and, in a word, of Christianity? Pelagius vacillates considerably in his use of the word "grace." Sometimes he makes it equivalent to natural endowment. Indeed one of his most careful statements is to this effect: "We distinguish three things—the ability, the will, the act (posse, velle, esse). The ability is in nature, and must be referred to God, who has bestowed this on His creature; the other two, the will and the act, must be referred to man, because they flow from the fountain of free will" (Aug., *De gr. Christi*, ch. 4). But at other times he admits a much wider range to grace, so as to make Augustine doubt whether his meaning is not, after all, orthodox. But, when he speaks of grace "sanctifying," "assisting," and so forth, it is only that man may "more easily," "accomplish what he could with more difficulty accomplish without" grace. A decisive passage occurs in the letter he sent to the see of Rome along with his *Confessio fidei*: "We maintain that free will exists generally in all mankind, in Christians, Jews and Gentiles; they have all equally received it by nature, but in Christians only is it assisted by grace. In others this good of their original creation is naked and unarmed. They shall be judged and condemned because, though possessed of free will, by which they might come to the faith and merit the grace of God, they make an ill use of their freedom; while Christians shall be rewarded because, by using their free will aright, they merit the grace of the Lord and keep His commandments" (ibid. chs. 33, 34). Pelagius allowed to grace everything but the initial determining movement towards salvation. He ascribed to the unassisted human will power to accept and use the proffered salvation of Christ. It was at this point his departure from the Catholic creed could be made apparent: Pelagius maintains, expressly and by implication, that it is the human will which takes the initiative, and is the determining factor in the salvation of the individual; while the Church maintains that it is the divine will that takes the initiative by renewing and enabling the human will to accept and use the aid or grace offered.

Semipelagianism.—It was easy for Augustine to show that this was an "impia opinio"; it was easy for him to expose the defective character of a theory of the will which implied that God was not holy because He is necessarily holy; it was easy for him to show that the positions of Pelagius were anti-Scriptural (see AUGUSTINE); but, though his arguments prevailed, they did not wholly convince, and the rise of Semipelagianism—an attempt to hold a middle course between the harshness of Augustinianism and the obvious errors of Pelagianism—is full of significance. This earnest and conciliatory movement discovered itself simultaneously in North Africa and in southern Gaul. In the former Church, which naturally desired to adhere to the views of its own great theologian, the monks of Adrumetum found themselves either sunk to the verge of despair or provoked to licentiousness by his predestinarian teaching. When this was reported to Augustine he wrote two elaborate treatises to show that when God ordains the end He also ordains the means, and if any man is ordained to life eternal he is thereby ordained to holiness and zealous effort. But meanwhile some of the monks themselves had struck out a *via media* which ascribed to God sovereign grace and yet left intact man's responsibility. A similar scheme was adopted by Cassian of Marseilles (hence Semipelagians are often spoken of as *Masilians*), and was afterwards ably advocated by Vincent of Lerins and Faustus of Rhegium. These writers, in opposition to Pelagius, maintained that man was damaged by the fall, and seemed indeed disposed to purchase a certificate of orthodoxy by the abusive epithets they heaped upon Pelagians (loahe, muscae morturae, &c.). The differentia of Semipelagianism is the tenet that in regeneration, and all that results from it, the divine and the human will are co-operating (synergistic) coefficient factors. After finding considerable acceptance, this theory was ultimately condemned, because it retained the root-principle of Pelagianism—that man has some ability to will good and that the beginning of salvation may be with man. The Councils of Orange and Valence

(529), however, which condemned Semipelagianism, did so with the significant restriction that predestination to evil was not to be taught—a restriction so agreeable to the general feeling of the Church that, three centuries after, Gottschalk was sentenced to be degraded from the priesthood, scourged and imprisoned for teaching reprobation. The questions raised by Pelagius continually recur, but, without tracing the strife as sustained by Thomists and Jansenists on the one side and the Jesuits and Arminians on the other, this article can only indicate the general bearing of the controversy on society and the Church.

The anthropology of Pelagius was essentially naturalistic. It threatened to supersede grace by nature, to deny all immediate divine influence, and so to make Christianity practically useless. Pelagius himself did not carry his rationalism through to its issues; but the logical consequence of his system was, as Augustine perceived, the denial of the atonement and other central truths of revealed religion. And, while the Pelagians never existed as a sect separate from the Church Catholic, yet wherever rationalism has infected any part of the Church there Pelagianism has sooner or later appeared; and the term "Pelagian" has been continued to denote views which minimize the effects of the fall and unduly magnify man's natural ability. These views and tendencies have appeared in theologies which are not in other respects rationalistic, as, e.g. in Arminianism; and their presence in such theologies is explained by the desire to remove everything which might seem to discourage human effort.

It is not easy to determine how far the vices which ate so deeply into the life of the Church of the middle ages were due to the sharpness with which some of the severer features of the Augustinian theology were defined during the Pelagian controversy. The pernicious belief in the magical efficacy of the sacraments and the consequent defective ethical power of religion, the superstitious eagerness to accept the Church's creed without examining or really believing it, the falsity and cruelty engendered and propagated by the idea that in the Church's cause all weapons were justifiable, these vices were undoubtedly due to the belief that the visible church was the sole divinely-appointed repository of grace. And the sharply accentuated tone in which Augustinianism affirmed man's inability quickened the craving for that grace or direct agency of God upon the soul which the Church declared to be needful and administered through her divinely appointed persons and sacraments, and thus brought a decided impulse to the development of the sacerdotal system.

Again, although it may fairly be doubted whether, as Baur supposes, Augustine was permanently tainted with the Manichean notion of the inherent evil of matter, it can scarcely be questioned that his views on marriage as elicited by the Pelagian controversy gave a considerable impulse to the already prevalent idea of the superiority of virginity. When the Pelagians declared that Augustine's theory of original sin discredited marriage by the implication that even the children of the regenerate were born in sin, he could only reply (*De nuptiis et concupiscentia*) that marriage now cannot partake of the spotless purity of the marriage of unfallen man, and that, though what is evil in concupiscentia is made a good use of in marriage, it is still a thing to be ashamed of—not only with the shame of natural modesty (which he does not take into account) but with the shame of guilt. So that, even although he is careful to point out the advantages of marriage, an indelible stigma is still left even on the lawful procreation of children.

"The Pelagians deserve respect," says Harnack, "for their purity of motive, their horror of the Manichean heaven and the *opus operatum*, their insistence on clearness, and their intention to defend the Deity. But we cannot but decide that their doctrine fails to recognize the misery of sin and evil, that in its deepest roots it is godless, that it knows, and seeks to know, nothing of redemption and that it is dominated by an empty formalism (a notional mythology), which does justice to no single point to actual quantities, and on a closer examination consists of sheer contradictions. In the form in which this doctrine was expressed by Pelagius—and in fact also by Julian—i.e. with all the accommodations to which he descended, it was not a novelty. But in its fundamental thought it was; or rather, it was an innovation because it abandoned in spite of all accommodations in expression, the role of the mystical doctrine of redemption, which the Church had steadfastly maintained side by side with the doctrine of freedom."

In the Pelagian controversy some of the fundamental differences between the Eastern and Western theologies appear. The former laid stress on "the supernatural character of Christianity as a fact in the objective world" and developed the doctrines of the Trinity and the Incarnation; the Western emphasized "the supernatural character of Christianity as an agency in the subjective world" and developed the doctrines of sin and grace. All the Greek fathers from Origen to Chrysostom had been jealous for human freedom and loath to make sin a natural power, though of course admitting a general state of sinfulness. The early British monasteries had been connected with the Orient. Pelagius was familiar with the Greek language and theology, and when he came to Rome he was much in the company of Rufinus and his circle who were endeavouring to propagate Greek theology in the Latin Church.

LITERATURE.—Pelagius's *Commentarii in epistolas Pauli, Libellus*

Ides ad Innocentium and *Epistola ad Demetriadem* are preserved in Jerome's works (vol. v. of Martiani's ed., vol. xi. of Vallarsi's). The last-named was also published separately by Semler (Halle, 1775). There are of course many citations in the Anti-Pelagian Treatises of Augustine. On the *Commentaries* see *Journal of Theol. Studies*, vii. 568, viii. 526; an edition is being prepared for the *Cambridge Texts and Studies* by A. Souter.

See also F. Wiggers, *Darstellung des Augustinismus und Pelagianismus* (6 vols., Berlin, 1831-1832; Eng. trans. of vol. i., by R. Emerson, Andover, 1840); J. L. Jacobi, *Die Lehre d. Pelagus* (Leipzig, 1842); F. Klasen, *Die innere Entwicklung des Pelagianismus* (Freiburg, 1882); B. B. Warfield, *Two Studies in the History of Doctrine* (New York, 1893); A. Harnack, *History of Dogma*, Eng. trans., v. 168-202; F. Loofs, *Doemensgeschichte* and art. in Hauck-Herzog's *Realencyclopädie für prot. Theologie u. Kirche* (end of vol. xv.), where a full bibliography is given. (M. D.)

PELASGIANS, a name applied by Greek writers to a prehistoric people whose traces were believed to exist in Greek lands. If the statements of ancient authorities are marshalled in order of their date it will be seen that certain beliefs cannot be traced back beyond the age of this or that author. Though this does not prove that the beliefs themselves were not held earlier, it suggests caution in assuming that they were. In the Homeric poems there are Pelasgians among the allies of Troy in the catalogue, *Iliad*, ii. 840-843, which is otherwise in strict geographical order, they stand between the Hellespontine towns and the Thracians of south-east Europe, i.e. on the Hellespontine border of Thrace. Their town or district is called Larissa and is fertile, and they are celebrated for their spearmanship. Their chiefs are Hippothous and Pylaeus, sons of Lethus son of Teutamus. *Iliad*, x. 428-429, describes their camping ground between the town of Troy and the sea; but this obviously proves nothing about their habitat in time of peace. *Odyssey*, xvii. 175-177, notes Pelasgians in Crete, together with two apparently indigenous and two immigrant peoples (Achaean and Dorians), but gives no indication to which class the Pelasgians belong. In Lemnos (*Iliad*, vii. 467; xiv. 230) there are no Pelasgians, but a Minyan dynasty. Two other passages (*Iliad*, ii. 681-684; xvi. 233-235) apply the epithet "Pelasgic" to a district called Argos about Mt Othrys in south Thessaly, and to Zeus of Dodona. But in neither case are actual Pelasgians mentioned; the Thessalian Argos is the specific home of Hellenes and Achaeans, and Dodona is inhabited by Perihacians and Aenianes (*Iliad*, ii. 750) who are nowhere described as Pelasgian. It looks therefore as if "Pelasgian" were here used connotatively, to mean either "formerly occupied by Pelasgian" or simply "of immemorial age."

Hesiod expands the Homeric phrase and calls Dodona "seat of Pelasgians" (fr. 225); he speaks also of a personal Pelasgus as father of Lycaon, the culture-hero of Arcadia; and a later epic poet, Asius, describes Pelasgus as the first man, whom the earth threw up that there might be a race of men. Hecataeus makes Pelasgus king of Thessaly (expounding *Iliad*, ii. 681-684); Acusilaus applies this Homeric passage to the Peloponnesian Argos, and engrafs the Hesiodic Pelasgus, father of Lycaon, into a Peloponnesian genealogy. Hellanicus a generation later repeats this blunder, and identifies this Argive and Arcadian Pelasgus with the Thessalian Pelasgus of Hecataeus. For Aeschylus (*Supplixes* 1, sqq.) Pelasgus is earthborn, as in Asius, and rules a kingdom stretching from Argos to Dodona and the Strymon; but in *Prometheus* 879, the "Pelasgian" land simply means Argos. Sophocles takes the same view (*Inachus*, fr. 256) and for the first time introduces the word "Tyrrhenian" into the story, apparently as synonymous with Pelasgian.

Herodotus, like Homer, has a denotative as well as a connotative use. He describes actual Pelasgians surviving and mutually intelligible (a) at Placie and Scylace on the Asiatic shore of the Hellespont, and (b) near Creston on the Strymon; in the latter area they have "Tyrrhenian" neighbours. He alludes to other districts where Pelasgian peoples lived on under changed names; Samothrace and Antandrus in Troas are probably instances of this. In Lemnos and Imbros he describes a Pelasgian population who were only conquered by Athens shortly before 500 B.C., and in this connexion he tells a story of earlier raids of these Pelasgians on Attica, and of a temporary

settlement there of Hellespontine Pelasgians, all dating from a time "when the Athenians were first beginning to count as Greeks." Elsewhere "Pelasgian" in Herodotus connotes anything typical of, or surviving from, the state of things in Greece before the coming of the Hellenes. In this sense all Greece was once "Pelasgic"; the clearest instances of Pelasgian survival in ritual and customs and antiquities are in Arcadia, the "Ionian" districts of north-west Peloponnese, and Attica, which have suffered least from hellenization. In Athens itself the prehistoric wall of the citadel and a plot of ground close below it were venerated in the 5th century as "Pelasgian"; so too Thucydides (ii. 17). We may note that all Herodotean examples of actual Pelasgi lie round, or near, the actual Pelasgi of Homeric Thrace; the most distant of these is confirmed by the testimony of Thucydides (iv. 106) as to the Pelasgian and Tyrrhenian population of the adjacent seaboard; also that Thucydides adopts the same general Pelasgian theory of early Greece, with the refinement that he regards the Pelasgian name as originally-specific, and as having come gradually into this generic use.

Ephorus, relying on Hesiodic tradition of an aboriginal Pelasgian type in Arcadia, elaborated a theory of the Pelasgians as a warrior-people spreading (like "Aryans") from a "Pelasgian home," and annexing and colonizing all the parts of Greece where earlier writers had found allusions to them, from Dodona to Crete and the Troad, and even as far as Italy, where again their settlements had been recognized as early as the time of Hellanicus, in close connexion once more with "Tyrrhenians."

The copious additional information given by later writers is all by way either of interpretation of local legends in the light of Ephorus's theory, or of explanation of the name "Pelasgic"; as when Philochorus expands a popular etymology "stork-folk" (*πελασγοί—πελαργοί*) into a theory of their seasonal migrations; or Apollodorus says that Homer calls Zeus Pelasgian "because he is not far from every one of us," *ὅτι τῆς γῆς πέλας ἐστίν*. The connexion with Tyrrhenians which began with Hellanicus, Herodotus and Sophocles becomes confusion with them in the 3rd century, when the Lemnian pirates and their Attic kinsmen are plainly styled Tyrrhenians, and early fortress-walls in Italy (like those on the Palatine in Rome) are quoted as "Arcadian" colonies.

Modern writers have either been content to restate or amplify the view, ascribed above to Ephorus, that "Pelasgian" simply means "prehistoric Greek" or have used the name Pelasgian at their pleasure to denote some one element in the mixed population of the Aegean-Thracian, Illyrian (Albanian) or Semitic. G. Sergi (*Origine e diffusione della stirpe mediterranea*, Rome, 1895; Eng. trans. *The Mediterranean Race*, London, 1901), followed by many anthropologists, describes as "Pelasgian" one branch of the Mediterranean or Eur-African race of mankind, and one group of types of skull within that race. The character of the ancient citadel wall at Athens, already mentioned, has given the name "Pelasgic masonry" to all constructions of large unhehwn blocks fitted roughly together without mortar, from Asia Minor to Spain.

For another view than that here taken see ACHAEANS; also GREECE: *Ancient History*, § 3, "Homeric Age."

BIBLIOGRAPHY.—Beside sections on the subject in all principal histories of Greece and bibliographies in G. Busolt, *Gr. Geschichte*, i² (Gotha, 1893, 164-182); and K. F. Hermann (Thumser), *Gr. Staatsalterthümer*, § 6, see S. Brück, *Quae veteres de Pelasgis tradiderint* (Breslau, 1884); B. Giecke, *Thracisch-pelasgische Stämme auf der Balkanhalbinsel* (Leipzig, 1858); F. G. Hahn, *Albanesische Studien* (Jena, 1854); P. Volkmut, *Die Pelasger als Semiten* (Schaffhausen, 1860); H. Kiepert, *Monatsbericht d. berl. Akademie* (1861), pp. 114 sqq.; K. Pauli, *Eine vorgriechische Inschrift auf Lemnos* (Leipzig, 1886); E. Meyer, "Die Pelasger" in *Forschungen z. alten Geschichte* (Halle, 1892), i. 124; W. Ridgeway, *Early Age of Greece* (Cambridge, 1901), vol. i.; J. L. Myres, "A History of the Pelasgian Theory" (in *Journal of Hellenic Studies*, xvii. 170); H. Marsh, *Horae pelagicae* (Cambridge, 1815); L. Benloew, *La Grèce avant les Grecs* (Paris, 1877). (J. L. M.)

PELEUS, in Greek legend, king of the Myrmidones of Phthia in Thessaly, son of Aetacus, king of Aegina, and brother (of

intimate friend) of Telamon. The two brothers, jealous of the athletic prowess of their step-brother Phocus, slew him; but the crime was discovered, and Peleus and Telamon were banished. Peleus took refuge in Phthia with his uncle Eurytion, who purified him from the guilt of murder, and gave him his daughter Antigone to wife, and a third of the kingdom as her dowry. Having accidentally killed his father-in-law at the Calydonian boar-hunt, Peleus was again obliged to flee, this time to Iolcus, where he was purified by Acastus. The most famous event in the life of Peleus was his marriage with the sea-goddess Thetis, by whom he became the father of Achilles. The story ran that both Zeus and Poseidon had sought her hand, but, Themis (or Prometheus or Proteus) having warned the former that a son of Thetis by Zeus would prove mightier than his father, the gods decided to marry her to Peleus. Thetis, to escape a distasteful union, changed herself into various forms, but at last Peleus, by the instructions of Chiron, seized and held her fast till she resumed her original shape, and was unable to offer further resistance. The wedding (described in the fine *Epithalamium* of Catullus) took place in Chiron's cave on Mt Pelion. Peleus survived both his son Achilles and his grandson Neoptolemus, and was carried away by Thetis to dwell for ever among the Nereids.

See Apollodorus iii. 12, 13; Ovid, *Melam.* xi, Pindar, *Isthmia*, viii. 70, *Nemea*, iv. 101; Catullus, *l. i. v.*; schol. Apoll. Rhod. iv. 816; Euripides, *Andromache*, 1242-1260.

PELEU ISLANDS (Ger. *Palauinseln*, also *Palap*), a group of twenty-six islands in the western Pacific Ocean, between 2° 35' and 9° N., and 130° 4' and 134° 40' E., belonging to Germany. They lie within a coral barrier reef, and in the south the islands are of coral, but in the north of volcanic rocks. They are well wooded, the climate is healthy, and the water-supply good. A few rats and bats represent the indigenous mammals, but the sea is rich in fish and molluscs; and Dr Otto Finsch (*Journ. des Muséum Godffroy*, 1875) enumerated 56 species of birds, of which 12 are peculiar to the group. The total area is 175 sq. m., the largest islands being Babeltop (Babelthuap, Baobeltaoab and other variants), Uruktaipi (Urukhopel), Korror, Nyaur, Peleliu and Eilmalk (Irakong). The population is about 3100. The natives are Micronesians, and are darker and shorter than their kinsmen, the Caroline Islanders. They usually have the frizzly hair of the Melanesians, and paint their bodies in brilliant colours, especially yellow. The men vary in height from 5 ft. to 5 ft. 5 in., the women from 4 ft. 9 to 5 ft. 2 in. The skull shows a strong tendency to brachycephalism. Two curious customs may be noted—the institution of an honourable order bestowed by the king, called *klill*; and a species of mutual aid society, sometimes confined to women, and possessing considerable political influence. There are five kinds of currency in the islands, consisting of beads of glass and enamel, to which a supernatural origin is ascribed.

The islands were sighted in 1543 by Ruy Lopez de Villalobos, who named them the Arcecos. The origin of the name *Islas Palaos* is doubtful. The islands were bought by Germany from Spain in 1899, and are administered together with the western Carolines, Yap being the administrative centre.

See K. Semper, *Die Palau-Inseln* (Leipzig, 1873); J. S. Kubary, *Die sozialen Einrichtungen der Palauer* (Berlin, 1885); A. A. Marche, *Luçon et Paléuan* (Paris, 1887).

PELF, a term now chiefly used of money and always in a derogatory sense. The word originally meant plunder, pillage (O. Fr. *peffre*, probably from Lat. *pilare*, to deprive of hair, *pilus*), and this significance is still kept in the related word "pilfer," to make petty thefts.

PELHAM, the name of an English family, derived from Pelham in Hertfordshire, which was owned by a certain Walter de Pelham under Edward I., and is alleged to have been in the possession of the same family before the Norman conquest. The family dignities included the barony of Pelham of Laughton (1706-1768), the earldom of Clare (1714-1768), the dukedom of Newcastle (1715-1768), the barony of Pelham of Stanmer from

1762, the earldom of Chichester from 1801 and the earldom of Yarborough from 1837.

JOHN DE PELHAM, who was one of the captors of John II. of France at Poitiers, acquired land at Winchelsea by his marriage with Joan Herbert, or Finch. His son, JOHN DE PELHAM (d. 1429), was attached to the party of John of Gaunt and his son Henry IV. In 1393 he received a life appointment as constable of Pevensey Castle, an honour subsequently extended to his heirs male, and he joined Henry on his invasion in 1399, if he did not actually land with him at Ravenspur. He was knighted at Henry's coronation, and represented Sussex in parliament repeatedly during the reign of Henry IV., and again in 1422 and 1427. As constable of Pevensey he had at different times the charge of Edward, duke of York, in 1405; Edmund, earl of March, with his brother Roger Mortimer in 1406; James I. of Scotland in 1414; Sir John Mortimer in 1422, and the queen dowager, Joan of Navarre, from 1418 to 1422. He was constantly employed in the defence of the southern ports against French invasion, and his powers were increased in 1407 by his appointment as chief butler of Chichester and of the Sussex ports, and in 1412 by the grant of the rape of Hastings. He was treasurer of England in 1412-1413, and although he was superseded on the accession of Henry V. he was sent in the next year to negotiate with the French court. He was included among the executors of the wills of Henry IV., of Thomas, duke of Clarence, and of Henry V. He died on the 12th of February 1429, and was succeeded by his son John, who took part in Henry V.'s expedition to Normandy in 1417.

In the reign of Queen Elizabeth Sir WILLIAM PELHAM (c. 1530-1587), third son of Sir William Pelham (d. 1558) of Laughton, Sussex, became lord justice of Ireland. He was captain of pioneers at the siege of Leith in 1560, and served at the siege of Havre in 1562, and with Coligny at Caen in 1563. He then returned to Havre, at that time occupied by English troops, and was one of the hostages for the fulfilment of its surrender to Charles IX. in 1564. After his return to England he fortified Berwick among other places, and was appointed lieutenant-general of ordnance. He was sent to Ireland in 1579, when he was knighted by Sir William Drury, the lord justice. Drury died in October, and Pelham was provisionally made his successor, an appointment subsequently confirmed by Elizabeth. Alarmed by the proceedings of Gerald Fitzgerald, 15th earl of Desmond, and his brother John Desmond, he proclaimed the earl a traitor. Elizabeth protested strongly against Pelham's action, which was justified by the sack of Youghal by Desmond. Thomas Butler, 10th earl of Ormonde, was entrusted with the campaign in Munster, but Pelham joined him in February 1580, when it was believed that a Spanish descent was about to be made in the south-west. The English generals laid waste northern Kerry, and proceeded to besiege Carrigafoyle Castle, which they stormed, giving no quarter to man, woman or child. Other strongholds submitted on learning the fate of Carrigafoyle, and were garrisoned by Pelham, who hoped with the concurrence of Admiral Winter's fleet to limit the struggle to Kerry. He vainly sought help from the gentry of the county, who sympathized with Desmond; and were only brought to submission by a series of "drives." After the arrival of the new deputy, Lord Grey of Wilton, Pelham returned to England on the ground of health. He had retained his office as lieutenant-general of ordnance, and was now made responsible for debts incurred during his absence. Leicester desired his services in the Netherlands, but it was only after much persuasion that Elizabeth set him free to join the army by accepting a mortgage on his estates as security for his liabilities. The favour shown by Leicester to Pelham caused serious jealousies among the English officers, and occasioned a camp brawl in which Sir Edward Norris was injured. Pelham was wounded at Doesburg in 1586, and accompanied Leicester to England in 1587. Returning to the Netherlands in the same year he died at Flushing on the 24th of November 1587. His half-brother, Sir Edmund Pelham (d. 1606), chief baron of the exchequer in Ireland, was the first English judge to go on circuit in Ulster.

Sir William married Eleanor, daughter of Henry Neville, earl of Westmorland, and was the ancestor of the Pelhams of Brocklesby, Lincolnshire. In the fourth generation Charles Pelham died in 1763 without heirs, leaving his estates to his great-nephew Charles Anderson (1749-1823), who thereupon assumed the additional name of Pelham, and was created Baron Yarborough in 1794. His son Charles (1781-1846), who was for many years commodore of the Royal Yacht Squadron, was created earl of Yarborough and Baron Worsley in 1837. Charles Alfred Worsley, the 4th earl (b. 1859), exchanged the name of Anderson-Pelham for that of Pelham in 1905. He married in 1886 Marcia Lane-Fox, eldest daughter of the 12th Baron Conyers, who became in 1892 Baroness Conyers in her own right.

Sir NICHOLAS PELHAM (1517-1560), an elder half-brother of Sir William Pelham, defended Seaford against the French in 1545, and sat for Arundel and for Sussex in parliament. He was the ancestor of the earls of Chichester. His second son, Sir THOMAS PELHAM (d. 1624), was created a baronet in 1611. His descendant, Sir THOMAS PELHAM, 4th baronet (c. 1650-1712), represented successively East Grinstead, Lewes and Sussex in parliament, and was raised to the House of Lords as Baron Pelham of Laughton in 1706. By his second marriage with Grace (d. 1700), daughter of Gilbert Holles, 3rd earl of Clare, and sister of John Holles, duke of Newcastle, he had five daughters, and two sons—Thomas Pelham, earl of Clare, duke of Newcastle-on-Tyne and 1st duke of Newcastle-under-Lyme (see NEWCASTLE, DUKES OF), and Henry Pelham (q.v.). The duke of Newcastle died without heirs, and the dukedom of Newcastle-under-Lyme descended to his nephew, Henry Fiennes Clinton, afterwards known as Pelham-Clinton, and his heirs, but the barony of Pelham of Laughton became extinct. In 1762 Newcastle had been created Baron Pelham of Stanmer, with reversion to his cousin and heir-male, THOMAS PELHAM (1728-1805), who became commissioner of trade (1754), lord of the admiralty (1761-1764), comptroller of the household (1765-1774), privy councillor (1765), surveyor-general of the customs of London (1773-1805), chief justice in eyre (1774-1775) and keeper of the wardrobe (1775-1782), and was created earl of Chichester in 1801. His third son, George (1766-1827), was successively bishop of Bristol, Exeter and Lincoln. THOMAS PELHAM, 2nd earl of Chichester (1756-1826), son of the 1st earl, was surveyor-general of ordnance in Lord Rockingham's ministry (1782), and chief secretary for Ireland in the coalition ministry of 1783. In 1795 he became Irish chief secretary under Pitt's government, retiring in 1798; he was home secretary from July 1801 to August 1803 under Addington, who made him chancellor of the duchy of Lancaster in 1803. Pelham went out of office in 1804, and in the next year succeeded to the earldom. He was joint postmaster-general from 1807 to 1823, and for the remaining three years of his life postmaster-general. His son and heir, HENRY THOMAS PELHAM (1804-1886), 3rd earl, was an ecclesiastical commissioner from 1850 until his death, and was greatly interested in various religious, philanthropic and educational movements; and two other sons were well-known men—Frederick Thomas Pelham (1808-1861), who became a rear-admiral in 1858, and subsequently lord-commissioner of the admiralty, and John Thomas Pelham (1811-1894), who was bishop of Norwich from 1857 to 1893. The third earl's son, Walter John Pelham (1838-1892), succeeded his father in 1886, and his nephew Jocelyn Brudenell Pelham (b. 1871) became 6th earl of Chichester in 1905.

PELHAM, HENRY (1696-1754), prime minister of England, younger brother of Thomas Holles Pelham, duke of Newcastle, was born in 1696. He was a younger son of Thomas, 1st Baron Pelham of Laughton (1650-1712; cr. 1706) and of Lady Grace Holles, daughter of the 3rd earl of Clare (see above). He was educated by a private tutor and at Christ Church, Oxford, which he entered in July 1710. As a volunteer he served in Dormer's regiment at the battle of Preston in 1715, spent some time on the Continent, and in 1717 entered parliament for Seaford, Sussex. Through strong family influence and the

recommendation of Walpole he was chosen in 1721 a lord of the Treasury. The following year he was returned for Sussex county. In 1724 he entered the ministry as secretary of war, but this office he exchanged in 1730 for the more lucrative one of paymaster of the forces. He made himself conspicuous by his support of Walpole on the question of the excise, and in 1743 a union of parties resulted in the formation of an administration in which Pelham was prime minister, with the office of chancellor of the exchequer; but rank and influence made his brother, the duke of Newcastle, very powerful in the cabinet, and, in spite of a genuine attachment, there were occasional disputes between them, which led to difficulties. Being strongly in favour of peace, Pelham carried on the war with languor and indifferent success, but the country, wearied of the interminable struggle, was disposed to acquiesce in his foreign policy almost without a murmur. The king, thwarted in his favourite schemes, made overtures in 1746 to Lord Bath, but his purpose was upset by the resignation of the two Pelhams (Henry and Newcastle), who, however, at the king's request, resumed office. Pelham remained prime minister till his death on the 6th of March 1754, when his brother succeeded him. His very defects were among the chief elements of Pelham's success, for one with a strong personality, moderate self-respect, or high conceptions of statesmanship could not have restrained the discordant elements of the cabinet for any length of time. Moreover, he possessed tact and a thorough acquaintance with the forms of the house. Whatever quarrels or insubordination might exist within the cabinet, they never broke out into open revolt. Nor can a high degree of praise be denied to his financial policy, especially his plans for the reduction of the national debt and the simplification and consolidation of its different branches. He had married in 1726 Lady Catherine Manners, daughter of the 2nd duke of Rutland; and one of his daughters married Henry Fiennes Clinton, 2nd duke of Newcastle.

See W. Cox, *Memoirs of the Pelham Administration*, (2 vols., 1829). For the family history see *Lower, Pelham Family* (1873); also the Pelham and Newcastle MSS. in the British Museum.

PELHAM, HENRY FRANCIS (1846-1907), English scholar and historian, was born at Berg Apton, Norfolk, on the 19th of September 1846, son of the Hon. John Thomas Pelham (1811-1894), bishop of Norwich, third son of the 2nd earl of Chichester. He was educated at Harrow and at Trinity College, Oxford, where he took a first class in *literae humaniores* in 1869. He was a tutor of Exeter College from 1869 to 1890. In 1887 he became university reader in ancient history, and two years later was elected to the Camden professorship. He became curator of the Bodleian library in 1892, and in 1897 president of Trinity College. He was also a fellow of Brasenose College, honorary fellow of Exeter, a fellow of the British Academy and of other learned societies, and a governor of Harrow School. His chief contribution to ancient history was his article on Roman history in the 9th edition of the *Encyclopaedia Britannica* (1886), which was republished with additions as the *Outlines of Roman History* (1890). His university lectures, though perhaps lacking in inspiration, were full of original research and learning. His death on the 13th of February 1907 not only prevented the publication in systematic form of his own important researches, but also delayed the appearance of much that had been left in MS. by H. Furneaux and A. H. J. Greenidge, and was at the time under his charge. Apart from the *Outlines* he published only *The Imperial Domains and the Colonate* (1890), *The Roman Frontier System* (1895), and articles in periodicals of which the most important was an article in the *Quarterly Review* on the early Caesars (April, 1905). He did much for the study of archaeology at Oxford, materially assisted the Hellenic Society and the British School at Athens, and was one of the founders of the British School at Rome. He married in 1873 Laura Priscilla, daughter of Sir Edward North Buxton.

PELIAS, in Greek legend, son of Poseidon and Tyro, daughter of Salmoneus. Because Tyro afterwards married her father's brother Cretheus, king of Iolcus in Thessaly, to whom she bore Aeson, Pheres and Amythaon, Pelias was by some thought to be

the son of Cretheus. He and his twin-brother Neleus were exposed by their mother, but were nurtured by a herdsman. When grown to manhood they were acknowledged by their mother. After the death of Cretheus, Pelias made himself master of the kingdom of Iolous, having previously quarrelled with Neleus, who removed to Messenia, where he founded Pylos. In order to rid himself of Jason, Pelias sent him to Colchis in quest of the golden fleece, and took advantage of his absence to put to death his father, Aeson, his mother and brother. When Jason returned he sought to avenge the death of his parents, and Medea persuaded the daughters of Pelias to cut in pieces and boil their father, assuring them that he would thus be restored to youth. Acastus, son of Pelias, drove out Jason and Medea and celebrated funeral games in honour of his father, which were celebrated by the poet Stesichorus and represented on the chest of Cypselus. The death of Pelias was the subject of Sophocles' *Rhesotomoi* (Root-cutters), and in the *Tyro* he treated another portion of the legend. *Peliades* (the daughters of Pelias) was the name of Euripides' first play.

PELICAN (Fr. *Pélican*; Lat. *Pelecanus* or *Pelicanus*), a large fish-eating water-fowl, remarkable for the enormous pouch formed by the extensible skin between the lower jaws of its long, and apparently formidable but in reality very weak, bill. The ordinary pelican, the *Oncrotalus* of the ancients, to whom it was well known, and the *Pelecanus oncotulus* of ornithologists, is a very abundant bird in some districts of south-eastern Europe, south-western Asia and north-eastern Africa, occasionally straying, it is believed, into the northern parts of Germany and France; but the possibility of such wanderers having escaped from confinement is always to be regarded, since few zoological gardens are without examples. Its usual haunts are the shallow margins of the larger lakes and rivers, where fishes are plentiful, since it requires for its sustenance a vast supply of them. The nest is formed among reeds, placed on the ground and lined with grass. Therein two eggs, with white, chalky shells, are commonly laid. The young during the first twelvemonth are of a greyish-brown, but when mature almost the whole plumage, except the black primaries, is white, deeply suffused by a rich blush of rose or salmon-colour, passing into yellow on the crest and lower part of the neck in front. A second and somewhat larger species, *Pelecanus crispus*, also inhabits Europe, but has a more eastern distribution. This, when adult, is readily distinguishable from the ordinary bird by the absence of the blush from its plumage, and by the curled feathers that project from and overhang each side of the head, which with some difference of coloration of the bill, pouch, bare skin round the eyes and irides give it a wholly distinct expression. Two specimens of the humerus have been found in the English fens (*Ibis*, 1868, p. 363; *Proc. Zool. Society*, 1871, p. 702), thus proving the existence of the bird in England at no very distant period, and one of them being that of a young example points to its having been bred in this country. It is possible from their large size that they belonged to *P. crispus*. Ornithologists have been much divided in opinion as to the number of living species of the genus *Pelecanus* (cf. *op. cit.*, 1868, p. 264; 1869, p. 571; 1871, p. 631)—the estimate varying from six to ten or eleven; but the former is the number recognized by M. Dubois (*Bull. Mus. de Belgique*, 1883). North America has one, *P. erythrorhynchus*, very similar to *P. oncotulus* both in appearance and habits, but remarkable for a triangular, horny excrescence developed on the ridge of the male's bill in the breeding season, which falls off without leaving trace of its existence when that is over. Australia has *P. conspicillatus*, easily distinguished by its black tail and wing-coverts. Of more marine habit are *P. philippensis* and *P. fuscus*, the former having a wide range in Southern Asia, and, it is said, reaching Madagascar, and the latter common on the coasts of the warmer parts of both North and South America.

The genus *Pelecanus* as instituted by Linnaeus included the ¹This caution was not neglected by the prudent, even so long ago as Sir Thomas Browne's days; for he, recording the occurrence of a pelican in Norfolk, was careful to notice that about the same time one of the pelicans kept by the king (Charles II.) in St James's Park, had been lost.

cormorant (*q.v.*) and gannet (*q.v.*) as well as the true pelicans, and for a long while these and some other distinct groups, as the snake-birds (*q.v.*), frigate-birds (*q.v.*) and tropic-birds (*q.v.*), which have all the four toes of the foot connected by a web, were regarded as forming a single family, *Pelecanidae*; but this name has now been restricted to the pelicans only, though all are still usually associated in the suborder *Sieganopodes* of Ciconiiform birds. It may be necessary to state that there is no foundation for the venerable legend of the pelican feeding her young with blood from her own breast, which has given it an important place in ecclesiastical heraldry, except that, as A. D. Bartlett suggested (*Proc. Zool. Society*, 1869, p. 146), the curious bloody secretion ejected from the mouth of the flamingo may have given rise to the belief, through that bird having been mistaken for the "Pelican of the wilderness" (A. N.)

PÉLION, a wooded mountain in Thessaly in the district of Magnesia, between Volo and the east coast. Its highest point (mod. Plessidi) is 5340 ft. It is famous in Greek mythology; the giants are said to have piled it on Ossa in order to scale Olympus, the abode of the gods; it was the home of the centaurs, especially of Chiron, who had a cave near its summit, and educated many youthful heroes; the ship "Argo" was built from its pine-woods. On its summit was an altar of Zeus Actæus, in whose honour an annual festival was held in the dog-days, and worshippers clad themselves in skins.

PÉLISSÉ (through the Fr. from Lat. *pellis*: sc. *vestis*, a garment made of fur, *pellis*, skin), properly a name of a cloak made of or lined with fur, hence particularly used of the fur-trimmed "dolman" worn along from the shoulders by hussar regiments. The word is now chiefly employed as the name of a long-sleeved cloak of any material worn by women and children.

PÉLISSIER, AIMABLE JEAN JACQUES (1794-1864), duke of Malakoff, marshal of France, was born on the 6th of November 1794 at Maromme (Seine Inférieure), of a family of prosperous artisans or yeoman, his father being employed in a powder-magazine. After attending the military college of La Flèche and the special school of St Cyr, he in 1815 entered the army as sub-lieutenant in an artillery regiment. A brilliant examination in 1819 secured his appointment to the staff. He served as aide-de-camp in the Spanish campaign of 1823, and in the expedition to the Morea in 1828-29. In 1830 he took part in the expedition to Algeria, and on his return was promoted to the rank of *chef d'escadron*. After some years' staff service in Paris he was again sent to Algeria as chief of staff of the province of Oran with the rank of lieutenant-colonel, and remained there till the Crimean War, taking a prominent part in many important operations. The severity of his conduct in suffocating a whole Arab tribe in the Dahra or Dahna caves, near Mustaganem, where they had taken refuge (June 18, 1845), awakened such indignation in Europe that Marshal Soult, the minister of war, publicly expressed his regret; but Marshal Bugeaud, the governor-general of Algeria, not only gave it his approval, but secured for Péliissier the rank of general of brigade, which he held till 1850, when he was promoted general of division. After the battles of October and November 1854 before Sevastopol, Péliissier was sent to the Crimea, where on the 16th of May 1855 he succeeded Marshal Canrobert as commander-in-chief of the French forces before Sevastopol (see CRIMEAN WAR). His command was marked by relentless pressure of the enemy and unalterable determination to conduct the campaign without interference from Paris. His perseverance was crowned with

¹The legend was commonly believed in the middle ages. Epiphanius, bishop of Constantia, in his *Physiologus* (1588), writes that the female bird, in cherishing her young, wounds them with loving, and pierces their sides, and they die. After three days the male pelican comes and finds them dead, and his heart is pained. He smites his own side, and as he stands over the wounds of the dead young ones the blood trickles down, and thus are they made alive again. The pelican "in his piety"—i.e. in this pious act of reviving his offspring—was a common subject for 15th-century emblem books; it became a symbol of self-sacrifice, a type of Christian redemption and of the Eucharistic doctrine. The device was adopted by Bishop Fox in 1516 for his new college of Corpus Christi, Oxford.—[H. CH.]

success in the storming of the Malakoff on the 8th of September. On the 12th he was promoted to be marshal. On his return to Paris he was named senator, created duke of Malakoff (July 22, 1856), and rewarded with a grant of 100,000 francs per annum. From March 1858 to May 1859 he was French ambassador in London, whence he was recalled to take command of the army of observation on the Rhine. In the same year he became grand chancellor of the Legion of Honour. In 1860 he was appointed governor-general of Algeria, and he died there on the 22nd of May 1864.

See Marbaud, *Le Maréchal Pélissier* (1863); Castille, *Portraits historiques*, 2nd series (1859).

PELL, JOHN (1610-1685), English mathematician, was born on the 1st of March 1610 at Southwick in Sussex, where his father was minister. He was educated at Steyning, and entered Trinity College, Cambridge, at the age of thirteen. During his university career he became an accomplished linguist, and even before he took his M.A. degree (in 1630) corresponded with Henry Briggs and other mathematicians. His great reputation and the influence of Sir William Boswell, the English resident, with the states-general procured his election in 1643 to the chair of mathematics in Amsterdam, whence he removed in 1646, on the invitation of the prince of Orange, to Breda, where he remained till 1652.

From 1654 to 1658 Pell acted as Cromwell's political agent to the Protestant cantons of Switzerland. On his return to England he took orders and was appointed by Charles II. to the rectory of Fobbing in Essex, and in 1673 he was presented by Bishop Sheldon to the rectory of Laindon in the same county. His devotion to mathematical science seems to have interfered alike with his advancement in the Church and with the proper management of his private affairs. For a time he was confined as a debtor in the king's bench prison. He lived, on the invitation of Dr Whistler, for a short time in 1682 at the College of Physicians, but died on the 12th of December 1685 at the house of Mr Cothorne, reader of the church of St Giles-in-the-Fields. Many of Pell's manuscripts fell into the hands of Dr Busby, master of Westminster School, and afterwards came into the possession of the Royal Society; they are still preserved in something like forty folio volumes, which contain, not only Pell's own memoirs, but much of his correspondence with the mathematicians of his time.

The Diophantine analysis was a favourite subject with Pell; he lectured on it at Amsterdam; and he is now best remembered for the indeterminate equation $ax^2 + 1 = y^2$, which is known by his name. This problem was proposed by Pierre de Fermat first to Bernhard Frenicle de Bessy, and in 1657 to all mathematicians. Pell's connexion with the problem simply consists of the publication of the solutions of John Wallis and Lord Brouncker in his edition of *Branker's Translation of Rhonius's Algebra* (1668). His chief works are: *Astronomical History of Observations of Heavenly Motions and Appearances* (1634); *Ecliptical prognostics* (1634); *Controversy with Longomontanus concerning the Quadrature of the Circle* (1646?); *An Idea of the Mathematicks*, 12mo (1650); *A Table of Ten Thousand Square Numbers* (fol.; 1672).

PELLA, the capital of ancient Macedonia under Philip II. (who transferred the seat of government hither from Edessa) and Alexander the Great, who was born here. It seems to have retained some importance up to the time of Hadrian. Scanty remains exist and some springs in the neighbourhood are still known as the baths of Pel. The site (identified by Leake) is occupied by the village of Neochori (Turk. *Yeni-Kest*) about 32 m. north-west of Salonika.

PELLAGRA (Ital. *pelle agra*, smarting skin), the name given, from one of its early symptoms, to a peculiar disease, of comparatively modern origin. For some time it was supposed to be practically confined to the peasantry in parts of Italy (particularly Lombardy) and France, and in the Asturias (*mal de la raso*), Rumania and Corfu. But it has recently been identified in various outlying parts of the British Empire (Barbadoes, India) and in both Lower and Upper Egypt; also among the Zulus and Basutos. In the United States sporadic cases had been observed up to 1906, but since then numerous cases have been reported. It is in Italy, however, that it has been most

prevalent. The malady is essentially chronic in character. The indications usually begin in the spring of the year, declining towards autumn, and recurring with increasing intensity and permanence in the spring seasons following. A peasant who is acquiring the malady feels unfit for work, suffers from headaches, giddiness, singing in the ears, a burning of the skin, especially in the hands and feet, and diarrhoea. At the same time a red rash appears on the skin, of the nature of erysipelas, the red or livid spots being tense and painful, especially where they are directly exposed to the sun. About July or August of the first season these symptoms disappear, the spots on the skin remaining rough and dry. The spring attack of the year following will probably be more severe and more likely to leave traces behind it; with each successive year the patient becomes more like a mummy, his skin shrivelled and sallow, or even black at certain spots, as in Addison's disease, his angles protruding, his muscles wasted, his movements slow and languid, and his sensibility diminished. Meanwhile there are more special symptoms relating to the nervous system, including drooping of the eyelid, dilatation of the pupil, and other disorders of vision, together with symptoms relating to the digestive system, such as a red and dry tongue, a burning feeling in the mouth, pain on swallowing, and diarrhoea. After a certain stage the disease passes into a profound disorganization of the nervous system; there is a tendency to melancholy, imbecility, and a curious mummified condition of body. After death a general tissue degeneration is observed.

The causation of this obscure disease has recently come up for new investigation in connexion with the new work done in relation to sleeping-sickness and other tropical diseases. So long as it was supposed to be peculiar to the Italian peasantry, it was associated simply with their staple diet, and was regarded as due to the eating of mouldy maize. It was by his views in this regard that Lombroso (q.v.) first made his scientific reputation. But the area of maize consumption is now known to be wider than that of pellagra, and pellagra is found where maize is at least not an ordinary diet. In 1905 Dr L. W. Sambon, at the meeting of the British Medical Association, suggested that pellagra was probably protozoal in origin, and subsequently he announced his belief that the protozoon was communicated by sand-flies, just as sleeping-sickness by the tsetse fly; and this opinion was supported by the favourable action of arsenic in the treatment of the disease. His hypothesis was endorsed by Sir Patrick Manson, and in January 1910 an influential committee was formed, to enable Dr Sambon to pursue his investigations in a pellagrous area.

PELLETAN, CHARLES CAMILLE (1846-), French politician and journalist, was born in Paris on the 28th of June 1846, the son of Eugène Pelletan (1813-1884), a writer of some distinction and a noted opponent of the Second Empire. Camille Pelletan was educated in Paris, passed as licentiate in laws, and was qualified as an "archiviste paléographe." At the age of twenty he became an active contributor to the press, and a bitter critic of the Imperial Government. After the war of 1870-71 he took a leading place among the most radical section of French politicians, as an opponent of the "opportunists" who continued the policy of Gambetta. In 1880 he became editor of *Justice*, and worked with success to bring about a revision of the sentences passed on the Communards. In 1881 he was chosen member for the tenth arrondissement of Paris, and in 1885 for the Bouches du Rhône, being re-elected in 1889, 1893 and 1898; and he was repeatedly chosen as "reporter" to the various bureaus. During the Nationalist and Dreyfus agitations he fought vigorously on behalf of the Republican government and when the coalition known as the "Bloc" was formed he took his place as a Radical leader. He was made minister of marine in the cabinet of M. Combes, June 1902 to January 1905, but his administration was severely criticized, notably by M. de Lanessan and other naval experts. During the great sailors' strike at Marseilles in 1904 he showed pronounced sympathy with the socialistic aims and methods of the strikers, and a strong feeling was aroused that

his Radical sympathies tended to a serious weakening of the navy and to destruction of discipline. A somewhat violent controversy resulted, in the course of which M. Pelletan's indiscreet speeches did him no good; and he became a common subject for ill-natured caricatures. On the fall of the Combes ministry he became less prominent in French politics.

PELLICANUS, CONRAD (1478-1556), German theologian, was born at Ruffach in Alsace, on the 8th of January 1478. His German name, Kürsner, was changed to Pellicanus by his mother's brother Jodocus Gallus, an ecclesiastic connected with the university of Heidelberg, who supported his nephew for sixteen months at the university in 1491-1492. On returning to Ruffach, he taught gratis in the Minorite convent school that he might borrow books from the library, and in his sixteenth year resolved to become a friar. This step helped his studies, for he was sent to Tübingen in 1496 and became a favourite pupil of the guardian of the Minorite convent there, Paulus Scriptoris, a man of considerable general learning. There seems to have been at that time in south-west Germany a considerable amount of sturdy independent thought among the Franciscans; Pellicanus himself became a Protestant very gradually, and without any such revulsion of feeling as marked Luther's conversion. At Tübingen the future "apostate in three languages" was able to begin the study of Hebrew. He had no teacher and no grammar; but Paulus Scriptoris carried him a huge codex of the prophets on his own shoulders all the way from Mainz. He learned the letters from the transcription of a few verses in the *Star of the Messiah* of Petrus Niger, and, with a subsequent hint or two from Reuchlin, who also lent him the grammar of Moses Kimhi, made his way through the Bible for himself with the help of Jerome's Latin. He got on so well that he was not only a useful helper to Reuchlin but anticipated the manuals of the great Hebraist by composing in 1507 the first Hebrew grammar in the European tongue. It was printed in 1503, and afterwards included in Reysch's *Margarita philosophica*. Hebrew remained a favourite study to the last. Pellicanus's autobiography describes the gradual multiplication of accessible books on the subjects, and he not only studied but translated a vast mass of rabbinical and Talmudic texts, his interest in Jewish literature being mainly philological. The chief fruit of these studies is the vast commentary on the Bible (*Zürich*, 7 vols., 1532-1539), which shows a remarkably sound judgment on questions of the text, and a sense for historical as opposed to typological exegesis.

Pellicanus became priest in 1501 and continued to serve his order at Ruffach, Pforsheim, and Basel till 1526. At Basel he did much laborious work for Froben's editions, and came to the conclusion that the Church taught many doctrines of which the early doctors of Christendom knew nothing. He spoke his views frankly, but he disliked polemic; he found also more toleration than might have been expected, even after he became active in circulating Luther's books. Thus, supported by the civic authorities, he remained guardian of the convent of his order at Basel from 1519 till 1524, and even when he had to give up his post, remained in the monastery for two years, professing theology in the university. At length, when the position was becoming quite untenable, he received through Zwingli a call to Zürich as professor of Greek and Hebrew, and formally throwing off his monk's habit, entered on a new life. Here he remained till his death on the 6th of April 1556.

Pellicanus's scholarship, though not brilliant, was really extensive; his sound sense, and his singularly pure and devoted character gave him a great influence. He was remarkably free from the pedantry of the time, as is shown by his views about the use of the German vernacular as a vehicle of culture (*Chron.* 135, 36). As a theologian his natural affinities were with Zwingli, with whom he shared the advantage of having grown up to the views of the Reformation, by the natural progress of his studies and religious life. Thus he never lost his sympathy with humanism and with its great German representative, Erasmus.

Pellicanus's Latin autobiography (*Chronicon C.P.R.*) is one of the most interesting documents of the period. It was first published

by Riggenbach in 1877, and in this volume the other sources for his life are registered. See also Emil Silberstein, *Conrad Pellicanus; ein Beitrag zur Geschichte des Studiums der hebr. Sprache* (Berlin, 1900).

PELLICIER, GUILLAUME (c. 1490-1568), French prelate and diplomatist, was educated by his uncle, the bishop of Maguelonne, whom he succeeded in 1529. In 1536 he had the seat of his bishopric transferred to Montpellier. Appointed ambassador at Venice in 1539, he fulfilled his mission to the entire satisfaction of Francis I., but on the discovery of the system of espionage he had employed the king had to recall him in 1542. Returning to his diocese, he was imprisoned in the château of Beaucaire for his tolerance of the Reformers, so he replaced his former indulgence by severity, and the end of his episcopate was disturbed by religious struggles. He was a man of wide learning, a humanist and a friend of humanists, and took a keen interest in the natural sciences.

See J. Zeller, *La Diplomatie française . . . d'après les correspondances de G. Pellicier* (Paris, 1881); and A. Tausserat-Radel, *Correspondances politiques de Guillaume Pellicier* (Paris, 1899).

PELLICO, SILVIO (1788-1854), Italian dramatist, was born at Saluzzo in Piedmont on the 24th of June 1788, the earlier portion of his life being passed at Pinerolo and Turin under the tuition of a priest named Manavella. At the age of ten he composed a tragedy under the inspiration of Caesarotti's translation of the Ossiatic poems. On the marriage of his twin sister Rosina with a maternal cousin at Lyons he went to reside in that city, devoting himself during four years to the study of French literature. He returned in 1810 to Milan, where he became professor of French in the Collegio degli Orfani Militari. His tragedy *Francesca da Rimini*, was brought out with success by Carlotta Marchionni at Milan in 1818. Its publication was followed by that of the tragedy *Eufemio da Messina*, but the representation of the latter was forbidden. Pellico had in the meantime continued his work as tutor, first to the unfortunate son of Count Briche, and then to the two sons of Count Porro Lambertenghi. He threw himself heartily into an attempt to weaken the hold of the Austrian despotism by indirect educational means. Of the powerful literary executive which gathered about Counts Porro and Confalonieri, Pellico was the able secretary—the management of the *Conciliatore*, which appeared in 1818 as the organ of the association, resting largely upon him. But the paper, under the censorship of the Austrian officials, ran for a year only, and the society itself was broken up by the government. In October 1820 Pellico was arrested on the charge of carbonarism and conveyed to the Santa Margherita prison. After his removal to the Piombi at Venice in February 1821, he composed several *Cantiche* and the tragedies *Ester d'Engaddi* and *Iginia d'Assi*. The sentence of death pronounced on him in February 1822 was finally commuted to fifteen years *carcere duro*, and in the following April he was placed in the Spielberg at Brünn. His chief work during this part of his imprisonment was the tragedy *Leoniero da Dertona*, for the preservation of which he was compelled to rely on his memory. After his release in 1830 he commenced the publication of his prison compositions, of which the *Ester* was played at Turin in 1831, but immediately suppressed. In 1832 appeared his *Gismonda da Mendrisio*, *Erodiade* and the *Leoniero*, under the title of *Tre nuovi tragedie*, and in the same year the work which gave him his European fame, *Le Mie prigioni*, an account of his sufferings in prison. The last gained him the friendship of the Marchesa di Barolo, the reformer of the Turin prisons, and in 1834 he accepted from her a yearly pension of 1200 francs. His tragedy *Tommaso Moro* had been published in 1833, his most important subsequent publication being the *Opere inedite* in 1837. On the decease of his parents in 1838 he was received into the Casa Barolo, where he remained till his death, assisting the marchesa in her charities, and writing chiefly upon religious themes. Of these works the best known is the *Dei Doveri degli uomini*, a series of trite maxims which do honour to his piety rather than to his critical judgment. A fragmentary biography of the marchesa by Pellico was published in Italian and English after her death. He died on the 31st of January 1854, and was

buried in the Campo Santo at Turin. His writings are defective in virility and breadth of thought, and his tragedies display neither the insight into character nor the constructive power of a great dramatist. It is in the simple narrative and naive egotism of *Le Misa prigioni* that he has established his strongest claim to remembrance, winning fame by his misfortunes rather than by his genius.

See Piero Maroncelli, *Addizioni alle mie prigioni* (Paris, 1834); the biographies by Latour; Gabriele Rossetti; Didier, *Revue des deux mondes* (September 1842); De Loménie, *Galerie des contemporains illustrés*, iv. (1842); Chiala (Turin, 1852); Nolle-Fabert (1854); Giorgio Briano (1854); Bourdon (1868); Rivieri (1899-1901).

PELLISSON, PAUL (1624-1693), French author, was born at Béziers on the 30th of October 1624, of a distinguished Calvinist family. He studied law at Toulouse, and practised at the bar of Castres. Going to Paris with letters of introduction to Valentin Conrart, who was a co-religionist, he became through him acquainted with the members of the academy. Pellisson undertook to be their historian, and in 1653 published a *Relation contenant l'histoire de l'académie française*. This panegyric was rewarded by a promise of the next vacant place and by permission to be present at their meetings. In 1657 Pellisson became secretary to the minister of finance, Nicolas Fouquet, and when in 1661 the minister was arrested, his secretary was imprisoned in the Bastille. Pellisson had the courage to stand by his fallen patron, in whose defence he issued his celebrated *Mémoire* in 1661, with the title *Discours au roi, par un de ses fidèles sujets sur le procès de M. de Fouquet*, in which the facts in favour of Fouquet are marshalled with great skill. Another pamphlet, *Seconde défense de M. Fouquet*, followed. Pellisson was released in 1666, and from this date sought the royal favour. He became historiographer to the king, and in that capacity wrote a fragmentary *Histoire de Louis XIV.*, covering the years 1660 to 1670. In 1670 he was converted to Catholicism and obtained rich ecclesiastical preferment. He died on the 7th of February 1693. He was very intimate with Mlle de Scudéry, in whose novels he figures as Herminius and Acante. His sterling worth of character made him many friends and justified Bussy-Rabutin's description of him as "encore plus honnête homme que bel esprit."

See Sainte-Beuve, *Causeries du lundi*, vol. xiv.; and F. L. Marcon, *Étude sur la vie et les œuvres de Pellisson* (1859).

PELLITORY, in botany, the common name for a small hairy perennial herb which grows on old walls, hedgerbanks and similar localities, and is known botanically as *Pariclaria officinalis* (Lat. *paries*, a wall). It has a short woody rootstock from which spring erect or spreading stems 1 to 2 ft. long, bearing slender leafy branches, and axillary clusters of small green flowers. It belongs to the nettle order (*Urticaceae*), and is nearly allied to the nettle, *Urtica*, but its hairs are not stinging.

PELLOUX, LUIGI (1839-), Italian general and politician, was born on the 21st of March 1839, at La Roche, in Savoy, of parents who retained their Italian nationality when Savoy was annexed to France. Entering the army as lieutenant of artillery in 1857, he gained the medal for military valour at the battle of Custoza in 1866, and in 1870 commanded the brigade of artillery which battered the breach in the wall of Rome at Porta Pia. He was elected to the Chamber in 1881 as deputy for Leghorn, which he represented until 1895, and joined the party of the Left. He had entered the war office in 1870, and in 1880 became general secretary, in which capacity he introduced many useful reforms in the army. After a succession of high military commands he received the appointment of chief of the general staff in 1896. He was minister of war in the Rudini and Giolitti cabinets of 1891-1893. In July 1896 he resumed the portfolio of war in the Rudini cabinet, and was appointed senator. In May 1897 he secured the adoption of the Army Reform Bill, fixing Italian military expenditure at a maximum of 19,560,000 a year, but in December of that year he was defeated in the Chamber on the question of the promotion of officers. Resigning office, he was in May 1898 sent as royal commissioner to Bari, where, without recourse to martial law, he succeeded in restoring

public order. Upon the fall of Rudini in June 1898, General Pelloux was entrusted by King Humbert with the formation of a cabinet, and took for himself the post of minister of the interior. He resigned office in May 1899, but was again entrusted with the formation of the ministry. He took stern measures against the revolutionary elements in southern Italy, and his new cabinet was essentially military and conservative. The Public Safety Bill for the reform of the police laws, taken over by him from the Rudini cabinet, and eventually promulgated by royal decree, was fiercely obstructed by the Socialist party, which, with the Left and Extreme Left, succeeded in forcing General Pelloux to dissolve the Chamber in May 1900, and to resign office after the general election in June. In the autumn of 1901 he was appointed to the command of the Turin army corps.

PELOMYXA, so named by R. Greeff, a genus of Lobose Rhizopoda (*q.v.*), naked, multinucleate, with very blunt rounded pseudopodia, formed by eruption (see AMOEBA), often containing peculiar vesicles (glycogen?), and full of a symbiotic bacterium. It inhabits the ooze of decomposing organic matter at the bottom of ponds and lakes.

PELOPIDAS (d. 364 B.C.), Theban statesman and general. He was a member of a distinguished family, and possessed great wealth which he expended on his friends, while content to lead the life of an athlete. In 385 B.C. he served in a Theban contingent sent to the support of the Spartans at Mantinea, where he was saved, when dangerously wounded, by Epaminondas (*q.v.*). Upon the seizure of the Theban citadel by the Spartans (383 or 382) he fled to Athens, and took the lead in a conspiracy to liberate Thebes. In 379 his party surprised and killed their chief political opponents, and roused the people against the Spartan garrison, which surrendered to an army gathered by Pelopidas. In this and subsequent years he was elected *boeotarch*, and about 375 he routed a much larger Spartan force at Tegyra (near Orchomenus). This victory he owed mainly to the valour of the Sacred Band, a picked body of 300 infantry. At the battle of Leuctra (371) he contributed greatly to the success of Epaminondas's new tactics by the rapidity with which he made the Sacred Band close with the Spartans. In 370 he accompanied his friend Epaminondas as *boeotarch* into Peloponnesus. On their return both generals were unsuccessfully accused of having retained their command beyond the legal term. In 366, in response to a petition of the Thesallians, Pelopidas was sent with an army against Alexander, tyrant of Pherae. After driving Alexander out, he passed into Macedonia and arbitrated between two claimants to the throne. In order to secure the influence of Thebes, he brought home hostages, including the king's brother, afterwards Philip II., the conqueror of Greece. Next year Pelopidas was again called upon to interfere in Macedonia, but, being deserted by his mercenaries, was compelled to make an agreement with Ptolemaeus of Alorus. On his return through Thessaly he was seized by Alexander of Pherae, and two expeditions from Thebes were needed to secure his release. In 367 Pelopidas went on an embassy to the Persian king and induced him to prescribe a settlement of Greece according to the wishes of the Thebans. In 364 he received another appeal from the Thessalian towns against Alexander of Pherae. Though an eclipse of the sun prevented his bringing with him more than a handful of troops, he overthrew the tyrant's far superior force on the ridge of Cynoscephalae; but wishing to slay Alexander with his own hand, he rushed forward too eagerly and was cut down by the tyrant's guards.

Plutarch and Nepos, *Pelopidas*; Diodorus xv. 68-81; Xenophon, *Hellenica*, vii. 1. See also THESSALIA. (M. O. B. C.)

PELOPONNESIAN WAR, in Greek history, the name given specially to the struggle between Athens at the head of the Delian League and the confederacy of which Sparta was the leading power.¹ According to Thucydides the war, which was

¹ Some historians prefer to call it the Second Peloponnesian War, the first being that of 457, which ended with the Thirty Years' Peace.

in his view the greatest that had ever occurred in Greece, lasted from 431 to the downfall of Athens in 404. The genius of Thucydides has given to the struggle the importance of an epoch in world history, but his view is open to two main criticisms—(1) that the war was in its ultimate bearings little more than a local disturbance, viewed from the standpoint of universal history; (2) that it cannot be called a war in the strict sense. The former of these criticisms is justified in the article on GREECE: *History* (q.v.). Unless we are to believe that the Macedonian supremacy is directly traceable to the mutual weakening of the Greek cities in 431-403, it is difficult to see what lasting importance attaches to the war. As regards the second, a few chief difficulties may be indicated. The very narrative even of Thucydides himself shows that the "war" was not a connected whole. It may be divided into three main periods—(1) from 431 to 421 (Lysias calls it the "Archidamian" War), when the Peace of Nicias, not merely formally, but actually produced a cessation of hostilities; (2) from 421 till the intervention of Sparta in the Sicilian War; during these years there was no "Peloponnesian War," and there were several years in which there was in reality no fighting at all: the Sicilian expedition was in fact a side issue; (3) from 413 to 404, when fighting was carried on mainly in the Aegean Sea (Isocrates calls this the "Decelean" War). The disjointed character of the struggle is no obvious from Thucydides himself that historians have come to the conclusion that the idea of treating the whole struggle as a single unit was *ex post facto* (see GREECE: *History*, § A, "Ancient" *ad fin.*).

The book itself affords evidence which goes far to justify this view. A very important problem is presented by bk. v., which is obviously put in as a connecting link to prove a theory. Thucydides expressly warns us not to regard the period of this book as one of peace, and yet the very contents of the book refute his argument. In 419 and 417 there is practically no fighting: the Mantinea War of 418 is a disconnected episode which did not lead to a resumption of hostilities; in 420 there are only obscure battles in Thrace; in 416 there is only the expedition to Melos; and finally from 421 to 413 there is official peace. Other details may be cited in corroboration. Book v. (ch. 26) contains a second introduction to the subject; *ὅτε δὲ πόλεμος* in i. 23 and iv. 48 is the Archidamian or Ten Years' War; in v. 26 we read of a *πρώτος πόλεμος*, a *δευτέρος πόλεμος* and an *ἀναστροφή*. Some critics think on these and other grounds that Thucydides wrote and published bks. i.-v. 25 by itself, then bks. vi. and vii. (Sicilian expedition), and finally revising his view joined them into one whole by the somewhat unsatisfactory bk. v. 26 and following chapters, and began to round off the story with the incomplete bk. viii. (on this see GREECE: *History*, as above). It is perhaps most probable that he retained notes made contemporarily and worked them up some time after 404, in a few passages failing to correct inconsistencies and dying before bk. viii. was completed. The general introduction in bk. i. was unquestionably written shortly after 404.

The causes of the war thus understood are complex. The view taken by Thucydides that Sparta was the real foe of Athens has been much modified by modern writers. The key to the situation is in fact the commercial rivalry of the Corinthians, whose trade (mainly in the West) had been seriously limited by the naval expansion of the Delian League. This rivalry was roused to fever heat by the Athenian intervention in 434-33 on behalf of Corcyra, Corinth's rebellious colony (see CORFU) and from that time the Corinthians felt that the Thirty Years' Truce was at an end. An opportunity soon offered for making a counter attack. Potidaea, a Dorian town on the western promontory of Chalcidice in Thrace, a tributary ally of Athens—to which however Corinth as metropolis still sent annual magistrates—was induced to revolt,¹ with the support of the Macedonian king Perdiccas, formerly an Athenian ally. The Athenian Phormio succeeded in blockading the city so that

¹ The importance of this revolt lay in the fact that it immediately involved danger to Athens throughout the Chalcidic promontories, and her north-east possessions generally.

its capture was merely a question of time, and this provided the Corinthians with an urgent reason for declaring war.

Prior to these episodes Athens had not been in hostile contact with any of the Peloponnesian confederate states for more than ten years, and Pericles had abandoned a great part of his imperial policy. He now laid an embargo upon Megara by which the Megarians were forbidden on pain of death to pursue trading operations with any part of the Athenian Empire. The circumstances of this decree (or decrees) are not material to the present argument (see Grote, *History of Greece*, ed. 1907, p. 370 note) except that it turned special attention to the commercial supremacy which Athens claimed to enjoy. In 432 a conference of Peloponnesian allies was summoned and the Corinthian envoys urged the Spartans to declare war on the ground that the power of Athens was becoming so great as to constitute a danger to the other states. This might have been urged with justice before the Thirty Years' Truce (447); but by that truce Athens gave up all her conquests in Greece proper except Naupactus and Plataea, while her solitary gains in Amphipolis and Thurii were compensated by other losses. The fact that the Corinthian argument failed to impress Sparta and many of the delegates is shown by the course of the debate. What finally impelled the Spartans to agree to the war was the veiled threat by the Corinthians that they would be driven into another alliance (i.e. Argos, i. 71). We can hardly regard Sparta as the determined enemy of Athens at this time. Only twice since 461 had she been at war with Athens—in 457 (Tanagra) and 447, when she deliberately abstained from pushing the advantage which the revolt in Euboea provided; she had refused to help the oligarchs of Samos in 440. Corinth however had not only strong, but also immediate and urgent reasons (Potidaea and Corcyra) for desiring war. It has been argued that the war was ultimately a struggle between the principles of oligarchy and democracy. This view, however, cannot be taken of the early stages of the war when there was democracy and oligarchy on both sides (see *ad fin.*); it is only in the later stages that the political difference is prominent.

The Opposing Forces.—The permanent strength of the Peloponnesian confederacy lay in the Peloponnesian states, all of which except Argos and Achaia were united under Sparta's leadership. But it included also extra-Peloponnesian states—viz. Megara, Phocis, Boeotia and Locris (which had formed part of the Athenian land empire), and the maritime colonies round the Ambracian Gulf. The organization was not elaborate. The federal assembly with few exceptions met only in time of war, and then only when Sparta agreed to summon it. It met in Sparta and the delegates, having stated their views before the Spartan Apella, withdrew till the Apella had come to a decision. The delegates were then invited to return and to confirm that decision. It is clear that the link was purely one of common interest, and that Sparta had little or no control over, e.g. so powerful a confederate as Corinth. Sparta was the chief member of the confederacy (*hegemon*), but the states were autonomous. In time of war each had to provide two-thirds of its forces, and that state in whose territory the war was to take place had to equip its whole force.

The Athenian Empire is described elsewhere (DELIAN LEAGUE, ATHENS). Here it must suffice to point out that there was among the real and technical allies no true bond of interest, and that many of the states were in fact bound by close ties to members of the Peloponnesian confederacy (e.g. Potidaea to Corinth). Sparta could not only rely on voluntary co-operation but could undermine Athenian influence by posing as the champion of autonomy. Further, Thucydides is wrong on his own showing in saying that Sparta refused to tolerate democratic government in confederate cities: it was not till after 418 that this policy was adopted. Athens, on the other hand, had undoubtedly interfered in the interest of democracy in various allied states (see DELIAN LEAGUE).

No detailed examination of the comparative military and naval resources of the combatants can here be attempted. On land the Peloponnesians were superior: they had at least 30,000

hoplites not including 10,000 from Central Greece and Boeotia: these soldiers were highly trained. The Athenian army was undoubtedly smaller. There has been considerable discussion as to the exact figures, the evidence in Thucydides being highly confusing, but it is most probable that the available fighting force was not more than half that of the Peloponnesian confederacy. Even of these we learn (Thuc. iii. 87) that 4400 died in the great plague. The only light-armed force was that of Boeotia at Delium (10,000 with 500 peltasts). Of cavalry Athens had 1000, Boeotia a similar number. The only other cavalry force was that of Thessaly, which, had it been loyal to Athens, would have meant a distinct superiority. In naval power the Athenians undoubtedly had an overwhelming advantage at the beginning, both in numbers and in training.

Financially Athens had an enormous apparent advantage. She began with a revenue of 1000 talents (including 600 from *στυμαχα*), and had also, in spite of the heavy expense which the building schemes of Pericles had involved, a reserve of 6000 talents. The Peloponnesians had no reserve and no fixed revenue assessment. On the other hand the Peloponnesian armies were unpaid, while Athens had to spend considerable sums on the payment of crews and mercenaries. In the last stages of the war the issue was determined by the poverty of Athens and Persian gold.

The events of the struggle from 431 to 404 may be summarized in the three periods distinguished above.

1. *The Ten Years' or Archidamian War.*—The Spartans sent to Athens no formal declaration of war but rather sought first to create some specious *casus belli* by sending requisitions to Athens. The first, intended to inflame the existing hostilities against Pericles (q.v.) in Athens, was that he should be expelled the city as being an Alcmaeonid (grand-nephew of Cleisthenes) and so implicated in the curse pronounced on the murderers of Cylon nearly 200 years before. This outrageous demand was followed by three others—that the Athenians should (1) withdraw from Potidaea, (2) restore autonomy to Aegina, and (3) withdraw the embargo on Megarian commerce. Upon the refusal of all these demands Sparta finally made the maintenance of peace contingent upon the restoration by Athens of autonomy to all her allies. Under the guidance of Pericles Athens replied that she would do nothing on compulsion, but was prepared to submit difficulties to amicable arbitration on the basis of mutual concessions. Before anything could come of this proposal, matters were precipitated (end of March 431) by the attack of Thebes upon Plataea (q.v.), which immediately sought and obtained the aid of Athens. War was begun. The Spartan king Archidamus assembled his army, sent a herald to announce his approach, marched into Attica and besieged Oenoe.

Meanwhile Pericles had decided to act on the defensive, i.e. to abandon Attica, collect all its residents in Athens and treat Athens as an island, retaining meanwhile command of the sea and making descents on Peloponnesian shores. The policy, which Thucydides and Grote commend, had grave defects—though it is by no means easy to suggest a better; e.g. it meant the ruin of the landed class, it tended to spoil the *mores* of those who from the walls of Athens annually watched the wasting of their homesteads, and it involved the many perils of an overcrowded city—a peril increased by, if not also the cause of, the plague. Moreover sea power was not everything, and delay exhausted the financial reserves of the state, while financial considerations, as we have seen, were comparatively unimportant to the Peloponnesians. The descents on the Peloponnesians were futile in the extreme.

Archidamus, having wasted much territory, including Acharnae, retired at the end of July. The Athenians retaliated by attacking Methone (which was secured by Brasidas), by successes in the West, by expelling all Aeginetans from Aegina (which was made a cleruchy), and by wasting the Megarid.

In 430 Archidamus again invaded Attica, systematically wasting the country. Shortly after he entered Attica plague broke out in Athens, borne thither by traders from Carthage or Egypt (Holm, *Greek History*, ii. 346 note). The effect upon

the overcrowded population of the city was terrible. Of the 1200 cavalry (including mounted archers) 300 died, together with 4400 hoplites; altogether the estimate of Diodorus (xiii. 48) that more than 10,000 citizens and slaves succumbed is by no means excessive. None the less Pericles sailed with 100 triremes, and ravaged the territory near Epidaurus. Subsequently he returned and the expedition proceeded to Potidaea. But the plague went with them and no results were achieved. The enemies of Pericles, who even with the aid of Spartan intrigue had hitherto failed to harm his prestige, now succeeded in inducing the desperate citizens to fine him for alleged malversation. The verdict, however, shocked public feeling and Pericles was reinstated in popular favour as strategus (c. Aug. 430). About a year later he died. In the autumn of 430 a Spartan attack on Zacynthus failed and the Ambraciots were repulsed from Amphilocheian Argos. In reply Athens sent Phormio to Naupactus to watch her interests in that quarter. In the winter Potidaea capitulated, receiving extremely favourable terms.

In 429 the Peloponnesians were deterred by the plague from invading Attica and laid siege to Plataea in the interests of Thebes. The Athenians failed in an expedition to Chalcidice under Xenophon, while the Spartan Cnemus with Chaonian and Epirot allies was repulsed from Stratus, capital of Acarnania, and Phormio with only 20 ships defeated the Corinthian fleet of 47 sail in the Gulf of Corinth. Orders were at once sent from Sparta to repair this disaster and 77 ships were equipped. Help sent from Athens was diverted to Crete, and after much manoeuvring Phormio was compelled to fight off Naupactus. Nine of his ships were driven ashore, but with the other 11 he subsequently defeated the enemy and recovered the lost nine. With the reinforcement which arrived afterwards he established complete control of the western seas. A scheme for operating with Sitalces against the Chalcidians of Thrace fell through, and Sitalces joined Perdiccas.

The year 428 was marked by a third invasion of Attica and by the revolt of Lesbos from Athens. After delay in fruitless negotiations the Athenian Cleopides, and afterwards Paches, besieged Mytilene, which appealed to Sparta. The Peloponnesian confederacy resolved to aid the rebels both directly and by a counter demonstration against Athens. The Athenians, though their reserve of 6000 talents was by now almost exhausted (except for 1000 talents in a special reserve), made a tremendous effort (raising 200 talents by a special property tax), and not only prevented an invasion by a demonstration of 100 triremes at the Isthmus, but sent Asopius, son of Phormio, to take his place in the western seas. In spring 427 the Spartans again invaded Attica without result. The winter of 428-427 was marked by the daring escape of half the Plataean garrison under cover of a stormy night, and by the capitulation of Mytilene, which was forced upon the oligarchic rulers by the democracy. The Spartan fleet arrived too late and departed without attempting to recover the town. Paches cleared the Asiatic seas of the enemy, reduced the other towns of Mytilene and returned to Athens with upwards of 1000 prisoners. An assembly was held and under the invective of Cleon (q.v.) it was decided to kill all male Mytileneans of military age and to sell the women and children as slaves. This decree, though in accordance with the rigorous customs of ancient warfare as exemplified by the treatment which Sparta shortly afterwards meted out to the Plataeans, shocked the feelings of Athens, and on the next day it was (illegally) rescinded just in time to prevent Paches carrying it out. The thousand¹ oligarchic prisoners were however executed, and Lesbos was made a cleruchy.

Meanwhile there occurred civil war in Corcyra, in which ultimately, with the aid of the Athenian admiral Eurymedon, the democracy triumphed amid scenes of the wildest savagery. In the autumn of the year Nicias fortified Minoa at the mouth of the harbour of Megara. Shortly afterwards the Spartans

¹ So Thuc. iii. 50. It is suggested that this number is an error for 30 or 50 (i.e. A or N for A). It seems incredible that 1000 could be described as "ringleaders" out of a population of perhaps 5000.

planted an unsuccessful colony at Heraclæa in the Trachinian territory north-west of Thermopylæ.

In the summer of 426 Nicias led a predatory expedition along the north-west coast without achieving any positive victory. More important, though equally ineffective, was the scheme of Demosthenes to march from Naupactus through Aetolia, subduing the wild hill tribes, to Cytinium in Doris (in the upper valleys of the Cephissus) and thence into Boeotia, which was to be attacked simultaneously from Attica. The scheme was crushed by the courage and skill of the Aetolians, who thereupon summoned Spartan and Corinthian aid for a counter attack on Naupactus. Demosthenes averted this, and immediately afterwards by superior tactics inflicted a complete defeat at Olpæ in Acarnania on Eurylochus at the head of a Spartan and Ambracian force. An Ambracian reinforcement was annihilated at one of the peaks called Idomene, and a disgraceful truce was accepted by the surviving Spartan leader Menedæus. This was not only the worst disaster which befell any powerful state up to the peace of Nicias (as Thucydides says), but was a serious blow to Corinth, whose trade on the West was, as we have seen, one of the chief causes of the war.

The year 425 is remarkable for the Spartan disaster of Pylos (q.v.). The Athenians had despatched 40 triremes under Eurymedon and Procles to Sicily with orders to sail first at Corcyra to prevent an expected Spartan attack. Meantime Demosthenes had formed the plan of planting the Messenians of Naupactus in Messenia—now Spartan territory—and obtained permission to accompany the expedition. The fleet was, as it chanced, delayed by a storm in the Bay of Navarino, and rough fortifications were put up by the sailors on the promontory of Pylos. Demosthenes was left behind in this fort, and the Spartans promptly withdrew from their annual raid upon Attica and their projected attack on Corcyra to dialogue him. After a naval engagement (see PYLOS) a body of Spartan hoplites were cut off on Sphacteria. So acutely did Sparta feel their position that an offer of peace was made on condition that the hoplites should go free. The eloquence of Cleon frustrated the peace party's desire to accept these terms, and ultimately to the astonishment of the Greek world the Spartan hoplites to the number of 292 surrendered unconditionally (see CLEON).

Thus in 424 the Athenians had seriously damaged the prestige of Sparta, and broken Corinthian supremacy in the north-west, and the Peloponnesians had no fleet. This was the zenith of their success, and it was unfortunate for them that they declined the various offers of peace which Sparta made. The next two years changed the whole position. The doubling of the tribute in 425 pressed hardly on the allies (see DELIAN LEAGUE): Nicias failed in a plot with the democratic party in Megara to seize that town; and the brilliant campaigns of Brasidas (q.v.) in the north-east, culminating in the capture of Amphipolis (422), finally destroyed the Athenian hopes of recovering their land empire, and entirely restored the balance of success and Spartan prestige. Moreover, the admirably conceived scheme for a simultaneous triple attack upon Boeotia at Chaeronea in the north, Delium in the south-east, and Siphæ in the south-west had fallen through owing to the inefficiency of the generals. The scheme, which probably originated with the atticizing party in Thebes, resulted in the severe defeat of Hippocrates at Delium by the Boeotians under Pagondas, and was a final blow to the policy of an Athenian land empire.

These disasters at Megara, Amphipolis and Delium left Athens with only one trump card—the possession of the Spartan hoplites captured in Sphacteria. This solitary success had already in the spring of 423 induced Sparta in spite of the successes which Brasidas was achieving in Thrace to accept the "truce of Laches"—which, however, was rendered abortive by the refusal of Brasidas to surrender Scione. The final success of Brasidas at Amphipolis, where both he and Cleon were killed, paved the way for a more permanent agreement, the peace parties at Athens and Sparta being in the ascendant.

2. From 421 to 413.—Peace was signed in March 421 on the basis of each side's surrendering what had been acquired by

the war, not including those cities which had been acquired by capitulation. It was to last for fifty years. Its weak points, however, were numerous. Whereas Sparta had been least of all the allies interested in the war, and apart from the campaigns of Brasidas had on the whole taken little part in it, her allies benefited least by the terms of the Peace. Corinth did not regain Sollium and Anactorium, while Megara and Thebes respectively were indignant that Athens should retain Nisæa and receive Panactum. These and other reasons rapidly led to the isolation of Sparta, and there was a general refusal to carry out the terms of agreement. The history of the next three years is therefore one of complex inter-state intrigues combined with internal political convulsions. In 421 Sparta and Athens concluded a defensive alliance; the Sphacterian captives were released and Athens promised to abandon Pylos. Such a peace, giving Sparta everything and Athens nothing but Sparta's bare alliance, was due to the fact that Nicias and Alcibiades were both seeking Sparta's friendship. At this time the Fifty Years' Truce between Sparta and Argos was expiring. The Peloponnesian malcontents turned to Argos as a new leader, and an alliance was formed between Argos, Corinth, Elis, Mantinea and the Thraceward towns (420). This coalition between two different elements—an anti-oligarchic party and a war party—had no chance of permanent existence. The war party in Sparta regained its strength under new ephors and negotiations began for an alliance between Sparta, Argos and Boeotia. The details cannot here be discussed. The result was a re-shuffling of the cards. The democratic states of the Peloponnese were driven, partly by the intrigues of Alcibiades, now anti-Laconian, into alliance with Athens, with the object of establishing a democratic Peloponnese under the leadership of Argos. These unstable combinations were soon after upset by Alcibiades himself, who, having succeeded in displacing Nicias as strategus in 419, allowed Athenian troops to help in attacking Epidaurus. For a cause not easy to determine Alcibiades was defeated by Nicias in the election to the post of strategus in the next year, and the suspicions of the Peloponnesian coalition were roused by the inadequate assistance sent by Athens, which arrived too late to assist Argos when the Spartan king Agis marched against it. Ultimately the Spartans were successful over the coalition at Mantinea, and soon afterwards an oligarchic revolution at Argos led to an alliance between that city and Sparta (c. Feb. 417). This oligarchy was overthrown again in June, and the new democracy having vainly sought an agreement with Sparta rejoined Athens. It was thus left to Athens to expend men and money on protecting a democracy by the aid of which she had hoped practically to control the Peloponnese. All this time, however, the alliance between her and Sparta was not officially broken.

The unsatisfactory character of the Athenian Peloponnesian coalition was one of the negative causes which led up to the Sicilian Expedition of 415. Another negative cause may be found in the failure of an attempt or attempts to subdue the Thraceward towns. By combining the evidence of Plutarch (in his comparison of Nicias and Crassus), Thuc. v. 83, and the inscription which gives the treasury payments for 418-415 (Hicks and Hill, *Gr. Hist. Inscr.* 70), we can scarcely doubt that there were expeditions in 418 (Euthydemus) and the summer of 417 (Nicias), and that in the winter of 417 a blockading squadron under Chaeremon was despatched. This policy—which was presumably that of Nicias in opposition to Alcibiades—having failed, the way was cleared for a reassertion of that policy of western conquest which had always had advocates from Themistocles onward in Athens,¹ and was part of the democratic programme.

The tragic fiasco of the Sicilian expedition, involving the death

¹ In 454 Athens made a treaty with Segesta (*Inscr.* Hicks and Hill, *Greek Hist. Inscr.* 34): in 433 with Rhegium and Leontini (Hicks and Hill, 51 and 52; cf. Thuc. iii. 86, *ἡ ἀσπὴ ἀσπυργία* with Chalcidic towns in Sicily); in 444 the colony of Thurii was founded; in 427 (see above) 60 ships were sent to Sicily; and if we may believe Aristophanes (*Eg.* 1302) Hyperbolus asked for 100 triremes for Carthage.

of Nicias and the loss of thousands of men and hundreds of ships, was a blow from which Athens never recovered (see under SYRACUSE and SICILY). Even before the final catastrophe the Spartans had reopened hostilities. On the advice of Alcibiades (*q.v.*), exiled from Athens in 415, they had fortified Declea in Attica within fifteen miles of Athens. This place not only served as a permanent headquarters for predatory expeditions, but cut off the revenue from the Laurium mines, furnished a ready asylum for runaway slaves, and rendered the transference of supplies from Euboea considerably more difficult (*i.e.* by the sea round Cape Sunium). Athens thus entered upon the third stage of the conflict with exceedingly poor prospects.

3. *The Ionian or Decleean War.*—From the Athenian standpoint this war may be broken up into three periods: (1) period of revolt of allies (413-411), (2) the rally (410-408), (3) the relapse (407-404). As contrasted with the Archidamian War, this war was fought almost exclusively in the Aegean Sea, the enemy was primarily Sparta, and the deciding factor was Persian gold. Furthermore, apart from the gradual disintegration of the empire, Athens was disturbed by political strife.

In 412 many Ionian towns revolted, and appealed either to Agis at Declea or to Sparta direct. Euboea, Lesbos, Chios, Erythrae led the way in negotiation and revolt, and simultaneously the court of Susa instructed the satraps Pharnabazus and Tissaphernes to renew the collection of tribute from the Greek cities of Asia Minor. The satraps likewise made overtures to Sparta. The revolt of the Ionian allies was due in part to Alcibiades also, whose prompt action in co-operation with his friend the ephor Endius finally confirmed the Chian oligarchs in their purpose. In 411 a treaty was signed by Sparta and Tissaphernes against Athens: the treaty formally surrendered to the Persian king all territory which he or his predecessors had held. It was subsequently renewed in a form somewhat less disgraceful to Greek patriotism by the Spartans Astyochus and Theramenes. On the other hand, a democratic rising in Samos prevented the rebellion of that island, which for the remainder of the war was invaluable to Athens as a stronghold lying between the two great centres of the struggle.

After the news of the Sicilian disaster Athens was compelled at last to draw on the reserve of 1000 talents which had lain untouched in the treasury.¹ The revolt of the Ionian allies, and (in 411) the loss of the Hellespontine, Thracian and Island tributes (see DELIAN LEAGUE), very seriously crippled her finances. On the other hand, Tissaphernes undertook to pay the Peloponnesian sailors a daily wage of one Attic drachma (afterwards reduced to $\frac{1}{2}$ drachma). In Attica itself Athens lost Oenoe and Oropus, and by the end of 411 only one quarter of the empire remained. In the meanwhile Tissaphernes began to play a double game with the object of wasting the strength of the combatants. Moreover Alcibiades lost the confidence of the Spartans and passed over to Tissaphernes, at whose disposal he placed his great powers of diplomacy, at the same time scheming for his restoration to Athens. He opened negotiations with the Athenian leaders in Samos and urged them to upset the democracy and establish a philo-Persian oligarchy. After elaborate intrigues, in the course of which Alcibiades played false to the conspirators by forcing them to abandon the idea of friendship with Tissaphernes owing to the exorbitant terms proposed, the new government by the Four Hundred was set up in Athens (see THERAMENES). This government (which received no support from the armament in Samos) had a brief life, and on the final revolt of Euboea was replaced by the old democratic system. Alcibiades (*q.v.*) was soon afterwards invited to return to Athens.

The war, which, probably because of financial trouble, the Spartans had neglected to pursue when Athens was thus in the throes of political convulsion, was now resumed. After much manoeuvring and intrigues a naval battle was fought at Cynos-

sema in the Hellespont in which victory on the whole rested with the Athenians (Aug. 411), though the net result was inconsiderable. About this time the duplicity of Tissaphernes—who having again and again promised a Phoenician fleet and having actually brought it to the Aegean finally dismissed it on the excuse of trouble in the Levant—and the vigorous honesty of Pharnabazus definitely transferred the Peloponnesian forces to the north-west coast of Asia Minor and the Hellespont. There they were regularly financed by Pharnabazus, while the Athenians were compelled to rely on forced levies. In spite of this handicap Alcibiades, who had been seized and imprisoned by Tissaphernes at Sardis but effected his escape, achieved a remarkable victory over the Spartan Mindarus at Cyzicus (about April 410). So complete was the destruction of the Peloponnesian fleet that, according to Diodorus, peace was offered by Sparta (see *ad fin.*) and would have been accepted but for the warlike speeches of the "demagogue" Cleophon representing the extreme democrats.² Another result was the return to allegiance (409) of a number of the north-east cities of the empire. Great attempts were made by the Athenians to hold the Hellespont and then to protect the corn-supply from the Black Sea. In Greece these gains were compensated by the loss of Pylos and Nisaea.

In 408 Alcibiades effectively invested Chalcedon, which surrendered by agreement with Pharnabazus, and subsequently Byzantium also fell into his hands with the aid of some of its inhabitants.

Pharnabazus, weary of bearing the whole cost of the war for the Peloponnesians, agreed to a period of truce so that envoys might visit Susa, but at this stage the whole position was changed by the appointment of Cyrus the Younger as satrap of Lydia, Greater Phrygia and Cappadocia. His arrival coincided with the appointment of Lysander (*c. Dec. 408*) as Spartan admiral—the third of the three great commanders (Brasidas and Gylippus being the others) whom Sparta produced during the war. Cyrus promptly agreed on the special request of Lysander (*q.v.*) to pay slightly increased wages to the sailors, while Lysander established a system of anti-Athenian clubs and oligarchic governments in various cities. Meanwhile Alcibiades (May 407), having exacted levies in Caria; returned at length to Athens and was elected strategus with full powers (see STRATEGUS). He raised a large force of men and ships and endeavoured to draw Lysander (then at Ephesus) into an engagement. But Cyrus and Lysander were resolved not to fight till they had a clear advantage, and Alcibiades took a small squadron to Phocaea. In spite of his express orders his captain Antiochus in his absence provoked a battle and was defeated and killed at Notium. This failure and the refusal of Lysander to fight again destroyed the confidence which Alcibiades had so recently regained. Ten strategi were appointed to supersede him and he retired to fortified ports in the Chersonese which he had prepared for such an emergency (*c. Jan. 406*). At the same time Lysander's year of office expired and he was superseded by Callicratidas, to the disgust of all those whom he had so carefully organized in his service. Callicratidas, an honourable man of pan-Hellenic patriotism, was heavily handicapped in the fact that Cyrus declined to afford him the help which had made Lysander powerful, and had recourse to the Milesians and Chians, with whose aid he fitted out a fleet of 140 triremes (only 10 Spartan). With these he pursued Conon (chief of the ten new Athenian strategi), captured 30 of his 70 ships and besieged him in Mytilene. Faced with inevitable destruction, Conon succeeded in sending the news to Athens, where by extraordinary efforts a fleet of 110 ships was at once equipped. Callicratidas, hearing of this fleet's approach, withdrew from Mytilene, leaving Eteonicus in charge of the blockade. Forty more ships were collected by the Athenians, who met and defeated Callicratidas at Arginusae with a loss of more than half his fleet. The immediate result was that Eteonicus left Mytilene and Conon found himself free. Unfortunately the victorious generals at Arginusae, through negligence or owing

¹ She had already abolished the system of tribute in favour of a 5% *ad valorem* tax on all imports and exports carried by sea between her ports and those of the allies.

² Xenophon, *Hell.* does not mention it: Thucydides's history had by this time come to an end.

to a storm, failed to recover the bodies of those of their crews who were drowned or killed in the action. They were therefore recalled, tried and condemned to death, except two who had disobeyed the order to return to Athens.

At this point Lysander was again sent out, nominally as secretary to the official admiral Aracus. Cyrus, recalled to Susa by the illness of Darius, left him in entire control of his satrapy. Thus strengthened he sailed to Lampsacus on the Hellespont and laid siege to it. Conon, now in charge of the Athenian fleet, sailed against him, but the fleet was entirely destroyed while at anchor at Aegospotami (Sept. 405), Conon escaping with only 12 out of 180 sail to Cyprus. In April 404 Lysander sailed into the Peiraeus, took possession of Athens, and destroyed the Long Walls and the fortifications of Peiraeus. An oligarchical government was set up (see CURTIUS), and Lysander having compelled the capitulation of Samos, the last Athenian stronghold, sailed in triumph to Sparta.

Two questions of considerable importance for the full understanding of the Peloponnesian War may be selected for special notice: (1) how far was it a war between two antagonistic theories of government, oligarchic and democratic? and (2) how far was Athenian statesmanship at fault in declining the offers of peace which Sparta made?

1. A common theory is that Sparta fought throughout the war as an advocate of oligarchy, while Athens did not seek to interfere with the constitutional preferences of her allies. The view is based partly on Thuc. i. 19, according to which the Spartans took care that their allies should adhere to a policy convenient to themselves. This idea is disproved by Thucydides' own narrative, which shows that down to 418 (the battle of Mantinea) Sparta tolerated democratic governments in Peloponnesus itself—e.g. Elis, Mantinea, Sicyon, Achaea. It was only after that date that democracy was suppressed in the Peloponnesian League, and even then Mantinea remained democratic. In point of fact, it was only when Lysander became the representative of Spartan foreign policy—i.e. in the last years of the war—that Sparta was identified with the oligarchic policy.

On the other hand, there is strong evidence that the Athenian Empire at a much earlier date was based upon a uniform democratic type of government (cf. Thuc. i. 19, viii. 64; Xen. Pol. i. 14, Hell. iii. 47; Arist. Pol. viii. 69). It is true that we find oligarchic government in Chios and Lesbos (up to 428) and in Samos (up to 440); but this is discounted by the fact that all three were "autonomous" allies. Moreover, in the case of Samos there was a democracy in 439, though in 412 the government was again oligarchic. The case of Selymbria (see Hicks and Hill, *op. cit.* 77) is of little account, because at that time (409) the Empire was in *extremis*. In general we find that Athenian orators take special credit on the ground that the Athenian had given to her allies the constitutional advantages which they themselves enjoyed.

2. In view of the disastrous issue of the war, it is important to notice that on three occasions—(a) after Pylos, (b) after Cyzicus, (c) after Arginus—Athens refused formal peace proposals from Sparta. (a) Though Cleon was probably wise in opposing peace negotiations before the capture of the Spartans in Sphacteria, it seems in the light of subsequent events that he was wrong to refuse the terms which were offered after the hoplites had been captured. No doubt, however, the temper in Athens was at that time predominantly warlike, and the surrender of the hoplites was a unique triumph. Possibly, too, Cleon foresaw that peace would have meant a triumph for the philo-Laconian party. (b) The peace proposals of 410 are given by Diodorus, who says that the ephor Endius proposed that a peace should be made on the basis of *vis possidetis*, except that Athens should evacuate Pylos and Cythera, and Sparta, Decelea. Cleophon, however, perhaps doubting whether the offer was sincere (cf. Philochorus in Schol. *ap. Eurip. Orest.* 371; *Fragm. ed. Didot*, 117, 118), demanded the *status quo ante* (413 or 431). (c) The proposals of 406, mentioned by *Ath. Pol.* 34, were on the same lines, except that Athens no longer had Pylos and Cythera, and had lost practically half her empire. At this time peace must therefore have been advantageous to Athens as showing the world that in spite of her losses she was still one of the great powers of Greece. Moreover, an alliance with Sparta would have meant a check to Persian interference. It is probable, again, that party interest was a leading motive in Cleophon's mind, since a peace would have meant the return of the oligarchic exiles and the establishment of a moderate oligarchy.

AUTHORITIES.—G. Busolt, *Griech. Gesch.*, Bd. iii., Teil ii. (1904). "Der Peloponnesische Krieg" is essential. All histories of Greece may be consulted (see GREECE: *History, Ancient*, section "Authorities"). (J. M. M.)

PELOPONNESUS ("Island of Pelops"), the ancient and modern Greek official name for the part of Greece south of the Isthmus of Corinth. In medieval times it was called the Morea,

from its resemblance to a mulberry-leaf in shape, and this name is still current in popular speech.

PELOPS, in Greek legend, the grandson of Zeus, son of Tantalus and Dione, and brother of Niobe. His father's home was on Mt Sipyhus in Asia Minor, whence Pelops is spoken of as a Lydian or a Phrygian. Tantalus one day served up to the gods his own son Pelops, boiled and cut in pieces. The gods detected the crime, and none of them would touch the food except Demeter (according to others, Thetis), who, distracted by the loss of her daughter Persephone, ate of the shoulder. The gods restored Pelops to life, and the shoulder consumed by Demeter was replaced by one of ivory. Wherefore the descendants of Pelops had a white mark on their shoulder ever after (Ovid, *Metam.* vi. 404; Virgil, *Georgics*, lii. 7). This tale is perhaps reminiscent of human sacrifice amongst the Greeks. Poseidon carried Pelops off to Olympus, where he dwelt with the gods, till, for his father's sins, he was cast out from heaven. Then, taking much wealth with him, he crossed over from Asia to Greece. He went to Pisa in Elis as suitor of Hippodameia, daughter of king Oenomaus, who had already vanquished in the chariot-race and slain many suitors for his daughter's hand. But by the help of Poseidon, who lent him winged steeds, or of Oenomaus's charioteer Myrtilus, whom he or Hippodameia bribed, Pelops was victorious in the race, wedded Hippodameia, and became king of Pisa (Hyginus, *Fab.* 84). The race of Pelops for his wife may be a reminiscence of the early practice of marriage by capture. When Myrtilus claimed his promised reward, Pelops flung him into the sea near Gerastus in Euboea, and from his dying curse sprang those crimes and sorrows of the house of Pelops which supplied the Greek tragedians with such fruitful themes (Sophocles, *Electra*, 505, with Jebb's note). Among the sons of Pelops by Hippodameia were Atreus, Thyestes and Chrysippus. From Pisa Pelops extended his sway over the neighbouring Olympia, where he celebrated the Olympian games with a splendour unknown before. His power and fame were so great that henceforward the whole peninsula was known to the ancients as Peloponnesus, "island of Pelops" (ἠῖος, island). In after times Pelops was honoured at Olympia above all other heroes; a temple was built for him by Heracles, his descendant in the fourth generation, in which the annual magistrates sacrificed to him a black ram.

From the reference to Asia in the tales of Tantalus, Niobe and Pelops it has been conjectured that Asia was the original seat of these legends, and that it was only after emigration to Greece that the people localized a part of the tale of Pelops in their new home. In the time of Pausanias the throne of Pelops was still shown on the top of Mt Sipyhus. The story of Pelops is told in the first Olympian ode of Pindar and in prose by Nicolaus Damascenus.

PELOTA (Sp. "little ball," from Lat. *pila*), a ball game which, originating centuries ago in the Basque provinces, has developed into several forms of the sport. Epigrams of Martial show that there were at least three kinds of pelota played in his time. *Blas*, practically hand fives against the back wall of a court, is still played on both sides of the Pyrenees. It is so popular that the authorities had to forbid its being played against the walls of the cathedral at Barcelona. In uncovered courts of large size there are two varieties of pelota. One, the favourite pastime of the Basque, is played against a front wall (*fronton*), either barehanded, with a leather or wooden long glove-like protector (*cesta*), or with a *chistera* strapped to the wrist, a sickle-shaped wicker-work implement three feet long, much like a hansom-wheel basket mud-guard, in the narrow groove of which the ball is caught and from which, thanks to the leverage afforded, it can be hurled with tremendous force. There are several players to a side, frequently an uneven number to allow a handicap. The score is announced by a *cañtara*, whose melodious vocal efforts make him not the least appreciated participant in the game. In the other form of the game, played nearly exclusively by professionals (*pelotaris*), there are usually three players on each side, two forwards and a back, distinguished by a coloured sash or cap. The server (*bulneur*) slips off his *chistera* to serve, bouncing the ball on the *but*, a kind of stool, about 30 ft. from the wall, and

striking it low against the wall. The side that wins the toss has the first service. The ball must be replayed by the opposing side at the wall, which it must hit over a line 3 ft. from the base of the wall and under the net fixed at the top of the wall. The game is counted 15, 30, 40, game, reckoned by the number of faults made by the opposing side. A fault is scored (a) when after the service the ball is not caught on the volley or first bounce, (b) when it does not on the return strike the wall within the prescribed limits, (c) when it goes out of the prescribed limits of the court, (d) when it strikes the net fixed at the top of the court. The side making the fault loses the service. A game like this has been played in England by Spanish professionals on a court 250 ft. long, against a wall 30 ft. high and 55 ft. wide. The ball used, a trifle smaller than a base-ball, is hard rubber wound with yarn and leather-covered, weighing 5 ounces. The server bounces the ball on the concrete floor quite near the *fronton*, and hits it with his *chistera* against the wall with a force to make it rebound beyond a line 80 ft. back. It usually goes treble that distance.

PELOTAS, a city of the state of Rio Grande do Sul, Brazil, on the left bank of the São Gonçalo river near its entrance into the Lagoa dos Patos, about 30 m. N.W. of the city of Rio Grande. Pop. (1900), city, about 24,000; *município* (commune, 1037 sq. m.), 43,091. The Rio Grande Bagé railway communicates with the city of Rio Grande, and with the railways extending to Bagé, Cacequi, Santa Maria, Passo Fundo and Porto Alegre. The São Gonçalo river is the outlet of Lagoa Mirim, and Pelotas is therefore connected with the inland water routes. The city is built on an open grassy plain (*campo*) little above the level of the lake (28 ft. above sea-level). The public buildings include the church of São Francisco, dating from the early part of the 19th century, the municipal hall, a fine theatre, the Misericórdia hospital, a public library containing about 25,000 volumes and a great central market. Pelotas is the centre of the *xarque* or *carne secca* (jerked beef) industry of Rio Grande do Sul. In its outskirts and the surrounding country are an immense number of *xarqueadas* (slaughter-houses), with large open yards where the dressed beef, lightly salted, is exposed to the sun and air. There are many factories or packing houses where the by-products are prepared for market. Pelotas was only a small settlement at the beginning of the 19th century and had no parochial organization until 1812. It became a *villa* in 1830 and a city in 1835.

PELOUZE, THÉOPHILE JULES (1807-1867), French chemist, was born at Valognes, in Normandy, on the 26th (or 13th) of February 1807. His father, Edmond Pelouze (d. 1847), was an industrial chemist and the author of several technical handbooks. The son, after spending some time in a pharmacy at La Fère, acted as laboratory assistant to Gay-Lussac and J. L. Lassaigne (1800-1850) at Paris from 1827 to 1829. In 1830 he was appointed associate professor of chemistry at Lille, but returning to Paris next year became répétiteur, and subsequently professor, at the École Polytechnique. He also held the chair of chemistry at the Collège de France, and in 1833 became assayer to the mint and in 1848 president of the Commission des Monnaies. After the *coup d'état* in 1851 he resigned his appointments, but continued to conduct a laboratory-school he had started in 1846. He died in Paris on the 1st of June 1867. Though Pelouze made no discovery of outstanding importance, he was a busy investigator, his work including researches on salicin, on beetroot sugar, on various organic acids—gallic, malic, tartaric, butyric, lactic, &c.—on oenanthic ether (with Liebig), on the nitrosulphates, on gun-cotton, and on the composition and manufacture of glass. He also carried out determinations of the atomic weights of several elements, and with E. Frémy, published *Traité de chimie générale* (1847-1850); *Abrégé de chimie* (1848); and *Notions générales de chimie* (1853).

PELTIER, JEAN CHARLES ATHANASE (1785-1845), French physicist, was born at Ham (Somme) on the 22nd of February 1785. He was originally a watchmaker, but retired from business about the age of thirty and devoted himself to experimental and observational science. His papers, which are

numerous, are devoted in great part to atmospheric electricity, waterspouts, cyanometry and polarization of skylight, the temperature of water in the spheroidal state, and the boiling-point at great elevations. There are also a few devoted to curious points of natural history. But his name will always be associated with the thermal effects at junctions in a voltaic circuit. His great experimental discovery, known as the "Peltier effect," was that if a current pass from an external source through a circuit of two metals it *cools* the junction through which it passes in the same direction as the thermo-electric current which would be caused by directly heating that junction, while it heats the other junction (see THERMO-ELECTRICITY). Peltier died in Paris on the 27th of October 1845.

PELTUINIUM [mod. Civita Ansidonia], a town of the Vestini, on the Via Claudia Nova, 12 m. E.S.E. of Aquila. It was apparently the chief town of that portion of the Vestini who dwelt west of the main Apennine chain. Remains of the town walls, of an amphitheatre, and of other buildings still exist.

PELUSIUM, an ancient city and port of Egypt, now represented by two large mounds close to the coast and the edge of the desert, 30 m. E. of Port Said. It lay in the marshes at the mouth of the most easterly (Pelusiac) branch of the Nile, which has long since been silted up, and was the key of the land towards Syria and a strong fortress, which, from the Persian invasion at least, played a great part in all wars between Egypt and the East. Its name has not been found on Egyptian monuments, but it may be the Sin of the Bible and of Assur-bani-pal's inscription. Pelusium ("the muddy") is the Faramā of the Arabs, Pelmoun in Coptic; the name Tina which clings to the locality seems etymologically connected with the Arabic word for clay or mud. The site, crowned with extensive ruins of burnt brick of the Byzantine or Arab period, has not yielded any important remains. (F. L. G.)

PELVIS (Lat. for "basin," cf. Gr. *πίλλος*), in anatomy, the bony cavity at the lower part of the abdomen in which much of the genito-urinary apparatus and the lower part of the bowels are contained (see SKELETON, § *Appendicular*).

PEMBA, an island in the Indian Ocean off the east coast of Africa, forming part of the sultanate of Zanzibar. Pemba lies 30 m. N.N.E. of Zanzibar island between 4° 30' and 5° 30' S., and 39° 35' and 39° 50' E. It is some 40 m. long and 10 across at its broadest part, and has an area of 380 sq. m. It is of coral-line formation. On the side facing the mainland the coast is much indented. From its luxuriant vegetation it gets its Arabic name of Al-huthera—"The Green." The interior is diversified by hills, some of which exceed 600 ft. The land is chiefly owned by great Arab proprietors, who work their plantations with Swahili labour, and with negroes from the mainland. Prior to 1807 the labourers were all slaves. Their gradual manumission was accomplished without injury to the prosperity of the island. The population is estimated at between 50,000 and 60,000, of whom 2000 to 3000 are Arabs. Most of the inhabitants are of Bantu stock, and are known as Wapemba. In the ports there are many Hindu traders and a few Europeans. The plantations are nearly all devoted to cloves (the annual average output being 10,000,000 lb) and coco-nut palms (for the preparation of copra). The number of coco-nut plantations is very small compared with those devoted to cloves. Yet cloves need much care and attention and yield small profit, while the coco-nut palm yields a fairly uniform crop of nuts and will grow almost anywhere. The preponderance of clove plantations dates from a cyclone which in 1878 destroyed nearly all the clove-trees in the island of Zanzibar. Thereupon, to benefit from the great rise in the price of cloves, the Pemba planters cut down their palms and planted cloves. The value of the cloves exported in 1907 was £339,000, or 92% of the total exports. India, Germany and Great Britain are, in the order named, the chief purchasers. Other exports include fire-wood, skins and hides, mother-of-pearl, wax and small quantities of rubber, cowries, tortoiseshell and so-called tortoise-nail. The "tortoise-nail" is the valve with which a shell-fish closes its shell. The *Liliodolphia* rubber-vine is indigenous, and since 1906 Ceara rubber-trees have been

extensively planted. Rice, the chief of Pemba's imports, could easily be grown on the island. Cotton cloths (Kangas) form the next most considerable item in the imports.

Pemba has three ports, all on the west side of the island. Shaki-Shaki, the capital and the centre of trade, is centrally situated at the head of a shallow tidal creek partly blocked by dense growths of mangroves. Mkoani is on the south-west coast, Kishi-Kashi on the north-west coast; at the last-named port there is a deep and well-sheltered harbour, approached however by a narrow and dangerous channel.

Pemba is administered as an integral part of the Zanzibar dominions, and yields a considerable surplus to the exchequer, mainly from a 25% duty imposed on cloves exported. There is a weekly steamship service to Zanzibar, and in 1907 the two islands were connected by wireless telegraphy (see ZANZIBAR).

PEMBROKE, EARLS OF. The title of earl of Pembroke has been held successively by several English families, the jurisdiction and dignity of a palatine earldom being originally attached to it. The first creation dates from 1138, when the earldom of Pembroke was conferred by King Stephen on Gilbert de Clare (d. 1148), son of Gilbert Fitz-Richard, who possessed the lordship of Strigul (Estrigol, in *Domesday Book*), the modern Chepstow. After the battle of Lincoln (1141), in which he took part, the earl joined the party of the empress Matilda, and he married Henry I.'s mistress, Isabel, daughter of Robert de Beaumont, earl of Leicester.

RICHARD DE CLARE, 2nd earl of Pembroke (d. 1176), commonly known as "Strongbow," son of the first earl, succeeded to his father's estates in 1148, but had forfeited or lost them by 1168. In that year Dermot, king of Leinster, driven out of his kingdom by Roderick, king of Connaught, came to solicit help from Henry II. He secured the services of Earl Richard, promising him the hand of his daughter Eva and the succession to Leinster. The earl crossed over in person (1170), took both Waterford and Dublin, and was married to Eva. But Henry II., jealous of this success, ordered all the troops to return by Easter 1171. In May Dermot died; this was the signal of a general rising, and Richard barely managed to keep Roderick of Connaught out of Dublin. Immediately afterwards he hurried to England to solicit help from Henry II., and surrendered to him all his lands and castles. Henry crossed over in October 1172; he stayed in Ireland six months, and put his own men into nearly all the important places, Richard keeping only Kildare. In 1173 he went in person to France to help Henry II., and was present at Verneuil, being reinstated in Leinster as a reward. In 1174 he advanced into Connaught and was severely defeated, but fortunately Raymond le Gros re-established his supremacy in Leinster. Early in 1176 Richard died, just as Raymond had taken Limerick for him. Strongbow was the statesman, as the Fitzgeralds were the soldiers, of the conquest. He is vividly described by Giraldus Cambrensis as a tall and fair man, of pleasing appearance, modest in his bearing, delicate in features, of a low voice, but sage in council and the idol of his soldiers. He was buried in the cathedral church of Dublin, where his effigy and that of his wife are still preserved.

See Giraldus Cambrensis, *Expugnatio hibernica*; and the *Song of Dermot*, edited by G. H. Orpen (1892).

Strongbow having died without male issue, his daughter ISABEL became countess of Pembroke in her own right, and the title was borne by her husband, SIR WILLIAM MARSHAL, or Le Maréchal, second son of John le Maréchal, by Sibylla, the sister of Patrick, earl of Salisbury. John le Maréchal was a partisan of the empress Matilda, and died about 1164.

The date of Sir William Marshal's birth is uncertain, but his parents were married not earlier than 1141, and he was a merchant in 1152, when he attracted the notice of King Stephen. In 1170 he was selected for a position in the household of Prince Henry, the heir-apparent, and remained there until the death of his young patron (1183). He undertook a pilgrimage to the Holy Land, where he served as a crusader with distinction for two years. Although he had abetted the prince in rebellion he was pardoned by Henry II. and admitted to the royal service

about 1188. In 1189 he covered the flight of Henry II. from Le Mans to Chinon, and, in a skirmish, unhorsed the undutiful Richard Cœur de Lion. None the less Richard, on his accession, promoted Marshal and confirmed the old king's licence for his marriage with the heiress of Strigul and Pembroke. This match gave Marshal the rank of an earl, with great estates in Wales and Ireland, and he was included in the council of regency which the king appointed on his departure for the third crusade (1190). He took the side of Prince John when the latter expelled the justiciar, William Longchamp, from the kingdom, but he soon discovered that the interests of John were different from those of Richard. Hence in 1193 he joined with the loyalists in making war upon the prince. Richard forgave Marshal his first error of judgment, allowed him to succeed his brother, John Marshal, in the hereditary marshalship, and on his death-bed designated him as custodian of Rouen and of the royal treasure during the interregnum. Though he quarrelled more than once with John, Marshal was one of the few English laymen who clung to the royal side through the Barons' War. He was one of John's executors, and was subsequently elected regent of the king and kingdom by the royalist barons in 1216. In spite of his advanced age he prosecuted the war against Prince Louis and the rebels with remarkable energy. In the battle of Lincoln (May 1217) he charged and fought at the head of the young king's army, and he was preparing to besiege Louis in London when the war was terminated by the naval victory of Hubert de Burgh in the straits of Dover. He was criticized for the generosity of the terms he accorded to Louis and the rebels (September 1217); but his desire for an expeditious settlement was dictated by sound statesmanship. Self-restraint and compromise were the key-notes of Marshal's policy. Both before and after the peace of 1217 he reissued Magna Carta. He fell ill early in the year 1219, and died on the 14th of May at his manor of Caversham near Reading. He was succeeded in the regency by Hubert de Burgh, in his earldom by his five sons in succession.

See the metrical French life, *Histoire de Guillaume le Maréchal* (ed. P. Meyer, 3 vols., Paris, 1891-1901); the *Minority of Henry III.*, by G. J. Turner (*Trans. Royal Hist. Soc.*, new series, vol. xviii, pp. 245-295); and W. Stubbs, *Constitutional History*, chs. xii. and xiv. (Oxford, 1896-1897).

Marshal's eldest son, WILLIAM MARSHAL (d. 1231), 2nd earl of Pembroke of this line, passed some years in warfare in Wales and in Ireland, where he was justiciar from 1224 to 1226; he also served Henry III. in France. His second wife was the king's sister, Eleanor, afterwards the wife of Simon de Montfort, but he left no children. His brother RICHARD MARSHAL (d. 1234), 3rd earl, came to the front as the leader of the baronial party, and the chief antagonist of the foreign friends of Henry III. Fearing treachery he refused to visit the king at Gloucester in August 1233, and Henry declared him a traitor. He crossed to Ireland, where Peter des Roches had instigated his enemies to attack him, and in April 1234 he was overpowered and wounded, and died a prisoner. His brother GILBERT (d. 1241), who became the 4th earl, was a friend and ally of Richard, earl of Cornwall. When another brother, Anselm, the 6th earl, died in December 1245, the male descendants of the great earl marshal became extinct. The extensive family possessions were now divided among Anselm's five sisters and their descendants, the earldom of Pembroke reverting to the Crown.

The next holder of the lands of the earldom of Pembroke was William de Valence (d. 1296), a younger son of Hugh de Lusignan, count of La Marche, by his marriage with Isabella of Angoulême (d. 1246), widow of the English king John, and was born at Valence, near Lusignan. In 1247 William and his brothers, Guy and Aymer, crossed over to England at the invitation of their half-brother, Henry III. In 1250 Aymer (d. 1260) was elected bishop of Winchester, and in 1247 Henry arranged a marriage between William and Joan de Munchensi (d. 1307) a granddaughter of William Marshal, 1st earl of Pembroke. The custody of Joan's property, which included the castle and lordship of Pembroke, was entrusted to her husband, who in 1295 was summoned to parliament as earl of Pembroke. In South Wales

Valence tried to regain the palatine rights which had been attached to the earldom of Pembroke. But his energies were not confined to South Wales. Henry III. heaped lands and honours upon him, and he was soon thoroughly hated as one of the most prominent of the rapacious foreigners. Moreover, some trouble in Wales led to a quarrel between him and Simon de Montfort, and this soon grew more violent. He would not comply with the provisions of Oxford, and took refuge in Wolvesey Castle at Winchester, where he was besieged and compelled to surrender and leave the country. In 1259 he and Earl Simon were formally reconciled in Paris, and in 1261 he was again in England and once more enjoying the royal favour. He fought for Henry at the battle of Lewes, and then, after a stay in France, he landed in Pembrokeshire, and took part in 1265 in the siege of Gloucester and the battle of Evesham. After the royalist victory he was restored to his estates and accompanied Prince Edward, afterwards Edward I., to Palestine. He went several times to France on public business; he assisted in the conquest of North Wales; and he was one of Edward's representatives in the famous suit over the succession to the crown of Scotland in 1291 and 1292. He died at Bayonne on the 13th of June 1296, his body being buried in Westminster Abbey. His eldest surviving son, AYMER (c. 1265-1324), succeeded to his father's estates, but was not formally recognized as earl of Pembroke until after the death of his mother Joan about 1307. He was appointed guardian of Scotland in 1306, but with the accession of Edward II. to the throne and the consequent rise of Piers Gaveston to power, his influence sensibly declined; he became prominent among the discontented nobles and was one of those who were appointed to select the lord orderiers in 1311. In 1312 he captured Gaveston at Scarborough, giving the favourite a promise that his life should be spared. Ignoring this undertaking, however, Guy Beauchamp, earl of Warwick, put Gaveston to death, and consequently Pembroke left the allied lords and attached himself to Edward II. Valence was present at Bannockburn; in 1317, when returning to England from Rome, he was taken prisoner and was kept in Germany until a large ransom was paid. In 1318 he again took a conspicuous part in making peace between Edward and his nobles, and in 1322 assisted at the formal condemnation of Earl Thomas of Lancaster, and received some of his lands. His wife, Mary de Chatillon, a descendant of King Henry III., was the founder of Pembroke College, Cambridge.

In 1339 LAURENCE, LORD HASTINGS (d. 1348), a great-grandson of William de Valence, having inherited through the female line a portion of the estates of the Valence earls of Pembroke was created, or recognized as, earl of Pembroke. His son John (d. 1376) married Margaret Plantagenet, daughter of King Edward III., and on the death without issue of his grandson in 1389 the earldom of Pembroke reverted again to the Crown, while the barony of Hastings became dormant and so remained till 1840.

In 1414 Humphrey Plantagenet, fourth son of King Henry IV., was created duke of Gloucester and earl of Pembroke for life, these titles being subsequently made hereditary, with a reversion as regards the earldom of Pembroke, in default of heirs to Humphrey, to William de la Pole, earl of Suffolk. Accordingly, on the death of Humphrey, without issue, in 1447 this nobleman became earl of Pembroke. He was beheaded in 1450 and his titles were forfeited. In 1453 the title was given to Sir Jasper Tudor, half-brother of King Henry VI. Sir Jasper being a Lancastrian, his title was forfeited during the predominance of the house of York, but was restored on the accession of Henry VII. On his death without heirs in 1495, his title became extinct.

During his attainder Sir Jasper was taken prisoner by SIR WILLIAM HERBERT (d. 1460), a zealous Yorkist, who had been raised to the peerage as Baron Herbert by Edward IV., and for this service Lord Herbert was created earl of Pembroke in 1468. His son William (d. 1491) received the earldom of Huntingdon in lieu of that of Pembroke, which he surrendered to Edward IV., who thereupon conferred it (1470) on his son Edward, prince

of Wales; and when this prince succeeded to the throne as Edward V., the earldom of Pembroke merged in the crown. ANNE BOLEYN, a few months previous to her marriage with Henry VIII., was created marchioness of Pembroke in 1532. It is doubted by authorities on peerage law whether the title merged in the royal dignity on the marriage of the marchioness to the king, or became extinct on her death in 1536.

The title of earl of Pembroke was next revived in favour of SIR WILLIAM HERBERT (c. 1501-1570), whose father, Richard, was an illegitimate son of the 1st earl of Pembroke of the house of Herbert. He had married Anne Parr, sister of Henry VIII.'s sixth wife, and was created earl in 1551. The title has since been held by his descendants.

An executor of Henry VIII.'s will and the recipient of valuable grants of land, Herbert was a prominent and powerful personage during the reign of Edward VI., both the protector Somerset and his rival, John Dudley, afterwards duke of Northumberland, angling for his support. He threw in his lot with Dudley, and after Somerset's fall obtained some of his lands in Wiltshire and a peerage. It has been asserted that he devised the scheme for settling the English crown on Lady Jane Grey; at all events, he was one of her advisers during her short reign, but he declared for Mary when he saw that Lady Jane's cause was lost. By Mary and her friends Pembroke's loyalty was at times suspected, but he was employed as governor of Calais, as president of Wales and in other ways. He was also to some extent in the confidence of Philip II. of Spain. The earl retained his place at court under Elizabeth until 1560, when he was suspected of favouring the projected marriage between Mary, queen of Scots, and the duke of Norfolk. Among the monastic lands granted to Herbert was the estate of Wilton, near Salisbury, still the residence of the earls of Pembroke.

His elder son Henry (c. 1534-1601), who succeeded as 2nd earl, was president of Wales from 1586 until his death. He married in 1577 Mary Sidney, the famous countess of Pembroke (c. 1561-1621), third daughter of Sir Henry Sidney and his wife Mary Dudley. Sir Philip Sidney to whom she was deeply attached through life, was her eldest brother. Sir Philip Sidney spent the summer of 1580 with her at Wilton, or at Ivychurch, a favourite retreat of hers in the neighbourhood. Here at her request he began the *Countess of Pembroke's Arcadia*, which was intended for her pleasure alone, not for publication. The two also worked at a metrical edition of the Psalms. When the great sorrow of her brother's death came upon her she made herself his literary executor, correcting the unauthorized editions of the *Arcadia* and of his poems, which appeared in 1590 and 1591. She also took under her patronage the poets who had looked to her brother for protection. Spenser dedicated his *Ruines of Time* to her, and refers to her as Urania in *Colin Clouts come home againe*; in Spenser's *Astropeid* she is "Clorinda." In 1590 Queen Elizabeth was her guest at Wilton, and the countess composed for the occasion a pastoral dialogue in praise of Astraea. After her husband's death she lived chiefly in London at Crosby Hall, where she died.

The Countess's other works include: *A Discourse of Life and Death*, translated from the French of Plesais du Mornay (1593), and *Antoine* (1592), a version of a tragedy of Robert Garnier.

WILLIAM HERBERT, 3rd earl of Pembroke (1580-1630), son of the 2nd earl and his famous countess, was a conspicuous figure in the society of his time and at the court of James I. Several times he found himself opposed to the schemes of the duke of Buckingham, and he was keenly interested in the colonization of America. He was lord chamberlain of the royal household from 1625 to 1625 and lord steward from 1626 to 1630. He was chancellor of the university of Oxford in 1624 when Thomas Tesdale and Richard Wightwick refounded Broadgates Hall and named it Pembroke College in his honour. By some Shakespearean commentators Pembroke has been identified with the "Mr W. H." referred to as "the onlie begetter" of Shakespeare's sonnets in the dedication by Thomas Thorpe, the owner of the published manuscript, while his mistress, Mary Fitton (q.v.), has been identified with the "dark lady" of the sonnets. In both

cases the identification rests on very questionable evidence (see *SHAKESPEARE, WILLIAM*). He and his brother Philip are the "incomparable pair of brethren" to whom the first folio of Shakespeare is inscribed. The earl left no sons when he died in London on the 10th of April 1630. Clarendon gives a very eulogistic account of Pembroke, who appears, however, to have been a man of weak character and dissolute life. Gardiner describes him as the Hamlet of the English court. He had literary tastes and wrote poems; one of his closest friends was the poet Donne, and he was generous to Ben Jonson, Massinger and others.

His brother, PHILIP HERBERT, the 4th earl (1584-1650), was for some years the chief favourite of James I., owing this position to his comely person and his passion for hunting and for field sports generally. In 1605 the king created him earl of Montgomery and Baron Herbert of Shurland, and since 1630, when he succeeded to the earldom of Pembroke, the head of the Herbert family has carried the double title of earl of Pembroke and Montgomery. Although Philip's quarrelsome disposition often led him into trouble he did not forfeit the esteem of James I., who heaped lands and offices upon him, and he was also trusted by Charles I., who made him lord chamberlain in 1626 and frequently visited him at Wilton. He worked to bring about peace between the king and the Scots in 1630 and 1640, but when in the latter year the quarrel between Charles and the English parliament was renewed, he deserted the king who soon deprived him of his office of chamberlain. Trusted by the popular party, Pembroke was made governor of the Isle of Wight, and he was one of the representatives of the parliament on several occasions, notably during the negotiations at Uxbridge in 1645 and at Newport in 1648, and when the Scots surrendered Charles in 1647. From 1641 to 1643, and again from 1647 to 1650, he was chancellor of the university of Oxford; in 1648 he removed some of the heads of houses from their positions because they would not take the solemn league and covenant, and his foul language led to the remark that he was more fitted "by his eloquence in swearing to preside over Bedlam than a learned academy." In 1640, although a peer, he was elected and took his seat in the House of Commons as member for Berkshire, this "ascend downwards" calling forth many satirical writings from the royalist wits. The earl was a great collector of pictures and had some taste for architecture. His eldest surviving son, Philip (1622-1669), became 5th earl of Pembroke, and 2nd earl of Montgomery; he was twice married, and was succeeded in turn by three of his sons, of whom Thomas, the 8th earl (c. 1656-1733), was a person of note during the reigns of William III. and Anne. From 1690 to 1692 he was first lord of the admiralty; then he served as lord privy seal until 1699, being in 1697 the first plenipotentiary of Great Britain at the congress of Ryswick. On two occasions he was lord high admiral for a short period; he was also lord president of the council and lord-lieutenant of Ireland, while he acted as one of the lords justices seven times; and he was president of the Royal Society in 1689-1690. His son Henry, the 9th earl (c. 1689-1750), was a soldier, but was better known as the "architect earl." He was largely responsible for the erection of Westminster Bridge. The title descended directly to Henry, 10th earl (1734-1794), a soldier, who wrote the *Method of Breaking Horses* (1762); George Augustus, 11th earl (1759-1827), an ambassador extraordinary to Vienna in 1807; and Robert Henry, 12th earl (1792-1862), who died without issue. George Robert Charles, the 13th earl (1850-1895), was a grandson of the 11th earl and a son of Baron Herbert of Lea (q.v.), whose second son Sidney (b. 1853) inherited all the family titles at his brother's death.

See G. T. Clark, *The Earls, Earldom and Castle of Pembroke* (Tenby, 1880); J. R. Planché, "The Earls of Strigul" in vol. x. of the *Proceedings of the British Archaeological Association* (1855); and G. E. Cokayne, *Complete Peerage*, vol. vi. (London, 1895).

PEMBROKE, a town of Ontario, Canada, capital of Renfrew county, 74 m. W.N.W., of Ottawa by rail on the south shore of Allumette Lake, an expansion of the Ottawa river, and on the Canadian Pacific and Canada Atlantic railways. Pop. (1901), 5156. It is the seat of a Roman Catholic bishopric, an

important centre in the lumber trade, and contains saw, grist and woollen mills, ax factory, &c. The Muskrat river affords excellent water-power.

PEMBROKE (*Penfro*), an ancient municipal borough, a contributory parliamentary borough and county-town of Pembrokeshire, Wales, situated on a narrow peninsula at the head of the Pennar tidal inlet or "pill" of Milford Haven. Pop. (1901), 4487; together with Pembroke Dock 15,853. Pembroke is a station on the South Wales system of the Great Western railway. The old-fashioned town, consisting chiefly of one long broad street, retains portions of its ancient walls. A large mill-dam is a conspicuous feature on the north of the town. St Mary's church in the centre of the town possesses a massive tower of the 12th century. Near the ruined West Gate is the entrance to Pembroke Castle, a splendid specimen of mediæval fortified architecture. The circular vaulted keep erected by Earl William Marshal (c. 1200), remains almost intact. Close to the keep stands the ruined chamber wherein, according to local tradition, Henry VII. was born in 1457. Beneath the fine banqueting hall, a flight of steps descends into "the Wogan," a vast subterranean chamber giving access to the harbour. Facing the castle, on the western side of the pill, stand the considerable remains of Monkton Priory, a Benedictine house founded by Earl William Marshal as a cell to the abbey of Séz or Sayes in Normandy, but under Henry VI. transferred to the abbey of St Albans. The priory church, now the parish church of the suburb of Monkton, contains monuments of the families of Meyrick of Bush and Owen of Orielton. St Daniel's chapel forms a prominent landmark on the ridge south of the town.

PEMBROKE DOCK (formerly known as Pater, or Paterchurch), a naval dockyard and garrison town, is situated close to Hobb's Point, at the eastern extremity of Milford Haven. It forms the Pater Ward of Pembroke, from which it is distant 2 m. to the north-west. The place owes its origin to the decision of the government in 1814 to form a naval dépôt on Milford Haven. The dockyard, enclosed by high walls and covering 80 acres, is protected by a powerful fort—the construction and repairing of ironclads are extensively carried on here. There is a submarine dépôt at Pennar Gut, and also accommodation for artillery and infantry. Ferry boats ply frequently between Pembroke Dock and Neyland on the opposite shore of the Haven.

Pembroke is probably an Anglo-Norman town of the Cymric *Penfro*, the territory lying between Milford Haven and the Bristol Channel, now known as the Hundred of Castlemartin. During the invasion of South Wales under William Rufus, Arnulf de Montgomeri, fifth son of Roger earl of Shrewsbury, seems to have erected a fortress of stone (c. 1090) on the site of the castle. The first castellan of this new stronghold was Giraldus de Windsor, husband of the Princess Nest of South Wales and grandfather of Giraldus Cambrensis. Throughout the 12th and 13th centuries the castle was strengthened and enlarged under successive earls palatine of Pembroke, who made this fortress their chief seat. As the capital of the palatinate and as the nearest port for Ireland, Pembroke was in Plantagenet times one of the most important fortified cities in the kingdom. The town, which had grown up under the shadow of the almost impregnable castle, was first incorporated by Henry I. in 1109 and again by Earl Richard de Clare in 1154 (who also encircled the town with walls), and these privileges were confirmed and extended under succeeding earls palatine and kings of England. In 1835 the corporation was remodelled under the Municipal Corporations Act. Henry II. occasionally visited Pembroke, notably in 1173, and until the close of the Wars of the Roses, both town and castle played a prominent part in the history of Britain. With the passing of the Act of Union of Wales and England in 1536 however, the *jura regalia* of the county palatine of Pembroke were abolished, and the prosperity of the town began to decline. Although acknowledged as the county town of Pembrokeshire, Pembroke was superseded by Haverfordwest as the judicial and administrative centre of the shire on account of the more convenient position of the latter place. By the act of 1536 Pembroke was declared the leading borough in the

Pembroke parliamentary district, yet the town continued to dwindle until the settlement of the government dockyard and works on Milford Haven. At the outbreak of the Civil Wars the town and castle were garrisoned for parliament by the mayor, John Poyer, a leading Presbyterian, who was later appointed governor, with Rowland Laugharne of St Brides for his lieutenant. But at the time of the Presbyterian defection in 1647, Poyer and his lieutenant-governors, Laugharne and Powell, declared for Charles and held the castle in the king's name. In June 1648 Cromwell himself proceeded to invest Pembroke Castle, which resisted with great obstinacy. But after the water-supply of the garrison had been cut off, the besieged were forced to capitulate, on the 11th of July 1648, on the condition of surrendering up the three chief defenders of the castle. Poyer, Laugharne and Powell were accordingly brought to London, but finally only Poyer was executed. The magnificent ruin of Pembroke Castle is the nominal property of the Crown, but has been held on lease since the reign of James II. by the family of Pryse of Gogerddan in Cardiganshire.

PEMBROKESHIRE (*Str Benfro, Dyfed*), the most westerly county of South Wales, bounded N.E. by Cardigan, E. by Carmarthen, S. by the Bristol Channel and W. and N.W. by St Bride's Bay and Cardigan Bay of St George's Channel. Area 615 sq. m. The whole coast is extremely indented, extending over 140 m. in length. The principal inlets are Milford Haven, St Bride's Bay, Freshwater Bay, Fishguard Bay and Newport Bay. The chief promontories are Cemmaes, Dinas, Strumble, St David's, St Ann's and St Gowan's Heads. Five islands of moderate size lie off the coast, viz. Ramsey, Grassholm, Skomer and Skokholm in St Bride's Bay, and Caldy Island (*Ynys Pyr*) opposite Tenby; the last named having a population of about 70 persons. Rare birds, such as peregrine falcons, ravens and choughs are not uncommon, while guillemots, puffins and other sea-fowl breed in immense numbers on the Stack Rocks, on Ramsey Island and at various points of the coast. Seals are plentiful in the caves of St Bride's Bay and Cardigan Bay. The county is undulating, and large tracts are bare, but the valleys of the Cleddau, the Nevern, the Teifi and the Gwaun are well-wooded. The Preselley Mountains stretch from Fishguard to the border of Carmarthen, the principal heights being Preselley Top (1760 ft.) and Carn Englyn (1022 ft.). Trefignn Rock in the Plumstone Mountains is popularly supposed to mark the northern limit of the ancient settlement of the Flemings. The principal rivers are the Teifi, forming the northern boundary of the county from Abercych to Cardigan Bay; the Nevern and the Gwaun, both falling into Cardigan Bay; and the Eastern and Western Cleddau, forming the Daugleddau after their junction below Haverfordwest. All these streams contain trout and salmon. There are no lakes, but the broad tidal estuaries of the Daugleddau and other rivers, which fall into Milford Haven and are locally called "pills," constitute a peculiar feature of south Pembrokeshire scenery.

Geology.—Pembrokeshire is divisible into a northern portion occupied mainly by Ordovician and Silurian strata, which have been subjected to pressures from the north, the strike of the beds being south-west-north-east; and a southern portion, the westerly continuation of the South Wales coalfield, with associated Lower Carboniferous, Old Red Sandstone and narrow belts of Silurian rocks, the whole having been considerably folded and faulted by pressure from the south, which has produced a general north-west-south-east strike. In the neighbourhood of St Davids are the Pre-Cambrian granitic rocks (Dimetian) and volcanic rocks (Pebedian). These are surrounded by belts of unconformable Cambrian strata (*Lingula* Flags, Tremadoc beds), followed by Ordovician (*Arenig*, *Llandeilo* and *Bala* beds) with associated igneous rocks. These comprise gabbros and diabases of Strumble Head, Fishguard, Llanwnda, Preselley; diorites north-west of St Davids, bostonites and porphyrites about Abercastle and the basaltic laccolite of Pen Caer, besides various contemporaneous acid lavas and tuffs. The Ordovician and Silurian rocks extend southward to the neighbourhood of Narberth and Haverfordwest, where *Arenig*, *Llandeilo* and *Bala* beds (Slade and Red Hill beds; Sholeshook and Robeston Wathen Limestone) and *Llandoverly* beds are recorded. The Coal Measures, highly inclined and anthracitic, stretch across from Carmarthen Bay to the shore of St Bride's Bay; they are bordered on the north and south-east by the Millstone Grits, Carboniferous Limestone series and Old Red Sandstone. On account of the folding

the limestone appears again farther south at Pembroke, Caldy Island and St Gowan's Head; most of the remaining ground about Milford Haven being occupied by Old Red Sandstone with infolded strips of Silurian. A fairly large tract of blown-sand occurs in Freshwater Bay south of Milford Haven. Silver-bearing lead has been mined at Llanfyrnach.

Climate and Industries.—The climate is everywhere mild, and in the sheltered valleys near the coast sub-tropical vegetation flourishes in the open air. In the south the rainfall is small, and the districts round Pembroke suffer from occasional droughts. The chief industry is agriculture, wherein stock-raising is preferred to the growing of cereals. Of cattle the long-horned, jet-black Castlemartin breed is everywhere conspicuous. South Pembroke has long been celebrated for its horses, which are bred in great numbers by the farmers. The deep-sea fisheries of Tenby and Milford are valuable; and fresh fish of good quality is exported by rail to the large towns. Oysters are found at Langwm and near Tenby; lobsters and crabs abound on the western coast. The South Wales coalfield extends into south Pembroke, and coal is worked at Saundersfoot, Begelly, Templeton, Kilgetty and other places. There are slate quarries at Glogue, Cilgerran and elsewhere; copper has been worked near St Davids, and lead at Llanfyrnach.

Communications.—The South Wales branch of the Great Western railway enters Pembrokeshire from the east near Clynderwen Junction, whence the main line leads to Fishguard Harbour with its important Irish traffic. Other lines proceed to Neyland and Milford Haven by way of Haverfordwest, and a branch line from Clynderwen to Goodwick joins the main line at Letterston. The Whitland-Cardigan branch traverses the north-east by way of Crymmych and Cilgerran. Another line running south-west from Whitland proceeds by way of Narberth and Tenby to Pembroke Dock.

Population and Administration.—The area of Pembrokeshire is 395,151 acres with a population in 1891 of 89,138 and 1901 of 88,732, showing a slight decrease. The municipal boroughs are Pembroke (pop. 15,853); Haverfordwest (6007); and Tenby (4400). The hamlet of Bridgend and a part of St Dogmell's parish are included within the municipal limits of Cardigan. Newport (*Trêdraeth*) (1222), the chief town of the barony of Kemes, or Cemmaes, still possesses a mayor and corporation under a charter granted in 1215 by Sir Nicholas Marteine, lord of Kemes, whose hereditary representative still nominates the mayor and aldermen, but its surviving municipal privileges are practically honorary. Milford Haven (5102), Narberth (1070) and Fishguard (3002) are urban districts. Other towns are St Davids (1710), St Dogmells (*Llandudoch*) (1286); and Cilgerran (1038). Pembrokeshire lies in the South Wales circuit, and assizes are held at Haverfordwest. Two members are returned to parliament; one for the county, and one for the united boroughs of Pembroke, Haverfordwest, Tenby, Fishguard, Narberth, Neyland, Milford and Wiston (*Castell Gwys*). Ecclesiastically, the county contains 153 parishes and lies wholly in the diocese of St Davids.

History.—Pembrokeshire, anciently known to the Welsh as *Dyfed*, was originally comprised in the territory of the *Dimetae*, conquered by the Romans. During the 6th century St David, or Dewi Sant, moved the chief seat of South Welsh monastic and ecclesiastical life from *Carleon-on-Usk* to his native place *Menevia*, which, known in consequence as *Tyddewi*, or St Davids, continued a centre of religious and educational activity until the Reformation, a period of 1000 years. On the death of Rhodri Mawr in 877, *Dyfed* fell nominally under the sway of the princes of Deheubarth, or South Wales; but their hold was never very secure, nor were they able to protect the coast towns from the Scandinavian pirates. In 1081 William the Conqueror penetrated west as far as St Davids, where he is said to have visited St David's shrine as a devout pilgrim. In 1092 Arnulf de Montgomery, son of Roger, earl of Shrewsbury, did homage to the king for the Welsh lands of *Dyfed*. With the building of Pembroke Castle, of which Gerald de Windsor was appointed castellan, the Normans began to spread over southern *Dyfed*; whilst Martin de Tours, landing in Fishguard

Bay and building the castle of Newport at Trêdwrth, won for himself the extensive lordship of Kemes (Cemmaes) between the river Teifi and the Preselley Mountains. The systematic planting of Flemish settlers in the hundred of Rhôs, or Roose, in or about the years 1106, 1108 and 1111 with the approval of Henry I., and again in 1156 under Henry II., marks an all-important episode in the history of Pembrokeshire. The castles of Haverfordwest and Tenby were now erected to protect these aliens, and despite the fierce attacks of the Welsh princes their domain grew to be known as "Little England beyond Wales," a district whereof the language, customs and people still remain characteristic. In 1138 Gilbert de Clare, having previously obtained Henry I.'s permission to enjoy all lands he might win for himself in Wales, was created earl of Pembroke in Stephen's reign with the full powers of an earl palatine in Dyfed. The devolution of this earldom is dealt with in a separate article.

In 1536, by the Act of Union (27 Henry VIII.), the king abolished all special jurisdiction in Pembrokeshire, which he placed on an equal footing with the remaining shires of Wales, while its borders were enlarged by the addition of Kemes, Dewisland and other outlying lordships. By the act of 1536 the county returned to parliament one knight for the shire and two burgesses; one for the Pembroke boroughs and one for the town and county of Haverfordwest, both of which since 1885 have been merged in the Pembroke-and-Haverfordwest parliamentary division. The Reformation deprived the county of the presence of the bishops of St David's, who on the partial dismantling of the old episcopal palace at St David's removed their chief seat of residence to Abergwily, near Carmarthen. Meanwhile the manor of Lamphey was granted to the family of Devereux, earls of Essex, and other episcopal estates were alienated to court favourites, notably to Sir John Perrot of Haroldstone (1517-1592), afterwards lord-deputy of Ireland. During the Civil Wars the forces of the parliament, commanded by Colonel Laugharne and Captain Swanley, reduced the royal forts at Tenby, Milford and Haverfordwest. In February 1797 some French frigates appeared off Fishguard Bay and landed about 1400 Frenchmen at Llanwnda. The invaders soon capitulated to the local militia, practically without striking a blow. The 19th century saw the establishment of the naval dockyard at Paterchurch and the building of docks and quays at Neyland and Milford. In 1906 extensive works for cross-traffic with Ireland were opened at Fishguard Harbour.

Many of the old Pembrokeshire families, whose names appear prominent in the county annals, are extinct in the county itself. Amongst these may be mentioned Perrot of Haroldstone, Devereux of Lamphey, Barlow of Slebech, Barrett of Gilliswick, Wogan of Wiston, Elliot of Amroth and Owen of Henllys. Amongst ancient families still existing are Philipps of Lydstep and Amroth (descendants of the old Welsh lords of Cilsant); Philipps of Picton Castle (a branch of the same house in the female line); Lort of Stackpole Court, now represented by Earl Cawdor; Scourfield of Moate; Bowen of Llwyngwair; Edwardes, Lords Kensington, of St Brides; Meyrick of Bush; Lort-Philipps of Lawrenny; Colby of Flynone; Stokes of Cuffern; Lloyd of Newport Castle (in which family is vested the hereditary lordship of the barony of Kemes); Saunders-Davies of Pentre; and Gower of Castle Malgwyn.

Antiquities.—There are few remaining traces in the county of the Roman occupation of Dimetia, but in British encampments, tumuli, cromlechs and monumental stones Pembrokeshire is singularly rich. Of the cromlechs the best preserved are those at Longhouse, near Mathry; at Pentre Evan in the Nevern Valley; and at Llech-y-dribedd, near Moylgrove; whilst of the many stone circles and alignments, that known as Pare-y-Marw, or "The Field of the Dead," near Fishguard, is the least injured. Stones inscribed in Ogam characters are not uncommon, and good examples exist at Caldly Island, Bridell, St Dogmells and Cilgerran. There are good specimens of Celtic fioriated churchyard crosses at Carew, Penally and Nevern. Interesting examples of medieval domestic architecture are the ruins

of the former episcopal mansions at Llanbaden, St David's and Lamphey, the two latter of which were erected by Bishop Gower between the years 1328-1347. With the exception of the cathedral at St David's and the principal churches of Haverfordwest and Tenby, the parish churches of Pembrokeshire are for the most part small, but many are ancient and possess fine monuments or other objects of interest, especially in "Little England beyond Wales." Amongst the more noteworthy are the churches at Stackpole Eilidur, Carew, Burton, Gurfreston, Nevern, St Petrox and Rudbaxton, the last-named containing a fine Jacobean monument of the Hayward family. Pembrokeshire has long been famous for its castles, of which the finest examples are to be observed at Pembroke; Manorbier, built in the 12th century and interesting as the birthplace and home of Giraldus Cambrensis; Carew, exhibiting many interesting features both of Norman and Tudor architecture; and Pictou, owned and inhabited by a branch of the Philipps family. Other castles are the keep of Haverfordwest and the ruined fortresses at Narberth, Tenby, Newport, Wiston, Benton, Upton and Cilgerran. There are some remains of monastic houses at Tenby and Pembroke, but the most important religious communities were the priory of the Augustinian friars at Haverfordwest and the abbey of the Benedictines at St Dogmells. Of this latter house, which was founded by Martin de Tours, first lord of Kemes, at the close of the 11th century, and who owned the priories of Pill and Caldly, considerable ruins exist near the left bank of the Teifi about 1 m. below Cardigan. Of the ancient preceptory of the Knights of St John at Slebech scarcely a trace remains, but of the college of St Mary at St David's founded by Bishop Houghton in 1377, the shell of the chapel survives in fair preservation. Pembrokeshire contains an unusually large number of county seats, particularly in the south, which includes Stackpole Court, the residence of Earl Cawdor, a fine mansion erected in the 18th century; Pictou Castle; Slebech, once the seat of the Barlows; Orierton, formerly belonging to the Owens; and Flynone, the residence of the Colby family.

Customs, &c.—The division of Pembrokeshire ever since the 12th century into well-defined Englishry and Welshry has produced two distinct sets of languages and customs within the county. Roughly speaking, the English division, the *Anglia Transwalliana* of Camden, occupies the south-eastern half and comprises the hundreds of Roose, Castlemartin, Narberth and Dungleddy. In the Welshry, which includes the hundreds of Dewisland and Cilgerran together with the old barony of Kemes, the language, customs, manners and folk-lore of the inhabitants are almost identical with those of Cardigan and Carmarthen. The old Celtic game of *Knappan*, a pastime partaking of the nature both of football and hockey, in which whole parishes and even hundreds were wont to take an active part, was prevalent in the barony of Kemes so late as the 16th century, as George Owen of Henllys, the historian and antiquary, records; and the playing of *knappan* lingered on after Owen's day. Amongst the settlers of the Englishry, who are of mingled Anglo-Saxon, Flemish, Welsh and perhaps Scandinavian descent, many interesting superstitions and customs survive. The English spoken by these dwellers in "Little England beyond Wales" contains many curious idioms and words and the pronunciation of some of the vowels is peculiar. Certain picturesque customs, many of them dating from pre-Reformation times, are still observed, notably in the neighbourhood of Tenby. Such are the sprinkling of persons with dewy evergreens on New Year's morning; the procession of the Cutty Green on St Stephen's day, and the constructing of little huts at Lammastide by the farm boys and girls. As early as the opening years of the 19th century, cripples and ophthalmic patients were in the habit of visiting the ancient hermitage at St Gowan's Head to bathe in its sacred well; and Richard Fenton, the county historian alludes (c. 1808) to the many crutches left at St Gowan's chapel by grateful devotees. Belief in ghosts, fairies, witches, &c., is still prevalent in the more remote places, and the dress of the fishwives of Langwn near Haverfordwest is highly picturesque with its short skirt, scarlet shawl and buckled shoes.

AUTHORITIES.—Richard Fenton, *A Historical Tour through Pembrokeshire* (London, 1816); Edward Lawa, *History of Little England beyond Wales* (London, 1888); Basil Jones and E. A. Freeman, *History and Antiquities of St David's* (London, 1856), &c.

PEMMICAN, a North American Indian (Cree) word for a meat prepared in such a way as to contain the greatest amount of nourishment in the most compact form. As made by the Indians it was composed of the lean parts of the meat, dried in the sun, and pounded or shredded and mixed into a paste with melted fat. It is flavoured with acid berries. If kept dry it will keep for an indefinite time, and is thus particularly serviceable in arctic or other explorations.

PEMPHIGUS (Gr. *πέμφιξ*, a bubble), a skin disease, in which large blebs appear, on a red base, containing a clear or yellowish fluid; the blebs occasion much irritation, and when they burst leave raw ulcerated surfaces. The disease is principally known in unhealthy or neglected children. A variety of the malady, *pemphigus foliaceus*, affects the whole body, and gradually proves fatal. Pemphigus of an acute septicæmic type occurs in butchers or those who handle hides, and a diplococcus has been isolated by William Bullock. The treatment is mainly constitutional, by means of good nourishment, warm baths, local sedatives and tonics. In chronic pemphigus, streptococci have been found in the blebs, and the opsonic index was low to streptococci. Improvement has been known to take place on the injection of a vaccine of streptococci.

PEN (Lat. *penna*, a feather, pen), an instrument for writing or for forming lines with an ink or other coloured fluid. The English word, as well as its equivalents in French (*plume*) and in German (*Feder*), originally means a wing-feather, but in ancient times the implements used for producing written characters were not quills. The earliest writing implement was probably the stilus (Gr. *γραφίς*), a pointed bodkin of metal, bone or ivory, used for producing incised or engraved letters on boxwood tablets covered with wax. The calamus (Gr. *κάλamos*) or arundo, the hollow tubular stalk of grasses growing in marshy lands, was the true ancient representative of the modern pen; hollow joints of bamboo were similarly employed.

An early specific allusion to the quill pen occurs in the writings of St Isidore of Seville (early part of the 7th century),¹ but there is no reason to assume that it was not in use at a still more remote date. The quills still largely employed among Western communities as writing instruments are obtained principally from the wings of the goose (see FEATHER). In 1809 Joseph Bramah devised and patented a machine for cutting up the quill into separate nibs by dividing the barrel into three or even four parts, and cutting these transversely into "two, three, four and some into five lengths." Bramah's invention first familiarized the public with the appearance and use of the nib slipped into a holder. In 1818 Charles Watt obtained a patent for gilding and preparing quills and pens, which may be regarded as the precursor of the gold pen. But a more distinct advance was effected in 1822, when J. I. Hawkins and S. Mordant patented the application of horn and tortoise-shell to the formation of pen-nibs, the points of which were rendered durable by small pieces of diamond, ruby or other very hard substance, or by lapping a small piece of thin sheet gold over the end of the tortoise-shell.

Metallic pens, though not unknown in classical times—a bronze pen found at Pompeii is in the Naples Museum—were little used until the 19th century and did not become common till near the middle of that century. It is recorded that a Birmingham split-riv manufacturer, Samuel Harrison, made a steel pen for Dr Joseph Priestley in 1780. Steel pens made and sold in London by a certain Wise in 1803 were in the form of a tube or barrel, the edges of which met to form the slit, while the sides were cut away as in the case of an ordinary quill. Their price was about five shillings each, and as they were hard, stiff and unsatisfactory instruments they were not in great demand. A metallic pen patented by

¹ *Instrumenta scribæ calamus et penna; ex his enim verba paginis inscribuntur; sed calamus arboris est, penna avis, cujus acumen dividitur in duo.*

Bryan Donkin in 1808 was made of two separate parts, flat or nearly so, with the flat sides placed opposite each other to form the slit, or alternatively of one piece, flat and not cylindrical as in the usual form, bent to the proper angle for insertion in the tube which constituted the holder. To John Mitchell probably belongs the credit of introducing machine-made pens, about 1822, and James Perry is believed to have been the first maker of steel slip pens. In 1828 Josiah Mason, who had been associated with Samuel Harrison, in the manufacture of split rings, saw Perry's pens on sale in Birmingham, and after examining them saw his way both to improve and to cheapen the process of making them. He therefore put himself in communication with Perry, and the result was that he began to make barrel pens for him in 1828 and slip pens in 1829. Perry, who did much to popularize the steel pen and bring it into general use, in his patent of 1830 sought to obtain greater flexibility by forming a central hole between the points and the shoulders and by cutting one or more lateral slits on each side of the central slit; and Joseph Gillot, in 1831 described an improvement which consisted in forming elongated points on the nibs of the pens.

The metal used consists of rolled sheets of cast steel of the finest quality made from Swedish charcoal iron. These sheets, after being cut into strips of suitable width, annealed in a muffle-furnace and pickled in a bath of dilute sulphuric acid to free the surface from oxidized scale, are rolled between steel rollers till they are reduced to ribbons of an even thickness, about $\frac{1}{16}$ in. From these ribbons the pen blanks are next punched out, and then, after being embossed with the name of the maker or other marks, are pierced with the central perforation and the side or shoulder slits by which flexibility is obtained. After another annealing, the blanks, which up to this point are flat, are "raised" or rounded between dies into the familiar semi-cylindrical shape. The next process is to harden and temper them by heating them in iron boxes in a muffle-furnace, plunging them in oil, and then heating them over a fire in a rotating cylindrical vessel till their surfaces attain the dull blue tint characteristic of spring-steel elasticity. Subsequently they are "scoured" in a bath of dilute acid, and polished in a revolving cylinder. The grinding of the points with emery follows, and then the central slit is cut by the aid of two very fine-edged cutters. Finally the pens are again polished, are coloured by being heated over a fire in a revolving cylinder, and in some cases are coated with a varnish of shellac dissolved in alcohol. Birmingham was the first home of the steel-pen industry, and continues its principal centre. The manufacture on a large scale was begun in the United States about 1860 at Camden, N. J., where the Esterbrook Steel Pen Manufacturing Company was incorporated in 1866.

Metals other than steel have frequently been suggested by inventors, these most commonly proposed being gold, silver, zinc, German silver, aluminium and aluminium *Gold Pens*. bronze. Dr W. H. Wollaston, it is recorded, had a gold pen composed of two thin strips of gold tipped with rhodium, apparently made on the principle patented by Donkin in 1808, and Lord Byron used one in 1810. Gold being extremely resistant to corrosion, pens made of it are very durable, but the metal is too soft for the points, which wear quickly unless protected by some harder material. For this purpose iridium is widely employed, by fusing the gold round it with a blowpipe.

Various devices have been adopted in order to increase the time for which a pen can be used without a fresh supply of ink. These fall into two main classes. In one, the form of the nib itself is modified, or some attachment *Reservoir Pen.* is added, to enlarge the ink capacity; in the other, which is by far the more important, the holder of the pen is utilized as a cistern or reservoir from which ink is supplied to the nib. Pens of the second class, which have the further advantage of being portable, are heard of under the name of "fountain inkhorns" or "fountain pens" so far back as the beginning of the 18th century, but it was not till a hundred

years later that inventors applied themselves seriously to their construction. Joseph Bramah patented several plans; one was to employ a tube of silver or other metal so thin that it could be readily squeezed out of shape, the ink within it being thus forced out to the nib, and another was to fit the tube with a piston that could slide down the interior and thus eject ink. In modern fountain pens a feed bar conveys, by capillary action, a fresh supply of ink to replace that which has been left on the paper in the act of writing, means being also provided by which air can pass into the reservoir and fill the space left empty by the outflowing ink. In another form of reservoir pen, which is usually distinguished by the name stylograph, there is no nib, but the ink flows out through a minute hole at the end of the holder, which terminates in a conical point. An iridium needle, held in place by a fine spring, projects slightly through the hole and normally keeps the aperture closed; but when the pen is pressed on the paper, the needle is pushed back and allows a thin stream of ink to flow out.

See J. P. Maginnis, "Reservoir, Stylographic and Fountain Pens," *Cantor Lectures, Society of Arts* (1905).

PENALTY (Lat. *poena*, punishment), in its original meaning, a punishment inflicted for some violation of the law or rule of conduct. Although still freely used in its original sense in such phrases, for example, as "the death penalty," "the penalty of rashness," &c., the more usual meaning attached to the word is that of a pecuniary mulct. Penalty is used specifically for a sum of money recovered by virtue of a penal statute, or recoverable in a court of summary jurisdiction for infringement of a statute. A sum of money agreed upon to be paid in case of non-performance of a condition in a bond or in breach of a contract or any stipulation of it is also termed a penalty (see DAMAGES).

PENANCE (Old Fr. *penance*, fr. Lat. *poenitentia*, penitence), strictly, repentance of sins. Thus in the Douai version of the New Testament the Greek word *μετάνοια* is rendered "penance," where the Authorized Version has "repentance." The two words, similar in their derivation and original sense, have however come to be symbolical of conflicting views of the essence of repentance, arising out of the controversy as to the respective merits of "faith" and "good works." The Reformers, upholding the doctrine of justification by faith, held that repentance consisted in a change of the whole moral attitude of the mind and soul (*ἐπινοήσεως*, Matt. xiii. 15; Luke xxii. 32), and that the Divine forgiveness followed true repentance and confession to God without any reparation of "works." This is the view generally held by Protestants. In the Roman Catholic Church the sacrament of penance consists of three parts: *contritio*, *confessio*, *satisfactio*. *Contritio* is in fact repentance as Protestant theologians understand it, i.e. sorrow for sin arising from love of God, and long before the Reformation the schoolmen debated the question whether complete "contrition" was or was not in itself sufficient to obtain the Divine pardon. The Council of Trent, however, decided that "reconciliation" could not follow such contrition without the other parts of the sacrament, which form part of it (*sine sacramenti voto, quod in illa includatur*). Contrition is also distinguished from "attrition" (*attritio*), i.e. repentance due to fear of punishment. It was questioned whether a state of mind thus produced would suffice for obtaining the benefits of the sacrament; this point was also set at rest by the Council of Trent, which decided that attrition, though not in itself capable of obtaining the justification of the sinner, is also inspired by God and thus disposes the soul to benefit by the grace of the sacrament.

The word "penance," applied to the whole sacrament, is also used of the works of satisfaction imposed by the priest on the penitent, i.e. the temporal punishment (*poena*). This varies with the character and heinousness of the offences committed. In the middle ages "doing penance" was often a process as terrible and humiliating to the penitent as it was possibly edifying to the Church. Public penances have, however, long been abolished in all branches of the Christian Church. (See CONFESSION.)

PENANG (*Pulus Pinang*, i.e. Arca-nut Island), the town and island which, after Singapore, form the most important portion of the crown colony of the Straits Settlements. The island is situated in 5° 24' N. and 100° 21' E., and distant about 2½ m. from the west coast of the Malay Peninsula. The island is about 15½ m. long by 10½ m. wide at its broadest point. Its area is something over 107 sq. m. The town, which is built on a promontory at a point nearest to the mainland, is largely occupied by Chinese and Tamils, though the Malays are also well represented. Behind the town, Penang Hill rises to a height of some 2700 ft., and upon it are built several government and private bungalows. The town possesses a fine European club, a racecourse, and good golf links. Coco-nuts are grown in considerable quantities along the seashore, and rice is cultivated at Bâlek Pulau and in the interior, but the jungle still spreads over wide areas. Penang has an excellent harbour, but has suffered from its proximity to Singapore. There are a Church of England and a Roman Catholic church in the town, and a training college under the Roman Catholic missionaries of the Société des Missions Étrangères at Pulau Tikus, a few miles outside the town.

Administration.—Since 1867 Penang has been under the administrative control of a resident councillor who is responsible to the governor of the Straits. He is aided in his duties by officers of the Straits Civil Service. Two unofficial members of the legislative council of the colony, which holds its sittings in Singapore, are nominated by the governor, with the sanction of the secretary of state for the colonies, to represent Penang. Their term of office is for five years. The official name of the island is Prince of Wales Island and that of the town is Georgetown; neither of these names, however, is in general use. Among the Malays Penang is usually spoken of as *Tanjong* or "The Cape," on account of the promontory upon which the town is situated. The town is administered by a municipal council composed of *ex officio*, nominated, and elected members.

Population.—The population of Penang at the time of the census of 1901 was 128,830, of whom 85,070 were males (60,210 over and 15,860 under 15 years of age), and 43,760 were females (28,725 over and 15,035 under 15 years of age). The population was composed of 71,462 Chinese, 34,286 Malays, 18,740 Tamils and other natives of India, 1649 Eurasians, 993 Europeans and Americans, and 1609 persons of other nationalities. As in other parts of the Straits Settlements the men are far more numerous than the women. The total population of the settlement of Penang, which includes not only the island but Province Wellesley and the Dindings, was 248,207 in 1901.

Shipping.—The number of ships which entered and left the port of Penang during 1906 was 2324 with an aggregate tonnage of 2,868,459. Of these 1802 were British with an aggregate tonnage of 1,966,286. These figures reveal a considerable falling-off during the past decade, the number of vessels entering and leaving the port in 1898 being 5114 with an aggregate tonnage of 3,761,094. This is mainly due to the construction of the railway which runs from a point on the mainland opposite to Penang, through the Federated Malay States of Perak, Selangor and the Negri Sembilan to Malacca, and has diverted to other ports and eventually to Singapore much of the coastal traffic which formerly visited Penang.

Finance and Trade.—The revenue of Penang, that is to say, not only of the island but of the entire settlement, amounted in 1906 to \$6,031,917, of which \$2,014,033 was derived from the revenue farms for the collection of import duties on opium, wine and spirits; \$160,047 from postal revenue; \$119,585 from land revenue; \$129,151 from stamps. The expenditure for 1906 amounted to \$5,072,406, of which \$836,097 was spent on administrative establishments, \$301,252 on the upkeep of existing public works; \$415,175 on the construction of works and buildings, and of new roads, streets, bridges, &c. The imports in 1906 were valued at \$94,546,112, the exports at \$90,709,225. Of the imports \$57,880,889 worth came from the United Kingdom or from British possessions or protectorates; \$23,937,737 worth came from foreign countries; and \$3,906,241 from the Dindings, Malacca and Singapore. Of the exports, \$23,122,947 went to the United Kingdom, or to British possessions or protectorates; \$37,671,033 went to foreign countries; and \$2,754,238 went to the Dindings, Malacca or Singapore.

History.—Penang was founded on the 17th of July 1786, having been ceded to the East India Company by the Sultan of Kedah in 1785 by an agreement with Captain Light, for an annuity of \$10,000 for eight years. In 1791 the subsidy was

changed to \$6000, in perpetuity; for some years later this was raised to \$10,000, and is still annually paid. This final addition was made when Province Wellesley was purchased by the East India Company for \$2000 in 1798. At the time of the cession Penang was almost uninhabited. In 1796 it was made a penal settlement, and 700 convicts were transferred thither from the Andaman Islands. In 1805 Penang was made a separate presidency, ranking with Bombay and Madras; and when in 1826 Singapore and Malacca were incorporated with it, Penang continued to be the seat of government. In 1829 Penang was reduced from the rank of a presidency, and eight years later the town of Singapore was made the capital of the Settlements. In 1867 the Straits Settlements were created a Crown colony, in which Penang was included.

See *Straits Settlements Blue Book 1906* (Singapore, 1907); *The Straits Directory* (Singapore, 1907); Sir Frank Swettenham, *British Malaya* (London, 1906). (H. Cl.)

PENARTH, an urban district and seaport in the southern parliamentary division of Glamorganshire, Wales, 166 m. by rail from London, picturesquely situated on rising ground on the south side of the mouth of the Ely opposite Cardiff, from which it is 4 m. distant by rail and 2 m. by steamer. Pop. (1901), 14,228. The place derives its name from two Welsh words, "pen," a head, and "garth," an enclosure. Penarth was a small and unimportant village until a tidal harbour at the mouth of the Ely was opened in 1850, and a railway, 6 m. long, was made about the same time, connecting the harbour with the Taff Vale railway at Radyr. A dock, authorized in 1857, was opened in 1865, when all three undertakings, which had cost £775,000, were leased in perpetuity to the Taff Vale Railway Company. The monopoly which the Bute Docks at Cardiff had previously enjoyed in shipping coal from the valleys of the Taff and Rhondda was thus terminated. The town is frequented in summer as a bathing-place, and the Rhaetic beds at the head are of special interest to geologists. On this head there stood an old church, probably Norman, which served as a landmark for sailors. The remains of an old chantry have been converted into a barn. Besides two Established and one Roman Catholic church, the principal buildings of Penarth are its various Nonconformist chapels, intermediate and technical school (1894), custom house, dock offices, and Turner House with a private art gallery which is thrown open on certain days to the public. Three miles to the west is Dinas Powis Castle. In 1880-1883 gardens were laid out along the cliff, in 1894 a promenade and landing-pier with a length of 630 ft. were constructed, and in 1900 a marine subway open at all times for foot passengers was made under the river Ely. The dock, as first constructed, comprised 17½ acres, was extended in 1884 at a cost of £250,000, and now covers 23 acres with a basin of 3 acres. It is 2900 ft. in length, has a minimum depth of 26 ft., and is furnished with every modern appliance for the export of coal, of which from 20,000 to 30,000 tons can be stored in the sidings near by. The Penarth-Ely tidal harbour has a water area of 55 acres with a minimum depth of 20 ft., and a considerable import trade is carried on here mainly by coasting vessels; but as only one of its sides has wharves (about 3000 ft. along) scarcely more than 5% of the total shipping of the port is done here. It has commodious warehouses, also tanks to hold about 6000 tons of oil.

PENATES (from Lat. *penus*, eatables, food), Roman gods of the store-room and kitchen. The store-room over which they presided was, in old times, beside the *atrium*, the room which served as kitchen, parlour, and bedroom in one; but in later times the store-room, was in the back part of the house. It was sanctified by the presence of the Penates, and none but pure and chaste persons might enter it, just as with the Hindus the kitchen is sacred and inviolable. They had no individual names, but were always known under the general designation, Penates. Closely associated with the Penates were the Lares (*q.v.*) another species of domestic deity, who seem to have been the defised spirits of deceased ancestors. But while each family had two Penates it had but one Lar. In the household shrine the image of the Lar (dressed in a toga) was placed

between the two images of the Penates, which were represented as dancing and elevating a drinking-horn in token of joy and plenty. The three images together were sometimes called Penates, sometimes Lares, and either name was used metaphorically for "home." The shrine stood originally in the *atrium*, but when the hearth and the kitchen were separated from the *atrium* and removed to the back of the house, and meals were taken in an upper storey, the position of the shrine was also shifted. In the houses at Pompeii it is sometimes in the kitchen, sometimes in the rooms. In the later empire it was placed behind the house-door, and a taper or lamp was kept burning before it. But the worship in the interior of the house was also kept up even into Christian times; it was forbidden by an ordinance of Theodosius (A.D. 392). The old Roman used, in company with his children and slaves, to offer a morning sacrifice and prayer to his household gods. Before meals the blessing of the gods was asked, and after the meal, but before dessert, there was a short silence, and a portion of food was placed on the hearth and burned. If the hearth and the images were not in the eating-room, either the images were brought and put on the table, or before the shrine was placed a table on which were set a salt-cellar, food and a burning lamp. Three days in the month, viz. the Calends, Nones and Ides (*i.e.* the first, the fifth or seventh, and the thirteenth or fifteenth), were set apart for special family worship, as were also the *Caristia* (Feb. 22) and the *Saturnalia* in December. On these days as well as on such occasions as birthdays, marriages, and safe returns from journeys, the images were crowned and offerings made to them of cakes, honey, wine, incense, and sometimes a pig. As each family had its own Penates, so the state, as a collection of families, had its public Penates. Intermediate between the worship of the public and private Penates were probably the rites (*sacra*) observed by each clan (*gens*) or collection of families supposed to be descended from a common ancestor. The other towns of Latium had their public Penates as well as Rome. The sanctuary of the whole Latin league was at Lavinium. To these Penates at Lavinium the Roman priests brought yearly offerings, and the Roman consuls, praetors and dictators sacrificed both when they entered on and when they laid down their office. To them, too, the generals sacrificed before departing for their province. Alba Longa, the real mother-city of Latium, had also its ancient Penates, and the Romans maintained the worship on the Alban mount long after the destruction of Alba Longa. The Penates had a temple of their own at Rome. It was on the Velia near the Forum, and has by some been identified with the round vestibule of the church of SS. Cosma e Damiano. In this and many other temples the Penates were represented by two images of youths seated holding spears. The Penates were also worshipped in the neighbouring temple at Vesta. To distinguish the two worshipings it has been supposed that the Penates in the former temple were those of Latium, while those in the temple of Vesta were the Penates proper of Rome. Certainly the worship of the Penates, whose altar was the hearth and to whom the kitchen was sacred, was closely connected with that of Vesta, goddess of the domestic hearth.

The origin and nature of the Penates was a subject of much discussion to the Romans themselves. They were traced to the mysterious worship of Samothrace; Dardanus, it was said, took the Penates from Samothrace to Troy, and after the destruction of Troy, Aeneas brought them to Italy and established them at Lavinium. From Lavinium Ascanius carried the worship to Alba Longa, and from Alba Longa it was brought to Rome. Equally unsatisfactory with this attempt to connect Roman religion with Greek legend are the vague and mystic speculations in which the later Romans indulged respecting the nature of the Penates. Some said they were the great gods to whom we owe breath, body and reason, viz. Jupiter representing the middle ether, Juno the lowest air and the earth, and Minerva the highest ether, to whom some added Mercury as the god of speech (Servius, on *Aen.* ii. 296; Macrobius, *Sat.* iii. 4, 8; Arnobius, *Adv. Nat.* iii. 40). Others identified them with Apollo

and Neptune (Macrob. iii. 4, 6; Arnob. *loc. cit.*; Servius, on *Aen.* iii. 119). The Etruscans held the Penates to be Ceres, Paes and Fortuna, to whom others added Genius Jovialis (Servius on *Aen.* ii. 325; Arnob. *loc. cit.*). The late writer Martianus Capella records the view that heaven was divided into sixteen regions, in the first of which were placed the Penates, along with Jupiter, the Lares, &c. More fruitful than these misty speculations is the suggestion, made by the ancients themselves, that the worship of these family gods sprang from the ancient Roman custom (common to many savage tribes) of burying the dead in the house. But this would account for the worship of the Lares rather than of the Penates. A comparison with other primitive religious beliefs suggests the conjecture that the Penates may be a remnant of fetishism or animism. The Roman genii seem certainly to have been fetishes and the Penates were perhaps originally a species of genii. Thus the Penates, as simple gods of food, are probably much more ancient than deities like Jupiter, Neptune, Apollo and Minerva.

With the Penates we may compare the kindly household gods of old Germany; they too had their home on the kitchen hearth and received offerings of food and clothing. In the castle of Hudemühlen (Hanover) there was a kobold for whom a cover was always set on the table. In Lapland each house had one or more spirits. The souls of the dead are regarded as house-spirits by the Russians; they are represented as dwarfs, and are served with food and drink. Each house in Servia has its patron-saint. In the mountains of Mysore every house has its bhuta or guardian deity, to whom prayer and sacrifices are offered. The Chinese god of the kitchen presents some curious analogies to the Penates: incense and candles are burnt before him on the first and fifteenth of the month; some families burn incense and candles before him daily; and on great festivals, one of which is at the winter solstice (nearly corresponding to the Saturnalia), he is served with cakes, pork, wine, incense, &c., which are placed on a table before him.

See ROMAN RELIGION.

(J. G. Fr.; X.)

PENCIL (Lat. *penicillus*, brush, literally little tail), a name originally applied to a small fine-pointed brush used in painting, and still employed to denote the finer camel's-hair and sable brushes used by artists, but now commonly signifying solid cones or rods of various materials used for writing and drawing. It has been asserted that a manuscript of Theophilus, attributed to the 13th century, shows signs of having been ruled with a black-lead pencil; but the first distinct allusion occurs in the treatise on fossils by Conrad Gesner of Zurich (1565), who describes an article for writing formed of wood and a piece of lead, or, as he believed, an artificial composition called by some *stimmi anglicanum* (English antimony). The famous Borrowdale mine in Cumberland having been discovered about that time, it is probable that we have here the first allusion to that great find of graphite. While the supply of the Cumberland mine lasted, the material for English pencils consisted simply of the native graphite as taken from the mine. The pieces were sawn into thin sheets, which again were cut into the slender square rods forming the "lead" of the pencil.

Strenuous efforts were made on the continent of Europe and in England to enable manufacturers to become independent of the product of the Cumberland mine. In Nuremberg, where the great pencil factory of the Faber family (*q.v.*) was established in 1760, pencils were made from pulverized graphite cemented into solid blocks by means of gums, resins, glue, sulphur and other such substances, but none of these preparations yielded useful pencils. In the year 1795 N. J. Conté (*q.v.*), of Paris, devised the process by which now all black-lead pencils, and indeed pencils of all sorts, are manufactured. In 1843 William Brockedon patented a process for compressing pure black-lead powder into solid compact blocks by which he was enabled to use the dust, fragments, and cuttings of fine Cumberland lead. Brockedon's process would have proved successful but the exhaustion of the Borrowdale supplies and the excellence of Conté's process rendered it more of scientific interest than of commercial value.

The pencil leads prepared by the Conté process consist of a mixture of graphite and clay. The graphite, having been pulverized and subjected to any necessary purifying processes, is "floated" through a series of settling tanks, in each of which the comparatively heavy particles sink, and only the still finer particles are carried over. That which sinks in the last of the series is in a condition of extremely fine division, and is used for pencils of the highest quality. The clay, which must be free from sand and iron, is treated in the same manner. Clay and graphite so prepared are mixed together in varying proportions with water to a paste, passed repeatedly through a grinding mill, then placed in bags and squeezed in a hydraulic press till they have the consistency of stiff dough, in which condition they are ready for forming pencil rods. For this purpose the plastic mass is placed in a strong upright cylinder, from which a plunger or piston, moved by a screw, forces it out through a perforated base-plate in a continuous thread. This thread is finally divided into suitable lengths, which are heated in a closed crucible for some hours. The two factors which determine the comparative hardness and blackness of pencils are the proportions of graphite and clay in the leads and the heat to which they are raised in the crucible. According as the proportion of graphite is greater and the heat lower the pencil is softer and of deeper black streak.

The wood in which the leads are cased is pencil cedar from *Juniperus virginiana* for the best qualities, and pine for the cheaper ones. A board of the selected wood, having a thickness about equal to half the diameter of the finished pencil and as wide as four or six pencils, is passed through a machine which smooths the surface and cuts round or square grooves to receive the leads. The leads being placed in the grooves the board is covered with another similarly grooved board, and the two are fastened together with glue. When dry they are taken to rapidly revolving cutters which remove the wood between the leads. The individual pencils thus formed only need to be finished by being dyed and varnished and stamped with name, grade, &c. Instead of wood, paper has been tried for the casings, rolled on in narrow strips which are torn off to expose fresh lead as the point becomes worn down by use.

Black pencils of an inferior quality are made from the dust of graphite melted up with sulphur and run into moulds. Such, with a little tallow added to give them softness, are the pencils commonly used by carpenters. Coloured pencils consist of a mixture of clay, with appropriate mineral colouring matter, wax, and tallow, treated by the Conté method, as in making lead pencils. In indelible and copying pencils the colouring matter is an aniline preparation mixed with clay and gum. The mixture not only makes a streak which adheres to the paper, but, when the writing is moistened with water, it dissolves and assumes the appearance and properties of an ink.

PENDA, king of Mercia (d. 654 or 655), son of Pybba, probably came to the throne in 626, but it is doubtful whether he actually became king of Mercia until 633, the year of the defeat and death of Edwin of Northumbria. According to the Anglo-Saxon Chronicle he was eighty years old at his death, but the energy of his administration and the evidence with regard to the ages of his children and relatives render it almost impossible. In 628 the Chronicle records a battle between him and the West Saxons at Cirencester in that year. In 633 Penda and Ceadwalla overthrew Edwin at Hatfield Chase; but after the defeat of the Welsh king at Oswald at "Hefenfelth" in 634, Mercia seems to have been for a time subject to Northumbria. In 642 Penda slew Oswald at a place called Maerfeld. He was continually raiding Northumbria and once almost succeeded in reducing Bamborough. He drove Cenwalh of Wessex, who had divorced his sister, from his throne. In 654 he attacked the East Angles, and slew their king Anna (see EAST ANGLIA). In 654 or 655 he invaded Northumbria in spite of the attempts of Oswio to buy him off, and was defeated and slain on the banks of the "Winwaed." In the reign of Penda the districts corresponding to Cheshire, Shropshire and Herefordshire were probably acquired, and he established his son Penda as a dependent prince in Middle Anglia. Although a pagan, he allowed his daughter Cyneburg to marry Alchfrith, the son of

Oswio, and it was in his reign that Christianity was introduced into Middle Anglia by his son Peada.

See Bede, *Hist. Eccl.* (ed. C. Plummer, Oxford, 1896); *Anglo-Saxon Chronicle* (ed. Earle and Plummer, Oxford, 1899).

PENDANT (through Fr. from Lat. *pendere*, to hang), any hanging object, such as a jewel or other ornament hanging from a brooch, bracelet, &c., or the loose end of a knight's belt left hanging after passing through the buckle, and terminating in an ornamental end. In architecture the word is applied to an elongated boss, either moulded or foliated, such as hangs down from the intersection of ribs, especially in fan tracery, or at the end of hammer beams. Sometimes long corbels, under the wall pieces, have been so called. The name has also been given to the large masses depending from enriched ceilings, in the later works of the Pointed style. "Pendants" or "Pendent posts" are those timbers which are carried down the side of the wall from the plate, and receive the hammer braces.

PENDENTIVE, the term given in architecture to the bridging across the angles of a square hall, so as to obtain a circular base for a dome or drain. This may be done by corbelling out in the angles, in which case the pendentive may be a portion of a hemisphere of which the half diagonal of the square hall is the radius; or by throwing a series of arches across the angle, each ring as it rises advancing in front of the one below and being carried by it during its construction; in this case the base obtained is octagonal, so that corbels or small pendentives are required for each angle of the octagon, unless as in the church of SS. Sergius and Bacchus at Constantinople a portion of the dome is set back; or again, by a third method, by sinking a semicircular niche in the angle. The first system was that employed in St Sophia at Constantinople, and in Byzantine churches generally, also in the domed churches of Perigord and Aquitaine. The second is found in the Sassanian palaces of Serbistan and Firuzabad, and in medieval architecture in England, France and Germany, where the arches are termed "squinches." The third system is found in the mosque at Damascus, and was often adopted in the churches in Asia Minor. There is still another method in which the pendentive and cupola are part of the same hemispherical dome, and in this case the ring courses lie in vertical instead of horizontal planes, examples of which may be found in the vault of Magnesia on Macæder in Asia Minor, and in the tomb at Valence known as *le pendentif de Valence*. The problem is one which has taxed the ingenuity of many builders in ancient times; the bas-reliefs found at Nimrud show that in the 9th century B.C. domes were evidently built over square halls, and must have been carried on pendentives of some kind.

PENDER, SIR JOHN (1816-1896), British cable pioneer, was born in the Vale of Leven, Scotland, on the 10th of September 1816, and after attending school in Glasgow became a successful merchant in textile fabrics in that city and in Manchester. His name is chiefly known in connexion with submarine cables, of which on the commercial side he was an important promoter. He was one of the 345 contributors who each risked a thousand pounds in the Transatlantic Cable in 1857, and when the Atlantic Telegraph Company was ruined by the loss of the 1865 cable he formed the Anglo-American Telegraph Company to continue the work, but it was not till he had given his personal guarantee for a quarter of a million pounds that the makers would undertake the manufacture of a new cable. But in the end he was justified, and telegraphic communication with America became a commercial success. Subsequently he fostered cable enterprise in all parts of the world, and at the time of his death, which occurred at Footscray Place, Kent, on the 7th of July 1896, he controlled companies having a capital of 15 millions sterling and owning 73,640 nautical miles of cables. He represented Wick Burghs in parliament from 1872 to 1885 and was promoted in 1892 to be K.C.M.G. He was made a K.C.M.G. in 1888 and was promoted in 1892 to be G.C.M.G. His eldest son James (b. 1841), who was M.P. for Mid Northamptonshire in 1895-1900, was created a baronet in 1897; and his third son, John Denison (b. 1855), was created a K.C.M.G. in 1901.

PENDLESIDE SERIES, in geology, a series of shales between the upper division of the Carboniferous Limestone and the Millstone Grits occurring in the Midlands between Stoke-on-Trent and Settle. It consists of black limestones at the base, followed by black shales with calcareous nodules, which pass into sandy shales with ganister-like sandstones. In places the series attains a thickness of 1500-2000 ft., and where it is thickest the Millstone Grits also attain their maximum thickness. The peculiarities of the series, which is characterized by a rich fauna with *Productus giganteus*, *P. striatus*, *Dibunophyllum*, *Cyathozonia cornu* and *Lonsdaleia floriformis*, can be best studied on the western slope of Pendle Hill, Lancashire, in the valley of the Hodder, dividing the counties of Lancashire and Yorkshire, at Mam Tor and the Edale valley in Derbyshire, and Morredge, the Dane valley in north Staffordshire, Bagillt and Teilia in North Wales, and Scarlett and Poolvash, Isle of Man. The limestones of the base are hard, compact and fossiliferous, often cherty, and vary much in the amount of calcium carbonate which they contain, at times passing into calcareous shales.

These limestones and shales contain a distinct fauna which appears for the first time in the Midlands, characterized by *Pterinopecten papyraceus*, *Posidonella laevis*, *Posidonomya Becheri*, *Posidonomya membranacea*, *Novismoceras rotiforme* and *Glyphioceras striatum*. Immediately below beds with this fauna are thin limestones with *Prolecanites compressus*, *Siroboceras bisulcatum*, many trilobites, and corals referable to the genera *Cyathozonia*, *Zaphrentis* and *Amplesiaiphrentis*. The fauna characteristic of the Carboniferous Limestone becomes largely extinct and is replaced by a shale fauna, but the oncoming of the age of Goniatites is shown by the presence in the upper part of the Carboniferous Limestone of numerous species and genera of this group, *Glyphioceras crenestría* being the most common and having the wider horizontal range. The whole Pendleside series can be divided into zones by the different species of Goniatites. At the base *Prolecanites compressus* characterizes the passage beds between the Carboniferous Limestone and the Pendlesides; *Nemismoceras rotiforme* and *Glyphioceras striatum* are found in a narrow zone immediately above. Then *Glyphioceras reticulatum* appears and reaches its maximum, and is succeeded by *Glyphioceras diadema* and *Glyphioceras spirale*, while immediately below the Millstone Grits *Glyphioceras bilingue* appears and passes up in that series. The Millstone Grits are characterized by the presence of *Gastrioceras Listeri*. The Pendleside series is therefore characterized by an Upper Carboniferous fauna, *Pterinopecten papyraceus*, *Posidonella laevis* and some other species which pass up right through the Coal Measures appearing for the first time, and the base of the series marks the division between Upper and Lower Carboniferous times.

The series passes eastward into Belgium and thence into Germany, when the same fossil zones are found in the basin of Namur and the valley of the Dill. Traced westward the series is well developed in Co. Dublin and on the west coast of Co. Clare and Limerick. There can be no doubt that the Pendleside series of the Midlands represents the Lower Culm of Codden Hill, north Devon, and the Lower Culm of the continent of Europe. The faunas in these localities have the same biological succession as in the Midlands.

See Wheelton Hind and J. Allen Howe, *Quart. Journ. Geol. Soc.* vol. lvii. (1901), and numerous other papers by the first-named author. (W. Ht.)

PENDLETON, EDMUND (1721-1803), American lawyer and statesman, was born, of English Royalist descent, in Caroline county, Virginia, on the 9th of September 1721. He was self-educated, but after reading law and being admitted to the bar (1744) his success was immediate. He served in the Virginia House of Burgesses from 1752 until the organization of the state government in 1776, was the recognized leader of the conservative Whigs, and took a leading part in opposing the British government. He was a member of the Virginia committee of correspondence in 1773, in 1774 was president of the Virginia provincial convention, and a member of the first

Continental Congress. In 1776, as president of the provincial convention, which adopted a state constitution for Virginia, he drew up the instructions to the Virginia members of Congress directing them to advocate the independence of the American colonies. In the same year he became president of the Virginia committee of safety, and in October was chosen the first speaker of the House of Delegates. With Jefferson and Chancellor George Wythe he drew up a new law code for Virginia. He was president of the court of chancery in 1777-1788, and from 1779 until his death was president of the Virginia court of appeals. He was an enthusiastic advocate of the Federal constitution, and in 1788 exerted strong influence to secure its ratification by his native state. He was a leader of the Federalist party in Virginia until his death at Richmond, Va., on the 23rd of October 1803.

PENDLETON, GEORGE HUNT (1825-1889), American lawyer and legislator, was born in Cincinnati, Ohio, on the 25th of July 1825. He was educated at the university of Heidelberg, studied law, was admitted to the bar, and began to practise at Cincinnati. He was a member of the Ohio Senate in 1854 and 1855, and from 1857 to 1865 was a Democratic member of the national House of Representatives, in which he opposed the war policy of Lincoln. In 1864 he was the Democratic candidate for vice-president. After leaving Congress he became one of the earliest champions of the "Ohio idea" (which he is said to have originated), demanding that the government should pay the principal of its 5-20-year 6% bonds in the "greenback" currency instead of in coin. The agricultural classes of the West regarded this as a means of relief, and Pendleton became their recognized leader and a candidate for the Democratic nomination to the presidency in 1868, but he failed to receive the requisite two-thirds majority. In 1869 he was the Democratic candidate for governor of Ohio, but was defeated by Rutherford B. Hayes. For the next ten years he devoted himself to the practice of law and to the supervision of the Kentucky Railroad Company, of which he had become president in 1869. From 1879 to 1885 he was a Democratic member of the United States Senate, and introduced the so-called Pendleton Act of 1883 for reforming the civil service, hostility to which lost him his seat in 1885. He was minister to Germany from 1885 to the summer of 1889, and died at Brussels on the 24th of November 1889.

PENELOPE, in Greek legend, wife of Odysseus, daughter of Icarus and the nymph Periboea. During the long absence of her husband after the fall of Troy many chieftains of Ithaca and the islands round about became her suitors; and, to rid herself of the importunities of the wooers, she bade them wait till she had woven a winding-sheet for old Laertes, the father of Odysseus. But every night she undid the piece which she had woven by day. This she did for three years, till her maids revealed the secret. She was relieved by the arrival of Odysseus, who returned after an absence of twenty years, and slew the wooers. The character of Penelope is less favourable in late writers than in the Homeric story. During her husband's absence she is said to have become the mother of Pan by Hermes, and Odysseus, on his return, repudiated her as unfaithful (Herodotus ii. 145 and schol.). She thereupon withdrew to Sparta and thence to Mantinea, where she died and where her tomb was shown. According to another account she married Telegonus the son of Odysseus and Circe, after he had killed his father, and dwelt with him in the island of Aea or in the Islands of the Blest (Hyginus, *Fab.* 127).

PENGELLY, WILLIAM (1812-1894), English geologist and anthropologist, was born at East Looe in Cornwall on the 12th of January 1812, the son of the captain of a small coasting vessel. He began life as a sailor, after an elementary education in his native village, but in 1828 he abandoned a seafaring life. He had developed a passion for learning, and about 1836 he removed to Torquay and started a school; in 1846 he became a private tutor in mathematics and natural science. Geology had in early years attracted his attention, but it was not until he was about 30 years of age that he began seriously to cultivate

the study. In 1837 he was instrumental in the reorganization of the Torquay Mechanics' Institute, in 1844 mainly owing to his energy the Torquay Natural History Society was founded, and in 1862 he assisted in founding the Devonshire Association for the Advancement of Literature, Science and Art. Meanwhile he had been occupied in collecting fossils from many parts of Devon and Cornwall, and in 1860 the Baroness Burdett-Coutts acquired and presented them to the Oxford Museum, where they form "The Pengelly Collection." Through the generosity of the same lady he was called upon to examine the lignites and clays of Bovey Tracey, in conjunction with Dr Oswald Heer, who undertook the determination of the plant-remains. Their report was published by the Royal Society (1862), and Pengelly was elected F.R.S. in 1863. He aided in the investigations of the Brixham bone-cavern from the date of its discovery in 1858, the full report being issued in 1873; and he was the main explorer of Kent's Hole, Torquay, and from 1864 for more than fifteen years he laboured with unflinching energy in examining and recording the exact position of the numerous organic remains that were disinterred during a systematic investigation of this cave, carried on with the aid of grants from the British Association. He first attended the British Association at the Cheltenham meeting in 1856, and was present at subsequent meetings (except that at Montreal in 1884) until 1889. His observations assisted in establishing the important fact of the contemporaneity of Palaeolithic man with various Pleistocene mammalia, such as the mammoth, cave-bear, cave-lion, &c. He was awarded the Lyell medal by the Geological Society of London in 1886. He died at Torquay on the 16th of March 1894.

See *Memoir of William Pengelly*, edited by his daughter Hester Pengelly, with a summary of his scientific work by the Rev. Professor T. G. Bonney (1897).

PENGUIN, the name of a flightless sea-bird,¹ but, so far as is known, first given to one inhabiting the seas of Newfoundland as in Hore's "Voyage to Cape Breton," 1536 (Hakluyt, *Researches*, iii. 168-170), which subsequently became known as the great auk or garefowl (*g.v.*); though the French equivalent *Pinguin*² preserves its old application, the word penguin is by English ornithologists always used for certain birds inhabiting the Southern Ocean, called by the French *Manchots*, the *Spheniscidae* of ornithologists. For a long while their position was very much misunderstood, some systematists having placed them with the *Alcidae* or Auks, to which they bear only a relationship of analogy, as indeed had been perceived by a few ornithologists, who recognized in the penguins a very distinct order, *Impennes*. L. Stejneger (*Standard Nat. Hist.* vol. iv., Boston, 1885) gave the *Impennes* independent rank equivalent to the rest of Carinate birds; M. A. Menzies (*Vergl. Ostkol. d. Pinguine*, Moscow, 1887) took a similar view; M. Fürbringer was first to show their relation to *Procellariiformes*, and this view is now generally accepted.

¹ Of the three derivations assigned to this name, the first is by Drayton in 1613 (*Polyolbion*, Song 9), where it is said to be the Welsh *pen gwyn*, or "white head"; the second, which seems to meet with Littré's approval, deduces it from the Latin *pinguis* (fat), which idea has given origin to the German name, *Felgāne*, for these birds; the third supposes it to be a corruption of "pin-wing" (*Ann. Nat. History*, 4th series, vol. iv. p. 133), meaning a bird that has undergone the operation of pinioning or, as in one part at least of England it is commonly called, "pin-winging." The first hypothesis has been supported on the ground that Breton sailors speaking a language closely allied to Welsh were acquainted with the great auk, and that the conspicuous white patches on the head of that bird justified the name "white head." To the second hypothesis Skeat (*Dictionary*, p. 433) objects that it "will not account for the suffix -in, and is therefore wrong; besides which the 'Dutchmen' who were asserted to be the authors of the name) turn out to be Sir Francis Drake" and his men. In support of the third hypothesis Mr Rees wrote (*Zoologist*, 2nd series, p. 1854) that the people in Newfoundland who used to meet with this bird always pronounced its name "pin wing." Skeat's inquiry (*loc. cit.*), whether the name may not after all be South American, is to be answered in the negative, since, so far as evidence goes, it was given to the North-American bird before the South-American was known in Europe.

² *Gorfon* has also been used by some French writers, being a corruption of *Geirfugl* or Garefowl.

There is a total want of quills in their wings, which are incapable of flexure, though they move freely at the shoulder-joint, and some at least of the species occasionally make use of them for progressing on land. In the water they are most efficient paddles. The plumage, which clothes the whole body, generally consists of small scale-like feathers, many of them consisting only of a simple shaft without the development of barbs; but several of the species have the head decorated with long cirrhus tufts, and in some the tail-quills, which are very numerous, are also long.¹ In standing these birds preserve an upright position, sometimes resting on the "tarsus"² alone, but in walking or running this is kept nearly vertical, and their weight is supported by the toes alone.

The most northerly limit of the penguins' range in the Atlantic is Tristan d'Acunha, and in the Indian Ocean Amsterdam Island, but they also occur off the Cape of Good Hope and along the coast of Australia, as well as on the south and east of New Zealand, while in the Pacific one species at least extends along the west coast of South America and to the Galapagos; but north of the equator none are found. In the breeding season they resort to the most desolate lands in higher southern latitudes, and indeed have been met with as far to the southward as navigators have penetrated. Possibly the Falkland Islands are richest in species, though, as individuals, they



King-Penguin (*Aptenodytes pennanti*).

are not nearly so numerous there as in many other places. The food of penguins consists of crustaceans, cephalopods and other molluscs, varied by fish and vegetable matter. The birds form immense breeding colonies, known as "rookeries." The nest of grass, leaves, or where vegetation is scanty of stones or rubbish, is placed on the ground or in holes. Two chalky white or greenish eggs are laid. The young penguins, clad in thick down, are born blind and are fed by the parents for an unusually long time before taking to the water. Penguins bite savagely when molested, but are easily trained and display considerable intelligence.

The *Spheniscidae* have been divided into at least eight genera, but three, or at most four, seem to be all that are needed, and

¹ The pterylographical characters of the penguins are well described by A. Hyatt (*Proc. Boston Soc. Nat. History*, 1871). A. D. Bartlett has observed (*Proc. Zool. Soc.*, 1879, pp. 6-9) that, instead of moulting in the way that birds ordinarily do, penguins, at least in passing from the immature to the adult dress, cast off the short scale-like feathers from their wings in a manner that he compares to "the shedding of the skin in a serpent."

² The three metatarsals in the penguins are not, as in other birds, united for the whole of their length, but only at the extremities, thus preserving a portion of their originally distinct existence, a fact probably attributable to arrest of development, since the researches of C. Gegenbaur show that the embryos of all birds, so far as is known, possess these bones in an independent condition.

three can be well distinguished, as pointed out by E. Coues in *Proc. Acad. of Nat. Sci. of Philadelphia*, 1872 (pp. 170-212), by anatomical as well as by external characters. They are: (1) *Aptenodytes*, easily recognized by its long and thin bill, slightly decurved, from which *Pygoscelis*, as M. Watson has shown, is hardly distinguishable; (2) *Eudyptes*, in which the bill is much shorter and rather broad; and (3) *Spheniscus*, in which the shortish bill is compressed and the maxilla ends in a conspicuous hook. *Aptenodytes* contains the largest species, among them those known as the "Emperor" and "King" penguins *A. patagonica* and *A. longirostris*. Three others belong also to this genus, if *Pygoscelis* be not recognized, but they seem not to require any particular remark. *Eudyptes*, containing the crested penguins, known to sailors as "Rock-hoppers" or "Macaronis," would appear to have five species, and *Spheniscus* four, among which *S. mendiculus*, which occurs in the Galapagos, and therefore has the most northerly range of the whole group, alone needs notice here. (A. N.)

The generic and specific distribution of the penguins is the subject of an excellent essay by Alphonse Milne-Edwards in the *Annales des sciences naturelles* for 1880 (vol. ix. art. 9, pp. 23-81); see also the Records of the Antarctic Expedition, 1901-1904.

PENHALLOW, SAMUEL (1665-1726), American colonist and historian, was born at St Mabon, Cornwall, England, on the 2nd of July 1665. From 1683 to 1686 he attended a school at Newington Green (near London) conducted by the Rev. Charles Morton (1627-1698), a dissenting clergyman, with whom he emigrated to Massachusetts in 1686. He was commissioned by the Society for the Propagation of the Gospel in New England to study the Indian languages and to preach to the Indians; but he was soon diverted from this work. Removing to Portsmouth, New Hampshire, he there married a daughter of John Cutt (1625-1681), president of the province of New Hampshire in 1679-1680, a successful merchant and mill-owner, and thus came into possession of considerable property (including much of the present site of Portsmouth). In 1700 he was speaker of the Assembly and in 1702 became a member of the Provincial Council, but was suspended by Liéut.-Governor George Vaughan (1676-1724). Penhallow, however, was sustained by Governor Samuel Shute (1662-1742), and Vaughan was removed from office in 1716. In 1714 Penhallow was appointed a justice of the superior court of judicature, and from 1717 until his death was chief justice of that court; and he also served as treasurer of the province in 1699-1726, and as secretary of the province in 1714-1726. He died at Portsmouth on the 2nd of December 1726. He wrote a valuable *History of the War of New England with the Eastern Indians, or a Narrative of their Continued Perfidy and Cruelty* (1726; reprinted in the *Collections of the New Hampshire Historical Society*, vol. i., 1824, and again at Cincinnati in 1859), which covers the period from 1703 to 1726, and is a standard contemporary authority.

PENINGTON, SIR ISAAC (c. 1587-1661), lord mayor of London, eldest son of Robert Penington, a London fishmonger, was born probably in 1587. His father besides his London business had landed estates in Norfolk and Suffolk, which Isaac inherited in addition to a property in Buckinghamshire which he himself purchased. In 1638 Isaac became an alderman and high sheriff of London. In 1640 he was elected to the House of Commons as member for the city of London, and immediately took a prominent place among the Puritan party. In 1642 he was elected lord mayor of London, but retained his seat in parliament by special leave of the Commons; and he was elected lord mayor for a second term in the following year, continuing while in office to raise large sums of money for the opposition to the Court party. From 1642 to 1645 he was lieutenant of the Tower, in which capacity he was present at the execution of Laud; but, though one of the commissioners for the trial of Charles I, he did not sign the death warrant. After the king's death Penington served on Cromwell's council of state, and on several committees of government. His services were rewarded by considerable grants of land, and a

knighthood conferred in 1649. He was tried and convicted of treason at the Restoration, and died while a prisoner in the Tower on the 17th of December 1661. He was twice married, and had six children by his first wife, several of whom became Quakers.

ISAAC PENINGTON (1616-1679), Sir Isaac's eldest son, was one of the most notable of the 17th-century Quakers. He was early troubled by religious perplexities, which found expression in many voluminous writings. No less than eleven religious works, besides a political treatise in defence of democratic principles, were published by him in eight years. He belonged for a time to the sect of the Independents; but about 1657, influenced probably by the preaching of George Fox, whom he heard in Bedfordshire, Penington and his wife joined the Society of Friends. His wife was daughter and heiress of Sir John Proude, and widow of Sir William Springett, so that the worldly position of the couple made them a valuable acquisition to the Quakers. Isaac Penington was himself a man of very considerable gifts and sweetness of character. In 1661 he was imprisoned for refusing to take the oath of allegiance, and on several subsequent occasions he passed long periods in Reading and Aylesbury gaols. He died on the 8th of October 1679; his wife, who wrote an account of his imprisonments, survived till 1682. In 1681 Penington's writings were published in a collected edition, and several later editions were issued before the end of the 18th century. His son John Penington (1655-1710) defended his father's memory against attack, and published some controversial tracts against George Keith. Edward Penington (1667-1711), another of Isaac Penington's sons, emigrated to Pennsylvania, where he founded a family. Isaac Penington's stepdaughter, Gulicma Springett, married William Penn.

See Maria Webb, *The Penns and Peningtons of the 17th Century* (London, 1867); Lord Clarendon, *History of the Rebellion and Civil Wars in England* (7 vols., Oxford, 1839); Bulstrode Whitlocke, *Memorials of English Affairs: Charles I. to the Restoration* (London, 1732); J. Gurney Bevan, *Life of Isaac Penington* (London, 1784); Thomas Ellwood, *History of the Life of Edwood by his own hand* (London, 1765); Willem Sewel, *History of the Quakers* (6th ed., 2 vols., London, 1834).

PENINSULA (Lat. *paeninsula*, from *paena*, almost, and *insula*, an island), in physical geography, a piece of land nearly surrounded by water. In its original sense it connotes attachment to a larger land-mass by a neck of land (isthmus) narrower than the peninsula itself, but it is often extended to apply to any long promontory, the coast-line of which is markedly longer than the landward boundary.

PENINSULAR WAR (1808-14). This important war, the conduct and result of which greatly enhanced the prestige of British arms, had for its main object the freedom of the Peninsula of Spain and Portugal from the domination of Napoleon; and hence it derives its name, though it terminated upon the soil of France.

Nelson having destroyed the French fleet at Trafalgar, Napoleon feared the possibility of a British army being landed on the Peninsular coasts, whence in conjunction with Portuguese and Spanish forces it might attack France from the south. He therefore called upon Portugal, in August 1807, to comply with his Berlin decree of the 21st of November 1806, under which continental nations were to close their ports to British subjects, and have no communication with Great Britain. At the same time he persuaded the weak king of Spain (Charles IV.) and his corrupt minister Godoy to permit a French army to pass through Spain towards Portugal; while under a secret treaty signed at Fontainebleau on the 27th of October 1807 Spanish troops were to support the French. Portugal was to be subsequently divided between Spain and France, and a new principality of the Algarve was to be carved out for Godoy. Portugal remonstrated against Napoleon's demands, and a French corps (30,000) under General Junot was instantly despatched to Lisbon. Upon its approach the prince regent fled, and the country was occupied by Junot, most of the Portuguese troops being disbanded or sent abroad. Napoleon induced the king of Spain to allow French troops to occupy the country and to

send the flower of the Spanish forces (15,000) under the marquis de Romana¹ to assist the French on the Baltic. Then Dupont de l'Étang (25,000) was ordered to cross the Bidasoa on the 22nd of November 1807; and by the 8th of January 1808 he had reached Burgos and Valladolid. Marshal Monecy with a corps occupied Biscay and Navarre; Duhesme with a division entered Catalonia; and a little later Bessières with another corps had been brought up. There were now about 100,000 French soldiers in Spain, and Murat, grand duke of Berg, as "lieutenant for the emperor," entered Madrid. During February and March 1808 the frontier fortresses of Pampeluna, St Sebastian, Barcelona and Figueras were treacherously occupied and Spain lay at the feet of Napoleon. The Spanish people, in an outburst of fury against the king and Godoy, forced the former to abdicate in favour of his son Ferdinand; but the inhabitants of Madrid having (May 2, 1808) risen against the French, Napoleon refused to recognize Ferdinand; both he and the king were compelled to renounce their rights to the throne, and a mercenary council of regency having been induced to desire the French emperor to make his brother, Joseph Bonaparte, king, he acceded to their request.²

The mask was now completely thrown off, and Spain and Portugal rose against the French. Provincial "juntas" (committees of government) were organized; appeals for assistance made to the British government, which granted arms, money and supplies, and it was resolved to despatch a British force to the Peninsula. Before it landed, the French under Dupont, Monecy and Marshal Bessières (75,000) had occupied parts of Biscay, Navarre, Aragon and the Castiles, holding Madrid and Toledo, while General Duhesme (14,000) was in Catalonia. Monecy (7000) had marched towards the city of Valencia, but been repulsed in attempting to storm it (June 28); Bessières had defeated the Spanish general Joachim Blake at Medina de Rio Seco (June 14, 1808) and Dupont (13,000) had been detached (May 24) from Madrid to reduce Seville and Cadiz in Andalusia. Spanish levies, numbering nearly 100,000 regulars and militia, brave and enthusiastic, but without organization, sufficient training, or a commander-in-chief, had collected together; 30,000 being in Andalusia, a similar number in Galicia, and others in Valencia and Estremadura, but few in the central portion of Spain.

At this juncture Dupont, moving upon Cadiz, met with a reverse which greatly influenced the course of the Peninsular War. On the 7th of June 1808 he had sacked Cordova; but while he was laden with its spoils the Spanish general Castaños with the army of Andalusia (30,000), and also a large body of armed peasantry, approached. Falling back to Andujar, where he was reinforced to 22,000 strong, Dupont detached a force to hold the mountain passes in his rear, whereupon the Spaniards interposed between the detachment and the main body and seized Baylen. Failing to dislodge them, and surrounded by hostile troops and an infuriated peasantry, Dupont capitulated with over *Battle of Baylen, July 19, 1808.* 20,000 men. This victory, together with the intrepid defence of Saragossa by the Spanish general José Palafox (June 15 to August 13, 1808) temporarily paralysed the French and created unbounded enthusiasm in Spain. Duhesme, having failed to take Gerona, was blockaded in Barcelona, Joseph fled from Madrid (Aug. 1, 1808), and the French forces closed to their rear to defend their communications with France. The British troops were directed towards Lisbon and Cadiz, in order to secure these harbours, to prevent the subjugation of Andalusia, and to operate up the basins of the Guadiana, Tagus and Douro into Spain. The British force consisted of 9000 men from Cork, under Sir Arthur Wellesley—at first in chief command; 5000 from Gibraltar, under General (Sir Brent) Spencer; and 10,000 under Sir John Moore coming from Sweden; Wellesley and Moore being directed towards Portugal, and Spencer to Cadiz. On the 1st of August 1808

¹ They subsequently escaped from Jutland, on British vessels, and reached Santander in October 1808.

² The king, the queen and Godoy were eventually removed to Rome, and Ferdinand to Valençay in France.

Wellesley began to land his troops, unopposed, near Figueira da Foz at the mouth of the Mondego; and the Spanish victory of Baylen having relieved Cadiz from danger, Spencer now joined him, and, without waiting for Moore the army, under 15,000 in all (which included some Portuguese)¹ with 18 guns, advanced towards Lisbon.

Campaign in Portugal, 1808.—The first skirmish took place at Obidos on the 15th of August 1808, against Delaborde's division (5000 men with 5 guns), which fell back to Roleia (Rorica or Rolica). A battle took place here (Aug. 17) in which Sir Arthur Wellesley attacked and drove him from two successive positions. The allied loss was about 500: the French 600 and three guns.¹ On the 20th of August the Allies, strengthened by the arrival of two more brigades (4000 men), occupied some heights north of Vimiera (Vimeira or Vimeiro) where the roads branch off to Torres Vedras and Mafra. Wellesley meant to turn the defile of Torres Vedras by Mafra at once if possible; but on this night Sir Harry Burrard, his senior, arrived off Vimiera, and though he did not land, gave instructions to wait for Sir John Moore. On the 21st of August the Allies were attacked by Junot at Vimiera, who, leaving a force at Lisbon, had come up to reinforce Delaborde. In this battle the Allies

Battle of Vimiera, August 21, 1808. numbered about 18,000 with 18 guns, French nearly 14,000, with 20 guns. Junot, believing the allied left to be weakly held, attacked it without reconnoitring, but Wellesley's regiments, marched thither behind the heights, sprang up in line; and under their volleys and bayonet charge, supported by artillery fire, Junot's deep columns were driven off the direct road to Lisbon. The losses were: Allies about 800, French 2000 and 13 guns. It was now again Wellesley's wish to advance and seize Torres Vedras; but Sir Hew Dalrymple, having at this moment assumed command, decided otherwise. On the 2nd of August Junot, knowing of the approach of Moore with reinforcements, and afraid of a revolt in Lisbon, opened negotiations, which resulted in the Convention of Cintra² (Aug. 30, 1808), under which the French evacuated Portugal, on condition that they were sent with their artillery and arms to France. Thus this campaign had been rapidly brought to a satisfactory conclusion; and Sir Arthur Wellesley had already given proof of his exceptional gifts as a leader. In England however a cry was raised that Junot should have been forced to an absolutely unconditional surrender; and Sir Arthur Wellesley, Sir Hew Dalrymple and Sir Harry Burrard³ were brought before a court of inquiry in London. This acquitted them of blame, and Sir John Moore in the meantime after the departure of Dalrymple (Oct. 6, 1808) had assumed command of the allied army in Portugal, now about 32,000 strong.

Moore's Campaign in Spain, 1808-9.—The British government notified to Sir John Moore that some 10,000 men were to be sent to Corunna under Sir David Baird; that he, with 20,000, was to join him, and then both act in concert with the Spanish armies. As the conduct of this campaign was largely influenced by the operations of the Spanish forces, it is necessary to mention their positions, and also the fact that greater reliance had been placed, both in England and Spain, upon them than future events justified. On the 26th of October 1808, when Moore's troops had left Lisbon to join Baird, the French still held a defensive position behind the Ebro; Bessières being in the basin of Vitoria, Marshal Ney north-west of Logroño, and Monecy covering Pampluna, and near Sanguesa. With the garrisons of Biscay, Navarre, and a reserve at Bayonne, their strength was about 75,000 men. Palafox (20,000) was near Saragossa and observing Sanguesa; Castaños with the victors of Baylen

(34,000) west and south of Tudela and near Logroño; Blake (32,000) east of Reynosa, having captured Bilbao; Count de Belvedere (11,000) near Burgos; reserves (57,000) were assembling about Segovia, Talavera and Cordova; Catalonia was held by 23,000, and Madrid had been reoccupied.

Moore had to decide whether to join Baird by sea or land. To do so by sea at this season was to risk delay, while in moving by land he would have the Spanish armies between him and the French. For these reasons he marched by land; and as the roads north of the Tagus were deemed impassable for guns, while transport and supplies for a large force were also difficult to procure, he sent Sir John Hope, with the artillery, cavalry and reserve ammunition column, south of the river, through Badajoz to Almaraz, to move thence through Talavera, Madrid and the Escorial Pass, involving a considerable détour; while he himself with the infantry; marching by successive divisions, took the shorter roads north of the Tagus through Coimbra and Almeida, and also by Alcantara and Coria to Ciudad Rodrigo and Salamanca. Baird was to move south through Galicia to meet him, and the army was to concentrate at Valladolid, Burgos, or whatever point might seem later on to be best. But as Moore was moving forward, the whole situation in Spain changed. Napoleon's forces, now increased to some 200,000 men present and more following, were assuming the offensive, and he himself on the 30th of October—had left Paris to place himself at their head. Before them the Spaniards were routed in every direction: Castaños was defeated near Logroño (Oct. 27); Castaños and Palafox at Tudela (Nov. 23); Blake at Zornoza (Oct. 29), Espinosa (Nov. 11) and Reynosa (Nov. 13); and Belvedere at Gamonal, near Burgos (Nov. 10). Thus when Moore reached Salamanca (Nov. 28) Baird was at Astorga; Hope at the Escorial Pass; Napoleon himself at Aranda; and French troops at Valladolid, Arealvo and Segovia; so that the French were nearer than either Baird or Hope to Moore at Salamanca. Moore was ignorant of their exact position and strength, but he knew that Valladolid had been occupied, and so his first orders were that Baird should fall back to Galicia and Hope to Portugal. But these were soon changed, and he now took the important resolution of striking a blow for Spain, and for the defenders of Madrid, by attacking Napoleon's communications with France. Hope having joined him through Avila, and magazines having been formed at Benavente, Astorga and Lugo, in case of retreat in that direction, he moved forward, and on the 13th of December approached the Douro, at and near Rueda east of Toro. Here he learnt that Madrid had fallen to Napoleon (Dec. 3) after he had by a brilliant charge of the Polish lancers and chasseurs of the Guard forced the Somosierra Pass (Nov. 30) and in another action stormed the Retiro commanding Madrid itself (Dec. 3); that the French were pressing on towards Lisbon and Andalusia; that Napoleon was unaware of his vicinity, and that Soult's corps, isolated on the Carrion River, had been ordered towards Benavente. He then finally decided to attack Soult (intending subsequently to fall back through Galicia) and ordered up transports from Lisbon to Corunna and Vigo; thus changing his base from Portugal to the north-west of Spain; Blake's Spanish army, now rallying under the marquis de la Romana near Leon, was to co-operate, but was able to give little effective aid.

On the 20th of December Baird joined Moore near Mayorga, and a brilliant cavalry combat now took place at Sahagun, in which the British hussar brigade distinguished itself. But on the 23rd of December, when Moore was at Sahagun and about to attack Soult, he learnt that overwhelming French forces were hastening towards him, so withdrew across the Esla, near Benevente (Dec. 28), destroying the bridge there. Napoleon, directly he realized Moore's proximity, had ordered Soult to Astorga to cut him off from Galicia; recalled his other troops from their march towards Lisbon and Andalusia, and, with 50,000 men and 150 guns, had left Madrid himself (Dec. 22). He traversed over 100 m. in less than five days across the snow-covered Escorial Pass, reaching Tortosillas on the Douro on the 26th of December. Hence he wrote to Soult, "If the English

¹ In this account of the war the losses and numbers engaged in different battles are given approximately only; and the former include killed, wounded and missing. Historians differ much on these matters.

² It was not, however, signed at Cintra, but at Lisbon, and was mainly negotiated near Torres Vedras.

³ The two latter were recalled from the Peninsula; Sir Arthur Wellesley had proceeded to London upon leave, and had only signed the armistice with Junot, not the convention itself.

pass to-day in their position (which he believed to be Sahagun) they are lost." But Moore had passed Astorga by the 31st of December, where Napoleon arrived on the 1st of January 1809. Thence he turned back, with a large portion of his army towards France, leaving Soult with over 40,000 men to follow Moore.

On the "Retreat to Corunna" fatigue, wet and bitter cold, combined with the sense of an enforced retreat, shook the discipline of Moore's army; but he reached Corunna on the 11th of January 1809, where he took up a position across the road from Lugo, with his left on the river Mero. On the 14th of January the transports arrived; and on the 16th Soult attacked.

Battle of Corunna, January 16, 1809. In this battle the French numbered about 20,000 with 40 guns; the British 15,000 with 9 very light guns. Soult failed to dislodge the British, and Moore was about to deliver a counter-attack when he himself fell mortally wounded. Baird was also wounded, and as night was approaching, Hope suspended the advance, and subsequently embarked the army, with scarcely any further loss. The British casualties were about 2000, the French 2000. When the troops landed in England, half clothed and half shod, their leader's conduct of the campaign was at first blamed, but his reputation as a general rests solidly upon these facts, that when Napoleon in person, having nearly 300,000 men in Spain, had stretched forth his hand to seize Portugal and Andalusia, Moore with 30,000, forced him to withdraw it, and follow him to Corunna, escaping at the same time from his grasp. Certainly a notable achievement.

Campaign in Portugal and Spain, 1809.—On the 22nd of April 1809 Sir Arthur Wellesley reached Lisbon. By this time, French armies, to a great extent controlled by Napoleon from a distance, had advanced—Soult from Galicia to capture Oporto and Lisbon (with General Lapisse from Salamanca moving on his left towards Abrantes) and Marshal Victor, still farther to the left, with a siege train to take Badajoz, Merida and subsequently Cadiz. Soult (over 20,000), leaving Ney in Galicia, had taken and sacked Oporto (March 29, 1809); but the Portuguese having closed upon his rear and occupied Vigo, he halted, detaching a force to Amarante to keep open the road to Braganza and asked for reinforcements. Victor had crossed the Tagus, and defeated Cuesta at Medellin (March 28, 1809); but, surrounded by insurgents, he also had halted; Lapisse had joined him, and together they were near Merida, 30,000 strong. On the allied side the British (25,000), including some German auxiliaries, were about Leiria; the Portuguese regular troops (16,000) near Thomar; and some thousands of Portuguese militia were observing Soult in the north of Portugal, a body under Silveira being at Amarante, which Soult was now approaching. Much progress had been made in the organization and training of the Portuguese levies; Major-General William Carr Beresford, with the rank of marshal, was placed at their head. Of the Spaniards, Palafox, after his defeat at Tudela had most gallantly defended Saragossa a second time (Dec. 20, 1808—Feb. 20, 1809); the Catalonians, after reverses at Molins de Rey (Dec. 21, 1808) and at Valis (Feb. 25, 1809) had taken refuge in Tarragona; and Rosas had fallen (Dec. 5, 1808) to the French general Gouvion St Cyr who, having relieved Barcelona, was besieging Gerona. Romaña's force was now near Orense in Galicia. A supreme junta had been formed which could nominally assemble about 100,000 men, but jealousy among its members was rife, and they still declined to appoint any commander-in-chief.

On the 5th of May 1809, Wellesley moved towards the river Douro, having detached Beresford to seize Amarante, from which the French had now driven Silveira. Soult expected the passage of the Douro to be attempted near its mouth, with fishing craft; but Wellesley, by a daring surprise, crossed (May 12) close above Oporto, and also by a ford higher up. After some fighting Oporto was taken, and Soult driven back. The Portuguese being in his rear, and Wellesley closing with him, the only good road of retreat available lay through Amarante, but he now learned that Beresford had taken this important point from Silveira; so he was then compelled, abandoning his guns and

much baggage, to escape, with a loss of some 5000 men, over the mountains of the Sierra Catalina to Salamonde, and thence to Orense.

During the above operations, Victor, with Lapisse, had forced the passage of the Tagus at Alcantara but, on Wellesley returning to Abrantes, he retired. News having been received that Napoleon had suffered a serious check at the battle of Aspern, near Vienna (May 22, 1809), Wellesley next determined—leaving Beresford (20,000) near Ciudad Rodrigo—to move with 22,000 men, in conjunction with Cuesta's Spanish army (40,000) towards Madrid against Victor, who, with 25,000 supported by King Joseph (50,000) covering the capital, was near Talavera. Sir Robert Wilson with 4000 Portuguese from Salamanca, and a Spanish force under Venegas (25,000) from Carolina, were to co-operate and occupy Joseph, by closing upon Madrid. Cuesta, during the advance up the valley of the Tagus, was to occupy the pass of Baños on the left flank; the Spanish authorities were to supply provisions, and Venegas was to be at Arganda, near Madrid, by the 22nd or 23rd of July; but none of these arrangements were duly carried out, and it was on this that the remainder of the campaign turned. Writing to Soult from Austria, Napoleon had placed the corps of Ney and Mortier under his orders, and said: "Wellesley will most likely advance by the Tagus against Madrid; in that case, pass the mountains, fall on his flank and rear, and crush him."

By the 20th of July Cuesta had joined Wellesley at Oropesa; and both then moved forward to Talavera, Victor falling back before them: but Cuesta, irritable and jealous, would not work cordially with Wellesley; Venegas—*Battle of Talavera, July 27, 28, 1809.* counter-ordered it is said by the Spanish junta—did not go to Arganda, and Wilson, though he advanced close to Madrid, was forced to retire, so that Joseph joined Victor, and the united force attacked the Allies at Talavera de la Reina on the Tagus. The battle lasted for two days, and ended in the defeat of the French, who fell back towards Madrid.¹ Owing to want of supplies, the British had fought in a half-starved condition; and Wellesley now learnt to his surprise that Soult had passed the mountains and was in his rear. Having turned about, he was on the march to attack him, when he heard (Aug. 23) that not Soult's corps alone, but three French corps, had come through the pass of Baños without opposition; that Soult himself was at Naval Moral, between him and the bridge of Almaraz on the Tagus, and that Cuesta was retreating from Talavera. Wellesley's force was now in a dangerous position: but by withdrawing at once across the Tagus at Arzobispo, he reached Jaraicejo and Almaraz (by the south bank) blowing up the bridge at Almaraz, and thence moved, through Merida, northwards to the banks of the Agueda, commencing to fortify the country around Lisbon.

Elsewhere in the Peninsula during this year, Blake, now in Catalonia, after routing Suchet at Alcaniz (May 23, 1809), was defeated by him at Maria (June 15) and at Belchite (June 18); Venegas, by King Joseph and Sébastiani, at Almonacid on the 11th of August; Del Parque (20,000), after a previous victory near Salamanca (Oct. 18), was overthrown at Alba de Tormes by General Marchand (Nov. 28): the old forces of Venegas and Cuesta (50,000), now united under Arceizaga, were decisively routed by King Joseph at Ocaña (Nov. 19); and Gerona after a gallant defence, had surrendered to Augereau (Dec. 10).

Sir Arthur Wellesley was for this campaign created Baron Douro and Viscount Wellington. He was made captain-general by Spain, and marshal-general by Portugal. But his experience after Talavera had been akin to that of Moore; his expectations from the Spaniards had not been realized; he had been almost intercepted by the French, and he had narrowly escaped from a critical position. Henceforth he resisted all proposals for joint operations, on any large scale, with Spanish armies not under his own direct command.

¹ After the battle the Light Division, under Robert Crauford, joined Wellesley. In the endeavour to reach the field in time it had covered, in heavy marching order, over 50 m. in 25 hours, in hot July weather.

Campaign in Portugal, 1810.—Napoleon, having avenged Aspern by the victory of Wagram (July 6, 1809), despatched to Spain large reinforcements destined to increase his army there to about 370,000 men. Marshal Masséna with 120,000, including the corps of Ney, Junot, Reynier and some of the Imperial Guard, was to operate from Salamanca against Portugal; but first Soult, appointed major-general of the army in Spain (equivalent to chief of the staff), was, with the corps of Victor, Mortier and Sébastiani (70,000), to reduce Andalusia. Soult (Jan. 31, 1810) occupied Seville and escaping thence to Cadiz, the Supreme Junta resigned its powers to a regency of five members (Feb. 2, 1810). Cadiz was invested by Victor's corps (Feb. 4), and then Soult halted, waiting for Masséna, who arrived at Valladolid on the 15th of May.

In England a party in parliament were urging the withdrawal of the British troops, and any reverse to the allied arms would have strengthened its hands. Wellington's policy was thus cautious and defensive, and he had already commenced the since famous lines of Torres Vedras round Lisbon. In June 1810 his headquarters were at Celorico. With about 35,000 British, 30,000 Portuguese regular troops and 30,400 Portuguese militia, he watched the roads leading into Portugal past Ciudad Rodrigo to the north, and Badajoz to the south of the Tagus, as also the line of the Douro and the country between the Elga and the Ponsul.

Soult having been instructed to co-operate by taking Badajoz and Elvas, Masséna, early in June 1810, moved forward, and Ciudad Rodrigo surrendered to him (June 10). Next pushing back a British force under Craufurd, he invested Almeida, taking it on the 27th of August. Then calling up Reynier, who during this had moved on his left towards Alcantara, he marched down the right bank of the Mondego, and entered Viseu (Sept. 21). Wellington fell back before him down the left bank, ordering up Rowland Hill's force from the Badajoz road, the peasantry having been previously called upon to destroy their crops and retire within the lines of Torres Vedras. A little north of Coimbra, the road which Masséna followed crossed the Sierra de Bussaco (Busaco), a very strong position where Wellington resolved to offer him battle. Masséna, superior in numbers and over-confident, made a direct attack upon the heights on the 27th of September 1810: his

strength being about 60,000, while that of the Allies was about 50,000, of whom nearly half were Portuguese. After a stern conflict the French were repulsed, the loss being five generals and nearly 5000 men, while the Allies lost about 1300. The next day Masséna turned the Sierra by the Boyalva Pass and Sardoal, which latter place, owing to an error, had not been occupied by the Portuguese, and Wellington then retreated by Coimbra and Leiria to the lines, which he entered on the 11th of October, having within them fully 100,000 able-bodied men.

The celebrated "Lines of Torres Vedras" were defensive works designed to resist any army which Napoleon could send against them. They consisted of three great lines strengthened by about 150 redoubts, and earthworks of various descriptions, mounting some 600 cannon; the outer line, nearly 30 m. long, stretching over heights north of Lisbon, from the Tagus to the sea. As Masséna advanced, the Portuguese closing upon his rear retook Coimbra (Oct. 7), and when he neared the lines, astounded at their strength, he sent General Foy to the emperor to ask for reinforcements. After an effort, defeated by Hill, to cross the Tagus, he withdrew (Nov. 15) to Santarem. This practically closed Wellington's operations for the year 1810, his policy now being not to lose men in battle, but to reduce Masséna by hunger and distress.

In other parts of Spain, Augereau had taken Hostalrich (May 10); captured Lerida (May 14); Mequinenza (June 8); and invested Tortosa (Dec. 15). The Spanish levies had been unable to contribute much aid to the Allies; the French having subdued almost all Spain, and being now in possession of Ciudad Rodrigo and Almeida. On the other hand Wellington still held Lisbon with parts of Portugal, Elvas and Badajoz, for Soult had not felt disposed to attempt the capture of the last two fortresses.

Campaign of 1811.—Napoleon, whose attention was now directed towards Russia, refused to reinforce Masséna, but enjoined Soult to aid him by moving against Badajoz. Soult, therefore, leaving Victor before Cadiz, invested Badajoz (Jan. 26, 1811) and took it from the Spaniards (March 10). With the hope of raising the blockade of Cadiz, a force under Sir Thomas Graham (afterwards Lord Lynedoch [q.v.]) left that harbour by sea, and joining with Spanish troops near Tarifa, advanced by land against Victor's blockading force, a Spanish general, La Peña, being in chief command. As they neared Barrosa, Victor attacked them, the Allies numbering in the battle about 13,000 with 24 guns, 4000 being British; the French 9000, actually engaged, with 14 guns; but with 5000 more a few miles off and others in the French lines. Hard fighting, chiefly between the French and British, now ensued, and at one time the Barrosa ridge, the key of the position left by La Peña's orders, practically undefended, fell into the French hands; but Graham by a resolute counter-attack regained it, and Victor was in the end driven back. La Peña, who had in the battle itself failed to give proper support to Graham, would not pursue, and Graham declining to carry on further operations with him, re-entered Cadiz. The French afterwards resumed the blockade, so that although Barrosa was an allied victory, its object was not attained. The British loss was about 1200; the French 2000, 6 guns and an eagle.

On the day of the above battle Masséna, having destroyed what guns he could not horse, and skilfully gained time by a feint against Abrantes, began his retreat from before the lines, through Coimbra and Espinhal. His army was in serious distress; he was in want of food and supplies; most of his horses were dead, and his men were deserting. Wellington followed, directing the Portuguese to remove all boats from the Mondego and Douro, and to break up roads north of the former river. Beresford was detached to succour Badajoz, but was soon recalled, as it had fallen to Soult. Ney, commanding Masséna's rearguard, conducted the retreat with great ability. In the pursuit, Wellington adhered to his policy of husbanding his troops for future offensive operations, and let sickness and hunger do the work of the sword. This they effectually did. Nothing could well exceed the horrors of Masséna's retreat. Rearguard actions were fought at Pombal (March 10), Redinha (March 12) and Condeixa (March 13). Here Ney was directed to make a firm stand; but, ascertaining that the Portuguese were at Coimbra and the bridge there broken, and fearing to be cut off also from Murcella, he burnt Condeixa, and marched to Casal Nova. An action took place here (March 14) and at Foz d'Arouce (March 15). Wellington now sent off Beresford with a force to retake Badajoz; and Masséna, sacrificing much of his baggage and ammunition, reached Celorico and Guarda (March 21). Here he was attacked by Wellington (March 20) and, after a further engagement at Sabugal (April 3, 1811), he fell back through Ciudad de Salamanca, having lost in Portugal nearly 30,000 men, chiefly from want and disease, and 6000 in the retreat alone.

The key to the remaining operations of 1811 lies in the importance attached by both Allies and French to the possession of the fortresses which guarded the two great roads from Portugal into Spain—Almeida and Ciudad Rodrigo on the northern, and Badajoz and Elvas on the southern road; all these except Elvas were in French hands. Wellington, on the 9th of April 1811, directed General Spencer to invest Almeida; he then set off himself to join Beresford before Badajoz, but after reconnoitring the fortress with his lieutenant he had at once to return north on the news that Masséna was moving to relieve Almeida. On the 3rd of May Loison attacked him at Fuentes d'Onor near Almeida, and Masséna coming up himself made a more serious attack on the 5th of May. The Allies numbered about 33,000, with 42 guns; the French 45,000 with 30 guns. The battle is chiefly notable for the steadiness with which the allied right, covered by the Light Division in squares, changed position in presence of the French

Battle of Barrosa, March 6, 1811.

Masséna's Retreat.

Lines of Torres Vedras, 1808-11.

Battle of Fuentes d'Onor, May 6, 1811.

cavalry; and for the extraordinary feat of arms of Captain Norman Ramsay, R.H.A., in charging through the French cavalry with his guns. Masséna failed to dislodge the Allies, and on the 8th of May withdrew to Salamanca, Almeida falling to Wellington on the 11th of May 1811. The allied loss in the fighting on both days at Fuentes d'Onor was about 1500: the French 3000.

In the meantime Soult (with 23,000 men and 50 guns), advancing to relieve Badajoz, compelled Beresford to suspend the siege, and to take up a position with about 30,000 men (of whom 7000 were British) and 38 guns behind the river Albuera (or Albuera). Here Soult attacked him on the 16th of May. An unusually bloody battle ensued, in which the French efforts were chiefly directed against the allied right, held by the Spaniards. At one time the right appeared to be broken, and 6 guns were lost, when a gallant advance of Sir Lowry Cole's division restored the day, Soult then falling back towards Seville. The allied loss was about 7000 (including about half the British force); the French about 8000.

After this Wellington from Almeida rejoined Beresford and the siege of Badajoz was continued: but now Marshal Marmont, having succeeded Masséna, was marching southwards to join Soult, and, two allied assaults of Badajoz having failed, Wellington withdrew. Subsequently, leaving Hill in the Alentejo, he returned towards Almeida, and with 40,000 men commenced a blockade of Ciudad Rodrigo, his headquarters being at Fuente Guinaldo. Soult and Marmont now fell back, the former to Seville, the latter to the valley of the Tagus, south of the pass of Baños.

In September, Marmont joined with the army of the north under General Dorsenne, coming from Salamanca—their total force being 60,000, with 100 guns—and succeeded (Sept. 25) in introducing a convoy of provisions into Ciudad Rodrigo. Before so superior a force, Wellington had not attempted to maintain the blockade; but on Marmont afterwards advancing towards him, he fought a rearguard action with him at El Bodon (Sept. 25), notable, as was Fuentes d'Onor, for the coolness with which the allied squares retired amidst the enemy's horsemen; and again at Fuente Guinaldo (Sept. 25 and 26) he maintained for 30 hours, with 15,000 men, a bold front against Marmont's army of 60,000, in order to save the Light Division from being cut off. At Aldea de Ponte there was a further sharp engagement (Sept. 27), but Wellington taking up a strong position near Sabugal, Marmont and Dorsenne withdrew once more to the valley of the Tagus and Salamanca respectively, and Wellington again blockaded Ciudad Rodrigo.

Thus terminated the main operations of this year. On the 28th of October 1811, Hill, by a very skillful surprise, captured Arroyo de los Molinos (between Badajoz and Trujillo), almost annihilating a French corps under Gérard; and in December 1811 the French were repulsed in their efforts to capture Tarifa near Cadiz. In the east of Spain Suchet took Tortosa (Jan. 1, 1811); Tarragona (June 28); and Murviedro (Oct. 26), defeating Blake's relieving force, which then took refuge in Valencia. Macdonald also retook Figueras which the Spaniards had taken on the 9th of April 1811 (Aug. 19). Portugal had now been freed from the French, but they still held Ciudad Rodrigo and Badajoz, the two main gates into Spain.

Campaign in Spain, 1812.—The campaign of 1812 marks an important stage in the war. Napoleon, with the Russian War in prospect, had early in the year withdrawn 30,000 men from Spain; and Wellington had begun to carry on what he termed a war of "magazines." Based on rivers (the navigation of which greatly improved) and the sea, he formed dépôts or magazines of provisions at many points, which enabled him always to take and keep the field. The French, on the other hand, had great difficulty in establishing any such reserves of food, owing to their practice of depending for sustenance entirely upon the country in which they were quartered. Wellington assumed the offensive, and by various movements and feints, aided the guerrilla bands by forcing the French corps to assemble in their

districts, which not only greatly harassed them but also materially hindered the combination of their corps for concerted action. Having secretly got a battering train into Almeida and directed Hill, as a blind, to engage Soult by threatening Badajoz, he suddenly (Jan. 8, 1812) besieged Ciudad Rodrigo.

The French, still numbering nearly 200,000, now held the following positions: the Army of the North—Dorsenne (48,000)—was about the Pisuerga, in the Asturias, and along the northern coast; the Army of Portugal—Marmont (50,000)—mainly in the valley of the Tagus, but ordered to Salamanca; the Army of the South—Soult (55,000)—in Andalusia; the Army of the Centre—Joseph (19,000)—about Madrid.

The siege of Ciudad Rodrigo was calculated in the ordinary course to require twenty-four days; but on it becoming known that Marmont was moving northward, the assault was delivered after twelve days only (Jan. 19). The gallantry of the troops made it successful, though with the loss of Generals Craufurd and McKinnon, and 1300 men, and Marmont's battering train of 150 guns here fell into the allied hands. Then, after a feint of passing on into Spain, Wellington rapidly marched south and, with 22,000 men, laid siege to Badajoz (March 17, 1812), Hill with 30,000 covering the siege near Merida. Wellington was hampered by want of time, and had to assault prematurely. Soult and Marmont having begun to move to relieve the garrison, the assault was delivered on the night of the 7th of April, and though the assailants failed at the breaches, the carnage at which was terrible, a very daring escalade of one of the bastions and of the castle succeeded, and Badajoz fell, Soult's pontoon train being taken in it. After the assault, some deplorable excesses were committed by the victorious troops. The allied loss was 3600 in the assault alone and 5000 in the entire siege.

The Allies had now got possession of the two great gates into Spain; and Hill, by an enterprise most skillfully carried out, destroyed (May 19) the Tagus bridge at Almaraz, by which Soult to the south of the river chiefly communicated with Marmont to the north. Wellington then, ostentatiously making preparations to enter Spain by the Badajoz line, once more turned northward, crossed the Tormes (June 17, 1812), and advanced to the Douro, behind which the French were drawn up. Marmont had erected at Salamanca some strong forts, the reduction of which occupied Wellington ten days, and cost him 600 men. The Allies and French now faced each other along the Douro to the Pisuerga. The river was high, and Wellington hoped that want of supplies would compel Marmont to retire, but in this he was disappointed.

On the 15th of July 1812, Marmont, after a feint against Wellington's left, suddenly, by a forced march, turned his right, and made rapidly towards the fords of Huerta and Alba on the Tormes. Some interesting manœuvres now took place, Wellington moving parallel and close to Marmont, but more to the north, making for the fords of Aldea Lengua and Santa Marta on the Tormes nearer to Salamanca, and being under the belief that the Spaniards held the castle and ford at Alba on that river. But Marmont's manœuvring and marching power had been underestimated, and on the 21st of July while Wellington's position covered Salamanca, and but indirectly his line of communications through Ciudad Rodrigo, Marmont had reached a point from which he hoped to interpose between Wellington and Portugal, on the Ciudad Rodrigo road. This he endeavoured to do on the 22nd of July 1812, which brought on the important battle of Salamanca (q.v.) in which Wellington gained a decisive victory, the French falling back to Valladolid and thence to Burgos. Wellington entered Valladolid (July 30), and thence marched against Joseph, who (July 27) had reached Blasco Sancho with reinforcements for Marmont. Joseph retired before him, and Wellington entered Madrid (Aug. 12, 1812), where, in the Retiro, 1700 men, 180 cannon, two eagles, and a quantity of stores were captured. Soult now raised the siege of Cadiz (Aug. 26), and evacuating Andalusia joined Suchet

with some 55,000 men. Wellington then brought up Hill to Madrid.

On the 1st of September 1812, the French armies having begun once more to collect together, Wellington marched against the Army of the North, now under General Clausel, and laid siege to the castle of Burgos (Sept. 19) to secure the road towards Santander on the coast. But the strength of the castle had been underrated; Wellington had insufficient siege equipment and transport for heavy guns; five assaults failed, and Soult (having left Suchet in Valencia) and also the Army of Portugal were both approaching, so Wellington withdrew on the night of

the 21st of October, and, directing the evacuation of Madrid, commenced the "Retreat from Burgos." In this retreat, although military operations were skilfully conducted, the Allies lost 7000 men, and discipline, as in that to Corunna, became much relaxed.

By November 1812, Hill having joined him at Salamanca, Wellington once more had gone into cantonments near Ciudad Rodrigo, and the French armies had again scattered for convenience of supply. In spite of the failure before Burgos, the successes of the campaign had been brilliant. In addition to the decisive victory of Salamanca, Madrid had been occupied, the siege of Cadiz raised, Andalusia freed, and Ciudad Rodrigo and Badajoz stormed. Early in January also the French had abandoned the siege of Tarifa, though Valencia had surrendered to them (Jan. 9). One important result of the campaign was that the Spanish Cortes nominated Wellington (Sept. 22, 1812) to the unfettered command of the Spanish armies. For the operations of this campaign Wellington was created earl, and subsequently marquis of Wellington; duke of Ciudad Rodrigo by Spain, and marquis of Torres Vedras by Portugal.

Campaign in Spain and the South of France, 1813.—At the opening of 1813, Suchet, with 63,000 men, had been left to hold Valencia, Aragon and Catalonia; and the remainder of the French (about 137,000) occupied Leon, the central provinces and Biscay, guarding also the communications with France. Of these about 60,000 under Joseph were more immediately opposed to Wellington, and posted, in scattered detachments, from Toledo and Madrid behind the Tormes to the Douro, and along that river to the Esla. Wellington had further organized the Spanish forces—Castaños (40,000), with the guerrilla bands of Mina, Longa and others, was in Galicia, the Asturias and northern Spain; Copons (10,000) in Catalonia; Elio (20,000) in Murcia; Del Parque (12,000) in the Sierra Morena, and O'Donnell (15,000) in Andalusia. More Portuguese troops had been raised, and reinforcements received from England, so that the Allies, without the Spaniards above alluded to, now numbered some 75,000 men, and from near the Coa watched the Douro and Tormes, their line stretching from their left near Lamego to the pass of Baños, Hill being on the right. The district of the Traso-Montes, north of the Douro, about the Tamega, Tua and Sabor, was so rugged that Wellington was convinced that Joseph would expect him to advance by the south of the river. He therefore, moving by the south bank himself with Hill, to confirm Joseph in this expectation, crossed the Tormes near and above Salamanca, having previously—which was to be the decisive movement—detached Graham, with 40,000 men, to make his way, through the difficult district above mentioned, towards Braganza, and then, joining with the Spaniards, to turn Joseph's right. Graham, crossing the Douro near Lamego, carried out his laborious march with great energy, and Joseph retired precipitately from the Douro, behind the Pisuegra. The allied army, raised by the junction of the Spanish troops in Galicia to 90,000, now concentrated near Toro, and moved towards the Pisuegra, when Joseph, blowing up the castle of Burgos, fell back behind the Ebro. Once more Wellington turned his right, by a sweeping movement through Rocamunde and Puente Arenas near the source of the Ebro, when he retreated behind the Zadorra near the town of Vitoria.

Santander was now evacuated by the French, and the allied line of communications was changed to that port. On the 20th

of June Wellington encamped along the river Bayas, and the next day attacked Joseph. For a description of the decisive battle of Vitoria (June 21, 1813), see VITORIA. In it King Joseph met with a crushing defeat, and, after it, the wreck of his army, cut off from the Vitoria-Bayonne road, escaped towards Pampeluna. Within a few days Madrid was evacuated, and all the French forces, with the exception of the garrisons of San Sebastian (3000), Pampeluna (3000), Santona (1500), and the troops under Suchet holding posts in Catalonia and Valencia, had retired across the Pyrenees into France. The Spanish peninsula was, to all intents and purposes, free from foreign domination, although the war was yet far from concluded. The French struggled gallantly to the close; but now a long succession of their leaders—Junot, Soult, Victor, Masséna, Marmont, Joseph—had been in turn forced to recoil before Wellington; and while their troops fought henceforward under the depressing memory of many defeats, the Allies did so under the inspiring influence of great successes, and with that absolute confidence in their chief which doubled their fighting power.

For this decisive campaign, Wellington was made a field marshal in the British army, and created duke of Victory¹ by the Portuguese government in Brazil. He now, with about 80,000 men, took up a position with his left (the Spaniards) on the Bidassoa near San Sebastian. Thence his line stretched along the Pyrenees by the passes of Vera, Echallar, Maya and Roncesvalles, to Altbiscar; his immediate object now being to reduce the fortresses of San Sebastian and Pampeluna. Not having sufficient *matériel* for two sieges, he laid siege to San Sebastian only, and blockaded Pampeluna. Sir Thomas Graham commenced the active siege of San Sebastian on the 10th of July 1813, but as Soult was approaching to its relief, the assault was ordered for daylight on the 24th. Unfortunately a conflagration breaking out near the breaches caused it to be postponed until nightfall, when, the breaches in the interval having been strengthened, it was delivered unsuccessfully and with heavy loss. Wellington then suspended the siege in order to meet Soult, who endeavoured (July 25) to turn the allied right, and reach Pampeluna: Attacking the passes of Maya and Roncesvalles, he obliged their defenders to retire, after sharp fighting, to a position close to Sorauren, which, with 25,000 men, he attempted to carry (July 28). By this time Wellington had reached it from the allied left; reinforcements were pressing up on both sides, and about 12,000 allied troops faced the French. A struggle, described by Wellington as "bludgeon work," now ensued, but all efforts to dislodge the Allies having failed, Soult, withdrawing, manœuvred to his right towards San Sebastian. Wellington now assumed the offensive, and, in a series of engagements, drove the French back (Aug. 2) beyond the Pyrenees. These included Roncesvalles and Maya (July 25); Sorauren (July 28 and 30); Yanzi (Aug. 1); and Echallar and Ivantelly (Aug. 2), the total losses in them being about—Allies under 7000, French 10,000. After this, Wellington renewing the siege of San Sebastian carried the place, excepting the castle, after a heavy expenditure of life (Aug. 31). Upon the day of its fall Soult attempted to relieve it, but in the combats of Vera and St Marcial was repulsed. The castle surrendered on the 9th of September, 1813, the losses in the entire siege having been about—

Allies 4000, French 2000. Wellington next determined to throw his left across the river Bidassoa to strengthen his own position, and secure the port of Fuenterabía.

Now commenced a series of celebrated river passages, which had to be effected prior to the further invasion of France. At daylight on the 7th of October 1813 he crossed the Bidassoa in seven columns, and attacked the entire French position, which stretched in two heavily entrenched lines from north

¹ *Duque da Victoria*, often incorrectly duke of Vitoria. The coincidence of the title with the place-name of the battle which had not yet been fought when the title was conferred, is curious, but accidental.

of the Irun-Bayonne road, along mountain spurs to the Great Rhune, 2800 ft. high. The decisive movement was a passage in strength near Fuenterrabia, to the astonishment of the enemy, who in view of the width of the river and the shifting sands, had thought the crossing impossible at that point. The French right was then rolled back, and Soult was unable to reinforce his right in time to retrieve the day. His works fell in succession after hard fighting, and he withdrew towards the river Nivelle. The loss was about—Allies, 1600; French, 1400. The passage of the Bidassoa "was a general's not a soldiers' battle" (Napier).

On the 31st of October Pampeluna surrendered, and Wellington was now anxious to drive Suchet from Catalonia before further invading France. The British government, however, in the interests of the continental powers, urged an immediate advance, so on the night of the 9th of November 1813 he brought up his right from the Pyrenean passes to the northward of Maya and towards the Nivelle. Soult's army (about 79,000), in three entrenched lines, stretched from the sea in front of St Jean de Luz along commanding ground to Amotz and thence, behind the river, to Mont Mondarin near the Nive. Each army had with it about 700 guns; and, during a heavy cannonade, Wellington on the 10th of November 1813 attacked this extended

position of 16 m. in five columns, these being so directed that after carrying Soult's advanced works a mass of about 50,000 men converged towards the French centre near Amotz, where, after hard fighting, it swept away the 18,000 of the second line there opposed to it, cutting Soult's army in two. The French right then fell back to St Jean de Luz, the left towards points on the Nive. It was now late and the Allies, after moving a few miles down both banks of the Nivelle, bivouacked, while Soult, taking advantage of the respite, withdrew in the night to Bayonne. The allied loss was about 2700; that of the French 4000, 51 guns, and all their magazines. The next day Wellington closed in upon Bayonne from the sea to the left bank of the Nive.

After this there was a period of comparative inaction, though during it the French were driven from the bridges at Urdains and Cambó. The weather had become bad, and the Nive unfordable; but there were additional and serious causes of delay. The Portuguese and Spanish authorities were neglecting the payment and supply of their troops. Wellington had also difficulties of a similar kind with his own government, and also the Spanish soldiers, in revenge for many French outrages, had become guilty of grave excesses in France, so that Wellington took the extreme step of sending 25,000 of them back to Spain and resigning the command of their army, though his resignation was subsequently withdrawn. So great was the tension at this crisis that a rupture with Spain seemed possible. These matters, however, having been at length adjusted, Wellington, who in his cramped position between the sea and the Nive could not use his cavalry or artillery effectively, or interfere with the French supplies coming through St Jean Pied de Port, determined to occupy the right as well as the left bank of the Nive. He could not pass to that bank with his whole force while Soult held Bayonne, without exposing his own communications through Irun. Therefore, on the 9th of December 1813, after making a demonstration elsewhere, he effected the passage with a portion of his force only under Hill and Beresford, near Ustaritz and Cambó, his loss being slight, and thence pushed down the river towards Villefranque, where Soult barred his way across the road to Bayonne. The allied army was now divided into two portions by the Nive; and Soult from Bayonne at once took advantage of his central position to attack it with all his available force, first on the left bank and then on the right. On the morning of the 10th of December he fell, with 60,000 men and 40 guns, upon Hope, who with 30,000 men and 24 guns held a position from the sea, 3 m. south of Biarritz on a ridge behind two lakes (or tanks) through Arcangues towards the Nive. Desperate fighting now ensued, but fortunately, owing to the intersected

ground, Soult was compelled to advance slowly, and in the end, Wellington coming up with Beresford from the right bank, the French retired baffled. On the 11th and 12th of December there were engagements of a less severe character, and finally on the 13th of December Soult with 35,000 men made a vehement attack up the right bank of the Nive against Hill, who with about 14,000 men occupied some heights from Villefranque past St Pierre (Lostenia) to Vieux Mogerre. The conflict about St Pierre (Lostenia) was one of the most bloody of the war; but for hours Hill maintained his ground, and finally repulsed the French before Wellington, delayed by his pontoon bridges over the Nive having been swept away, arrived to his aid. The losses in the four days' fighting in the battles before Bayonne (or battles of the Nive) were—Allies about 5000, French about 7000. Both the British and Portuguese artillery, as well as infantry, greatly distinguished themselves in these battles.

In eastern Spain Suchet (April 11, 1813) had defeated Elio's Murcians at Yecla and Villena, but was subsequently routed by Sir John Murray¹ near Castalla (April 13), who then besieged Tarragona. The siege was abandoned after a time, but was later on renewed by Lord W. Bentinck. Suchet, after the battle of Vitoria, evacuated Tarragona (Aug. 17) but defeated Bentinck in the combat of Ordal (Sept. 13).

Campaign in the South of France, 1814.—When operations recommenced in February 1814 the French line extended from Bayonne up the north bank of the Adour to the Pau, thence bending south along the Bidouze to St Palais, with advanced posts on the Joyeuse and at St Jean Pied de Port. Wellington's left, under Hope, watched Bayonne, while Beresford, with Hill, observed the Adour and the Joyeuse, the right trending back till it reached Urcaray on the St Jean Pied de Port road. Exclusive of the garrison of Bayonne and other places, the available field force of Soult numbered about 41,000, while that of the Allies, deducting Hope's force observing Bayonne, was of much the same strength. It had now become Wellington's object to draw Soult away from Bayonne, in order that the allied army might, with less loss, cross the Adour and lay siege to the place on both banks of the river.

At its mouth the Adour was about 500 yds. wide, and its entrance from the sea by small vessels, except in the finest weather, was a perilous undertaking, owing to the shifting sands and a dangerous bar. On the other hand, the deep sandy soil near its banks made the transport of bridging materials by land laborious, and almost certain of discovery. Wellington, convinced that no effort to bridge below Bayonne would be expected, decided to attempt it there, and collected at St Jean Pied de Port and Passages a large number of country vessels (termed *chasse-marees*). Then, leaving Hope with 30,000 men to watch Bayonne, he began an enveloping movement round Soult's left. Hill on the 14th and 15th of February, after a combat at Garris, drove the French posts beyond the Joyeuse; and Wellington then pressed these troops back over the Bidouze and Gave² de Mauleon to the Gave d'Oleron. Wellington's object in this was at once attained, for Soult, leaving only 10,000 men in Bayonne, came out and concentrated at Orthes on the Pau. Then Wellington (Feb. 19) proceeded to St Jean de Luz to superintend the despatch of boats to the Adour. Unfavourable weather, however, compelled him to leave this to Sir John Hope and Admiral Penrose, so returning to the Gave d'Oleron he crossed it, and faced Soult on the Pau (Feb. 25). Hope in the meantime, after feints higher up the Adour, succeeded (Feb. 22 and 23) in passing 600 men across the river in boats. The nature of the ground, and there being no suspicion of an attempt at this point, led to the French coming out very tardily to oppose them; and when they did, some Congreve rockets (then a novelty) threw them into confusion, so that the right bank was held until, on the morning of the 24th, the flotilla of

¹ Commander of a British expedition from the Mediterranean islands.

² "Gave" in the Pyrenees means a mountain stream or torrent.

Passage of the Nive, Dec. 9, 1813.

Passage of the Adour, Feb. 22 to 26, 1814.

chasse-morées appeared from St Jean de Luz, preceded by men-of-war boats. Several men and vessels were lost in crossing the bar; but by noon on the 26th of February the bridge of 26 vessels had been thrown and secured; batteries and a boom placed to protect it, 8000 troops passed over, and the enemy's gunboats driven up the river. Bayonne was then invested on both banks as a preliminary to the siege.

On the 27th of February Wellington, having with little loss effected the passage of the Pau below Orthes, attacked Soult. In this battle the Allies and French were of about equal strength (37,000): the former having 48 guns, the latter 40. Soult held a strong position behind Orthes on heights commanding the roads to Dax and St Sever. Beresford was directed to turn his right, if possible cutting him off from Dax, and Hill his left towards the St Sever road. Beresford's attack, after hard fighting over difficult ground, was repulsed, when Wellington, perceiving that the pursuing French had left a central part of the heights unoccupied, thrust up the Light Division into it, between Soult's right and centre. At the same time Hill, having found a ford above Orthes, was turning the French left, when Soult retreated just in time to save being cut off, withdrawing towards St Sever, which he reached on the 28th of February. The allied loss was about 2000; the French 4000 and 6 guns.

From St Sever Soult turned eastwards to Aire, where he covered the roads to Bordeaux and Toulouse. Beresford, with 12,000 men, was now sent to Bordeaux, which opened its gates as promised to the Allies. Driven by Hill from Aire on the 2nd of March 1814, Soult retired by Vic Bigorre, where there was a combat (March 19), and Tarbes, where there was a severe action (March 20), to Toulouse behind the Garonne. He endeavoured also to rouse the French peasantry against the Allies, but in vain, for Wellington's justice and moderation afforded them no grievances. Wellington wished to pass the Garonne above Toulouse in order to attack the city from the south—its weakest side—and interpose between Soult and Suchet. But finding it impracticable to operate in that direction, he left Hill on the west side and crossed at Grenade below Toulouse (April 3). When Beresford, who had now rejoined Wellington, had passed over, the bridge was swept away, which left him isolated on the right bank. But Soult did not attack; the bridge (April 8) was restored; Wellington crossed the Garonne and the Ers, and attacked Soult on the 10th of April. In the battle of Toulouse the French numbered about 40,000 (exclusive of the local National Guards) with 80 guns; the Allies under 52,000 with 64 guns. Soult's position to the north and east of the city was exceedingly strong, consisting of the canal of Languedoc, some fortified suburbs, and (to the extreme east) the commanding ridge of Mont Rave, crowned with redoubts and earthworks. Wellington's columns, under Beresford, were now called upon to make a flank march of some two miles, under artillery, and occasionally musketry, fire, being threatened also by cavalry, and then, while the Spanish troops assaulted the north of the ridge, to wheel up, mount the eastern slope, and carry the works. The Spaniards were repulsed, but Beresford gallantly took Mont Rave and Soult fell back behind the canal. On the 12th of April Wellington advanced to invest Toulouse from the south, but Soult on the night of the 11th had retreated towards Villefranque, and Wellington then entered the city. The allied loss was about 5000; the French 3000. Thus, in the last great battle of the war, the courage and resolution of the soldiers of the Peninsular army were conspicuously illustrated.

On the 13th of April 1814 officers arrived with the announcement to both armies of the capture of Paris, the abdication of Napoleon, and the practical conclusion of peace; and on the 18th a convention, which included Suchet's force, was entered into between Wellington and Soult. Unfortunately, after Toulouse had fallen, the Allies and French, in a sortie from Bayonne on the 14th of April, each lost about 1000 men: so that some 10,000 men fell after peace had virtually been made. In the east, during this year (1814), Sir W. Clinton had, on

the 16th of January, attacked Suchet at Molins de Rey and blockaded Barcelona (Feb. 7); the French posts of Lerida, Mequinenza and Monzon had also been yielded up, and Suchet, on the 2nd of March, had crossed the Pyrenees into France Figueras surrendered to Cuesta before the end of May; and peace was formally signed at Paris on the 30th of May.

Thus terminated the long and sanguinary struggle of the Peninsular War. The British troops were partly sent to England, and partly embarked at Bordeaux for America, with which country war had broken out (see AMERICAN WAR OF 1812-15): the Portuguese and Spanish recrossed the Pyrenees: the French army was dispersed throughout France: Louis XVIII was restored to the French throne: and Napoleon was permitted to reside in the Island of Elba, the sovereignty of which had been conceded to him by the allied powers. For the operations of this campaign Wellington was created marquis of Douro and duke of Wellington, and peerages were conferred upon Beresford, Graham and Hill.

The events of the Peninsular War, especially as narrated in the Wellington Despatches, are replete with instruction not only for the soldier, but also for the civil administrator. Even in a brief summary of the war one salient fact is noticeable, that all Wellington's reverses were in connexion with his sieges, for which his means were never adequate. In his many battles he was always victorious, his strategy eminently successful, his organizing and administrative power exceptionally great, his practical resource unlimited, his soldiers most courageous; but he never had an army fully complete in its departments and warlike equipment. He had no adequate corps of sappers and miners, or transport train. In 1812 tools and material of war for his sieges were often insufficient. In 1813, when he was before San Sebastian, the ammunition ran short; a battering train, long demanded, reached him not only some time after it was needed, but even then with only one day's provision of shot and shell. For the siege of Burgos heavy guns were available in store on the coast; but he neither had, nor could procure, the transport to bring them up. By resource and dogged determination Wellington rose superior to almost every difficulty, but he could not overcome all; and the main teaching of the Peninsular War turns upon the value of an army that is completely organized in its various branches before hostilities break out. (C. W. R.)

AUTHORITIES.—*The Wellington Despatches*, ed. Gurwood (London, 1834-1839); *Supplementary Wellington Despatches* (London, 1858-1861 and 1867-1872); Sir W. Napier, *History of War in the Peninsula and South of France* (London, 1828-1840); C. W. C. Oman, *History of the Peninsular War* (London, 1902); Sir J. Jones, *Journals and Sieges in Spain, 1811-12* (London, 1814); and *Account of the War in Spain, Portugal and South of France, 1808-14* (London, 1821); Sir J. F. Maurice, *Diary of Sir John Moore* (London, 1904); Commandant Balagny, *Campagne de l'Empereur Napoléon en Espagne, 1808-1809* (Paris, 1902); Major-General C. W. Robinson, *Wellington's Campaigns* (London, 1907); Sir A. Alison, *History of Europe, 1789-1815* (London, 1835-1842); T. Choumara, *Considérations militaires sur les mémoires du Maréchal Suchet et sur la bataille de Toulouse* (Paris, 1838); Commandant Clerc, *Campagne du Maréchal Soult dans les Pyrénées occidentales en 1813-14* (Paris, 1894); *Mémoires du Baron Marbot* (Paris, 1801; Eng. trans. by A. J. Butler, London, 1902); H. R. Clinton, *The War in the Peninsula, &c.* (London, 1829); Marshal Suchet's *Mémoires* (Paris, 1826; London, 1829); Captain L. Butler, *Wellington's Operations in the Peninsula, 1808-14* (London, 1904); Batty, *Campaign of the Left Wing of the Allied Army in the Western Pyrenees and South of France, 1813-14* (London, 1823); Foy, *Histoire de la guerre de la Péninsule, &c., sous Napoléon* (Paris and London, 1827); Lord Londonderry, *Narrative of the Peninsular War, 1808-13* (London, 1829); R. Southey, *History of the Peninsular War* (London, 1823-1832); Major A. Grünth, *Wellington and Waterloo* (illustrated; London, 1898); Thiers, *Histoire du consulat et de l'Empire* (Paris, 1845-1847; and translated by D. F. Campbell, London, 1845); Captain A. H. Marindin, *The Salamanca Campaign* (London, 1906); Marmont's *Mémoires* (Paris, 1857); Colonel Sir A. S. Fraser, *Letters during the Peninsular and Waterloo Campaigns* (ed. by Major-General E. Sabine, London, 1859); Lieut.-Colonel W. Hill-James, *Battles round Biarritz, Nivelle and the Nive* (London, 1896); *Battles round Biarritz, Garos and the Bridge of Boats* (Edinburgh, 1897); H. B. Robinson, *Mémoires of Lieutenant-General Sir T. Picton* (London, 1835); G. C. Moore-Smith, *Autobiography of Lieutenant-General Sir Harry Smith* (London, 1901); *Life of John Colborne (F.-M. Lord Seaton)* (London, 1903); Rev. A. H. Crauford.

General Craufurd and his Light Division (London, 1891); Sir George Larpent, *Private Journal of F. S. Larpent during the Peninsular War* (London, 1853); Major-General H. D. Hutchinson, *Operations in the Peninsula, 1808-9* (London, 1905); *The Dickson MSS., being Journals of Major-General Sir Alexander Dickson during the Peninsular War* (Woolwich, 1907).

PENISCOLA, a town of eastern Spain, in the province of Castellón de la Plana, and on the Mediterranean Sea, 5 m. by road S. of Benicarló. Pop. (1900), 3142. Peñíscola, often called the Gibraltar of Valencia, is a fortified seaport, with a lighthouse, built on a rocky headland about 220 ft. high, and only joined to the mainland by a narrow strip of sand. Originally a Moorish stronghold, it was captured in 1233 by James I. of Aragon, who entrusted it to the Knights Templar. In the 14th century it was garrisoned by the knights of Montesa, and in 1420 it reverted to the Crown. From 1415 it was the home of the schismatic pope Benedict XIII. (Pedro de Luna), whose name is commemorated in the Bufador de Papa Luna, a curious cavern with a landward entrance through which the sea-water escapes in clouds of spray.

PENITENTIAL (Lat. *poenitentiale, libellus poenitentialis, &c.*), a manual used by priests of the Catholic Church for guidance in assigning the penance due to sins. Such manuals played a large rôle in the early middle ages, particularly in Ireland, England and Frankland, and their influence in the moral education of the barbarian races has not received sufficient attention from historians. They were mainly composed of canons drawn from various councils and of *dicta* from writings of some of the fathers. Disciplinary regulations in Christian communities are referred to from the very borders of the apostolic age, and a system of careful oversight of those admitted to the mysteries developed steadily as the membership grew and dangers of contamination with the outside world increased. These were the elaborate precautions of the catechumenate, and—as a bulwark against the persecutions—the rigid system known as the Discipline of the Secret (*disciplina arcani*). The treatment of the lapsed, which produced the Novatian heresy, was also responsible for what has frequently been referred to as the first penitential. This is the *libellus* in which, according to Cyprian (*Ep.* 51), the decrees of the African synods of 251 and 255 were embodied for the guidance of the clergy in dealing with their repentant and returning flocks. This manual, which has been lost, was evidently not like the code-like compilations of the 8th century, and it is somewhat misleading to speak of it as a penitential. Jurisdiction in penance was still too closely limited to the upper ranks of the clergy to call forth such literature. Besides the bishop an official well versed in the penitential regulations of the Church, called the *poenitentarius*, assigned due penalties for sins. For their guidance there was considerable conciliar legislation (e.g. Ancyra, Nicaea, Neocaesarea, &c.), and certain patristic letters which had acquired almost the force of decretals. Of the latter the most important were the three letters of St Basil of Caesarea (d. 379) to Bishop Amphilochus of Iconium containing over eighty headings.

Three things tended to develop these rules into something like a system of penitential law. These were the development of auricular confession and private penance; the extension of the penitential jurisdiction among the clergy owing to the growth of a parochial priesthood; and the necessity of adapting the penance to the primitive ideas of law prevailing among the newly converted barbarians, especially the idea of compensation by the *vergild*. In Ireland in the middle of the 5th century appeared the "canons of St Patrick." In the first half of the next century these were followed by others, notably those of St Finian (d. 552). At the same time the Celtic British Church produced the penitentials of St David of Menevia (d. 544) and of Gildas (d. 583) in addition to synodal legislation. These furnished the material to Columban (d. 615) for his *Liber de poenitentia* and his monastic rule, which had a great influence upon the continent of Europe. The Anglo-Saxon Church was later than the Irish, but under Theodore of Tarsus (d. 690), archbishop of Canterbury, the practice then in force was made

the basis of the most important of all penitentials. The *Poenitentiale Theodori* became the authority in the Church's treatment of sinners for the next four centuries, both in England and elsewhere in Europe. The original text, as prepared by a disciple of Theodore, and embodying his decisions, is given in Haddan and Stubbs's *Councils and Ecclesiastical Documents relating to Great Britain and Ireland* (iii. 173 seq.). A *Poenitentiale Commanii* (St Cumanian), dating apparently from the early 8th century, was the third main source of Frankish penitentials. The extent and variety of this literature led the Gallican Church to exercise a sort of censorship in order to secure uniformity. After numerous synods, Bishop Haltigar of Cambrai was commissioned by Ebo of Reims in 829 to prepare a definitive edition. Haltigar used, among his other materials, a so-called *poenitentiale romanum*, which was really of Frankish origin. The canons printed by David Wilkins in his *Concilia* (1737) as being by Ecgbert of York (d. 767) are largely a translation into Anglo-Saxon of three books of Haltigar's penitentials. In 841 Hrabanus Maurus undertook a new *Liber poenitentium* and wrote a long letter on the subject to Heribald of Auxerre about 853. Then followed the treatise of Reginon of Prum in 906, and finally the collection made by Burchard, bishop of Worms, between 1012 and 1023. The codification of the canon law by Gratian and the change in the sacramental position of penance in the 12th century closed the history of penitentials.

Much controversy has arisen over the question whether there was an official papal penitential. It is claimed that (quite apart from Haltigar's *poenitentiale romanum*) such a set of canons existed early in Rome, and the attempt has been made by H. J. Schmitz in his learned treatise on penitentials (*Busbücher und das kanonische Busverfahren*, 1883 and 1898) to establish their pontifical character. The matter is still in dispute, Schmitz's thesis not having met with universal acceptance.

In addition to the works mentioned above the one important work on the penitentials was L. W. H. Wasserschleben's epoch-making study and collection of texts, *Die Bussordnungen der abendländischen Kirche nebst einer rechtsgeschichtlichen Einleitung* (Halle, 1851). See articles in Wetzer and Welte's *Kirchenlexikon*, Hauck's *Realencyclopädie*, and Haddan and Stubbs's *Councils*. See also Sebass in *Zeitschrift für Kirchengeschichte*, xviii. 58. On the canons of St Patrick see the *Life of St Patrick* by J. B. Bury (pp. 233-275).

PENITENTIARY (med. Lat. *poenitentarius*, from *poenitentia*, penance, *poena*, punishment, a term used both as adjective and substantive, referring either to the means of repentance or that of punishment. In its ecclesiastical use the word is used as the equivalent both of the Latin *poenitentarius*, "penitentiary priest," and *poenitentaria*, the dignity or office of a *poenitentarius*. By an extension of the latter sense the name is applied to the department of the Roman Curia known as the apostolic penitentiary (*sacra poenitentaria apostolica*), presided over by the cardinal grand penitentiary (*major poenitentarius*, Ital. *penitenziere maggiore*) and having jurisdiction more particularly in all questions in *foro interno* reserved for the Holy See (see CURIA ROMANA). In general, the *poenitentarius*, or penitentiary priest, is in each diocese what the grand penitentiary is at Rome, i.e. he is appointed to deal with all cases of conscience reserved for the bishop. In the Eastern Church there are very early notices of such appointments; so far as the West is concerned, Hinschius (*Kirchenrecht*, I. 428, note 2) quotes from the chronicle of Bernold, the monk of St Blase (c. 1054-1100), as the earliest record of such appointment, that made by the papal legate Odo of Ostia in 1054. In 1215 the fourth Lateran Council, by its 10th canon, ordered suitable men to be ordained in all cathedral and conventual churches, to act as coadjutors and assistants to the bishops in hearing confessions and imposing penances. The rule was not immediately nor universally obeyed, the bishops being slow to delegate their special powers. Finally, however, the council of Trent (Sess. xxiv. cap. viii. *de reform.*) ordered that, "wherever it could conveniently be done," the bishop should appoint in his cathedral a *poenitentarius*, who should be a doctor or licentiate in theology or canon law and at least forty years of age.

See P. Hinschius, *Kirchenrecht*, i. 427, &c. (Berlin, 1869); Du Cange, *Glossarium*, s.v. "Poenitentarius"; Herzog-Hauck, *Realencyclopädie* (ed. 1904), s.v. "Poenitentarius."

PENKRIDGE, a town in the western parliamentary division of Staffordshire, England; 134 m. N.W. from London by the London & North-Western railway, on the small river Penk. Pop. (1901), 2347. Trade is chiefly agricultural and there are stone-quarries in the vicinity. The church of St Michael and All Angels, formerly collegiate and dedicated to St Mary, is a fine building principally Perpendicular, but with earlier portions. The Roman Watling Street passes from east to west 3 m. south of Penkridge. In the neighbourhood is Pillaton Hall, retaining a picturesque chapel of the 15th century.

PENLEY, WILLIAM SYDNEY (1852-), English actor, was born at Broadstairs, and educated in London, where his father had a school. He first made his mark as a comedian by his exceedingly amusing performance as the curate in *The Private Secretary*, a part in which he succeeded Beerbohm Tree; but he is even more associated with the title rôle in Brandon Thomas's *Charley's Aunt* (1892), a farce which had an unprecedentedly long run and was acted all over the world.

PENMARC'H, a village of western France in the department of Finistère, 18 m. S.W. of Quimper by road. Pop. (1906), of the village, 387; of the commune, 5702. On the extremity of the peninsula on which it is situated are fortified remains of a town which was of considerable importance from the 14th to the 16th centuries and included, besides Penmarc'h, St Guénolé and Kerity. It owed its prosperity to its cod-banks, the disappearance of which together with the discovery of the Newfoundland cod-banks and the pillage of the place by the bandit La Fontenelle in 1595 contributed to its decadence. The church of St Nouna, a Gothic building of the early 16th century at Penmarc'h, and the church of St Guénolé, an unfinished tower of the 15th century and the church of Kerity (15th century) are of interest. The coast is very dangerous. On the Point de Penmarc'h stands the Phare d'Eckmühl, with a light visible for 60 miles. There are numerous megalithic monuments in the vicinity.

PENN, WILLIAM (1621-1670), British admiral, was the son of Giles Penn, merchant and seaman of Bristol. He served his apprenticeship at sea with his father. In the first Civil War he fought on the side of the parliament, and was in command of a ship in the squadron maintained against the king in the Irish seas. The service was arduous and called for both energy and good seamanship. In 1648 he was arrested and sent to London, but was soon released, and sent back as rear admiral in the "Assurance" (32). The exact cause of the arrest is unknown, but it may be presumed to have been that he was suspected of being in correspondence with the king's supporters. It is highly probable that he was, for until the Restoration he was regularly in communication with the Royalists, while serving the parliament, or Cromwell, so long as their service was profitable, and making no scruple of applying for grants of the confiscated lands of the king's Irish friends. The character of "mean fellow" given him by Pepys is borne out by much that is otherwise known of him. But it is no less certain that he was an excellent seaman and a good fighter. After 1650 he was employed in the Ocean, and in the Mediterranean in pursuit of the Royalists under Prince Rupert. He was so active on this service that when he returned home on the 18th of March 1651 he could boast that he had not put foot on shore for more than a year. When the first Dutch War broke out Penn was appointed vice-admiral to Blake, and was present at the battle of the 28th of September off the Kentish Knock. In the three days' battle off Portland, February 1653, he commanded the Blue squadron, and he also served with distinction in the final battles of the war in June and July. In December he was included in the commission of admirals and generals at sea, who exercised the military command of the fleet, as well as "one of the commissioners for ordering and managing the affairs of the admiralty and navy." In 1654 he offered to carry the fleet over to the king, but in October of

the same year he had no scruple in accepting the naval command in the expedition to the West Indies sent out by Cromwell, which conquered Jamaica. He was not responsible for the shameful repulse at San Domingo, which was due to a panic among the troops. On their return he and his military colleague Venables were sent to the Tower. He made humble submission, and when released retired to the estate he had received from confiscated land in Ireland. He continued in communication with the Royalists, and in 1660 had a rather obscure share in the Restoration. He was reappointed commissioner of the navy by the king, and in the second Dutch War served as "great captain commander" or captain of the fleet, with the duke of York (afterwards King James II.) at the battle of Lowestoft (June 3, 1665). When the duke withdrew from the command, Penn's active service ceased. He continued however to be a commissioner of the navy. His death occurred on the 16th of September 1670, and he was buried in the church of St Mary Redcliffe, Bristol. His portrait by Lely is in the Painted Hall at Greenwich. By his wife Margaret Jasper, he was the father of William Penn, the founder of Pennsylvania. Though Sir William Penn was not a high-minded man, he is a figure of considerable importance in British naval history. As admiral and general for the parliament he helped in 1653 to draw up the first code of tactics provided for the navy. It was the base of the "Duke of York's Sailing and Fighting Instructions," which continued for long to supply the orthodox tactical creed of the navy.

See the *Memorials of the Professional Life and Times of Sir William Penn*, by Granville Penn. (D. H.)

PENN, WILLIAM (1644-1718), English Quaker and founder of Pennsylvania, son of Admiral Sir William Penn (1621-1670) and Margaret Jasper, a Dutch lady, was born at Tower Hill, London, on the 14th of October 1644. During his father's absence at sea he lived at Wanstead in Essex, and went to school at Chigwell close by, in which places he was brought under strong Puritan influences. Like many children of sensitive temperament, he had times of spiritual excitement; when about twelve he was "suddenly surprised with an inward comfort, and, as he thought, an external glory in the room, which gave rise to religious emotions, during which he had the strongest conviction of the being of a God, and that the soul of man was capable of enjoying communication with Him." Upon the death of Cromwell, Penn's father, who had served the Protector because there was no other career open, remained with his family on the Irish estates which Cromwell had given him, of the value of £300 a year. On the resignation of Richard Cromwell he at once declared for the king and went to the court in Holland, where he was received into favour and knighted; and at the elections for the convention parliament he was returned for Weymouth. Meanwhile young Penn studied under a private tutor on Tower Hill until, in October 1660, he was entered as a gentleman commoner at Christ Church. He appears in the same year to have contributed to the *Threnodia*, a collection of elegies on the death of the young duke of Gloucester.

The rigour with which the Anglican statutes were revived, and the Puritan heads of colleges supplanted, roused the spirit of resistance at Oxford to the uttermost. With this spirit Penn, who was on familiar terms with John Owen (1616-1683), and who had already fallen under the influence of Thomas Loe the Quaker, then at Oxford, actively sympathized. He and others refused to attend chapel and church service, and were fined in consequence. How far his leaving the university resulted from this cannot be clearly ascertained. Anthony Wood has nothing regarding the cause of his leaving, but says that he stayed at Oxford for two years, and that he was noted for proficiency in manly sports. There is no doubt that in January 1662 his father was anxious to remove him to Cambridge, and consulted Pepys on the subject; and in later years he speaks of being "banished" the college, and of being whipped, beaten and turned out of doors on his return to his father, in the anger of the latter at his avowed Quakerism. A reconciliation, however, was effected; and Penn was sent to France to forget this

folly. The plan was for a time successful. Penn appears to have entered more or less into the gaieties of the court of Louis XIV., and while there to have become acquainted with Robert Spencer, afterwards earl of Sunderland, and with Dorothy, sister to Algernon Sidney. What, however, is more certain is that he somewhat later placed himself under the tuition of Moses Amyraut, the celebrated president of the Protestant college of Saumur, and at that time the exponent of liberal Calvinism, from whom he gained the patristic knowledge which is so prominent in his controversial writings. He afterwards travelled in Italy, returning to England in August 1664, with "a great deal, if not too much, of the vanity of the French garb and affected manner of speech and gait."¹

Until the outbreak of the plague Penn was a student of Lincoln's Inn. For a few days also he served on the staff of his father—now great captain commander—and was by him sent back in April 1665 to Charles with despatches. Returning after the naval victory off Lowestoft in June, Admiral Penn found that his son had again become settled in seriousness and Quakerism. To bring him once more to views of life not inconsistent with court preferment, the admiral sent him in February 1666 with introductions to Ormonde's pure but brilliant court in Ireland, and to manage his estate in Cork round Shannangary Castle, his title to which was disputed. Penn appears also later in the year to have been "clerk of the cheque" at Kinsale, of the castle and fort of which his father had the command. When the mutiny broke out in Carrickfergus Penn volunteered for service, and acted under Arran so as to gain considerable reputation. The result was that in May 1666 Ormonde offered him his father's company of foot, but, for some unexplained reason, the admiral demurred to this arrangement. It was at this time that the well-known portrait was painted of the great Quaker in a suit of armour; and it was at this time, too, that the conversion, begun when he was a boy by Thomas Loe in Ireland, was completed at the same place by the same agency.²

On the 3rd of September 1667 Penn attended a meeting of Quakers in Cork, at which he assisted to expel a soldier who had disturbed the meeting. He was in consequence, with others present, sent to prison by the magistrates. From prison he wrote to Lord Orrery, the president of Munster, a letter, in which he first publicly makes a claim for perfect freedom of conscience. He was immediately released, and at once returned to his father in London, with the distinctive marks of Quakerism strong upon him. Penn now became a minister of the denomination, and at once entered upon controversy and authorship. His first book, *Truth Exalted*, was violent and aggressive in the extreme. The same offensive personality is shown in *The Guide Mistaken*, a tract written in answer to John Clapham's *Guide to the True Religion*. It was at this time, too, that he appealed, not unsuccessfully, to Buckingham, who on Clarendon's fall was posing as the protector of the Dissenters, to use his efforts to procure parliamentary toleration.

Penn's first public discussion was with Thomas Vincent, a London Presbyterian minister, who had reflected on the "damnable" doctrines of the Quakers. The discussion, which had turned chiefly upon the doctrine of the Trinity, ended uselessly, and Penn at once published *The Sandy Foundation Shaken*, a tract of ability sufficient to excite Pepys's astonishment, in which orthodox views were so offensively attacked that Penn was placed in the Tower, where he remained for nearly nine months. The imputations upon his opinions and good citizenship, made as well by Dissenters as by the Church, he repelled in *Innocency with her Open Face*, in which he asserts his full belief in the divinity of Christ, the atonement, and justification through faith, though insisting on the necessity of good works. It was now, too, that he published the most important of his books, *No Cross, No Crown*, which contained an able defence of the Quaker doctrines and practices, and a scathing attack on the loose and unchristian lives of the clergy.

¹ Pepys, August 30, 1664.

² Webb, *The Penns and Penningtons* (1867), p. 174.

While completely refusing to recant Penn addressed a letter to Arlington in July 1669, in which, on grounds of religious freedom, he asked him to interfere. It is noteworthy, as showing the views then predominant, that he was almost at once set at liberty.

An informal reconciliation now took place with his father, who had been impeached through the jealousy of Rupert and Monk (in April 1668), and whose conduct in the operations of 1665 he had publicly vindicated; and Penn was again sent on family business to Ireland. At the desire of his father, whose health was fast failing, Penn returned to London in 1670. Having found the usual place of meeting in Gracechurch Street closed by soldiers, Penn, as a protest, preached to the people in the open street. With William Mead he was at once arrested and indicted at the Old Bailey on the 1st of September for preaching to an unlawful, seditious and riotous assembly, which had met together with force and arms. The Conventicle Act not touching their case, the trial which followed, and which may be read at length in Penn's *People's Ancient and Just Liberties Asserted*, was a notable one in the history of trial by jury. With extreme courage and skill Penn exposed the illegality of the prosecution, while the jury, for the first time, asserted the right of juries to decide in opposition to the ruling of the court. They brought in a verdict declaring Penn and Mead "guilty of speaking in Gracechurch Street," but refused to add "to an unlawful assembly"; then, as the pressure upon them increased, they first acquitted Mead, while returning their original verdict upon Penn, and then, when that verdict was not admitted, returned their final answer "not guilty" for both. The court fined the jurymen 40 marks each for their contumacy, and, in default of payment, imprisoned them, whereupon they vindicated and established for ever the right they had claimed in an action (known as Bushell's case from the name of one of the jurymen) before the court of common pleas, when all twelve judges unanimously declared their imprisonment illegal.

Penn himself had been fined for not removing his hat in court, had been imprisoned on his refusal to pay, and had earnestly requested his family not to pay for him. The fine, however, was settled anonymously, and he was released in time to be present at his father's death on the 16th of September 1670, at the early age of forty-nine. Penn now found himself in possession of a fortune of £1500 a year, and a claim on the Crown for £16,000, lent to Charles II. by his father. Upon his release Penn at once plunged into controversy, challenging a Baptist minister named Jeremiah Ives, at High Wycombe, to a public dispute and, according to the Quaker account, easily defeating him. No account is forthcoming from the other side. Hearing at Oxford that students who attended Friends' meeting were rigorously used, he wrote a vehement and abusive remonstrance to the vice-chancellor in defence of religious freedom. This found still more remarkable expression in the *Seasonable Caveat against Popery* (Jan. 1671).

In the beginning of 1671 Penn was again arrested for preaching in Wheeler Street meeting-house by Sir J. Robinson, the lieutenant of the Tower, formerly lord mayor, and known as a brutal and bigoted churchman. Legal proof being wanting of any breach of the Conventicle Act, and the Oxford or Five Mile Act also proving inapplicable, Robinson, who had some special cause of enmity against Penn, urged upon him the oath of allegiance. This, of course, the Quaker would not take, and consequently was imprisoned for six months. During this imprisonment Penn wrote several works, the most important being *The Great Case of Liberty of Conscience* (Feb. 1671), a noble defence of complete toleration. Upon his release he started upon a missionary journey through Holland and Germany; at Emden he founded a Quaker society, and established an intimate friendship with the princess palatine Elizabeth.

Upon his return home in the spring of 1672 Penn married Gulielma Springett, daughter of Mary Pennington by her first husband, Sir William Springett; she appears to have been

equally remarkable for beauty, devotion to her husband, and firmness to the religious principles which she had adopted when little more than a child.¹ He now settled at Rickmansworth in Hertfordshire, and gave himself up to controversial writing. To this year, 1672, belong the *Treatise on Oaths and England's Present Interest Considered*. In the year 1673 Penn was still more active. He secured the release of George Fox, addressed the Quakers in Holland and Germany, carried on public controversies with Thomas Hicks, a Baptist, and John Faldo, an Independent, and published his treatise on the *Christian Quaker and his Divine Testimony Vindicated, the Discourse of the General Rule of Faith and Practice, Reasons against Railing* (in answer to Hicks), *Counterfeit Christianity Detected*, and a *Just Rebuke to One-and-twenty Learned Divines* (an answer to Faldo and to Quakerism no Christianity). His last public controversy was in 1675 with Richard Baxter, in which, of course, each party claimed the victory.

At this point Penn's connexion with America begins. The province of New Jersey, comprising the country between the Hudson and Delaware rivers on the east and west, had been granted in March 1663-1664 by Charles II to his brother, James in turn had in June of the same year leased it to Lord Berkeley and Sir G. Carteret in equal shares. By a deed, dated 18th of March 1673-1674, John Fenwick, a Quaker, bought one of the shares, that of Lord Berkeley (Stoughton erroneously says Carteret's) in trust for Edward Byllinge, also a Friend, for £1000. This sale was confirmed by James, after the second Dutch War, on the 6th of August 1680. Disputes having arisen between Fenwick and Byllinge, Penn acted as arbitrator; and then, Byllinge being in money difficulties, and being compelled to sell his interest in order to satisfy his creditors, Penn was added, at their request, to two of themselves, as trustee. The disputes were settled by Fenwick receiving ten out of the hundred parts into which the province was divided,² with a considerable sum of money, the remaining ninety parts being afterwards put up for sale. Fenwick sold his ten parts to two other Friends, Eldridge and Warner, who thus, with Penn and the other two, became masters of West Jersey, West New Jersey, or New West Jersey, as it was indifferently called.³ The five proprietors appointed three commissioners, with instructions dated from London the 6th of August 1676, to settle disputes with Fenwick (who had bought fresh land from the Indians, upon which Salem was built, Penn being himself one of the settlers there) and to purchase new territories, and to build a town—New Beverley, or Burlington, being the result. For the new colony Penn drew up a constitution, under the title of "Concessions." The greatest care is taken to make this constitution "as near as may be conveniently to the primitive, ancient and fundamental laws of the nation of England." But a democratic element is introduced, and the new principle of perfect religious freedom stands in the first place (ch. xvi.). With regard to the liberty of the subject, no one might be condemned in life, liberty or estate, except by a jury of twelve, and the right of challenging was granted to the uttermost (ch. xvii.). Imprisonment for debt was not abolished (as Dixon states), but was reduced to a minimum (ch. xviii.), while theft was punished by twofold restitution either in value or in labour to that amount (ch. xviii.). The provisions of ch. xix. deserve special notice. All causes were to go before three justices, with a jury. "They, the said justices, shall pronounce such judgment as they shall receive from, and be directed by the said twelve men, in whom only the judgment resides, and not otherwise. And in case of their neglect and refusal, that then one of the twelve, by consent of the rest, pronounce their own judgment as the justices should have done." The justices and constables, moreover, were

¹ For a very charming account of her, and the whole Pennington connexion, see Maria Webb's *The Penns and Penningtons*.

² See on this Stoughton's *Penn*, p. 113.

³ The deed by which Fenwick and Byllinge conveyed West New Jersey to Penn, Lawry and Nicholas Lucas is dated the 10th of February 1674-1675.

⁴ The line of partition was "from the east side of Little Egg Harbour, straight north, through the country, to the utmost branch of Delaware River."

elected by the people, the former for two years only (ch. xli) Suitors might plead in person, and the courts were public (ch. xxii.). Questions between Indians and settlers were to be arranged by a mixed jury (ch. xxv.). An assembly was to meet yearly, consisting of a hundred persons, chosen by the inhabitants, freeholders and proprietors, one for each division of the province. The election was to be by ballot, and each member was to receive a shilling a day from his division, "that thereby he may be known to be the servant of the people." The executive power was to be in the hands of ten commissioners⁴ chosen by the assembly. Such a constitution soon attracted large numbers of Quakers to West Jersey.

It was shortly before these occurrences that Penn inherited through his wife the estate of Wormunghurst in Sussex, whither he removed from Rickmansworth. He now (July 25, 1677) undertook a second missionary journey to the continent along with George Fox, Robert Barclay and George Keith. He visited particularly Rotterdam and all the Holland towns, renewed his intimacy with the princess Elizabeth at Herwerden, and, under considerable privations, travelled through Hanover, Germany, the lower Rhine and the electorate of Brandenburg, returning by Bremen and the Hague. It is worthy of recollection that the Germantown (Philadelphia) settlers from Kirchheim, one of the places which responded in an especial degree to Penn's teaching, are noted as the first who declared it wrong for Christians to hold slaves. Penn reached England again on the 24th of October. He tried to gain the insertion in the bill for the relief of Protestant Dissenters of a clause enabling Friends to affirm instead of taking the oath, and twice addressed the House of Commons' committee with considerable eloquence and effect. The bill, however, fell to the ground at the sudden prorogation.

In 1678 the popish terror came to a head, and to calm and guide Friends in the prevailing excitement Penn wrote his *Epistle to the Children of Light in this Generation*. A far more important publication was *An Address to Protestants of all Persuasions*, by William Penn, Protestant, in 1679; a powerful exposition of the doctrine of pure tolerance and a protest against the enforcement of opinions as articles of faith. This was succeeded, at the general election which followed the dissolution of the pensionary parliament, by an important political manifesto, *England's Great Interest in the Choice of this New Parliament*, in which he insisted on the following points: the discovery and punishment of the plot, the impeachment of corrupt ministers and councillors, the punishment of "pensioners," the enactment of frequent parliaments, security from popery and slavery, and ease for Protestant Dissenters. Next came *One Project for the Good of England*, perhaps the most pungent of all his political writings. But he was not merely active with his pen. He was at this time in close intimacy with Algernon Sidney, who stood successively for Guildford and Bramber. In each case, owing in a great degree to Penn's eager advocacy, Sidney was elected, only to have his elections annulled by court influence. Toleration for Dissenters seemed as far off as ever. Encouraged by his success in the West Jersey province, Penn again turned his thoughts to America. In repayment of the debt mentioned above he now asked from the Crown, at a council held on the 24th of June 1680, for "a tract of land in America north of Maryland, bounded on the east by the Delaware, on the west limited as Maryland [i.e. by New Jersey], northward as far as plantable"; this latter limit Penn explained to be "three degrees northwards." This formed a tract of 300 m. by 160, of extreme fertility, mineral wealth and richness of all kinds. Disputes with James, duke of York, and with Lord Baltimore, who had rights over Maryland, delayed the matter until the 14th of March 1681, when the grant received the royal signature, and Penn was made master of the province of Pennsylvania. His own account of the name is that he suggested "Sylvania," that the king added the "Penn" in honour of his father, and that, although he

⁴ Penn's letter of the 26th of August 1676 says twelve, and Clarkson has followed this; but the Concessions, which were not assented to by the inhabitants until the 3rd of March 1676-1677, say ten.

strenuously objected and even tried to bribe the secretaries, he could not get the name altered. It should be added that early in 1682 Carteret, grandson of the original proprietor, transferred his rights in East Jersey to Penn and eleven associates, who soon afterwards conveyed one-half of their interest to the earl of Perth and eleven others. It is uncertain to what extent Penn retained his interest in West and East Jersey, and when it ceased. The two provinces were united under one governor in 1699, and Penn was a proprietor in 1700. In 1702 the government of New Jersey was surrendered to the Crown.

By the charter for Pennsylvania Penn was made proprietary of the province. He was supreme governor; he had the power of making laws with the advice, assent and approbation of the freemen, of appointing officers, and of granting pardons. The laws were to contain nothing contrary to English law, with a saving to the Crown and the privy council in the case of appeals. Parliament was to be supreme in all questions of trade and commerce; the right to levy taxes and customs was reserved to England; an agent to represent Penn was to reside in London; neglect on the part of Penn was to lead to the passing of the government to the Crown (which event actually took place in 1692); no correspondence might be carried on with countries at war with Great Britain. The importunity of the bishop of London extorted the right to appoint Anglican ministers, should twenty members of the colony desire it, thus securing the very thing which Penn was anxious to avoid—the recognition of the principle of an establishment.

Having appointed Colonel (Sir William) Markham, his cousin, as deputy, and having in October sent out three commissioners to manage his affairs until his arrival, Penn proceeded to draw up proposals to adventurers, with an account of the resources of the colony. He negotiated, too, with James and Lord Baltimore with the view, ultimately successful, of freeing the mouth of the Delaware, wrote to the Indians in conciliatory terms, and encouraged the formation of companies to work the infant colony both in England and Germany, especially the "Free Society of Traders in Pennsylvania," to whom he sold 20,000 acres, absolutely refusing, however, to grant any monopolies. In July he drew up a body of "conditions and concessions." This constitution, savouring strongly of Harrington's *Oceana*, was framed, it is said, in consultation with Sidney, but the statement is doubtful. Until the council of seventy-two (chosen by universal suffrage every three years, twenty-four retiring each year), and the assembly (chosen annually) were duly elected, a body of provisional laws was added.

It was in the midst of this extreme activity that Penn was made a Fellow of the Royal Society. Leaving his family behind him, Penn sailed with a hundred comrades from Deal in the "Welcome" on the 1st of September 1682. His *Last Farewell to England* and his letter to his wife and children contain a beautiful expression of his pious and manly nature. He landed at New Castle on the Delaware on the 27th of October, his company having lost one-third of their number by small-pox during the voyage. After receiving formal possession, and having visited New York, Penn ascended the Delaware to the Swedish settlement of Upland, to which he gave the name of Chester. The assembly at once met, and on the 7th of December passed the "Great Law of Pennsylvania." The idea which informs this law is that Pennsylvania was to be a Christian state on a Quaker model. Philadelphia was now founded, and within two years contained 300 houses and a population of 2500. At the same time an act was passed, uniting under the same government the territories which had been granted by feoffment by James in 1682. Realistic and entirely imaginative accounts (cf. Dixon, p. 270), inspired chiefly by Benjamin West's picture, have been given of the treaty which there seems no doubt Penn actually made in November 1683 with the Indians. His connexion with them was one of the most successful parts of his management, and he gained at once and retained through life their intense affection.

Penn now wrote an account of Pennsylvania from his own observation for the "Free Society of Traders," in which he

shows considerable power of artistic description. Tales of violent persecution of the Quakers, and the necessity of settling disputes, which had arisen with Lord Baltimore, his neighbour in Maryland, brought Penn back to England (Oct. 2, 1684) after an absence of two years. In the spring of 1683 he had modified the original charter at the desire of the assembly, but without at all altering its democratic character.¹ He was, in reference to this alteration, charged with selfish and deceitful dealing by the assembly. Within five months after his arrival in England Charles II. died, and Penn found himself at once in a position of great influence. Penn now took up his abode at Kensington in Holland House, so as to be near the court. His influence there was great enough to secure the pardon of John Locke, who had been dismissed from Oxford by Charles, and of 1200 Quakers who were in prison. At this time, too, he was busy with his pen once more, writing a further account of Pennsylvania, a pamphlet in defence of Buckingham's essay in favour of toleration, in which he is supposed to have had some share, and his *Persuasive to Moderation to Dissenting Christians*, very similar in tone to the *One Project for the Good of England*. When Monmouth's rebellion was suppressed he appears to have done his best to mitigate the horrors of the western commission, opposing Jeffreys to the uttermost.² Macaulay has accused Penn of being concerned in some of the worst actions of the court at this time. His complete refutation by Forster, Paget, Dixon and others renders it unnecessary to do more than allude to the cases of the Maids of Taunton, Alderman Kiffin, and Magdalen College (Oxford).

In 1686, when making a third missionary journey to Holland and Germany, Penn was charged by James with an informal mission to the prince of Orange to endeavour to gain his assent to the removal of religious tests. Here he met Burnet, from whom, as from the prince, he gained no satisfaction, and who greatly disliked him. On his return he went on a preaching mission through England. His position with James was undoubtedly a compromising one, and it is not strange that, wishing to tolerate Papists, he should, in the prevailing temper of England, be once more accused of being a Jesuit, while he was in constant antagonism to their body. Even Tillotson took up this view strongly, though he at once accepted Penn's vehement disavowal. In 1687 James published the Declaration of Indulgence, and Penn probably drew up the address of thanks on the part of the Quakers. It fully reflects his views, which are further ably put in the pamphlet *Good Advice to the Church of England, Roman Catholics, and Protestant Dissenters*, in which he showed the wisdom and duty of repealing the Test Acts and Penal Laws. At the Revolution he behaved with courage. He was one of the few friends of the king who remained in London, and, when twice summoned before the council, spoke boldly in his behalf. He admitted that James had asked him to come to him in France; but at the same time he asserted his perfect loyalty. During the absence of William in 1690 he was proclaimed by Mary as a dangerous person, but no evidence of treason was forthcoming. It was now that he lost by death two of his dearest friends, Robert Barclay and George Fox. It was at the funeral of the latter that, upon the information of the notorious informer William Fuller (1670-1717), an attempt was made to arrest him, but he had just left the ground; the fact that no further steps were then taken shows how little the government believed in his guilt. He now lived in retirement in London, though his address was perfectly well known to his friends in the council. In 1691, again on Fuller's evidence, a proclamation was issued for the arrest of Penn and two others as being concerned in Preston's plot. In 1692 he began to write again, both on questions of Quaker discipline and in defence of the sect. *Just Measures in an Epistle of Peace and Love, The New Athenians* (in reply to the attacks of the *Athenian Mercury*), and *A Key opening the Way to every Capacity* are the principal publications of this year.

Meantime matters had been going badly in Pennsylvania.

¹ Dixon, p. 276.

² Burnet, iii. 66; Dalrymple, i. 282.

Penn had, in 1686, been obliged to make changes in the composition of the executive body, though in 1689 it reverted to the original constitution; the legislative bodies had quarrelled; and Penn could not gain his rents. The chief difficulty in Pennsylvania was the dispute between the province—*i.e.* the country given to Penn by the charter—and the "territories," or the lands granted to him by the duke of York by feoffment in August 1682, which were under the same government but had differing interests. The difficulties which Quaker principles placed in the way of arming the colony—a matter of grave importance in the existing European complications—fought most hardly against Penn's power. On the 21st of October 1692 an order of council was issued depriving Penn of the governorship of Pennsylvania and giving it to Colonel Benjamin Fletcher, the governor of New York. To this blow were added the illness of his wife and a fresh accusation of treasonable correspondence with James. In his enforced retirement he wrote the most devotional and most charming of his works—the collection of maxims of conduct and religion entitled *The Fruits of Solitude*. In December, thanks to the efforts of his friends at court, among whom were Buckingham, Somers, Rochester, and Henry Sidney, he received an intimation that no further steps would be taken against him. The accusation, however, had been public, and he insisted on the withdrawal being equally public. He was therefore heard in full council before the king, and honourably acquitted of all charges of treason. It was now that he wrote an *Essay towards the Present and Future Peace of Europe*, in which he puts forth the idea of a great court of arbitration, a principle which he had already carried out in Pennsylvania.

In 1694 (Feb. 23) his wife Gulielma died, leaving two sons, Springett and William, and a daughter Letitia, afterwards married to William Aubrey. Two other daughters, Mary and Hannah, died in infancy. He consoled himself by writing his *Account of the Rise and Progress of the People called Quakers*. The coldness and suspicion with which he had been regarded by his own denomination had now ceased, and he was once more regarded by the Quaker body as their leader. About the same time (Aug. 20) he was restored to the governorship of Pennsylvania; and he promised to supply money and men for the defence of the frontiers. In 1695 he went on another preaching mission in the west, and in March 1696 he formed a second marriage, with Hannah Callowhill, his son Springett dying five weeks later. In this year he wrote his work *On Primitive Christianity*, in which he argues that the faith and practice of the Friends were those of the early Church. In 1697 Penn removed to Bristol, and during the greater part of 1698 was preaching with great success against oppression in Ireland, whither he had gone to look after the property at Shannangarry.

In 1699 he was back in Pennsylvania, landing near Chester on the 30th of November, where the success of Colonel Robert Quarry, judge of the admiralty in Pennsylvania—who was in the interests of those who wished to make the province an imperial colony—and the high-handed action of the deputy Markham in opposition to the Crown, were causing great difficulties. Penn carried with him particular instructions to put down piracy, which the objections of the Quakers to the use of force had rendered audacious and concerning which Quarry had made strong representations to the home government, while Markham and the inhabitants apparently encouraged it. Penn and Quarry, however came at once to a satisfactory understanding on this matter, and the illegal traffic was vigorously and successfully attacked. In 1696 the Philadelphia Yearly Meeting had passed a resolution declaring slavery contrary to the first principles of the gospel. Penn, however, did not venture upon emancipation; but he insisted on the instruction of negroes, permission for them to marry, repression of polygamy and adultery, and proposed regulations for their trial and punishment. The assembly, however, a very mixed body of all nations, now refused to accept any of these proposals except the last-named. His great success was with the Indians; by their treaty with him in 1700 they promised not to help any enemy of England,

to traffic only with those approved by the governor, and to sell furs or skins to none but inhabitants of the province. At the same time he showed his capacity for legislation by the share he took with Lord Bellomont at New York in the consolidation of the laws in use in the various parts of America.

Affairs now again demanded his presence in England. The king had in 1701 written to urge upon the Pennsylvania government a union with other private colonies for defence, and had asked for money for fortifications. The difficulty felt by the Crown in this matter was a natural one. A bill was brought into the lords to convert private into Crown colonies. Penn's son appeared before the committee of the house and managed to delay the matter until his father's return. On the 15th of September Penn called the assembly together, in which the differences between the province and the territories again broke out. He succeeded, however, in calming them, appointed a council of ten to manage the province in his absence, and gave a borough charter to Philadelphia. In May 1700, experience having shown that alterations in the charter were advisable, the assembly had, almost unanimously, requested Penn to revise it. On the 28th of October 1701 he handed it back to them in the form in which it afterwards remained. An assembly was to be chosen yearly, of four persons from each county, with all the self-governing privileges of the English House of Commons. Two-thirds were to form a quorum. The nomination of sheriffs, coroners, and magistrates for each county was given to the governor, who was to select from names handed in by the free-men. Moreover, the council was no longer elected by the people, but nominated by the governor, who was thus practically left single in the executive. The assembly, however, who, by the first charter, had not the right to propound laws, but might only amend or reject them, now acquired that privilege. In other respects the original charter remained, and the inviolability of conscience was again emphatically asserted. Penn reached England in December 1701. He once more assumed the position of leader of the Dissenters and himself read the address of thanks for the promise from the Throne to maintain the Act of Toleration. He now took up his abode again at Kensington, and published while here his *More Fruits of Solitude*.

In 1703 he went to Knightsbridge, where he remained until 1706, when he removed to Brentford, his final residence being taken up in 1710 at Field Ruscombe, near Twyford. In 1704 he wrote his *Life of Bulstrode Whitelocke*. He had now much trouble from America. The territorialists were openly rejecting his authority, and doing their best to obstruct all business in the assembly; and matters were further embarrassed by the injudicious conduct of Governor John Evans in 1706. Moreover, pecuniary troubles came heavily upon him, while the conduct of his son William, who became the ringleader of all the dissolute characters in Philadelphia, was another and still more severe trial. This son was married, and had a son and daughter, but appears to have been left entirely out of account in the settlement of Penn's proprietary rights on his death.

Whatever were Penn's great qualities, he was deficient in judgment of character. This was especially shown in the choice of his steward Ford, from whom he had borrowed money, and who, by dexterous swindling, had managed, at the time of his death, to establish, and hand down to his widow and son, a claim for £14,000 against Penn. Penn, however, refused to pay, and spent nine months in the Fleet rather than give way. He was released at length by his friends, who paid £7500 in composition of all claims. Difficulties with his government of Pennsylvania continued to harass him. Fresh disputes took place with Lord Baltimore, the owner of Maryland, and Penn also felt deeply what seemed to him the ungrateful treatment which he met with at the hands of the assembly. He therefore in 1710 wrote, in earnest and affectionate language, an address to his "old friends," setting forth his wrongs. So great was the effect which this produced that the assembly which met in October of that year was entirely in his interests; revenues were properly paid; the disaffected were silenced and complaints

were hushed; while an advance in moral sense was shown by the fact that a bill was passed prohibiting the importation of negroes. This, however, when submitted to the British parliament, was cancelled. Penn now, in February 1712, being in failing health, proposed to surrender his powers to the Crown. The commission of plantations recommended that Penn should receive £12,000 in four years from the time of surrender. Penn stipulating only that the queen should take the Quakers under her protection; and £1000 was given him in part payment. Before, however, the matter could go further he was seized with apoplectic fits, which shattered his understanding and memory. A second attack occurred in 1713. He died on the 30th of May 1718, leaving three sons by his second wife, John, Thomas and Richard, and was buried along with his first and second wives at Jourdan's meeting-house, near Chalfont St Giles in Buckinghamshire. In 1790 the proprietary rights of Penn's descendants were bought up for a pension of £4000 a year to the eldest male descendant by his second wife, and this pension was commuted in 1884 for the sum of £67,000.

Penn's *Life* was written by Joseph Besse, and prefixed to the collected edition of Penn's *Works* (1726); see also the bibliographical note to the article in *Dict. Nat. Biog.* W. Hepworth Dixon's biography, refuting Macaulay's charges, appeared in 1851. In 1907 Mrs Colquhoun Grant, one of Penn's descendants, brought out a book, *Quaker and Courtier: the Life and Work of William Penn.* (O. A.)

PENNANT, THOMAS (1726–1798), British naturalist and antiquary, was descended from an old Welsh family, for many generations resident at Downing, Flintshire, where he was born on the 14th of June 1726. He received his early education at Wrexham, and afterwards entered Queen's College, Oxford, but did not take a degree. At twelve years of age he was inspired with a passion for natural history through being presented with Francis Willughby's *Ornithology*; and a tour in Cornwall in 1746–1747 awakened his strong interest in minerals and fossils. In 1750 his account of an earthquake at Downing was inserted in the *Philosophical Transactions*, where there also appeared in 1756 a paper on several coralloid bodies he had collected at Coalbrookdale, Shropshire. In the following year, at the instance of Linnaeus, he was elected a member of the Royal Society of Upsala. In 1766 he published the first part of his *British Zoology*, a work meritorious rather as a laborious compilation than as an original contribution to science. During its progress he visited the continent of Europe and made the acquaintance of Buffon, Voltaire, Haller and Pallas. In 1767 he was elected F.R.S. In 1771 was published his *Synopsis of Quadrupeds*, afterwards extended into a *History of Quadrupeds*. At the end of the same year he published *A Tour in Scotland in 1769*, which proving remarkably popular was followed in 1774 by an account of another journey in Scotland, in two volumes. These works have proved invaluable as preserving the record of important antiquarian relics which have now perished. In 1778 he brought out a similar *Tour in Wales*, which was followed by a *Journey to Snowdon* (pt. i. 1781; pt. ii. 1783), afterwards forming the second volume of the *Tour*. In 1782 he published a *Journey from Chester to London*. He brought out *Arctic Zoology* in 1785–1787. In 1790 appeared his *Account of London*, which went through a large number of editions, and three years later he published the *Literary Life of the late T. Pennant, written by himself*. In his later years he was engaged on a work entitled *Outlines of the Globe*, vols. i. and ii. of which appeared in 1798, and vols. iii. and iv., edited by his son David Pennant, in 1800. He was also the author of a number of minor works, some of which were published posthumously. He died at Downing on the 16th of December 1798.

PENNAR, or **PENNER**, two rivers of southern India, distinguished as North and South. The native name is Pinakini. Both rise near the hill of Nandidrug in Mysore state, and flow eastward into the Bay of Bengal. The northern is the more important and has a total length of 355 m., that of the southern being 245 m. This latter bears the alternative name of the Ponnir. The Pennar (northern) river canal system comprises more than 30 m. of canals, irrigating 155,500 acres.

PENNE, a town and episcopal see of Italy, in the province of Teramo, 26 m. S.E. of Teramo, and 26 m. inland from the Adriatic, 1437 ft. above sea-level. Pop. (1901), 10,394. The cathedral has been much altered; in its treasury is some fine 13th (?) century silversmiths' work; the church of S. Giovanni has a fine cross by Nicola di Guardiagrele, and that of S. Maria in Colleromano, outside the town, a Romanesque portal. Many of the houses have fine terra-cotta friezes. It occupies the site of the ancient Pinna, the chief city of the Vestini, who entered into alliance with Rome in 307 B.C. and remained faithful to her through the Hannibalic wars and even during the revolt of the Italian allies in 90 B.C. No remains of the Roman period exist, even the city walls being entirely medieval.

See G. Colasanti, *Pinna* (Rome, 1907); V. Bindi, *Monumenti degli Abruzzi* (Naples, 1889, pp. 365 sqq.).

PENNELL, JOSEPH (1860–), American artist and author, was born in Philadelphia on the 4th of July 1860, and first studied there, but like his compatriot and friend, J. M. Whistler, he afterwards went to Europe and made his home in London. He produced numerous books (many of them in collaboration with his wife, Elizabeth Robins Pennell), but his chief distinction is as an original etcher and lithographer, and notably as an illustrator. Their close acquaintance with Whistler led to Mr and Mrs Pennell undertaking a biography of that artist in 1906, and, after some litigation with his executrix on the right to use his letters, the book was published in 1908.

PENNI, GIANFRANCESCO (1488–1528), Italian painter, surnamed "Il Fattore," from the relation in which he stood to Raphael, whose favourite disciple he was after Giulio Romano, was a native of Florence, but spent the latter years of his life in Naples. He painted in oil as well as in fresco, but is chiefly known for his work in the Loggia of the Vatican.

PENNINE CHAIN, an extensive system of hills in the north of England. The name is probably derived from the Celtic *pen*, high, appearing in the Apennines of Italy and the Pennine Alps. The English system is comprised within the following physical boundaries. On the N. a well-marked depression, falling below 500 ft. in height, between the upper valleys of the Irthing and the south Tyne, from which it is known as the Tyne Gap, separates the Pennines from the system of the Cheviots. On the N.E., in Northumberland, the foothills extend to the North Sea. On the N.W. the Eden valley forms part of the boundary between the Pennines and the hills of the Lake District, and the division is continued by the upper valley of the Lune. For the rest the physical boundaries consist of extensive lowlands—on the E. the vale of York, on the W. the coastal belt of Lancashire and the plain of Cheshire, and on the S. and S.E. the valley of the river Trent. The Pennines thus cover parts of Cumberland, Westmorland and Northumberland, Lancashire and Yorkshire, Cheshire and Derbyshire, while the southern foothills extend into Staffordshire and Nottinghamshire.

The Pennine system is hardly a range, but the hills are in effect broken up into numerous short ranges by valleys cut back into them in every direction, for the Pennines form a north and south watershed which determines the course of all the larger rivers in the north of England. The chain is divided into two sections by a gap formed by the river Aire flowing east, a member of the Humber basin, and the Ribble flowing west and entering the Irish Sea through a wide estuary south of Morecambe Bay.

The northern section of the Pennine system is broader and generally higher than the southern. Its western slope is generally short and steep, the eastern long and gradual; this distinction applying to the system at large. In the north-west a sharp escarpment overlooks the Eden valley. This is the nearest approach to a true mountain range in the Pennine system and indeed in England. It is known as the Cross Fell Edge from its highest point, Cross Fell (2930 ft.), to the south-east of which a height of 2780 ft. is reached in Milburn Forest, and of 2391 ft. in Mickle Fell. This range is marked off eastward by the upper valleys of the south Tyne and the Tees, and, from the divide between these two, branch ranges spring eastward, separated by the valley of the Wear, at the head of which are Burnhope Seat (2452 ft.) and Dead Stones (2326 ft.). In the northern range the highest point is Middlehope Moor (2206 ft.), and in the southern, Chapel Fell Top (2294 ft.). It is thus seen that the

higher elevations, like the steeper slopes, lie towards the west. Cross Fell Edge terminates southward at a high pass (about 1400 ft.) between the head of the Belah, a tributary of the Eden, and the Greta, a tributary of the Tees. This pass is followed by the Tebay and Barnard Castle line of the North Eastern railway. The hills between the Lune valley on the west and the headstream of the Eden and the Ribbles on the east are broken into masses by the dales of tributaries to the first-named river—here the chief elevations are Wild Boar Fell (2323 ft.), Whersnide (2414 ft.), and Ingelborough (2373 ft.). The Ribbles and Eden valleys afford a route for the main line of the Midland railway. Well-marked eastward ranges occur here between Swaledale and the river Ure, which traverses the celebrated Wensleydale (q.v.), and between the Ure and Wharfe. In the first the highest points are High Seat (2328 ft.) and Great Shunner Fell (2340 ft.); and in the second Buckden Pike (2302 ft.) and Great Whersnide (2310 ft.). There is then a general southerly slope to the Aire gap.

The southern section of the system calls for less detailed notice. Heights exceeding 2000 ft. are rare. The centre of the section is the well-known Peak (q.v.) of Derbyshire. Both here and throughout the system the summits of the hills are high uplands, rounded or nearly flat, consisting of heathery, peaty moorland or hill pasture. The profile of the Pennines is thus not striking as a rule, but much fine scenery is found in the narrow dales throughout; Wensleydale, Wharfedale and other Yorkshire dales being no less famous than the dales of Derbyshire. In the parts about Settle below Ingelborough, in Derbyshire, and elsewhere, remarkable caverns and subterranean watercourses in the limestone have been explored to great depths. In Ingelborough itself are the Ingelborough cave, near Clapham; the chasm of Gaping Ghyll, over 350 ft. deep; Helln or Hellan Pot, a vast swallow-hole 359 ft. deep, only exceeded by Rowten Pot (365 ft.) near Whersnide; and many others. Malham Tarn, near the head of the Aire, is drained by a stream which quickly disappears below ground, and the Aire itself is fed by a brook gushing forth in full stream at the foot of the cliffs of Malham Cove. A notable example in Derbyshire is the disappearance of the Wye into Plunge Hole, after which it traverses Poole's Cave, close to Buxton. There may also be noted the remarkable series of caverns near Castleton (q.v.). Lakes are few and small in the Pennine district, but in some of the upland valleys, such as those of the Nidd and the Etherow, reservoirs have been formed for the supply of the populous manufacturing districts of Lancashire and the West Riding of Yorkshire, which lie on either flank of the system between the Aire gap and the Peak. (For geology see ENGLAND and articles on the several counties.)

PENNSYLVANIA, a North Atlantic state of the United States of America and one of the original thirteen, lying for the most part between latitudes $39^{\circ} 43' 26.3''$ and $42^{\circ} N.$ and between longitudes $74^{\circ} 40'$ and $80^{\circ} 31' 36'' W.$ The state is in the form of a rectangle, except in the north-west where a triangular projection, extending to $42^{\circ} 15' N. lat.$, gives it a shoreline of almost 40 m. on Lake Erie, on the east where the Delaware river with two large bends separates it from New York and New Jersey, and in the south-east where the arc of a circle which was described with a 12-m. radius from New Castle, Delaware, forms the boundary between it and Delaware. The forty-second parallel of N. latitude forms the boundary between it and New York on the N.; Mason and Dixon's line is the border between it and Maryland and West Virginia on the south and a north and south line marks the boundary between it and West Virginia and Ohio on the west. The total area is 45,126 sq. m. and of this 294 sq. m. are water surface.

Physical Features.—Pennsylvania skirts the coastal plain in the south-east below Philadelphia, is traversed from north-east to south-west by the three divisions of the Appalachian province—Piedmont or older Appalachian belt, younger Appalachian ridges and valleys and Allegheny plateau—and in the north-west corner is a small part of the Erie plain. The entire surface has a mean elevation of about 1100 ft. above the sea. It rises from 20 ft. or less on the bank of the Delaware between Philadelphia and Chester to 3000–3000 ft. on the higher ridges in the middle section (3136 ft. on Blue Knob in Bedford county), and falls again to 900–1000 ft. on the Ohio border and to 750 ft. or less on the Erie plain; in the south-east is an area of about 6100 sq. m. that is less than 500 ft. above the sea, while on the ridges in the middle of the state is an aggregate area of about 2000 sq. m. that everywhere exceeds 2000 ft. in elevation. The area below 500 ft. is mostly in the Triassic lowland of the Piedmont region, or, as the Pennsylvania portion of it is called, the south-east province. This is an undulating plain which has been produced by the wearing away of weak sandstones, &c. On the north and west borders of this plain are two parts of a chain of semi-detached and usually rounded hills, known as the South Mountains. The north-east part is a south-westward arm of the New England uplands, is known as the Reading Prong, and extends from New Jersey through Easton to

Reading. The south-west part is a north-eastern prolongation of the Virginia Piedmont, is known as the Cumberland Prong, and extends N.N.E. through the south part of Cumberland county. In the Reading Prong most of the hills rise 900–1000 ft. above the sea and about one-half that height above the surrounding country; in the Cumberland Prong their height increases to the southward until, on the Maryland border, they rise 2100 ft. above the sea and 1400 ft. above the adjoining plain. Another range of hills, known as the Trenton Prong, extends from the northern suburbs of Philadelphia both westward and southward through Chester, Delaware, Lancaster and York counties, but these rise only 400–600 ft. above the sea and have few steep slopes. Both of these ranges of hills are composed of hard crystalline rocks, and between them lies the lowland eroded on the weaker sandstones and sediments. In Bucks and Montgomery counties is a large sandstone area; traversing Chester county is the narrow Chester Valley with a limestone bottom, and in Lancaster county is the most extensive limestone plain. The Pennsylvania portion of the younger Appalachian ridges and valleys, known as the central province of the state, embraces the region between the South Mountains, on the south-east, and the crest of the Allegheny plateau or Allegheny Front, on the north-west. It extends from south-west to north-east about 230 m. and has a nearly uniform width of 50 m. except that it narrows rapidly as it approaches the north-east corner of the state. The ridges and intervening valleys, long parts of which have an approximately parallel trend from south-west to north-east, were formed by the erosion of folded sediments of varying hardness, the weak belts of rock being etched out to form valleys and the hard belts remaining as mountain ridges. After the folding the whole region was worn down nearly to sea-level, forming a low plain which bevelled across the geological structure of the entire state, including the Piedmont area to the south-east and the plateau area to the north-west. Then came a broad uplift followed by the erosion which carved out the valleys, leaving hard rocks as mountain ridges which rise about to the level of the old erosion plain. In Bedford county and elsewhere the ridges rise to 2400 ft. or more above the sea, but their more usual height is 1400 to 2000 ft. above the sea and 500 to 1000 ft. above the intervening valleys. Their crest lines are often of nearly uniform height for miles and generally are little broken except by an occasional V-shaped wind gap, a narrow water gap or a rounded knob. The valleys rarely exceed more than a few miles in width, are usually steep-sided, and frequently are traversed by longitudinal ranges of hills and cross ridges; but the Pennsylvania portion of the Appalachian or Great Valley, which forms a distinct division of the central province and lies between the South Mountains and the long rampart of Blue Mountain, is about 10 m. in width on the Maryland border and to the north-east its width increases to 20 m. The north-west part of it is a slate belt that has been much dissected by eroding streams, but the south-east part is a gently rolling belt of limestone to which occasionally a steep hill descends from the slate belt. The Pocono plateau, into which the central province merges at its north-east extremity, is a continuation of the Catskill plateau southward from New York and covers Wayne, Pike and Monroe counties and the east portion of Carbon county. Its surface is underlain by a hard sandstone and conglomerate which erode slowly, and the general upland level, which is 1400–1800 ft. above the sea, is little broken except by shallow valleys and occasional knobs. The Allegheny plateau, which extends from the crest of the Allegheny Front to and beyond the west and north borders of Pennsylvania and covers more than one-half of the state, is much more dissected. In Tioga and Potter counties on the north middle border, it rises 2400–2500 ft. above the sea, but from this height the general upland level falls gradually to 1200–1300 ft. in the south-west and 900–1000 ft. along the Ohio border, and in Erie county there is a sudden fall of about 200 ft. to the Erie plain. In the northern, middle and south-west portions of this plateau province the upland is cut by an intricate network of narrow valleys and ravines that are commonly 300–600 ft. deep and occasionally 800–1000 ft. deep, but west of the Allegheny river, where harder rocks have resisted such deep dissection and glacial drift has filled depressions or smoothed rough surfaces, the uplands are broader and the valleys wider and shallower. Most of the Pennsylvania shore of Lake Erie is lined with a wall of sand and clay 50–100 ft. in height and along the foot of this is only a narrow beach, but in front of the city of Erie the shore currents have formed a spit, known as Presque Isle, which affords a good harbour.

The Pocono plateau, nearly all of the central and south-east provinces and the north-east portion of the Allegheny plateau are drained by the Susquehanna and Delaware river-systems into the Chesapeake and Delaware Bays; the greater part of the Allegheny plateau is drained by the Allegheny and Monongahela rivers into the Ohio river; the extreme southern portion of the central province and the extreme western portion of the south-east province are drained by tributaries of the Potomac; the Erie plain is drained by short streams into Lake Erie; and a very small section of the Allegheny plateau, in the northern part of Potter county, is drained by the Genesee river into Lake Ontario. The Susquehanna drains about 21,000 sq. m. of the state; the Ohio, Allegheny and Monongahela

14,747 sq. m.; and the Delaware 6,443 sq. m. The Susquehanna is a wide and shallow stream with a zigzag course and numerous islands, but both the Susquehanna and the Delaware, together with their principal tributaries, flow for the most part transverse to the geological structure, and in the gorges and water-gaps through which they pass ridges in the mountain region, is some of the most picturesque scenery in the state; a number of these gorges, too, have been of great economic importance as passages for railroads. The lower portion of the Delaware river has been entered by the sea as the result of the depression of the land, giving a harbour, at the head of which developed the city of Philadelphia. The present course of the Upper Allegheny river is the result of the glacier which blocked the northward drainage of the region through which it flows and turned it southward. The Monongahela is an older stream, but like the Allegheny, it meanders much, and both rivers flow in deeply entrenched valleys. The few small lakes of the state are mostly on the Pocono plateau, where they were formed by glaciation; here, too, are some streams with picturesque cascades.

Fauna.—Under the protection of a game commission which was created in 1895, of some game preserves which have been established by this commission, and of various laws affecting wild animals and birds, the numbers of Virginia deer, black bear, rabbits, ruffed grouse, quail and wild turkeys have increased until in some of the wilder sections they are quite plentiful, while the numbers of weasels, minks, lynx and foxes have been diminished. Squirrels, racoons, woodchucks and skunks are common, and musk-rats, porcupines and opossums are found in some sections. Two species of venomous snakes—the rattlesnake and the copper-head—occur in the sparsely settled regions. The avifauna include—among the birds of prey—the red-shouldered hawk, red-tailed hawk, marsh hawk, Cooper's hawk, sharp-shinned hawk and sparrow hawk, the great horned owl, the barn owl and the screech owl; and bald eagles are not uncommon in the mountainous regions along the larger rivers. The "turkey-buzzard"—turkey-vulture—(very valuable as a scavenger) is seen occasionally, especially in the south and south-west. The game birds include the ruffed grouse, quail and English pheasant (which have increased rapidly under protection), besides woodcock, snipe, many species of ducks and a few Canada geese. The song and insectivorous birds—thrushes, flycatchers, vireos and woodpeckers—of this latitude, are well represented, and the high plateaus (particularly the Pocono plateau) have special ornithological interest as the tarrying-places, during the migratory seasons, of many species of birds whose natural breeding ground is much farther north. Perch, sunfish, trout, bass, pike and pickerel abound in many of the streams. Yellow perch are especially plentiful in the lakes on the Pocono plateau. Pike-perch and a few blue pike are taken in the Susquehanna, where shad are no longer plentiful since work was begun on McCall's Ferry dam, and in 1908 the entire catch for the river was valued at about \$20,000, but in the Delaware there are valuable shad and herring fisheries. The blue pike, whitefish and herring, obtained on Lake Erie are of considerable commercial importance. In 1908 the total catch on Lake Erie was valued at \$200,869, the principal items being herring (\$90,108), blue pike (\$13,657) and whitefish (\$31,580). The catch of herring was twice as much in 1908 as in 1907 and that of whitefish nearly four times as much in 1908 as in 1907; this increase was attributed to the work of the state hatcheries. There were eight hatcheries in 1910 and the number of fish distributed from these during 1908 was about 662,000,000; they consisted chiefly of pickerel, yellow perch, walleyed pike, white fish, herring, blue pike, trout and shad.

Flora.—Except on some portions of the Pocono plateau, Pennsylvania was originally well forested, and although most of the merchantable timber has been cut, about one-half of the state is still woodland. On the higher elevations the trees are mostly white pine, yellow pine and hemlock, but in the valleys and lower levels are oaks, hickories, maples, elms, birches, locusts, willows, spruces, gums, buckeyes, the chestnut, black walnut, butternut, cedar, ash, linden, poplar, buttonwood, hornbeam, holly, catalpa, magnolia, tulip-tree, Kentucky coffee-tree, sassafras, wild cherry, pawpaw, crab-apple and other species. The flora is most varied in the Susquehanna Valley below Harrisburg, and on Presque Isle are some plants peculiar to the Lake region. The state has forest reserves (918,000 acres in 1910) in 26 counties, the largest areas being in Potter, Clinton, Center, Cameron, Lycoming, Huntingdon, Union and Mifflin counties; and there is an efficient department of forestry under a state commissioner of forestry, at Mont Alto, where there is only one in the United States; its first class graduate any city, borough or township of the first class to acquire, subject to the approval of the commissioner of forestry, a municipal forest; and it authorized the distribution of seedling forest trees, at cost, to those who would plant and protect them, for growing private forests.

Climate.—The temperature is quite mild and equable in the south-east province where the ocean influences it and where the mountains bounding it on the north and north-west are some protection from the colder winds. The crests of the higher ridges in the central province are delightfully cool in summer, but the

adjacent valleys are subject to excessive heat in summer and severe cold in winter. The mean annual temperature decreases to the north-westward on the Allegheny plateau, but on the Erie plain, in the extreme north-west, Lake Erie exerts its moderating influence, the mean temperature rises, and extremes shorten. The mean annual temperature in the south-east province is about 52° F.; it decreases to 50° in the central province and to 47° or less in some of the north-west counties of the Allegheny plateau, but rises to 49° on the shore of Lake Erie. At Philadelphia the mean temperature in winter (December, January and February) is 34°, the mean temperature in summer (June, July and August) is 74°, and the range of extremes here for a long period of years ending with 1907 was within 103° and 6°. At Huntingdon, Huntingdon county, in the Juniata Valley, the winter mean is 30°, the summer mean 71°, and within the period from 1888 to 1907 extremes ranged from 104° to 23°. The summer maxima on the mountains are usually 8° to 10° less than in the valleys directly below them; Saegerstown, Crawford county, is nearly 30 m. south of Erie, on Lake Erie, and yet the winter mean is 28° at Erie and only 25° at Saegerstown, and the lowest temperature on record for Erie is -16° while for Saegerstown it is -27°. During the period from 1875 to 1908 inclusive, extremes within the state ranged from 107° at York, York county, in July 1901, to -42° at Smithport, McKean county, in January 1904. July is the warmest month in all parts of the state. January is the coldest in some and February in others. The average annual rainfall is 44 in. It is 50 in. or more in some regions along the south-east border of the mountain district or farther south-east where the rains are occasionally heavy, and it is less than 40 in. in some of the north-east and south-west counties. The amount of rainfall during the summer is about 3 in. more than that during either autumn or winter and 2 in. more than that during spring. In the mountain region and in the vicinity of Lake Erie there is often a fall of several inches of snow during the winter months and the rapid melting of this produces floods on the Delaware, Susquehanna and Ohio rivers and some of their tributaries. The prevailing winds are westerly, but they are frequently interrupted by warm breezes from the south, or moisture-bearing currents from the east.

Soils.—The most productive soil is that in the south-east section of the Great Valley and in Chester Valley where it is derived largely from limestone. There is some of the same formation as well as that derived from red shales on the sandstone hills in the south-east province and in many of the middle and western valleys, but often a belt of inferior slate soil adjoins a limestone belt, and many of the ridges are covered with a still more sterile soil derived from white and grey sandstones. The north-west and north-east sections contain some glacial drift but the soil in these parts is not suitable for cultivation except in the larger valleys in the north-west where it is drained by glacial gravel or there is some sandy loam mixed with clay.

Agriculture.—Pennsylvania is noted for its mineral wealth and manufactures rather than for its agricultural resources, but in 1900 about two-thirds of its land was included in farms, a little more than two-thirds of its farm-land was improved, and in several crops the state has long ranked high. The number of farms increased from 127,577 in 1850 to 224,248 in 1900, the increase resulting in part from a reduction of their size but more largely from the appropriation of new lands for farming purposes. The average size in 1900 was 86.4 acres. Nearly 60% of them contained less than 100 acres and only about 2.7% contained 260 acres or more. More than seven-tenths (160,105) were worked by owners or part owners, and only 34,529 by share tenants, and 23,737 by cash tenants. Hay, Indian corn, wheat, oats, potatoes, fruits, vegetables and tobacco are the principal crops. Of the total crop acreage in 1899 nearly two-fifths was devoted to hay and forage, and the value of the hay crop in 1909¹ (when the crop was 3,742,000 tons, valued at \$54,633,000) was greater than that of any other state in the Union except New York. Hay is grown in largest quantities in the north, and in the section south-east of Blue Mountain. More than one-half of the crop acreage in 1899 was devoted to cereals, and of the total cereal acreage 32% was of wheat, 31.2% was of Indian corn, 24.8% was of oats, 6.5% was of rye, and 5.3% was of buckwheat. The product of Indian corn was 48,800,000 bushels in 1909; of wheat 26,265,000 bushels; of oats 25,948,000 bushels; of barley 196,000 bushels; of rye 5,508,000 bushels; and of buckwheat 5,665,000 bushels.

Indian corn, wheat and rye, are cultivated most extensively in the south-east counties. Some of the larger oat-producing counties also are in the south-east, but most of the buckwheat, barley and oats are grown in the north and west counties. The dairy business, for which much of the hay crop is needed, has grown with the growth of the urban population as is shown in part by a steady increase in the number of dairy cows from 530,224 in 1850 to 1,140,000 in 1910; the value of the dairy products in 1899 (\$35,860,110) was exceeded only in New York. The number of other cattle has fluctuated somewhat, but there were 917,000 in 1910 as against 623,722 in 1850. Horses increased in number

¹ Statistics for 1909 and 1910 are from the Year Book of the United States Department of Agriculture.

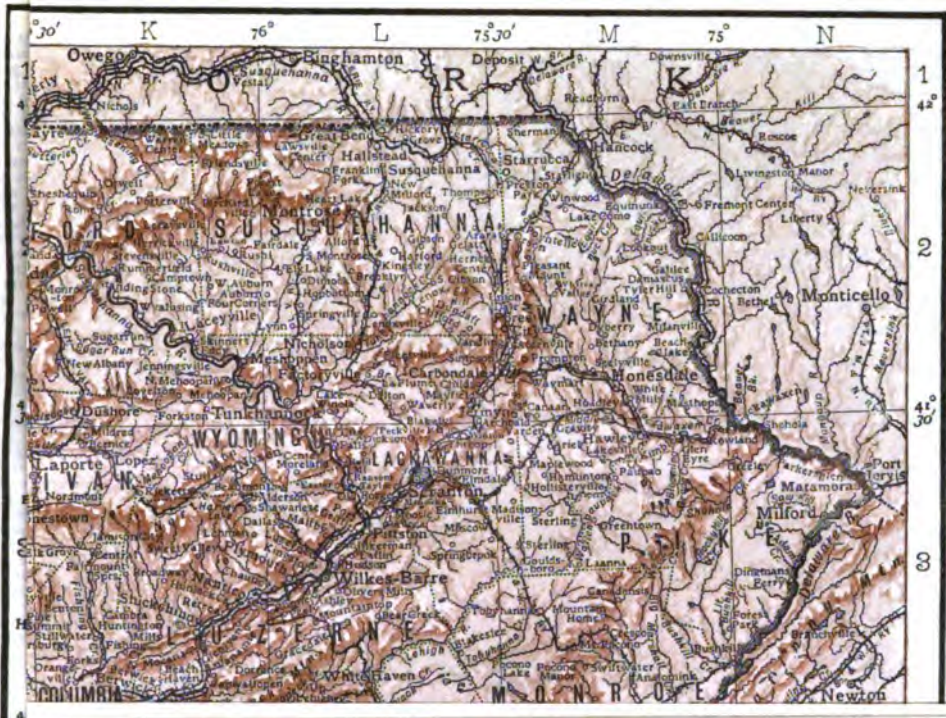



from 350,398 in 1850 to 610,000 in 1910. The number of mules increased steadily from 2259 in 1850 to 43,000 in 1910. The raising of sheep and swine was of considerably less relative importance in 1910 than in 1850, there being 1,882,357 sheep and 1,040,366 swine in 1850 and 1,112,000 sheep and 931,000 swine in 1910. The dairy business is largest in the regions around Philadelphia and Pittsburg, and in Erie and Bradford counties. Cattle other than dairy cows as well as horses and sheep are most numerous in the western counties, in Bradford county on the north border, and in some of the counties of the south-east. Swine are most numerous in the south-east and south-west counties. The state ranks high in the production of potatoes, cabbages, lettuce and turnips, and it produces large crops of sweet Indian corn, tomatoes, cucumbers, musk-melons, asparagus and celery. The total value of all vegetables produced in 1899 was \$15,832,904, an amount exceeding that of any other state except New York. A large portion of the vegetables are grown in the vicinity of Philadelphia or in the vicinity of Pittsburg. The culture of tobacco, which was introduced as early as 1689, was a small industry until the middle of the 19th century, but it then developed rapidly except during a brief interruption caused by the Mexican War. In 1909 the crop was 30,732,000 lb. More than two-thirds of the state's crop of 1899 was produced in Lancaster county, which is one of the largest tobacco-producing counties in the United States, and most of the other third was produced in York, Tioga, Bradford and Clinton counties. Apples, cherries and pears are the principal orchard fruits. Grapes, peaches, plums and prunes, apricots, strawberries, raspberries and loganberries, blackberries and dewberries, currants and gooseberries are also grown. Orchard fruits are most abundant south-east of Blue Mountain, and small fruits near the larger cities, but about two-thirds of the grapes are grown in Erie county. Floriculture is an important industry in Philadelphia and its vicinity. The sale of nursery products, more than one-half of which were grown in Chester and Montgomery counties, amounted in 1899 to \$541,032, and although this was less than one-third that of New York it was exceeded in only three other states.

Minerals.—Pennsylvania is by far the most important coal-producing state in the Union, and as much of the iron ore of the Lake Superior region is brought to its great bituminous coal-field for rendering into pig-iron, the value of the state's mineral products constitutes a large fraction of the total value for the entire country; in 1907, when the value of the mineral products of the state was \$657,783,345, or nearly one-third that of all the United States, and in 1908 when the total for the state was \$473,083,212, or more than one-fourth that of the whole United States, more than four-fifths of it was represented by coal and pig-iron. With the exception of two small areas in Colorado and New Mexico, Pennsylvania contains the only anthracite-coal region in the country. This is in the east of the state, and although it has a total area of about 3300 sq. m., its workable measures are mostly in Lackawanna, Luzerne, Carbon, Schuylkill and Northumberland counties in an area of less than 500 sq. m. This coal was discovered as early as 1762 near the site of the present city of Wilkes-Barre and during the War of Independence it was used at Carlisle in the manufacture of war materials, but it was of little commercial importance until early in the next century. In 1815 the output was reported as only 50 tons, but it steadily rose to 74,347,102 tons (valued at \$158,178,849) in 1908. Besides having practically all the anthracite, Pennsylvania has the thickest bituminous coal-measures, and most of the coal obtained from these is of the best quality. They form the northern extremity of the great Appalachian coal-field and underlie an area of 15,000 sq. m. or more in the west of the state. The Pittsburg district, comprising the counties of Allegheny, Washington, Fayette and Westmoreland, is exceptionally productive, and the coal in Allegheny and Washington counties is noted for its gas-producing qualities, while in Fayette and Westmoreland counties is obtained the famous Connellsville coking coal. The bituminous coal was first used at nearly the same time as the anthracite and it was first shipped from Pittsburg in 1803. In 1840 the state's output was 464,826 tons. It increased to 1,000,000 tons in 1850, to 11,760,000 tons in 1875, to 79,842,326 tons in 1900, to 150,143,177 tons in 1907; and was 117,179,527 tons in 1908, when it was 35.2% of that of the entire country and was valued at \$118,816,303. In 1880 the output of coal (anthracite and bituminous) in Pennsylvania was 66% of that of the entire country; in 1908 it was 48.2%; but in the latter year the Pennsylvania mines produced more coal than the combined production of all the countries of the world excepting Great Britain, Germany and Austria-Hungary, and it was nearly four times as much as the total mined in Austria, nearly five times as much as that mined in France, and seven times as much as the output of Russia in that year. Extending from the south-west corner of the state through Greene, Washington, Allegheny, Beaver, Butler, Venango, Clarion, Forest, Elk, Warren, McKean and Tioga counties is the Pennsylvania section of the Appalachian oil-field which, with the small section in New York, furnished nearly all of the country's supply of petroleum for some years following the discovery of its value for illuminating purposes. The mineral was made known to white men by the Indians, who sold it, under the name of Seneca oil, as a cure for various ills, and burned it at some of their ceremonies. The early settlers in

west Pennsylvania also found that some unknown people had dug pits several feet in depth around the oil springs apparently for the purpose of collecting the oil. But it was not until the middle of the 19th century that its value as an illuminating oil became known, and not until 1839 was the first petroleum well drilled. This was the Drake well, on the flats of Oil Creek at Titusville; it was about 70 ft. in depth, and when 25 barrels were pumped from it in a day its production was considered enormous. By the close of 1861 wells had been drilled from which 2000 to 3000 barrels flowed in a day without pumping, and the state's yearly output continued to increase until 1891, when it amounted to 31,424,206 barrels. Since then, however, wells have been going dry, and when, in 1895, the output fell to 19,144,390 barrels it was exceeded by that of Ohio. It went down quite steadily to 9,424,325 in 1908, and in that year Pennsylvania was out-ranked as an oil-producing state by Oklahoma, California, Illinois, Texas and Ohio. In drilling for some of the first oil wells gas escaped, and in a few instances this was used as a fuel for generating steam in the boilers of the drilling-engines. In some instances, too, wells which were drilled for oil produced only gas. A little later, about 1868, successful experiments were made with gas as a manufacturing fuel, and in 1872 the gas industry was fairly well established near Titusville by drilling a well and piping the gas for consumption both as fuel and light. The value of the state's output increased from approximately \$75,000 in 1882 to approximately \$19,282,000 in 1898, and the total value of its output during these and the intervening years was more than 80% that of all the United States. The industry then became of greater importance in several other states and declined in Pennsylvania until in 1896 the value of Pennsylvania's product amounted to only \$5,528,610, or 42.5% of that of the United States. This temporary decline was, however, followed by a rather steady rise and in 1908 the output was valued at \$19,104,944, which was still far in excess of that of any other state and nearly 35% of that of the entire country. The gas region has an area of about 15,000 sq. m. and embraces about all of the Pennsylvania section of the Allegheny plateau except a narrow belt along its east and south-east border. There are deposits of various kinds of iron ore in the eastern, south-eastern, middle and some of the western counties, and from the middle of the 18th century until near the close of the 19th Pennsylvania ranked high among the iron-ore-producing states. As late as 1880 it ranked first, with a product amounting to 1,951,496 long tons. But the state's iron foundries moved rapidly westward after the first successful experiments in making pig-iron with bituminous coal, in 1845, and the discovery, a few years later, that rich ore could be obtained there at less cost from the Lake Superior region resulted in a decline of iron-mining within the state until, in 1902, the product amounted to only 822,932 long tons, 72.2% of which was magnetite ore from the Cornwall mines in Lebanon county which have been among the largest producers of this kind of ore since the erection of the Cornwall furnace in 1742. In 1908 the entire iron-ore product of the state, amounting to 443,161 long tons, was not 1.3% of that of the United States, but the production of the magnetite-ore alone (343,998 long tons) was more than one-fifth that of all the United States. In the manufacture of pig-iron Pennsylvania is easily first among the states, with a product value in 1908 of \$111,385,000, nearly 43.8% of that of the entire country. Pennsylvania has extensive areas of limestone rock suitable for making cement, and in Northampton and Lehigh counties enormous quantities of it are used in this industry. Natural-rock cement was first made in the state soon after the discovery, in 1831, of deposits of cement rock near Williamsport, Lycoming county, and the industry was greatly promoted in 1850 when the vast deposits in the lower Lehigh Valley were discovered and large quantities of cement were required in the rebuilding of the Lehigh Canal. Competition produced in Lehigh county the first successful Portland cement plant in the United States in 1870. The output of the natural-rock cement continued greater than that of the Portland until 1896, but for the succeeding ten years the enormous development of the cement industry was almost entirely in the Portland branch, its production in the state increasing from 825,054 barrels in 1896 to 8,770,434 barrels in 1902, and to 18,254,806 barrels (valued at \$13,899,807) in 1908, when it was more than 30% of that of the United States. The production of natural-rock cement was 608,000 barrels in 1896 and only 252,479 barrels (valued at \$87,192) in 1908. Limestones and dolomites suitable for building purposes are obtained chiefly in Montgomery, Chester and Lancaster counties, and even these are generally rejected for ornamental work on account of their colour, which is usually bluish, grey or mottled. However until increased facilities of transport brought more desirable stones into competition they were used extensively in Philadelphia and with them the main building of Girard College and the United States Naval Asylum were erected and the long rows of red-brick residences were trimmed. There are limestone quarries in nearly two-thirds of the counties and great quantities of the stone are used for flux in the iron furnaces, for making quicklime, for railway ballast and for road making. The total value of the limestone output in 1908 amounted to \$4,057,471, and the total value of all stone quarried was \$6,371,152. In Dauphin county is a quarry of bluish-brown Triassic sandstone that has been used extensively

especially in Philadelphia, for the erection of the so-called brown stone fronts. On the Pocono plateau is a large deposit of a fine-grained dark-blue stone of the Devonian formation which is known as the Wyoming Valley stone, and, like the New York "bluestone," which it closely resembles, is much used for window and door trimmings, steps and flagging. Several of the western counties contain Carboniferous or sub-Carboniferous sandstones that are used locally for building and for various other purposes. In 1908 the value of Pennsylvania sandstone and bluestone was \$1,368,784. Northampton, Lehigh and York counties contain the most productive slate quarries in the country, and in 1908 the value of their output was \$3,902,983; the Northampton and Lehigh slate is the only kind in the United States used for school blackboards. There is an extensive area in the southeast part of the state containing shale clay of a superior quality for making common brick. Kaolin abundantly in Chester and Delaware counties, and fire-clay in several of the western counties. In 1908 the state ranked first in the value of its output of brick and tile (\$18,981,743), which was 14.74 % of the entire product of the United States, and was second only to Ohio in the total value of its clay products (\$14,842,982), which was 11.14 % of that for the entire country. Glass sand abundantly both in the eastern and in the western sections and for many years Pennsylvania has used this more extensively in the manufacture of glass than any other state. Deposits of crystalline graphite are found in Chester and Berks counties. In Chester county, also, is one of the most productive deposits of feldspar, second in importance only to those of Maine. Soapstone is quarried in Montgomery and Northampton counties, phosphate rock, in Juniata county; rocks from which mineral paints are made, in several counties, and there is some garnet in Delaware county.

Manufactures.—The state ranks second to New York in the value of its manufactures, which increased from \$155,044,910 in 1890 to \$1,955,551,332 (factory products alone) in 1905, a growth which has been promoted by an abundance of fuel, by a good port on the Atlantic seaboard, by a network of canals which in the early years was of much importance in connecting the port with the Mississippi river system, by its frontage on Lake Erie, which makes the ores of the Lake Superior region easily accessible, and by a great railway system which has been built to meet the demands arising from the natural resources. By far the most important industry is the production of iron and steel. The manufacture of iron was established on a commercial basis in 1716-1718, when a furnace was built on Manatawney Creek above Pottstown, and before the close of the colonial era Pennsylvania had risen to first rank among the iron-producing colonies, a position which it has always held among the states of the Union. So long as charcoal only was used in the furnaces (until about 1840) and during the brief period in which this was replaced largely by anthracite, the industry was of chief importance in the eastern section, but with the gradual increase in the use of bituminous coal, or of coke made from it, the industry moved westward, where, especially in the Pittsburgh district, it received a new impetus by the introduction of iron ore from the Lake Superior region. The value of the output of iron and steel increased from \$264,571,624 in 1890 to \$471,228,844 in 1905, and the state furnished 46.5 % of the pig-iron and 54 % of the steel and malleable iron produced in the entire country. The manufacture of great quantities of coke has resulted from the demand for this product in the iron and steel industry and from the abundance of coking coal; the manufacture of glass has been promoted by the supply of glass sand and natural gas in the west of the state; the manufacture of leather by the abundance of hemlock bark; the manufacture of pottery, terra-cotta and fire-clay products by the abundance of raw material; the manufacture of silk and silk goods by the large number of women and girls who came into the state in families of which the men and boys were employed in mining and picking anthracite coal; and in each of these industries as well as in a few others the state has for many years produced a large portion of the country's product.

In 1905 the twelve leading manufactures, with the value of each, were: steel and malleable iron, \$363,773,577; foundry and machine-shop products, consisting most largely of steam locomotives, metal-working machinery and pumping machinery, \$119,650,913; pig-iron, \$107,455,267; leather, \$69,427,882; railway cars and material by steam railway companies, \$61,021,374; refined petroleum, \$47,469,502; silk and silk goods, \$39,333,320; tobacco, cigars and cigarettes, \$39,079,122; flour and great-mill products, \$38,518,702; refined sugar and molasses, \$37,182,504; worsted goods, \$35,683,015; and malt liquors, \$34,863,823. The most marked advances from 1900 to 1905 were in worsted goods (61.4 %) structural iron-work (60 %), and tin and terne-plate (54.4 %). Philadelphia is the great manufacturing centre. Within its limits, in 1905, all the sugar and molasses were manufactured and much of the petroleum was refined, nearly all of the iron and steel ships and steam locomotives were built, and 93 % of the carpets and rugs were made, and the total value of the manufactures of this city in that year was nearly one-third of that for the entire state. Nearly 20 % of the iron and steel was produced by Pittsburgh together with Allegheny, with which it has since been consolidated, and the production of these is the leading industry of New Castle, Johnstown, Duquesne, McKeesport, Sharon, Braddock and Dubois, also in the west part of

the state and of Reading, Harrisburg, Steelton, South Bethlehem, Pottstown, Lebanon, Phoenixville and Danville in the east part. The silk and cement industries are confined largely to the eastern cities and boroughs; the coke, tin and terne-plate, and pickling industries to the western; and the construction and repair of railway cars to Altoona, Meadville, Dunmore, and repair of railway cars to Altoona, Meadville, Dunmore, Chambersburg, Butler and Philadelphia.

Transport and Commerce.—The new road cut through the Juniata region in the march of the army of Brigadier-General John Forbes, against Fort Duquesne in 1758, was a result of the influence of Pennsylvania, for it was considered even then a matter of great importance to the future prosperity of the province that its seaport, Philadelphia, be connected with navigation on the Ohio by the easiest line of communication that could be had wholly within its limits. As early as 1762 David Rittenhouse and others made a survey for a canal to connect the Schuylkill and the Susquehanna rivers, and in 1791 a committee of the state legislature reported in favour of a project for establishing communication by canals and river improvement from Philadelphia to Lake Erie by way of the Susquehanna river. Before anything was done, the need of improved means of transportation between Philadelphia and the anthracite coal-fields became the more pressing. The Schuylkill Canal Company, chartered in 1815, began the construction of a canal along the Schuylkill river from Philadelphia to Mount Carbo, Schuylkill county, in 1816, and completed it in 1826. In 1818 the Lehigh Navigation Company was formed to improve the navigation of the Lehigh river from its confluence with the Delaware to Coalport, and two years later coal was successfully carried down the Lehigh and Delaware rivers to Philadelphia in "arks" or rectangular boxes, two or more of which were joined together and steered by a long oar. So prosperous was the business that in 1827-1829 the company built a number of locks which made the Lehigh navigable in either direction, and in 1827-1832 the state did the same for the Delaware between the mouth of the Lehigh and Bristol. The Union Canal Company, incorporated in 1811, completed a canal from Middletown on the Susquehanna to Reading on the Schuylkill in 1827. In 1824 the state legislature authorized the appointment of a commission to explore routes from the Schuylkill to Pittsburg, and from the West Branch of the Susquehanna to the Allegheny, and in the three or four succeeding years the state committed itself to a very extensive system of internal improvements. Work was begun on the system in 1826 and was continued without interruption until 1840, when the completed or nearly completed portions embraced a railway from Philadelphia to Columbia on the Susquehanna, a canal up the Susquehanna and the Juniata from Columbia to Hollidaysburg, a portage railway from Hollidaysburg through Blair's Gap in the Allegheny Front to Johnstown on the Conemaugh river, a canal down the Conemaugh, Kiskiminetas, and Allegheny rivers to Pittsburg, a canal up the Susquehanna and its west branch from the mouth of the Juniata to Farrisandsville, in Clinton county, a canal up the Susquehanna and its north branch from Northumberland nearly to the New York border, and a canal up the Delaware river from Bristol to the mouth of the Lehigh; considerable work had also been done on two canals to connect the Ohio river with Lake Erie. Work was stopped, in 1840, before the system was completed because of the intense popular discontent arising from the burden of debt which had been assumed and because the success of competing railways was then fully assured. In 1845 the state began to sell its canals and railways to private corporations and the sale was completed in 1859. The western division of the system was abandoned by the new owners in 1865 and the worked portion of the east division gradually decreased until it, too, was wholly abandoned in 1904, with the exception of the Delaware Division Canal, which since 1866 has been worked by the Lehigh Coal & Navigation Company in connexion with the Lehigh Canal. In its natural condition there were bars in the Delaware river below Philadelphia which obstructed the navigation of vessels drawing more than 17-20 ft. of water, but in 1869 the Federal government adopted a project for obtaining a channel having a minimum depth of 30 ft. The Federal government has much improved the navigation of the Monongahela and Allegheny rivers and is committed to a project for black-water navigation on the Ohio which is expected to give Pittsburg communication with the sea by vessels drawing 9 ft. of water.

The first railway in the state was that built in 1827 by the Lehigh Coal & Navigation Company from Mauch Chunk to its mines, 9 m. distant; but this was only a gravity road down which cars loaded with coal descended by their own gravity and up which the empty cars were drawn by mules. In 1823 a company was incorporated to build a railway from Philadelphia to Columbia, but nothing further was done until 1828, when the state canal commissioners were directed to build this road and the Allegheny Portage railway from Hollidaysburg to Johnstown. The latter was built with ten inclined planes, five on each side of the summit at Blair's Gap and cars were drawn up these by stationary engines. Both the Philadelphia & Columbia and the Allegheny Portage railways were completed in 1834. From these and other beginnings the state's railway mileage gradually increased to 1240 m. in 1890, to 4696 m. in 1870, to 8639 m. in 1890 and to 11,373 m. in

the end of 1908, when it was exceeded by only two states in the Union, Texas and Illinois. The principal railways are the lines operated by the Pennsylvania Railroad Company from New York to Washington through Philadelphia; from Philadelphia to Cincinnati, Cleveland, Chicago and St. Louis through Harrisburg and Pittsburg; from Baltimore, Maryland, to Soda Point on Lake Ontario (Northern Central) through Harrisburg and Williamsport; from Williamsport to Buffalo and to Erie, and from Pittsburg to Buffalo; the Philadelphia & Reading; the Lehigh Valley; the Erie; the Delaware, Lackawanna & Western; the Baltimore & Ohio; and the Buffalo, Rochester & Pittsburg.

The state has one port of entry along the Atlantic coast, one on the Ohio river, and one on the Great Lakes. Philadelphia, the Atlantic port, exports chiefly petroleum, coal, grain and flour, and imports chiefly iron ore, sugar, drugs and chemicals, manufactured iron, hemp, jute and flax. In 1909 the value of its exports, \$80,650,274, was greater than that of any other Atlantic port except New York, and the value of its imports, \$78,003,464, was greater than that of any except New York and Boston. Pittsburg ranks high among the interior ports of the country in foreign commerce and first among the cities of the United States in the tonnage of its domestic commerce. Erie is quite unimportant among the lake ports in foreign commerce, but has a large domestic trade in iron ore, copper, wheat and flour.

Population.—The population of Pennsylvania was 434,373 in 1790; 602,365 in 1800; 810,091 in 1810; 1,049,458 in 1820; 1,348,233 in 1830; 1,724,033 in 1840; 2,311,786 in 1850; 2,906,215 in 1860; 3,521,951 in 1870; 4,282,891 in 1880; 5,258,014 in 1890; 6,302,115 in 1900; 7,665,111 in 1910. Of the total in 1900, 985,250, or 15.6%, were foreign-born, 156,845 were negroes, 1619 were Indians, 1927 were Chinese and 40 were Japanese. Nearly 95% of the foreign-born was composed of natives of Germany (212,453), Ireland (205,900), Great Britain (180,670), Poland (76,358), Austria (761,492), Italy (66,655), Russia (50,959), Hungary (47,393) and Sweden (24,130). Of the native population (5,316,865) 90.7% were born within the state and a little more than two-fifths of the remainder were natives of New York, Maryland, Ohio, New Jersey, Virginia, New England, Delaware and West Virginia. Almost two-thirds of the Indians were in Cumberland county where, at Carlisle, is a United States Indian Industrial School. In 1906 the total number of communicants of different religious denominations in the state was 2,977,022, of whom 1,177,037 were Protestants and 1,214,734 were Roman Catholics. There is a large number of the smaller religious sects in the state; the principal denominations, with the number of communicants of each in 1906, are: Methodist (363,443), Lutheran (335,643), Presbyterian (322,542), Reformed Church (177,270), Baptist (141,604), Protestant Episcopal (99,021), United Brethren (55,574), United Evangelical Church (45,480), Disciples of Christ (46,458), German Baptist Brethren (23,176), Eastern Orthodox Churches (22,123), Mennonites (16,527), Congregational (14,811), Evangelical Association (13,294), Friends (12,457), Church of God or "Winnerebrennians" (11,157), and Moravian (5322).

Of the total population in 1900, 3,223,337, or 51.1%, were urban (i.e. in places having a population of 4000 or more), 762,846, or 12.15%, were semi-urban (i.e. in incorporated places having a population less than 4000) and 2,315,932, or 36.75%, were rural (i.e. outside of the incorporated places). From 1890 to 1900 the urban population increased 854,790, or 36%, and the semi-urban 134,077, or 18.4%, but the rural increased only 55,195, or 2.4%. The populations of the principal cities in 1900 were as follows: Philadelphia, 1,293,697; Pittsburg, 321,616; Allegheny, 129,896 (subsequently annexed to Pittsburg); Scranton, 102,026; Reading, 78,061; Erie, 52,133; Wilkes-Barre, 51,721; Harrisburg, 50,167; Lancaster, 41,459; Altoona, 38,973; Johnstown, 35,936; Allentown, 35,416; McKeesport, 34,227; Chester, 33,988; York, 33,708; Williamsport, 28,757; New Castle, 28,339; Easton, 25,238; Norristown, 22,265; Shenandoah, 20,321; Shamokin (borough), 18,202; Lebanon, 17,668.

Administration.—Pennsylvania has been governed under constitutions of 1776, 1790 and 1838; the present government is under the constitution of the 16th of December 1873 with amendments adopted on the 5th of November 1901. An amendment to the constitution to be adopted must be approved by a majority of the members elected to each house of the general assembly in two successive legislatures and then, at least three months after the second approval of the general assembly, by a majority of the popular vote cast on the adoption of the amendment. All male citizens over 21 years of age,

who have been citizens of the United States for one month, residents of the state for one year and of the election district for two months immediately preceding the election, have the right of suffrage, provided they have paid within two years a state or county tax, which shall have been assessed at least two months and paid at least one month before the election. The Australian or "Massachusetts" ballot, adopted in 1891 under a law which fails to require personal registration, by a provision like that in Nebraska makes it easy to vote a straight ticket; party names are arranged on the ballot according to the number of votes secured by each party at the last preceding election.

Executive.—The office of governor, superseded in 1776 by a president and council of twelve, was restored in 1790. Under the present constitution the governor serves for four years and is ineligible for the next succeeding term. The governor and lieutenant-governor must be at least 30 years old, citizens of the United States, and inhabitants of the state for seven years last preceding election; no member of Congress or person holding any office under the United States or Pennsylvania may be governor or lieutenant-governor. The governor controls a large amount of patronage; appointing, subject to the advice and consent of two-thirds of the senate, a secretary of the commonwealth and an attorney-general during pleasure, and a superintendent of public instruction for four years, and may fill vacancies in various offices which occur during the recess of the senate. He has a right of veto, extending to items in appropriation bills, which may be overridden by a two-thirds vote in each house. His power of pardon is limited, being subject to the recommendation of three members of a board which consists of the lieutenant-governor, secretary of the commonwealth, attorney-general and secretary of internal affairs. The other executive officials are the lieutenant-governor and the secretary of internal affairs, elected for four years, the auditor-general, elected for three years, the treasurer, elected for two years, and (all appointed by the governor) the secretary of the commonwealth, the attorney-general and a superintendent of public instruction. All those chosen by election are ineligible for a second consecutive term except the secretary of internal affairs. The department of internal affairs consists of six bureaus: the land office, vital statistics, weather service, assessments, industrial statistics, and railroads, canals, telegraphs and telephones. There are also many statutory administrative officials and boards, such as the adjutant-general, insurance commissioner, board of health, board of agriculture, board of public grounds and buildings, commissioners of fisheries, and factory and mining inspectors.

Legislature.—During the colonial period and the early years of statehood the legislature was composed of one house, but the bicameral system was adopted in the constitution of 1790. There are fifty senators, elected for four years, and approximately two hundred representatives, elected for two years. Senators must be at least 25 years old, citizens and inhabitants of the state for four years next before election and inhabitants of the senatorial districts from which each is elected for one year next before election; representatives must be at least 21 years old and must have lived in the state three years and in the district from which elected one year next before election. To avoid the possibility of metropolitan domination provision is made that no city or county shall be entitled to more than one-sixth of the total number of senators. Sessions are biennial. The powers of the two houses are the same except that the senate exercises the usual right of confirming appointments and of sitting as a court of impeachment, while the House of Representatives initiates money bills and impeachment cases.

Judiciary.—The supreme court consists of seven judges elected by the voters of the state at large. Minority representation is secured by the provision that each elector shall vote for one less than the number of judges to be chosen at each election. The state is divided into three supreme judicial districts, the eastern, the middle and the western. This court was formerly very much overworked, but it was relieved by an act of the 24th of June 1895 establishing a superior court (now of seven judges) with appellate jurisdiction. There were in 1910 fifty-six district courts of common pleas, one for each county of forty thousand inhabitants and not more than four counties in a district. The judges of the common pleas are also judges of the courts of oyer and terminer, quarter sessions of the peace and general goal delivery, and the orphans' courts, although there are separate orphans' courts in the counties (ten in 1909) having a population of more than one hundred and fifty thousand. Justices of the peace are elected in wards, districts, boroughs and townships. In the colonial period all judges were appointed by the governor during good behaviour. The constitution of 1776 provided for terms of seven years, that of 1790 restored the life term, and that of 1838 fixed the terms for judges of the common pleas at ten years and judges of the supreme court at fifteen. A constitutional amendment of 1850 provided that all judges should be elected by the people.¹

¹ The constitution of 1873 made provision for minority representation as follows: "Whenever two judges of the supreme court are

At present supreme court judges serve for twenty-one years and are ineligible for re-election. Superior court and common pleas judges serve for ten years, and justices of the peace for five. Judges may be impeached for misdemeanour in office or they may be removed by the governor, with the consent of two-thirds of each house of the general assembly, for any reasonable cause which shall not be sufficient ground for impeachment.

Local Government.—The local government is a combination of the county system of the South and the township system of New England. The county officers are sheriffs, coroners, prothonotaries, registers of wills, recorders of deeds, commissioners, treasurers, surveyors, auditors or comptrollers, clerks of the courts, and district attorneys, elected for three years. The three commissioners and the three auditors in each county are chosen by the same limited vote process as the supreme-court judges, thus allowing a representation to the minority party. Pennsylvania has suffered more perhaps than any other state in the Union from legislative interference in local affairs. Under an act of the general assembly passed in 1870 the people of Philadelphia were forced to contribute more than \$200,000 for the construction of a city-hall. To guard against such encroachments in the future the constitution of 1873 imposed the most detailed limitations upon special legislation. The object of the provision, however, has been in a large measure nullified by the system of city classification, under which Philadelphia is the only city of the first class. The passage of the "Ripper Bill" of 1901 shows that the cities of the second class are by no means secure. The apparent object of the measure was to deprive the people of Pittsburg temporarily of the privileges of self-government by empowering the governor to appoint a recorder (in 1903 the title of mayor was again assumed) to exercise (until 1903, when the municipal executive should be again chosen by the people) the functions of the mayor, thus removed by the governor under this statute; and this act applied to the other cities of the second class, Allegheny and Scranton, although they had not offended the party managers.

Miscellaneous Laws.—A woman's right to hold, manage and acquire property in her own right is not affected by marriage, but for a married woman to mortgage or convey her real estate the joint action of herself and her husband is necessary. The rights of dower and courtesy both obtain. When a husband dies intestate leaving a widow and issue, the widow has the use of one-third of his real estate for life and one-third of his personal estate absolutely; if he leaves no issue but there be collateral heirs or other kindred, the widow has the real or personal estate or both to the value of \$5000, the use of one-half the remaining real estate for life, and one-half the remaining personal estate absolutely; if the husband leaves a will the widow has the choice between her dower right and the terms of the will. When a wife dies intestate leaving a husband and issue the husband has the use of all her real estate for life, and the personal estate is divided among the husband and children share and share alike; if there be no issue the husband has the use of all her real estate for life and all her personal estate absolutely; if the wife leaves a will the husband has the choice between its terms and his right by courtesy. Whenever there is neither issue nor kindred the surviving husband or wife has all the estate. The principal grounds for an absolute divorce are impotency, adultery, wilful or malicious desertion, cruel and barbarous treatment, personal abuse and conviction of any such crime as arson, burglary, embezzlement, forgery, kidnapping, larceny, murder, perjury or assault with intent to kill. Before filing a petition for a divorce the plaintiff must have resided within the state at least one year. A suit for a divorce on the ground of desertion may be commenced when the defendant has been absent six months, but the divorce may not be granted until the desertion has continued two years. The party convicted of adultery is forbidden to marry the co-respondent during the lifetime of the other party. A marriage of first cousins or a bigamous marriage may be declared void. Pennsylvania has no homestead law, but the property of a debtor amounting to \$300 in value, exclusive of the wearing apparel of himself and family and of all Bibles and school-books in use, is exempt from levy and sale on execution or by distress for rent; and the exemption extends to the widow and children unless there is a lien on the property for purchase money. The child-labour law of 1909 forbids the employment of children under eighteen years of age in blast furnaces, tanneries, quarries, in managing elevator lifts or hoisting machines, in oiling dangerous machinery while in motion, at switch tending, as brakemen, firemen, engineers, motormen and in other positions of similar character. The same law prescribes conditions under which children between fourteen and eighteen years of age may be employed in the manufacture of white-lead, red-lead, paints, phosphorus, poisonous acids, tobacco or cigars, in mercantile establishments, stores, hotels, offices or in other places requiring protection to their health or safety; and it forbids the employment of boys under sixteen years of age or of girls under eighteen years of age in such factories or establishments more than ten hours a day (unless it be to prepare for a short day) or for more than fifty-eight hours

to be chosen for the same term of service each voter shall vote for one only, and when three are to be chosen he shall vote for no more than two; candidates highest in vote shall be declared elected."

a week, or their employment there between nine o'clock in the evening and six o'clock in the morning, except that in the factories requiring continuous night and day employment boys not under fourteen years of age may be employed partly by day and partly by night not exceeding nine hours in any twenty-four. The employment of children under fourteen years of age in coal-mines is forbidden, as is also the employment of children under fourteen years of age in any cotton, woollen, silk, paper, bagging or flax factory, or in any laundry, or the employment of children under twelve years of age in any mill or factory whatever within the commonwealth.

Prisons and Charities.—Penal and charitable institutions are under the supervision of a board of public charities of ten members, established in 1869, and a committee in lunacy, composed of five members of this board, appointed under an act of 1883. An agitation begun by the Philadelphia society for assisting distressed prisoners in 1776, checked for a time by the War of Independence, led ultimately to the passage of a statute in 1818 for the establishment of the Western Penitentiary at Allegheny (opened 1826) and another of 1821 for the establishment of the Eastern Penitentiary in Philadelphia (opened 1829). In the former penitentiary prisoners are congregated; in the latter they are kept in solitary confinement. An act of 1878 provided for a third penitentiary in the middle district, but through the efforts of Governor Henry M. Hoyt the plans were changed and instead the Industrial Reformatory was established at Huntingdon (opened 1889). The House of Refuge of western Pennsylvania, located in Allegheny in 1854 (act of 1850), became the Pennsylvania Reform School in 1872, and was removed to Morgantza, Washington county, in 1876. Few states have done so much as Pennsylvania for the humane and scientific treatment of its dependent and defective classes. Largely as a result of the efforts of Dorothea Lynde Dix (q.v.), a hospital for the insane was established at Harrisburg in 1851 (act of 1845). A second hospital was opened at Pittsburg in 1853 (act of 1848), but the location was ruined by Pennsylvania railway improvements, and in 1862 it was removed to a new site about 7 m. from the city, which was called Diamond in honour of Miss Dix; the hospital is not a state institution, but the state provides for the maintenance there of patients committed by the courts or the poor authorities in the thirteen counties forming the western district. For three other districts three state institutions have been established—at Danville, 1872 (act of 1868), Warren, 1880 (act of 1873), and Norris-town, 1880 (act of 1876). An act of 1901 established a homeopathic hospital for the insane at Allentown. A distinction is made between hospitals and asylums. The asylum for the chronic insane is at South Mountain, 1894 (act of 1891). A state institution for feeble-minded of western Pennsylvania at Polk, Venango county, was opened in 1897 (act of 1893), and the eastern Pennsylvania state institution for feeble-minded and epileptic at Spring City, Chester county, was opened in 1908 (act of 1903). There are institutes for the blind at Overbrook and Piltzberg, and for the deaf and dumb at Philadelphia and Edgewood Park, an oral school for the deaf at Scranton, a home for the training of deaf children at Philadelphia, a soldiers' and sailors' home at Erie (1886), a soldiers' orphans' industrial school (1895) at Scotland, Franklin county, the Thaddeus Stevens industrial school (1905) at Lancaster, hospitals for the treatment of persons injured in the mines, at Ashland (1879), Hazleton (1887) and Shamokin (1907), and cottage hospitals at Blossburg, Conneltsville, Mercer and Philipsburg (all 1887). In addition to the institutions under state control a large number of local charities receive aid from the public treasury. In 1907-1908, \$14,222,440 was appropriated for institutions: \$7,479,752 for state institutions, \$1,240,108 for semi-state institutions, \$4,757,100 for general hospitals, \$149,500 for hospitals for consumptives, and \$745,900 for homes, asylums, &c. The system of juvenile courts, created under a statute of 1901, has done much to ameliorate the condition of dependent and delinquent children.

Education.—During the colonial period there were many sectarian and neighbourhood subscription schools in which the poor could receive a free education, but public schools in the modern American sense were unknown. The famous Friends' public school, founded in Philadelphia in 1689 and chartered in 1697, still exists as the William Penn charter school. An agitation begun soon after the War of Independence resulted in the creation of a school fund in 1831 and the final establishment of the present system of public schools in 1834. The attempt to repeal the law in 1835 was defeated largely through the efforts of Thaddeus Stevens, who was then a member of the state house of representatives. During the years 1852-1857 the educational department became a separate branch of the state government, the office of county school superintendent was created, the state teachers' association (known since 1900 as the Pennsylvania educational association) was organized, and a law was enacted for the establishment of normal schools. Since 1893 the state has furnished textbooks and other necessary supplies free of charge, and since 1895 education has been compulsory for all children between the ages of eight and thirteen. Schools must be kept open not less than seven and not more than ten months in the year. Out of a total expenditure of \$30,021,774 for the fiscal year 1909, \$7,875,083 was for educational purposes, of which \$6,810,906 was for common schools, being appropriations to the

counties. There is a biennial school appropriation of \$13,000,000. In addition the district directors levy local rates which must not be greater than the state and county taxes combined. The Pennsylvania state college at State College, Center county, was established in 1855 as the farmers' high school of Pennsylvania, in 1862 became the Agricultural College of Pennsylvania, and received its present name in 1874 after the income from the national land grant had been appropriated to the use of the institutions; in 1909-1910 it had 147 instructors, 1400 students and a library of 37,000 volumes. Other institutions for higher education are the University of Pennsylvania, at Philadelphia (1749), an endowed institution which receives very little support from the state; the University of Pittsburgh (1819), at Pittsburg (q.v.); Dickinson College (Methodist Episcopal, 1783), at Carlisle; Haverford College (Society of Friends, 1833), at Haverford; Franklin and Marshall (German Reformed, 1853), at Lancaster; Washington and Marshall (Presbyterian, 1853), at Lafayette (Presbyterian, 1832), at Easton; Bucknell University (Baptist, 1846), at Lewisburg; Waynesburg (Cumberland Presbyterian, 1851), at Waynesburg; Ursinus (German Reformed, 1870), at Collegeville; Allegheny College (Methodist Episcopal, 1816), at Meadville; Swarthmore (Society of Friends (Hicksites), 1866), at Swarthmore; Muhlenberg (Lutheran, 1867), at Allentown; Lehigh University (non-sectarian, 1867), at Bethlehem; and for women Bryn Mawr College (Society of Friends, 1885), at Bryn Mawr; the Allentown College (German Reformed, 1867), at Allentown; Wilson College (Presbyterian, 1870), and the Pennsylvania College for women (1866), at Pittsburg. There are theological seminaries at Pittsburg, the Allegheny Seminary (United Presbyterian, 1825), Reformed Presbyterian (1856), and Western Theological Seminary (Presbyterian, 1827); at Lancaster (German Reformed, 1827); at Meadville (Unitarian, 1844); at Bethlehem (Moravian, 1807); at Chester, the Crozer Theological Seminary (Baptist, 1868); at Gettysburg (Lutheran, 1826); and in Philadelphia several schools, notably the Protestant Episcopal Church divinity school (1862) and a Lutheran seminary (1864), at Mount Airy. There are many technical and special schools, such as Girard College, Drexel Institute and Franklin Institute, at Philadelphia, the Carnegie Institute at Pittsburg and the United States Indian school at Carlisle (1891).

Finance.—The revenues of the state are derived primarily from corporation taxes, business licences, and a 5% rate on collateral inheritance. Taxes on real estate have been abolished and those on personal property are being reduced, although the heavy expenditures on the new capitol at Harrisburg checked the movement temporarily. The total receipts for the year ending on the 30th of November 1909 were \$28,943,210, and the expenditure was \$30,021,774. During the provincial period Pennsylvania, in common with the other colonies, was affected with the paper money craze. From 1773 to 1775 it issued £1,094,650 and from 1775 to 1785 £1,172,000 plus £1,350,000. Acts were passed in 1781, 1791, 1792 and 1794 to facilitate redemption at depreciated rates, and the last bills were called in on the 1st of January 1806. The state was also carried along by the movement which began about 1825 for the expenditure of public funds on internal improvements. On turnpikes, bridges, canals and railways \$53,352,649 was spent between 1826 and 1843, the public debt in the latter year reaching the high-water mark of \$42,188,434. An agitation was then begun for retrenchment, the public works were put up for sale, and were finally disposed of in 1858 (when the debt was \$39,488,244) to the Pennsylvania Railroad Company for \$7,500,000. Under authority of a constitutional amendment of 1857 a sinking fund commission was established in 1858. Aside from a temporary increase during the Civil War (1861-65) the debt has been rapidly reduced. The constitution of 1873 and subsequent legislation have continued the commission, but the sources of revenue have been very much curtailed, being restricted to the interest on the deposits of the fund and interest on certain Allegheny Railroad bonds. The total debt on the 30th of November 1909 was \$2,643,917, of which the greater part were 31 and 4% bonds, maturing on the 1st of February 1912. The sinking fund at the same date amounted to \$2,652,035, leaving a net surplus in the sinking fund of \$8118. The sinking fund was formerly divided among certain favoured banks in such manner as would best advance the political interests of the organization which controlled the state; but just after the reform victory in the election of 1905 the sinking fund commission instituted the policy of buying bonds at the market price, and the debt is now being reduced by that method. The financial institutions of Pennsylvania other than national banks are created by state charters limited to twenty years and are subject to the supervision of a commissioner of banking.

History.—The chief features of Pennsylvania history in colonial days were the predominance of Quaker influence, the heterogeneous character of the population, liberality in matters of religion, and the fact that it was the largest and the most successful of proprietary provinces. The earliest European settlements within the present limits of the state were some small trading posts established by the Swedes and the Dutch in the

lower valley of the Delaware River in 1623-1681. Between 1650 and 1660 George Fox and a few other prominent members of the Society of Friends had begun to urge the establishment of a colony in America to serve as a refuge for Quakers who were suffering persecution under the "Clarendon Code." William Penn (q.v.) became interested in the plan at least as early as 1666. For his charters of 1680-1682 and the growth of the colony under him see PENN, WILLIAM.

During Penn's life the colony was involved in serious boundary disputes with Maryland, Virginia and New York. A decree of Lord Chancellor Hardwicke, in 1750, settled the Maryland-Delaware dispute and led to the survey in 1763-1767 of the boundary between Pennsylvania and Maryland (lat. 39° 43' 26.3" N.), called the Mason and Dixon line in honour of the surveyors; it acquired considerable importance later as separating the free and the slave states. In 1784 Virginia agreed to the extension of the line and to the establishment of the western limit (the present boundary between Pennsylvania and Ohio) as the meridian from a point on the Mason and Dixon line five degrees of longitude west of the Delaware river. The 42nd parallel was finally selected as the northern boundary in 1780, in 1790 the Federal government sold to Pennsylvania the small triangular strip of territory north of it on Lake Erie. A territorial dispute with Connecticut over the Wyoming Valley was settled in favour of Pennsylvania in 1782 by a court of arbitration appointed by the Continental Congress.

Upon William Penn's death, his widow became proprietary. Sir William Keith, her deputy, was hostile to the council, which he practically abolished, and was popular with the assembly, which he assiduously courted, but was discharged by Mrs Penn after he had quarrelled with James Logan, secretary of the province. His successors, Patrick Gordon and George Thomas, under the proprietorship of John, Thomas and Richard Penn, continued Keith's popular policy of issuing a plentiful paper currency; but with Thomas the assembly renewed its old struggle, refusing to grant him a salary or supplies because of his efforts to force the colony into supporting the Spanish War. Again, during the Seven Years' War the assembly withstood the governor, Robert Hunter Morris, in the matter of grants for military expenses. But the assembly did its part in assisting General Braddock to outfit; and after Braddock's defeat all western Pennsylvania suffered terribly from Indian attacks. After the proprietors subscribed £5000 for the protection of the colony the assembly momentarily gave up its contest for a tax on the proprietary estates and consented to pass a money bill, without this provision, for the expenses of the war. But in 1760 the assembly, with the help of Benjamin Franklin as agent in England, won the great victory of forcing the proprietors to pay a tax (£566) to the colony; and thereafter the assembly had little to contest for, and the degree of civil liberty attained in the province was very high. But the growing power of the Scotch-Irish, the resentment of the Quakers against the proprietors for having gone back to the Church of England and many other circumstances strengthened the anti-proprietary power, and the assembly strove to abolish the proprietorship and establish a royal province; John Dickinson was the able leader of the party which defended the proprietors; and Joseph Galloway and Benjamin Franklin were the leaders of the anti-proprietary party, which was greatly weakened at home by the absence after December 1764 of Franklin in England as its agent. The question lost importance as independence became the issue.

In 1755 a volunteer militia had been created and was led with great success by Benjamin Franklin; and in 1756 a line of forts was begun to hold the Indians in check. In the same year a force of pioneers under John Armstrong of Carlisle surprised and destroyed the Indian village of Kittanning (or Atiucé) on the Allegheny river. But the frontier was disturbed by Indian attacks until the suppression of Pontiac's conspiracy. In December 1763 six Christian Indians, Conestogas, were massacred by the "Paxton boys" from Paxton near the present Harrisburg; the Indians who had escaped were taken

to Lancaster for safe keeping but were seized and killed by the "Paxton boys," who with other backwoodsmen marched upon Philadelphia early in 1764, but Quakers and Germans gathered quickly to protect it and civil war was averted, largely by the diplomacy of Franklin. The Paxton massacre marked the close of Quaker supremacy and the beginning of the predominance of the Scotch-Irish pioneers.

Owing to its central position, its liberal government, and its policy of religious toleration, Pennsylvania had become during the 18th century a refuge for European immigrants, especially persecuted sectaries. In no other colony were so many different races and religions represented. There were Dutch, Swedes, English, Germans, Welsh, Irish and Scotch-Irish; Quakers, Presbyterians, Episcopalians, Catholics, Lutherans (Reformed), Mennonites, Dunkers, Schwenkfelders, and Moravians. Most of these elements have now become merged in the general type, but there are still many communities in which the popular language is a corrupt German dialect, largely Rheno-Franconian in its origin, known as "Pennsylvania Dutch." Before the Seven Years' War the Quakers dominated the government, but from that time until the failure of the Whisky Insurrection (1794) the more belligerent Scotch-Irish (mostly Presbyterians) were usually in the ascendancy, the reasons being the growing numerical strength of the Scotch-Irish and the increasing dissatisfaction with Quaker neglect of means of defending the province.

As the central colony, Pennsylvania's attitude in the struggle with the mother country was of vast importance. The British party was strong because of the loyalty of the large Church of England element, the neutrality of many Quakers, Dunkers, and Mennonites, and a general satisfaction with the liberal and free government of the province, which had been won gradually and had not suffered such catastrophic reverses as had embittered the people of Massachusetts, for instance. But the Whig party under the lead of John Dickinson, Thomas Mifflin and Joseph Reed was successful in the state, and Pennsylvania contributed greatly to the success of the War of Independence, by the important services rendered by her statesmen, by providing troops and by the financial aid given by Robert Morris (*q.v.*). The two Continental Congresses (1774, and 1775-1781) met in Philadelphia, except for the months when Philadelphia was occupied by the British army and Congress met in Lancaster and York, Pennsylvania, and then in Princeton, New Jersey. In Philadelphia the second Congress adopted the Declaration of Independence, which the Pennsylvania delegation, excepting Franklin, thought premature at the time, but which was well supported by Pennsylvania afterwards. During the War of Independence battles were fought at Brandywine (1777), Paoli (1777), Fort Mifflin (1777) and Germantown (1777), and Washington's army spent the winter of 1777-1778 at Valley Forge; and Philadelphia was occupied by the British from the 26th of September 1777 to the 18th of June 1778. The Penns lost their governmental rights in 1776, and three years later their territorial interests were vested in the commonwealth in return for a grant of £120,000 and the guarantee of titles to private estates held in severalty. They still own considerable property in and around Wilkes-Barré, in Luzerne county, and in Philadelphia. The first state constitution of September 1776 was the work of the Radical party. It deprived the Quakers of their part in the control of the government and forced many Conservatives into the Loyalist party. This first state constitution was never submitted to popular vote. It continued the unicameral legislative system, abolished the office of governor, and provided for an executive council of twelve members. It also created a curious body, known as the council of censors, whose duty it was to assemble once in seven years to decide whether there had been any infringements of the fundamental law. The party which had carried this constitution through attacked its opponents by withdrawing the charter of the college of Philadelphia (now the university of Pennsylvania) because its trustees were anti-Constitutionalists and creating in its place a university of the state of Pennsylv-

vania. The Constitutional party in 1785 secured the annulment by the state assembly of the charter of the Bank of North America, which still retained a congressional charter; and the cause of this action also seems to have been party feeling against the anti-Constitutionalists, among whom Robert Morris of the bank was a leader, and who, especially Morris, had opposed the paper money policy of the Constitutionalists. These actions of the state assembly against the college and the bank probably were immediate causes for the insertion in the Federal Constitution (adopted by the convention in Philadelphia in 1787) of the clause (proposed by James Wilson of Pennsylvania, a friend of the college and of the bank) forbidding any state to pass a law impairing the obligation of contracts. The state ratified the Federal Constitution, in spite of a powerful opposition—largely the old (state) Constitutional party—on the 22nd of December 1787, and three years later revised its own constitution to make it conform to that document. Under the constitution of 1790 the office of governor was restored, the executive council and the council of censors were abolished, and the bicameral legislative system was adopted. Philadelphia was the seat of the Federal government, except for a brief period in 1789-1790, until the removal to Washington in 1800. The state capital was removed from Philadelphia to Lancaster in 1799 and from Lancaster to Harrisburg in 1812.

The state was the scene of the Scotch-Irish revolt of 1794 against the Federal excise tax, known as the Whisky Insurrection (*q.v.*) and of the German protest (1799) against the house tax, known as the Fries Rebellion from its leader John Fries (*q.v.*). In 1838 as the result of a disputed election to the state house of representatives two houses were organized, one Whig and the other Democratic, and there was open violence in Harrisburg. The conflict has been called the "Buckshot War." The Whig House of Representatives gradually broke up, many members going over to the Democratic house, which had possession of the records and the chamber and was recognized by the state Senate. Pennsylvania was usually Democratic before the Civil War owing to the democratic character of its country population and to the close commercial relations between Philadelphia and the South. The growth of the protectionist movement and the development of anti-slavery sentiment, however, drew it in the opposite direction, and it voted the Whig national ticket in 1840 and in 1848, and the Republican ticket for Lincoln in 1860. A split among the Democrats in 1835, due to the opposition of the Germans to internal improvements and to the establishment of a public school system, resulted in the election as governor of Joseph Ritner, the anti-Masonic candidate. The anti-Masonic excitement subsided as quickly as it had risen, and under the leadership of Thaddeus Stevens the party soon became merged with the Whigs. During the Civil War (1861-65) the state gave to the Union 336,000 soldiers; and Generals McClellan, Hancock, Meade and Reynolds and Admirals Porter and Dahlgren were natives of the state. Its nearness to the field of war made its position dangerous. Chambersburg was burned in 1862; and the battle of Gettysburg (July 1863), a defeat of Lee's attempt to invade the North in force was a turning point in the war.

The development of the material resources of the state since 1865 has been accompanied by several serious industrial disturbances. The railway riots of 1877, which centred at Pittsburg and Reading, resulted in the destruction of about two thousand freight cars and a considerable amount of other property. An organized association, known as the Molly Maguires (*q.v.*), terrorized the mining regions for many years, but was finally suppressed through the courageous efforts of President Franklin Benjamin Gowen (1863-1886) of the Philadelphia & Reading railroad with the assistance of Allan Pinkerton and his detectives. There have been mining strikes at Scranton (1871), in the Lehigh and Schuylkill regions (1875), at Hazleton (1897), and one in the anthracite fields (1902) which was settled by a board of arbitrators appointed by President Roosevelt; and there were street railway strikes at Chester in 1908 and in Philadelphia in 1910. The calling in of Pinkerton detectives from Chicago and New

York to settle a strike in the Carnegie steel works at Homestead in 1892 precipitated a serious riot, in which about twenty persons were killed. It was necessary to call out two brigades of the state militia before the disorder was finally suppressed. The labour unions took advantage of this trouble to force Pennsylvania, Indiana, Illinois, Minnesota, Colorado and several other states to pass anti-Pinkerton statutes making it illegal to import irresponsible armed men from a distance to quell local disturbances. On the political side the chief features in the history of the state since 1865 have been the adoption of the constitution of 1873, the growth of the Cameron-Quay-Pearse political machine, and the attempts of the reformers to overthrow its domination. The constitution of 1838, which superseded that of 1790, extended the functions of the legislature, limited the governor's power of appointment, and deprived negroes of the right of suffrage. The provision last mentioned was nullified by the fourteenth and fifteenth amendments to the constitution of the United States. The chief object of the present state constitution (1873) was to prohibit local and special legislation. It increased the number of senators and representatives, created the office of lieutenant-governor, substituted biennial for annual sessions of the legislature, introduced minority representation in the choice of the higher judiciary and of the county commissioners and auditors and provided (as had an amendment adopted in 1850) for the election of all judges by popular vote. The political organization founded by Simon Cameron (q.v.) and strengthened by his son, James Donald Cameron, Matthew Stanley Quay and Boies Penrose (b. 1860), is based upon the control of patronage, the distribution of state funds among favoured banks, the support of the Pennsylvania railway and other great corporations, and upon the ability of the leaders to persuade the electors that it is necessary to vote the straight Republican ticket to save the protective system. Robert E. Pattison (1850-1904), a Democrat, was elected governor in 1883; and again in 1891, but he was handicapped by Republican legislatures. In 1905 a Democratic state treasurer was elected.

PENNSYLVANIA GOVERNORS.

Under Dutch Rule (1624-1664).¹

Cornelis Jacobsen Mey	Director	1624-1625
William van Hulst		1625-1626
Peter Minuit	Governor	1626-1632
David Pieterzen de Vries		1632-1633
Wouter van Twiller		1633-1638
William Kieft		1638-1647
Peter Stuyvesant		1647-1664

Under Swedish Rule (1638-1655).²

Peter Minuit		1638-1641
Peter Hollender		1641-1642
John Printz		1642-1653
John Pappegoya		1653-1654
John Claude Rysingh		1654-1655

Under the Duke of York (1664-1673).

Richard Nicolls		1664-1667
Robert Carr	Deputy	1664-1667
Robert Needham	Commander on the Delaware	1664-1668
Francis Lovelace		1667-1673
John Carr	Commander on the Delaware	1668-1673

Under Dutch Rule (1673-1674).

Anthony Colve		1673-1674
Peter Alrichs	Deputy on the Delaware	1673-1674

Under the Duke of York (1674-1681).

Sir Edmund Andros		1674-1681
-----------------------------	--	-----------

Under the Proprietors (1681-1693).

William Markham	Deputy-Governor	1681-1682
William Penn		1682-1684
Thomas Lloyd	President of the Council	1684-1686
Thomas Lloyd		
Robert Turner		
Arthur Cook	Executive Commissioners 1686-1688	
John Simcock		
John Eckley		
John Blackwell	Deputy-Governor	1688-1690

Thomas Lloyd	President of the Council	1690-1691
Thomas Lloyd	Deputy-Governor	1691-1693
William Markham		1691-1693
Under the Crown (1693-1695).		
Benjamin Fletcher		1693-1695
William Markham	Deputy-Governor	1693-1695
Under the Proprietors (1695-1776).		
William Markham	Deputy-Governor	1695-1699
William Penn		1699-1701
Andrew Hamilton	Deputy-Governor	1701-1703
Edward Shippen	President of the Council	1703-1704
John Evans	Lieutenant-Governor	1704-1709
Charles Gookin	"	1709-1717
Sir William Keith	"	1717-1726
Patrick Gordon	"	1726-1735
James Logan	President of the Council	1736-1738
George Thomas	Deputy-Governor	1738-1747
Anthony Palmer	President of the Council	1747-1748
James Hamilton	Lieutenant-Governor	1748-1754
Robert H. Morris	Deputy-Governor	1754-1756
William Denny	"	1756-1759
James Hamilton	"	1759-1763
John Penn	"	1763-1771
James Hamilton	President of the Council	1771-1771
Richard Penn	Lieutenant-Governor	1771-1773
John Penn	"	1773-1773

Period of Statehood (1776-).

Benjamin Franklin, Chairman of the Committee of Safety		1776-1777
Thomas Wharton, Jr.	President of the Council	1777-1778
George Bryan	Acting President of the Council	1777
Joseph Reed	President of the Council	1778-1781
William Moore	"	1781-1782
John Dickinson	"	1782-1785
Benjamin Franklin	"	1785-1784
Thomas Mifflin	"	1788-1790
Thomas Mifflin	Federalist	1790-1799
Thomas McKean	Democratic-Republican	1799-1803
Simon Snyder	"	1803-1817
William Finley	"	1817-1820
Joseph Heister	"	1820-1823
John A. Shulze	"	1823-1829
George Wolf	Democrat	1829-1835
Joseph Ritner	Anti-Masonic	1835-1839
D. R. Porter	Democrat	1839-1845
F. R. Shunk	"	1845-1848
W. F. Johnston	Whig	1848-1852
William Bigler	Democrat	1852-1859
James Pollock	"	1855-1858
W. F. Packer	"	1858-1861
A. G. Curtin	Republican	1861-1867
John W. Geary	"	1867-1873
John F. Hartranft	"	1873-1879
Henry M. Hoyt	"	1879-1885
Robert E. Pattison	Democrat	1883-1887
James A. Beaver	Republican	1887-1891
Robert E. Pattison	Democrat	1891-1895
Daniel H. Hastings	Republican	1895-1899
William A. Stone	"	1899-1903
Samuel W. Pennypacker	"	1903-1907
Edwin S. Stuart	"	1907-1911
John K. Tener	"	1911-

BIBLIOGRAPHY.—For the physiography of Pennsylvania, see W. S. Tower's "Regional and Economic Geography of Pennsylvania," in the *Bulletins of the Geographical Society of Philadelphia*, vols. iv., v., and vi. (Philadelphia, 1904-1908); J. P. Lesley, *A Summary Description of the Geology of Pennsylvania* (Harrisburg, 1892-1895); C. B. Trego, *A Geography of Pennsylvania* (Philadelphia, 1843); and *Topographic and Geologic Survey of Pennsylvania, 1906-1908* (Harrisburg, 1909). For industrial statistics see reports of the Twelfth United States Census, the *Special Reports on Manufactures in 1905*, by the United States Census Bureau, the annual reports on the *Mineral Resources of the United States*, by the United States Geological Survey, and the *Year Book of the United States Department of Agriculture*.

For the administration of the state see: *The Constitution of the Commonwealth of Pennsylvania*, adopted December 16, 1873, amended November 5, 1901 (Harrisburg, 1902); S. George et al. (editors), *Laws of Pennsylvania, 1682-1700*, preceded by the *Duke of York's Laws, 1676-1682* (Harrisburg, 1879); A. J. Dallas (editor), *Laws of Pennsylvania, 1700-1801* (Philadelphia and Lancaster, 1797-1801); *Laws of the General Assembly of Pennsylvania*

¹ Lloyd was deputy-governor of the province, the present state of Pennsylvania; Markham of the lower counties, the present state of Delaware.

² The state was governed by a supreme executive council in 1777-1790.

³ Governor Shunk resigned in July 1848 and was succeeded by W. F. Johnston, president of the state senate.

¹ Governors of New Netherland and of the Dutch settlements on the Delaware.

² The Swedish colonies on the Delaware conquered by the Dutch in 1655.

(Philadelphia, 1801 sqq. and Harrisburg, 1802 sqq.); and *The Statutes at Large of Pennsylvania* (Philadelphia, 1896 sqq.), published under an act of 1887. Some valuable information is to be found in B. A. and M. L. Hinsdale, *History and Civil Government of Pennsylvania* . . . (Chicago, 1899); and in the various editions of Smull's *Legislative Handbook and Manual*. For the history of penal and charitable institutions, see the *Annual Reports of the Board of Commissioners of Public Charities* (Harrisburg, 1871 sqq.); the *Annual Reports of the Committee on Lunacy* (Harrisburg, 1883 sqq.); and Amos H. Mylin, *Penal and Charitable Institutions of Pennsylvania* (2 vols., Harrisburg, 1897), an official publication, well written and handsomely illustrated. For educational history, see N. C. Schaefer, *The Common School Laws of Pennsylvania* (Harrisburg, 1904); B. A. Hinsdale, *Documents Illustrative of American Educational History* (Washington, 1895); and J. P. Wickersham, *History of Education in Pennsylvania* (Lancaster, 1886), one of the best state histories of education. For finance and banking, see the annual reports of the state treasurer, auditor-general, sinking fund commissioners, and the commissioner of banking, all published at Harrisburg; *An Historical Sketch of the Paper Money of Pennsylvania*, by a member of the Numismatic Society of Philadelphia (Philadelphia, 1862); and B. M. Mead, *A Brief Review of the Financial History of Pennsylvania . . . to the Present Time (1682-1881)* (Harrisburg, 1881).

The only complete history of the entire period is Howard M. Jenkins, *et al.*, *Pennsylvania, Colonial and Federal* (3 vols., Philadelphia, 1903). This is especially valuable for the detailed histories of gubernatorial administrations from 1790 to 1903. The third volume contains useful chapters on education, the judiciary, the medical profession, journalism, military affairs, internal improvements, &c. S. G. Fisher, *Pennsylvania, Colony and Commonwealth* (Philadelphia, 1897) contains the best short account of the colonial and revolutionary history, but it gives only a very brief summary of the period since 1783. W. R. Shepherd, *History of Proprietary Government in Pennsylvania* (New York, 1896), a detailed study of the proprietary from the political, governmental and territorial points of view, is scholarly, and gives a good account of the boundary disputes with Maryland, Virginia, New York and Connecticut. Among the older standard works are Samuel Hazard, *Annals of Pennsylvania from the Discovery of the Delaware, 1609-1682* (Philadelphia, 1850), an elaborate account of the early Dutch and Swedish settlements on the Delaware river and bay; and Robert Proud, *History of the Pennsylvania from 1681 until after the year 1742* (2 vols., Philadelphia, 1797-1798), written from the Quaker standpoint. For early literary history, see M. K. Jackson, *Outline of the Literary History of Colonial Pennsylvania* (New York, 1908). W. H. Egle, *Illustrated History of the Commonwealth of Pennsylvania* (Harrisburg, 1877), contains trustworthy histories of individual counties by various writers. J. B. McMaster and F. D. Stone, *Pennsylvania and the Federal Constitution, 1787-1788* (Philadelphia, 1888), is a useful work. For the anti-Masonic movement, see Charles McCarthy, *The Anti-Masonic Party* (Washington, 1903). S. G. Fisher, *The Making of Pennsylvania* (Philadelphia, 1896), introductory to the same author's *Colony and Commonwealth*, is an interesting study of the various nationalities and religions represented among the settlers of the state. For the period of Quaker predominance (1681-1756), see Isaac Sharpless, *History of Quaker Government in Pennsylvania* (2 vols., Philadelphia, 1898-1899). See also J. Taylor Hamilton's "History of the Moravian Church (Nazareth, Pa., 1900), vol. vi. of the *Transactions of the Moravian Historical Society; Proceedings and Addresses of the Pennsylvania German Society*, vols. vii. and viii. (Reading, 1897-1898); J. F. Sachse, *German Pietists of Provincial Pennsylvania, 1694-1708* (Philadelphia, 1895), and *German Sectarians of Pennsylvania, 1708-1800* (2 vols., Philadelphia, 1899-1901). The chief sources are the *Pennsylvania Archives* (first series, 12 vols., Philadelphia, 1852-1856; second series, 19 vols., Harrisburg, 1874-1893; and third series, 4 vols., Harrisburg, 1894-1895); *Colonial Records, 1683-1700* (16 vols., Philadelphia, 1852); and Samuel Hazard, *Register of Pennsylvania* (16 vols., Philadelphia, 1823-1836). The Pennsylvania Historical Society, organized in Philadelphia in 1825, has published 14 vols. of *Memoirs* (1826-1895), a *Bulletin* of 13 numbers (1845-1847), one volume of *Collections* (1853), and the *Pennsylvania Magazine of History and Biography*, a Quarterly (1877 sqq.). There is a good account of the public archives, both printed and manuscript, in the first report of the Public Archives Commission of the American Historical Association, published in vol. ii. of the annual report of the association for the year 1900 (Washington, 1901).

PENNSYLVANIA, UNIVERSITY OF, an American institution of higher learning, in Philadelphia, occupying about 60 acres, near the west bank of the Schuylkill river, north-east of the Philadelphia Hospital, east of 30th Street, south-east of Woodland Avenue, and south of Chestnut Street. In this irregular area are all the buildings except the Flower Astronomical Observatory (1896), which is 2 m. beyond the city limits on the West Chester Pike. The northernmost

of these buildings is the law school, between Chestnut and Sansom Streets, on 34th Street. In a great triangular block bounded by Woodland Avenue, Spruce Street, and 34th Street are: the university library, which had in 1909 about 275,000 bound volumes and 50,000 pamphlets, including the Biddle Memorial law library (1886) of 40,000 volumes, the Colwell and Henry C. Carey collections in finance and economics, the Francis C. Macaulay library of Italian, Spanish and Portuguese authors, with an excellent Dante collection, the classical library of Ernst von Leutsch of Göttingen, the philological library of F. A. Pott of Halle, the Germanic library of R. Bechstein of Rostock, the Semitic library of C. P. Caspari of Copenhagen, the Hebrew and Rabbinical Marcus Jastrow Memorial library, the ethnological library of D. G. Brinton, and several special medical collections; College Hall, with the university offices; Howard Houston Hall (1896) the students' club; Logan Hall; the Robert Hare chemical laboratory; and (across 36th Street) the Wistar Institute of anatomy and biology. Immediately east of this triangular block are: Bennett House; the Randall Morgan laboratory of physics; the engineering building (1906); the laboratory of hygiene (1892); dental hall; and the John Harrison laboratory of chemistry. Farther east are the gymnasium, training quarters and Franklin (athletic) field, with brick grand-stands. South of Spruce Street are: the free museum of science and art (1899), the north-western part of a projected group, with particularly valuable American, Egyptian, Semitic and Cretan collections, the last two being the results in part of university excavations at Nippur (1888-1902) and at Gournia (1901-1904); between 34th and 36th Streets the large and well-equipped university hospital (1874); large dormitories, consisting in 1909, of 29 distinct but connected houses; medical laboratories; a biological hall and vivarium; and across Woodland Avenue, a veterinary hall and hospital.

The university contains various departments, including the college (giving degrees in arts, science, biology, music, architecture, &c.), the graduate school (1882), a department of law (founded in 1790 and re-established in 1850) and a department of medicine (first professor, 1756; first degrees granted, 1768), the oldest and probably the most famous medical school in America. Graduation from the school of arts in the college is dependent on the successful completion of 60 units of work (the unit is one hour's work a week for a year in lectures or recitations or two hours' work a week for a year in laboratory courses); this may be done in three, four or five years; of the 60 counts; 22 must be required in studies (chemistry, 2 units; English, 6; foreign languages, 6; history, logic and ethics, mathematics, and physics, 2 each); 18 must be equally distributed in two or three "groups"—the 19 groups include astronomy, botany, chemistry, economics, English, fine arts, French, geology, German, Greek, history, Latin, mathematics, philosophy, physics, political science, psychology, sociology and zoology; and in the remaining 30 units the student's election is practically free. Special work in the senior year of the college counts 8 units for the first year's work in the department of medicine. College scholarships are largely local, two being in the gift of the governor of the state, fifty being for graduates of the public schools of the city of Philadelphia, and five being for graduates of Pennsylvania public schools outside Philadelphia; in 1909 there were twenty-eight scholarships in the college not local. In the graduate school there are five fellowships for research, each with an annual stipend of \$800, twenty-one fellowships valued at \$500 each, for men only, and five fellowships for women, besides special fellowships and 39 scholarships.

The corporation of the university is composed of a board of twenty-four trustees, of which the governor of Pennsylvania is *ex-officio* president. The directing head of the university, and the head of the university faculty and of the faculty of each department is the provost—a title rarely used in American universities; the provost is president *pro tempore* of the board of trustees.

In 1908-1909 the university had 454 officers of instruction, of whom 220 were in the college and 157 in the department

of medicine, and an enrolment of 4570 students, of whom 2989 were in the college (412 in the school of arts; 987 in the Towne scientific school; 472 in the Wharton school, and 253 in the evening school of accounts and finance; 384 in courses for teachers; and 481 in the summer school), 353 in the graduate school, 327 in the department of law, 559 in the department of medicine, 385 in the department of dentistry, and 150 in the department of veterinary medicine.

In August 1907 the excess of the university's assets over its liabilities was \$13,239,408 and the donations for the year were \$305,814. A very large proportion of the university's investments is in real estate, especially in Philadelphia. In 1907 the total value of real estate (including the university buildings) was \$6,829,154; and libraries, museums, apparatus and furniture were valued at \$2,025,357. Students' tuition fees vary from \$150 to \$200 a year in the college; and are \$160 in the department of law, \$200 in the department of medicine, \$150 in the department of dentistry and \$100 in the department of veterinary science. The income from tuition fees in 1906-1907 was \$458,396; the payments for "educational salaries" amounted to \$433,311, and for "administration salaries" to \$135,314.

The university publishes the following series: *Astronomical Series* (1899 sqq.); *Contributions from the Botanical Laboratory* (1892 sqq.); *Contributions from the Laboratory of Hygiene* (1898 sqq.); *Contributions from the Zoological Laboratory* (1893 sqq.); *Series in History* (1901 sqq.); *Series in Mathematics* (1897 sqq.); *Series in Philology and Literature* (1891 sqq.); *Series in Romanic Languages and Literatures* (1907 sqq.); *Series in Philosophy* (1890 sqq.); *Series in Political Economy and Public Law* (1885 sqq.); *The American Law Register* (1852 sqq.); *The University of Pennsylvania Medical Bulletin* (1888 sqq.); *Transactions of the Department of Archaeology* (1904 sqq.); *the Journal of Morphology* (1887 sqq.); and *Transactions and Proceedings of the Botanical Society of Pennsylvania* (1897 sqq.). There are also occasional publications by institutes and departments connected with the university. Student publications include: a daily, *The Pennsylvaniaist* (1885); the weekly, *Old Penn* (1902); a comic monthly, *The Punch Bowl*; a literary monthly, *The Red and Blue*; a quarterly of the department of dentistry, *The Penn Dental Journal*; an annual, *The Record*; and *The Alumni Register* (1896), a monthly.

Benjamin Franklin in 1749 published a pamphlet, entitled *Proposals Relating to the Education of Youth in Pensilvania*, which led to the formation of a board of twenty-four trustees, nineteen of whom, on the 13th of November 1749, met for organization and to promote "the Publick Academy in the City of Philadelphia," and elected Benjamin Franklin president of the board, an office which he held until 1756. So closely was Franklin identified with the plan that Matthew Arnold called the institution "the University of Franklin." On the 1st of February 1750 there was conveyed to this board of trustees the "New Building" on Fourth Street, near Arch, which had been erected in 1740 for a charity school—a use to which it had not been put—and as a "house of Publick Worship," in which George Whitefield had preached in November 1740; the original trustees (including Franklin) of the "New Building" and of its projected charity school date from 1740, and therefore the university attaches to its seal the words "founded 1740." In the "New Building" the academy was opened on the 7th of January 1751, the city having voted £200 in the preceding August for the completion of the building. On the 16th of September 1751 a charitable school "for the instruction of poor Children gratis in Reading, Writing, and Arithmetick" was opened in the "New Building." The proprietaries, Thomas and Richard Penn, incorporated "The Trustees of the Academy and Charitable School in the Province of Pennsylvania" in 1753; and in 1755 issued a confirmatory charter, changing the corporate name to "The Trustees of the College, Academy and Charitable School," &c., whereupon William Smith (1727-1803) of the university of Aberdeen, who had become rector of the academy in 1752 and had taken orders in the Church of England in 1753, became provost of the college. In 1756 Dr Smith established a complete and liberal curriculum which was adopted by Bishop James Madison in 1777 when he became president of the College of William and Mary. In 1757 the first college class graduated. Under Smith's control the Latin school grew in importance at the expense of the English school, to the great annoyance of Franklin. In 1762-1764 Dr Smith collected for

the college in England about £6000; and in 1764 his influence had become so strong that it was feared that the college would become sectarian. The Penns and others deprecated this and the trustees bound themselves (1764) to "use their utmost endeavours that . . . (the original plan) be not narrowed, nor the members of the Church of England, nor those dissenting from them . . . be put on any worse footing in this seminary than they were at the time of receiving the royal brief." From September 1777 to June 1778 college exercises were not held because Philadelphia was occupied by British troops. In 1779 the state legislature, on the ground that the trustees' declaration in 1764 was a "narrowing of the foundation," confiscated the rights and property of the college and chartered a new corporation "the Trustees of the University of the State of Pennsylvania"; in 1789 the college was restored to its rights and property and Smith again became its provost; in 1791 the college and the university of the State of Pennsylvania were united under the title, "the University of Pennsylvania," whose trustees were elected from their own members by the board of trustees of the college and that of the university. In 1802 the university purchased new grounds on Ninth Street, between Market and Chestnut, where the post office building now is; there until 1829 the university occupied the building erected for the administrative mansion of the president of the United States; there new buildings were erected after 1829; and from these the university removed to its present site in 1872.

The provosts have been: in 1755-1779 and in 1789-1803, William Smith; in 1779-1791, of the university of the state of Pennsylvania, John Ewing (1732-1802); in 1807-1810, John McDowell (1750-1820); in 1810-1813, John Andrews (1746-1813); in 1813-1828, Frederick Beasley (1777-1845); in 1828-1833, William Heathcote De Lancey (1797-1865); in 1834-1853, John Ludlow (1793-1857); in 1854-1859, Henry Vethake (1792-1866); in 1860-1868, Daniel Raynes Goodwin (1811-1890); in 1868-1880, Charles Janeway Stillé (1819-1899); in 1881-1894, William Pepper (1843-1898); in 1894-1910, Charles Custis Harrison (b. 1844), and in 1911 sqq. Edgar Fahs Smith (b. 1856).

See T. H. Montgomery, *A History of the University of Pennsylvania from its Foundation to A.D. 1770* (Philadelphia, 1900); George B. Wood, *Early History of the University of Pennsylvania* (3rd ed., ibid., 1896); J. B. McMaster, *The University of Pennsylvania* (ibid., 1897); G. E. Nitzsche, *Official Guide to the University of Pennsylvania* (ibid., 1906); and Edward P. Cheyney, "University of Pennsylvania," in vol. I. of *Universities and their Sons* (Boston, 1901).

PENNY (Mid. Eng. *peni* or *peny*, from O. Eng. form *penig*, earlier *penning* and *pendig*; the word appears in Ger. *Pfennig* and Du. *penning*; it has been connected with Du. *paud*, Ger. *Pfund*, and Eng. "pawn," the word meaning a little pledge or token, or with Ger. *Pfanne*, a pan), an English coin, equal in value to the one-twelfth of a shilling. It is one of the oldest of English coins, superseding the *scatta* or *scat* (see NUMISMATICS; and BRITAIN: *Anglo Saxon*, § "Coins"). It was introduced into England by Offa, king of Mercia, who took as a model a coin first struck by Pippin, father of Charlemagne, about 735, which was known in Europe as *novus denarius*. Offa's penny was made of silver and weighed 2½ grains, 240 pennies weighing one Saxon pound (or Tower pound, as it was afterwards called), hence the term pennyweight (dwt.). In 1527 the Tower pound of 5400 grains was abolished, and the pound of 5760 grains adopted instead. The penny remained, with some few exceptions, the only coin issued in England until the introduction of the gold florin by Edward III. in 1342. It was not until the reign of Edward I. that halfpence and farthings became a regular part of the coinage, it having been usual to subdivide the penny for trade purposes by cutting it into halves and quarters, a practice said to have originated in the reign of Æthelred II. In 1257, in the reign of Henry III., a gold penny,

¹ Probably the actual reason was that the assembly, dominated by the advocates of the radical constitution of 1776, was attempting to punish the trustees of the college, who were almost all "anti-constitutionalists."

of the value of twenty silver pence, was struck. The weight and value of the silver penny steadily declined from 1300 onwards; as will be seen from the following table:—

Reign.	Weight.	Value in silver 925 fine, at 5s. 6d. per oz.	
		Grains.	Penny.
William I., 1066		22½	3·09
Edward I., 1300		22	3·02
" III., 1344		20½	2·78
" III., 1346		20	2·75
" III., 1351		18	2·47
Henry IV., 1412		15	2·06
Edward IV., 1464		12	1·65
Henry VIII., 1527		10½	1·44
" VIII., 1543		10	1·37
Edward VI., 1552		8	1·10
Elizabeth, 1601		7½	1·06

The last coinage of silver pence for general circulation was in the reign of Charles II. (1661-1662), since which time they have only been coined for issue as royal alms on Maundy Thursdays. Copper halfpence were first issued in Charles II.'s reign,¹ but it was not until 1797, in the reign of George III., that copper pence were struck. This copper penny weighed 1 oz. avoirdupois. In the same year copper twopences were issued weighing 2 oz., but they were found too cumbersome and were discontinued. In 1866 bronze was substituted for the copper coinage, the alloy containing 95 parts of copper, 4 of tin, and 1 of zinc. The weight was also reduced, 1 lb of bronze being coined into 48 pennies, as against 24 pennies into which 1 lb of copper was coined.

PENN YAN, a village and the county-seat of Yates county, New York; U.S.A., situated N. of Keuka Lake, on the outlet extending to Lake Seneca, about 170 m. W. of Albany, and about 95 m. E. by S. of Buffalo. Pop. (1905), 4504; (1910) 4597. It is served by the New York Central & Hudson River and the Northern Central railways and by electric railway to Branchport, and has steamboat connexions with Hammondsport at the head of Keuka Lake. The lake, one of the most beautiful of the so-called "finger lakes" of central New York, abounds in lake and rainbow trout, black bass, pickerel and pike, and there are many summer cottages along its shores. At Keuka Park, on the west shore of the lake, is Keuka College (1890), and at Eggleston's Point is held a summer "natural science camp" for boys. The village is the seat of the Penn Yan Academy (1859). The lake furnishes water-power, and among the manufactures are paper, lumber, carriages, shoes, &c. Much ice is shipped from the village. Penn Yan is an important shipping point in the apple and grape-growing region of central New York, and winemaking is an important industry. The first frame dwelling at Penn Yan was built in 1799; the village became the county-seat in 1823, when Yates county was created, and was incorporated in 1833. The first settlers were chiefly followers of Jemima Wilkinson (1753-1819), a religious enthusiast, born in Cumberland township, Providence county, Rhode Island, who asserted that she had received a divine commission. She preached in Rhode Island, Connecticut, Massachusetts and Pennsylvania. Obtaining a large tract (which was called Jerusalem in 1789) in the present Yates county, she founded in 1788 the village of Hopeton on the outlet of Keuka Lake about a mile from Seneca Lake. Many followers settled there, and she herself lived there after 1790. Some of her followers left her before 1800, and then the community gradually broke up. The name of the village is said to have been derived from the first syllables of "Pennsylvania" and "Yankee," as most of the early settlers were Pennsylvanians and New Englanders.

¹ The figure of Britannia first appeared on this issue of copper coins. The original of Britannia is said to have been Frances Stewart, afterwards duchess of Richmond (Pepys, *Diary*, Feb. 25, 1667). It was in Charles II.'s reign, too, that the practice was established of placing the sovereign's bust in a direction contrary to that of his predecessor.

See Lewis C. Aldrich, *History of Yates County, New York* (Syracuse, 1892).

PENNYROYAL, in botany, a herb formerly much used in medicine, the name being a corruption of the old herbalist's name "Pulioll-royall," *Pulegium regium*. It is a member of the mint genus, and has been known to botanists since the time of Linnaeus as *Mentha pulegium*. It is a perennial herb with a slender branched stem, square in section, up to a foot in length and rooting at the lower nodes, small opposite stalked oval leaves about half-inch long, and dense clusters of small reddish-purple flowers in the leaf axils, forming almost globular whorls. It grows in damp gravelly places, especially near pools, on heaths and commons. It has a strong smell somewhat like that of spearmint, due to a volatile oil which is readily obtained by distillation with water, and is known in pharmacy as *Oleum pulegii*. The specific name recalls its supposed property of driving away fleas (*pulices*). Like the other mints it has carminative and stimulant properties.

PENOBSCOT, a tribe of North American Indians of Algonquian stock. Their old range was the country around the river Penobscot in Maine. They sided with the French in the colonial wars, but made a treaty of peace with the English in 1749. They fought against the English in the War of Independence, and were subsequently settled on an island in the Penobscot river, near Oldtown.

PENOLGY (Lat. *poena*, punishment), the modern name given to penitentiary science, that concerned with the processes devised and adopted for the repression and prevention of crime. (See CRIME; CRIMINOLOGY; PRISON; JUVENILE OFFENDERS; RECIDIVISM, &c.)

PENRHYN, GEORGE SHOLTO GORDON DOUGLAS-PENNANT, 2nd BARON (1836-1907), was the son of Colonel Edward Gordon Douglas (1800-1886), brother of the 10th earl of Morton, who, through his wife, Juliana, elder daughter and coheir of George Hay Dawkins-Pennant, of Penrhyn Castle, Carnarvon, had large estates in Wales and elsewhere, and was created Baron Penrhyn in 1866. Dawkins had inherited the estates from Richard Penryn, who was created Baron Penryn in 1763, the title becoming extinct on his death in 1808.

George Douglas-Pennant was conservative M.P. for Carnarvonshire in 1866-1868 and 1874-1880, and succeeded his father in the title in 1886. A keen sportsman, a benevolent landlord, a kind and considerate employer, Lord Penrhyn came of a proud race, and was himself of an imperious disposition. He came prominently before the public in 1897 and subsequent years in connexion with the famous strike at his Welsh slate-quarries. During his father's lifetime the management of the Penrhyn quarry had been left practically to an elective committee of the operatives, and it was on the verge of bankruptcy when in 1885 he took matters in hand; he abolished the committee, and with the help of Mr E. A. Young, whom he brought in from London as manager, he so reorganized the business that this slate-quarry yielded a profit of something like £150,000 a year. The new men and new methods were, however, not to the taste of the trade unionist leaders of the quarriesmen, and in 1897, when the "new unionism" was rampant in labour questions throughout England, a strike was deliberately fomented. Lord Penrhyn refused to recognize the union or its officials, though he was willing to consider any grievances from individual quarriesmen, and a protracted struggle ensued, in which his determination was invincible. He became the object of the bitterest political hostility, and trade unionism exerted itself to the utmost, but vainly, to bring about some form of government intervention. Penrhyn strikers perambulated the country, singing and collecting contributions to their funds. But in spite of every pressure Lord Penrhyn insisted on being master of his own property, and by degrees the agitation collapsed. His death on the 10th of March 1907 evoked general and genuine regret. Lord Penrhyn was twice married, and had fifteen surviving children. He was succeeded in the title by his eldest son, Edward Sholto (b. 1864), who was Unionist M.P. for South-Northamptonshire from 1895 to 1900.

PENRITH, a municipality of Cumberland county, New South Wales, Australia, on the Nepean River, 34 m. by rail W. by N. of Sydney. Penrith and the adjoining township of St Mary's are chiefly remarkable for their connexion with the railway. The iron tubular bridge which carries the line over the Nepean is the best of its kind in the colony, while the viaduct over Knapsack Gully is the most remarkable erection of its kind in Australia. There are large engineering works and railway fitting shops at Penrith, which is also the junction for all the western goods traffic. The inhabitants of both towns are mainly railway employes. Pop. (1901), of Penrith 3539, of St Mary's 1840.

PENRITH, a market town in the Penrith parliamentary division of Cumberland, England, in a valley near the river Eamont, on the Cockermonth, Keswick & Penrith, London & North Western and North Eastern railways. Pop. of urban district (1901), 9182. It contains some interesting brasses. A 14th-century grammar school was refounded by Queen Elizabeth; and there are two mansions dating from the same reign, which have been converted into inns. Though there are breweries, tanneries and saw-mills, the town depends mainly on agriculture. There are some ruins of a castle erected as a protection against the Scots. Near Penrith on the south, above the precipitous bank of the Eamont, stands a small but beautiful old castellated house, Yanwath Hall. To the north-east of the town is Eden Hall, rebuilt in 1824. Among many fine paintings, it contains portraits by Hoppner, Kneller, Lely, Opie and Reynolds. The "Luck of Eden Hall," which has been celebrated in a ballad by the duke of Wharton, and in a second ballad written by Uhland; the German poet, and translated by Longfellow, is an enamelled goblet, kept in a leather case dating from the times of Henry IV. or Henry V. It was long supposed to be Venetian, but has been identified as of rare Oriental workmanship. The legend tells how a senechal of Eden Hall one day came upon a company of fairies dancing at St Culbert's Well in the park. These flew away, leaving their cup at the water's edge, and singing "If that glass either break or fall, Farewell to the luck of Eden Hall." Its true history is unknown.

Penrith, otherwise Penreth, Perith, Perath, was founded by the Cambro-Celts, but on a site farther north than the present town. In 1222 Henry III. granted a yearly fair extending from the eve of Whitsun to the Monday after Trinity and a weekly market on Wednesday, but some time before 1278 the market day was changed to Tuesday. The manor in 1242 was handed over to the Scottish king who held it till 1295, when Edward I. seized it. In 1397 Richard II. granted it to Ralph Neville, first earl of Westmorland; it then passed to Warwick the king-maker and on his death to the crown. In 1694 William III. granted the honour of Penrith to the earl of Portland, by whose descendant it was sold in 1787 to the duke of Devonshire. A court leet and view of frankpledge have been held here from time immemorial. In the 18th and early part of the 19th century Penrith manufactured checks, linen cloth and gingham, but the introduction of machinery put an end to this industry, only the making of rag carpets surviving. Clock and watch-making seems to have been an important trade here in the 18th century. The town suffered much from the incursions of the Scots, and Ralph, earl of Westmorland, who died 1426, built the castle, but a tower called the Bishop's Tower had been previously erected on the same site. In 1597-1598 a terrible visitation of plague attacked the town, in which, according to an old inscription on the church, 2260 persons perished in Penrith, by which perhaps is meant the rural deanery. During the Civil War the castle was dismantled by the Royalist commandant. In 1745 Prince Charles Edward twice marched through Penrith, and a skirmish took place at Clifton. The church of St Andrew is of unknown foundation, but the list of vicars is complete from 1223.

PENRYN, JOHN (1559-1593), Welsh Puritan, was born in Brecknockshire in 1559; tradition points to Cefn Brith, a farm near Llangamarch, as his birthplace. He matriculated at

Peterhouse, Cambridge, in December 1580, being then almost certainly a Roman Catholic; but soon became a convinced Protestant, with strong Puritan leanings. Having graduated B.A., he migrated to St Alban's Hall, Oxford, and proceeded M.A. in July 1586. He did not seek episcopal ordination, but was licensed as University Preacher. The tradition of his preaching tours in Wales is slenderly supported; they could only have been made during a few months of 1586 or the autumn of 1587. At this time ignorance and immorality abounded in Wales. In 1562 an act of parliament had made provision for translating the Bible into Welsh, and the New Testament was issued in 1567; but the number printed would barely supply a copy for each parish church. Indignant at this negligence, Penry published, early in 1587, *The Equity of an Humble Supplication—in the behalf of the country of Wales, that some order may be taken for the preaching of the Gospel among those people*. Archbishop Whitgift, angry at the implied rebuke; caused him to be brought before the High Commission and imprisoned for about a month. On his release Penry married a lady of Northampton, which town was his home for some years. With the assistance of Sir Richard Knightley and others, he set up a printing press, which for nearly a year from Michaelmas 1588 was in active operation. It was successively located at East Moulsey (Surrey), Fawley (Northampton); Coventry and other places in Warwickshire, and finally at Manchester, where it was seized in August 1589. On it were printed Penry's *Exhortation to the governors and people of Wales*, and *View of . . . such publick wants and disorders as are in the service of God . . . in Wales*; as well as the celebrated *Martin Marprelate* tracts. In January 1590 his house at Northampton was searched and his papers seized, but he succeeded in escaping to Scotland. There he published several tracts, as well as a translation of a learned theological work known as *Theses Genevoenses*. Returning to England in September 1592, he joined the Separatist Church in London, in which he declined to take office, though after the arrest of the ministers, Francis Johnson and John Greenwood, he seems to have been the regular preacher. He was arrested in March 1593, and efforts were made to find some pretext for a capital charge. Failing this a charge of sedition was based on the rough draft of a petition to the queen that had been found among his private papers; the language of which was indeed harsh and offensive, but had been neither presented nor published. He was convicted by the Queen's Bench on the 21st of May 1593, and hanged on the 29th at the unusual hour of 4 p.m., the signature of his old enemy Whitgift being the first of those affixed to the warrant.

See the *Life*, by John Waddington (1854).

PENRYN, a market town and port, and municipal and contributory parliamentary borough of Cornwall, England, 2 m. N.W. of Falmouth, on a branch of the Great Western railway. Pop. (1901), 3190. It lies at the head of the estuary of the Penryn River, which opens from the main estuary of the Fal at Falmouth. Granite, which is extensively quarried in the neighbourhood, is dressed and polished at Penryn, and there are also chemical and bone manure works, engineering, iron and gunpowder works, timber-yards, brewing, tanning and paper-making. The harbour dries at low tide, but at high tide has from 9 to 12½ ft. of water. Area, 291 acres.

Penryn owed its development to the fostering care of the bishops of Exeter within whose demesne lands it stood. These lands appear in Domesday Book under the name of Trelivel. In 1290 Bishop Briwere granted to his burgesses of Penryn that they should hold their burgeses freely at a yearly rent of 12d. by the acre for all service. Bishop Walter de Stapeldon secured a market on Thursdays and a fair at the Feast of St Thomas. The return to the bishop in 1307 was £7, 13s. 2½d. from the borough and £26, 7s. 3d. from the forum. In 1311 Bishop Stapeldon procured a three days' fair at the Feast of St Vitalis. Philip and Mary gave the parliamentary franchise to the burgesses in 1553. James I. granted and renewed the charter of incorporation, providing a mayor, eleven

aldermen and twelve councillors, markets on Wednesdays and Saturdays, and fairs on the 1st of May, the 7th of July and the 21st of December. The charter having been surrendered, James II. by a new charter *inter alia* confined the parliamentary franchise to members of the corporation. This proviso however was soon disregarded, the franchise being freely exercised by all the inhabitants paying scot and lot. An attempt to deprive the borough of its members, owing to corrupt practices, was defeated by the House of Lords in 1827. The act of 1832 extended the franchise to Falmouth in spite of the rivalry existing between the two boroughs, which one of the sitting members asserted was so great that no Penryn man was ever known to marry a Falmouth woman. In 1885 the united borough was deprived of one of its members. The corporation of Penryn was remodelled in 1835, the aldermen being reduced to four. Its foreign trade, which dates from the 14th century, is considerable. The extra-parochial collegiate church of Glasney, founded by Bishop Bronescombe in 1265, had a revenue at the time of its suppression under the act of 1545 of £221, 18s. 4d.

See *Victoria County History, Cornwall*; T. C. Peter, *Glasney Collegiate Church*.

PENSACOLA, a city, port of entry, and the county-seat of Escambia county, Florida, U.S.A., in the N.W. part of the state, on Pensacola Bay, about 6 m. (11 m. by channel) N. of the Gulf of Mexico. Pop. (1900) 17,747; (1910) 22,982. It ranks second in size among the cities of Florida. The city is served by the Louisville & Nashville and the Pensacola, Alabama & Tennessee railways, and by steamers to West Indian, European and United States ports. The harbour¹ is the most important deep-water harbour south of Hampton Roads. The narrow entrance is easily navigable and is defended by Fort Pickens on the west end of Santa Rosa Island, with a great sea-wall on the Gulf side (completed in 1909), Fort McRee on a small peninsula directly opposite, and Fort Barrancas on the mainland immediately north-east of Fort McRee. On the mainland 1 m. east of Fort Barrancas are the United States Naval Station, consisting of a yard (84 acres enclosed) with shops, a steel floating dry dock and marine barracks; and a reservation (1800 acres) on which are a naval hospital, a naval magazine, two timber ponds, a national cemetery, and the two villages of Warrington and Woolsey, with a population of about 1500, mostly employes of the yard. The city's principal public buildings are the state armoury, the Federal building, and the city hall. The mean annual temperature is about 72° F., and breezes from the Gulf temper the heat. Pensacola is a shipping point for lumber, naval stores, tobacco, phosphate rock, fish, cotton and cotton-seed oil, meal and cake, and is one of the principal markets in the United States for naval stores. In 1895 the foreign exports were valued at \$3,196,609, in 1897 at \$8,436,679, and in 1909 at \$20,971,670; the imports in 1909 were valued at \$1,479,017. The important factor in this vast development has been the Louisville & Nashville railway, which after 1893 built extensive warehouses and docks at Pensacola. There are excellent coaling docks—good coal is brought hither from Alabama—and a grain elevator. Among the manufactures are sashes, doors and blinds, whitening, fertilizers, rosin and turpentine, and drugs.

Pensacola Bay may have been visited by Ponce de Leon in 1513 and by Panfilo de Narvaez in 1528. In 1540 Maldonado, the commander of the fleet that brought De Soto to the Florida coast, entered the harbour, which he named Puerta d'Auchusi, and on his recommendation De Soto designated it as a basis of supplies for his expedition into the interior. In 1559 a permanent settlement was attempted by Tristan de Luna, who renamed the harbour Santa Maria, but two years later this settlement was abandoned. In 1696 another settlement was made by Don Andres d'Arriola, who built Fort San Carlos near the site of the present Fort Barrancas, and seems to have named the place Pensacola. In 1719, Spain and France, being at war, Pensacola was captured by Sieur de Bienville, the French

governor of Louisiana. Later in the same year it was successively re-taken by a Spanish force from Havana and recaptured by Bienville, who burned the town and destroyed the fort. In 1723, three years after the close of hostilities, Bienville relinquished possession. The Spanish then transferred their settlement to the west end of Santa Rosa Island, but after a destructive hurricane in 1754 they returned to the mainland. In 1763, when the Floridas were ceded to Great Britain, Pensacola became the seat of administration for West Florida and most of the Spanish inhabitants removed to Mexico and Cuba. During the War of American Independence the town was a place of refuge for many Loyalists from the northern colonies. On the 9th of May 1781 it was captured by Don Bernardo de Galves, the Spanish governor at New Orleans. Most of the English inhabitants left, but trade remained in the hands of English merchants. During the War of 1812 the British made Pensacola the centre of expeditions against the Americans, and in 1814 a British fleet entered the harbour to take formal possession. In retaliation General Andrew Jackson attacked the town, driving back the British. In 1818, on the ground that the Spanish encouraged the Seminole Indians in their attacks upon the American settlements in the vicinity, Jackson again captured Pensacola, and in 1821 Florida was finally transferred to the United States. On the 12th of January 1861 the Navy Yard was seized by order of the state government, but Fort Pickens, defended first by an insignificant force under Lieut. Adam J. Slemmer (1828-68) and afterwards by a larger force under Lieut.-Colonel Harvey Brown (1796-1874), remained in the hands of the Union forces, and on the 8th of May 1862 the Confederates abandoned Pensacola. Pensacola was chartered as a city in 1895.

PENSHURST, a village in the south-western parliamentary division of Kent, England, at the confluence of the Eden and Medway, 4½ m. S.W. of Tonbridge. Pop. (1901), 1678. The village is remarkable for some old houses, including a timbered house of the 15th century, and for a noted factory of cricket implements. The church, chiefly late Perpendicular, contains a large number of monuments of the Sidney family and an effigy of Sir Stephen de Penchester, Warden of the Cinque Ports in the time of Edward I. Penshurst Place is celebrated as the home of the Sidney family. Anciently the residence of Sir Stephen de Penchester, Penshurst was granted to Henry VIII.'s chamberlain, Sir William Sidney, whose grandson, Sir Philip Sidney, was born here in 1554. It passed to Sir Philip's younger brother Robert, who in 1618 was created earl of Leicester. On the death of the seventh earl in 1743 the estates devolved upon his niece Elizabeth, whose only child married Sir Bysshe Shelley of Castle Goring. Their son was created a baronet in 1818 as Sir John Shelley-Sidney, and his son was created Baron de L'Isle and Dudley in 1835. The mansion is quadrangular, and has a fine court, chapel and hall (c. 1341) with open timber roof and a minstrels' gallery. The various rooms contain an interesting collection of portraits, armour and other family relics. The praises of the park and the house have been sung in Sir Philip Sidney's *Arcadia*, and by Ben Jonson, Edmund Waller and Robert Southey.

PENSION (Lat. *pensio*, a payment, from *pendere*, to weigh, to pay), a regular or periodical payment made by private employers, corporations or governments, in consideration either of past services or of the abolition of a post or office. Such a pension takes effect on retirement or when the period of service is over. The word is also used in the sense of the payment by members of a society in respect of dues.

United Kingdom.

In the United Kingdom the majority of persons in the employ of the government are entitled to pensions on reaching a certain age and after having served the state for a certain minimum number of years. That such is the case, and moreover that it is usual to define such pensions as being given in consideration of past services, has led to the putting forward very generally the argument that pensions, whether given by a government or

¹ In 1881 the United States government began to improve the harbour by dredging, and in June 1909 the depth of the channel, for a minimum width of about 300 ft., was 30 ft. at mean low water.

by private employers, are in the nature of deferred pay, and that holders of posts which carry pensions must therefore be rewarded by a remuneration less than the full market rate, by the difference of the value of the pension. This view is hardly correct, for the object of attaching a pension to a post is not merely to reward past services, but to attract continuity of service by the holder as well as to enable the employer to dispense with the services of the employé without hardship to him should age or infirmity render him less efficient. Dissatisfaction has been expressed from time to time by members of the English civil service with the system in force, viz. that the benefit of long service was confined only to survivors, and that no advantage accrued to the representatives of those who died in service. This was altered by an act of 1909. See *Royal Commission on Superannuation in the Civil Service: Report and Evidence* (1903). For the general pensions given by the state to the aged poor see OLD AGE PENSIONS.

Civil Service.—In the English civil service the grant of pensions on superannuation is regulated by statute, the four principal acts being the Superannuation Acts of 1834, 1859, 1887 and 1909. To qualify for a pension it is necessary (1) that a civil servant should have been admitted to the service with a certificate from the civil service commissioners, or hold an office specially exempted from this requirement; (2) that he should give his whole time to the public service; (3) that he should draw the emoluments of his office from public funds exclusively; (4) that he should have served for not less than ten years; (5) that if under the age of 60 years he should be certified to be permanently incapable, from infirmity of body or mind, of discharging his official duties, or have been removed from his office on the ground of his inability to discharge his duties efficiently. On retirement on these conditions a civil servant is qualified for a pension calculated at one-eightieth of his retiring salary (or, in certain cases, of his average salary for the last three years) for each complete year of service, subject to a maximum of forty-eightieths. Civil servants retiring on the ground of ill health after less than ten years' service qualify for a gratuity of one month's pay for each year of service. Previous to the Superannuation Act of 1909 the pension was calculated at the rate of one-sixtieth of the retiring salary for each completed year of service, subject to a maximum of forty-sixtieths. This is still the rate for those who entered the service previous to the passing of the act (September 20, 1909) unless they availed themselves of the permission in the act to take advantage of its provisions, which were more than a compensation for the lowering of the rate. The act gave power to the treasury to grant by way of additional allowance to a civil servant who retired after not less than two years' service, in addition to his superannuation, a lump sum equal to one-thirtieth of his annual salary and emoluments multiplied by the number of completed years he has served, so however that such lump sum does not exceed one and a half times his salary, while if he retires after attaining the age of sixty-five years, there must be deducted from that lump sum one-twentieth for every completed year that he has served after attaining that age. In the case of those who entered the service before the passing of the act, and take advantage of the act, this additional allowance is increased by one-half per cent. for each completed year served at the passing of the act. The act also provided that where a civil servant died after serving five years or upwards, a gratuity equal to his annual salary and emoluments might be granted to his legal personal representatives. Where the civil servant attains the age of sixty-five this gratuity is reduced by one-twentieth for each completed year beyond that age. On the other hand, where the civil servant has retired from the service and all the sums received by him at his death on account of superannuation are less than his annual salary his representatives may receive the difference as a gratuity. Provision was also made in the act for granting compensation on abolition of office, provided that such compensation does not exceed what the recipient might be granted or be entitled to if he retired on the ground of ill health. Pensions are also sometimes awarded in excess of the scale as a reward for special services, as compensation for injury in certain cases, or to holders of professional offices, appointed at an age exceeding that at which public service ordinarily begins. In the estimates for civil services for the year 1909-1910, there was provided for non-effective and charitable services (as pensions and gratuities in lieu of pensions are known as) the sum of £9,625,920; this, however, included an item of £8,750,000 for old-age pensions, leaving a sum of £875,920. There was charged on the Consolidated Fund, on account of pensions and compensation allowance for civil, judicial and other services, a sum of £142,767, while the following sums for civil pensions were provided in the estimates of the several departments: War Office, £150,000; Admiralty, £369,800; Customs and Excise, £412,358; Inland Revenue, £116,000; Post Office, £649,000; Royal Irish Constabulary, £116,500; Dublin Metropolitan Police, £33,646; making a total of £2,298,167, or a gross total for civil pensions of

£3,174,067. A return is published annually containing a complete list of the various pensions.

Perpetual or Hereditary Pensions.—Perpetual pensions were freely granted either to favourites or as a reward for political services from the time of Charles II. onwards. Such pensions were very frequently attached as "salaries" to places which were sinecures, or, just as often, posts which were really necessary were grossly overpaid, while the duties were discharged by a deputy at a small salary. Prior to the reign of Queen Anne such pensions and annuities were charged on the hereditary revenues of the sovereign and were held to be binding on the sovereign's successors (*The Bankers' Case*, 1691; *State Trials*, xiv. 3-43). By 1 Anne c. 7, it was provided that no portion of the hereditary revenues could be charged with pensions beyond the life of the reigning sovereign. This act did not affect the hereditary revenues of Ireland and Scotland, and many persons were quartered, as they had been before the act, on the Irish and Scottish revenues who could not be provided for in England—for example, the duke of St Albans, illegitimate son of Charles II., had an Irish pension of £800 a year; Catherine Sedley, mistress of James II., had an Irish pension of £5000 a year; the duchess of Kendall and the countess of Darlington, mistresses of George I., had pensions of the united annual value of £5000, while Madame de Walmoden, a mistress of George II., had a pension of £3000 (*Leccky, History of Ireland in the Eighteenth Century*). These pensions had been granted in every conceivable form—during the pleasure of the Crown, for the life of the sovereign, for terms of years, for the life of the grantee, and for several lives in being or in reversion (*Erskine May, Constitutional History of England*). On the accession of George III. and his surrender of the hereditary revenues in return for a fixed civil list, this civil list became the source from which the pensions were paid. The subsequent history of the civil list will be found under that heading (CIVIL LIST), but it may be here mentioned that the three pension lists of England, Scotland and Ireland were consolidated in 1830, and the civil pension list reduced to £75,000, the remainder of the pensions being charged on the Consolidated Fund.

In 1887, Charles Braslaugh, M.P., protested strongly against the payment of perpetual pensions, and as a result a Committee of the House of Commons inquired into the subject (*Report of Select Committee on Perpetual Pensions*, 248, 1887). An appendix to the Report contains a detailed list of all hereditary pensions, payments and allowances in existence in 1881, with an explanation of the origin in each case and the ground of the original grant; there are also shown the pensions, &c., redeemed from time to time, and the terms upon which the redemption took place. The nature of some of these pensions may be gathered from the following examples: To the duke of Marlborough and his heirs in perpetuity, £4000 per annum; this annuity was redeemed in August 1884 for a sum of £107,780, by the creation of a ten years' annuity of £12,796, 17s. per annum. By an act of 1806 an annuity of £500 per annum was conferred on Lord Nelson and his heirs in perpetuity. In 1793 an annuity of £2000 was conferred on Lord Rodney and his heirs. All these pensions were for services rendered, and although justifiable from that point of view, a preferable policy is pursued in the 20th century, by parliament voting a lump sum, as in the cases of Lord Kitchener in 1902 (£50,000) and Lord Cromer in 1907 (£50,000). Charles II. granted the office of receiver-general and controller of the seals of the court of king's bench and common pleas to the duke of Grafton. This was purchased in 1825 from the duke for an annuity of £843, which in turn was commuted in 1883 for a sum of £27,714, 12s. 8d. To the same duke was given the office of the pipe or remembrancer of first-fruits and tenths of the clergy. This office was sold by the duke in 1765, and after passing through various hands was purchased by one R. Harrison in 1798. In 1835 on the loss of certain fees the holder was compensated by a perpetual pension of £62, 9s. 8d. The duke of Grafton also possessed an annuity of £6870 in respect of the commutation of the dues of butlerage and prisage. To the duke of St Albans was granted in 1684 the office of master of the hawks. The sums granted by the original patent were: master of hawks, salary, £391, 1s. 5d.; four falcons at £50 per annum each, £200; provision of hawks, £600; provision of pigeons, hens and other meats, £182, 10s.; total, £1373, 11s. 5d. This amount was reduced by office fees and other deductions to £965, at which amount it stood, until commuted in 1891 for £18,335. To the duke of Richmond and his heirs was granted in 1676 a duty of one shilling per ton on all coals exported from the Tyne for consumption in England. This was redeemed in 1799 for an annuity of £19,000 (chargeable on the consolidated fund), which was afterwards redeemed for £633,333. The duke of Hamilton, as hereditary keeper of the palace, Holyrood House, received a perpetual pension of £45, 10s., and the descendants of the heritable usher of Scotland drew a salary of £24, 10s. The conclusions of the committee were that pensions, allowances and payments should not in future be granted in perpetuity, on the ground that such grants should be limited to the persons actually rendering the services, and that such rewards should be defrayed by the generation benefited; that offices with salaries and without duties, or with merely nominal duties, ought

to be abolished; that all existing perpetual pensions and payments and all hereditary offices should be abolished: that where no service or merely nominal service is rendered by the holder of an hereditary office or the original grantee of a pension, the pension or payment should in no case continue beyond the life of the present holder and that in all cases the method of commutation ought to ensure a real and substantial saving to the nation (the existing rate, about 27 years' purchase, being considered by the committee to be too high). These recommendations of the committee were adopted by the government and outstanding hereditary pensions were gradually commuted, the only ones left outstanding being those to Lord Rodney (£2000) and to Earl Nelson (£5000), both chargeable on the consolidated fund.

Political Pensions.—By the Political Offices Pension Act 1869, pensions were instituted for those who had held political office. For the purposes of the act political offices were divided into three classes: (1) those with a yearly salary of not less than £5000; (2) those with a salary of less than £5000 and not less than £2000; (3) those with a salary of less than £2000 and more than £1000. For service in these offices there may be awarded pensions for life in the following scale: (1) a first class pension not exceeding £2000 a year, in respect of not less than four years' service or its equivalent, in an office of the first class; (2) a second class pension not exceeding £1200, in respect of service of not less than six years or its equivalent, in an office of the second class; (3) a third class pension not exceeding £800 a year, in respect of service of not less than ten years in an office of the third class. The service need not be continuous, and the act makes provision for counting service in lower classes as a qualification for pension in a higher class. These pensions are limited in number to twelve, but a holder must not receive any other pension out of the public revenue, if so, he must inform the treasury and surrender it if it exceeds his political pension, or if under he must deduct the amount. He may, however, hold office while a pensioner, but the pension is not payable during the time he holds office. To obtain a political pension, the applicant must file a declaration stating the grounds upon which he claims it and that his income from other sources is not sufficient to maintain his station in life.

Civil List Pensions.—These are pensions granted by the sovereign from the civil list upon the recommendation of the first lord of the treasury. By 1 & 2 Vict. c. 2 they are to be granted to "such persons only as have just claims on the royal beneficence or who by their personal services to the Crown, or by the performance of duties to the public, or by their useful discoveries in science and attainments in literature and the arts, have merited the gracious consideration of their sovereign and the gratitude of their country." A sum of £1200 is allotted each year from the civil list, in addition to the pensions already in force. From a *Returns* issued in 1908 the total of civil list pensions payable in that year amounted to £24,665.

Judicial, Municipal, &c.—There are certain offices of the executive whose pensions are regulated by particular acts of parliament. Judges of the Supreme Court, on completing fifteen years' service or becoming permanently incapacitated for duty, whatever their length of service, may be granted a pension equal to two-thirds of their salary (Judicature Act 1873). The lord chancellor of England however short a time he may have held office, receives a pension of £5000, but he usually continues to sit as a law lord in the House of Lords—so also does the lord chancellor of Ireland, who receives a pension of £3,692 6s. 1d. A considerable number of local authorities have obtained special parliamentary powers for the purpose of superannuating their officials and workmen who have reached the age of 60-65. Poor law officers receive superannuation allowances under the Poor Law Officers Superannuation Acts 1864-1897.

Ecclesiastical Pensions.—Bishops, deans, canons or incumbents who are incapacitated by age or infirmity from the discharge of their ecclesiastical duties may receive pensions which are a charge upon the revenues of the see or cure vacated.

Navy pensions were first instituted by William III. in 1693 and regularly established by an order in council of Queen Anne in 1700. Since then the rate of pensions has undergone various modifications and alterations; the full regulations concerning pensions to all ranks will be found in the quarterly *Navy List*, published by the authority of the Admiralty. In addition to the ordinary pensions there are also good-service pensions, Greenwich Hospital pension and pensions for wounds. An officer is entitled to a pension when he is retired at the age of 45, or if he retires between the ages of 40 and 45 at his own request, otherwise he receives only half pay. The amount of his pension depends upon his rank, length of service and age. The maximum retired pay of an admiral is £850 per annum, for which 30 years' service or its equivalent in half-pay time is necessary; he may, in addition, hold a good service pension of £300 per annum. The maximum retired pay of a vice-admiral, with 29 years' service is £725; of rear-admirals with 27 years' service £600 per annum. Pensions of captains who retire at the age of 55, commanders, who retire at 50, and lieutenants who retire at 45, range from £200 per annum for 17 years' service to £225 for 24 years' service. The pensions of other officers are calculated in the same way, according to age and length of service. The

good-service pensions consist of ten pensions of £300 per annum for flag-officers, two of which may be held by vice-admirals and two by rear-admirals; twelve of £150 for captains; two of £200 a year and two of £150 a year for engineer officers; three of £100 a year for medical officers of the navy; six of £500 a year for general officers of the Royal Marines and two of £150 a year for colonels and lieutenant-colonels of the same. Greenwich Hospital pensions range from £150 a year for flag officers to £25 a year for warrant officers. All seamen and marines who have completed twenty-two years' service are entitled to pensions ranging from 10d. a day to a maximum of 1s. 2d. a day, according to the number of good-conduct badges, together with the good-conduct medal, possessed. Petty officers, in addition to the rates of pension allowed them as seamen, are allowed for each year's service in the capacity of superior petty officer, 15s. 2d. a year, and in the capacity of inferior petty officer 7s. 7d. a year. Men who are discharged the service on account of injuries and wounds or disability attributable to the service are pensioned with sums varying from 6d. a day to 2s. a day. Pensions are also given to the widows of officers in certain circumstances and compassionate allowances made to the children of officers. In the Navy estimates for 1908-1909 the amount required for half-pay and retired-pay was £868,800, and for pensions, gratuities and compassionate allowances £1,334,600, a total of £2,203,400.

Army.—The system of pensions in the British Army is somewhat intricate, provision being made for dealing with almost every case separately. As a general rule officers can retire after eight years' service on a pension of £100 per annum for ten years, provided that they take commissions in either the Imperial Yeomanry or Special Reserve and attend the annual trainings during that period. The other pensions are as follows: 2nd lieutenants, lieutenants, captains and majors after 15 years' service (or 12 years in the West India regiment), £120; if 45 years of age £200; if major, after 25 years' service, £200. Royal artillery or royal engineers if commissioned, after 21 years of age, £300; if 48 years of age, £500; lieutenant-colonels, after 2 years as such, with 15 years' service, £450; with 27 years' service, £300; with 30 years' service, £365; after term of employment as lieutenant-colonel commanding a unit, or staff appointment as lieutenant-colonel, or after 5 years as lieutenant-colonel cavalry and infantry, £420. Royal artillery, royal engineers and army service corps, £450; Colonels, after 5 years as colonel, cavalry and infantry, £420. Royal artillery, royal engineers and army service corps, £450, after completing the term of command of a regimental district or a regiment of foot-guards, or employed in any other capacity for three years, £450-£500 according to age; Brevet-colonels, with the substantive rank of lieutenant-colonel, receive, cavalry or infantry, £420; royal artillery, royal engineers and army service corps, £450. Major-generals retire at the age of 62 with a pension of £700; lieutenant-generals at 67 with £850; generals at 67 with £1000.

Officers whose first permanent commission bears date prior to the 1st of January, 1887, retire with a gratuity in lieu of pension. Officers of the departmental corps retire either with pensions ranging from £1125 yearly to 10s. daily, or with gratuities ranging from £500 to £1000.

Warrant officers with 5 years' service as such, and 20 years' total service, receive 3s. 6d. per diem if discharged from the service on account of disability, reduction of establishment or age. On discharge for any reasons (except misconduct or inefficiency) they receive from 3s. 6d. to 5s. per diem, according to length of service and corps. If they have less than 5 years' service as warrant officers, but not less than 21 years' total service, they receive at least 3s. per diem; and if discharged at their own request after 18 years' total service, 2s. 7½d.

Additional pensions are given at the rate of 6d. per diem for gallant conduct, and 1½d. to 1s. per diem for re-employed pensioners on completing their second term of employment, with 3d. per diem extra if promoted while so serving. Special pensions are also granted in exceptional cases.

For the purposes of pensions, non-commissioned officers are divided into four classes, corresponding roughly to quartermaster-sergeants, colour-sergeants, sergeants and corporals.

With not more than 21 years' total service, and with the following continuous service in one of the above classes, the rates of pensions (per diem) are:—

Class.	12 years' Service.	9 years' Service.	6 years' Service.	3 years' Service.
	s. d.	s. d.	s. d.	s. d.
I.	2 9	2 6	2 3	2 0
II.	2 6	2 3	2 0	1 9
III.	2 3	2 0	1 9	1 6
IV.	1 8	1 6	1 4	1 0

Privates (Class V.) receive the following pensions:

21 years' Service.	20 years' Service.	19 years' Service.	18 years' Service.	14 to 18 years' Service.
1s. 1d.	1s. 0d.	11d.	10d.	8d. to 10d.

For service in excess of 21 years, the following amounts are added to the pensions enumerated above:—

	For each complete year in excess of 21 years.
Classes I. to III.	1d. per diem to 9d. per diem.
Classes IV. and V.	1d. per diem to 5d. per diem.

A man promoted to higher rank within one year of his completing 21 years' service, receives, on his discharge in the higher rank, an extra 3d. per diem, provided that he has completed 25 years' service in all. An additional pension of 6d. per diem is awarded for gallant conduct, as in the case of warrant officers.

N.C.O.'s and men disabled through military service are granted the following pensions:—

If partially capable of earning a livelihood	Per diem.
Class I. to III.	1s. to 3s.
IV.	9d. to 2s.
V.	6d. to 1s. 6d.
If totally incapable of earning a livelihood	Per diem.
Class I. to III.	2s. 6d. to 3s. 6d.
IV.	2s. 0d. to 3s. 0d.
V.	1s. 6d. to 2s. 6d.

Pensions may also be granted to N.C.O.'s and men who are disabled by causes other than military service, according to circumstances.

United States.

In the ordinary sense of the word, pensions in the United States are confined to federal judges and officers of the army and navy, but the United States "Pension Fund" is so singular a feature of the national budget, that it is desirable to give an account of the different classes of allowances which are granted. In the United States allowances for services in wars prior to the 4th of March 1861 are called "old war" pensions, and may be divided into three classes, viz., (1) invalid pensions, based upon wounds or injuries received, or disease contracted in the course of duty, (2) "service" pensions, and (3) land bounties, both granted for service irrespective of injuries.

The first provision made by Congress for pensions was a resolution passed on the 26th of August 1776, promising invalid pensions to officers and men of the army or navy who lost a limb or were otherwise disabled in the War of Independence, at a rate equal to half of their monthly pay as officers or soldiers during life or continuance of the disability, those not totally disabled to receive an adequate monthly pension not to exceed half of their pay. Then followed various Acts of Congress enlarging the provisions for invalid pensions and extending them to those who had been in the war of 1812, and to the widows and children of those who died in the war or from wounds received in the war. The act of the 3rd of May 1846, provided for the prosecution of the war with Mexico and for pensioning those volunteers wounded or otherwise disabled in service. Other acts were subsequently passed making further provision for pension on account of service in the Mexican war. The first general law granting "service" pensions was not passed until the 18th of March 1818, thirty-five years after the termination of the War of Independence. Its beneficiaries were required to be in indigent circumstances and in need of assistance from their country. Two years later Congress became alarmed by reason of the large number of claims filed (about 8000), and enacted what was known as the "Alarm Act," requiring each applicant for pension and each pensioner on the rolls to furnish a schedule of his whole estate and income, clothing and bedding excepted. Many pensioners were dropped who were possessed of as much as \$150 worth of property. Numerous acts were, however, passed from time to time liberalizing the law or dealing more generously with the survivors of the Revolution. Service pensions were not granted to widows of the soldiers of this war until 1836, and then only for a period of five years and on condition that the marriage of the soldier was prior to his last service, and that the soldier's service was not less than six months. In 1853, seventy years after the close of the war, the limitation as to the time of marriage was removed. The rolls in 1901 contained nine and in 1908 two pensions based upon service in the War of Independence. The last survivor was Daniel F. Bakeman, who died on the 5th of April 1869, aged 109 years and 6 months.

The first law granting service pensions on account of the war of 1812 was passed in 1871, fifty-six years after the close of the war. This act required sixty days' service. Widows were not pensionable unless the marriage to the soldier had taken place prior to the treaty of peace of 15th February 1815. On 9th March 1878, sixty-three years after the war, an act was passed reducing the requisite period of service to fourteen days and removing the limitations as to date of marriage. In 1908 the pension rolls

contained the names of 471 widows of this war, the last male survivor having died in 1905, at the age of 105 years. Service pensions were provided for those who served in the Black Hawk war, Creek war, Cherokee disturbances and the Seminole war (1832 to 1842), on the 27th of July 1892, fifty years after the period embraced in the act; they were granted to those who had served for thirty days and were honourably discharged, and to their widows. In 1908 there were 1820 survivors and 3018 widows, pensioners of the Indian wars. Service pensions were granted to the survivors of the war with Mexico by an act passed on the 29th of January 1887, thirty-nine years after the Guadeloupe-Hidalgo treaty. The pensions were granted to those who were honourably discharged and to the widows, for service of sixty days, if sixty-two years of age, or disabled or dependent. This law was liberalized by the acts of the 5th of January 1893, 23rd of April 1900, 6th of February 1907, and 19th of April 1908, increasing the pension to \$15 for those who have reached the age of seventy years, and to \$30 for those seventy-five years and over. In 1908 the pension rolls contained the names of 2932 survivors and 6914 widows on account of service in the Mexican war. To give title to bounty land, service must have been for at least fourteen days or in a battle prior to 3rd March 1855; and if in the navy or regular army, must have been in some war in which the United States was engaged. Bounty land warrants are issued for 160 acres, and over 50,000,000 acres have been granted under the different Bounty Land Acts.

For services rendered in the Civil War (1861-65) in the army or navy of the United States, or in their various branches, the law provided two distinct systems of pensioning—(1) the general laws, granting pensions for wounds or injuries received, or disease contracted in service in the line of duty, the pensions ranging from \$6 to \$100 per month; and (2) the so-called Dependent Pension Act and amending acts, granting pensions for permanent disabilities, regardless of the time and manner of their origin, provided they were not the result of vicious habits, the pensions ranging from \$6 to \$12 per month. What is known as the general law for disabilities incurred in service and in the course of duty was constituted in the act of the 14th of July 1862, as amended by the act of the 3rd of March 1873. Under its provisions the following classes of persons are entitled to benefit, viz. any officer of the army, navy or marine corps, or any enlisted man in the military or naval service of the United States, whether regularly mustered or not; any master or any pilot, engineer, sailor or other person not regularly mustered; serving upon any gunboat or war-vessel of the United States; any acting assistant or contract surgeon; any provost-marshal, deputy provost-marshal or enrolling officer; subject to the several conditions in each particular case prescribed in the law. This law also embraces in its provisions the following classes, each class being subject to certain specified conditions, viz. widows, children under sixteen years of age, dependent parents, and brothers and sisters. This act has been the subject of numerous amendments along more liberal lines. As an illustration a case may be cited where a soldier lost both hands in the service in the course of duty, and was discharged in 1862. He is entitled to a pension of \$8 per month from the date of his discharge. Under subsequent acts he is entitled to \$25 per month from 4th July 1864; \$31.25 from 4th June 1872; \$35 from 4th June 1874; \$72 from 17th June 1878, and \$100 from 12th February 1899.

Under the general law a widow or dependent relative could not be pensioned unless the cause of the soldier's death originated in service in the line of duty; if it were so shown, a widow might be pensioned whether she were rich or poor. Upon the death or remarriage of the widow the minor children of the soldier under the age of sixteen years become entitled to pension. If the soldier died of causes due to his service, and left no widow or minor children, his other relatives become entitled, if dependent, in the following order, viz: first, the mother; secondly, the father; thirdly, orphan sisters and brothers under sixteen years of age, who shall be pensioned jointly. In 1908 the number of invalids pensioned under the general law was 142,044, and the number of widows and dependent relatives was 81,168.

The so-called Dependent Pension Act was based upon an Act of Congress approved 27th June 1890, which was amended on 19th May 1900. Properly speaking, it might be called "dependents" only as regards widows and parents. The main conditions as to the soldier or sailor were, ninety days' service, an honourable discharge, and a permanent disability from disease or otherwise, not the result of his own vicious habits, to such an extent as to render him unable to maintain himself by manual labour. The rates of pension under this act were \$6, \$8, \$10 and \$12 per month. Widows became entitled under this law if they married the soldier or sailor prior to 27th June 1890, provided they were without means of support other than their daily labour, and an actual net income not exceeding \$250 per year, and had not remarried. Claims of children under sixteen years of age were governed by the same conditions as applied to claims of widows, except that their dependence was presumed, and need not be shown by evidence. If a minor child was insane, idiotic or otherwise physically or mentally helpless, the pension continued during the life of said child or during the period of disability. Further acts made more liberal provisions. That of the 6th of February 1907, granted pensions

to persons who had served ninety days or more in the military or naval service in the civil war, or sixty days in the Mexican war, and were honourably discharged, no other conditions being attached. The rate of pension was fixed at \$12 per month when sixty-two years of age, \$15 per month when seventy years of age and \$20 per month when seventy-five years of age. The act of April 1908, fixed the rate of pension for widows, minor children under the age of sixteen and helpless minors on the roll or afterwards to be placed on it at \$12 per month, and granted pensions at the same rate to the widows of persons who served ninety days or more during the civil war, without regard to their pecuniary condition. In 1908 there were 140,600 invalids on the roll, and 4294 minor and helpless children. In the same year under the act of 1907 there were 338,341 dependants, while under the act of 1908, 188,445 widows were put on the roll. All women employed by competent authority as nurses during the Civil War for six months or more, who are unable to earn a support, are granted a pension of \$12 per month by an act of the 5th of August 1892. In 1908 the pension rolls contained the names of 3110 pensioners under this act.

There were on the roll in 1908 on account of the Spanish war, 11,796 invalids and 3722 dependants. The total amount paid in pensions in 1908 on account of that war and the insurrection in the Philippine Islands was \$3,654,122. The grand total of pensioners on the roll for all wars was, in 1908, 951,687.

In addition to pensions, the United States government grants the following gratuities: *First:* If a soldier lost a limb in the service, or as a result of his service in line of duty, he is furnished with an artificial limb free of cost every three years, or commutation therefor, and transportation to and from a place where he shall select the artificial limb. *Second:* An honourably discharged soldier or sailor is given preference for appointment to places of trust and profit, and preference for retention in all civil service positions. *Third:* There are ten National Soldiers' Homes situated at convenient and healthy points in different parts of the country, where comfortable quarters, clothing, medical attendance, library and amusements of different kinds are provided free of all expense; government providing the soldiers free transportation to the home, continuing payments of pension while they are members of the home, and increasing the same as disabilities increase. *Fourth:* There are thirty homes maintained by the different states, which are similar in their purpose to the National Homes, the sum of \$100 per year being paid by the general government for each inmate. Many of these state homes also provide for the wives and children of the inmates, so that they need not be separated while they are members of such home. *Fifth:* Schools are established by the different states for the maintenance and education of soldiers' orphans until they attain the age of sixteen years.

From the close of the Civil War in 1865 to 1908, the government of the United States paid to its pensioners for that war the sum of \$3,533,593,025. The payments on account of all wars for the fiscal year ended on the 30th of June 1908 were \$153,093,086. Over \$17,000,000 has been paid to surgeons for making medical examinations of pensioners and applicants for pensions. The total disbursement for pensions from 1790 to 1908 amounted to \$3,751,108,809. No other nation or government in all time has dealt so liberally with its defenders.

The money appropriated by Congress for the payment of pensions is disbursed by eighteen pension agents established in different parts of the country. Pensions are paid quarterly, and the agencies are divided into three classes, one of which pays on the 4th of every month.

PENSIONARY, a name given to the leading functionary and legal adviser of the principal town corporations of Holland, because they received a salary, or pension. At first this official was known by the name of "clerk" or "advocate." The office originated in Flanders. The earliest "pensionaries" in Holland were those of Dort (1468) and of Haarlem (1478). The pensionary conducted the legal business of the town, and was the secretary of the town council and its representative and spokesman at the meetings of the Provincial States. The post of pensionary was permanent and his influence was great.

In the States of the province of Holland pensionary of the order of nobles (*Ridderschap*) was the foremost official of that assembly and he was named—until the death of Oldenbarnevelt in 1619—the land's advocate, or more shortly, the advocate. The importance of the advocate was much increased after the outbreak of the revolt in 1572, and still more so during the long period 1586-1619 when John van Oldenbarnevelt held the office. The advocate drew up and introduced all resolutions, concluded debates and counted the votes in the Provincial Assembly. When it was not in session he was a permanent member of the college of deputed councillors who carried on the administration. He was minister of justice and of finance.

All correspondence passed through his hands, and he was the head and the spokesman of the deputation, who represented the province in the States General. The conduct of foreign affairs in particular was entrusted almost entirely to him.

After the downfall of Oldenbarnevelt the office of lands-advocate was abolished, and a new post, tenable for five years only, was erected in its place with the title of *Raad-Præsionaris*, or Pensionary of the Council, usually called by English writers Grand Pensionary. The first holder of this office was Anthony Duyck. Jacob Cats and Adrian Pauw, in the days of the stadtholders Frederick Henry and William of Orange II. had to be content with lessened powers, but in the stadtholderless régime 1650-1672 the grand pensionary became even more influential than Oldenbarnevelt himself, since there was no prince of Orange filling the offices of stadtholder, and of admiral and captain-general of the Union. From 1653-1672 John de Witt, re-elected twice, made the name of grand pensionary of Holland for ever famous during the time of the wars with England. The best known of his successors was Anthony Heinsius, who held the office from 1688 to his death in 1720. He was the intimate friend of William III., and after the decease of the king continued to carry out his policy during the stadtholderless period that followed. The office was abolished after the conquest of Holland by the French in 1795.

See Robert Fruin, *Geschiedenis der Staats-Instellingen in Nederland*, The Hague, 1901, G. W. Vreede, *Inleiding tot een Gesch. der Nederlandsche Diplomatie* (Utrecht, 1858). (C. E.)

PENTAMETER, the name given to the second and shorter line of the classical elegiac verse. It is composed of five (*πέντε*) feet or measures (*μέτρα*), and is divided into two equal parts of two and a half feet each: the second of these parts must be dactylic, and the first may be either dactylic or spondaic. The first part must never overlap into the second, but there must be a break between them. Thus:

— — — | — — — | — — — | — — — | — — — |

In the best Latin poets, the first foot of each part of the pentameter is a dactyl. The pentameter scarcely exists except in conjunction with the hexameter, to which it always succeeds in elegiac verse. The invention of the rigidly dactylic form was attributed by the Greeks to Archilochus. Schiller described the sound and method of the elegiac couplet in two very skilful verses, which have been copied in many languages:

Im Hexameter steigt des Springquells süßes Säule,
Im Pentameter drauf fällt sie melodisch herab.

The pentameter was always considered to add a melancholy air to verse, and it was especially beloved by the Greeks in those recitations (*παρῳδείαι*) to the sound of the flute, which formed the earliest melodic performances at Delphi and elsewhere.

PENTASTOMIDA, or LINGUATULINA, vermiform entoparasitic animals, of which the exact zoological position is unknown, although they are usually regarded as highly modified degenerate Arachnida of the order Acari.

The body is sub-cylindrical or somewhat convex above, flatter below, broad and oval in front and narrowed and elongate behind. Its integument is marked by a large number of transverse grooves simulating the segmentation of Annelida, and near the anterior extremity close to the mouth are two pairs of recurved chitinous hooks. The alimentary canal is a simple tube traversing the body from end to end, the anus opening at the extremity of its narrowed tail-like termination. The nervous system is represented by an oesophageal collar and a suboesophageal ganglion, whence paired nerves pass outwards to innervate the anterior extremity and backwards towards its posterior end. No respiratory or circulatory organs are known. The sexes are distinct but dissimilar in size, the female being usually much larger than the male. The generative organs occupy a large part of the body cavity. In the female the ovary is a large unpaired organ from the anterior end of which arise two oviducts, and connected with the latter are a pair of large so-called copulatory pouches, which perhaps act as receptacula seminis. These and the oviducts lie on the anterior half of the body; but the oviducts themselves soon unite to form a single tube of great length, which runs backwards to its posterior extremity, terminating in the genital orifice close to the anus.

In the male, on the contrary, this orifice is situated in the anterior half of the body, not far behind the mouth. The orifice leads into a large pouch lodging a pair of very long penes, which are coiled up when not in use. The two testicles, which extend far back into the posterior part of the body, are long and tubular. Anteriorly their vasa deferentia soon unite into a common duct, which opens into the pouch containing the penes. Also communicating with this pouch is a pair of long slender flagelliform tubes, of which the function is unknown.

The structure of the adult *Linguatula* or *Pentastomon*, above described, does not supply convincing evidence of relationship with the Acari. At the same time some Acari, like *Eriophys* (*Phylloptus*) and *Demodex*, have the body elongated and annulated, but in these groups the elongation of the body is caudal or post-anal, as is attested by the position of the anus far forwards on its ventral surface. Again, the adult *Pentastomon* shows no trace of appendages, unless the two pairs of chitinous hooks are to be regarded as the vestiges of jaws or ambulatory limbs. In the embryo, however, what have been regarded as remnants of limbs may be seen.

In the mature stage Pentastomida live in the respiratory passages of mammalia, principally in the nasal cavities. The remarkable life-history of one species, *Linguatula taeniolides*, has been worked out in detail and presents a close analogy to that of some Cestodes. The adults live in the nose of dogs, where they have been known to survive over fifteen months. Each female lays a vast number of eggs, about 500,000 being the estimated amount. These are expelled along with mucus by the sneezing of the host. If they fall on pasture land or fodder of any kind and are eaten by any herbivorous animal, such as a hare, rabbit, horse, sheep or ox, the active embryos or larvae are set free in the alimentary canal of the new host.

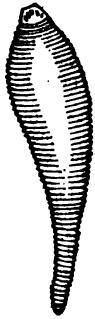

FIG. 1.—*Linguatula taeniolides*, Rud. adult.



FIG. 2.—The same, in the first larval stage; under side. a . . . a, Leg-like processes.

These larvae are minute oval creatures with a comparatively short apically fringed caudal prolongation and furnished with two pairs of short two-clawed processes, which may represent the limbs of arthropods and possibly the two pairs of legs found in Acari of the family Eriophyidae. The larva is also armed anteriorly with a median piercing probe and a pair of sharp hooks by means of which it perforates the walls of the alimentary tract and makes its way into the body cavity, lungs or liver. Here it becomes encysted, and losing its boring apparatus and claw-bearing processes remains for a time quiescent. After a series of moults it passes into the second larval stage, somewhat like the parent but differing in having each integumental ring armed with a fringe of backwardly directed short bristles. This sexually immature stage, regarded at one time as representing a distinct species and named *Linguatula denticulata*, is reached in about six or seven months and measures from 6 to 8 mm. in length. In the event of the host escaping being killed and eaten it is believed that some of these larvae wander about or ultimately make their way to the exterior, possibly through the bronchi; nevertheless it seems to be certain that they can only reach sexual maturity in the nasal passages of some carnivorous animal, and the chance of attaining this environment is afforded when the viscera of the host are devoured by some flesh-eating mammal.

The adult female of *L. taeniolides* measures about 4 in. long and the male barely one-fourth of that. The adult and immature stages are, however, by no means confined respectively to carnivorous and herbivorous species of mammals. The adult stage, for example, has been found in the nasal passages of sheep, goats,

horses and even of man, and the larval stage in the pleural and peritoneal cavities of dogs and cats. (R. L. P.).

PENTATEUCH, the name found as early as in Tertullian and Origen corresponding to the Jewish *חמשה חומשי תורה* (the five-fifths of the Torah, or Law), and applied to the first five books of the Old Testament (Genesis, Exodus, Leviticus, Numbers, Deuteronomy). The several books were named by the Jews from their initial words, though at least Leviticus, Numbers, and Deuteronomy had also titles resembling those we use, viz. *חוקת מוסר, עשרת הדיברות* (*Διμορφωμένοι*, Origen, in *Esa.*, H. E. vi. 25), and *חוקת מוסר*. The Pentateuch, together with Joshua, Judges and Ruth, with which it is usually united in Greek MSS., makes up the Octateuch; the Pentateuch and Joshua together have recently been named the Hexateuch. On the critical questions arising from the Pentateuch or Hexateuch, see BIRX and the articles on the several books.

PENTECOST, a feast of the Jews, in its original meaning a "harvest feast," as consisting of the first-fruits of human toil (*Exod.* xxiii. 16), extending over the seven weeks which fairly correspond with the duration of the Canaanite harvest. Hence it was the closing feast of the harvest gladness.

The agricultural character of this feast clearly reveals its Canaanite origin (see HEBREW RELIGION). It does not, however, rank equal in importance with the other two agricultural festivals of pre-exilian Israel, viz. the *Massah* or feast of unleavened cakes (which marked the beginning of the corn-harvest), and the *Asph* ("ingathering," later called *suabim*, "booths") which marked the close of all the year's ingathering of vegetable products. This is clear in the ideal scheme of Ezekiel (xlv. 21 seq.) in which according to the original text, Pentecost is omitted (see Cornall's revised text and his note *ad loc.*). It is a later hand that has ascribed a reference to the "feast of weeks" which is found in our Masoretic Hebrew text: Nevertheless occasional allusions to this feast, though secondary, are to be found in Hebrew literature, e.g. *Isa.* ix. 3 (2 Heb.) and *Ps.* lv. 7 (8 Heb.).

In both the early codes, viz. in *Exod.* xxiii. 16 (E) and in *Exod.* xxxiv. 22 (J, in which the harvest festival is called "feast of weeks") we have only a bare statement that the harvest festival took place some weeks after the opening spring festival called *Massah*. It is in *Deut.* xvi. 9 that we find it explicitly stated that *seven* weeks elapsed between the beginning of the corn-harvest ("when thou puttest the sickle to the corn") and the celebration of the harvest festival (*קציר*). We also note the same generous inclusion of the household slaves and of the resident alien as well as the fatherless and widow that characterizes the autumnal festival of "Booths."

But when we pass to the post-exilian legislation (*Lev.* xxiii. 10-21; cf. *Num.* xxviii. 26 seq.) we enter upon a far more detailed and specific series of ritual instructions. (1) A special ceremonial is described as taking place on "the morrow after the Sabbath," i.e. in the week of unleavened cakes. The first-fruits of the harvest here take the form of a sheaf which is waved by the priest before Yahweh. (2) There is the offering of a male lamb of the first year without blemish and also a meal offering of fine flour and oil mixed in defined proportions as well as a drink-offering of wine of a certain measure. After this "morrow after the Sabbath" seven weeks are to be reckoned, and when we reach the morrow after the seventh Sabbath fifty days have been enumerated. Here we must bear in mind that Hebrew numeration always includes the day which is the *terminus a quo* as well as that which is *term. ad quem*. On this fiftieth day two wave-loaves made from the produce of the fields occupied by the worshipper ("your habitations") are offered together with seven unblemished lambs of the first year as well as one young bullock and two rams as a burnt offering. We have further precise details respecting the sin-offering and the peace-offerings which were also presented.¹ This elaborate ceremonial connected with the wave-offering (developed in the post-exile period) took place on the morrow of the seventh Sabbath called

¹ On the critical questions involved in these ritual details of *Lev.* xxiii. 18 as compared with *Num.* xxviii. 27-30 cf. Driver and White in *S. B. O. T.*, note on *Lev.* xxiii. 18.

a "day of holy convocation" on which no servile work was to be done. It was called a "fiftieth-day feast." Pentecost or "Fiftieth" day is only a Greek equivalent of the last name (*πεντηκοστή*) in the Apocrypha and New Testament. The orthodox later Jews reckoned the fifty days from the 16th of Nisan, but on this there has been considerable controversy among Jews themselves. The orthodox later Jews assumed that the Sabbath in Lev. xxiii. 11, 15 is the 15th Nisan, or the first day of the feast of *Matsoth*. Hitzig maintained that in the Hebrew calendar 14th and 21st Nisan were always Sabbaths, and that 1st Nisan was always a Sunday, which was the opening day of the year. "The morrow after the Sabbath" means, according to Hitzig, the day after the weekly Sabbath, viz. 22nd Nisan. Knobel (*Comment. on Leviticus*) and Kurtz agree with Hitzig's premises but differ from his identification of the Sabbath. They identify it with the 14th Nisan. Accordingly the "day after" falls on the 15th. (See Purves's article, "Pentecost," in Hastings's *Dict. of the Bible*, and also Ginsburg's article in Kitto's *Cyclopaedia*.) Like the other great feasts, it came to be celebrated by fixed special sacrifices. The amount of these is differently expressed in the earlier and later priestly law (Lev. xxiii. 18 seq.; Num. xxviii. 26 seq.); the discrepancy was met by adding the two lists. The later Jews also extended the one day of the feast to two. Further, in accordance with the tendency to substitute historical for economic explanations of the great feasts, Pentecost came to be regarded as the feast commemorative of the Sinaitic legislation.

To the Christian Church Pentecost acquired a new significance through the outpouring of the Spirit (Acts ii.). (See WIR-SUNDAY.)

It is not easy to find definite parallels to this festival in other ancient religious cults. The Akitu festival to Marduk was a spring festival at the beginning of the Babylonian year (Nisan). It therefore comes near in time to the feast of unleavened cakes rather than to the later harvest festival in the month Sivan called "feast of weeks." Zimmern indeed connects the Akitu festival with that of Purim on the 15th Adar (March); see *K.A.T.* p. 514 seq. Also the Roman Cerealia of April 12th-19th rather correspond to *Ματσοθή* than to *Κάστ.* (O. C. W.)

PENTELICUS (*Πεντηλικός*, or *Πεντηλικόν ὄρος* from the dem. *Πεντή*; mod. Mendeli), a mountain to the N.E. of the Athenian plain, height 3640 ft. Its quarries of white marble were not regularly worked until after the Persian wars; of this material all the chief buildings of Athens were constructed, as well as the sculpture with which they were ornamented. The ancient quarries are mostly on the south side of the mountain. The best modern quarries are on the north side. The top of Pentelicus commands a view over the plain of Marathon, and from it the Athenian traitors gave the signal to the Persians by a flashing shield on the day of the battle. There was a statue of Athena on the mountain.

PENTHEUS, in Greek legend, successor of Cadmus as king of Thebes. When Dionysus, with his band of frenzied women (*Maenads*) arrived at Thebes (his native place and the first city visited by him in Greece), Pentheus denied his divinity and violently opposed the introduction of his rites. His mother Agavé having joined the revellers on Mount Cithaeron, Pentheus followed and climbed a lofty pine to watch the proceedings. Being discovered he was torn to pieces by Agave and others, who mistook him for some wild beast. His head was carried back to Thebes in triumph by his mother. Labdacus and Lycurgus, who offered a similar resistance, met with a like fearful end. Some identify Pentheus with Dionysus himself in his character as the god of the vine, torn to pieces by the violence of winter. The fate of Pentheus was the subject of lost tragedies by Thespis and Pacuvius.

See Euripides, *Bacchae*, *passim*; Ovid, *Metam.* iii. 511; Theocritus xvi; Apollodorus iii. 5, 3; Nonnus, *Dionysiaca*, xlv-xlvi; on representations in art see O. Jahn, *Pentheus und die Maimaden* (1841).

PENTHIÈVRE, COUNTS OF. In the 11th and 12th centuries the countship of Penthièvre in Brittany (dep. of Côtes-du-Nord)

belonged to a branch of the sovereign house of Brittany. Henry d'Avagour, heir of this dynasty, was dispossessed of the countship in 1235 by the duke of Brittany, Pierre Mauclerc, who gave it as dowry to his daughter, Yolande, on her marriage in 1238 to Hugh of Lusignan, count of La Marche. Duke John I. of Brittany, Yolande's brother, seized the countship on her death in 1272. In 1337 Joan of Brittany brought Penthièvre to her husband, Charles de Châtillon-Blois. In 1437 Nicole de Blois, a descendant of this family, married Jean de Brosee, and was deprived of Penthièvre by the duke of Brittany, Francis II., in 1465. The countship, which was restored to Sebastian of Luxemburg, heir of the Broesses through his mother, was erected for him into a duchy in the peerage of France (*duché-pairie*) in 1569, and was afterwards held by the duchess of Mercœur, daughter of the first duke of Penthièvre, and then by her daughter, the duchess of Vendôme. The duchess of Vendôme's grandson, Louis Joseph, inherited Penthièvre in 1669, but it was taken from him by decree in 1687 and adjudged to Anne Marie de Bourbon, princess of Conti. In 1696 it was sold to the count of Toulouse, whose son bore the title of duke of Penthièvre. This title passed by inheritance to the house of Orleans.

PENTHOUSE, a sloping roof attached to a building either to serve as a porch or a covering for an arcade, or, if supported by walls, as a shed, a "lean-to." In the history of siegecraft, the word is particularly applied to the fixed or movable constructions used to protect the besiegers when mining, working battering-rams, catapults, &c., and is thus used to translate Lat. *vinea* and *pluteus*, and also *testudo*, the shelter of locked shields of the Romans. The Mid. Eng. form of the word is *penis*, an adaptation of O. Fr. *apentis*, Med. Lat. *appenditium* or *appendicium*, a small structure attached to, or dependent on, another building, from *appendere*, to hang on to. The form "pent-house" is due to a supposed connexion with "house" and Fr. *penle*, sloping roof. The more correct form "pentice" is now frequently used.

PENTSTEMON, in botany, a genus of plants (nat. order Scrophulariaceae), chiefly natives of North America, with showy open-tubular flowers. The pentstemon of the florist has, however, sprung from *P. Hartwegii* and *P. Cobaea*, and possibly some others. The plants endure English winters unharmed in favoured situations. They are freely multiplied by cuttings, selected from the young side shoots, planted early in September, and kept in a close cold frame till rooted. They winter safely in cold frames, protected by mats or litter during frost. They produce seed freely, new kinds being obtained by that means. When special varieties are not required true from cuttings, the simplest way to raise pentstemons is to sow seed in heat (65° F.) early in February, afterwards pricking the seedlings out and hardening them off, so as to be ready for the open air by the end of May. Plants formerly known under the name of *Chelone* (e.g. *C. barbata*, *C. campanulata*) are now classed with the pentstemons.

PENUMBRA (Lat. *paene*, almost, *umbra*, a shadow), in astronomy, the partial shadow of a heavenly body as cast by the sun. It is defined by the region in which the light of the sun is partially but not wholly cut off through the interception of a dark body. (See ECLIPSE.)

PENZA, a government of eastern Russia, bounded N. by the government of Nizhny-Novgorod, E. by Simbirsk, and S. and W. by Saratov and Tambov; area 14,992 sq. m.; pop. (est. 1906) 1,699,000. The surface is undulating, with deep valleys and ravines, but does not exceed 900 ft. above sea-level. It is principally made up of Cretaceous sandstones, sands, marls and chalk, covered in the east by Eocene deposits. Chalk, potter's clay, peat and iron are the chief mineral products in the north. The soil is a black earth, more or less mixed with clay and sand; marshes occur in the Krasnoslobodsk district; and expanses of sand in the river valleys. There are extensive forests in the north, but the south exhibits the characteristic features of a steppeland. The government is drained by the Moksha, the Sura (both navigable), and the Khopor, belonging to the Oka, Volga and Don systems. Timber is floated down

several smaller streams, while the Moksha and Sura are important means of conveyance. The climate is harsh, the average temperature at the city of Penza being only 38°. The population consists principally of Russians, together with Mordvinians, Meshcheryaks and Tatars. The Russians profess the Orthodox Greek faith, and very many, especially in the north, are Raskolniks or Nonconformists. The chief occupation is agriculture. The principal crops are rye, oats, buckwheat, hemp, potatoes and beetroot. Grain and flour are considerable exports. The local authorities have established depôts for the sale of modern agricultural machinery. There are several agricultural and horticultural schools, and two model dairy-farms. Cattle breeding and especially horse-breeding are comparatively flourishing. Market-gardening is successfully carried on, and improved varieties of fruit-trees have been introduced through the imperial botanical garden at Penza and a private school of gardening in the Gorodishche district. Sheep-breeding is especially developed in Chembar and Insar. The Mordvinians devote much attention to bee-keeping. The forests (22% of the total area) are a considerable source of wealth, especially in Krasnoslobodsk and Gorodishche. The manufactures are few. Distilleries come first, followed by beet sugar and oil mills, with woollen cloth and paper mills, tanneries, soap, glass, machinery and iron-works. Trade is limited to the export of corn, spirits, timber, hempsed-oil, tallow, hides, honey, wax, woollen cloth, potash and cattle, the chief centres for trade being Penza, Nizhni-Lomov, Mokshany, Saranak and Krasnoslobodsk.

The government is divided into ten districts, the chief towns of which are Penza, Gorodishche, Insar, Kerenak, Krasnoslobodsk, Mokshany, Narovchat, Nizhni-Lomov, Saransk and Chembar. The present government of Penza was formerly inhabited by Mordvinians, who had the Meshcheryaks on the W. and the Bulgars on the N. In the 13th century these populations fell under the dominion of the Tatars, with whom they fought against Moscow. The Russians founded the town of Mokshany in 1535. Penza was founded in the beginning of the 17th century, the permanent Russian settlement dating as far back as 1666. In 1776 it was taken by the rebel Pugachev. The town was almost totally destroyed by conflagrations in 1836, 1839 and 1858.

PENZA, a town of Russia, capital of the government of the same name, 402 m. by rail S.E. from Moscow. It stands on a plateau 567 ft. above the sea, at the confluence of the Penza with the navigable Sura. Pop. (1897), 61,851. The older parts of the town are constructed of wood, but the newer parts are well built. The cathedral was erected in 1820-1821. Penza has technical schools, public libraries, a museum of antiquities, and a theatre which has played some part in the history of the Russian stage. The bulk of the inhabitants support themselves by agriculture or fishing in the Sura. An imperial botanical garden is situated within two miles of the town. Apart from paper-mills and steam flour-mills, the manufacturing establishments are small. There is a trade in corn, oil, tallow, timber and spirits, and two fairs where cattle and horses are sold.

PENZANCE, a municipal borough, market town and seaport in the St Ives parliamentary division of Cornwall, England, the terminus of the Great Western railway, 32½ m. W.S.W. of London. Pop. (1901), 13,136. It is finely situated on the western shore of Mount's Bay, opposite St Michael's Mount, being the westernmost port in England. The site of the old town slopes sharply upward from the harbour, to the west of which there extends an esplanade and modern residential quarter; for Penzance, with its mild climate, is in considerable favour as a health resort. The town has no buildings of great antiquity, but the public buildings (1867), in Italian style, are handsome. By the market house is a statue of Sir Humphry Davy, who was born here in 1778. Among institutions there are a specially fine public library, museums of geology and natural history and antiquities, mining and science schools, the West Cornwall Infirmary and a meteorological station. The harbour, enclosed within a breakwater, has an area of 24 acres, with 12 to 16 ft. depth of water, and floating and graving docks. There is a

large export trade in fish, including that of pilchards to Italy. Other exports are tin and copper, granite, serpentine, vegetables and china clay. Imports are principally coal, iron and timber. Great quantities of early potatoes and vegetables, together with flowers and fish, are sent to London and elsewhere. The borough is under a mayor, 6 aldermen and 18 councillors. Area, 355 acres.

Nearly two miles inland to the north-west is MADRON (an urban district with a population of 3486). The church of St Maddern is principally Perpendicular, with earlier portions and a Norman front. Near the village a "wishing well" of ancient fame is seen, and close to it the ruins of a baptistery of extreme antiquity. Monoliths and cromlechs are not uncommon in the neighbourhood. Three miles north-east is the urban district of LUDGVAN (pop. 2274), and to the south is PAUL (6332), which includes the village of Newlyn (g.v.).

Penzance (Pensans) was not recognized as a port until the days of the Tudors, but its importance as a fishing village dates from the 14th century. In 1327 thirty burgesses in Penzance and thirteen boats paying 13s. yearly are found among the possessions of the lords of Alverton, of which manor it formed a portion of the demesne lands. The year 1512 marks the beginning of a new era. Until then St Michael's Mount had been regarded as the port of Mounts Bay; but in that year Henry VIII. granted the tenants of Penzance whatever profits might accrue from the "ankerage, kylage and busselage" of ships resorting thither, so long as they should repair and maintain the quay and bulwarks for the safeguard of the ships and town. Nevertheless thirty years later it is described by Leland as the westernmost market town in Cornwall "with no secur for Botes or shippes but a forced Pere or Key." During the war with Spain the town was devastated in 1595. The charter of incorporation granted in 1614 states that by the invasion of the Spaniards it had been treacherously spoiled and burnt but that its strength, prosperity and usefulness for navigation, and the acceptable and laudable services of the inhabitants in rebuilding and fortifying it, and their enterprise in erecting a pier, have moved the king to grant the petition for its incorporation. This charter provides for a mayor, eight aldermen and twelve assistants to constitute the common council, the mayor to be chosen by the council from the aldermen, the aldermen to be chosen from the assistants, and the assistants from the most sufficient and discreet of the inhabitants. It also ratified Henry's grant of anchorage, keelage and busselage. In 1663 Penzance was constituted a coinage town for tin. It has never enjoyed independent parliamentary representation. In 1332 a market on Wednesdays and a fair at the Feast of St Peter ad Vincula were granted to Alice de Lisle and in 1405 this market was ratified and three additional fairs added, viz. at the feasts of St Peter in Cathedra and the Conception and Nativity of the Blessed Virgin. The charter of 1614 substituted markets on Tuesdays and Thursdays for the Wednesday market and added two fairs one at Corpus Christi and the other on the Thursday before St Andrew. Of the fairs only Corpus Christi remains; markets are now held on Tuesday, Thursday and Saturday. Apart from fishing and shipping, Penzance has never been an industrial centre.

PEONAGE (Span. *peon*; M. Lat. *pedo* (*pes*), primarily a foot-soldier, then a day-labourer), a system of agricultural servitude common in Spanish America, particularly in Mexico. In the early days the Spanish government, with the idea of protecting the Indians, exempted them from compulsory military service, the payment of tithes and other taxes, and regulated the system of labour; but left them practically at the mercy of the Spanish governors. The peons, as the Indian labourers were called, were of two kinds: (1) the agricultural workman who was free to contract himself, and (2) the criminal labourers who, often for slight offences, or more usually for debt, were condemned to practical slavery. Though legally peonage is abolished, the unfortunate peon is often lured into debt by his employer and then kept a slave, the law permitting his forcible detention till he has paid his debt to his master.

PEOPLE, a collective term for persons in general, especially as forming the body of persons in a community or nation, the "folk" (the O.E. and Teut. word, cf. Ger. *Volk*). The earlier forms of the word were *peple*, *poepie*, *pauple*, &c.; the present form is found as early as the 15th century, but was not established till the beginning of the 16th. Old French, from which it was adapted, had many of these forms as well as the mod. Fr. *peuple*. The Lat. *populus* is generally taken to be a reduplication from the root *ple*,—fill, seen in *plenus*, full; *plebs*, the commons; Gr. *πληθος*, multitude.

PEORIA, a city, port of entry, and the county-seat of Peoria county, Illinois, U.S.A., in the north central part of the state, on the lower end of Lake Peoria, an expansion of the Illinois river, and about 150 m. S.W. of Chicago. Pop. (1900) 56,100; (1910) 66,950. It is served by 13 railroads, of which the most important are the Chicago, Burlington & Quincy, the Chicago, Rock Island & Pacific, the Chicago & Alton, the Illinois Central, the Cleveland, Cincinnati, Chicago & St. Louis, and the Chicago & North-Western. The Illinois river is navigable to its mouth, and at La Salle, above Peoria, connects with the Illinois & Michigan Canal extending to Chicago. The river is spanned at Peoria by two railway bridges and a wagon bridge. The residential portion of the city is situated on bluffs overlooking Lake Peoria, and the business streets lie on the plain between these elevations and the water front. The park system includes more than 400 acres; Bradley Park (140 acres), the largest, was given to the city by Mrs Lydia Moss Bradley (1816-1908) and was named in her honour. On a bluff north-east of the city is Glen Oak Park (103 acres), modelled after Forest Park, St. Louis, Missouri; in the south-western part of the city is Madison Park (83 acres); and in the lower part of the city is South Park (10 acres). In the Court House Square there are two monuments in honour of the Federal soldiers and sailors of Peoria county who perished in the Civil War; in Springdale Cemetery there are two similar memorials, one of which (a large granite boulder) is in memory of the unknown dead; and in the same cemetery there is a monument erected by the state (1906) to mark the grave of Thomas Ford (d. 1851), governor of Illinois in 1842-1846. Among the principal public buildings and institutions are the Peoria Public Library founded in 1855, the City Hall, the Court House, the Federal building, St Mary's Cathedral, the Bradley Polytechnic Institute (affiliated with the university of Chicago), founded in 1896 by Mrs Lydia Moss Bradley, who gave it an endowment of \$2,000,000; Spalding Institute, founded through the efforts of John L. Spalding (b. 1840), who was Bishop of the Roman Catholic diocese of Peoria in 1877-1908; an Evangelical Lutheran Orphans' Home (1902), an Industrial School for girls (1892), Cottage Hospital (1876), St Francis Hospital (1875), a Florence Crittenton Home (1902), a Home for the Friendless (1876), and a House of the Good Shepherd (1891), and the Guyer Memorial (1889), St Joseph's (1892), and John C. Proctor homes for the aged and infirm (1907). At Bartonville, a suburb, there is a state hospital for the incurable insane.

In 1900 and in 1905 Peoria ranked second among the cities of Illinois in the value of its manufactures. The invested capital amounted in 1905 to \$22,243,821, and the factory products were valued at \$60,920,411. The principal industry is the manufacture of distilled liquors, which were valued in 1905 at \$42,170,815. Other important manufactures are agricultural implements (\$2,309,962), slaughter-house and meat-packing products (\$1,480,398), glucose, cooperage (\$1,287,742), malt liquors (\$887,570), foundry and machine-shop products, strawboard, automobiles, brick and stone, and flour and grist mill products. Peoria is also an important shipping point for grain and coal.

Peoria was named from one of the five tribes of the Illinois Indians. In 1680 La Salle, the explorer, built Fort Crèvecoeur, on the lake shore bluffs, opposite the present city; this fort, however, was destroyed and deserted in the same year by La Salle's followers after he had set out to return to Fort Frontenac. There is evidence that a French mission was established on or near the site of Peoria as early as 1711; and certainly by 1725 a settlement, known as Peoria, and composed of French and

"breed" traders, trappers and farmers, had been established about 1½ m. above the foot of the lake, on its west shore. This village was practically deserted during the later years (1781-1783) of the War of Independence, and when its inhabitants returned after the peace they settled in a village which had been established about 1778, on the present site of Peoria, by Jean Baptiste Maillet (d. 1801), and was at first called La Ville de Maillet. It is probable that Jean Baptiste Point de Saible, believed to have been a Santo Domingan negro, and jocularly spoken of "as the first white settler in Chicago," lived in the "old village" of Peoria as early as 1773—or six years before he settled on the present site of Chicago—and again about 1783. In November 1812 about half of the town was burned by a company of Illinois militia who had been sent thither to build a fort, and whose captain asserted that his boats had been fired upon at night by the villagers. In the following year a fort, named Fort Clark in honour of George Rogers Clark, was erected on the site of the old village; it was evacuated in 1818, and soon afterwards was burned by the Indians. After the town was burned there was no serious attempt to rebuild until 1819. Peoria was incorporated as a town in 1835 and was chartered as a city in 1845. In 1900 North Peoria was annexed.

See David McCulloch, *Early Days of Peoria and Chicago*, an address read before the Chicago Historical Society in 1904, and published by that society, (n.d.), and "Old Peoria," by the same author, in publication No. 6 of the Illinois State Historical Society *Transactions* (Springfield, Ill. 1901); also *Historical Encyclopedia of Illinois* (Chicago, 1900), ed. by Newton Bateman and Paul Selby; *History of Peoria County, Ill.* (Chicago, 1880); and C. Ballance, *History of Peoria* (Peoria, 1870).

PEPE, GUGLIELMO (1783-1855), Neapolitan general, was born at Squillace in Calabria. He entered the army at an early age, but in 1799 he took part in the republican movement at Naples inspired by the French Revolution; he fought against the Bourbon troops under Cardinal Ruffo, was captured and exiled to France. He entered Napoleon's army and served with distinction in several campaigns, including those in the Neapolitan kingdom, first under Joseph Bonaparte and later under Joachim Murat. After commanding a Neapolitan brigade in the Peninsular campaign, Pepe returned to Italy in 1813, with the rank of general, to help to reorganize the Neapolitan army. When the news of the fall of Napoleon (1814) reached Italy Pepe and several other generals tried without success to force Murat to grant a constitution as the only means of saving the kingdom from foreign invasion and the return of the Bourbons. On Napoleon's escape from Elba (1815) Murat, after some hesitation, placed himself on the emperor's side and waged war against the Austrians, with Pepe on his staff. After several engagements the Neapolitans were forced to retire, and eventually agreed to the treaty of Casalanza by which Murat was to abandon the kingdom; but the Neapolitan officers retained their rank under Ferdinand IV, who now regained the throne of Naples. While engaged in suppressing brigandage in the Capitanata, Pepe organized the carbonari (q.v.) into a national militia, and was preparing to use them for political purposes. He had hoped that the king would end by granting a constitution, but when that hope failed he meditated seizing Ferdinand, the emperor of Austria, and Metternich, who were expected at Avellino, and thus compelling them to liberate Italy (1819). The scheme broke down through an accident, but in the following year a military rising broke out, the mutineers cheering for the king and the constitution. Pepe himself was sent against them, but while he was hesitating as to what course he should follow Ferdinand promised a constitution (July 1820). A revolt in Sicily having been repressed, Pepe was appointed inspector-general of the army. In the meanwhile the king, who had no intention of respecting the constitution, went to Laibach to confer with the sovereigns of the holy alliance assembled there, leaving his son as regent. He obtained the loan of an Austrian army with which to restore absolute power, while the regent dallied with the Liberals. Pepe, who in parliament had declared in favour of deposing the king, now took command of the army and marched against the Austrians. He attacked them at Rieti (March 7,

1821), but his raw levies were repulsed. The army was gradually disbanded, and Pepe spent several years in England, France and other countries, publishing a number of books and pamphlets of a political character and keeping up his connexion with the Carbonari. When in 1848 revolution and war broke out all over Italy, Pepe returned to Naples, where a constitution had again been proclaimed. He was given command of the Neapolitan army which was to co-operate with Piedmont against the Austrians, but when he reached Bologna the king, who had already changed his mind, recalled him and his troops. Pepe, after hesitating between his desire to fight for Italy, and his oath to the king, resigned his commission in the Neapolitan service and crossed the Po with 2000 volunteers to take part in the campaign. After a good deal of fighting in Venetia, he joined Manin in Venice and took command of the defending army. When the city was forced by hunger to surrender to the Austrians, Pepe and Manin were among those excluded from the amnesty; he again went into exile and died in Turin in 1855.

The story of Pepe's life down to 1846 is told in his own interesting *Memoria* (Lugano, 1847), and his *Narrative of the Events... at Naples in 1820 and 1821* (London, 1821); for the later period of his life see the general histories of the Risorgimento, and the biographical sketch in vol. ii. of L. Carpi's *Risorgimento* (Milan, 1886).

PEPERINO, an Italian name applied to a brown or grey volcanic tuff, containing fragments of basalt and limestone, with disseminated crystals of augite, mica, magnetite, leucite, &c. The typical peperino occurs in the Alban Hills, near Rome, and was used by the ancients, under the name of lapis albanus, as a building stone and for the basins of fountains. Other tuffs and conglomerates in Auvergne and elsewhere are also called peperino. The name originally referred to the dark coloured inclusions, suggestive of pepper-corns. In English the word has sometimes been written peperine.

PEPPER, WILLIAM (1843-1898), American physician, was born in Philadelphia, on the 21st of August 1843. He was educated at the university of Pennsylvania, graduating from the academic department in 1862 and from the medical department in 1864. In 1868 he became lecturer on morbid anatomy in the same institution, and in 1870 lecturer on clinical medicine. From 1876 to 1887 he was professor of clinical medicine, and in 1887 succeeded Dr Alfred Stillé as professor of theory and practice of medicine. He was elected provost of the university in 1881, resigning that position in 1894. For his services as medical director of the Centennial Exhibition in 1876 he was made knight commander of St Olaf by the king of Sweden. He founded the *Philadelphia Medical Times*, and was editor of that journal in 1870-1871. He was known particularly for his contributions on the subject of the theory and practice of medicine, and the *System of Medicine* which he edited in 1885-1886 became one of the standard textbooks in America. Among his contributions to the medical and scientific journals of the day, were "Trephining in Cerebral Disease" (1871); "Local Treatment in Pulmonary Cavities" (1874); "Catarrhal Irrigation" (1881); "Epilepsy" (1883); and "Higher Medical Education: the True Interest of the Public and the Profession." He died on the 28th of July 1898 at Pleasanton, California.

PEPPER, a name applied to several pungent spices known respectively as black, white, long, red, or cayenne, Ashanti, Jamaica, and melegueta pepper, but derived from at least three different natural orders of plants.

Black pepper is the dried fruit of *piper nigrum*, a perennial climbing shrub indigenous to the forests of Travancore and Malabar, from whence it has been introduced into Java, Sumatra, Borneo, the Malay Peninsula, Siam, the Philippines, and the West Indies. It climbs on tree-trunks by roots in the same way as ivy, and from its climbing habit is known as the pepper vine. It is one of the earliest spices known to mankind, and for many ages formed a staple article of commerce between India and Europe. Tribute has been levied in pepper; one of the articles demanded in 408 by Alaric as part of the ransom of Rome was 3000 lb of pepper. Its exorbitant price during the middle ages was one of the inducements which led the Portuguese to seek a

sea-route to India. The discovery of the passage round the Cape of Good Hope led (1498) to a considerable fall in the price, and about the same time the cultivation of the plant was extended to the western islands of the Malay Archipelago. Pepper, however, remained a monopoly of the Portuguese crown as late as the 18th century. In Great Britain it was formerly taxed very heavily, the impost in 1623 amounting to 5s., and as late as 1823 to 2s. 6d. lb.

The largest quantities of pepper are produced in Penang, the island of Rionw, and Johore near Singapore—Penang affording on an average about half of the entire crop. Singapore is the great emporium for this spice in the East, the largest proportion being shipped thence to Great Britain. The varieties of black pepper met with in commerce are known as Malabar, Aleppy or Tellicherry, Cochin, Penang, Singapore and Siam.



Piper nigrum.

a, Twig with fruit (about $\frac{1}{2}$ nat. size); b, longitudinal section of flower much enlarged; c, section of fruit.

It owes its pungency to a resin, and its flavour to a volatile oil, of which it yields from 1.6 to 2.2%. The oil agrees with oil of turpentine in composition as well as in specific gravity and boiling point. In polarized light it deviates the ray, in a column 50 mm. long, 1.2° to 3.4° to the left. Pepper also contains a yellow crystalline alkaloid, called piperine, to the extent of 2 to 8%. This substance has the same empirical formula as morphine, $C_{17}H_{19}NO_2$, but differs in constitution and properties. It is insoluble in water when pure, is devoid of colour, flavour and odour, and may be resolved into piperic acid, $C_{17}H_{17}O_4$, and piperidine, C_4H_9N . The latter is a liquid colorless alkaloid, boiling at $106^{\circ}C$, has an odour of pepper and ammonia, and yields crystallizable salts. A fatty oil is found in the pericarp of pepper, and the berries yield on incineration from 4.1 to 5.7 of ash. The only use of black pepper is as a condiment, but it may be given therapeutically in doses of 5 to 50 grains. It has the pharmacological actions of a volatile oil.

In the south-west of India, where the pepper-plant grows wild, it is found in rich, moist, leafy soil, in narrow valleys, propagating itself by running along the ground and giving off roots into the soil. The only method of cultivation adopted by the natives is to tie up the end of the vines to the neighbouring trees at distances of at least 6 ft., especially to those having a rough bark, in order that the roots may easily attach themselves to the surface. The underwood is then cleared away, leaving only sufficient trees to provide shade and permit free ventilation. The roots are manured with a heap of leaves, and the shoots are trained twice a year. In localities where the pepper does not grow wild, ground is selected which permits of free drainage, but which is not too dry nor liable to inundation, and cuttings are planted at about a foot from the trees either in the rainy season in June or in the dry season in February. Sometimes several cuttings, about 18 in. long are placed in a basket and buried at the root of the tree, the cuttings being made to slope towards the trunk. In October or November the young plants are manured with a mixture of leaves and cow-dung. On dry soils the young plants require watering every other day during the dry season for the first three years. The plants bear in the fourth or fifth year, and if raised from cuttings are

fruitful for seven years, if from seed for fourteen years. The pepper from plants raised from cuttings is said to be superior in quantity and quality, and this method is in consequence most frequently adopted. Where there are no trees the ground is made into terraces and enclosed by a mud wall, and branches of *Erythrina indica* are put into the ground in the rainy season and in the course of a year are capable of supporting the young pepper plants. In the meantime mango trees are planted, these being preferred as supports, since their fruit is not injured by the pepper plant, while the *Erythrina* is killed by it in fourteen or fifteen years.

In Sumatra the ground is cleared, ploughed, and sown with rice, and cuttings of the vine are planted in September, 5 ft. apart each way, together with a sapling of quick growth and rough bark. The plants are now left for twelve or eighteen months and then entirely buried, except a small piece of bent stem, whence new shoots arise, three or four of which are allowed to climb the tree near which they are planted. These shoots generally yield flowers and fruits the next year. Two crops are collected every year, the principal one being in December and January and the other in July and August, the latter yielding pepper of inferior quality and in less quantity.

Two or three varieties are met with in cultivation; that yielding the best kinds has broadly ovate leaves, five to seven in number, nerved and stalked. The flower-spikes are opposite the leaves, stalked and from 3 to 6 in. long; the fruits are sessile and fleshy. A single stem will bear from twenty to thirty of these spikes. The harvest begins as soon as one or two berries at the base of the spikes begin to turn red, and before the fruit is mature, but when full-grown and still hard; if allowed to ripen, the berries lose pungency, and ultimately fall off and are lost. The spikes are collected in bags or baskets and dried in the sun. When dry the pepper is put into bags containing from 64 to 128 lb. In Sumatra the yield is estimated at about 15 lb per plant per annum. In Malabar each vine gives 2 lb a year up to the fifteenth or twentieth year, or about 24 lb from each tree, a single tree sometimes supporting eight or twelve vines; an acre is calculated to bear 2500 plants, to cost about £4 in outlay to bring it into bearing, and to yield a produce of £80 when in its best condition.

White pepper differs only in being prepared from the ripe fruits. These, after collection, are kept in the house three days and then bruised and washed in a basket with the hand until the stalks and pulpy matter are removed, after which the seeds are dried. It is, however, sometimes prepared from the dried black pepper by removing the dark outer layer. It is less pungent than the black but possesses a finer flavour. It is chiefly prepared at the island of Riouw, but the finest comes from Tellicherry.

White pepper affords on an average not more than 1.9% of essential oil; but, according to Cazeneuve, as much as 9% of piperine, and of ash not more than 1.1%.

Long pepper is the fruit-spike of *Piper officinarum* and *P. longum*, gathered shortly before it reaches maturity and dried. The former is a native of the Indian Archipelago, and has oblong-ovate, acuminate leaves, which are pinnately veined. The latter is indigenous in the hotter provinces of India, Ceylon, Malacca and the Malay Islands; it is distinguished from *P. officinarum* by the leaves being cordate at the base and five-veined.

Long pepper appears to have been known to the ancient Greeks and Romans under the name of *πτερον πικρόν*; and in the 10th century mention is made of long pepper, or macropiper, in conjunction with black and white peppers. The spice consists of a dense spike of minute baccate fruits closely packed around the central axis, the spike being about 14 in. long and $\frac{1}{2}$ in. thick; as met with in commerce they have the appearance of having been limed. In Bengal the plants are cultivated by suckers, which are planted about 5 ft. apart on dry rich soil on high ground. An English acre will yield about 3 maunds (80 lb) the first year, 12 the second, and 18 the third year; after this time the yield decreases, and the roots are therefore grubbed up and sold as *piperi mal.* under which name they are much used as a medicine in India. After the fruit is collected, which is usually in January, the stem and leaves die down to the ground. Long pepper contains piperine, resin and volatile oil and yields about 8% of ash. Penang and Singapore are the principal centres in the East for its sale.

Ashanti or West African pepper is the dried fruit of *Piper Clusii*, a plant widely distributed in tropical Africa, occurring most abundantly in the country of the Niam-niam. It differs from black pepper in being rather smaller, less wrinkled, and in being attenuated into a stalk, like cubeba (the dried unripe fruits of *P. Cubeba*), to which it bears considerable resemblance externally. The taste, however, is pungent, exactly like that of pepper, and the fruit contains piperine. It was imported from the Grain Coast by the merchants of Rouen and Dieppe as early

as 1364 and was exported from Benin by the Portuguese in 1485; but, according to Clusius, its importation was forbidden by the king of Portugal for fear it should depreciate the value of the pepper from India. In tropical Africa it is extensively used as a condiment, and it could easily be collected in large quantities if a demand for it should arise.

Jamaica pepper is the fruit of *Pimenta officinalis*, an evergreen tree of the Myrtle family. It is more correctly termed "pimento" or "allspice," as it is not a true pepper.

Melogeuta pepper, known also as "Guinea grains," "grains of paradise" (q.v.) or "alligator pepper," is the seed of *Amomum Melogeuta*, a plant of the ginger family; the seeds are exceedingly pungent, and are used as a spice throughout central and northern Africa.

For Cayenne pepper, see that article.

PEPPER-CORN, the fruit or seed of the pepper plant; hence anything very small or insignificant. *Pepper-corn rent* is a merely nominal rent, reserved for the purpose of having the tenancy acknowledged by the tenant. Building leases frequently reserve a pepper-corn as rent for the first few years. See RENT.

PEPPERMINT, an indigenous perennial herb of the natural order Labiatae, and genus *Mentha* (see MINT), the specific name being *Mentha piperita*, is distinguished from other species of the genus by its stalked leaves and oblong-obtuse spike-like heads of flowers. It is met with, near streams and in wet places, in several parts of England and on the European continent, and is also extensively cultivated for the sake of its essential oil in England,¹ in several parts of continental Europe, and in the



FIG. 1.—*Mentha piperita*.

a, Flowering branch (about $\frac{1}{2}$ nat. size); b, flower showing form of calyx teeth (enlarged).

United States. Yet it was only recognized as a distinct species late in the 17th century, when Dr Eales discovered it in Hertfordshire and pointed it out to Ray, who published it in the second edition of his *Synopsis stirpium britannicarum* (1696). The medicinal properties of the plant were speedily recognized and it was admitted into the *London Pharmacopoeia* in 1721, under the name of *Mentha piperitis sapor.*

Two varieties are recognized by growers, the white and the black mint. The former has purplish and the latter green stems; the leaves are more coarsely serrated in the white. The black is more generally cultivated, probably because it is found to yield more oil, but that of the white variety is considered to have a more delicate odour, and obtains a higher price. The white is the kind chiefly dried for herbalists. The flavour varies to a slight extent even with particular plots of land, badly drained ground being known to give unfavourable results both as to the quantity and quality of the oil. That of the Japanese

¹ Near Mitcham in Surrey, Wisbech in Cambridgeshire, Market Deeping in Lincolnshire and Hitchin in Hertfordshire.

and Chinese oil also differs slightly from the English; and is thus distinguishable by experts. In America the oil is liable to be injured in flavour by aromatic weeds which grow freely among the crop, the most troublesome of these being *Erigeron canadense*, and *Erechtithis hieracifolia*. When pure the oil is nearly colourless and has an agreeable odour and powerful aromatic taste, followed by a sensation of cold when air is drawn into the mouth. It has a specific gravity of 0.84 to 0.92, and boils at 365° F. Mitcham oil, when examined by polarized light in a column 50 mm. long, deviates from 14.2° to 10.7° to the left, the American 4.3°. When oil of peppermint is cooled to 4° C. it sometimes deposits colourless hexagonal prisms of menthol, $C_{10}H_{16}O$, which are soluble in alcohol and ether, almost insoluble in water, and fusible at 92° F. The oil consists chiefly of menthol and a terpene called menthene, $C_{10}H_{18}$. Oil of peppermint is often adulterated with a third part of rectified spirit, which may be detected by the milkiness produced when the oil is agitated with water. Oil of rosemary and rectified oil of turpentine are sometimes used for the same purpose. If the oil contains turpentine it will explode with iodine. If quite pure it dissolves in its own weight of rectified spirits of wine. Peppermint oil is largely distilled at Canton, a considerable quantity being sent to Bombay, also a large quantity of menthol. The species cultivated in the neighbourhood of Canton, is *Mentha arvensis*, var. *glabrata*. Peppermint is chiefly cultivated in the province of Kiang-si; and according to native statements as much as 40 piculs of oil of peppermint are sent annually to ports on the coast. In Japan also the distillation of oil of peppermint forms a considerable industry, the plant cultivated being *M. arvensis*, var. *piperascens*. The oil, under the name of *hakka no abura*, is exported from Hiogo and Osaka, but is said to be frequently adulterated. The menthol is obtained by subjecting the oil to a low temperature, when it crystallizes out and is separated. The two varieties of *M. arvensis* just



FIG. 2.—*Mentha arvensis*, var. *piperascens*.
a, Flowering branch removed; b, calyx showing form of teeth (enlarged).

named yield much more menthol than *M. piperita*. It is remarkable, however, that the *M. arvensis*, var. *janamica*, growing in Ceylon, has not the flavour of peppermint but that of garden mint, while typical form of *M. arvensis* grown in Great Britain has an odour so different from peppermint that it has to be carefully removed from the field lest it should spoil the flavour of the peppermint oil when the herb is distilled. *M. incana*, cultivated near Bombay as a herb, also possesses the flavour of peppermint. In the form in which menthol is imported it bears some resemblance to Epsom salts, with which it is sometimes adulterated.

The volatile oil of *Mentha piperita* is a valuable and widely used drug. Its chief constituents are menthol and menthene, which is a liquid terpene. The British pharmacopoeia contains two preparations of this oil, the *Aqua menthae piperitae* and the *Spiritus menthae piperitae*. The oil has the characters of its class, with certain special features. Its local anæsthetic action is exceptionally strong. It is also powerfully antiseptic. These two properties make it valuable in the relief of toothache and in the treatment of carious cavities in the teeth. They also render the drug valuable in certain forms of dyspepsia and in colic generally, "soda-mint lozenges" being a familiar form. The characteristic anti-spasmodic action of the volatile oils is perhaps more marked in this than in any other oil, and greatly adds to its power of relieving pains arising in the alimentary canal. The volatile oil of spearmint is also official in Great Britain and the United States, being given in the same doses and for the same purposes as oil of peppermint. It is of less value medicinally, not containing any appreciable quantity of menthol, the place of which is taken in the *oleum menthae viridis*—

the pharmacopœial name—by carvone, $C_{10}H_{16}O$, found in caraway oil, and isomeric with thymol.

The following mode of cultivation of peppermint is adopted at Market Deeping. A rich friable soil, retentive of moisture, is selected, and the ground is well tilled 8 to 10 in. deep. The plants are propagated in the spring, usually in April and May. When the young shoots from the crop of the previous year have attained a height of about 4 in. they are pulled up and transplanted into new soil. They grow vigorously the first year, and throw out numerous stolons on the surface of the ground. After the crop has been removed these are allowed to harden or become woody, and then farm-yard manure is scattered over the field and ploughed in. In this way the stolons are divided into numerous pieces, and covered with soil before the frost sets in. If the autumn is wet they are liable to become sodden, and rot, and the next crop fails. In the spring the fields are dressed with Peruvian guano. In new ground the peppermint requires hand-weeding two or three times, as the hoe cannot be used without injury to the plants. Moist heavy weather in August is apt to cause the foliage to drop off and leave the stems almost bare. In these circumstances rust (*Puccinia menthae*) also is liable to attack the plants. This is prevented to a certain extent by a rope being drawn across the plants, by two men walking in the furrows, so as to remove excessive moisture. The average yield of peppermint is about 165 cwt. per acre. The first year's crop is always cut with the sickle to prevent injury to the stolons. The herb of the second and third year is cut with scythes, and then raked by women into loose heaps ready for carting. The field is then gleaned by boys, who add what they collect to the heaps. The plants rarely yield a fourth crop on the same land. The harvest usually commences in the beginning or middle of August, or as soon as the plants begin to flower, and lasts for six weeks, the stills being kept going night and day. The herb is carted direct from the field to the stills, which are made of copper, and contain about 5 cwt. of the herb. Before putting the peppermint into the still water is poured in to a depth of about a ft., at which height a false bottom is placed, and on this the herb is thrown and trodden down by men. The lid, which fits into a water-joint, is then let down by pulleys and fastened by two bars, any excess of pressure or temperature being indicated by the water that is ejected at the joint. The distillation is conducted by the application of direct heat at the lowest possible temperature, and is continued for about four and a half hours. When this operation is completed, the lid is removed and a rope is attached to a hook on the false bottom, which, as well as the herb resting on it, is raised bodily by a windlass and the peppermint carried away in the empty carts on their return journey to the fields, where it is placed in heaps and allowed to rot, being subsequently mixed with the manure applied in the autumn as above stated. The usual yield of oil, if the season be warm and dry, is said to be 1 oz. from 5 lb of the fresh flowering herb, but, if wet and unfavourable, the product is barely half that quantity. The yield of a charge of the still is estimated at from 1 lb 12 oz. to 5 lb. The oil improves in mellowness even if kept as long as ten or fourteen years. The green colour sometimes present in the oil is stated to be due to a quantity of water larger than necessary having been used in the distillation; on the other hand, if the herb be left in the still from Saturday to Monday, the oil assumes a brown tint.

In France peppermint is cultivated on damp rich ground at Sens, in the department of the Yonne. In Germany it is grown in the neighbourhood of Leipzig, where the little town of Colleda produces annually as much as 40,000 cwt. of the herb. In the United States peppermint is cultivated on a most extensive scale, chiefly in southwest Michigan, the west districts of New York state, and Ohio. The yield averages from 50 to 30 lb per acre. In Michigan the plant was introduced in 1855.

PEPPERRELL, SIR WILLIAM (1696-1750), American soldier, was born in Kittery, Maine, then a part of Massachusetts, on the 27th of June 1696. He studied surveying and navigation, and joined his father in his ship-building, fishing and general trading business, quickly becoming one of the wealthiest and most influential men in the province. He was commissioned captain (1717), major, lieutenant-colonel, and in 1726 colonel of militia. Pepperrell served in the Massachusetts general court (1726-1727), and in the governor's council (1727-1750), of which for eighteen years he was president. Although not a trained lawyer, he was chief justice of the court of common pleas from 1730 until his death. In 1745 he was commander-in-chief of the New England force of about 4000, which, with the assistance of a British squadron under Commodore Peter Warren, besieged and captured the French fortress of Louisbourg; the garrison surrendering on the 16th of June and Pepperrell and Warren taking possession on the following day. For his services Pepperrell, in November 1746, was created a baronet—the only New Englander so honoured. He was active in raising troops

during the "French and Indian War," and received the rank of lieutenant-general in February 1759. He died in Kittery, Maine, on the 6th of July in the same year.

See Usher Parsons, *Life of Sir William Pepperell, Bart.* (Cambridge, Mass., 1855), based on the family papers.

PEPPER TREE, a tree which has no proper connexion with the true pepper (*Piper*), and is really a member of the natural order Anacardiaceae, being known botanically as *Schinus Molle*, from the Peruvian name *Mulli*. It is a native of tropical South America and is grown in the open air in the south of Europe. It is a small tree with unequally pinnate leaves, the segments linear, entire or finely saw-toothed, the terminal one longer than the rest, and all filled with volatile oil stored in large cells or cysts, which are visible to the naked eye and appear like holes when the leaf is held up to the light. When the leaves are thrown upon the surface of water the resinous or oily fluid escapes with such force as violently to agitate them. The flowers are small, whitish, arranged in terminal clusters and polygamous or unisexual, with five sepals, as many petals, ten stamens (as large as the petals in the case of the male flower, very small in the female flower, but in both springing from a cushion-like disk surrounding the base of the three-celled ovary). The style is simple or three-cleft, and the fruit a small, globose, pea-like drupe with a bony kernel enclosing a single seed. The fleshy portion of the fruit has a hot aromatic flavour from the abundance of the resin it contains. The resin is used for medicinal purposes by the Peruvians, and has similar properties to mastic. The Japan pepper tree is *Xanthoxylum piperitum* the fruits of which have also a hot taste. Along the Riviera the tree known as *Melia Aedarach*, or the "Pride of India," is also incorrectly called the pepper tree by visitors.

PEPSIN, an enzyme or ferment obtained by drying the mucous lining of the fresh and healthy stomach of a pig, sheep or calf. As used in medicine it consists of a light yellow-brown or white powder or of pale yellow translucent grains or scales. It is only slightly soluble in water and alcohol. Pepsin is used to help gastric digestion in old people and in those in whom there is a deficient secretion of the gastric juice. It is useful in chronic catarrhal conditions of the stomach, the dyspepsia of alcoholism, and in gastric ulcer and cancer of the stomach.

Pepsin digests the albumens but is useless in the digestion of fats or carbohydrates. It may also be used to predigest albuminous foods. The following is a method of peptonizing beef. Take 1 lb. of minced raw lean beef, 1 pint of water containing 0.2 % of hydrochloric acid, place in a jar with 30 grs. of pepsin, set in a warm place at 110° F. for 3 hours, stirring occasionally. Then quickly boil it. It is usually unnecessary to strain it, as the meat is reduced to a fine almost impalpable powder which is readily assimilated. Many varieties of proprietary peptonizing tablets are on the market and are convenient for the preparation of peptonized milk. The following is a method of preparing it. Take a clean glass quart bottle, pour in a pint of perfectly fresh cold milk, then add a teaspoonful of cold water in which a peptonizing tablet has been dissolved. Submerge the bottle in a can of water at 100° F. for from 5 to 10 minutes, take out the bottle and place on ice to prevent the further action of the pepsin. If no ice is convenient bring the milk to a boil for the same purpose. If the action of the pepsin be continued for a much longer period the milk becomes bitter to the taste from the development of excess of peptones. Predigested foods should not be used over a long period or the digestive functions of the stomach may atrophy from disuse.

Pancreatic solution, derived from the pancreas of a pig digested in alcohol, has the power of converting starch into sugar, and albumen and fibrin into peptones. It only acts in an alkaline medium and at a temperature under 140° F. If used to peptonize milk sodium bicarbonate should be added. Many commercial preparations are on the market. Trypsin, the principal ferment of the pancreas, also changes proteids into peptones.

PEPUSCH, JOHN CHRISTOPHER (1667-1752), English musician, of German parentage, was born in Berlin. He began his study of music at an early age, and about 1700 left Berlin and went to England, where he had various engagements, and where he went on with his researches into ancient music. He composed a number of church services and instrumental pieces, besides music for masques and plays, but he is best known in connexion with the founding in 1710 of the Academy of Ancient Music. In 1713 he was made a Mus.D. of Oxford, and in 1746

F.R.S. In 1718 he married Margarita de l'Épine (d. 1746), who, as the first Italian to sing in England, was described in 1692 in the *London Gazette* simply as "the Italian woman." Pepusch died in London on the 20th of July 1752. His *Treatise on Harmony* (anonymous 1st ed. 1730) is believed to have been an embodiment of his rules drafted by his pupil Viscount Paisley, afterwards earl of Abercorn.

PEPYS, SAMUEL (1633-1703), English diarist, was born on the 23rd of February 1633. The place of his birth is not known. The name was pronounced in the 17th century, and has always been pronounced by the family, "Peepa." The family can be traced in Cambridgeshire as far back as the reign of Edward I. They rose by slow degrees from the class of small copyholders and yeoman farmers to the position of gentry. In 1563 they had a recognized right to use a coat of arms. John Pepys, Samuel's father, was a younger son, who, like other gentlemen in his position in that age, went into trade. He was for a time established as a tailor in London, but in 1661 he inherited a small estate at Brampton near Huntingdon, where he lived during the last years of his life.

Samuel was fifth child and second son of a large family, all of whom he survived. His first school was in Huntingdon, but he was afterwards sent to St Paul's in London, where he remained till 1650. While at St Paul's he was an eye-witness of the execution of King Charles I. On the 21st of June in that year his name was entered as a sizar on the books of Trinity Hall, Cambridge, but it was transferred to Magdalene on the 1st of October. On the 5th of March he entered into residence, and he remained there till 1654 or 1655. He obtained a Spendulfe scholarship a month after entering, and one on Dr John Smith's foundation on the 14th of October 1653. Nothing is known of his university career except that on the 21st of October 1653 he was publicly admonished with another undergraduate for having been "scandalously overserved with drink." At Cambridge he wrote a romance, *Love is a Cheat*, which he afterwards destroyed. On the 1st of December 1655 he was married at St Margaret's church, Westminster, to Elizabeth, daughter of Alexander Marchant, Sieur de St Michel, a French Huguenot exile from Anjou who had married an English lady named Kingsmill. Pepys had at this time no independent means, and probably relied on his cousins, the Montagues, to provide for him. On the 26th of March 1658 he was cut for the stone, an event which he always kept in memory by a solemn anniversary. In 1659 he went as secretary with his cousin, Edward Montagu, afterwards earl of Sandwich, on a voyage to the Sound. On his return he was engaged as a clerk under Mr (afterwards Sir) Edward Downing, one of the four tellers of the exchequer. In 1660 he accompanied his cousin, who commanded the fleet which brought King Charles II. back from exile. In that year, by the interest of his cousin, he was named "clerk of the acts" in the navy office, but was compelled to buy off a competitor, one Barlow, by an annuity of £100.

Pepys was now fairly established in the official career which led him to honour. On the 1st of January 1660 he had begun his second and hidden life as a diarist. It is in that capacity that he is of such unique interest. But if his diary had never been written, or had been lost, he would still be a notable man, as an able official, the author of valuable *Memoirs of the Navy* (1690), an amateur musician and protector of musicians, a gentleman who took an enlightened interest in science, and was elected president of the Royal Society. To his contemporary diarist, John Evelyn, he appeared as "a worthy, industrious and curious person." It is true that Andrew Marvel accused him of having accumulated a fortune of £40,000 by "illegal wages." But this charge, made in a pamphlet called *A List of the principal Labourers in the great design of Popery and Arbitrary Power*, was attributed to political animosity. To the world he appeared as an honourable and religious man, and so he would seem to have been to us if he had not recorded in his diary all those weaknesses of character and sins of the flesh which other men are most careful to conceal.

His place of clerk to the Navy Board was equivalent to the

post of permanent under secretary in modern times. It made him chief of the secretariat and a member of the administrating body of the navy. Though he was so ignorant of business that he did not even know the multiplication table when he first took office, he soon mastered the needful mechanical details by working early and late. He had other posts and honours, which came to him either as consequential on his clerkship or because he was a useful official. On the 23rd of July 1660 he was appointed one of the clerks of the privy seal, an office which returned him £3 a day in fees. He was made a justice of the peace. In 1662 he was appointed a younger brother of the Trinity House, and was named a commissioner for managing the affairs of Tangier, then occupied by an English garrison. In 1664 he became a member of the corporation of the Royal Fishery, to which body he was named treasurer when another official had brought the accounts into confusion. In that year he also joined the Royal Society. During the naval war with Holland (1664-67) he proved himself an indefatigable worker. As surveyor of the victualling, the whole burden of a most important department was thrown on him in addition to his regular duties. He in fact organized the department. While the plague was raging in London in 1666 he remained at his post when many of his colleagues ran away, and he manfully avowed his readiness to take the risk of disease, as others of the king's servants faced the dangers of war. He had now gained the full confidence of the lord high admiral, the duke of York, afterwards King James II. When, on the termination of the war, the navy office was violently attacked in parliament, he was entrusted with its defence. The speech which he delivered at the bar of the House of Commons on the 5th of March 1668 passed for a complete vindication. In sober fact the charges of mismanagement were well founded, but the fault was not in the officials of the navy office only, and Pepys, who was master of the details, had no difficulty in throwing dust in the eyes of the House of Commons, which was ignorant. Nobody indeed was better acquainted with the defects of the office, for in 1668 he drew up for the duke of York two papers of inquiry and rebuke, "The Duke's Reflections on the severall Members of the Navy Board's Duty" and "The Duke's answer to their severall excuses" (Harleian MS. 6003). In 1669 he travelled abroad. His success in addressing parliament gave him the ambition to become a member of the House of Commons. He stood for Aldborough, but the death of his wife, on the 10th of November 1669, prevented him from conducting his canvass in person, and he was not elected. In 1673 he was returned for Castle Rising. The validity of his election was questioned by his opponent, Mr Offey, and the committee of privilege decided against him, but the prorogation of the house prevented further action. The no-popey agitation was now growing in strength. The duke of York was driven from office by the Test Act, and Pepys was accused of "popery," partly on the ground that he was said to keep a crucifix and altar in his house, partly because he was accused of having converted his wife to Roman Catholicism. The crucifix story broke down on examination, but there is some reason to believe that Mrs Pepys did become a Roman Catholic. Pepys was transferred by the king from the navy office to the secretaryship of the admiralty in 1673. In 1679 he was member for Harwich, and in the height of the popish plot mania he was accused, manifestly because he was a trusted servant of the duke of York, of betraying naval secrets to the French, but the charges were finally dropped. Pepys was released on bail on the 12th of February 1680. In that year he accompanied the king to Newmarket, and took down the narrative of his escape after the battle of Worcester. A proposal to make him head of King's College, Cambridge, in 1681, came to nothing. In 1682 he accompanied the duke of York to Scotland, where the uncleanly habits of the people caused him great offence. In 1683-1684 he was engaged in arranging for the evacuation of Tangier. He visited the place and kept a diary of his voyage. In 1684 he was elected president of the Royal Society. On the accession of King James II. in 1685 he retained his place as secretary to the admiralty, to which he had been appointed by patent when James resumed the lord high admiralship (June 10,

1684), and Pepys was in effect minister for the navy. The revolution of 1688 ended his official career. He was dismissed on the 9th of March 1689, and spent the rest of his life in retirement, and, except for a brief imprisonment on the charge of Jacobite intrigue in 1690, in peace. He died at his house in Clapham on the 25th of May 1703. His last years were passed in correspondence with his friends, who included Evelyn and Dryden, or in arranging his valuable library. It was left on his death to his nephew, John Jackson, son of his sister Pauline, and in 1724, by the terms of his will, was transferred to Magdalene College, Cambridge, where it is still preserved.

Such was the outward and visible life of Samuel Pepys, the public servant whose diligence was rewarded by success. The other Pepys, whom Sir Walter Scott called "that curious fellow," was revealed in 1825, when his secret diary was partly published. The first entry was made on the 1st of January 1660, the last on the 31st of May 1669, when the increasing weakness of his eyes, which had given him trouble since 1664, compelled him to cease writing in the conditions he imposed upon himself: If there is in all the literature of the world a book which can be called "unique" with strict propriety it is this. Confessions, diaries, journals, autobiographies abound, but such a revelation of a man's self has not yet been discovered. The diary is a thing apart by virtue of three qualities which are rarely found in perfection when separate and nowhere else in combination. It was secret; it was full; and it was honest. That Pepys meant it for his own eye alone is clear. He wrote it in Shelton's system of tachygraphy published in 1641, which he complicated by using foreign languages or by varieties of his own invention whenever he had to record the passages least fit to be seen by his servants or by "all the world." Relying on his cypher he put down whatever he saw, heard, felt or imagined, every motion of his mind, every action of his body. And he noted all this, not as he desired it to appear to others, but as it was to his seeing. The result is "a human document" of amazing vitality. The man who displays himself to himself in the diary is often odious, greedy, cowardly, casuistical, brutal. He tells how he kicked his cook, and blacked his wife's eye, and was annoyed when others saw what he had done. He notes how he compelled the wives of unfortunate men who came to draw their husband's pay at the navy office to prostitute themselves; how he took "compliments," that is to say gifts, from all who had business to do with the navy office; how he got tipsy and suffered from sick headache; how he repented, made vows of sobriety, and found casuistical excuses for breaking them. The style is as peculiar as the matter—colloquial, garrulous, racy from simplicity of language, and full of the unconscious humour which is never absent from a truthful account of the workings of nature in the average sensual man. His position enabled him to see much. His complete harmony with the animalism and vulgarity of the Restoration makes him a valuable witness for his time. To his credit must be put the facts that he knew the animalism and vulgarity to be what they were; that he had a real love of music and gave help to musicians, Cesare Morelli for instance; that though he made money out of his places he never allowed bad work to be done for the navy if he could help it; that he was a hard worker; and that he had a capacity for such acts of kindness and generosity as are compatible with a gross temperament and a pedestrian ambition.

The diary, written in a very small hand in six volumes, was included among his books at Magdalene. On the publication of Evelyn's diary in 1818, the then head of Magdalene, the Hon. and Rev. George Neville, decided to publish Pepys's. Part of the MS. was deciphered by his cousin Lord Grenville. The library contained both the short and the long-hand copies of Pepys's account of King Charles's adventures, but its books were so little known by the curators that this key was overlooked. The MS. was deciphered by John Smith, afterwards rector of Baldock in Hertfordshire, between 1819 and 1822. The first and partial edition, edited by Richard Neville Griffin, 3rd Lord Braybrooke, appeared in 1825 in two volumes quarto (London). It attracted great attention and was reviewed by Sir Walter Scott in the *Quarterly* for January 1826. A second edition in two octavo

volumes followed in 1828 (London). A third and enlarged edition in five volumes octavo appeared in 1848-1849, and a fourth in four in 1854 (London). In 1875-1879 Dr Minors Bright published a still fuller edition in six volumes octavo (London). Many portraits of Pepys are known to have been taken and several can be traced. One was taken by Savill (1661), another by John Hales (1666), now in the National Portrait Gallery. A portrait by Sir Peter Lely is in the Pepysian library, Magdalene College, Cambridge. Three portraits were taken by Sir Godfrey Kneller, of which one belongs to the Royal Society, and another is in the Hall of Magdalene. Pepys's only known publication in his life was the *Memoirs of the Navy*, but other writings have been attributed to him.

AUTHORITIES.—The standard edition of *Pepys's Diary* is that by H. B. Wheatley, in nine volumes octavo, with a supplementary volume of *Pepysiana* (London, 1893-1899). See also Wheatley's *Samuel Pepys, and the world he lived in* (London, 1880); *The Life, Journals and Correspondence of Pepys*, by J. Smith (London, 1841); E. H. Moorhouse, *Samuel Pepys, Administrator, Observer, Gossp* (1909); and P. Lubbock, *Samuel Pepys* (1909). (D. H.)

PEQUOT, an Algonquian tribe of North-American Indians, a branch of the Mohicans. They occupied the coast of Connecticut from Niantic river to the Rhode Island boundary. Together with their kinmen, the Mohegans, they formed a powerful and warlike people, bitterly hostile to the early settlers. In 1637 the Pequots were surprised by the whites at their fort on the Mystic river, and suffered so completely a defeat that the tribe was broken up, and its remnants took refuge with neighbouring tribes. The Pequot country passed under the control of the Mohegans. At the height of their power the Pequots numbered, it is estimated, some 3000.

PERCEPTION (from Lat. *percipere*, to perceive), in psychology, the term specially applied to the mental process by which the mind becomes conscious of an external object; it is the mental completion of a sensation, which would otherwise have nothing but a momentary existence coextensive with the duration of the stimulus, and is intermediate between sensation and the "ideal revival," which can reinstate a perceptual consciousness when the object is no longer present. This narrow and precise usage of the term "perception" is due to Thomas Reid, whose view has been generally adopted in principle by modern psychologists. On the other hand some psychologists decline to accept the view that the three processes are delimited by sharp lines of cleavage. It is held on the one hand that sensation is in fact impossible as a purely subjective state without cognition; on the other that sensation and perception differ only in degree, perception being the more complex. The former view admits, which the latter practically denies, the distinction in principle. Among those who adopt the second view are E. B. Titchener and William James. James (*Principles of Psychology*, ii. 76) compares sensation and perception as "the bare and the richer consciousness," and says that "beyond the first crude sensation all our consciousness is a matter of suggestion, and the various suggestions shade gradually into each other, being one and all products of the same psychological machinery of association." Similarly Wundt and Titchener incline to obliterate the distinction between perception and ideal revival. Prior to Reid, the word perception had a long history in the wider sense of cognition in general. Locke and Hume both use it in this sense, and regard thinking as that special kind of perception which implies deliberate attention. (See **PSYCHOLOGY**.)

PERCEVAL, or **PERCVELLE** (Ger. *Parzival*, Fr. *Perlesvaus*, Welsh, *Peredur*), the hero of a comparatively small, but highly important, group of romances, forming part of the Arthurian cycle. Originally, the story of Perceval was of the character of a folk-tale, and that of one of remarkable importance and world-wide diffusion. He is represented as the son of a widow, "la dame yeuve," his father having been slain in tourney, battle or by treachery, either immediately before, or shortly after his birth. The mother, fearful lest her son should share his father's fate, flies to the woods, either alone with one attendant, or with a small body of faithful retainers, and there brings up her son in ignorance of his name, his parentage and all knightly accomplishments.

The youth grows up strong, swift-footed and of great personal beauty, but, naturally enough, of very limited intelligence. This last is one of the most characteristic traits of the Perceval story, connecting it alike with the Irish *Lay of the Great Fool*, and the Teutonic *Disembling* tales. He spends his days chasing the beasts of the forest, running them down by sheer speed, or killing them with darts (javelots) or bow and arrows, the only weapons he knows.

One day, however, he meets a party of knights in armour; he first adores the leader as God, and then takes them to be some new and wondrous kind of animal, asking the most naive questions as to their armour and equipment. Being told that they are knights he determines that he too will be one; and returns to his mother announcing his intention of at once setting forth into the world to seek for knighthood. Dressed as a peasant (or a fool), he departs (his mother, in some versions, dying of grief), and comes to the king's court. Of course in the romance it is the court of Arthur; probably in the original tale it was simply "the king." Here his uncouth behaviour and great personal beauty attract general attention, and he is alike mocked by Kay, and his future distinction mysteriously foretold. He slays a foe of Arthur's, the Red Knight, who has insulted the king, and challenged the knights of the court, who, for some mysterious reason, are unable to respond to the challenge. Dressing himself in the armour of the slain knight, which he has great difficulty in handling and eventually puts on over his peasant's garb, he sets out on a series of adventures which differ greatly in the various versions, but the outcome of which is that he becomes a skilful and valiant knight and regains the heritage of his father.

This, the Perceval story proper, has been recognized by scholars as a variant of a widespread folk-tale theme, designated by J. C. von Hahn as the *Aryan Expulsion and Return* formula, which counts among its representatives such heroes as Perseus, Cyrus, Romulus and Remus, Siegfried, and, as Alfred Nutt has pointed out, Arthur himself. This particular variant appears to be of British-Celtic origin, and the most faithful representative of the original tale is now very generally held to be the English *Syr Percivelle of Galles*, a poem preserved in the Thornton manuscript. Here the hero is nephew to Arthur on the mother's side, and his father, of the same name as himself, is a valiant knight of the court. A noticeable feature of the story is the uncertainty as to the hero's parentage; the mother is always a lady of rank, a queen in her own right, or sister of kings (as a rule of the Grail kings); but the father's rank varies, he is never a king, more often merely a valiant knight, and in no instance does he appear to be of equal rank with his wife. This distinguishes the story from that of Lancelot, with which some modern scholars have been inclined to identify it; for Lancelot's parentage is never in doubt, he is *fiu du roi*.

The connexion of the story with Arthur and his court brought about a speedy and more important development, the precise steps of which are not yet clear: Perceval became the hero of the Grail quest, in this outing Gawain, to whom the adventure originally belonged, and the Perceval became merged in the Grail tradition. Of the *Perceval-Grail* romances the oldest from the point of view of manuscript preservation is the *Perceval* or *Conte del Graal* of Chrétien de Troyes. Two manuscripts, indeed, the British Museum and Mons texts, preserve a fragment relating the birth and infancy of the hero, which appears to represent the source at the root alike of Chrétien and of the German *Parzival*, but it is only a fragment, and so far no more of the poem has been discovered. Chrétien left his poem unfinished, and we do not know how he intended to complete the adventures of his hero; but those writers who undertook the task, Wauchier de Denain, Gerbert de Montreuil and Manessier, carried it out with such variety of detail, and such a bewildering indifference to Chrétien's version, that it seems practically certain that there must have been, previous to Chrétien's work, more than one poem dealing with the same theme. The German poet, Wolfram von Eschenbach, whose *Parzival* in parts closely agrees with the *Perceval* and who was long held to be a mere translator of Chrétien,

differs widely in the setting of his story. He gives an introduction, in which the adventures of the father, here a prince of Anjou, are related, a conclusion, in which the Swan-Knight, Lohengrin, is made Parzival's son, he represents the inhabitants of the Grail castle as Templars (Templeesen), and makes the Grail itself a stone. Finally, he reproaches Chrétien with having told the story amiss, whereas Kiot, the Provençal, whose version Wolfram was following, had told it aright from beginning to end. It is certain that Gerbert knew, and used, a *Perceval* which, if not Kiot's poem, must have been closely akin to it, as he too makes the Swan-Knight a descendant of the Grail hero. The probability seems to be that the earliest Perceval-Grail romance was composed at Fescamp, and was coincident with the transformation, under the influence of the *Saint-Sang* legend, of the originally Pagan talisman known as the Grail into a Christian relic, and that this romance was more or less at the root of all subsequent versions.

Besides the poems, we have also two prose Perceval romances, the relative position of which has not yet been satisfactorily determined. The first is found in two manuscripts only, the so-called "Didot" (from its original possessor M. Firmin-Didot), now in the Bibliothèque Nationale, Paris, the other, and much superior text, in the Biblioteca Estense, Modena. In both cases the romance follows the prose rendering of Borron's *Joseph of Arimathea* and *Merlin*, and precedes a *Mort Artus*, thus forming part of a complete cycle. The text shows a curious mingling of sources; the real primitive Perceval story, the *Enfances*, is omitted, he grows up in his father's house and goes to court at his wish. Later, however, stories which certainly derive from an early non-Grail tradition are introduced, and there are references which imply a knowledge of the prose *Lancelot* and of Chrétien's poem. The romance is probably a somewhat late, and not very skilful, compilation. The other prose romance, the *Perlesvaus*, is decidedly superior in literary form, but here too we have a mingling of old and new elements. The *Enfances* story is omitted, and there are parallels with the German *Parzival*, with Wauchier de Denain and with Gerbert, while much is peculiar to the *Perlesvaus* itself. It is not improbable that it represents a free and individual working over of the original Fescamp version, and that in its later shape it was intended to form, and did at one time form, the *Quest* section of the cyclic redaction of the Arthurian prose romances, being dislodged from this position by the *Galahad Queste*. It is a curious fact that the printed editions always give it in conjunction with this latter and that the two have also been preserved together in a Welsh manuscript translation. We also possess in one of the so-called *Mabinogi* a Welsh version of the tale, *Peredur, son of Ewrawc*. This appears to be a free rendering of the adventures found in Chrétien combined with incidents drawn from Welsh tradition. This was at one time claimed as the original source of all the Perceval romances, but this theory cannot be maintained in face of the fact that the writer gives in one place what is practically a literal translation of Chrétien's text in a passage which there is strong reason to believe was borrowed by Chrétien from an earlier poem. In order of time the *Peredur* probably ranks latest in the series of Perceval romances, which, however, does not detract from its interest as a possible representative of genuine Welsh traditions, unknown to other writers.

The value and interest of the Perceval romances stand very high, not alone for their intrinsic merit, though that is considerable—Chrétien's *Perceval*, though not his best poem, is a favourable specimen of his work, and von Eschenbach's *Parzival*, though less elegant in style, is by far the most humanly interesting, and at the same time, most deeply spiritual, of the Grail romances—but also for the interest of the subject matter. The Perceval story is an admirable folk-tale, the Grail problem is the most fascinating problem of medieval literature; the two combined form a romance of quite unique charm and interest. This has been practically proved by the extraordinary success which has attended Richard Wagner's dramatic re-telling of the legend in his *Parsifal*. The immediate source of this

version is the poem of Wolfram von Eschenbach, though the Grail, of course, is represented in the form of the Christian relic, not as the jewel talisman of the *Parzival*, but the psychological reading of the hero's character, the distinctive note of von Eschenbach's version, has been adapted by Wagner with marvellous skill, and his picture of the hero's mental and spiritual development, from extreme simplicity to the wisdom born of perfect charity, is most striking and impressive.

BIBLIOGRAPHY—There are early printed editions of the *Perceval* (1530) and of the *Perlesvaus* (1516 and 1523). The *Perceval* was edited from the Mons text by Potvin (6 vols., 1866-1871); *Syr Percyelle of Galles*, in *The Thornton Romances*, by Halliwell (1844) for the Camden Society. *Parzival* exists in numerous editions; critical texts have been edited by Lachmann (1891), Martin (1903) and Leitzmann (1902-1903). For the general reader the most useful text is that of Bartsch in *Deutsche Classiker des Mittelalters*, as it includes notes and a glossary. Modern German versions are by Simrock (very close to the original) and Hertz (freer, but with excellent notes and appendices); Eng. trans. by J. L. Weston (1894). The "Didot" *Perceval* was published by Lucher in vol. I. of *Le Saint Graal* (1875-1878); an edition of the Molien text has also been prepared. *Perlesvaus* was published by Potvin in vol. I. of his edition of Chrétien's poem. The Welsh text, with translation, has been edited by Canon Williams. A fine translation by Dr Sebastian Evans is published in "The Temple Classics," under the title of *The High History of the Holy Grail*. *Peredur* will be found in Alfred Nutt's edition of the *Mabinogion* (1902). For the critical treatment of the subject see *The Legend of Sir Perceval* (Grimm Library, vol. xvii.); *Perlesvaus* by Nitze (1902); *Legends of the Wagner Drama* by J. L. Weston. (J. L. W.)

PERCEVAL, SPENCER (1762-1812), prime minister of England from 1809 to 1812, second son of John, 2nd earl of Egmont, was born in Audley Square, London, on the 1st of November 1762. He was educated at Harrow and at Trinity College, Cambridge, and was called to the bar at Lincoln's Inn in 1786. A very able speech in connexion with a famous forgery case having drawn attention to his talents, his success was from that time rapid, he was soon regarded as the leading counsel on the Midland circuit, and in 1796 became a K.C. Entering parliament for Northampton in April of that year, he distinguished himself by his speeches in support of the administration of Pitt. In 1801, on the formation of the Addington administration, he was appointed solicitor-general, and in 1802 he became attorney-general. An ardent opponent of Catholic Emancipation, he delivered in 1807 a speech on the subject which helped to give the deathblow to the Grenville administration, upon which he became chancellor of the exchequer under the duke of Portland, whom in 1809 he succeeded in the premiership. Notwithstanding that he had the assistance in the cabinet of no statesman of the first rank, he succeeded in retaining office till he was shot by a man named Bellingham, a bankrupt with a grievance, who had vainly applied to him for redress, in the lobby of the House of Commons on the 11th of May 1812. Bellingham was certainly insane, but the plea was set aside and he was hanged. Perceval was a vigorous debater, specially excelling in replies, in which his thorough mastery of all the details of his subject gave him a great advantage. He married in 1790 and had six sons and six daughters; one of the latter married Spencer Horatio Walpole (d. 1898), home secretary, and their son Sir Spencer Walpole, the well-known historian, published an excellent biography of Perceval in 1874.

See also P. Treherne, *Spencer Perceval* (1909).

PERCH (through Fr. from Lat. *perca*, Gr. *πέρα*; the last word is connected with *περαός*, dark-coloured, spotted), a fresh-water fish (*Perca fluviatilis*), generally distributed over Europe, northern Asia and North America, and so well known as to have been selected for the type of an entire family of spiny-rayed fishes, the *Percidae*, which is represented in European fresh-waters by several other fishes such as the pike (*Acerina cernua*) and the pike-perch (*Lucioperca*). It inhabits rivers as well as lakes, but thrives best in waters with a depth of not less than 3 ft.; in large deep lakes it frequently descends to depths of 50 fathoms and more. It occurs in Scandinavia as far north as the 69th parallel, but does not extend to Iceland or any of the islands north of Europe. In the Alps it ascends to an altitude of 4000 ft.

The shape of its body is well proportioned, but many variations occur, some specimens being singularly high-backed, others low and long-bodied, sometimes such variations are local, and Agassiz and other naturalists at one time thought it possible to distinguish two species of the common perch of Europe, there are not even sufficient grounds, however, for separating specifically the North-American form, which in the majority of ichthyological works is described as *Perca flavescens*. The brilliant and striking colours of the perch render it easily recognizable even at a distance. A rich greenish-brown with golden reflections covers the back and sides, which are ornamented with five or seven dark cross-bands. A large black spot occupies the

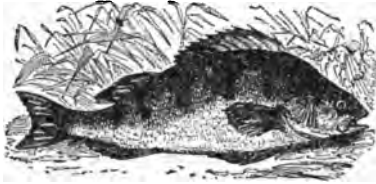

The Perch, *Perca fluviatilis*.

membrane between the last spines of the dorsal fin; and the ventral, anal and lower part of the caudal are bright vermilion. In the large peaty lakes of north Germany a beautiful variety is not uncommon, in which the golden tinge prevails, as in a goldfish.

The perch is strictly carnivorous and most voracious; it wanders about in small shoals within a certain district, playing sad havoc among small fishes, and is therefore not to be tolerated in waters where valuable fry is cultivated. Perch of three pounds in weight are not infrequently caught in suitable localities; one of five would now be regarded as an extraordinarily large specimen, although in older works we read of individuals exceeding even that weight.

Perch are good, wholesome food, and highly esteemed in inland countries where marine fish can be obtained only with difficulty. The nearly allied pike-perch is one of the best European food-fishes. The perch is exceedingly prolific; it begins to spawn when three years old, in April or in the first half of May, depositing the ova, which are united by a viscid matter in lengthened or net-shaped bands, on water plants.

PERCH (through Fr. *perche* from Lat. *perca*, a pole or rod used for measurement), a bar or rod used for various purposes, as e.g. for a navigation mark in shallow waters, for a support on which a bird may rest, or for a pole which joins the back with the fore part of a wagon or other four-wheeled vehicle. As a term of linear measurement, "perch," also "rod" or "pole," = 16½ ft., 5½ yds.; of superficial area, = 30½ sq. yds.; 160 perches = 1 acre. As a stonemason's measure, a "perch" = 1 linear perch in length by 1½ ft. in breadth and 1 ft. in thickness.

PERCHE, a region of northern France extending over the departments of Orne, Eure, Eure-et-Loir and Sarthe. Its boundaries are Normandy on the N. and W., Maine on the S.W., Vendômois and Dunois on the S., Beaugo on the E. and Thimerais on the N.E. The greater part of the district is occupied by a semicircle of heights (from 650 to 1000 ft. in height) stretching from Moulins-la-Marche on the north-west to Montmirail on the south; within the basin formed thereby the shape of which is defined by the Huisne, an affluent of the Sarthe, lie the chief towns—Mortagne, Nogent-le-Rotrou and Bellême. Stock-raising and dairy-farming are flourishing in the Perche, which is famous for the production of a breed of large and powerful horses. Cider-apples and pears are grown throughout the district. In the middle ages the Perche constituted a countship of which Corbon, Mortagne and Nogent-le-Rotrou were successively the capitals. Under the *ancien régime* it formed, together with Maine, a *gouvernement* of which Mortagne was the capital.

PERCIVAL, JAMES GATES (1795-1856), American poet, philologist and geologist, was born in Kensington parish, Berlin, Connecticut, on the 15th of September 1795. He graduated

at Yale in 1815, and in 1820 took the degree of M.D., and started practice in Berlin. He contributed verse to the *Microscope*, a semi-weekly paper, founded at New Haven in 1820. In this first appeared his best-known poem, "The Suicide," which reflects his chronic melancholy, due doubtless to ill-health; it was begun in 1816 and finished in 1820, after he had actually made two attempts on his own life. In 1823 Percival became an editor of the *Connecticut Herald* at New Haven, and in 1824 he was in turn an assistant-surgeon and lecturer on chemistry at West Point, and an inspector of recruits at the Charlestown (Mass.) Navy Yard. He prepared (1826-1831) an English edition of Malte-Brun's *Geography* (published 1834), and in 1827-1829 read the manuscripts and proof-sheets of *Webster's Dictionary*, giving special attention to scientific words. In 1835-1840, with Professor Charles U. Shepard (1804-1886), he made a geological survey of Connecticut, his *Report* (1842) showed great learning and much patient research. In 1854 he became state geologist of Wisconsin, and in 1855 published one volume of his *Report*, the second he had nearly completed at the time of his death, on the 22nd of May 1856, at Hazel Green, Wisconsin.

See his *Poetical Works* (2 vols. Boston, 1859), with a biographical sketch by L. W. Fitch, and Julius H. Ward, *Life and Letters of James Gates Percival* (Boston, 1866).

PERCY (FAMILY). This family, whose deeds are so prominent in English history, was founded by William de Perce (c. 1030-1096), a follower of the Conqueror, who bestowed on him a great fief in Yorkshire and Lincolnshire. The register of Whithy Abbey, which he founded anew, and in later days the heralds, were responsible for the fabulous origin and pedigree of the family which are still current. By Emma, daughter of Hugh de Port, a great Hampshire baron, William was father of several sons, of whom Alan the eldest succeeded him. His grandson William was the last of the house in the direct line, and left two sisters and coheresses, Maud countess of Warwick, who died childless, and Agnes. Agnes de Perce had married Josceline, styled "brother of the queen" (i.e. Adeliza of Louvain, second wife of Henry I.), whose legitimacy has been questioned, and from this marriage descended the second house of Percy (which name it assumed), till its own extinction in the male line five centuries later (1670). By it was brought into the family the great Petworth estate in Sussex, which Josceline had obtained from his sister, who was holding Arundel and its fief. His son Richard (c. 1170-1244) and Richard's nephew William (c. 1183-1245) were among the barons who rose in arms against John, but the latter made his peace with Henry III., and had his lands restored to him. Richard de Percy was one of the twenty-five barons appointed to enforce the observance of Magna Carta.

The next important member of the family is William's grandson Henry de Percy (c. 1272-1315), whom Edward I., after the deposition of John Baliol, appointed governor of Galloway, and who was one of his most active agents in the subjugation of Scotland till the success of Robert Bruce drove him out of Turnberry Castle, and made him withdraw into England. He was rewarded by Edward II. with the barren title of earl of Carrick, declared to be forfeited by the Scottish hero; and the same king appointed him governor of the castles of Bamburgh and Scarborough. But in 1309 he himself made his position strong in the north of England by purchasing lands from Anthony Bek, bishop of Durham, among which was the honour of Alnwick, the principal seat of the family ever since. The Percies had chiefly resided till then at Spofforth in Yorkshire, and their connexion with Northumberland dates from this acquisition. Henry's son, another Henry (c. 1299-1352), took part in the league against Edward II.'s favourites the Despencers, was in favour with Edward III., and obtained from Edward Baliol as king of Scotland grants of Lochmaben, Annandale and Moffatdale, which he surrendered to the English king for the castle and constableness of Jedburgh, or Jedworth, with the forest of Jedworth and some neighbouring towns. A few years later, in fuller recompense of the unprofitable gift of Baliol, a grant of 500 marks a year was made to him out of the old customs at Berwick.

and in 1346 he did splendid service to his sovereign by defeating and taking prisoner David II, king of Scotland, at the battle of Neville's Cross.

To him succeeded another Henry Percy (1322-1368), a feudal baron-like his predecessors, who fought at Crécy during his father's lifetime and whose brother Thomas Percy (1333-1369) was bishop of Norwich from 1356-1369. The next head of the Percys was Henry's son, another Henry, who was made earl of Northumberland at the coronation of Richard II, and whose younger brother Thomas (d. 1403) was created earl of Worcester in 1397. The 1st earl of Northumberland, father of the famous Hotspur, Sir Henry Percy (q.v.), was killed at Bramham Moor in 1408, while in arms against the king, and his title and estates were forfeited. But, by an act no less gracious than politic, Henry V. restored them in 1414 to this earl's grandson, Henry (1394-1455), then a prisoner with the Scots, whose liberation he had no difficulty in procuring from the duke of Albany during the time of James I.'s captivity. From that day the loyalty of the family to the house of Lancaster was steadfast and undeviating. The 2nd earl died fighting for Henry VI. at the first battle of St Albans in 1455; the 3rd, Henry (1421-1461), was slain on the bloody field of Towton; the 4th, Henry (1446-1480), was killed in quelling an insurrection in the time of Henry VII. So strong was the Lancastrian feeling of the family that even Sir Ralph Percy (1475-1464), a brother of the earl who fell at Towton, though he had actually submitted once to Edward IV., turned again, and when he fell at Hodgley Moor in April 1464 consoled himself with the thought that he had, as he phrased it, "saved the bird in his bosom."

No wonder, then, that in Edward IV.'s days the title and estates of the family were for a time taken away and given to John Neville Lord Montagu, brother of Warwick the king-maker. But the north of England was so accustomed to the rule of the Percys that in a few years Edward saw the necessity of restoring them, and did so even at the cost of alienating still further the powerful family of the Nevilles, who were then already on the point of rebellion.

A crisis occurred in the fortunes of the family in the reign of Henry VIII. on the death of Henry, the 6th earl (s. 1502-1537), whose brothers Sir Thomas and Sir Ingelram Percy, much against his will, had taken part in the great insurrection called the Pilgrimage of Grace. A thriftless man, of whom it is recorded that in his youth he was smitten with the charms of Anne Boleyn, but was forced to give her up and marry a woman he did not love, he died childless, after selling many of the family estates and granting the others to the king. The title was forfeited on his death, and was granted by Edward VI. to the ambitious John Dudley, earl of Warwick, who was attainted in the succeeding reign. It was restored in the days of Queen Mary to Thomas Percy (1528-1572), a nephew of the 6th earl, who, being a staunch Roman Catholic, was one of the three earls who took the lead in the celebrated rising of 1572, and was beheaded at York. His brother Henry (s. 1532-1585), who succeeded him, was no less unhappy. Involved in Throgmorton's conspiracy, he was committed to the Tower of London, and was supposed to have shot himself in bed with a pistol found beside him; but there were grave suspicions that it had been discharged by another hand. His son, Henry (1567-1632), the next earl, suffered like his two predecessors for his attachment to the religion of his forefathers. The Crown lawyers sought in vain to implicate him in the Gunpowder Plot, but he was imprisoned for fifteen years in the Tower and compelled to pay a fine of £30,000. Algernon (1602-1668), the son who next succeeded, was a parliamentary general in the Civil War. At length, in 1670, the male line of this illustrious family became extinct, at least in the direct line, about five hundred years after the marriage of Agnes de Percy with Josceline of Louvain.

The representation of the earlier Percys had passed away through the daughters of Earl Thomas, beheaded in 1572, but his earldom of Northumberland (created anew for him in 1557) had passed to his brother Henry, under a special remainder, and appears to have become extinct in 1670, though persistently

claimed by James Percy, "the trunk-maker." The last earl's daughter Elizabeth, a great heiress, was mother by Charles Seymour, 6th duke of Somerset, of Algernon, 7th duke, who was summoned (in error) as Lord Percy in 1722 and created earl of Northumberland in 1749. On the duke's death in 1750 his earldom of Northumberland passed under a special remainder, with the main inheritance of the Percys, to Sir Hugh Smithson, bart. (1715-1786), who had married his daughter and eventual heiress in 1740, and was created duke of Northumberland and Earl Percy in 1766. From this marriage descends the present ducal house, which bears the name of Percy in lieu of Smithson, and owns vast estates in Northumberland.

Alnwick Castle, their chief seat, where much state is still kept up, has been described by Mr Clark as "probably the finest extant example of a Norman castle of this type, having an open keep and a complete encinte." It had been hardly occupied and in decay for some two centuries when the present family succeeded to it, but was restored by them to its former splendour between 1750 and 1786. "Princely Petworth," however, the seat of the later Percys, with their ancient Sussex estates and those in Yorkshire (Leconfield) and Cumberland (Cockermouth), all passed away in 1750 with the earldom of Egremont and barony of Cockermouth to Charles Wyndham, nephew of the 7th duke of Somerset, and these estates are now held by Lord Leconfield. The actual representation in blood of the later Percys (i.e. from 1572) passed in 1865, on the death of the 4th duke, to the dukes of Atholl, who in virtue of it are Lords Percy, under the writ of 1722, the oldest of the family titles now remaining. The ancient London residence of the Percys, Northumberland House, Charing Cross, was removed to make way for Northumberland Avenue. Above it stood the Percy crest, a (blue) lion with stiffly extended tail; but the famous badge of the house was the white crescent or half moon—"the Half-Moon shining all aoe fair" of "the Northern Rising" ballad—with a pair of manacles. Their coat of arms was a blue lion rampant on a yellow ground—"Jaune o un bleu lyon rampant" of the Carlawerock roll, stated, but wrongly, to have been derived from the dukes of Louvain and Brabant. With it they quartered the "Lucas" coat of the Lucys of Cockermouth after succeeding to their estates, whence the lines in *The Bulls of Otterbourne*:—

"The Lucetts and the Crésnants both,

The Skotts fought them agayne."

See E. B. De Fonblanque, *Annals of the House of Percy* (1887), and G. Brennan, *History of the House of Percy* (edited by W. A. Landsay, 1902), both somewhat adulatory and needing critical revision; T. F. B. *History of Alnwick* (1866); Hartshorn's paper on the Percys and their Castles in the Newcastle volume of the *Archæological Institute* (1852); E. A. Freeman, "The Percy Castles" (1875) in *English Towns and Districts*; G. T. Clark, *Medieval Military Architecture* (1884); G. E. C. (okayne), *Complete Peerage* (1895), vol. vi.; Bishop Percy, *Northumberland Household Book*. See also the article *Northumberland, Earls and Dukes of*. (J. Ga.; J. H. R.)

PERCY, SIR HENRY, called **HOTSPUR** (1364-1403), eldest son of Henry, 1st earl of Northumberland, was born on the 20th of March 1364. He saw active service when he was fourteen at the siege of Berwick. Six years later he was associated with his father in the wardenship of the eastern march of Scotland, and his zeal in border warfare won the name of Hotspur for him from his opponents. In 1386 he was sent to Calais, and raided French territory, but was shortly afterwards recalled to defend England against a naval attack by France. In popular story and ballad he is known as one of the heroes of Otterburn or Chevy Chase, which is the subject of one of the most stirring recitals of Froissart. In the summer of 1388 the Scots invaded England by way of Carlisle, sending a small body under the earls of Douglas, Mar and Moray to invade Northumberland. The earl of Northumberland remained at Alnwick, but sent his sons Sir Henry and Sir Ralph against the enemy. In hand-to-hand fighting before the walls of Newcastle, Douglas is said to have won Sir Henry's pennon, which he swore to fix upon the walls of Dalkeith. The Scots then retreated to Otterburn, where Percy, who was bent on recovering his pennon, attacked them on a fine August evening in 1388. Douglas was

slain in the battle, though not, as is stated by Walsingham, by Percy's hand: Henry Percy was captured by Sir John Montgomery, and his brother Ralph by Sir John Maxwell. Hotspur was released on the payment of a heavy ransom, to which Richard II. contributed £3000, and in the autumn his term as warden of Carlisle and the West March was extended to five years. In 1399 together with his father he joined Henry of Lancaster. Henry IV. gave the charge of the West March to Northumberland, while Henry Percy received the castles of Bamburgh, Roxburgh and Berwick, and the wardenship of the East March, with a salary of £3000 in peace time and £12,000 in war. During the first year of Henry's reign Hotspur further was appointed justiciar of North Wales and constable of the castles of Chester, Flint, Conway, Denbigh and Carnarvon. Henry also gave him a grant of the island of Anglesey, with the castle of Beaumaris. William and Rees ap Tudor captured Conway Castle on the 1st of April 1401, and Percy in company with the prince of Wales set out to recover the place, Percy providing the funds. In May he reported to the king the pacification of Merioneth and Carnarvon, and before the end of the month Conway was surrendered to him. Meanwhile he wrote demanding arrears of pay, with the threat of resignation if the money were not forthcoming, but the king intimated that the loss of Conway had been due to his negligence, and only sent part of the money. He had the same difficulty in obtaining money for his northern charge that he had experienced in Wales.¹ Anglesey was taken from him, and he was deprived of Roxburgh Castle in favour of his rival, the earl of Westmorland. The Scots again invaded England in the autumn of 1402, headed by the earl of Douglas and Murdoch Stewart, son of the duke of Albany. Northumberland and Hotspur barred their way at Millfield, near Wooler, and the Scots were compelled to fight at Humberdon, or Homildon Hill, on the 14th of September. The English archers were provided with a good target in the masses of the Scottish spearmen, and Hotspur was restrained from charging by his ally, George Dunbar, earl of March. The Scottish army was almost destroyed, while the English loss is said to have been five men. Disputes with the king arose over the disposal of the Scottish prisoners, Percy insisting on his right to hold Douglas as his personal prisoner, and he was summoned to court to explain. It is related that when he arrived Henry asked for Douglas, and Hotspur demanded in return that his brother-in-law, Edmund Mortimer, should be allowed to ransom himself from Owen Glendower, with whom he was a prisoner. High words followed, in the course of which Henry called Percy a traitor, struck him on the face, and drew his sword on him. Percy is said to have answered this defiance with the words, "Not here, but on the field." This was late in 1402, and in 1403 Hotspur issued a proclamation in Cheshire stating that Richard II. was alive, and summoning the inhabitants to his standard. He made common cause with his prisoner Douglas, and marched south to join forces with Glendower, who was now reconciled with Mortimer. He was reinforced by his uncle Thomas, earl of Worcester, who, although steward to the household of the prince of Wales, joined his family in rebellion. The mythical Richard II. was heard of no more, and Percy made himself the champion of the young earl of March. When he arrived at the Castle Foregate, Shrewsbury, early on the 21st of July, and demanded provisions, he found the king's forces had arrived before him. He retired in the direction of Whitchurch, and awaited the enemy about 3½ m. from Shrewsbury. After a long parley, in which a truce of two days was even said to have been agreed on, the Scottish earl of March, fighting on the royal side, forced on the battle in the afternoon, the royal right being commanded by the prince of

¹ The dissatisfaction of the Percys seems to have been chiefly due to the money question. Sir J. H. Ramsay (*Lancaster and York*) estimates that in the four years from 1399 to 1403 they had received from the king the sum of £41,750, which represented a very large capital in the 14th century, and they had also received considerable grants of land. King Henry IV. was about to march north himself to look into the real relations between the Percys and the Scots, when on the 6th of July 1403 Henry Percy was in open rebellion.

Wales. Hotspur was killed, the earls of Douglas and Worcester, Sir Richard Venables of Kinderton, and Sir Richard Vernon were captured, and the rebel army dispersed. Worcester, Venables and Vernon were executed the next day. Percy's body was buried at Whitchurch, but was disinterred two days later to be exhibited in Shrewsbury. The head was cut off, and fixed on one of the gates of York.

See NORTHUMBERLAND, EARLS AND DUKES OF; and PERCY: (*Family*). Also *Chronique de la traison et mort de Richard II.*, ed. B. Williams (Eng. Hist. Soc., 1846); J. Creton, *Histoire du roy Richard II.*, ed. John Webb, in *Archæologia* (xx, 1824); and Adam of Usk's *Chronicon*, 1377-1404, ed. E. M. Thompson (1876); the authorities are cited in detail in J. H. Wylie's *England under Henry IV.* (1884-1898), and Sir J. H. Ramsay's *Lancaster and York* (Oxford, 1892). Holinshed's *Chronicle* was the chief source of Shakespeare's account of Hotspur in *Henry IV.*

PERCY, THOMAS (c. 1560-1605), one of the Gunpowder Plot conspirators, was a son of Edward Percy of Beverley, who was grandson of Henry Percy, 4th earl of Northumberland. Though brought up a Protestant, he early became well-affected to the Roman Catholics and finally an adherent. He entered the service of his cousin, Henry Percy, 9th earl of Northumberland, and was appointed by him constable of Alnwick Castle and agent for his northern estates, in which capacity he showed himself tyrannical and extortionate. In 1602 he was sent by Northumberland to James in Scotland to secure toleration for the Roman Catholics and returned announcing favourable promises from the king, the extent of which he probably greatly exaggerated; and when James, after his succession to the English throne, did not immediately abrogate the penal laws, Percy, although he had accepted the court appointment of gentleman pensioner, professed himself highly indignant and indulged himself in thoughts of revenge. Some time in May 1603 Percy angrily declared his intention to Catesby of killing the king, and in April 1604 he met Catesby with John Wright, Thomas Winter and Guy Fawkes, and was then initiated into Catesby's gunpowder plot, which met with his zealous approval and support. To Percy was allotted the special duty after the explosion of seizing the infant prince Charles and riding off with him on his saddle to Warwickshire. All the preparations being complete, Percy went to Alnwick in October and collected £3000 of the earl of Northumberland's rents which he intended using in furtherance of the plot, returning to London on the 1st of November. Meanwhile the plot had been revealed through the letter to Lord Montague on the 26th of October, and it was Percy's insistence at the last meeting of the conspirators on the 3rd that decided them not to fly but to hazard the attempt. On the news of Guy Fawkes's arrest, Percy with the rest of the conspirators, except Tresham, fled on horseback, taking refuge ultimately at Holbeche, near Stourbridge, in Staffordshire, where on the 8th of November, during the attack of the sheriff's men upon the house, he was struck down by a bullet, fighting back to back with Catesby, and died two days later. Percy married a sister of the conspirator John Wright and left a son Robert and two daughters, one of whom is said to have married Robert, the son of Catesby.

PERCY, THOMAS (1729-1811), bishop of Dromore, editor of the *Percy Reliques*, was born at Bridgnorth on the 13th of April 1729. His father, Arthur Lowe Percy, a grocer, was of sufficient means to send his son to Christ Church, Oxford, in 1746. He graduated in 1750 and proceeded M.A. in 1753. In the latter year he was appointed to the vicarage of Easton Maudit, Northamptonshire, and three years later was instituted to the rectory of Wilby in the same county, benefices which he retained until 1782. In 1759 he married Anne, daughter of Barton Gutteridge. At Easton Maudit most of the literary work for which he is now remembered—including the *Reliques*—was completed. When his name became famous he was made domestic chaplain to the duke and duchess of Northumberland, and was tempted into the belief that he belonged to the illustrious house of Percy. Through his patron's influence he became dean of Carlisle in 1778 and bishop of Dromore in Ireland in 1782. His wife died before him in 1806; the good bishop, blind but otherwise in

sound health, lived until the 30th of September 1811. Both were buried in the transept which Percy added to Dromore Cathedral.

Dr Percy's first work was a translation from a Portuguese manuscript of a Chinese story, published in 1761. Two years later he published *Five Pieces of Runic Poetry, translated from the Icelandic*. In 1763 he edited the earl of Surrey's poems with an essay on early blank verse, translated the Song of Solomon, and published a key to the New Testament. His *Northern Antiquities* (1770) is a translation from the French of Paul Henri Mallet. His reprint of *The Household Book of the Earl of Northumberland in 1512* is of the greatest value for the illustrations of domestic life in England at that period. But these works are of little estimation when compared with the *Reliques of Ancient English Poetry* (1765). This was based on an old manuscript collection of poetry, rescued by Percy in Humphrey Pitt's house at Shifnal, Shropshire, from the hands of the housemaid who was about to throw the fire with it. The manuscript was edited in its complete form by J. W. Hales and F. J. Furnivall in 1867-1868.

See A. C. C. Gausson, *Percy: Prelate and Poet* (1908). The *Reliques* has been edited by various hands, notably by H. B. Wheatley (1876). The fourth edition was by Percy's nephew, Thomas Percy (1768-1808), himself a writer of verse.

PERDICCAS, the name of three kings of Macedonia, who reigned respectively c. 700 B.C., c. 454-413 B.C., and 364-359 B.C., and of one of Alexander the Great's generals, son of Orontes, a descendant of the independent princes of the province of Orestis. The last named distinguished himself at the conquest of Thebes (335 B.C.), and held an important command in the Indian campaigns of Alexander. In the settlement made after Alexander's death (323) it was finally agreed that Philip Arrhidaeus, an insane son of the great Philip, and Roxana's unborn child (if a son) should be recognized as joint kings, Perdiccus being appointed, according to one account, guardian and regent, according to another, chiliarch under Craterus. He soon showed himself intolerant of any rivals, and acting in the name of the two kings (for Roxana gave birth to a son, Alexander IV.) sought to hold the empire together under his own hand. His most loyal supporter was Eumenes, governor of Cappadocia and Paphlagonia. These provinces had not yet been conquered by the Macedonians, and Antigonus (governor of Phrygia, Lycia and Pamphylia) refused to undertake the task at the command of Perdiccus. Having been summoned to the royal presence to stand his trial for disobedience, Antigonus fled to Europe and entered into alliance with Antipater, Craterus and Ptolemy, the son of Lagos. Perdiccus, leaving the war in Asia Minor to Eumenes, marched to attack Ptolemy in Egypt. He reached Pelusium, but failed to cross the Nile. A mutiny broke out amongst the troops, disheartened by failure and exasperated by his severity, and Perdiccus was assassinated by some of his officers (321). (E. R. B.)

See MACEDONIAN EMPIRE.

PEREDA, JOSÉ MARÍA DE (1833-1906), one of the most distinguished of modern Spanish novelists, was born at Polanco near Santander on the 6th of February 1833. He was educated at the Instituto Cántabro of Santander, whence he went in 1852 to Madrid, where he studied with the vague purpose of entering the artillery corps. Abandoning this design after three years' trial, he returned home and began his literary career by contributing articles to a local journal, *La Abeja montañesa* in 1858. He also wrote much in a weekly paper, *El Tío Cayetano*, and in 1864 he collected his powerful realistic sketches of local life and manners under the title of *Escenas montañesas*. Pereda fought against the revolution of 1868 in *El Tío Cayetano*, writing the newspaper almost single-handed. In 1871 he was elected as the Carlist deputy for Cabañiga. In this same year he published a second series of *Escenas montañesas* under the title of *Tipos y paisajes*; and in 1876 appeared *Bocetos al temple*, three tales, in one of which the author describes his disenchanting political experience. The *Tipos trashumantes* belongs to the year 1877, as does *El Bury sueño*, which was intended as a reply

to the thesis of Balzac's work, *Les Petites misères de la vie conjugale*. More and more pessimistic as to the political future of his country, Pereda took occasion in *Don Gonzalo González de la Gonzalezera* (1879) to ridicule the Revolution as he had seen it at work, and to pour scorn upon the *nouveaux riches* who exploited Liberalism for their personal ends. Two novels by his friend Pérez Galdós, *Doña Perfecta* and *Gloria*, drew from Pereda a reply, *Do Tal palo tal astilla* (1880), in which he endeavours to show that tolerance in religious matters is disastrous alike to nations and to individuals. *The Esbozos y rasguños* (1881) is of lighter material, and is less attractive than *El Sabar, de la Tierruca* (1882), a striking piece of landscape which won immediate appreciation. New ground was broken in *Pedro Sánchez* (1883), where Pereda leaves his native province to portray the disillusion of a sincere enthusiast who has plunged into the political life of the capital. Pereda's masterpiece is *Sotileza* (1884), a vigorous rendering of marine life by an artist who perceives and admires the daily heroisms of his fisher-folk. It has often been alleged against the author that he confines himself to provincial life, to lowly personages and to unrefined subjects, and no doubt an anxiety to clear himself from this absurd reproach led him to attempt a description of society at the capital in *La Montañesa* (1888), which is certainly the least interesting of his performances. In *La Puchera* (1889) he returned to the marine subjects which he knew and loved best. Again, in *Peñas arriba* (1895), the love of country life is manifested in the masterly contrast between the healthy, moral labour of the fields and the corrupt, squalid life of cities. Pereda's fame was now established; the statutes of the Spanish Academy, which require members to reside at Madrid, were suspended in his favour (1896). But his literary career was over. The tragic death of his eldest son, the disastrous campaign in Cuba and the Philippines, darkened his closing years, and his health failed long before his death at Polanco on the 1st of March 1906.

Pereda belongs to the native realistic school of Spain, which, founded by the unknown author of *Lasarillo de Tormes*, was continued by Metejo Alemán, Cervantes, Quevedo, Castillo Solórzano and many others. With the single exception of Cervantes, however, the picaresque writers are almost entirely wanting in the spirit of generous sympathy and tenderness which constitutes a great part of Pereda's charm. His realism is purely Spanish, as remote from Zola's moroseness as from the graceful sentimentality of Pierre Loti. Few 19th-century writers possessed the virile temperament of Pereda, and, with the single exception of Tolstoy, none kept a moral end more steadily in view. This didactic tendency unquestionably injures his effects. Moreover, his grim satire occasionally degenerates into somewhat truculent caricature, and the excessive use of dialect and technical terms (which caused him to supply *Sotileza* with a brief vocabulary) is a grave artistic blemish. But he saw, knew, understood character; he created, not only types, but living personages, such as Andrés, Cleto and Muergo in *Sotileza*, Pedro Juan and Pilara in *La Puchera*; and he personified the tumult and calm of the sea with more power than Victor Hugo displayed in *Les Travailleurs de la mer*. His descriptive powers were of the highest order, and his style, pure of all affectations and embellishments, is of singular force and suppleness. With all his limitations, he was as original a genius as Spain produced during the 19th century. (J. F. K.)

PÈRE DAVID'S DEER, the *mi-lou* of the Chinese, an aberrant and strangely mule-like deer (*q. n.*), the first evidence of whose existence was made known in Europe by the Abbé (then Père) David, who in 1865 obtained the skin of a specimen from the herd kept at that time in the imperial park at Peking. This skin, with the skull and antlers, was sent to Paris, where it was described in 1866 by Professor Milne-Edwards. In lacking a brow-tine, and dividing in a regular fork-like manner some distance above the burr, the large and cylindrical antlers of this species conform to the general structural type characteristic of the American deer. The front prong of the main fork, however,

curves somewhat forward and again divides at least once; while the hind prong is of great length undivided, and directed backwards in a manner found in no other deer. As regards general form, the most distinctive feature is the great relative length of the tail, which reaches the hocks, and is donkey-like rather than deer-like in form. The head is long and narrow, with a prominent ridge for the support of the antlers, moderate-sized ears, and a narrow and pointed muzzle. A gland and tuft are present on the skin of the outer side of the upper part of the hind cannon-bone; but, unlike American deer, there is no gland on the inner side of the hock. Another feature by which this species differs from the American deer is the conformation of the bones of the lower part of the fore-leg, which have the same structure as in the red deer group. The coat is of moderate length, but the hair on the neck and throat of the old stags is elongated to form a mane and fringe. Although new-born fawns are spotted, the adults are in the main uniformly coloured; the general tint of the coat at all seasons being reddish tawny with a more or less marked tendency to grey. It has been noticed at Woburn Abbey that the antlers are shed and replaced twice a year.

The true home of this deer has never been ascertained, and probably never will be; all the few known specimens now living being kept in confinement—the great majority in the duke of Bedford's park at Woburn, Bedfordshire. (R. L.)

PEREGRINUS PROTEUS (2nd cent. A.D.), Cynic philosopher, of Parium in Mysia. At an early age he was suspected of parricide, and was obliged to leave his native place. During his wanderings he reached Palestine, where he ingratiated himself with the Christian community, and became its virtual head. His fanatical zeal and craving for notoriety led to his imprisonment, but the governor of Syria let him go free, to prevent his posing as a martyr. He then returned to Parium to claim his paternal inheritance, but finding that the circumstances of his father's death were not yet forgotten, he publicly surrendered all claims to the property in favour of the municipality. He resumed his wandering life, at first assisted by the Christians, but having been detected profaning the rites of the Church, he was excommunicated. During a visit to Egypt he made the acquaintance of the famous Cynic Agathobulus and joined the sect. Meeting with little encouragement, he made his way to Rome, whence he was expelled for insulting the emperor Antoninus Pius. Crossing to Greece, he finally took up his abode at Athens. Here he devoted himself to the study and teaching of philosophy, and obtained a considerable number of pupils, amongst them Aulus Gellius, who speaks of him in very favourable terms. But, having given offence by his attacks on Herodes Atticus and finding his popularity diminishing, he determined to create a sensation. He announced his intention of immolating himself on a funeral pyre at the celebration of the Olympian games in 165, and actually carried it out. Lucian, who was present, has given a full description of the event.

C. M. Wieland's *Gekörnte Geschichte des Philosophen Peregrinus Proteus* (Eng. trans., 1796) is an attempt to rehabilitate his character. See also Lucian, *De morte Peregrini*; Aulus Gellius xii. 11; Ammianus Marcellinus xxix. Philostratus, *Vit. Sophist.* ii. 1, 33; J. Bernays, *Lucian und die Kyniker* (1875); E. Zeller, "Alexander und Peregrinus," in *his Vorlesungen und Abhandlungen*, ii. (1877).

PEREIRE [PEREIRA], **GIACOBBO RODRIGUEZ** (1715-1780), one of the inventors of deaf-mute language, a member of a Spanish-Jewish family, was born at Estremadura, Spain, on the 11th of April 1715. At the age of eighteen he entered a business at Bordeaux. Here he fell in love with a young girl who had been dumb from birth, and henceforth devoted himself to discover a method of imparting speech to deaf-mutes. His first subject was Aaron Baumann, a co-religionist, whom he taught to enunciate the letters of the alphabet, and to articulate certain ordinary phrases. He next devised a sign alphabet for the use of one hand only, and in 1740 he brought his second pupil before the Paris Academy of Sciences, the members of which were astonished at the results he had accomplished. In 1759 Pereire was made a member of the Royal Society of London. He died at Paris on the 15th of September 1780.

PEREKOP, a town of Russia, in the government of Taurida; 60 m. S.E. of Kherson, on the isthmus which connects the Crimea with the Continent, and commanding the once defensive ditch and dike which cross from the Black Sea to the Sivash (putrid) lagoon. Pop. about 5000. It was formerly an important place, with a great transit trade in salt, obtained from salt lakes in the immediate neighbourhood. Since the opening of the railway route from Kharkov to Simferopol in the Crimea Perekop has greatly declined. In ancient times the isthmus was crossed (about 1½ m. south of the present town) by a ditch which gave the name of Taphros to a Greek settlement. This line of defence having fallen into decay, a fort was erected and a new ditch and dike constructed in the 15th century by the Tatar khan of the Crimea, Mengli Ghirai, and by his son and successor Sahib Ghirai. The fort, known as Kapu or Or-Kapu, became the nucleus of the town. In the middle ages Perekop was known as Tuzia. In 1736 it was captured by the Russians under Münnich, and again in 1738 under Lasey (Lacy), who blew up the fort and destroyed a great part of the dike. In 1754 the fort was rebuilt by Krim Ghurei; but the Greek and Armenian inhabitants of Perekop formed a new settlement at Armyanskiy Bazar (Armenian Market), 3 m. farther south. Captured by the Russians in 1771, the town passed into Russian possession with the rest of the Crimea in 1783.

PEREMPTORY, an adjective adapted from the Roman law term *peremptorium edictum*, *peremptoria exceptio*, a decree or plea which put an end to or quashed (Lat. *perimere*, to destroy) an action, hence decisive, final. A similar use is found in English law in "peremptory challenge," a challenge to a jury allowed to a prisoner without cause shown, or "peremptory mandamus," an absolute command. The natural repugnance to a final order has given this word in its ordinary usage a sense of objectionable and intolerant emphasis.

PEREYASLAVI, a town of Russia, in the government of Poltava, 26 m. S.E. of the city of Kiev, at the confluence of the Trubezh and the Alta, which reach the Dnieper 5 m. lower down at the town's port, the village of Andrushki. Pop. 14,609. Besides the town proper there are three considerable suburbs. Though founded in 993 by Vladimir the Great of Moscow in memory of his signal success over the Turkish Pechenegs, Pereyaslavi has now few remains of antiquity. The town has a trade in grain, salt, cattle and horses, and some manufactures—tallow, wax, tobacco, candles and shoes.

From 1054 Pereyaslavi was the chief town of a separate principality. As a southern outpost it often figures in the 11th, 12th and 13th centuries, and was plundered by the Mongols in 1239. In later times it was one of the centres of the Cossack movement; and in 1628 the neighbourhood of the town was the scene of the extermination of the Polish forces known as "Tara's Night." It was by the Treaty of Pereyaslavi that in 1654 the Cossack chieftain Bogdan Chmelnicki acknowledged the supremacy of Tsar Alexis of Russia.

PEREYASLAVI (called *Zalyeskiy*, or "Beyond the Forest," to distinguish it from the older town in Poltava after which it was named), one of the oldest and most interesting cities in middle Russia, situated in the government of Vladimir, 45 m. N.E. of Moscow on the road to Yaroslavl, and on both banks of the Trubezh near its entrance into Lake Pleschchevo. Pop. 8662. Pereyaslavi was formerly remarkable for the number and importance of its ecclesiastical foundations. Among those still standing are the 12th-century cathedral, with ancient wall-paintings and the graves of Demetrius, son of Alexander Nevsky, and other princes, and a church founded by Eudoxia (Euphrosyne), wife of Demetrius Donskoi, in the close of the 14th century. It is by its extensive cotton manufactures that Pereyaslavi is now best known. The fisheries in the lake (20 m. sq. in extent and 175 ft. deep) have long been of great value.

Founded in 1152 by Yuri Dolgoruki, prince of Suzdal, Pereyaslavi soon began to play a considerable part in the history of the country. From 1195 till 1302 it had princes of its own; and the princes of Moscow, to whom it was at the latter date

bequeathed, kept it (apart from some temporary alienations in the 14th century) as part of their patrimony throughout the 15th and 16th centuries. Lake Pléshchévov was the scene of Peter the Great's first attempts (1691) at creating a fleet.

PEREZ, ANTONIO (c. 1540-1621), for some years the favourite minister of Philip II. of Spain and afterwards for many more the object of his unrelenting hostility, was by birth an Aragonese. His reputed father, Gonzalo Perez, an ecclesiastic, has some place in history as having been secretary both to Charles V. and to Philip II., and in literature as author of a Spanish translation of the *Odyssey* (*La Ulysea de Homero*, Antwerp, 1556). Antonio Perez, who was legitimated by an imperial diploma issued at Valladolid in 1542, was, however, believed by many to be in reality the son of Philip's minister, Ruy Gomez de Silva, prince of Eboli, to whom, on the completion of a liberal education at home and abroad, he appears at least to have owed his first introduction to a diplomatic career.¹ In 1567 he became one of the secretaries of state, receiving also about the same time the lucrative appointment of protonotary of Sicily, and in 1573 the death of Ruy Gomez himself made room for Perez's promotion to be head of the "despacho universal," or private bureau, from which Philip attempted to govern by assiduous correspondence the affairs of his vast dominions. Another of the king's secretaries at this time, though in a less confidential relation, was a friend and contemporary of Perez, named Juan de Escovedo, who, however, after the fall of Tunis in 1574, was sent off to supersede Juan de Soto as secretary and adviser of Don John of Austria, thus leaving Perez without a rival. Some time after Don John's appointment to the governorship of the Netherlands Perez accidentally became cognisant of his inconveniently ambitious "empresa de Inglaterra," in which he was to rescue Mary Queen of Scots, marry her, and so ascend the throne of England. The next step might even be against Spain itself. This secret scheme the faithful secretary at once carried to Philip, who characteristically resolved to meet it by quietly removing his brother's aider and abettor. With the king's full cognisance, accordingly, Perez, after several unsuccessful attempts to poison Escovedo, succeeded in procuring his assassination in a street of Madrid on the 31st of March 1578. The immediate effect was to raise Perez higher than ever in the royal confidence and favour, but, wary though the secretary had been, he had not succeeded in obliterating all trace of his connexion with the crime, and very soon a prosecution was set on foot by the representatives of the murdered man. For a time Philip was both willing and able to protect his accomplice, but ultimately he appears to have listened to those who, whether truly or falsely, were continually suggesting that Perez had had motives of his own, arising out of his relations with the princess of Eboli, for compassing the assassination of Don John's secretary; be this as it may, from trying to screen Perez the king came to be the secret instigator of those who sought his ruin. The process, as such matters often have been in Spain, was a slow one, and it was not until 1589 that Perez, after more than one arrest and imprisonment on a variety of charges, seemed on the eve of being convicted and condemned as the murderer of Escovedo. At this juncture he succeeded in making his escape from prison in Castile into Aragon, where, under the ancient "fueros" of the kingdom he could claim a public trial in open court, and so bring into requisition the documentary evidence he possessed of the king's complicity in the deed. This did not suit Philip, who, although he instituted a process in the supreme tribunal of Aragon, speedily abandoned it and caused Perez to be attacked from another side, the charge of heresy being now preferred, arising out of certain reckless and even blasphemous statements. On the other hand it is suggested that this story of his being the son of Gomez was only circulated by Ruy Gomez's wife, Ana de Mendoza, as a refutation of the possibility of a supposed amour between her and Perez. It is contended by Mignet that this intrigue between her and Perez was known to Escovedo, and that this accounts for the part played by Perez in Escovedo's murder, because Ana had also been Philip's mistress, and Escovedo might have made mischief between Philip and Perez. Major Hume appears to combine the latter theory with Philip's political objection to Escovedo.

amous expressions Perez had used in connexion with his troubles in Castile. But all attempts to remove the accused from the civil prison in Saragossa to that of the Inquisition raised popular tumults, which in the end led to Perez's escape across the Pyrenees, but unfortunately also furnished Philip with a pretext for sending an army into Aragon and suppressing the ancient "fueros" altogether (1591). From the court of Catherine de Bourbon, at Pau, where he was well received, Perez passed to that of Henry IV. of France, and both there and in England his talents and diplomatic experience, as well as his well-grounded enmity to Philip, secured him much popularity. While in England he became the "intimate coach-companion and bed-companion" of Francis Bacon, and was also much in the society of the earl of Essex. The peace of Vervins in 1598 greatly reduced his apparent importance abroad, and Perez now tried to obtain the pardon of Philip III., that he might return to his native country. His efforts, however, proved vain, and he died in comparative obscurity in Paris on the 3rd of November 1611.

Perez's earliest publication was a small quarto, dedicated to the earl of Essex, written and apparently printed in England about 1594, entitled *Pedazos de historia*, and professedly published at Leon. A Dutch translation appeared in 1594, and in 1598 he published his *Relaciones*, including the *Memorial del becho de su causa*, drawn up in 1590, and many of his letters. Much has been done, by Mignet (*Antonio Perez, el Philippe II.*, 1845; 4th ed., 1874) and by Froude ("An Unsolved Historical Riddle," *Nineteenth Cent.*, 1883) among others, towards the elucidation of various difficult points in Perez's somewhat perplexing story. For the murder of Escovedo, see Andrew Lang's discussion of it in his *Historical Mysteries* (1904); and the *Españoles é ingleses* (1903) of Major Martin Hume, who had access to various newly discovered MSS.

PÉREZ GALDÓS, BENITO (1845-), was born at Las Palmas, in the Canary Islands, on the 20th of May 1845. In 1863 he was sent to Madrid to study law, drifted into literature, and was speedily recognized as one of the most promising recruits on the Liberal side. Shortly after the Revolution of 1868 he abandoned journalism, and employed fiction as the vehicle for propagating advanced opinions. His first novel, *La Fontana de oro*, was printed in 1871, and later in the same year appeared *El Audaes*. The reception given to these early essays encouraged the writer to adopt novel-writing as a profession. He had already determined upon the scheme of his *Episodios nacionales*, a series which might compare with the *Comédie humaine*. Old charters, old letters, old newspapers were collected by him with the minuteness of a German archivist; no novelist was ever more thoroughly equipped as regards the details of his period. *Tratado*, the first volume of the *Episodios nacionales*, appeared in 1879; the remaining books of this first series are entitled *La Cort de Carlos IV.*, *El 19 de marzo y el 2 de mayo*, *Bailén*, *Napoleón en Chamartin*, *Zaragoza*, *Gerona*, *Cádiz*, *Juan Martín el Empeinado* and *La Batalla de Arapiles*. As the titles suffice to show, the author's aim was to write the national epic of the 19th century in prose; and he so completely succeeded that, long before the first series ended in 1881, he took rank among the foremost novelists of his time. A second series of *Episodios nacionales*, beginning with *El Equipaje del rey Just* and ending with a tenth volume, *Un Faccioso más y algunas frailes menos*, was brought to a close in 1883, and was, like its predecessor, a monument of industry and exact knowledge, of realism and romantic conception; and he carried on the *Episodios nacionales* into a fourth series, raising the total of volumes to forty. In fecundity and in the power of creating characters, Pérez Galdós vies with Balzac. Parallel with his immense achievement in historical fiction, Pérez Galdós published a collection of romances dealing with contemporary life, its social problems and religious difficulties. Of these the best known, and perhaps the best, are *Doña Perfecta* (1876); *Gloria* (1877); *La Familia de León Roch* (1878); *Marianela* (1878); *Fortunata y Jacinta* (1887); and *Angel Guerra* (1891). Nor does this exhaust his prodigious activity. Besides adapting several of his novels for stage purposes, he wrote original dramas such as *La Loca de la casa* (1893), *San Quintín* (1894), *Elleco* (1900) and *Mariucha* (1904); but his diffuse, exuberant genius

was scarcely accommodated to the convention of theatrical form. Pérez Galdós became a member of the Spanish Academy, and was also elected to the Cortes; but it is solely as a romancer that his name is familiar wherever Spanish is spoken, as a national novelist of fertile talent, and a most happy humorist who in his eccentricities and oddities is hardly inferior to Dickens.

PERFUMERY (Lat. *per*, through, and *fumare*, to smoke), the preparation of perfumes, or substances which are pleasing to the sense of smell. Perfumes may be divided into two classes, the first of which includes all primitive or simple odoriferous bodies derived from the animal or vegetable kingdom, as well as the definite chemical compounds specially manufactured, while the second comprises the various "bouquets" or "mélanges" made by blending two or more of the foregoing in varying proportions—toilet powders, dentifrices, sachets, &c. To the former class belong (1) the animal products, ambergris, castor, civet, musk; (2) the essential oils (also called attars), mostly procured by the distillation of the stems, leaves, flowers and other parts of plants; (3) the phloem butters or oils, which are either solid or liquid fats charged with odours by the processes of inflorescence or maceration, (4) the odoriferous gum-resins or balsams which exude naturally or from wounds in the trunks of various trees and shrubs, such as benzoin, opoponax, Peru, Tolu, storax, myrrh; (5) the large number of synthetic perfumes which simulate the odour of the natural scents. The second class contains the endless combination of tinctures sold under fancy names which may or may not afford a clue to their composition, such as "comédie française," "eau de senteur," "eau de Cologne," "lavendre ambrée," "blumengeist." In general, they are mixtures of a number of perfumes dissolved in alcohol. Strictly speaking, most of the perfumes on the market belong to the second class, since, in most cases, they are prepared by blending various natural or artificial odorous principles.

Natural Perfumes.—The animal perfumes are extremely limited in number. Ambergris (*q.v.*), one of the most important, is secreted by the sperm whale; musk (*q.v.*), the best known scent of this class, is secreted by the male musk-deer and other animals—musk-ox, musk-rat, &c.; civet (*q.v.*) is a musky scent named from the animal which secretes it; and castor or castoreum is a somewhat similar secretion of the beaver (*q.v.*). More important are the scents yielded by flowering plants. As a general rule fragrant flowers flourish in hot climates, but the more delicate perfumes are yielded by plants having a colder habitat; it must be remembered, however, that some costly perfumes are obtained from the plants of Ceylon, the East Indies, Mexico and Peru. In Europe, Grasse, Cannes and Nice are the centres of the natural perfume industry. Cannes is famous for its rose, acacia, jasmine and neroli oil; Nîmes for its thyme, rosemary and lavender; and Nice for its violets. Citron and orange oil come from Sicily; iris and bergamot from Italy; and roses are extensively cultivated in Bulgaria, and in European Turkey. England is unsurpassed for its lavender and peppermint, which flourish at Mitcham and Hitchin.

The natural sources of the attars or essential oils are the different parts of the plants which yield them—the wood (lign, aloe, santal, cedar), the bark (cinnamon, cascarilla), the leaves (patchouli, bay, thyme), the flowers (rose, lavender, orange-blossom), the fruit (nutmeg, citron), or the seeds (caraway, almond). Some plants yield more than one, such as lemon and bergamot. They are mostly obtained by distilling that part of the plant in which they are contained with water, or with high-pressure or superheated steam; but some few, as those from the rind of bergamot (from *Citrus bergamia*), lemon (citron zeste, from *C. Limonium*), lime (*C. Limetta*), by "expression." The outer layer of the cortex is rasped off from the unripe fruits, the raspings placed in a canvas bag, and squeezed in a screw or hydraulic press. The attars so obtained are separated from the admixed water by a tap-funnel, and are then filtered. Certain flowers, such as jasmine, tuberose, violet, cassia, either do not yield their attars by distillation at all, or do it so sparingly as not to admit of its collection for commercial purposes; and

sometimes the attar, as in the case of orange (neroli), has an odour quite different from that of the fresh blossoms. In these cases the odours are secured by the processes of inflorescence (enfleurage) or by maceration. Both depend upon the remarkable property which fats and oils possess of absorbing odours. Enfleurage consists in laying the leaves or flowers on plates covered with a layer of fat. The flowers are renewed every morning, and when the fat has sufficient odour it is scraped off, melted and strained. Maceration consists in soaking the flowers in heated fat; in due time they are strained off and replaced by fresh ones, as in the enfleurage process. The whole of the necessary meltings and heatings of the perfumed greases are effected by means of water-baths, whereby the temperature is kept from rising too high. For the manufacture of perfumes for the handkerchief the greases now known as pomades, butters or phloemomes are treated with rectified spirit of wine 60° over-proof, *i.e.* containing as much as 95% of absolute alcohol by volume, which practically completely abstracts the odour.

The gum-resins and resins have been employed as perfumes from the earliest times. The more important are incense, frankincense and myrrh (*q.v.*). They are largely used in the manufacture of perfumes, both for burning as pastilles, ribbon of Bruges, incenses, &c., and in tinctures, to which they impart their characteristic odours, affording, at the same time, a certain fixity to other perfumes of a more fleeting nature when mixed with them.

Synthetic Perfumes.—Under this heading are included all perfumes in which artificial substances are odorous ingredients. Although the earliest perfumes of this class were introduced in about the middle of the 19th century, the important industry which now prevails is to be regarded as dating from the 'seventies and 'eighties. Three main lines of development may be distinguished: (1) the chance discovery of substances which have odours similar to natural perfumes; (2) the elucidation of the composition of the natural scents, and the chemical constitution of their ingredients, followed by the synthetic preparation of the substances so determined; and (3), which may be regarded as connected with (2), the extraction and separation of the essential oils yielded by less valuable plants, and their reblending to form marketable perfumes.

The first synthetic perfume was the "essence of Mirbane" introduced by Collas in about 1850; this substance was the nitro-benzene discovered by E. Mitscherlich in 1834. Soon afterwards many esters of the fatty acids simulating the odours of fruits were introduced; and in 1838 Baur discovered the "artificial musks," which are derivatives of *s*-trinitrobenzene. The above are instances of the first line of progress. The second line has for early examples the cases of artificial oil of wintergreen, which followed Cabour's discovery that the natural oil owed its odour, in the main, to methyl salicylate, and of artificial oil of bitter almonds which followed the preparation of benzaldehyde from benzal chloride in 1868. The synthesis of coumarin, the odorous principle of hay and woodruff, by Sir W. H. Perkin in 1868; of vanillin, the odorous principle of vanilla, by F. Tiemann and W. Haarmann in 1875; and of ionone, almost identical with the natural irone, the odorous principle of violets, by Tiemann and P. Krüger in 1898, are to be regarded as of the highest importance. Equally important are the immense strides made in the elucidation of the constitution and syntheses of the terpenes (*q.v.*), a group of compounds which are exceptionally abundant as odorous principles in the essential oils.

The present state of our knowledge does not permit a strict correlation of odour and chemical constitution. One theory regards odour as due to "osmophores," or odour-producing groups, in much the same way as colour is associated with chromophores. Such osmophores are hydroxyl (OH), aldehyde (CHO), ketone (CO), ether (O), nitrile (CN), nitro (NO₂), &c.; we may also notice the isonitrile group (·NG) associated with an unpleasant odour, and the iso-thiocyanate group (·NCS) to which the mustard oils owe their characteristic smell. The same group, however, is not invariably associated with the same odour, or even any odour at all, as, for instance, in such closely related

compounds as the members of a homologous series. For example, the lower fatty aldehydes have unpleasant odours, those with ten carbon atoms (and also double linkages, which in itself may affect odour) form some of the most delicate scents, while the higher members are odourless. The absence of odour in the higher members may be possibly associated with the low volatility exhibited by compounds of high molecular weight. Certain isomorphs have practically equal effects; for example, benzaldehyde, nitrobenzene, benzonitrile, and phenyl azoimide have practically identical odours, and among the "artificial musks," a nitro group may be replaced by the azoimido group without the odour being modified. As a general rule, homologues have similar odours, but many exceptions are known. For example the methyl and ethyl ethers of β -naphthol have the odour of neroli; on the other hand, of the esters of anthranilic acid, the methyl has the odour of orange blossoms, the ethyl has a slight odour, and the isobutyl is odourless. The introduction of a methyl group into the benzene ring generally involves little or no change in odour; but when it (and more especially higher alkyl radicals) is introduced into side chains the odour may be entirely changed. For example, benzene and its homologues have similar odours; phthalide is odourless, but the isopropyl and butyl phthalides, in which substitution occurs in the side chain, smell of cedar. Especially characteristic are the derivatives of phenylacetylene. This hydrocarbon is distinctly unpleasant; on the other hand, para-ethyl and para-methyl phenylacetylene smell of anise. While the triply-linked carbon system is generally associated with strong and unpleasant odours, the doubly linked system gives pleasant ones. Thus the unpleasant phenylacetylene, $C_6H_5 \cdot C \equiv CH$, is contrasted with styrolene, $C_6H_5 \cdot CH=CH_2$, which occurs in storax, and phenylpropionic aldehyde with cinnamic aldehyde, $C_6H_5 \cdot CH=CH \cdot CHO$, which occurs in cassia and cinnamon. The reduction of a double to a single linkage may not destroy odour. Thus hydrocinnamic aldehyde, the reduction product of cinnamic aldehyde, smells of jasmine and lilac, and melilotin, which occurs in yellow melilot (*Melilotus officinalis*), has the same odour (woodruff) as its oxidation product coumarin. The orientation of the substituent groups in the benzene nucleus also affects odour. In general, the meta compounds are odourless, while the ortho and para may have odour. Thus β -methoxyacetophenone has a pleasant odour, the meta compound is odourless, β -aminoacetophenone, α -aminobenzaldehyde, and o -nitrophenol have strong odours, while the meta and para bodies are odourless. Of the three triptrobenzenes only the symmetrical form gives origin to perfumes.

The concentration and even the solvent has considerable effect on the odour of a substance. Many of the artificial principles—vanillin, heliotropine, ionone, &c.—have very different odours in strong and in dilute solution; phenyl acetic acid and β -naphthylamine are odourless when solid, but have disagreeable odours when dissolved. Traces of impurities often have the effect of making odourless or pleasant-smelling compounds quite intolerable. Acetylene as generated from calcium carbide, and carbon disulphide prepared from its elements are quite intolerable, though when pure they are, at least, not unpleasant; artificial benzaldehyde must be very carefully purified before it can be used in the preparation of the more delicate scents. In all cases the natural scents are complex mixtures of many ingredients, and a variation in the amount of any one may completely alter the scent. Such mixtures would be difficult to reproduce economically; the perfumer is content with a product having practically an identical odour, with or without the natural substance which it is designed to compete with.

We now give an account of the artificial scents, principally arranged according to their chemical relations. The fatty esters are interesting as providing many of the fruit essences; in fact, by appropriate blending, any fruit odour can be reproduced. Their use, however, is inhibited by the fact that they irritate the respiratory organs, producing coughing and headaches. Isobutyl carbinol acetic ester (amyl acetate), $(CH_3)_2CH \cdot CH_2 \cdot CH_2 \cdot OC \cdot CH_3$, forms when in dilute alcoholic solution the artificial pear oil; a similar odour is possessed by isocamyl-n-butyrate, $C_8H_{17} \cdot CO_2 \cdot C_4H_9$.

n-Octyl acetate, $C_8H_{17} \cdot O_2C \cdot CH_3$, has the odour of oranges. Isom propionate, $C_8H_{17} \cdot O_2C \cdot C_2H_5$, and ethyl-n-butyrate, $C_8H_{17} \cdot O_2C \cdot C_2H_5$ have the odour of pineapple, the latter constituting the artificial pineapple oil of commerce. Isoamyl isovalerate, $C_{11}H_{21} \cdot O_2C \cdot C_4H_9$ is the artificial apple oil. Of the fatty ketones, methyl non ketone, $CH_3 \cdot CO \cdot C_9H_{19}$, which is the scent of oil of rue, and methyl acetone, $CH_3 \cdot CO \cdot CH_2 \cdot (CH_2)_6 \cdot CH_3$, which has the odour of peppermint, receive commercial application. Of exceptional importance in the chemistry of perfumes are the unsaturated open chain compounds containing at least eight carbon atoms. The are chemically considered, along with the related cyclic compound in the article TERPENES; here we notice their odours and occur in perfumes. Of the alcohols, l-linalol occurs in oil of lavender bergamot, limet and origanum; d-linalol in coriander; citronell and geraniol in rose, geranium and pelargonium oils. Of the aldehydes, citral or geraniol has the odour of lemons; citronell is the chief constituent of citronella oil. By condensing citral with acetone and treating the product with dilute sulphuric acid, the valuable violet substitute ionone results. This substance is hydroaromatic ketone, and closely resembles the natural princic iron. By successive treatment with acetic anhydride (to form isopulegol), oxidation to isopulegone, and treatment with bary citronellal yields the cyclic compound *pilegone*, the chief constituent of oil of pennyroyal. The olefinic terpenes are generally converted into methylheptenone, $(CH_3)_2C \cdot CH(CH_2)_5 \cdot CO \cdot CH_3$, which has been synthesized from sodium acetylacetonate and amylene dibromide this ketone occurs in several essential oils, and has the odour of rue. For the occurrence of cyclic terpenes in the essential a reference should be made to the table below, which contains the names, sources and chief ingredients of the more important essential oils.¹ The terpenes are printed in italics, the aliphatic and benzeno compounds in ordinary type.

Name of Oil.	Source.	Constituents.
Anise	<i>Pimpinella anisum</i>	Anethole, estragole.
Bay	<i>Pimenta acris</i>	Eugenol, methyl eugenol, chavicol, estragole, myrcene, phellandrene.
Bergamot	<i>Citrus bergamia</i>	Linalol, linalyl acetate, d-limonene, bergaptena.
Cajapat	<i>Melaleuca</i> , sp.	Cineol.
Cassia	<i>Cinnamomum cassia</i>	Cinnamic aldehyde, cinnamyl acetate.
Caraway	<i>Carum carvi</i>	Carvone, d-limonene.
Camphor	<i>Cinnamomum camphor</i>	d-Pinene, phellandrene, terpinol, eugenol, safrole.
Chamomile	<i>Anthemis nobilis</i>	Isobutyl and isomyl ester of angelic and tiglic acids.
Cinnamon	<i>Cinnamomum Zeylanicum</i>	Cinnamic aldehyde.
Clove	<i>Eugenia caryophyllata</i>	Eugenol.
Coriander	<i>Coriandrum sativum</i>	Linalol.
Cumin	<i>Cuminum cyminum</i>	Cumic aldehyde, cymene.
Eucalyptus	<i>Eucalyptus globulus</i>	Cineol, d-pinene, and linaldehydes.
Fennel	<i>Foeniculum vulgare</i>	Anethole, fenchone, d-pinene.
Geranium	<i>Andropogon schoenanthus</i>	Geraniol, citronellol.
Jasmine	<i>Jasminum grandiflorum</i>	Methyl anthranilate, indo benzyl alcohol, benzyl acetate, linalol, linalyl acetate.
Lavender	<i>Lavandula vera</i>	Linalol, linalyl acetate.
Lemon	<i>Citrus limonum</i>	Limonene, phellandrene, citral, citronellal, geranyl acetate, linalol.
Lemon-grass	<i>Andropogon citralis</i>	Citral.
Neroli	<i>Citrus bigaradia</i>	l-Linalol, geraniol, limonene, methyl anthranilate.
Orange	<i>Citrus aurantium</i>	d-Limonene.
Peppermint	<i>Mentha piperita</i>	Menthol, menthyl acetate, isovalerate.
Pine-needle	<i>Pinus sylvestris</i>	d-Pinene, d-sylvestrene.
Rose	<i>Rosa damascena</i>	Geraniol, l-citronellol.
Rose	<i>Pelargonium odoratissimum</i>	Geraniol, citronellol.
Geranium	seemum	
Rosemary	<i>Rosmarinus officinalis</i>	Pinene, camphene, camphol, cineol, borneol.
Sage	<i>Salvia officinalis</i>	Pinene, cineol, thujone, borneol.
Sassafras	<i>Sassafras officinalis</i>	Safrole.
Sassafras	<i>Mentha viridis</i>	l-Linalol, l-carvone.
Sparmint	<i>Mlicium anisatum</i>	Anethole.
Star anise	<i>Illicium anisatum</i>	Thujone.
Tansy	<i>Tanacetum vulgare</i>	Thujone.
Thyme	<i>Thymus vulgaris</i>	Thymol.
Wormwood	<i>Artemisia absinthium</i>	Thujone and thujyl esters.
Ylang-ylang	<i>Cananga odorata</i>	l-Linalol, geraniol.

¹ See J. B. Cohen, *Organic Chemistry*, p. 532; or J. Parry, *Chemist of Perfumes* (1908).

The chief benzenoid compounds used as perfumes are aldehydes, oxaldehydes, phenols and phenol ethers. Benzaldehyde has the odour of almonds, cinnamic aldehyde of cinnamon, and cuminaldehyde gives the odour to cumin oil. Of oxaldehydes salicylaldehyde gives the odour to spiraea oil, and vanillin is the active ingredient of vanilla (q.v.). Anisaldehyde smells like hawthorn, and is extensively used under the name aubepin for scenting soaps and extracts. Carvacrol and thymol are isomeric methyl propyl phenols; both have the odour of thyme. Of phenol ethers eugenol (allyl guaiacol) has the odour of cloves, and anethole (allyl phenyl methyl ether) is the chief constituent of anise oil, being chiefly used in the manufacture of liqueurs. Several piperyonyl compounds are of commercial importance. The aldehyde, $\text{CH}_2(\text{OH})\text{C}_6\text{H}_4\text{CHO}$ (1,2,4), piperonal, has the odour of heliotrope; an allyl derivative, safrole $\text{CH}_2(\text{OH})\text{C}_6\text{H}_4\text{C}_2\text{H}_5$ (1,2,4), occurs in sassafras, while apiole or dimethoxy safrole has the odour of parsley oil. Of other synthetic perfumes amylic salicylate is used under the names of *orchidee* or *irefah* as the basis of many perfumes, in particular of clover scents; methyl anthranilate occurs in the natural neroli and other oils, and has come into considerable use in the preparation of artificial bergamot, neroli, jasmine and other perfumes (the Trolene, Marcol and Amanthol of the *Adien Gesellschaft für Anilin Fabrikation* have this substance as a base); the "artificial musks" are derivatives of β -trinitrobenzene; coumarin is the principle of woodruff; and β -naphthol methyl ether is used for the preparation of artificial neroli.

The Odophone.—The most important element in the perfumer's art is the blending of the odorous principles to form a mixture which gratifies the sense of smell. Experience is the only guide. It is impossible to foretell the odour of a mixture from the odours of its components. Septimus Piesse endeavoured to show that a certain scale or gamut existed amongst odours as amongst sounds, taking the sharp smells to correspond with high notes and the heavy smells with low. He illustrated the idea by classifying some fifty odours in this manner, making each to correspond with a certain note, one-half in each clef, and extending above and below the lines. For example, treble clef note E (4th space) corresponds with Portugal (orange), note D (1st space below clef) with violet, note F (4th space above clef) with ambergris. It is readily noticed in practice that ambergris is much sharper in smell (higher) than violet, while Portugal is intermediate. He asserted that properly to constitute a bouquet the odours to be taken should correspond in the gamut like the notes of a musical chord—one false note among the odours as among the music destroying the harmony. Thus on his odophone, santal, geranium, acacia, orange-flower, camphor, corresponding with C (base and line below), C (base 2nd space), E (treble 1st line), G (treble 2nd line), C (treble 3rd space), constitute the bouquet of chord C.

Other Branches of Perfumery.—As a natural outcome of the development of the perfume industry, scented articles for toilet and other uses are now manufactured in large quantities. Soaps, toilet powders, tooth powders, hair-washes, cosmetics generally, and note-paper have provided material on which the perfumer works. For the preparation of *scented soaps* two methods are in use: both start with a basis either of fine yellow soap (which owes its odour and colour to the presence of resin), or of curd soap (which is hard, white and odourless, and is prepared without resin). In one process the soap is melted by superheated steam, and while still hot and semi-fluid mixed by means of a stirrer of wood with iron cross-bar, technically called a "crutch," with the attars and colouring matter. It is then removed from the melting pan to a rectangular iron mould or box, the sides of which can be removed by unscrewing the tie-riods which hold them in position; when cold the mass is cut into slabs and bars with a thin brass wire. In the other or cold process the soap is first cut into chips or shavings by a plane or "chipping machine," then the colouring matters are added and thoroughly incorporated by passing the soap between rollers; the tinted soap emerges in a continuous sheet but little thicker than paper. The perfumes are then added, and after standing for about twelve hours the soap is again sent through the rolling machine. It is next transferred to a bar-forming machine, from which it emerges as a continuous bar almost as hard as wood. Soap thus worked contains less than 10% of water; that prepared by melting contains 20 and even 30%. The amount of perfume added depends upon its nature, and amounts usually to about 7 or 8%. The finest soaps are always manufactured by the cold process.

Toilet Powders are of various sorts. They consist of rice-starch or wheat-starch, with powderedorris-root in varying proportions, and with or without the addition of zinc oxide, bismuth oxide or French chalk. The constituent powders, after the addition of the perfume, are thoroughly incorporated and mixed by sifting through a fine sieve. Violet powder for the nursery should consist entirely of powdered violet root (*Iris florentina*), from the odour of which the powder is named. It is of a yellowish tint, soft and pleasant to the touch. The white common so-called "violet powders" consist of starch scented with bergamot, and are in every sense inferior.

Tooth Powders consist for the most part of mixtures of powderedorris-root with precipitated chalk, and some other constituent destined to particularize it as to properties or flavour, such as

charcoal, finely pulverised pumice, quassia, sugar, camphor, &c. The perfume of the containedorris-root is modified, if required, by the addition of a little of some perfume. **Tooth Pastes** are formed of the same constituents as the powders, and are worked into a paste by the addition of a little honey or glucose syrup, which substances are usually believed ultimately to have an injurious effect on the teeth.

Perfume Sachets consist either of a powder composed of a mixture of vanilla, musk, Tonqua beans, &c., one or other predominating as required, contained in an ornamental silk sac; or of some of the foregoing substances spread upon card or chamois leather or flannel after being made into a paste with mucilage and a little glycerina. When dry the card so prepared is daintily covered with various parti-coloured silks for sale. Where the ingredients employed in their manufacture are of good quality these cards, known as "peau d'Espagne" sachets, retain their odour unimpaired for years.

Adulterations.—There is, as might be expected, considerable scope for the adulteration of the "matières premières" employed in perfumery. Thus, in the case of musk, the "pods" are frequently found to be partially emptied of the grain, which has been replaced by hide or skin, while the weight has been increased by the introduction of lead, &c. In other instances the fraud consists in the admixture of refuse grain, from which the odour has been exhausted with spirit, with dried blood, and similar substances, whilst pungency is secured by the addition of ammonium carbonate. Attar of rose is diluted with attar of *Palma rosa*, a variety of geranium of only a quarter or a fifth of the value. The main adulterant of all the natural essential oils, however, is castor oil. This is a bland neutral body, practically odourless, and completely soluble in alcohol; it therefore presents all the requisites for the purpose.

BIBLIOGRAPHY.—See generally, J. C. Sawyer, *Oderographia*, vol. I. (1892), vol. II. (1894); G. W. Askinson, *Perfumes* (Eng. trans. by Isidor Fürst, 1892); S. Piesse, *Art of Perfumery* (1891); Paul Hubert, *Plantes à parfums* (1909); M. Otto, *L'Industrie des parfums* (1909). Synthetic perfumes are treated in detail in C. Deite, *Manual of Toilet Soap-making* (Eng. trans. by S. I. King, 1905), and in E. J. Parry, *Chemistry of the Essential Oils and Artificial Perfumes* (2nd ed., 1908). Reference may also be made to T. Koller, *Cosmetics* (1902). The standard works on the essential oils are given in the article OILS. G. Cohn, *Die Riechstoffe* (1904), treats the chemistry, and Zwaardemaker, *Physiologie des Geruchs* (1895), the physiology of perfumes. See also the reports and bulletins of Schimmel & Co. and Rouse Bertrand at Fila.

PERGA (mod. *Murlana*), an ancient city of Pamphylia, situated about 8 m. inland, at the junction of a small stream (Sarı Su) with the Cestrus. It was a centre of native influences as contrasted with the Greek, which were predominant in Attalia, and it was a great seat of the worship of "Queen" Artemis, here represented as a human-headed cone and a purely Anatolian nature goddess. There Paul and Barnabas began their first mission in Asia Minor (Acts ix. 13). A much frequented route into Phrygia and the Maeander valley began at Perga, and Alexander made it the starting-point of his invasion of inner Asia Minor. Long the metropolis of Pamphylia Secunda, it was superseded in Byzantine times by its port, Attalia, which became a metropolis in 1084. The extensive ruins all lie in the plain south of the Acropolis. The walls are well preserved, but of late Roman or Byzantine reconstruction. The lines of intersecting streets can be easily made out, and there are ruins of two sets of baths, two basilicas and a forum. But the most notable monument is the theatre, which lies outside the walls on the south-west, near the stadium. This is as perfect as those of Myra and Patara, but larger than either, and yields the palm only to those of Aspendus and Side. Modern Murlana is a large village, long under the dominion of the Dere Beys of the Tekke Oglu family.

See C. Lanckoronski, *Villes de la Pamphylie et de la Pisidie*; vol. I. (1890); Sir W. M. Ramsay, *Church in the Roman Empire* (1893). (D. G. H.)

PERGAMENEOUS (Lat. *pergamena*, parchment), a technical term used of anything of the texture of parchment, as in zoology of the wing-covers of insects.

PERGAMUM, or **PERGAMUS** (mod. *Bergama*), an ancient city of Teuthrania, a district in Mysia. It is usually named Πέργανον by Greek writers, but Ptolemy has the form Πέργματος. The name, which is related to the German *burg*, is appropriate to the situation on a lofty isolated hill in a broad fertile valley, less than 15 m. from the mouth of the Caicus. According to the belief of its inhabitants, the town was founded by Arcadian colonists, led by Telephus, son of Heracles. Auge, mother of

Telephus, was priestess of Athena Alea at Tegea, and daughter of Aieus; fleeing from Tegea, she became the wife of Teuthras, the eponymous king of Teuthrania, and her son Telephus succeeded him. Athena Polias was the patron-goddess of Pergamum, and the legend combines the ethnological record of the connexion claimed between Arcadia and Pergamum with the usual belief that the hero of the city was son of its guardian deity, or at least of her priestess. Nothing more is recorded of the city till the time of Xenophon, when it was a small fortified town on the summit of the hill; but it had been striking coins since 450 B.C. at latest. Its importance began under Lyimachus, who deposited his treasures, 9000 talents, in this strong fortress under the charge of a eunuch, Philetaerus of Tium. In 283 B.C. Philetaerus rebelled, Lyimachus died without being able to put down the revolt, and Pergamum became the capital of a little principality. Partly by clever diplomacy, partly through the troubles caused by the Gaulish invasion and by the dissensions among the rival kings, Philetaerus contrived to keep on good terms with his neighbours on all sides (283-263 A.C.). His nephew Eumenes (263-241) succeeded him, increased his power, and even defeated Antiochus II. of Syria in a pitched battle near Sardis. His successor Attalus I. (241-197) won a great battle over the Gauls, and assumed the title of king. The other Greek kings who aimed at power in Asia Minor were his natural enemies, and about 222 reduced Pergamenian power to a very low ebb. On the other hand, the influence of the Romans was beginning to make itself felt in the East. Attalus prudently connected himself with them and shared in their continuous success. Pergamum thus became the capital of a considerable territory and a centre of art and regal magnificence. The wealth of the state and the king's desire to celebrate his victories by monuments of art led to the rise of the "Pergamenian school" in sculpture. The splendour of Pergamum was at its height under Eumenes II. (197-150). He continued true to the Romans during their wars with Antiochus and Perseus, and his kingdom spread over the greater part of western Asia Minor, including Mysia, Lydia, great part of Phrygia, Ionia and Caria. To celebrate the great achievement of his reign, the defeat of the barbarian Gauls, he built in the agora a vast altar to Zeus Soter (see below). He left an infant son, Attalus (III.), and a brother, Attalus II. (Philadelphus), who ruled 159-138, and was succeeded by his nephew, Attalus III. (Philometor). The latter died in 133, and bequeathed his kingdom to the Romans, who erected part of it (excluding Great Phrygia, which they gave to Mithradates of Pontus) into a province under the name of Asia. Pergamum continued to rank for two centuries as the capital, and subsequently, with Ephesus and Smyrna, as one of the three great cities of the province; and the devotion of its former kings to the Roman cause was continued by its citizens, who erected on the Acropolis a magnificent temple to Augustus. It was the seat of a *conventus*, including the cities of the Cacus valley and some of those in the northern part of the Hermus valley. Under the Roman Empire Pergamum was one of the chief seats of the worship of Asclepius "the Saviour"; invalids came from distant parts of the country to ask advice from the god and his priests. The temple and the curative establishment of the god were situated outside the city. Pergamum was the chief centre of the imperial cult under the early empire, and, in W. M. Ramsay's opinion, was for that reason referred to in Rev. ii. 13 as the place of "Satan's throne." It was also an early seat of Christianity, and one of the Seven Churches. The place, re-fortified by the Byzantines, and still retaining its name as Bergama, passed into Moslem hands early in the 14th century. The lower town was rebuilt, and in the 17th and 18th centuries became a chief seat of the great Dere Bey family of Kara Osman Oglu (see MANSISA), which did not resign it to direct Ottoman control until about 1825. It is still an administrative and commercial centre of importance, having some 20,000 inhabitants.

Excavations.—The site of the ancient city has been the scene of extensive excavations promoted by the Berlin museum since 1878, and directed first by K. Humann and A. Conze, and

afterwards by W. Dörpfeld. The first impulse to them was given in 1873 by the reception in Berlin of certain reliefs, extracted by Humann from the walls of Bergama. These were recognized as probably parts of the Great Altar of Zeus erected by Eumenes II. in 180 B.C. and decorated with a combat of gods and giants, symbolic of the struggle between the Pergamene Greeks and the Gaulish barbarians. Excavation at the south end of the Acropolis led to the discovery of the Altar itself and the rest of its surviving reliefs, which, now restored and mounted in Berlin, form one of the glories of that city. In very high relief and representing furious action, these sculptures are the finest which survive from the Pergamene school, which replaced the repose and breadth of earlier schools by excess of emphasis and detail. The summit of the Acropolis is crowded with public buildings, between the market place, which lies at the southern point, and the Royal Gardens on the north. In the interval are the Zeus altar; the great hexastyle Doric temple of Athena flanked by the palace on the east, by the theatre and its long terrace on the west, and by a library on the north; and a large Corinthian temple of Trajan. The residential part of the Greek, and practically all the Roman city lay below the Acropolis on ground now mostly occupied by modern Bergama; but west of the river Selinus, on rising ground facing the Acropolis, are to be seen notable remains of a Roman theatre, an amphitheatre and a circus.

See, beside general authorities for Asia Minor, J. Dalfway, *Constantinople*, &c. (1797); W. M. Ramsay, *Letters to the Seven Churches* (1904); and especially the publication by the Royal Museum of Berlin, *Alterthümer von Pergamon* (1885 sqq.); "Operations at Pergamon 1906-1907," in *Athenische Mittheil.* (1908), xxxiii. G. Leroux, "La Préfendue basilique de Pergame" in *Bull. Corr. Hell.* (1909), pp. 238 sqq. (D. G. H.)

PERGOLA (Lat. *pergula*, a projecting roof, shed, from *pergere*, to reach forward, project), a term adopted from the Italian for an arbour of trellis-work over which are trained creeping plants, vines, &c., and especially for a trellis-work covering a path, walk or balcony in a garden.

PERGOLESÌ (or **PERGOLESZ**), **GIOVANNI BATTISTA** (1710-1736), Italian musical composer, was born at Jesi near Ancona on the 3rd of January 1710, and after studying music under local masters until he was sixteen was sent by a noble patron to complete his education at Naples, where he became a pupil of Greco, Durante and Feo for composition and of Domenico de Matteis for the violin. His earliest known composition was a sacred drama, *La Conversione di S. Guglielmo d'Aquidania*, between the acts of which was given the comic intermezzo *Il Maestro di musica*. These works were performed in 1731, probably by fellow pupils, at the monastery of St Agnello Maggiore. Through the influence of the prince of Stigliano and other patrons, including the duke of Maddaloni, Pergolesi was commissioned to write an opera for the court theatre, and in the winter of 1731 successfully produced *La Sallustia*, followed in 1732 by *Ricimero*, which was a failure. Both operas had comic intermezzi, but in neither case were they successful. After this disappointment he abandoned the theatre for a time and wrote thirty sonatas for two violins and bass for the prince of Stigliano. He was also invited to compose a mass on the occasion of the earthquake of 1731, and a second mass, also for two choirs and orchestra, is said to have been praised by Leo. In September 1732 he returned to the stage with a comic opera in Neapolitan dialect, *Lo Fraiè inamorato*, which was well received; and in 1733 he produced a serious opera, *Il Prigionier*, to which the celebrated *Serva padrona* furnished the intermezzi. There seems, however, no ground for supposing that this work made any noticeable difference to the composer's already established reputation as a writer of comic opera. About this time (1733-1734) Pergolesi entered the service of the duke of Maddaloni, and accompanied him to Rome, where he conducted a mass for five voices and orchestra in the church of St Lorenzo in Lucina (May 1734). There is no foundation for the statement that he was appointed maestro di cappella at the Holy House of Loreto; he was, in fact, organist of the royal chapel at Naples in 1735. The complete failure of *L'Olimpiade* at Rome in January 1735

is said to have broken his health, and determined him to abandon the theatre for the Church; this statement is, however, incompatible with the fact that his comic opera *Il Flaminio* was produced in Naples in September of the same year with undoubted success. His ill health was more probably due to his notorious profligacy. In 1736 he was sent by the duke of Maddaloni to the Capuchin monastery at Pozzuoli, the air of the place being considered beneficial to cases of consumption. Here he is commonly supposed to have written the celebrated *Stabat Mater*; Paisiello, however, stated that this work was written soon after he left the *Conservatorio dei poveri di Gesù Cristo* in 1729. We may at any rate safely attribute to this period the *Scherzo fatto ai Cappuccini di Pozzuoli*, a musical jest of a somewhat indelicate nature. He died on the 17th of March 1736, and was buried in the cathedral of Pozzuoli.

Pergolesi's posthumous reputation has been exaggerated beyond all reason. This was due partly to his early death, and largely to the success of *La Serva padrona* when performed by the *Bouffons Italiens* at Paris in 1752. Charming as this little piece undoubtedly is, it is inferior both for music and for humour to Pergolesi's three act comic operas in dialect, which are remembered now only by the air "Ogni pena più spietata" from *Lo Frate innamorato*. As a composer of sacred music Pergolesi is effective, but essentially commonplace and superficial, and the frivolous style of the *Stabat Mater* was rightly censured by Paisiello and Padre Martini. His best quality is a certain sentimental charm, which is very conspicuous in the cantata *L'Orfeo* and in the genuinely beautiful duets "Ce serca, se dice" and "Ne' giorni tuoi felici" of the serious opera *L'Olimpiade*; the latter number was transferred unaltered from his early sacred drama *S. Guglielmo*, and we can thus see that his natural talent underwent hardly any development during the five years of his musical activity. On the whole, however, Pergolesi is in no way superior to his contemporaries of the same school, and it is purely accidental that a later age should have regarded him as its greatest representative.

BIBLIOGRAPHY.—The most complete life of Pergolesi is that by E. Faustini Fasini (*Gazzetta musicale di Milano*, 31st of August 1899, &c., published by Ricordi in book form, 1900); G. Annibaldi's *Il Pergolesi in Pozzuoli, vita intima* (Jesi, 1890) gives some interesting additional details derived from documents at Jesi, but is cast in the form of a romantic novel. H. M. Schletterer's lecture in the *Sammlung musikalischer Vorträge*, edited by Count P. von Walderssee, is generally inaccurate and uncritical, but gives a good account of later performances of Pergolesi's works in Italy and elsewhere. Various portraits are reproduced in the *Gazz. mus. di Milano* for the 14th of December 1899, and in *Musica e musicisti*, December 1905. Complete lists of his compositions are given in Eitner's *Quellen-Lexicon* and in Grove's *Dictionary* (new ed.). (E. J. D.)

PERGOLESI, MICHAEL ANGELO, an 18th-century Italian decorative artist, who worked chiefly in England. Biographical details are almost entirely lacking, but like Cipriani he was brought, or attracted, to England by Robert Adam after his famous continental tour. He worked so extensively for the Adams, and his designs are so closely typical of much upon which their reputation rests, that it is impossible to doubt his influence upon their style. His range, like theirs, was catholic. He designed furniture, mantelpieces, ceilings, chandeliers, doors and mural ornament with equal felicity, and as an artist in plaster work in low relief he was unapproached in his day. He delighted in urns and sphinxes and interlaced gryphons, in *amorini* with bows and torches, in trophies of musical instruments and martial weapons, and in flowering arabesques which were always graceful if sometimes rather thin. The centre panels of his walls and ceilings were often occupied by classical and pastoral subjects painted by Cipriani, Angelica Kauffmann, Antonio Zucchi, her husband, and sometimes by himself. These nymphs and amorini, with their disengaged and *riant* air and classic grace, were not infrequently used as copies for painting upon that satinwood furniture of the last quarter of the 18th century which has never been surpassed for dainty elegance, and for the popularity of which Pergolesi was in large measure responsible; they were even reproduced in marquetry. Some of this painted work was, apparently, executed by his own hand; most of the

pieces attributed to him are remarkable examples of artistic taste and technical skill. His satin-wood table-tops, china cabinets and side-tables are the last word in a daintiness which here and there perhaps is mere prettiness. Pergolesi likewise designed silver plate, and many of his patterns are almost instinctively attributed to the brothers Adam by the makers and purchasers of modern reproductions. There is, moreover, reason to believe that he sided the Adams firm in purely architectural work. In later life Pergolesi appears, like Angelica Kauffmann, to have returned to Italy.

Our chief source of information upon his works is his own publication, *Designs for Various Ornaments as Seventy Plates*, a series of folio sheets, without text, published between 1777 and 1801.

PERI, JACOPO (1561-16 ?), Italian musical composer, was born at Florence on the 20th of August 1561; of a noble family. After studying under Cristoforo Malvezzi of Lucca, he became maestro di cappella, first to Ferdinand, duke of Tuscany, and later to Cosimo II. He was an important member of the literary and artistic circle which frequented the house of Giovanni Bardi, conte de Vernio, whose revival of Greek tragedy with its appropriate musical declamation was a favourite subject of discussion. With this end in view the poet Ottavio Rinuccini supplied a drama with the title of *Dafne*, to which Peri composed music, and this first attempt at opera was performed privately in 1597 in the Palazzo Corsi at Florence. This work was so much admired that in 1600 Rinuccini and Peri were commissioned to produce an opera on the occasion of the marriage of Henry IV. of France with Maria di' Medici. This work (*L'Euridice*) attracted a great deal of attention, and the type once publicly established, the musical drama was set on the road to success by the efforts of other composers and the patronage of other courts. Peri himself seems never to have followed up his success with other operas; he became maestro di cappella to the duke of Ferrara in 1601, but after the publication of his *Varie musiche a una, due e tre voci* at Florence in 1609, nothing more is known of him.

Peri's *Dafne* (which has entirely disappeared) and *Euridice* (printed at Florence 1600; reprinted Venice 1608 and Florence 1863) are of the greatest importance not only as being the earliest attempts at opera, but as representing the new monodic and declamatory style which is the basis of modern music as opposed to the contrapuntal methods of Palestrina and his contemporaries. Peri's work is of course primitive in the extreme, but it is by no means without beauty, and there are many scenes in *Euridice* which show a considerable dramatic power.

PERLANDER (Gr. Περλάνδρος), the second tyrant of Corinth (625-585 B.C.). In contrast with his father Cypselus, the founder of the dynasty, he is generally represented as a cruel despot, or at any rate as having used all possible devices for keeping his city in subjection. Among numerous anecdotes the following is characteristic. Perlander, on being consulted by the tyrant Thrasylbulus of Miletus as to the best device for maintaining himself in power, by way of reply led the messenger through a cornfield, and as he walked struck off the tallest and best-grown ears (a legend applied to Roman circumstances in *Livy* i. 54). It seems, however, that the prevalent Greek tradition concerning him was derived from the versions of the Corinthian aristocracy, who had good reasons for giving a prejudiced account, and the conflicting character of the various legends further shows that their historical value is slight. A careful sifting of the available evidence would rather tend to represent Perlander as a ruler of unusual probity and insight, and the exceptional firmness and activity of his government is beyond dispute. His home administration was so successful that he was able to dispense with direct taxation. He fostered wealth by the steady encouragement of industry and by drastic legislation against idleness, luxury and vice; and the highest prosperity of the Corinthian handicrafts may be assigned to the period of his rule (see *CORINTH*). At the same time he sought to check excessive accumulation of wealth in individual hands and restricted the influx of population into the town. Employment was found

PERGAMUM

PLATE I



The North Wing, West and South Sides.



The South Wing, West and South Sides.



The Great Altar of Zeus, from the North-west, as set up in the Kaiser Friedrich Museum, Berlin.

From photographs by W. Titzenthaler, Berlin.



North, South, East, and West Sides of the Great Altar of Zeus.

From photographs by W. Titzenthaler, Berlin.

for the proletariat in the erection of temples and of public works. Pericles further appears as a patron of literature, for it was by his influence that the poet Anon came to Corinth to organize the dithyramb. He devoted no less attention to the increase of Corinthian commerce, which in his days piled busily on both eastern and western seas. With this end in view he established colonies at Potidaea and Apollonia in Macedonia, at Anactorium and Leucas in north-western Greece, and he is said to have projected a canal through the Isthmus. In Greece proper he conquered Epidaurus, and with the help of his fleet of triremes brought the important trading centre of Corcyra under his control, while his interest in the Olympian festival is perhaps attested by a dedication which may be ascribed to him—the famous “chest of Cypselus.” He cultivated friendly relations with the tyrants of Miletus and Mytilene, and maintained a connexion with the kings of Lydia, of Egypt and, possibly, of Phrygia. In spite of these varied achievements Pericles never entirely conciliated his subjects, for he could not trust himself without a bodyguard. Moreover his family life, according to all accounts, was unfortunate. His sons all died or were estranged from him, and the murder of his last remaining child Lycophron, the governor of Corcyra, is said to have broken his spirit and hastened on his death.

Pericles was reckoned one of the seven sages of Greece, and was the reputed author of a collection of maxims (“*Troθήμαι*”) in 2000 verses. The letters ascribed to him by Diogenes Laërtius are undoubtedly spurious.

Herodotus iii. 48-53, v. 92; Aristotle, *Politics*, v. 6, 10-12; Heraclides Ponticus in C. Müller's *Frags. hist. graec.* ii. 212; Nicolaus Damascenus, *ibid.*, iii. 393; Diogenes Laërtius, *De vitis clarorum philosophorum*, i. ch. 7. (M. O. B. C.)

PERICLES (490-429 B.C.), Athenian statesman, was born about 490 B.C., the son of Xanthippus and Agariste. His father took a prominent part in Athenian politics, and in 479 held high command in the Greek squadron which annihilated the remnants of Xerxes' fleet at Mycale; through his mother, the niece of Cleisthenes, he was connected with the former tyrants of Sicyon and the family of the Alcmaeonidae. His early training was committed to the ablest and most advanced teachers of the day: Damon instructed him in music, Zeno the Eleatic revealed to him the powers of dialectic; the philosopher Anaxagoras, who lived in close friendship with Pericles, had great influence on his cast of thought and was commonly held responsible for that calm and undaunted attitude of mind which he preserved in the midst of the severest trials.

The first important recorded act of Pericles falls in 463, when he helped to prosecute Cimon on a charge of bribery, after the latter's Thasian campaign; but as the accusation could hardly have been meant seriously Pericles was perhaps put forward only as a lay-figure. Undue prominence has commonly been assigned to him in the attack upon the Areopagus in 462 or 461 (see **AREOPAGUS**, **CIMON**). The Aristotelian *Constitution of Athens* shows conclusively that Pericles was not the leader of this campaign, for it expressly attributes the bulk of the reforms to Ephialtes (ch. 25), and mentions Ephialtes and Archestratus as the authors of the laws which the reactionaries of 404 sought to repeal (ch. 35); moreover, it was Ephialtes,² not Pericles, on whom the Conservatives took revenge as the author of their discomfiture. To Ephialtes likewise we must ascribe the renunciation of the Spartan alliance and the new league with Argos and Thessaly (461).

Not long after, however, when Ephialtes fell by the dagger, Pericles undoubtedly assumed the leading position in the state.

¹ He must have been born before 485-484, in which years his father was ostracised. On the other hand, Plutarch describes him as *πρεσβύτης*, i.e. not yet 30, in 463.

² The later evidence of Pericles has probably misled historians into exaggerating his influence at this time. Even the *Const. Ath.* (ch. 27) says that Pericles took “some” prerogatives from the Areopagus; this looks like a conjecture based on Arist. *Pol.* ii. 9 (12), 1273; *τίμη δὲ Ἀριστοῦ πρὸς Βούλην Ἐπιβαλῆτος ἀπέλοιτο καὶ Περικλῆς*, a passage which really proves nothing. Plutarch, who is clearly blinded by Pericles' subsequent brilliance, makes him suddenly burst into prominence and hold the highest place for 40 years (i.e. from 463); he degrades Ephialtes into a tool of Pericles.

The beginning of his ascendancy is marked by an unprecedented outward expansion of Athenian power. In continuance of Cimon's policy, 200 ships were sent to support the Egyptian insurgents against Persia (459),³ while detachments operated against Cyprus and Phoenicia. At the same time Athens embarked on several wars in Greece Proper. An alliance with the Megarians, who were being hard pressed by their neighbours of Corinth, led to enmity with this latter power, and before long Epidaurus and Aegina were drawn into the struggle. On sea the Athenians, after two minor engagements, gained a decisive victory which enabled them to blockade Aegina. On land their general Myronides beat off two Corinthian attacks on Megara, which had been further secured by long walls drawn between the capital and its port Nisaea, nearly a mile distant. In 457 the Athenians and their allies ventured to intercept a Spartan force which was returning home from central Greece. At Tanagra in Boeotia a pitched battle was fought, in which both Pericles and the partisans of Cimon distinguished themselves. The Spartans were successful but did not pursue their advantage, and soon afterwards the Athenians, seizing their opportunity, sallied forth again, and, after a victory under Myronides at Oenophyta, obtained the submission of all Boeotia, save Thebes, and of Phocis and Locris. In 455 Tolmides ravaged Laconia and secured Naupactus on the Corinthian gulf; in 454⁴ Pericles himself defeated the Sicyonians, and made a descent upon Oeniadae at the mouth of the gulf, and in 453 conducted a cleruchy to the Thracian Chersonese. These years mark the zenith of Athenian greatness. Yet the drain on the country's strength was severe, and when news arrived in 453 that the whole of the Egyptian armament, together with a reserve fleet, had been destroyed by the Persians, a reaction set in, and Cimon, who was recalled on Pericles' motion (but see **CIMON**), was empowered to make peace with Sparta on the basis of the *status quo*. For a while the old anti-Persian policy again found favour in Athens, and Cimon led a great expedition against Cyprus; but on Cimon's death hostilities were suspended, and a lasting arrangement with Persia was brought about.⁵ It was probably in order to mark the definite conclusion of the Persian War and to obtain recognition for Athens' work in punishing the Mede that Pericles now⁶ proposed a pan-Hellenic congress at Athens to consult about the rebuilding of the ruined temples and the policing of the seas; but owing to the refusal of Sparta the project fell through.

Pericles may now have hoped to resume his aggressive policy in Greece Proper, but the events of the following years completely disillusioned him. In 447 an Athenian army, which had marched into Boeotia to quell an insurrection, had to surrender in a body at Coronea, and the price of their ransom was the evacuation of Boeotia. Upon news of this disaster Phocis, Locris and Euboea revolted, and the Megarians massacred their Athenian garrison, while a Spartan army penetrated into Attica as far as Eleusis. In this crisis Pericles induced the Spartan leaders to retreat, apparently by means of a bribe, and hastened to reconquer Euboea; but the other land possessions could not be recovered, and in a thirty years' truce which was arranged in 445 Athens definitely renounced her predominance in Greece Proper. Pericles' foreign policy henceforward underwent a profound change—to consolidate the naval supremacy, or to extend it by a cautious advance, remained his only ambition.

³ The chronology of these years down to 449 is not quite certain.

⁴ An abortive expedition to reinstate a Thessalian prince probably also belongs to this year; there is also evidence that Athens interfered in a war between Selinus and Segesta in Sicily about this time.

⁵ The “peace of Callias” is perhaps a fiction of the 4th century orators. All the earlier evidence goes to show that only an informal understanding was arrived at, based on the *de facto* inability of either power to cripple the other (see **CIMON**).

⁶ 448 seems the most likely date. Before 450 Pericles' influence was as yet too small; 450-451 were years of war. After 445 Athens was hardly in a position to summon such a congress, and would not have sent 10 envoys out of 20 to northern and central Greece, where she had lost all her influence; nor is it likely that the building of the Parthenon (begun not later than 447) was entered on before the congress.

While scouting the projects of the extreme Radicals for interfering in distant countries, he occasionally made a display of Athens' power abroad, as in his expedition to the Black Sea,¹ and in the colonization of Thurii,² which marks the resumption of a Western policy.

The peaceful development of Athenian power was interrupted by the revolt of Samos in 440. Pericles himself led out a fleet against the seceders and, after winning a first engagement, unwisely divided his armament and allowed one squadron to be routed. In a subsequent battle he retrieved this disaster, and after a long blockade reduced the town itself. A demand for help which the Samians sent to Sparta was rejected at the instance of the Corinthians.

Turning to Pericles' policy towards the members of the Delian League, we find that he frankly endeavoured to turn the allies into subjects (see DELIAN LEAGUE). A special feature of his rule was the sending out of numerous cleruchies (*q.v.*), which served the double purpose of securing strategic points to Athens and converting the needy proletariat of the capital into owners of real property. The land was acquired either by confiscation from disaffected states or in exchange for a lowering of tribute. The chief cleruchies of Pericles are: Thracian Chersonese (453-452), Lemnos and Imbros, Andros, Naxos and Eretria (before 447);³ Brea in Thrace (446); Oreus (445); Amisus and Astacus in the Black Sea (after 440); Aegina (431).

In his home policy Pericles carried out more fully Ephialtes' project of making the Athenian people truly self-governing. His chief innovation was the introduction of payment from the public treasury for state service. Chief of all, he provided a remuneration of 1 to 2 obols a day for the jurymen, probably in 451.⁴ Similarly he created a "theoricon" fund which enabled poor citizens to attend the dramatic representations of the Dionysia. To him we may also attribute the 3 obols pay which the soldiers received during the Peloponnesian War in addition to the old-established provision-money. The archons and members of the *boulé*, who certainly received remuneration in 411, and also some minor magistrates, were perhaps paid for the first time by Pericles. In connexion with this system of salaries should be mentioned a somewhat reactionary law carried by Pericles in 451, by which an Athenian parentage on both sides was made an express condition of retaining the franchise and with it the right of sitting on paid juries. The measure by which the archonship was opened to the third and (practically) to the fourth class of citizens (the *Zeugitæ* and *Thetes*) may also be due to Pericles; the date is now known to be 457 (*Const. Ath.* 26; and see ARCHON).

The last years of his life were troubled by a new period of storm and stress which called for his highest powers of calculation and self-control. A conflict between Corcyra and Corinth, the second and third naval powers of Greece, led to the simultaneous appearance in Athens of an embassy from either combatant (433). Pericles had, as it seems, resumed of late a plan of Western expansion by forming alliances with Rhegium and Leontini, and the favourable position of Corcyra on the trade-route to Sicily and Italy, as well as its powerful fleet, no doubt helped to induce him to secure an alliance with that island, and so to commit an unfriendly act towards a leading representative of the Peloponnesian League. Pericles now seemed to have made up his mind that war with Sparta, the head of that

League, had become inevitable. In the following spring he fastened a quarrel upon Potidæa, a town in Chalcidice, which was attached by ancient bonds to Corinth, and in the campaign which followed Athenian and Coriathian troops came to blows. A further *casus belli* was provided by a decree forbidding the importation of Megarian goods into the Athenian Empire,⁵ presumably in order to punish Megara for her alliance with Corinth (spring 432). The combined complaints of the injured parties led Sparta to summon a Peloponnesian congress which decided on war against Athens, failing a concession to Megara and Coriath (autumn 432). In this crisis Pericles persuaded the wavering assembly that compromise was useless, because Sparta was resolved to precipitate a war in any case. A further embassy calling upon the Athenians to expel the accursed family of the Alcmaeonidae, clearly aimed at Pericles himself as its chief representative, was left unheeded, and early in 431 hostilities began between Athens and Sparta and their respective allies (see PELOPONNESIAN WAR).

At the same time, Pericles was being sorely hampered by his adversaries at home. The orthodox Conservatives and some democrats who were jealous of his influence, while afraid to beard the great statesman himself, combined to assail his nearest friends. The sculptor Pheidias (*q.v.*) was prosecuted on two vexatious charges (probably in 433), and before he could disprove the second he died under arrest. Anaxagoras was threatened with a law against atheists, and felt compelled to leave Athens. A scandalous charge against his mistress Aspasia, which he defeated by his personal intercession before the court, was taken very much to heart by Pericles. His position at home scarcely improved during the war. His policy of abandoning the land defence was unpopular with the land-owning section of the people, who from the walls of Athens could see their own property destroyed by the invaders. At the end of the first year of war (early in 430) Pericles made a great appeal to the pride of his countrymen in his well-known funeral speech. But in the ensuing summer, after a terrible outbreak of plague had ravaged the crowded city, the people became thoroughly demoralized. Pericles led a large squadron to harry the coasts of the Peloponnesians, but met with little success. On his return the Athenians sued for peace, though without success, and a speech by Pericles had little effect on their spirits. Late in 430 they deposed him from his magistracy. In addition to this they prosecuted him on a charge of embezzlement, and imposed a fine of 50 talents. A revulsion of feeling soon led to his reinstatement, apparently with extraordinary powers. But the plague, which had carried off two of his sons and a sister, had left its mark also on Pericles himself. In the autumn of 429 he died⁶ and was buried near the Academia, where Pausanias (150 A.D.) saw his tomb. A slightly idealized portrait of Pericles, as *strategus* is preserved to us in the British Museum bust, No. 549, which is a good copy of the well-known bronze original by Cresilas.

If we now endeavour to give a general estimate of Pericles' character and achievements, it will be well to consider the many departments of his activity one by one. In his foreign policy Pericles differs from those statesmen of previous generations who sought above all the welfare of Greece as a whole. His standpoint was at all times purely Athenian. Nor did he combine great statesmanlike qualities with exceptional ability in the field. We may clearly distinguish two periods in his administration of foreign affairs. At first, joining to Cimon's anti-Persian ambitions and Themistocles' schemes of Western expansion a new policy of aggression on the mainland, he endeavoured to push forward Athenian power in every direction, and engaged himself alike in Greece Proper, in the Levant and in Sicily. After Cimon's death he renounced the war against Persia, and the collapse of 447-445 had the effect of completing his change.

¹ The general impression in Greece was that this decree was the proximate cause of the war. The scurrilous motives which Aristophanes suggests for this measure can be entirely disregarded.

² His dying boast, that "no Athenian had put on mourning through his doing," perhaps refers to his forbearance towards his political rivals, whom he refused to ruin by prosecution.

¹ The date can hardly be fixed; probably it was after 440.

² It has been doubted whether Pericles favoured this enterprise, but among its chief promoters were two of his friends, Lampon the soothsayer and Hippodamus the architect. The oligarch Cratinus (in a frag. of the *Thyrsidae*) violently attacks the whole project.

³ These dates are suggested by the decrease of tributes which the inscriptions prove for this year.

⁴ This is the date given by the *Const. Ath.*, which also mentions a *δωροδοκία τῶν δικαστῶν* (Blass' restoration) in frag. c. 18. The confused story of Philochorus and Plutarch, by which 4760 citizens were disfranchised or even sold into slavery in 445, when an Egyptian prince sent a largess of corn, may refer to a subsequent application of Pericles' law, though probably on a much milder scale than is here represented.

of attitude. Henceforward he repressed all projects of reckless enterprise, and confined himself to the gradual expansion and consolidation of the empire. It is not quite easy to see why he abandoned this successful policy in order to hasten on a war with Sparta, and neither the Corycraean alliance nor the Megarian decree seems justified by the facts as known to us, though commercial motives may have played a part which we cannot now gauge. In his adoption of a purely defensive policy at the beginning of the Peloponnesian War, he miscalculated the temper of the Athenians, whose morale would have been better sustained by a greater show of activity. But in the main his policy in 431-429 was sound, and the disasters of the war cannot fairly be laid to his charge. The foundation of cleruchies was an admirable device, which in many ways anticipated the colonial system of the Romans.

In his attitude towards the members of the Delian League Pericles likewise maintained a purely Athenian point of view. But he could hardly be said seriously to have oppressed the subject cities, and technically all the League money was spent on League business, for Athens, to whom the chief monuments in Athens were reared, was the patron goddess of the League. Under Pericles Athens also attained her greatest measure of commercial prosperity, and the activity of her traders all over the Levant, the Black Sea and the West, is attested not only by literary authority, but also by numerous Attic coins, vases, &c.

Pericles' home policy has been much debated since ancient times. His chief enactments relate to the payment of citizens for State service. These measures have been interpreted as an appeal to the baser instincts of the mob, but this assumption is entirely out of keeping with all we know of Pericles' general attitude towards the people, over whom Thucydides says he practically ruled as a king. We must, then, admit that Pericles sincerely contemplated the good of his fellow-countrymen, and we may believe that he endeavoured to realize that ideal Athens which Thucydides sketches in the Funeral Speech—an Athens where free and intelligent obedience is rendered to an equitable code of laws, where merit finds its way to the front, where military efficiency is found along with a free development in other directions and strangles neither commerce nor art. In accordance with this scheme Pericles sought to educate the whole community to political wisdom by giving to all an active share in the government, and to train their aesthetic tastes by making accessible the best drama and music. It was most unfortunate that the Peloponnesian War ruined this great project by diverting the large supplies of money which were essential to it, and confronting the remodelled Athenian democracy, before it could dispense with his tutelage, with a series of intricate questions of foreign policy which, in view of its inexperience, it could hardly have been expected to grapple with successfully.

Pericles also incurred unpopularity because of his rationalism in religious matters; yet Athens in his time was becoming ripe for the new culture, and would have done better to receive it from men of his circle—Anaxagoras, Zeno, Protagoras and Meton—than from the more irresponsible sophists. The influence of Aspasia on Athenian thought, though denounced unsparingly by most critics, may indeed have been beneficial, inasmuch as it tended towards the emancipation of the Attic woman from the over-strict tutelage in which she was kept. As a patron of art Pericles was a still greater force. His policy in encouraging the drama has already been mentioned: among his friends he could count three of the greatest Greek writers—the poet Sophocles and the historians Herodotus and Thucydides. Pericles likewise is responsible for the epoch-making splendour of Attic art in his time, for had he not so fully appreciated and given such free scope to the genius of Pheidias, Athens would hardly have witnessed the raising of the Parthenon and other glorious structures, and Attic art could not have boasted a legion of first-rate sculptors of whom Akamenes, Agoracritus and Paconius are only the chief names. (See also GREEK ART.)

Of Pericles' personal characteristics we have a peculiarly full

and interesting record. He was commonly compared to Olympian Zeus, partly because of his serene and dignified bearing, partly by reason of the majestic roll of the thundering eloquence, with its bold poetical imagery, with which he held friend and foe spellbound. The same dignity appeared in the grave beauty of his features, though the abnormal height of his cranium afforded an opportunity for ridicule of which the comedians made full use. In spite of an unusually large crop of scandals about him we cannot but believe that he bore an honourable character, and his integrity is vouched for by Thucydides in such strong terms as to exclude all further doubt on the question.

ANCIENT AUTHORITIES.—Our chief source must always remain Thucydides (i. and ii. 1-65), whose insight into the character and ideals of Pericles places him far above all other authorities. The speeches which he puts into his mouth are of special value in disclosing to us Pericles' inmost thoughts and aspirations (i. 140-144; ii. 34-46; ii. 60-64). Thucydides alone shows sympathy with Pericles, though, as J. B. Bury points out (*Ancient Greek Historians*, 1909, pp. 133 seq.), he was by no means a blind admirer. Of other 5th-century sources, Aristophanes is obviously a caricaturist, pseudo-Xenophon (*de republica Atheniensium*) a mere party pamphleteer. Plato, while admiring Pericles' intellect, accuses him of pandering to the mob; Aristotle in his *Politics* and especially in the *Constitution of Athens*, which is valuable in that it gives the dates of Pericles' enactments as derived from an official document, accepts the same view. Plutarch (*Pericles*) gives many interesting details as to Pericles' personal bearing, home life, and patronage of art, literature and philosophy, derived in part from the old comic poets, Aristophanes, Cratinus, Eupolis, Hermippus, Plato and Teleclides; in part from the contemporary memoirs of Stesimbrotus and Ion of Chios. At the same time he reproduces their scandalous anecdotes in a quite uncritical spirit, and accepts unquestioningly the 4th-century tradition. He quotes Aristotle, Heraclides Ponticus, Aeschines Socraticus, Idomeneus of Lampsacus and Duris of Samos, and is also indebted through some Alexandrine intermediary to Ephorus and Theopompus. Diodorus (xi. and xii.), who copied Ephorus, contains nothing of value.

MODERN WORKS.—Historians are agreed that Pericles was one of the most powerful personalities of ancient times, and generally allow him to have been a man of probity. J. Beloch, *Griech. Gesch.*, vols. i. and ii. (Strassburg and Bonn, 1893-1896), and *Die altische Politik seit Perikles* (Leipzig, 1884) takes the most disparaging view; E. Abbott, *Greek Hist.*, vol. ii. (London, 1892), and M. Dusscher, *Gesch. d. Altertums*, vols. viii., ix. (Leipzig, 1884-1886), are on the whole unfavourable; Adolf Schmidt, *Das Perikleische Zeitalter* (Jena, 1877), V. Duruy, *History of Greece* (Eng. trans., London, 1892), G. Busolt, *Griech. Gesch.*, vol. iii. (Gotha, 1897, 1904), and E. Meyer, *Gesch. d. Altertums*, vols. iii. and iv. (Stuttgart, 1901), *Forschungen*, vol. ii. (Halle, 1899; London, 1902), apportion praise and blame more equally; J. B. Bury and E. Curtius, *Hist. of Greece* (Eng. trans., vol. ii. and iii., London, 1869, 1870), A. Holm, *Hist. of Greece* (Eng. trans., vol. ii., London, 1895), W. Lloyd, *The Age of Pericles* (London, 1875), and especially G. Grote, *Hist. of Greece*, vols. iv. and v. (see also additional notes in the edition by J. M. Mitchell and M. Caspari, 1907) take a favourable view. For Pericles' buildings, see C. Wachsmuth, *Gesch. d. Stadt Athen*, i. 316-360 (Leipzig, 1874); E. A. Gardner, *Ancient Athens* (London, 1902), for his strategy, H. Delbrück, *Die Strateg. d. Perikles* (Berlin, 1890). See *ATHENS: HISTORY; GREECE: Ancient History; and GREEK ART.* (M. O. B. C.)

PERIDOT, sometimes written peridote, a name applied by jewelers to "noble olivine," or that kind of olivine which can be used as a gem-stone (see OLIVINE). The word peridot is an old trade-term, of unknown origin, used by French jewelers and introduced into science by J. R. Haüy. Peridot is practically the same stone as chrysolite (q.v.), though it is convenient to restrict that term to transparent olivine of pale yellowish green colour, and to apply the term peridot to those kinds which are darker and decidedly green: the colour, which is due to the presence of ferrous iron, is never vivid, like that of emerald, but is usually some shade of olive-, pistachio- or leek-green. Although the stone is sometimes cut *en cabochon*, and in rose-form, the cutting best adapted to display the colour is that of a table or a step-cut stone. Unfortunately the hardness of peridot is only about 6.5, or but little above that of glass, so that the polished stone readily suffers abrasion by wear. In polishing peridot the final touch is given on a copper wheel moistened with sulphuric acid.

Although olivine has a fairly wide distribution in nature, the varieties used as gem-stones are of very limited occurrence. Much mystery for a long time surrounded the locality which

little most of the peridot of commerce but it is now identified with the island of Mt. John, or Isle Zebolget, in the Red Sea, where it occurs, as shown by M. J. Couyat, in an altered dunite, or olivine rock (*Bull. soc. franç. min.*, 1908). This is probably the 'Ivian lala, *rovdáfov ávov*, of the ancients. It is generally held that the mineral now called topaz was unknown to ancient and mediæval writers, and that their *rovdáfov* was our peridot. Much was probably the Hebrew *pidlak*, translated topaz in the Old Testament. Dr G. F. Kunz has suggested that the peridot of modern trade are largely derived from old jewelry. The famous shrine of the Three Kings in Cologne Cathedral contains a large peridot, which has commonly been regarded as an emerald. It is notable that pebbles of transparent olivine, fit for cutting, are found in the United States in Montana, Arizona and New Mexico; in consequence of their shape and curiously pitted surface they are known as "Job's tears." (F. W. R.)

PERIDOTITE, a plutonic holo-crystalline rock composed in large part of olivine, and almost or entirely free from feldspar. The rocks are the most basic, or least siliceous plutonic rocks, and contain much iron oxide and magnesia. Hence they have dark colours and a high specific gravity (3.0 and over). They weather readily and are changed to serpentine, in which process water is absorbed and enters into chemical combination with the silicates of magnesia and iron. In some peridotites, such as the dunites, olivine greatly preponderates over all other minerals. It is always in small, rather rounded crystals without good crystalline form, and pale green in colour. Most of the rocks of this group, however, contain other silicates such as augite, hornblende, biotite or rhombic pyroxene, and often two or three of these are present. By the various mineral combinations different species are produced, e.g. mica-peridotite, hornblende-peridotite, enstatite-peridotite. Of the accessory minerals the commonest are iron oxides and chromite or picotite. In some peridotites these form segregations or irregular masses which are of importance as sources of the ores of chromium. Corundum occurs in small crystals in many North American peridotites and platinum and the nickel-iron compound awaruite are found in rocks of this class in New Zealand. Red garnet (pyrope) characterizes the peridotites of Bohemia. The diamond mines of South Africa are situated in pipes or volcanic necks occupied by a peridotite breccia which has been called kimberlite. In this rock in addition to diamond the following minerals are found, hypersthene, garnet, biotite, pyroxene (chrome-diopside), ilmenite, zircon, &c.

Some peridotites have a granular structure, e.g. the dunites, all the crystal grains being of rounded shape and nearly equal size; a few are porphyritic with large individuals of diallage, augite or hypersthene. Some are banded with parallel bands of dissimilar composition, the result probably of fluxion in a magma which was not quite homogeneous. The great majority of the rocks of this group are poikilitic, that is to say, they contain olivine in small rounded crystals embedded in large irregular masses of pyroxene or hornblende. The structure is not unlike that known as ophitic in the dolerites, and arises from the olivine having first separated out of the liquid magma while the pyroxene or amphibole succeeded it and caught up its crystals. In hand specimens of the rocks the smooth and shining cleavage surfaces of hornblende and augite are dotted over with dull blackish green spots of olivine; to this appearance the name "lustre-mottling" has been given.

Mica-peridotites are not of frequent occurrence. A well-known rock from Kaltes Thal, Harzburg, contains much biotite, deep brown in thin section. Other examples are found in India and in Arkansas. Poikilitic structure is rarely well developed in this group. The "blue-ground" of Kimberley which contains the diamonds is a brecciform biotite-hypersthene-peridotite with augite. In the north of Scotland, in several places in Sutherland and Ross, there are peridotites with silvery yellow green biotite and large plates of pale green hornblende: these have been called scyellites. In the hornblende-peridotites lustre-mottling is often very striking. The amphibole may be colourless tremolite in small prisms, as in some varieties of serpentine from the Lizard (Cornwall); or pale green hornblende as in scyelite. In both these cases there is some probability that the hornblende has developed, partly at least, from olivine or augite. In sheared peridotites tremolite and

actinolite are very frequent. Other rocks contain dark brown hornblende, with much olivine; there may also be augite which is often intergrown perthitically with the hornblende. Examples of this type occur in North Wales, Anglesey, Cornwall, Cortland, New York, and many other localities. A well-known peridotite from Schriesheimer Tal in the Odenwald has pale brownish green amphibole in large crystals filled with small grains of olivine which are mostly serpentinized. Very often primary brown hornblende in rocks of this type is surrounded by fringes and outgrowths of colourless tremolite which has formed as a secondary mineral after olivine. Complete pseudomorphs after olivine composed of a matrix of scaly talc and chlorite crossed by a network of tremolite needles, are also very common in some peridotites, especially those which have undergone pressure or shearing: these aggregates are known as pillite.

The peridotites which contain monoclinic pyroxene may be divided into two classes, those rich in diallage and those in which there is much augite. The diallage-peridotites have been called wehrilites; often they show excellent lustre-mottling. Brown or green hornblende may surround the diallage, and hypersthene may occur also in lamellar intergrowth with it. Some of these rocks contain biotite, while a little feldspar (often saussuritic) may often be seen in the sections. Rocks of this kind are known in Hungary, in the Odenwald and in Silesia. In Skye the pyroxene-bearing peridotites usually contain green chrome-diopside (a variety of augite distinguished by its pale colour and the presence of a small amount of chromium). The augite-peridotites are grouped by German petrographers under the picrites, but this term has a slightly different signification in the English nomenclature (see PICRITE).

The enstatite-peridotites are an important group represented in many parts of the world. Their rhombic pyroxene is often very pale coloured but may then be filled with platy enclosures which give it a metallic or bronzy lustre. These rocks have been called saxonites or harzburgites. When weathered the enstatite passes into platy masses of bastite. Picotite and chromite are common accessory minerals and diallage or hornblende may also be present. Many of the serpentine rocks of the Lizard (Cornwall) Arrshire and north-western Scotland are of this type. Examples are known also from Bastie near Harzburg, New York and Maryland, Norway, Finland, New Zealand, &c. Often the enstatite crystals are of large size and are very conspicuous in the hand specimens. They may be porphyritic, or may form a coarsely crystalline matrix enclosing innumerable olivine grains, and then lustre-mottling is as a rule very well shown.

The ilherzolites are rocks, first described from Lherz in the Pyrenees, consisting of olivine, chrome-diopside and enstatite, and accessory picotite or chromite. They are fine-grained, bright green in colour, often very fresh, and may be somewhat granitic. The dunites are peridotites, similar to the rock of Dun Mountain, New Zealand, composed essentially of olivine in a finely granular condition. Many examples of this type are known in different parts of the world, usually as local facies of other kinds of peridotite. In olivine-basalts of Tertiary age in the Rhine district small nodules of green olivine occur frequently. They are of rounded shapes and may be a foot in diameter. The structure is granular and in addition to olivine they may contain chromite, spinel and magnetite, enstatite and chrome-diopside. Some geologists believe these to be fragments of dunite detached from masses of that rock not exposed at the surface; others consider that they are aggregations of the early minerals of the basalt magma, which were already crystallized before the liquid rock was emitted.

The great majority of stony or lithoidal meteorites (aerolites) are rich in olivine and present many analogies to the terrestrial peridotites. Among their minerals are hypersthene (enstatite) augite and chrome-diopside, chromite, pyrite and troilite, nickeliferous iron and basic plagioclase feldspar. The structure of these meteorites is described as "chondritic"; their minerals often occur as small rounded grains arranged in radiate clusters; this has very rarely been observed in ordinary peridotites.

Although many peridotites are known in which the constituent minerals are excellently preserved, the majority show more or less advanced decomposition. The olivine is especially unstable and is altered to serpentine, while augite, hornblende and biotite are in large measure fresh. In other cases the whole rock is changed to an aggregate of secondary products. Most serpentines (q.v.) arise in this way. (J. S. F.)

PÉRIER, CASIMIR PIERRE (1777-1832), French statesman, was born at Grenoble on the 11th of October 1777, the fourth son of a rich banker and manufacturer, Claude Périer (1748-1801), in whose house the estates of Dauphiny met in 1788. Claude Périer was one of the first directors of the Bank of France; of his eight sons, Augustin (1773-1833), Antoine Scipion (1776-1821), Casimir Pierre and Camille (1781-1844), all distinguished themselves in industry and in politics. The family removed to Paris after the revolution of Thermidor, and Casimir joined the army of Italy in 1798. On his father's death he left the

army and with his brother Scipion founded a bank in Paris, the speculations of which he directed while Scipion occupied himself with its administration. He opposed the ruinous methods by which the duc de Richelieu sought to raise the war indemnity demanded by the Allies, in a pamphlet *Réflexions sur le projet d'emprunt* (1817), followed in the same year by *Dernières réflexions* . . . in answer to an inspired article in the *Moniteur*. In the same year he entered the chamber of deputies for Paris, taking his seat in the Left Centre with the moderate opposition, and making his first speech in defence of the freedom of the press. Re-elected for Paris in 1822 and 1824, and in 1827 for Paris and for Troyes, he elected to represent Troyes, and sat for that constituency until his death. Périér's violence in debate was not associated with any disloyalty to the monarchy, and he held resolutely aloof from the republican conspiracies and intrigues which prepared the way for the revolution of 1830. Under the Martignac ministry there was some prospect of a reconciliation with the court, and in January 1829 he was nominated a candidate for the presidency of the chamber; but in August with the elevation to power of Polignac the truce ceased, and on the 15th of March 1830 he was one of the 221 deputies who repudiated the pretensions put forward by Charles X. Averse by instinct and by interest to popular revolution he nevertheless sat on the provisory commission of five at the hôtel-de-ville during the days of July, but he refused to sign the declaration of Charles X.'s dethronement. Périér reluctantly recognized in the government of Louis Philippe the only alternative to the continuance of the Revolution; but he was no favourite with the new king, whom he scorned for his truckling to the mob. He became president of the chamber of deputies, and sat for a few months in the cabinet, though without a portfolio. On the fall of the weak and discredited ministry of Laffitte, Casimir Périér, who had drifted more and more to the Right, was summoned to power (March 13, 1831), and in the short space of a year he restored civic order in France and re-established her credit in Europe. Paris was in a constant state of disturbance from March to September, and was only held in check by the premier's determination; the workmen's revolt at Lyons was suppressed after hard fighting; and at Grenoble, in face of the quarrels between the military and the inhabitants, Périér declined to make any concession to the townsfolk. The minister refused to be dragged into armed intervention in favour of the revolutionary government of Warsaw, but his policy of peace did not exclude energetic demonstrations in support of French interests. He constituted France the protector of Belgium by the prompt expedition of the army of the north against the Dutch in August 1831; French influence in Italy was asserted by the audacious occupation of Ancona (Feb. 23, 1832); and the refusal of compensation for injuries to French residents by the Portuguese government was followed by a naval demonstration at Lisbon. Périér had undertaken the premiership with many forebodings, and overwork and anxiety prepared the way for disease. In the spring of 1832 during the cholera outbreak in Paris, he visited the hospitals in company with the duke of Orleans. He fell ill the next day of a violent fever, and died six weeks later, on the 16th of May 1832.

His *Opinions et discours* were edited by A. Lestour (2 vols., 1838); C. Nicoullaud published in 1894 the first part (*Casimir-Périér, député de l'opposition, 1817-1830*) of a study of his life and policy; and his ministry is exhaustively treated by Thureau-Dangin in vols. i. and ii. (1884) of his *Histoire de la monarchie de juillet*.

His elder son, AUGUSTE VICTOR LAURENT CASIMIR PÉRIÉR (1811-1876), the father of President Casimir-Périér (see CASIMIR-PÉRIÉR), entered the diplomatic service, being attached successively to the London, Brussels and St Petersburg embassies, and in 1843 became minister plenipotentiary at Hanover. In 1846 he resigned from the service to enter the legislature as deputy for the department of Seine, a constituency which he exchanged for Aube after the Revolution of 1848. On the establishment of the Second Empire he retired temporarily from public life, and devoted himself to economic questions on which he published a series of works, notably *Les Finances et la*

politique (1863), dealing with the interaction of political institutions and finance. He contested Grenoble unsuccessfully in 1863 against the imperial candidate, Casimir Royer; and failed again for Aube in 1869. In 1871 he was returned by three departments to the National Assembly, and elected to sit for Aube. He was minister of the interior for a few months in 1871-1872, and his retirement deprived Thiers of one of the strongest elements in his cabinet. He also joined the short-lived ministry of May 1873. He consistently opposed all efforts in the direction of a monarchical restoration, but on the definite constitution of the republic became a life senator, declining MacMahon's invitation to form the first cabinet under the new constitution. He died in Paris on the 6th of June 1876.

For the family in general see E. Choulet, *La Famille Casimir-Périér* (Grenoble, 1894).

PÉRIGÉE (Gr. *περ*, near, *γη*, the earth), in astronomy that point of the moon's orbit or of the sun's apparent orbit at which the moon or sun approach nearest to the earth. The sun's perigee and the earth's perihelion are so related that they differ 180° in longitude, the first being on the line from the earth toward the sun, and the second from the sun toward the earth. The longitude of the solar perigee is now 101°, that of the earth's perihelion 281°.

PÉRIGORD, one of the old provinces of France, formed part of the military government of Guienne and Gascony, and was bounded on the N. by Angoumois, on the E. by Limousin and Quercy, on the S. by Agenais and Bazadais, and on the W. by Bordelais and Saintonge. It is now represented by the departments of Dordogne and part of Lot-et-Garonne. Périgord was in two divisions: Périgord blanc (cap. Périgueux) and Périgord noir (cap. Sarlat). In the time of Cæsar it formed the *civitas Petrocoriorum*, with Vesunna (Périgueux) as its capital. It became later part of *Aquitania secunda* and formed the *pagus petragoricus*, afterwards the diocese of Périgueux. Since the 8th century it had its own counts (see the *Histoire généalogique* of P. Anselme, tome iii.), who were feudatories of the dukes of Aquitaine and in the 13th century were the vassals of the king of England. In the 15th century the county passed into the hands of the dukes of Orleans, and in the 16th came to the family of d'Albret, becoming Crown land again on the accession of Henry IV.

See Desmottes, *Histoire du Périgord* (1868), the Bulletin of the Société historique et archéologique du Périgord (1874 seq.), *l'Inventaire sommaire de la "Collection de Périgord"* in the Bibliothèque nationale (1874); the *Dictionnaire topographique du département de la Dordogne* by the Vicomte de Gourgues (1873).

PÉRIGUEUX, a town of south-western France, formerly capital of the old province of Périgord, now chief town of the department of Dordogne, 79 m. N.E. of Bordeaux, on the railway between that city and Limoges. Pop. (1906), 28,199. The town, situated on an eminence on the right bank of the Isle, is divided into three parts. On the slope of the hill is the medieval town, bordered south-east by the river and on the other three sides by esplanades and promenades; to the west is the modern town, which stretches to the station; to the south of the modern town is the old Roman town or *castrum*, now traversed by the railway.

Three bridges connect Périgueux with the left bank of the Isle, where stood Vesunna, the capital of the Petrocorii. Hardly a trace of this old Gallic town remains, but not far off, on the Plateau de la Boissière, the rampart of the old Roman camp can still be traced. On the right bank of the Isle, in the Roman city, there have been discovered some baths of the 1st or 2nd century, supplied by an aqueduct four miles long, which spanned the Isle. A circular building, called the "Tower of Vesunna," 68 ft. in diameter and 89 ft. in height, stands at what was formerly the centre of the city, where all the chief streets met. It is believed to have been originally the cella or main part of a temple, probably dedicated to the tutelary deities of Vesunna. Of the amphitheatre there still remain huge fragments of wall and vaulting. The building had a diameter of 1312 ft., that of the arena being 870 ft.; and, judging from its construction,

must be as old as the 3rd or even the 2nd century. The counts of Périgueux used it for their château, and lived in it from the 12th to the end of the 14th century. In 1644 it was given over by the town to the Order of the Visitation, and the sisters took from it the stones required for the construction of their nunnery. The most remarkable, however, of the ruins of the *cité* is the Château Barrière, an example of the fortified houses formerly common there. Two of its towers date from the 3rd or 4th century, and formed part of the fortified encinte; the highest tower is of the 10th century; and the part now inhabited is of the 11th or 12th century, and was formerly used as a burial chapel. The bulk of the château is of the 12th, and some of the windows of the 16th century.

The chief medieval building in the *cité* is the church of St Étienne, once the cathedral. It dates from the 11th and 12th centuries, but suffered much injury at the hands of the Protestants in the religious wars when the tower and two of the three cupolas were destroyed. The choir and its cupola were skilfully restored in the 17th century. A fine carved wooden retables of the 17th century and a tomb of a bishop of the 12th century are to be seen in the interior. In the medieval town, known as Le Puy-St-Front, the most remarkable building is the cathedral of St Front, which, till its restoration, or rather rebuilding, in the latter half of the 19th century when the old features were to a great extent lost, was of unique architectural value. It bears a striking resemblance to the Byzantine churches and to St Mark's at Venice, and according to one theory was built from 984 to 1047, contemporaneously with the latter (977-1085). It consists of five great cupolas, arranged in the form of a Greek cross, and conspicuous from the outside. The arms of the cross are 69 ft. in width, and the whole is 184 ft. long. These cupolas, 89 ft. high from the keystone to the ground, are supported on a vaulted roof with pointed arches after the manner characteristic of Byzantine architecture. The pointed arches imitated from it prepared the way for the introduction of the Gothic style. Adjoining St Front on the west are the remains of an old basilica of the 6th century, above which rises the belfry, the only one in the Byzantine style now extant. It dates from the 11th century, and is composed of two massive cubes, placed the one above the other in retreat, with a circular colonnade surmounted by a dome. To the south-west of St Front, the buildings of an old abbey (11th to 16th century) surround a cloister dating chiefly from the 13th century. Of the fortifications of Puy St Front, the chief relic is the Tour Mataguerre (14th century).

Périgueux is seat of a bishop, prefect and court of assizes, and has tribunals of first instance and of commerce, a chamber of commerce and a branch of the Bank of France. Its educational establishments include a lycée for boys, training colleges for both sexes and a school of drawing. The trade of the town is in pigs, truffles, flour, brandy, poultry and pies known as *piéts de Périgord*.

Vesunna was the capital of the Pétrocorii, allies of Vercingetorix when Caesar invaded Gaul. The country was afterwards occupied by the Romans, who built a second city of Vesunna on the right bank of the Isle opposite the site of the Gallic town. The barbarian invasion brought this prosperity to a close. St Front preached Christianity here in the 4th century and over his tomb there was raised a monastery, which became the centre of the new town called Le Puy St Front. The *cité* was pillaged by the Saracens about 731, and in 844 the Normans devastated both quarters. The new town soon began to rival the old city in importance, and it was not until 1240 that the attempts of the counts of Périgord and the bishops to infringe on their municipal privileges brought about a treaty of union. During the Hundred Years' War, Périgueux was twice attacked by the English, who took the *cité* in 1356; and the whole town was ceded to them by the Treaty of Brétigny, but returned to the French Crown in the reign of Charles V. The county passed by marriage into the hands of Anthony of Bourbon, father of Henry IV., and was converted by the latter into royal domain. During the Huguenot wars Périgueux was frequently

a stronghold of the Calvinists, who in 1575 did great destruction there, and it also suffered during the troubles of the Fronde.

PERIHELION (Gr. *peri*, near, *helios*, sun), in astronomy, the point of nearest approach of a body to the sun. (See ORBIT.)

PERIM, a British island in the strait of Bab-el-Mandeb, at the entrance to the Red Sea, and 96 m. W. by S. of Aden. Perim is 2 m. from the Arabian shore, is about $\frac{1}{2}$ m. long with an average breadth of over a mile and covers some 7 sq. m. There is a good harbour with easy entrance on the south side with a depth of water from 25 to 30 ft. It is largely used by mercantile vessels as a coaling-station and for taking in stores, including fresh water and ice. Perim, the Diodoros island of the *Periplus*, was, in consequence of the French occupation of Egypt, garrisoned from 1799 to 1801 by a British force. In view of the construction of the Suez Canal and the increasing importance of the Red Sea route to India the island was annexed to Great Britain in 1857, fortified and placed under the charge of the Aden residency. In 1861 a lighthouse was built at its eastern end. Submarine cables connect the island with Aden, Egypt and Zanzibar. Population, including a garrison of 50 sepoys, about 200.

PERINO DEL VAGA (1500-1547), a painter of the Roman school, whose true name was PERINO (or PIERO) BUONACCORSI. He was born near Florence on the 28th of June 1500. His father ruined himself by gambling, and became a soldier in the invading army of Charles VIII. His mother dying when he was but two months old, he was suckled by a she-goat; but shortly afterwards he was taken up by his father's second wife. Perino was first apprenticed to a druggist, but soon passed into the hands of a mediocre painter, Andrea da Ceri, and, when eleven years of age, of Ridolfo Ghirlandajo. Perino rapidly surpassed his fellow-pupils, applying himself especially to the study of Michelangelo's great cartoon. Another mediocre painter, Vaga from Toscanella, undertook to settle the boy in Rome, but first set him to work in Toscanella. Perino, when he at last reached Rome, was utterly poor, and with no clear prospect beyond journey-work for trading decorators. He, however, studied with great severity and spirit from Michelangelo and the antique, and was eventually entrusted with some of the subordinate work undertaken by Raphael in the Vatican. He assisted Giovanni da Udine in the stucco and arabesque decorations of the loggie of the Vatican, and executed some of those small but finely composed scriptural subjects which go by the name of "Raphael's Bible"—Raphael himself furnishing the designs. Perino's examples are: "Abraham about to sacrifice Isaac," "Jacob wrestling with the Angel," "Joseph and his Brethren," the "Hebrews crossing the Jordan," the "Fall and Capture of Jericho," "Joshua commanding the Sun to stand still," the "Birth of Christ," "His Baptism" and the "Last Supper." Some of these are in bronze-tint, while others are in full colour. He also painted, after Raphael's drawings, the figures of the planets in the great hall of the Appartamento Borgia. Perino exhibited very uncommon faculty in these works and was soon regarded as second only to Giulio Romano among the great painter's assistants. To Raphael himself he was always exceedingly respectful and attentive, and the master loved him almost as a son. He executed many other works about Rome, always displaying a certain mixture of the Florentine with the Roman style.

After Raphael's death in 1520 a troublous period ensued for Perino, with a plague which ravaged Rome in 1523, and again with the sack of that city in 1527. Then he accepted an invitation to Genoa, where he was employed in decorating the Doria Palace, and rapidly founded a quasi-Roman school of art in the Ligurian city. He ornamented the palace in a style similar to that of Giulio Romano in the Mantuan Palazzo del Tè, and frescoed historical and mythological subjects in the apartments, fanciful and graceful arabesque work, sculptural and architectural details—in short, whatever came to hand. Among the principal works are: the "War between the Gods and Giants," "Horatius Cocles defending the Bridge," and the "Fortitude

of Mutius Scaevola." The most important work of all, the "Shipwreck of Aeneas," is no longer extant. From Genoa Perino twice visited Pisa, and began some painting in the cathedral. Finally he returned to Rome, where Paul III. allowed him a regular salary till the painter's death. He retouched many of the works of Raphael, and laboured hard on his own account, undertaking all sorts of jobs, important or trivial. Working for any price, he made large gains, but fell into mechanical negligence. Perino was engaged in the general decoration of the Sala Reale, begun by Paul III., when his health, undermined by constant work and as constant irregularities, gave way, and he fell down dead on the 19th of October 1547. He is buried in the Pantheon.

Perino produced some excellent portraits, and his smaller oil pictures combine with the manner of Raphael something of that of Andrea del Sarto. Many of his works were engraved, even in his own lifetime. Daniele Ricciarelli, Girolamo Siciliano da Sernoneta, Luzzo Romano and Marcello Venusti (Mantovano) were among his principal assistants. (W. M. R.)

PERINTHUS (Turk. *Eski Eragli*, old Heraclea), an ancient town of Thrace, on the Propontis, 22 m. W. of Selymbria, strongly situated on a small peninsula on the bay of that name. It is said to have been a Samian colony, founded about 599 B.C. According to Tzetzes, its original name was Mygdonia; later it was called Heraclea (Heraclea Thraciae, Heraclea Perinthus). It is famous chiefly for its stubborn and successful resistance to Philip II. of Macedonia in 340; at that time it seems to have been more important than Byzantium itself.

PERIOD (Gr. *περίοδος*, a going or way round, circuit, *sept.* round, and *ódos*, way, road), a circuit or course of time, a cycle; particularly the duration of time in which a planet revolves round its sun, or a satellite round its primary, a definite or indefinite recurring interval of time marked by some special or peculiar character, e.g. in history, literature, art, &c.; it is so used of a division of geological time. Particular uses of the word are for the various phases through which a disease passes, the termination or conclusion of any course of events; the pause at the end of a completed sentence, and the mark (.) used to signify the same (see PUNCTUATION).

PERIODICALS, a general term for literary publications which appear in numbers or parts at regular intervals of time—as a rule, weekly, monthly or quarterly. The term strictly includes "newspapers" (*q.v.*), but in the narrower sense usually intended it is distinguished as a convenient expression for periodical publications which differ from newspapers in not being primarily for the circulation of news or information of ephemeral interest, and in being issued at longer intervals. In modern times the weekly journal has become so much of the nature of a newspaper that it seldom can be called a periodical in this sense. The present article chiefly deals with publications devoted to general literature, literary and critical reviews and magazines for the supply of miscellaneous reading. In the article SOCIETIES (*q.v.*) an account is separately given of the transactions and proceedings of learned and scientific bodies. Year-books, almanacs, directories and other annuals belong to a distinct type of publication, and are not referred to here.

BRITISH

The first literary periodical in English was the *Mercurius librariorum*, or a *Faithful Account of all Books and Pamphlets* (1680), a mere catalogue, published weekly or fortnightly in London, followed by *Weekly Memorials for the Ingenious* (Jan. 16, 1681–1682 to Jan. 15, 1683), which was more of the type of the *Journal des Savants* (see under FRANCE below), whence it borrowed many contributions. Of the *History of Learning* (1691)—another with the same title came out in 1694—only a few numbers appeared, as the conductor, De la Croix, started the monthly *Works of the Learned* (Aug. 1691 to April 1692), devoted principally to continental scholarship. The monthly *Compleat Library* (1692 to 1694) was a venture of John Buntoun; the monthly *Memoirs for the Ingenious* (1693), edited by J. de la Croix, ran for 12 months, and another with the same title appeared in the following year, only to enjoy a briefer career. The first periodical of merit and influence was the *History of the Works of the Learned* (1699–1712), largely consisting of descriptions of foreign books. The *Memoirs of Literatures*, the first English review consisting entirely of original matter, published in London from 1710 to 1714, had for editor Michel de la Roche, a French Protestant

refugee, who also edited at Amsterdam the *Bibliothèque anglaise* (1717–1749), and subsequently *Mémoires illustrés de la Grande Bretagne* (1720–1724). Returning to England in 1725, he recommenced his *New Memoirs of Literature* (1725–1728), a monthly, and in 1730 a *Literary Journal*. Dr Samuel Jebb started *Bibliotheca Hæroica* (1722–1724), to appear every two months, which dealt with medals and antiquities as well as with literature, but only ten numbers appeared. The *Present State of the Republick of Letters* was commenced by Andrew Reid in January 1728, and completed in December 1736. It contained not only excellent reviews of English books but papers from the works of foreigners. Two volumes came out each year. It was successful, as also was the *História literaria* (1730–1734) of Archibald Bower; the *Bea, or Universal Weekly Pamphlet* (1733–1735) of the unfortunate Eustace Budgell, and the *Literary Magazine* (1735–1736), with which Ephraim Chambers had much to do, were short-lived. The last named was continued in 1737 as the *History of the Works of the Learned*, and was carried on without intermission until 1743, when its place was taken by a *Literary Journal* (Dublin, 1744–1749), the first review published in Ireland. The *Museum* (1746) of R. Dodsley united the character of a review of books with that of a literary magazine. It came out fortnightly to the 12th of September 1747. Although England can show nothing like the *Journal des savants*, which has flourished almost without a break for two and a half centuries, a nearly complete series of reviews of English literature may be made up from 1681 to the present day.

After the close of the first quarter of the 18th century the literary periodical began to assume more of the style of the modern review, and in 1749 the title and the chief features were united in the *Monthly Review*, established by Ralph Griffiths,¹ who conducted it until 1803, whence it was edited by his son down to 1825. It came to an end in 1845. From its commencement the *Review* dealt with science and literature, as well as with literary criticism. It was Whig in politics and Nonconformist in theology. The first series ran from 1749 to December 1789, 81 vols.; the second from 1790 to 1815, 108 vols.; the third or new series from 1826 to 1830, 15 vols.; and the fourth from 1831 to 1845, 45 vols. When the magazine stopped. There is a general index (1749–1789) 3 vols., and another (1790–1816), 2 vols.

The Tory party and the established church were defended in the *Critical Review* (1756–1817), founded by Archibald Hamilton and supported by Smollett, Dr Johnson and Robertson. Johnson contributed to fifteen numbers of the *Literary Magazine* (1756–1758). The reviews rapidly increased in number towards the end of the century. Among the principal were the *London Review* (1775–1780), a *New Review* (1782–1786), the *English Review* (1783–1796) incorporated in 1797 with the *Analytical Review* (1788–1799), the *Anti-Jacobin Review and Magazine* (1798–1821), and the *British Critic* (1793–1843), the organ of the High Church party, and first edited by Archdeacon Nares and Beloe.

These periodicals had now become extremely numerous, and many of the leading London publishers found it convenient to maintain their own particular organs. It is not a matter of surprise, therefore, that the authority of *Quarterlies*, the reviews should have fallen somewhat in public estimation. The time was ripe for one which should be quite independent of the booksellers, and which should also aim at a higher standard of excellence. As far back as 1755 Adam Smith, Blair and others had produced an *Edinburgh Review* which only ran to two numbers, and in 1773 Gilbert Stuart and William Smellie issued during three years an *Edinburgh Magazine and Review*. To Edinburgh is also due the first high-class critical journal, the *Edinburgh Review*, established in October 1802 by Jeffrey, Scott, Horner, Brougham and Sydney Smith. It created a new era in periodical criticism, and assumed from the commencement a wider range and more elevated tone than any of its predecessors. The first editor was Sydney Smith, then Jeffrey for many years, and later editors were Macvey Napier, William Empson, Sir G. C. Lewis, Henry Reeve and the Hon. Arthur Elliot. Its buff and blue cover was adopted from the colours of the Whig party whose political principles it advocated. Among its more famous contributors were Lord Brougham, Sir Walter Scott, Carlyle, Hazlitt and Macaulay. Scott, being dissatisfied with the new review, persuaded John Murray, his London publisher, to start its brilliant Tory competitor, the *Quarterly Review* (Feb. 1809), first edited by William Gifford, then by Sir J. T. Coleridge, and subsequently by S. G. Lockhart, Rev. Whitwell Etwin, W. M. Macpherson, Sir Wm. Smith, Rowland Prothero and G. W. Prothero. Among the contributors in successive years were Canning, Scott (who reviewed himself), Robert Southey,

¹ Archibald Bower (1686–1766) was educated at Douai, and became a Jesuit. He subsequently professed himself a convert to the Anglican Church, and published a number of works, but was more esteemed for his ability than for his moral character.

² The biographers of Goldsmith have made us familiar with the name of Griffiths (1720–1803), the prosperous publisher, with his diploma of LL.D. granted by an American university, and with the quarrels between him and the poet.

Sir John Barrow, J. Wilson Croker, Isaac Disraeli, A. W. Kinglake, Lord Salisbury and W. E. Gladstone. The *Westminster Review* (1824), established by the followers of Jeremy Bentham, advocated radical reforms in church, state and legislation. In 1836 it was joined to the *London Review* (1829), founded by Sir William Molesworth, and then bore the name of the *London and Westminster Review* till 1851, when it returned to the original title. Other quarterly reviews worth mentioning are the *Eclectic Review* (1805-1868), edited down to 1834 by Josiah Conder (1789-1855) and supported by the Dissenters; the *British Review* (1811-1825); the *Christian Remembrancer* (1819-1868); the *Retrospective Review* (1820-1826, 1828, 1853-1854), for old books; the *Foreign Quarterly Review* (1827-1846), afterwards incorporated with the *Westminster*; the *Foreign Review* (1828-1829); the *Dublin Review* (1836), a Roman Catholic organ; the *Foreign and Colonial Quarterly Review* (1843-1847); the *Prospective Review* (1845-1855), given up to theology and literature, previously the *Christian Teacher* (1835-1844); the *North British Review* (1844-1871); the *British Quarterly Review* (1845), successor to the *British and Foreign Review* (1835-1844); the *New Quarterly Review* (1852-1861); the *Scottish Review* (1853-1862), published at Glasgow; the *Wesleyan London Quarterly Review* (1853-); the *National Review* (1855-1864); the *Diplomatic Review* (1855-1881); the *Irish Quarterly Review* (1851-1859), brought out in Dublin; the *Home and Foreign Review* (1862-1864); the *Fine Arts Quarterly Review* (1863-1865); the *New Quarterly Magazine* (1873-1880); the *Catholic Union Review* (1863-1874); the *Anglican Church Quarterly Review* (1875); *Mind* (1876), dealing with mental philosophy; the *Modern Review* (1880-1884); the *Scottish Review* (1882); the *Asiatic Quarterly Review* (1886); since 1891 the *Imperial and Asiatic Quarterly Review*; and the *Jewish Quarterly Review*.

The monthly reviews include the *Christian Observer* (1802-1857), conducted by members of the established church upon evangelical principles, with Zachary Macaulay as the first editor; and the *Monthly Repository* (1806-1837), originally purely theological, but after coming into the hands of the Rev. W. J. Fox made entirely literary and political. The *Fortnightly Review* (1865), edited successively by G. H. Lewes, John Morley, T. H. S. Escott, Frank Harris, Oswald Crawford and W. L. Courtney, was intended as a kind of English *Revue des deux mondes*. Since 1866 it has appeared monthly. The *Contemporary Review* (1866), long edited by Sir Percy Bunting, and the *Nineteenth Century* (1877), founded and edited by Sir James Knowles (q.v.), and renamed *Nineteenth Century and After* in 1900, are similar in character, consisting of signed articles by men of mark of all opinions upon questions of the day. The *National Review* (1883), edited successively by Alfred Austin, W. Earl Hodgson, and L. J. Maxse, is alone in taking editorially a pronounced party line in politics as a Conservative organ. *Modern Thought* (1879-1884), for the free discussion of political, religious and social subjects, and the *Modern Review* (1892-1894) may also be mentioned. Other monthlies are the *Indian Magazine* (1871); the *Irish Monthly* (Dublin, 1873); the *Gaelic Journal* (Dublin, 1882); the *African Review* (1892) and the *Empire Review* (1900). The *Monthly Review* (1900-1908), edited till 1904 by Henry Newbolt, was for some years a notable addition to the high class literary monthlies.

The weekly reviews dealing generally with literature, science and art are the *Literary Gazette* (1817-1862), first edited by William Jerdan; the *Athenaeum* (1828), founded by James Silk Buckingham, but successfully established by C. W. Dilke, and long edited in later years by Norman MacColl (1843-1904), and afterwards by Mr Vernon Rendall; and the *Academy* (1869). Among those which also include political and social topics, and are more particularly dealt with under NEWSPAPERS, may be mentioned, the *Examiner* (1808-1881), the *Spectator* (1828), the *Saturday Review* (1855), the *Scots or National Observer* (1888-1897), *Outlook* (1898), *Pilot* (1900-1903), and *Speaker* (1890), which became the *Nation*.

Soon after the introduction of the literary journal in England, one of a more familiar tone was started by the eccentric John Dunton in the *Athenian Gazette*, or *Casualty Mercury*, resolving all the most *Nice and Curious Questions* (1689-1690 to 1695-1696), afterwards called *The Athenian Mercury*, a kind of forerunner of *Notes and Queries*, being a penny weekly sheet, with a quarterly critical supplement. In the last part the publisher announces that it will be continued "as soon as ever the glut of news is a little over." Dunton was assisted by Richard Sault and Samuel Wesley. Defoe's *Review* (1704-1713) dealt chiefly with politics and commerce, but the introduction in it of what its editor fittingly termed the "scandalous club" was another step nearer the papers of Steele and the periodical essayists, the first attempts to create an organized popular opinion in matters of taste and manners. These little papers, rapidly thrown off for a temporary purpose, were destined to form a very important

¹The centenary of the *Edinburgh Review* was celebrated in an article in October 1902, and that of the *Quarterly Review* in two articles April and July 1909. See also *On the Authorship of the First Hundred Numbers of the Edinburgh Review* (1895), by W. A. Copinger, and *The First Edinburgh Reviewers in Literary Studies* (1879), vol. I., by W. Bagehot.

part of the literature of the 18th century, and in some respects its most marked feature. Although the frequenters of the clubs and coffee-houses were the persons for whom the essay-papers were mainly written, a proof of the increasing refinement of the age is to be found in the fact that now for the first time were women specially addressed as part of the reading public. The *Tatler* was commenced by Richard Steele in 1709, and *Tatler*, &c. issued thrice a week until 1711. The idea was at once extremely popular, and a dozen similar papers were started within the year, at least one half bearing colourable imitations of the title. Addison contributed to the *Tatler*, and together with Steele established and carried on the *Spectator* (1710-1714), and subsequently the *Guardian* (1713). The newspaper tax enforced in 1712 dealt a hard blow at these. Before this time the daily issue of the *Spectator* had reached 3000 copies; it then fell to 1600; the price was raised from a penny to twopence, but the paper came to an end in 1714. Dr Drake (*Essays illustr. of the Rambler*, &c., il. 490) drew up an imperfect list of the essayists, and reckoned that from the *Tatler* to Johnson's *Rambler*, during a period of forty-one years, 106 papers of this description were published. Dr Drake continued the list down to 1809, and described altogether 221 which had appeared within a hundred years. The following is a list of the most considerable, with their dates, founders and chief contributors:—

Tatler (April 12, 1709 to Jan. 2, 1710-1711). Steele, Addison, Swift, Hughes, &c.; *Spectator* (March 1, 1710-1711 to Dec. 20, 1714). Addison, Steele, Budgell, Hughes, Grove, Pope, Parnell, Swift, &c.; *Guardian* (March 12, 1713 to Oct. 1, 1713). Steele, Addison, Berkeley, Pope, Tickell, Budgell, &c.; *Rambler* (March 20, 1750 to March 14, 1752). Johnson; *Adventurer* (Nov. 7, 1752 to March 9, 1754). Hawkesworth, Johnson, Bathurst, Warton, Chapone; *World* (Jan. 4, 1753 to Dec. 30, 1756). E. Moore, earl of Chesterfield, R. O. Cambridge, earl of Orford, Soame Jenyns, &c.; *Connoisseur* (Jan. 31, 1754 to Sept. 30, 1756). Colman, Thornton, Warton, earl of Cork, &c.; *Idler* (April 15, 1758 to April 5, 1760). Johnson, Sir J. Reynolds and Benzet Langton; *See* (Oct. 6, 1759 to Nov. 24, 1759). O. Goldsmith; *Mirror* (Jan. 23, 1779 to May 27, 1780). Mackenzie, Craig, Abercromby, Home, Bannatyne, &c.; *Lounger* (Feb. 5, 1785 to Jan. 6, 1787). Mackenzie, Craig, Abercromby, Tytler; *Observer* (1785 to 1790). Cumberland; *Looker-on* (March 10, 1792 to Feb. 1, 1794). W. Roberts, Beresford, Chalmers.

As from the "pamphlet of news" arose the weekly paper wholly devoted to the circulation of news, so from the general newspaper was specialized the weekly or monthly review of literature, Modern antiquities and science, which, when it included *Magazines*, essay-papers, made up the magazine or miscellaneous repository of matter for information and amusement. Several monthly publications had come into existence since 1681; but perhaps the first germ of the magazine is to be found in the *Gentleman's Journal* (1691-1694) of Peter Motteux, which, besides the news of the month, contained miscellaneous prose and poetry. Dr Samuel Jebb included antiquarian notices as well as literary reviews in his *Bibliotheca literaria* (1722-1724), previously mentioned, but the *Gentleman's Magazine*, founded in 1731, fully established, through the tact and energy of the publisher Edward Cave (q.v.), the type of the magazine, from that time so marked a feature of English periodical literature. The first idea is due to Motteux, from whom the title, motto and general plan were borrowed. The chief feature in the new venture at first consisted of the analysis of the journals, which Cave undertook personally. Prizes were offered for poetry. In April 1732 the leading metropolitan publishers, jealous of the interloper Cave, started the *London Magazine*, or *Gentleman's Monthly Intelligencer* (1732-1784), which had a long and prosperous career. The new magazine closely copied Cave's title, plan and aspect, and bitter war was long waged between the two. The rivalry was not without benefit to the literary public, as the conductors of each used every effort to improve their own review. Cave introduced the practice of giving engravings, maps and portraits, but his greatest success was the addition of Samuel Johnson (q.v.) to the regular staff. This took place in 1738, when the latter wrote the preface to the volume for that year, observing that the magazine had "given rise to almost twenty imitations of it, which are either all dead or very little regarded." The plan was also imitated in Denmark, Sweden and Germany. The *Gentleman's Magazine* was continued by Cave's brother-in-law, David Henry, afterwards by John Nichols and his son.² Cave appears to have been the first

²The first series of the *Gentleman's Magazine* or *Trader's Monthly Intelligencer*, extended from January 1731 to December 1735, 5 vols.; the *Gentleman's Magazine and Historical Chronicle* from January 1736 to December 1807, vols. 6-77; new series, January 1808 to December 1833, vols. 78-103; new series, 1834-1856, 45 vols.; new (third) series, 1856-1865, 19 vols.; new (fourth) series, 1866-1868, 5 vols. A general index to the first twenty vols. appeared in 1753. S. Ayscough brought out an index to the first fifty-six vols., 1731-1786 (1786), 2 vols., and one by J. Nichols, 1787-1818 (1821), 2 vols. A complete list of the plates and woodcuts (1731-1813) was published in 1814, and another list (1731-1818), in 1821. The *Gentleman's Magazine Library*, being a classified collection of the chief contents of the *Gentleman's Magazine*, from 1731 to 1868, is now being edited by Mr G. L. Gomme (1883, &c., vols. 1-17).

to use the word magazine in the sense of a periodical of miscellaneous literature. The specially antiquarian, biographical and historical features, which make this magazine so valuable a store-house for information for the period it covers, were dropped in 1868, when an "entirely new series," a miscellany of light literature was successively edited by Gowing, Joseph Hatton and Joseph Knight.

Many other magazines were produced in consequence of the success of these two. It will be sufficient to mention the following: The *Scots Magazine* (1739-1817) was the first published in Scotland; from 1817 to 1826 it was styled the *Edinburgh Magazine*. The *Universal Magazine* (1747) had a short, if brilliant, career; but the *European Magazine*, founded by James Perry in 1782, lasted down to 1826. Of more importance than these, or than the *Royal Magazine* (1759-1771) was the *Monthly Magazine* (1796-1843), with which Priestley and Godwin were originally connected. During thirty years the *Monthly* was conducted by Sir Richard Phillips, under whom it became more statistical and scientific than literary. Class magazines were represented by the *Edinburgh Farmer's Magazine* (1800-1825) and the *Philosophical Magazine* (1798), established in London by Alexander Tilloch; the latter at first consisted chiefly of translations of scientific articles from the French. The following periodicals, all of which date from the 18th century, are still published: the *Gospel Magazine* (1766, with which is incorporated the *British Protestant*), the *Wesleyan Methodist Magazine* (1778), *Curtis's Botanical Magazine* (1786), *Evangelical Magazine* (1793); since 1905 the *Evangelical British Missionary*, the *Philosophical Magazine* (1798), now known as the *London, Edinburgh and Dublin Philosophical Magazine*.

The increased influence of this class of periodical upon public opinion was first apparent in *Blackwood's Edinburgh Magazine*, founded in 1817 by the publisher of that name, and carried to a high degree of excellence by the contributions of Scott, Lockhart, Hoger, Maginn, Syme and John Wilson ("Christopher North"). John Galt and Samuel Warren. It has always remained Liberal in literature and Conservative in politics. The *New Monthly Magazine* is somewhat earlier in date. It was founded in 1814 by the London publisher, Colburn, and was edited in turn by Campbell, Theodore Hook, Bulwer-Lytton and Ainsworth. Many of Carlyle's and Thackeray's pieces first appeared in *Fraser's Magazine* (1830), long famous for its personalities and its gallery of literary portraits. The *Metropolitan Magazine* was started in opposition to *Fraser*, and was first edited by Campbell, who had left its rival. It subsequently came into the hands of Captain Marryat, who printed in it many of his sea-tales. The *British Magazine* (1832-1849) included religious and ecclesiastical information. From Ireland came the *Dublin University Magazine* (1833). The regular price of these magazines was half a crown; the first of the cheaper ones was *Tait's Edinburgh Magazine* (1832-1861) at a shilling. It was Radical in politics, and had Roebuck as one of its founders. *Bentley's Miscellany* (1837-1868) was exclusively devoted to novels, light literature and travels. Several of Ainsworth's romances, illustrated by Cruikshank, first saw the light in *Bentley*. The *Nautical Magazine* (1832) was addressed specially to sailors, and Colburn's *United Service Journal* (1829) to both services. The *Asiatic Journal* (1816) dealt with Oriental subjects.

From 1815 to 1820 a number of low-priced and unwholesome periodicals flourished. The *Mirror* (1823-1849), a two-penny *Cheap Pub.* illustrated magazine, begun by John Limbird, and *Stations*, a direction. The political agitation of 1831 led to a further popular demand, and a supply of cheap and healthy serials for the reading multitude commenced with *Chambers's Journal* (1829), the *Penny Magazine* (1832-1845) of Charles Knight, and the *Saturday Magazine* (1832-1844), begun by the Society for Promoting Christian Knowledge. The first was published at 1d. and the last two at 1d. Knight secured the best authors and artists of the day to write for and illustrate his magazine, which, though at first a commercial success, may have had the reason of its subsequent discontinuance in its literary excellence. At the end of 1832 it had reached a sale of 200,000 in weekly numbers and monthly parts. It came to an end in 1845 and was succeeded by *Knight's Penny Magazine* (1845), which was stopped after six monthly parts. These periodicals were followed by a number of penny weeklies of a lower tone, such as the *Family Herald* (1843), the *London Journal* (1845) and *Lloyd's Miscellany*. In 1850 the sale of the first of them was placed at 175,000 copies, the second at 170,000, and *Lloyd's* at 95,000. In 1846 fourteen penny and three half-penny magazines, twelve social journals, and thirty-seven book-serials were produced every week in London. A further and permanent improvement in cheap weeklies for home reading may be traced from the foundation of *Howitt's Journal* (1847-1849), and more especially *Household Words* (1850), conducted by Charles Dickens, *All the Year Round* (1859), by the same editor, and afterwards by his son, *Once A Week* (1859), and the *Leisure Hour* (1852). The plan of *Notes and Queries* (1849), for the purpose of inter-communication among those interested in special points of literary and antiquarian character, has led to the

adoption of similar departments in a great number of newspapers and periodicals, and, besides several imitators in England, there are now parallel journals in Holland, France, and Italy.

Shilling monthlies began with *Macmillan* (1859), the *Cornhill* (1860), first edited by Thackeray, and *Temple Bar* (1860). *St James's Magazine* (1861), *Belgravia* (1866), *St Paul's* (1867-1874), *London Society* (1862), and *Tinsley's* (1867) were devoted chiefly to novels and light reading. Sixpenny illustrated magazines commenced with *Good Words* (1860) and the *Quiver* (1861), both religious in tendency. In 1882 *Fraser* changed its name to *Longman's Magazine*, and was popularized and reduced to sixpence. The *Cornhill* followed the same example in 1883, reducing its price to sixpence and devoting its pages to light reading. The *English Illustrated Magazine* (1883) was brought out in competition with the American *Harper's and Century*. The *Pall Mall Magazine* followed in 1893. Of the artistic periodicals we may mention the *Art Journal* (1849), *Portfolio* (1870), *Magazine of Art* (1878-1904), *Studio* (1893), *Connoisseur* (1901), and *Burlington* (1903). The *Bookman* (1886), for a combination of popular and literary qualities, and the *Badminton* (1895), for sport, also deserve mention. One of the most characteristic developments of later journalism was the establishment in 1890 of the *Review of Reviews* by W. T. Stead. Meanwhile the number of cheap periodicals increased enormously, such as the weekly *Tit-bits* (1881) and *Anstons* (1888), and profusely illustrated magazines appeared, like the *Strand* (1891), *Pearson's* (1896), or *Windsor* (1895). Professions and trades now have not only their general class-periodicals, but a special review or magazine for every section. In 1910 the magazines and reviews published in the United Kingdom numbered 2795. Religious periodicals were 668; 338 were devoted to trade; 361 to sport; 691 represented the professional classes; 51 agriculture; and 218 were juvenile periodicals. The London monthlies were 797 and the quarterlies 155.

Indexes to English Periodicals.—A large number of periodicals do not preserve literary matter of permanent value, but the high-class reviews and the archaeological, artistic and scientific magazines contain a great mass of valuable facts, so that general and special indexes have become necessary to all literary workers. Lists of the separate indexes to particular series are given in H. B. Wheatley's *What is an Index?* (1879), W. P. Courtney's *Register of National Bibliography* (1905, 2 vols.), and the *List of Books forming the Reference Library in the reading room of the British Museum* (4th ed. 1910, 2 vols.).

Authorities.—"Periodicals," in the British Museum catalogue; Lowndes, *Bibliographer's Manual*, by Hy. G. Bohn, (1864); *Col. of Periodicals in the Bodl. Lib.*, pt. i., "English Periodicals" (1878); *Cat. of the Hope Collection of Early Newspapers and Essayists in the Bodl. Lib.* (1865); Scudder, *Cat. of Scientific Serials* (1879); Andrews, *Hist. of Brit. Journalism* (1859); Cucheval Clarygn, *Hist. de la Presse en Angleterre et aux Etats Unis* (1857); Madden, *Hist. of Irish Period. Lit.* (1867); J. Grant, *The Great Metropolis*, li. 229-327; "Periodical Essays of the Age of Anne," in *N. American Rev.* vol. xvi.; Drake, *Essays on the "Spectator," "Tatler," &c.* (1810-1814); Courthope, *Addition* ("Engl. Men of Letters," 1884); "Forgotten Periodical Publications," in *Notes and Queries*, 3rd series, vol. ix. p. 53; "Account of Periodical Literary Journals from 1681 to 1749," by S. Parkes, in *Quart. Jour. of Sc., Lit., &c.*, xlii. 36, 289; see also *Notes and Queries*, 3rd series, vol. vi. pp. 327, 435; "Laps of Century Magazines," in *Fraser's Mag. Series* (1879), p. 325; "Periodicals during 1712-1732," in *Notes and Queries*, 3rd series, vol. ix. p. 72, &c.; x. 174; "Catholic Period. Lit.," 5th series, vol. xi. 427, 494; "Early Roman Catholic Magazines," *ib.*, 6th series, vol. iii. p. 43, &c.; iv. 211; Timperley, *Ency. of Lit. Amer.* (1842); C. Knight, *The Old Printer and the Modern Press* (1854), and *Passages of a Working Life* (1864-1865); *Memoir of Robert Chambers* (1872); the *London Cat. of Periodicals, Newspapers, &c.* (1844-1910); *The Bookseller* (February 1867, June and July 1868, August 1874, July 1879); "On the Unstamped Press," *Notes and Queries*, 4th series, vol. x. and xi. (1872-1873), and *English Hist. Review* (1897), xii. 711-726; "Contributions Towards an Index of Serial Stories," by W. L. Fletcher, *Library Journal* (1881), vi. 42, 166; "Byways of Periodical Literature," *Wallford's Antiq. Mag.* (1887), xi. 179-186, xii. 65-74; *Catalogue of Magazines &c., recd. at the Melbourne Pub. Lib.* (1891); "English Periodical Literature," by W. Robertson Nicoll, *Bookman* (1895), vol. i.; "The Periodical Press, 1865-1895," by T. H. S. Escott, *Blackwood* (1894), pp. 156, 532; "Bibliography of Periodical Literature," by F. Campbell, *The Library* (1898), viii. 49; "Bibliography of the British Periodical Press," by D. Williams in *Mitchell's Newspaper Directory* (1902), pp. 12-13; "English Reviews," by A. Waugh, *Critic*, vol. 40; "Excursus on Periodical Criticism," *Saintsbury, History of Criticism* (1904), iii. 408-428. As regards the treatment of periodicals in libraries see "Helps for Cataloguers of Serials," by H. C. Bolton in *Boston Bull. of Bibliography* (1897); "Co-operative lists of periodicals," *Library Journal*, (1899), xxiv. 29-32; "Union List of Periodicals in Chicago Libraries," *Public Libraries*, Chicago (1900), v. 60; "Care of Periodicals in a Library," by F. R. Jackson, *Public Libraries*, Chicago (1906), vol. xi. Complete lists of current British periodicals are included in *Mitchell's Newspaper Press Directory*, *Street's Newspaper Directory*, and *Willing's Press Guide*, and a select list and other information are given in the *Literary Year Book*.

John Limbird, to whom even before Chambers or Knight is due the carrying out the idea of a cheap and good periodical for the people, died on the 31st of October 1883, without having achieved the worldly prosperity of his two followers.

UNITED STATES

The two earliest American miscellanies were produced almost simultaneously. Spurred by the success of the *Gentleman's Magazine* in England Benjamin Franklin founded the *General Magazine* (1741) at Philadelphia, but it expired after six monthly numbers had appeared. Franklin's rival, Andrew Bradford, forestalled him by three days with the *American Magazine* (1741) edited by John Webbe, which ran only to two numbers. Further attempts at Philadelphia in 1757 and 1769 to revive periodicals with the same name were both fruitless. The other pre-revolutionary magazines were the *Boston American Magazine* (1743-1747), in imitation of the *London Magazine*; the *Boston Weekly Magazine* (1743); the *Christian History* (1743-1744); the *New York Independent Reflector* (1754-1754); the *Boston New England Magazine* (1758-1760), a collection of fugitive pieces; the *Boston Royal American Magazine* (1774-1775); and the *Pennsylvania Magazine* (1775-1776), founded by Robert Aitken, with the help of Thomas Paine. The *Columbian Magazine* (1786-1790) was continued as the *Universal Asylum* (1790-1792). Matthew Carey brought out the *American Museum* in 1787, and it lasted until 1792. Among the other magazines which ran out a brief existence before the end of the century was the Philadelphia *Political Censor* or *Monthly Review* (1796-1797) edited by William Cobbett. One of the most successful was the *Farmer's Weekly Museum* (1790-1799), supported by perhaps the most brilliant staff of writers American periodical literature had yet seen to show, and edited by Joseph Dennie, who in 1801 began the publication of the *Portfolio*, carried on to 1827 at Philadelphia. For five years it was a weekly miscellany in quarto, and afterwards an octavo monthly; it was the first American serial which could boast of so long an existence. Charles Brocaden Brown established the *New York Monthly Magazine* (1799), which, changing its title to *The American Review*, was continued to 1802. Brown founded at Philadelphia the *Literary Magazine* (1803-1808); he and Dennie may be considered as having been the first American professional men of letters. The Anthology Club was established at Boston in 1803 by Phineas Adams for the cultivation of literature and the discussion of philology. Ticknor, Everett and Bigelow were among the members, and were contributors to the organ of the club, the monthly *Anthology* and *Boston Review* (1803-1811), the forerunner of the *North American Review*. In the year 1810 Thomas (Printing in America, ii. 292) informs us that 27 periodicals were issued in the United States. The first serious rival of the *Portfolio* was the *Analectic Magazine* (1813-1820), founded at Philadelphia by Moses Thomas, with the literary assistance of W. Irving (for some time the editor), Paulding, and the ornithologist Wilson. In spite of a large subscription list it came to an end on account of the costly style of its production. The first southern serial was the *Monthly Register* (1805) of Charleston. New York possessed no periodical worthy of the city until 1824, when the *Atlantic Magazine* appeared, which changed its name shortly afterwards to the *New York Monthly Review*, and was supported by R. C. Sands and W. C. Bryant. N. P. Willis was one of the editors of the *New York Mirror* (1823-1842). Between 1840 and 1850 *Graham's Magazine* was the leading popular miscellany in the country, reaching at one time a circulation of about 35,000 copies. The first western periodical was the *Illinois Monthly Magazine* (1830-1832), published, owned, edited and almost entirely written by James Hall, who followed with his *Western Monthly Magazine* (1833-1836), produced in a similar manner. In 1833 the novelist C. F. Hoffman founded at New York the *Kuischerbocher* (1833-1860), which soon passed under the control of Timothy Flint and became extremely successful, most of the leading native writers of the next twenty years having been contributors. Equally popular was *Putnam's Monthly Magazine* (1853-1857, 1867-1869). It was revived in 1906-1910. The *Dial* (1840-1844), Boston, the organ of the transcendentalists, was first edited by Margaret Fuller, and subsequently by R. W. Emerson and G. Ripley. Other magazines were the *American Monthly Magazine* (1833-1838), the *Southern Literary Messenger* (1834), Richmond, the *Gentleman's Magazine* (1837-1840), and the *International Magazine* (1850-1852), edited by R. W. Griswold. The *Yale Literary Magazine* dated from 1836. The *Merchants' Magazine* was united in 1871 with the *Commercial and Financial Chronicle*. First in order of date among the current monthly magazines comes the *New York Harper's New Monthly Magazine* (1850), the earliest existing illustrated American serial, then the *Boston Atlantic Monthly* (1857), with which was incorporated the *Galaxy* (1866) in 1878, famous for its editors Lowell, Howells and T. B. Aldrich, and its contributors O. W. Holmes, Longfellow, Whittier and others. Next came *Lippincott's Magazine* (1858) from Philadelphia, and the *Comopolitan* (1856) and *Scribner's Monthly* (1870), known as the *Century Illustrated Magazine* since 1881 from New York. These were followed by *Scribner's Magazine* (1887), the *New England Magazine* (1880), the *Illustrated Review of Reviews* (1890), *McClure's Magazine* (1892), the *Bookman* (1895), the *World's Work* (1902), the *American Magazine* (1906) succeeding Frank Leslie's *Popular Monthly*, and *Munssey's Magazine* (1889). All are illustrated, and three in particular, the *Century*, *Scribner's* and *Harper's*, carried the art of wood-engraving to a high standard of excellence.

The first attempt to carry on an American review was made by Robert Walsh in 1811 at Philadelphia with the quarterly *American*

Review of History and Politics, which lasted only a couple of years. Still more brief was the existence of the *General Repository* and *Review* (1812), brought out at Cambridge by Andrews Norton with the help of the professors of the university, but of which only four numbers appeared. Niles's *Weekly Register* (1811-1848) was political, historical and literary. The *North American Review*, the oldest and most famous of all the American reviews, dates from 1815, and was founded by William Tudor, a member of the previously mentioned Anthology Club. After two years' control Tudor handed over the review to the club, then styled the North American Club, whose most active members were E. T. Channing, R. H. Dana and Jared Sparks. In 1819 E. Everett became the editor; his brother Alexander acquired the property in 1829. The roll of contributors numbers almost every American writer of note. Since 1879 it has been published monthly (except in Sept. 1906-Sept. 1907, when it appeared semi-monthly). The *American Quarterly Review* (1827-1837), established at Philadelphia by Robert Walsh, came to an end on his departure for Europe. The *Southern Quarterly Review* (1828-1832), conducted by H. Legaré, S. Elliot and G. W. Simms in defence of the politics and finance of the South, enjoyed a shorter career. It was reconstituted in 1842, and lived another thirteen years. These two were followed by the *Democratic Review* (1838-1842), the *American Review* (1845-1849), afterwards the *American Whig Review* (1850-1852), the *Massachusetts Quarterly Review* (1847-1850), and a few more. The *New Englander* (1845-1850), the *Biblical Repository and Princeton Review* (1825), the *National Quarterly Review* (1860) and the *New York International Review* (1874-1883), may also be mentioned. The critical weeklies of the past include the *New York Literary Gazette* (1834-1835, 1839), *De Bow's Review* (1846), the *Literary World* (1847-1853), the *Criterion* (1855-1856), the *Round Table* (1863-1864), the *Citizen* (1864-1873), and *Appleton's Journal* (1869). The leading current monthlies include the *New York Forum* (1856), *Arena* (1890), *Current Literature* (1888), and *Bookman*, the *Chicago Dial* (1880), and the *Greenwich, Connecticut, Literary Collector*. Foremost among the weeklies comes the *New York Nation* (1865).

Religious periodicals have been extremely numerous in the United States. The earliest was the *Theological Magazine* (1796-1798). The *Christian Examiner* dates from 1824 and lasted down to 1870. The *Panoptist* (1805) changed its name to the *Missionary Herald*, representing the American Board of Missions. The *Methodist Magazine* dates from 1818 and the *Christian Disciple* from 1813. The *American Biblical Repository* (1831-1850), a quarterly, was united with the *Andover Bibliotheca Sacra* (1843) and with the *Theological Eclectic* (1865). *Brownson's Quarterly Review* began as the *Boston Quarterly Review* in 1838, and did much to introduce to American readers the works of the modern French philosophical school. Other serials of this class are the *Protestant Episcopal Quarterly Review* (1854), the *Presbyterian Magazine* (1851-1866), the *Catholic World* (1865), the *Southern Review* (1867), the *New Jerusalem Magazine* (1827), *American Baptist Magazine* (1817), the *Church Review* (1848), the *Christian Review* (1835), the *Unitarianist Quarterly* (1844). Current religious quarterlies are the *Chicago American Journal of Theology* and the *Oberlin Bibliotheca Sacra*. The *Chicago Biblical World* is published monthly.

Among historical periodicals may be numbered the *American Register* (1806-1811), *Stryker's American Register* (1848-1852), *Edwards's American Quarterly Register* (1829-1843), the *New England Historical and Genealogical Register* (1847), *Folsom's Historical Magazine* (1857), the *New York Genealogical Record* (1869), and the *Magazine of American History* (1877). There is also the *Lancaster, Pennsylvania, American Historical Review*, issued quarterly.

Many serial publications have been almost entirely made up of extracts from English sources. Perhaps the earliest example is to be found in *Select Views of Literature* (1811-1812). The *Eclectic Magazine* (1844) and *Littell's Living Age* (1844) may be mentioned.

In 1817 America possessed only one scientific periodical, the *Journal of Mineralogy*. Professor Silliman established the journal known by his name in 1818. Since that time the *American Journal of Science* has enjoyed unceasing favour. The special periodicals of the day are very numerous. Among the most representative are: the *Popular Science Monthly*, New York; the monthly *Boston Journal of Education*; the quarterly *American Journal of Mathematics*, Baltimore; the monthly *Cassier's Magazine* (1891), New York; the monthly *American Engineer* (1893), New York; the monthly *House and Garden*, Philadelphia; the monthly *Atropysical Journal*, commenced as *Sideral Messenger* (1882), Chicago; the monthly *American Chemical Journal*, Baltimore; the monthly *American Naturalist*, Boston; the monthly *American Journal of the Medical Sciences*, Philadelphia; the monthly *Quincy*, New York; the weekly *American Agriculturist*, New York; the quarterly *Metaphysical Magazine* (1895) New York; the bi-monthly *American Journal of Sociology*, Chicago; the bi-monthly *American Law Review*, St. Louis; the monthly *Banker's Magazine*, New York; the quarterly *American Journal of Philology* (1880), Baltimore; the monthly *Literary Journal* (1876), New York; the monthly *Public Libraries*, Chicago; the weekly *Scientific American*, New York; the quarterly *American Journal of Archaeology* (1885), New York.

The number of periodicals devoted to light literature and to female readers has been, and still remains, extremely large. The earliest

in the latter class was the *Lady's Magazine* (1792) of Philadelphia. The *Lowell Offering* (1841) was written by factory girls of Lowell (Mass.). *Godey's Lady's Book* was long popular, and the *Ladies Home Journal* (1883) and the *Woman's Home Companion* (1893) are now current. Children's magazines originated with the *Young Misses' Magazine* (1806) of Brooklyn; the *New York St Nicholas* (monthly) and the *Boston Youth's Companion* (weekly) are prominent juveniles.

The total of American periodicals mentioned in the *Gale's* by H. O. Severance and C. H. Walsh (1909, Ann Arbor), is 5136 for the year 1908.

AUTHORITIES.—The eighth volume of the *Tenth Report of the United States Census* (1884) contains a statistical report on the newspaper and periodical press of America by S. N. D. North. See also Cucheval Clarigny, *Histoire de la presse en Angleterre et en les États Unis* (1857); H. Stevens, *Catalogue of American Books in the Library of the British Museum* (1866), and *American Books with Titles to 1866* (1873); I. Thomas, *History of Printing in America* (Albany, 1874); J. Nichol, *American Literature* (1882); "Check List of American Magazines," in *Library Journal*, xiv, 373; G. P. Rowell & Co.'s *American Newspaper Directory* (New York); A. R. Spofford, *Book for all Readers* (1900); F. W. Faxon's *Check List of American and English Periodicals* (Boston, 1908). Many American libraries co-operate in issuing joint or union lists of periodicals. See list of these as well as lists of special indexes in A. B. Kroeger's *Guide to Reference Books* (2nd ed., Boston, 1908).

Indexes to Periodicals.—The contents of English and American periodicals of the last 100 years are indexed in the following publications: W. F. Poole's *Index to Periodical Literature* (1802-1881, revised ed., Boston, 1891); 1st supplement, 1882-1887, by W. F. Poole and W. I. Fletcher, 1888; 2nd supplement, 1887-1892, by W. I. Fletcher, 1893; 3rd supplement, 1892-1896, by W. I. Fletcher and F. O. Poole, 1898; 4th supplement, 1897-1902, 1902; 5th supplement, 1902-1907, 1908; *Poole's Index*, abridged edition, by W. I. Fletcher and M. Poole (Boston, 1901); 1st supplement, 1900-1904 (Boston, 1905); *The Co-operative Index to Periodicals* (1885-1894, ed. W. I. Fletcher, 1886-1894); *The Annual Literary Index, including Periodicals*, ed. by W. I. Fletcher and R. R. Bowker (New York, 10 vols., 1892-1907); "Index of Periodicals for 1890," &c. (*Review of Reviews*), by Miss Hetherington (13 vols., 1891-1902); *O. P. Indexes*; *Cotgreave's Contents Subject Index to General and Periodical Literatures* (1900); *Cumulative Index to a Selected list of Periodicals*, begun in the Cleveland Public Library in 1896 and 1897 by W. H. Brett, merged in 1903 with the *Reader's Guide to Periodical Literature* (8 vols., 1901-1908, ed. by A. L. Guthrie, Minneapolis, U.S.); *Magazine Subject Index*, by F. W. Faxon (Boston, 1908), continued quarterly in *Bulletin of Bibliography*, which in 1907 began a magazine subject index; *Eclectic Library Catalogue* (Minneapolis, 1908), issued quarterly.

CANADA

Canadian periodicals have reached a higher standard than in any other British self-governing colony. Like that of South Africa, the press is bi-lingual. The first Canadian review, the *Quebec Magazine* (1791-1793), was published quarterly in French and English. It was followed by the *British American Register* (Quebec, 1803), *L'Abeille canadienne* (Montreal, 1818), edited by H. Mezière, the *Canadian Magazine* (Montreal, 1823-1825), the *Canadian Review* (Montreal, 1824-1826), *La Bibliothèque canadienne* (Montreal, 1827-1830), continued as *L'Observateur* (1830-1831), and the *Magasin de Bas-Canada* (Montreal, 1832). The three latter were edited by Michel Bibaud. The *Literary Garland* (Montreal, 1837-1850), edited by John Gibson, was for some time the only English magazine published in Canada. Later magazines were *L'Echo du cabinet de lecture paroissial* (Montreal, 1859), 15 vols.; *La Pape canadienne* (Quebec, 1863-1866), one of the most interesting French-Canadian reviews; *La Revue canadienne*, which was started at Montreal in 1864, and contained the best writings of contemporary French-Canadian literateurs; *La Revue de Montréal* (1877-1881), edited by the abbé T. A. Chandonnet; the *Canadian Journal* (Toronto), commenced in 1852 under Henry Youle Hind and continued by Daniel Wilson; *L'Abeille* (Quebec, 1848-1881), and the *Canadian Monthly* (Toronto, 1873-1882). The *Bystander* (Toronto, 1880-1883), was edited by Goldwin Smith. *Le Canada français* (Quebec, 1888-1891), edited by the staff of the Laval University, and *Canadienne* (1880-1890), were important historical and literary reviews. Contemporary magazines are the *Canadian Magazine* (1893), the *Westminster*, both produced at Toronto, *La Nouvelle-France* (Quebec), the *Canada Monthly* (London, Ontario), and the *University Magazine*, edited by Professor Macphail, of the McGill University.

See H. J. Morgan, *Bibliotheca canadensis* (1867), "Canadian Magazines," by G. Stewart, *Canadian Monthly*, vol. xvii; "Periodical Literature in Canada," by J. M. Ouley, *North Am. Rev.* (1888); P. Gagnon, *Essai de bibliographie canadienne* (1895), and S. E. Dawson, *Press Writers of Canada* (1901).

SOUTH AFRICA

The earliest magazine was the *South African Journal*, issued by the poet Pringle and John Fairbairn in 1824. It was followed by the *South African Quarterly Journal* (1829-1834), the *Cape of Good Hope Literary Gazette* (1830-1833), edited by A. J. Jardine, the *Cape*

of *Good Hope Literary Magazine* (1847-1848), edited by J. L. Fitzpatrick, and the *Eastern Province Monthly Magazine*, published at Grahamstown in 1857-1858. A Dutch periodical called *Elpis, algemeene tijdschrift voor Zuid Afrika* (1857-1861) appealed to the farming community. The *Eastern Province Magazine* was issued at Port Elizabeth in 1861-1862, and the *South African Magazine* appeared in 1867-1868. The *Orange Free State Magazine*, the only English magazine published at Bloemfontein, was issued in 1877-1878; and the *E. P. Magazine* was published at Grahamstown in 1892-1897. The *Cape Monthly Magazine*, the most important of the periodicals, was issued from 1857 to 1862, and was again continued under the editorship of Professor Noble from 1870 to 1881. The *Cape Illustrated Magazine* (1890-1899) was edited by Professor J. Gill. In Durban the *Present Century* was started in 1903, and the *Natal Magazine* was issued at Pietermaritzburg in 1877. The weekly *New Era* (1904-1905) was succeeded by the *South African Magazine* (1906-1907); both were edited by C. H. Crane. The *African Monthly* (Grahamstown, 1907) and the *State of South Africa* (Cape Town, 1909) are monthly reviews, while the *South African Railway Magazine* (1907) is of wider interest than its name denotes.

See S. Mendelssohn, *South African Bibliography* (2 vols., 1910); and P. E. Lewin, *Catalogue of the Port Elizabeth Library* (2 vols., 1906).

AUSTRALIA AND NEW ZEALAND

New South Wales.—The *Australian Magazine* was published monthly at Sydney in 1821-1822. This was followed by the *South Asian Register* (1827), the *Australian Quarterly Journal* (1828), edited by the Rev. P. N. Wilton, the *New South Wales Magazine* (1833), the *New South Wales Literary, Political and Commercial Advertiser* (1835), edited by the eccentric Dr Lhotsky, *Tegg's Monthly Magazine* (1836), the *Australian Magazine* (1838), the *New South Wales Magazine* (1843), the *Australian Penny Journal* (1848) and many others. The *Sydney University Magazine* (1855), again published in 1878-1879, and continued as the *Sydney University Review*, is the first magazine of a high literary standard. The *Sydney Magazine of Science and Art* (1857) and the *Month* (1857) were short-lived. Of later magazines the *Australian* (1878-1881), *Aurora australis* (1868), and the *Sydney Magazine* (1878), were the most noteworthy. Of contemporary magazines *Dalgety's Review* is mainly agricultural, the *Australian Magazine* (1909) and the *Lone Hand* (1907) are popular, and the *Science of Man* is an anthropological review.

See *Australasian Bibliography* (Sydney, 1893); G. B. Barton, *Literature of N. S. W.* (1866); E. A. Petherick, *Catalogue of Books Relating to Australasia* (1909).

Victoria.—The *Port Phillip Magazine* (1843) must be regarded as the first literary venture in Victoria. This was followed by the *Australia Felix Magazine* (1849), and the *Australasian Quarterly Reprint* (1850-1851) both published at Geelong, the *Illustrated Australian Magazine* (1850-1852), the *Australasian Gold-Digger's Monthly Magazine* (1852-1853), edited by James Bonwick, and the *Melbourne Monthly Magazine* (1855-1856), the *Journal of Australasia* (1856-1858), the *Australian Monthly Magazine* (1863-1867), which contained contributions from Marcus Clarke and was continued as the *Colonial Monthly* (1867-1869), the *Melbourne Review* (1876-1885) and the *Victorian Review* (1879-1886) may also be mentioned. The *Imperial Review*, apparently the work of one pen, has been published since 1879; the *Pastoralists' Review* appeals more especially to the agricultural community. A *Library Record of Australasia* was published in 1901-1902. An Australian edition of the *Review of Reviews* is published at Melbourne.

See "Some Magazines of Early Victoria," in the *Library Record of Australasia*, Nos. 2-4 (1901).

South Australia.—The *South Australian Magazine* was issued monthly in 1841-1843, the *Adelaide Magazine* (1845), the *Adelaide Miscellany* (1848-1849), and the *Wanderer* in 1853. The *South Australian Twopenny Magazine* was published at Plymouth, England, in 1839, and the *South Australian Miscellany and New Zealand Review* at London in the same year.

See T. Gill, *Bibliography of South Australia* (1886).

Tasmania.—The first magazine was Murray's *Austral-Asiatic Review*, published at Hobart in 1828. The *Hobart Town Magazine* appeared in 1839-1894, and the *Vas Diemen's Land Monthly Magazine* in 1835.

New Zealand.—The *New Zealand Magazine*, a quarterly, was published at Wellington in 1850. In 1857 appeared the *New Zealand Quarterly Review*, of little local interest, followed by *Chapman's New Zealand Monthly Magazine* (1862), the *Southern Monthly Magazine* (1863), the *Delphic Oracle* (1866-1870), the *Stoic* (1871), the *Dunedin Review* (1885), the *Literary Magazine* (1885), the four latter being written by J. G. S. Grant, an eccentric genius, the *Monthly Review* (1888-1890), the *New Zealand Illustrated Magazine* (1890-1905), chiefly devoted to the light literature of New Zealand subjects, the *Maori Record* (1905-1907), and the *Red Fannel*, published since 1905.

See T. M. Hocken, *Bibliography of New Zealand* (1909).

WEST INDIES AND BRITISH CROWN COLONIES

In Jamaica the *Columbian Magazine* was founded at Kingston in 1796 and ceased publication in 1800. Two volumes were

published of a *New Jamaica Magazine* which was started about 1798. The *Jamaica Magazine* (1812-1813), the *Jamaica Monthly Magazine* (1844-1848), and the *Victoria Quarterly* (1880-1892), which contained many valuable articles on the West Indies, were other magazines. The *West Indian Quarterly* was published at Georgetown, British Guiana, from 1885 to 1888. At Georgetown was also published the well-known *Timebri* (1882-1898) which contained many important historical articles. In Trinidad the *Trinidad Monthly Magazine* was started in 1871, and the *Union Magazine* in 1892.

Malta had a *Malta Penny Magazine* in 1839-1841, and the *Revue historique et littéraire* was founded in Mauritius in 1887. Many magazines dealing with the colonies have been published in England, such as the *Colonial Magazine* (1840-1843).

See F. Cundall, *Bibliographia Jamaicensis* (1902-1908).

INDIA AND CEYLON

Calcutta.—The first Indian periodical was the *Asiatic Miscellany* (Calcutta, 1785-1789), probably edited by F. Gladwin. The *Calcutta Monthly Register* was published in 1790, and the *Calcutta Monthly Journal* from 1798 to 1841. Among other early Calcutta magazines were the *Asiatic Observer* (1823-1824), the *Quarterly Oriental Magazine* (1824-1827), and the *Royal Sporting Magazine* (1833-1838). The *Calcutta Literary Gazette* was published in 1830-1834, and the *Calcutta Review*, still the most important serial of the Indian Empire, first appeared in 1846 under the editorship of Sir J. W. Kaye.

Bombay.—The *Bombay Magazine* was started in 1811 and lasted but a short time. The *Bombay Quarterly Magazine* (1851-1853) gave place to the *Bombay Quarterly Review*, issued in 1855.

Madras.—Madras had a *Journal of Literature and Science* and the *Oriental Magazine and Indian Hurkurn* (1819). The *Indian Antiquary* was started at Bombay in 1872 and still continues. Of other contemporary magazines the *Hindustan Review* (Allahabad), the *Modern Review* (Calcutta), the *Indian Review* (Madras), the *Madras Review*, a quarterly first published in 1895, and the *Calcutta University Magazine* (1894), are important.

Ceylon.—In Ceylon the *Religious and Theological Magazine* was started at Colombo in 1833, the *Colombo Magazine* in 1839, the *Ceylon Magazine* in 1840, and the *Investigator* at Kandy in 1841. Of contemporary magazines the *Tropical Agriculturist* was started in 1881, the *Ceylon Literary Register* (1898-1899), afterwards the *Monthly Literary Register* and the *Ceylon National Review* in 1893. In Burma the quarterly *Buddhism* appeared in 1904. Singapore had a *Journal of the Indian Archipelago* from 1847 to 1859, and the *Chinese Repository* (1832-1851) was edited at Canton by Morrison. See "Periodical Literature in India," in *Dark Blue* (1872-1873).

FRANCE

We owe the literary journal to France, where it soon attained to a degree of importance unapproached in any other country. The first idea may be traced in the *Bureau d'adresse* (1633-1642) of Théophraste Renaudot, giving the proceedings of his conferences upon literary and scientific matters. About the year 1663 Mézeray obtained a privilege for a regular literary periodical, which came to nothing, and it was left to Denis de Sallo, counsellor of the parliament of Paris and a man of rare merit and learning, to actually carry the project into effect. The first number of the *Journal des sçavants* appeared on the 5th of January 1665, under the assumed name of the sieur d'Hédouville. The prospectus promised to give an account of the chief books published throughout Europe, obituary notices, a review of the progress of science, besides legal and ecclesiastical information and other matters of interest to cultivated persons. The criticisms, however, wounded alike authors and the clergy, and the journal was suppressed after a career of three months. Colbert, seeing the public utility of such a periodical, ordered the abbé Gallois, a contributor of De Sallo's, to re-establish it, an event which took place on the 4th of January 1666. It lingered nine years under the new editor, who was replaced in 1675 by the abbé de la Roque, and the latter in his turn by the president Cousin, in 1686. From 1701 commenced a new era for the *Journal*, which was then acquired by the chancellor de Pontchartrain for the state and placed under the direction of a commission of learned men. Just before the Revolution it developed fresh activity, but the troubles of 1792 caused it to be discontinued until 1796, when it again failed to appear after twelve numbers had been issued. In 1816 it was definitely re-established and replaced under government patronage, remaining subject to the chancellor or garde-des-sceaux until 1857, when it was transferred to the control of the minister of public instruction. Since 1901, the organization of the publication has changed. The state subsidy having been withdrawn, the Institute voted a yearly subscription of 10,000 francs and nominated a commission of five members, one for each section, who managed the *Journal*. Since 1900, however, the various sections have left to the Académie des Inscriptions et Belles Lettres the entire direction of the *Journal*, while still paying the annual subsidy. It now restricts itself to publishing contributions relating to antiquities and the middle ages and Oriental studies.

Louis Auguste de Bourbon, sovereign prince of Dombes, having transferred his parliament to Trévoux, set up a printing press, and was persuaded by two Jesuits, Michel le Tellier and Philippe Lalleman, to establish the *Mémoires pour servir à l'histoire des sciences et des arts* (1701-1767), more familiarly known as the *Journal des Trévoux*, long the best informed and best-written journal in France. One feature of its career was its constant appeal for the literary assistance of outsiders. It was continued in a more popular style as *Journal des sciences et des beaux-arts* (1768-1775), by the abbé Aubert and by the brothers Castillon (1776-1778), and as *Journal de littérature, des sciences, et des arts* (1779-1782) by the abbé Grosier.

The first legal periodical was the *Journal du palais* (1672) of Claude Blondeau and Gabriel Cuiéret, and the first devoted to medicine the *Nouvelles découvertes dans toutes les parties de la médecine* (1679) of Nicolas de Bligny, frequently spoken of as a charlatan, a term which sometimes means simply a man of many ideas. Religious periodicals date from 1680, and the *Journal ecclésiastique* of the abbé de la Roque, to whom is also due the first medical journal (1683). The prototype of the historico-literary periodical may be discovered in *La Clef du cabinet des princes de l'Europe* (1704-1706), familiarly known as *Journal de Verdun*, and carried on under various titles down to 1794.

Literary criticism was no more free than political discussion, and no person was allowed to trespass either upon the domain of the *Journal des sçavants* or that of the *Mercur de France* (see *NEWS-PAPERS*) without the payment of heavy subsidies. This was the origin of the clandestine press of Holland, and it was that country which for the next hundred years supplied the ablest periodical criticism from the pens of French Protestant refugees. During that period thirty-one journals of the first class proceeded from these sources. From its commencement the *Journal des sçavants* was pirated in Holland, and for ten years a kind of joint issue made up with the *Journal des Trévoux* appeared at Amsterdam. From 1762 to 1775 miscellaneous articles from different French and English reviews were added to this reprint. Bayle, a born journalist and the most able critic of the day, conceived the plan of the *Nouvelles de la république des lettres* (1684-1718), which at once because entirely successful and obtained for him during the three years of his control the dictatorship of the world of letters. He was succeeded as editor by La Roque, Barrin, Bernard and Leclerc. Bayle's method was followed in an equally meritorious periodical, the *Histoire des ouvrages des sçavants* (1687-1704) of H. Bassagne de Beauval. Another continuator of Bayle was Jean Leclerc, one of the most learned and acute critics of the 18th century, who carried on three reviews—the *Bibliothèque universelle et historique* (1686-1693), the *Bibliothèque choisie* (1703-1713), and the *Bibliothèque ancienne et moderne* (1714-1727). They form one series, and, besides valuable estimates of new books, include original dissertations, articles and biographies like our modern learned magazines. The *Journal littéraire* (1713-1722, 1729-1736) was founded by a society of young men, who made it a rule to discuss their contributions in common. Specially devoted to English literature were the *Bibliothèque anglaise* (1716-1728), the *Mémoires littéraires de la Grande Bretagne* (1720-1724), the *Bibliothèque britannique* (1733-1734), and the *Journal britannique* (1750-1757) of Maty, who took for his principle, "pour penser avec liberté il faut penser seul." One of these Dutch-printed reviews was *L'Europe sçavante* (1718-1720), founded chiefly by Themiseul de Saint-Hyacinthe, with the intention of placing each separate department under the care of a specialist. The *Bibliothèque germanique* (1720-1740) was established by Jacques Lenfant to do for northern Europe what the *Bibliothèque britannique* did for England. It was followed by the *Nouvelle bibliothèque germanique* (1746-1759). The *Bibliothèque raisonnée des ouvrages des sçavants* (1728-1758) was supplementary to Leclerc, and was succeeded by the *Bibliothèque des sciences et des beaux-arts* (1754-1780). Nearly all of the preceding were produced either at Amsterdam or Rotterdam, and, although out of place in a precise geographical arrangement, really belong to France by the close ties of language and of blood.

Taking up the exact chronological order again, we find the success of the English essay-periods led to their prompt introduction to the Continent. An incomplete translation of the *Spectator* was published at Amsterdam in 1714, and many volumes of extracts from the *Teller*, *Spectator* and *Guardian* were issued in France early in the 18th century. Marivaux brought out a *Spectateur Français* (1722), which was coldly received; it was followed by fourteen or fifteen others, under the titles of *Le Spectateur* (1728-1730), *Le Radeleur* (1775), *Le Babillard* (1778-1779), &c. Of a similar character was *Le Pour et le contre* (1723-1740) of the abbé Prévost, which contained anecdotes and criticism, with special reference to Great Britain. Throughout the 18th century, in France as in England, a favourite literary method was to write of social subjects under the assumed character of a foreigner, generally an

¹ Matthew Maty, M.D., born in Holland, 1718, died principal librarian of the British Museum, 1776. He settled in England in 1740, published several books, and wrote the preface to Gibbon's first work, *Essai de la littérature*.

Oriental, with the title of *Turkish Spy, Lettres chinoises, &c.* These productions were usually issued in periodical form, and, besides an immense amount of worthless tittle-tattle, contain some valuable matter.

During the first half of the century France has little of importance to show in periodical literature. The *Nouvelles ecclésiastiques* (1728-1803) were first printed and circulated secretly by the Jansenists in opposition to the *Constitution unigenita*. The Jesuits retaliated with the *Supplément des nouvelles ecclésiastiques* (1734-1748). The promising title may have had something to do with the temporary success of the *Mémoires secrets de la république des lettres* (1744-1748) of the marquis d'Argens. In the *Observations sur les écrits modernes* (1735-1743) Desfontaines held the gates of Philistia for eight years against the Encyclopaedists, and even the redoubtable Voltaire himself. It was continued by the *Jugements sur quelques ouvrages nouveaux* (1744-1745). The name of Fréron, perhaps the most vigorous enemy Voltaire ever encountered, was long connected with *Lettres sur quelques écrits de ce temps* (1749-1754), followed by *L'Année littéraire* (1754-1790). Among the contributors of Fréron was another manufacturer of criticism, the abbé de la Porte, who, having quarrelled with his confrères, founded *Observations sur la littérature moderne* (1749-1752) and *L'Observateur littéraire* (1758-1761).

A number of special organs came into existence about this period. The first, treating of agriculture and domestic economy, was the *Journal économique* (1751-1772); a *Journal de commerce* was founded in 1750; periodical biography may be first seen in the *Nécrologe des hommes célèbres de France* (1764-1782); the political economists established the *Ephémérides du citoyen* in 1765; the first *Journal d'éducation* was founded in 1768, and the *Courrier de la mode* in the same year; the theatre had its first organ in the *Journal des Acteurs* (1770); in the same year were produced a *Journal de musique* and the *Encyclopédie militaire*; the sister service was supplied with a *Journal de marine* in 1778. We have already noticed several journals specially devoted to one or other foreign literature. It was left to Fréron, Grimm, Prévoist and others in 1754 to extend the idea to all foreign productions, and the *Journal étranger* (1754-1762) was founded for this purpose. The *Gazette littéraire* (1764-1766), which had Voltaire, Diderot and Saint-Lambert among its editors, was intended to swamp the small fry by criticism; the *Journal des dames* (1759-1778) was of a light magazine class; and the *Journal de monsieur* (1776-1783) had three phases of existence, and died after extending to thirty volumes. The *Mémoires secrets pour servir à l'histoire de la république des lettres* (1762-1787), better known as *Mémoires de Bachaumont*, from the name of their founder, furnish a minute account of the social and literary history for a period of twenty-six years. Of a similar character was the *Correspondance littéraire secrète* (1774-1793), to which Métra was the chief contributor. *L'Esprit des Journaux* (1772-1818) forms an important literary and historical collection, which is rarely to be found complete.

The movement of ideas at the close of the century may best be traced in the *Annales politiques, civiles, et littéraires* (1777-1792) of Linguet. The *Décade philosophique* (year V., or 1796/1797), founded by Ginguené, is the first periodical of the magazine class which appeared after the storms of the Revolution. It was a kind of resurrection of good taste; under the empire it formed the sole refuge of the opposition. By a decree of the 17th of January 1800 the consulate reduced the number of Parisian journals to thirteen, of which the *Décade* was one; all the others, with the exception of those dealing solely with science, art, commerce and advertisements, were suppressed. A report addressed to Bonaparte by Fiyévé in the year XI. (1802/1803) furnishes a list of fifty-one of these periodicals. In the year XIII. (1804/1805) only seven non-political serials were permitted to appear.

Between 1815 and 1819 there was a constant struggle between freedom of thought on the one hand and the censure, the police and the law officers on the other. This oppression led to the device of "semi-periodical" publications, of which *La Minerve française* (1818-1820) is an instance. It was the *Satire Ménippée* of the Restoration, and was brought out four times a year at irregular intervals. Of the same class was the *Bibliothèque historique* (1818-1820), another anti-royalist organ. The censure was re-established in 1820 and abolished in 1828 with the monopoly. It has always seemed impossible to carry on successfully in France a review upon the lines of those which have become so numerous and important in England. The *Revue britannique* (1825-1901) had, however, a long career. The short-lived *Revue française* (1828-1830), founded by Guizot, Rémusat, De Broglie, and the doctrinaires, was an attempt in this direction. The well-known *Revue des deux mondes* was established in 1829 by Ségur-Dupeyron and Mauroy, but it ceased to appear at the end of the year, and its actual existence dates from its acquisition in 1831 by François Buloz,¹ a masterful editor,

under whose energetic management it soon achieved a world-wide reputation. The most distinguished names in French literature have been among its contributors, for whom it has been styled the "vestibule of the Academy." It was preceded by a few months by the *Revue de Paris* (1829-1835), founded by Vignon, who introduced the novel to periodical literature. In 1834 this was purchased by Buloz, and brought out concurrently with his other *Revue*. While the former was exclusively literary and artistic, the latter dealt more with philosophy. The *Revue indépendante* (1831-1848) was founded by Pierre Leroux, George Sand and Viardot for the democracy. The times of the consulate and the empire were the subjects dealt with by the *Revue de l'empire* (1842-1848). In *Le Correspondant* (1843), established by Montalembert and De Falloux, the Catholics and Legitimists had a valuable supporter. The *Revue contemporaine* (1852), founded by the comte de Beval as a royalist organ, had joined to it in 1856 the *Athenaeum français*. The *Revue germanique* (1858) exchanged its exclusive name and character in 1865 to the *Revue moderne*. The *Revue européenne* (1859) was at first subventioned like the *Revue contemporaine*, from which it soon withdrew government favour. The *Revue nationale* (1860) appeared quarterly, and succeeded to the *Magasin de librairie* (1858).

The number of French periodicals, reviews and magazines has enormously increased, not only in Paris but in the provinces. In Paris the number of periodicals published in 1883 was 1379; at the end of 1908 there were more than 3500 of all kinds. The chief current periodicals may be mentioned in the following order. The list includes a few no longer published.

Archæology.—*Revue archéologique* (1860), bi-monthly; *Ami des monuments* (1887); *Bulletin de numismatique* (1891); *Revue biblique* (1892); *L'Année épigraphique* (1880)—a sort of supplement to the *Corpus inscriptionum latinarum*; *Celica* (1903)—common to France and England; *Gazette numismatique française* (1897); *Revue sémitique d'épigraphie et d'histoire ancienne* (1893); *Bulletin monumental*, bi-monthly; *L'Intermédiaire*, weekly, the French "Notes and Queries," devoted to literary and antiquarian questions.

Astronomy.—*Annuaire astronomique et météorologique* (1901); *Bulletin astronomique* (1884), formerly published under the title *Bulletin des sciences mathématiques et astronomiques*.

Bibliography.—*Annales de bibliographie théologique* (1888); *La bibliographie moderne* (1897); *Bibliographie anatomique* (1891); *Bibliographie scientifique française* (1902); *Bulletin des bibliothèques et des archives* (1884); *Bulletin des livres reliés à l'Amérique* (1899); *Courrier des bibliothèques* (1910); *Répertoire méthodique de l'histoire moderne et contemporaine de la France* (1898); *Répertoire méthodique du moyen âge français* (1894); *Revue bibliographique et critique des langues et littératures romanes* (1889); *Revue des bibliothèques* (1891); *Polybibliothèque: revue bibliographique universelle*, monthly; *Revue générale de bibliographie française*, bi-monthly.

Children's Magazines.—*L'Ami de la jeunesse*; *Le Jeudi de la jeunesse*, weekly.

Fashions.—*La Mode illustrée*; *Les Modes*, monthly.

Fine Arts.—*Les Arts* (1902); *Gazette des beaux-arts* (1859), monthly, with *Chronique des arts*; *Revue de l'art ancien et moderne* (1897) monthly; *L'Art décoratif*, monthly, *Art et décoration*, monthly; *L'Art pour tous*, monthly; *La Décoration*, monthly; *L'Architecture*—journal of the Soc. centrale des Architectes français, weekly; *L'Art* (1875) is no longer published.

Geography and Colonies.—*Bulletin de géographie historique; Annales de géographie* (1891), with useful quarterly bibliography; *Nouvelles géographiques*—supplement to the *Tour du monde* (1891); *La Vie coloniale* (1902); *La Géographie*, monthly, published by the Soc. de Géographie (1900); *Revue de géographie*, monthly; *Revue géographique internationale*, monthly.

History.—For long the chief organs for history and archæology were the *Bibliothèque de l'école des chartes* (1835), appearing every two months and dealing with the middle ages, and the *Cabinet historique* (1855), a monthly devoted to MSS. and unprinted documents. The *Revue historique* (1876) appears bi-monthly; there is also the *Revue d'histoire moderne et contemporaine*.

Law and Jurisprudence.—*Annales de droit commercial* (1877); *Revue algérienne et tunisienne de législation et de jurisprudence* (1885); *Revue du droit public et de la science politique* (1894); *Revue générale du droit international public* (1894).

Literary Reviews.—The *Revue des deux mondes* and the *Correspondant* have already been mentioned. One of the first of European weekly reviews is the *Revue critique* (1866). The *Revue politique et littéraire*, successor to the *Revue des cours littéraires* (1863) and known as the *Revue Bleue*, also appears weekly. Others of interest are: *Anité, revue mensuelle de littérature* (1904); *L'Art et la vie* (1892); *Cosmopolis* (1896); *L'Ermitage* (1890); *Le Mercure de France, série moderne* (1890), a magazine greatly valued in literary circles; *La Revue de Paris*, fortnightly (1894), and the *Nouvelle Revue* (1879)—

¹ The novelist and publicist Joseph Fiyévé (1767-1839), known for his relations with Napoleon I., has been made the subject for a study by Sainte-Beuve (*Causeries*, v. 172).

² This remarkable man (1804-1877) began life as a shepherd. Educated through the charity of M. Naville, he came to Paris as

a compositor, and by translating from the English earned sufficient to purchase the moribund *Revue des deux mondes*, which acquired its subsequent position in spite of the tyrannical editorial behaviour of the proprietor. Buloz is said to have eventually enjoyed an income of 365,000 francs from the *Revue*.

both serious rivals of the *Revue des deux mondes*; *Revue française d'Édimbourg* (1897); *Revue germanique* (1905); *Le Livre* (1880), dealing with bibliography and literary history, and *La Revue latine* (1902), no longer published; *La Revue*, monthly.

Mathematics.—*Intermédiaire des mathématiciens* (1894); *Bulletin des sciences mathématiques* (1896); *Revue de mathématiques spéciales* (1890); *Journal de mathématiques pures et appliquées*, quarterly.

Médecine.—*Revue de médecine* (1881); *Annales de l'École de plein exercice de médecine et de pharmacie de Marseille* (1891); *La Chronique médicale* (1893); *Revue de gynécologie*, bi-monthly; *La Semaine médicale*, weekly; *Journal d'hygiène*, monthly.

Military.—*Revue des troupes coloniales*, monthly; *La Revue d'infanterie*, monthly.

Music.—*Musica* (1902); *Revue d'histoire et de critique musicale* (1901); *Annales de la musique*; *Le Ménestrel*, weekly.

Philology.—*L'Année linguistique* (1901-1902); *Bulletin de la société des parlars de France* (1893); *Bulletin des humanités français* (1891); *Bulletin hispanique* (1899); *Bulletin italien* (1901); *Low-Gai-Sabé-Antoulongio promouéno* (1905); *Le Maitre phonétique* (1886); *Le Moyen Age* (1888); *Revue de la renaissance* (1901); *Revue de métrique et de versification* (1894-1895); *Revue des études grecques* (1888); *Revue des études romanes* (1903); *Revue des parlars populaires* (1902); *Revue des patois* (1887); *Revue hispanique* (1894); *Revue celtique*, quarterly; *Revue de philologie française et de littérature*.

Philosophy and Psychology.—*Revue philosophique* (1876), monthly; *Annales des sciences psychiques* (1891); *L'Année philosophique* (1890), critical and analytical review of all philosophical works appearing during the year; *L'Année psychologique* (1894); *Journal de psychologie normale et pathologique* (1904); *Bulletin de l'Institut général de psychologie* (1903); *Revue de l'hypnotisme et de la psychologie physiologique* (1900); *Revue de métaphysique et de morale* (1893); *Revue de philosophie* (1900); *Revue de psychiatrie* (1897).

Physics and Chemistry.—*Bulletin des sciences physiques* (1888); *L'Éclairage électrique* (1894); *Le Radium* (1904); *Revue générale des sciences pures et appliquées* (1890); *Revue pratique de l'électricité* (1892).

Popular and Family Reviews.—*A travers le monde* (1898); *Femina* (1901); *Je sais tout* (1905); *La Lecture moderne* (1901); *La Revue hebdomadaire* (1892); *Les Lectures pour tous* (1898); *Mon bonheur* (1902); *La Vie heureuse* (1902).

Science (General).—*La Nature*, weekly; *Revue scientifique* (1863), weekly; *La Science française*, monthly; *Science (Applied)*: *Les inventions illustrées*, weekly; *Revue industrielle*, weekly; *Science (Natural)*: *Archives de biologie*, *Journal de botanique* (1887); *L'Année biologique* (1895); *Revue des sciences naturelles de l'ouest* (1891); *Revue générale de botanique* (1889); *La Pisciculture pratique* (1895).—*Science (Political, Sociological and Statistical)*: *Annales économiques* (founded as *La France commerciale* in 1885); *L'Année sociologique* (1896-1897); *Bulletin de l'office du travail* (1894); *Bulletin de l'office international du travail* (1902); *Le Mouvement socialiste*—international bi-monthly (1899); *Notices et comptes rendus de l'office du travail* (1892); *L'Orient et l'abeille du Bosphore* (1899); *Revue politique et parlementaire* (1894); *Revue internationale de sociologie*, monthly.

SPORTS.—*L'Aérophile* (1893); *L'Aéronautique* (1902); *L'Aérotation* (1904); *La Vie au grand air* (1898); *La-Vie automobile* (1901); *Revue de l'aéronautique* (1888).

AUTHORITIES.—The subject of French periodicals has been exhaustively treated in the valuable works of Eugène Hatin—*Histoire de la presse en France* (8 vols., 1859-1861), *Les Gazettes de Hollande et la presse clandestine aux 17^e et 18^e siècles* (1865), and *Bibliographie de la presse périodique française* (1866). See also *Catologue de l'histoire de France* (11 vols., 1855-1879), V. Gêbe, *Catologue des journaux, &c., publiés à Paris* (1879); Brunet, *Manuel du libraire, avec supplément* (8 vols., 1860-1860); F. Mège, *Les journaux et écrits périodiques de la Basse Auvergne* (1866); *Bulletin des sommaires des journaux* (1888); D. Jordell, *Répertoire bibliographique des principaux revues françaises* (4 vols., 1897-1899, 1898-1900), indexes about 350 periodicals; *Annuaire de la presse française et du monde politique* (1900-1910); Le Soudier, *Annuaire des journaux, revues et publications périodiques parus à Paris jusqu'en 1909* (1910). For lists of general indexes consult Stein, *Manuel de bibliographie générale* (1897), pp. 637-710.

GERMANY

The earliest trace of the literary journal in Germany is to be found in the *Erbauliche Monatsunterredungen* (1663) of the poet Johann Rist and in the *Miscellanea curiosa medico-physica* (1670-1704) of the Academia naturae curiosorum Leopoldina-Carolina, the first scientific annual, uniting the features of the *Journal des savants* and of the *Philosophical Transactions*. D. G. Morhof, the author of the well-known *Polyhistor*, conceived the idea of a monthly serial to be devoted to the history of modern books and learning, which came to nothing. While professor of morals at Leipzig, Otto Mencke planned the *Acta eruditiorum*, with a view to make known, by means of analyses, extracts and reviews, the new works produced throughout Europe. In 1680 he travelled in England and Holland in order to obtain literary assistance, and

the first number appeared in 1682, under the title of *Acta eruditiorum lipsiensium*, and, like its successors, was written in Latin. Among the contributors to subsequent numbers were Leibnitz, Seckendorf and Cellarius. A volume came out each year, with supplements. After editing about thirty volumes Mencke died, leaving the publication to his son, and the *Acta* remained in the possession of the family down to 1745, when they extended to 117 volumes, which form an extremely valuable history of the learning of the period. A selection of the dissertations and articles was published at Venice in 7 vols. 4to (1740). The *Acta* soon had imitators. The *Ephemeres litterariae* (1686) came out at Hamburg in Latin and French. The *Nova litteraria maris Balkici et Septentrionis* (1698-1708) was more especially devoted to north Germany and the universities of Kiel, Rostock and Dorpat. Supplementary to the preceding was the *Nova litteraria Germaniae collecta Hamburgi* (1703-1709), which from 1707 widened its field of view to the whole of Europe. At Leipzig was produced the *Teutsche acta eruditiorum* (1712), an excellent periodical, edited by J. G. Rabener and C. G. Jöcher, and continued from 1740 to 1758 as *Zuerlässige Nachrichten*. It included portraits.

The brilliant and enterprising Christian Thomasius brought out periodically, in dialogue form, his *Monatsgespräche* (1688-1690), written by himself in the vernacular, to defend his novel theories against the alarmed pedantry of Germany, and, together with Strahl, Buddes and others, *Observationes selectae ad rem litterariam spectantes* (1700), written in Latin. W. E. Tenzel also published *Monatliche Unterredungen* (1689-1698), continued from 1708 as *Curieuse Bibliothek*, and treating various subjects in dialogue form. After the death of Tenzel the *Bibliothek* was carried on under different titles by C. Woltereck, J. G. Krause and others, down to 1721. Of much greater importance than these was the *Monatlicher Anzeiger* (1701), supported by J. G. Eccard and Leibnitz. Another periodical on Thomasius's plan was *Neue Unterredungen* (1702), edited by N. H. Gundling. The *Gundlingiana* of the latter person, published at Halle (1715-1732), and written partly in Latin and partly in German by the editor, contained a miscellaneous collection of juridical, historical and theological observations and dissertations.

Nearly all departments of learning possessed their several special periodical organs about the close of the 17th or the beginning of the 18th century. The *Anni Francoanorum* (1680) was edited by the Jesuit Stiller; and J. S. Adami published, between 1690 and 1713, certain theological repertoires under the name of *Deliciae*. Historical journalism was first represented by *Electa juris publici* (1709), philology by *Neue aetna philologica* (1715-1723), philosophy by the *Acta philosophorum* (1715-1727), medicine by *Der patriotische Medikus* (1725), music by *Der musikalische Patriot* (1725), and education by *Die Maitrone* (1728). Reference has already been made to the *Miscellanea curiosa medico-physica* (1670-1704); the *Monatliche Erzählungen* (1689) was also devoted to natural science.

Down to the early part of the 18th century Halle and Leipzig were the headquarters of literary journalism in Germany. Other centres began to feel the need of similar organs of opinion. Hamburg had its *Nieder-sächsische neue Zeitungen*, styled from 1731 *Nieder-sächsische Nachrichten*, which came to an end in 1736, and Mecklenburg owned in 1710 its *Neuer Vorrath*, besides others brought out at Rostock. Prussia owes the foundation of its literary periodicals to G. P. Schulze and M. Lilienthal, the former of whom began with *Gelehrtes Preussen* (1722), continued under different titles down to 1729; the latter helped with the *Erleutertes Preussen* (1724), and was the sole editor of the *Acta borussica* (1730-1732). Pomerania and Silesia also had their special periodicals in the first quarter of the 18th century. Franconia commenced with *Nova litteraria*, and Hesse with the *Kurze Historie*, both in 1725. In south Germany appeared the *Württembergische Nebenstunden* (1718), and the *Parnassus boicus*, first published at Munich in 1722. The *Frankfurter gelehrte Zeitungen* was founded in 1736 by S. T. Hocker, and existed down to 1790. Austria owned *Das merkwürdige Wien*.

In 1715 the *Neue Zeitungen von gelehrten Sachen* was founded by J. G. Krause at Leipzig and carried on by various editors down to 1797. It was the first attempt to apply the form of the weekly political journal to learned subjects, and was imitated in the *Ver-mischte Bibliothek* (1718-1720) and the *Bibliotheca novissima* (1718-1721), both founded by J. G. Francke in Halle. Shortly after the foundation of the university of Göttingen appeared *Zeitungen von gelehrten Sachen* (1739), still famous as the *Göttingische gelehrte Anzeigen*, which during its long and influential career has been conducted by professors of that university, and among others by Haller, Heyne and Eichhorn.

Influenced by a close study of English writers, the two Swiss, Bodmer and Breitinger, established *Die Discurs der Mäler* (1721), and by paying more attention to the matter of works reviewed than to their manner, commenced a critical method new to Germany. The system was attacked by Gottsched, who, educated in the French school, erred in the opposite direction. The struggle between the two parties gave fresh life to the literature of the country but German criticism of the higher sort can only be said really to begin with Lessing. The Berlin publisher Nicolai founded the *Bibliothek der schönen Wissenschaften*, and afterwards handed it over to C. F. Weisse in order to give his whole energy to the *Briefe, die neueste Literatur betreffend* (1759-1765), carried on by the help

of Lessing; Mendelssohn and Abbt. To Nicolai is also due the *Allgemeine deutsche Bibliothek* (1766-1806), which embraced a much wider field and soon became extremely influential. Herder founded the *Kritische Wälder* in 1766. *Der deutsche Merkur* (1773-1789, revived 1790-1810) of Wieland was the solitary representative of the French school of criticism. A new era in German periodical literature began when Bertuch brought out at Jena in 1785 the *Allgemeine Literaturzeitung*, to which the leading writers of the country were contributors. On being transferred to Halle in 1804 it was replaced by the *Jenaische allgemeine Literaturzeitung*, founded by Eichardt. Both reviews enjoyed a prosperous career down to the year 1848.

At the beginning of the 19th century we find the *Erlanger Literaturzeitung* (1799-1810), which had replaced a *Gelehrte Zeitung* (1746); the *Leipziger Literaturzeitung* (1800-1834); the *Heidelbergsche Jahrbücher der Literatur* (1808-1872); and the *Wiener Literaturzeitung* (1813-1816), followed by the *Wiener Jahrbücher der Literatur* (1818-1848), both of which received government support and resembled the English *Quarterly Review* in their conservative politics and high literary tone. *Hermes*, founded at Leipzig in 1819 by W. T. Krug, was distinguished for its erudition, and came out down to 1831. One of the most remarkable periodicals of this class was the *Jahrbücher für wissenschaftliche Kritik* (1827-1846), first published by Cotta. The *Hallsche Jahrbücher* (1827-1842) was founded by Ruge and Echtermeyer, and supported by the government. The *Repertorium der gesammten deutschen Literatur*, established by Gersdorf in 1831, and known after 1843 as the *Leipziger Repertorium der deutschen und ausländischen Literatur*, existed to 1860. Buchner founded the *Literarische Zeitung* at Berlin in 1834. It was continued by Brandes down to 1849. The political troubles of 1848 and 1849 were most disastrous to the welfare of the literary and miscellaneous periodicals. Gersdorf's *Repertorium*, the *Gelehrte Anzeigen* of Göttingen and of Munich, and the *Heidelbergsche Jahrbücher* were the sole survivors. The *Allgemeine Monatschrift für Literatur* (1850), conducted after 1851 by Droysen, Nitzsch and others, continued only down to 1854; the *Literarisches Centralblatt* (1850) is still published. The *Bilder für literarische Unterhaltung* sprang out of the *Literarisches Wochenblatt* (1818), founded by Kotzebue; after 1865 it was edited by R. Gottschall with considerable success. Many of the literary journals did not disdain to occupy themselves with the fashions, but the first periodical of any merit specially devoted to the subject was the *Basar* (1855). The first to popularize science was *Natur* (1852). The *Hausblätter* (1855), a bi-monthly magazine, was extremely successful. The *Salon* (1868) followed more closely the type of the English magazine. About this period arose a great number of weekly serials for popular reading, known as "Sonntagsblätter," of which the *Gartenlaube* (1858) and *Dukeim* (1864) are surviving examples.

In course of time a large number of similar publications were issued, some illustrated, for instance: *Illustrierte Zeitung* (Leipzig, 1843), *Berliner Illustrierte Zeitung* (1892), *Die Woche* (1899) the last the most widely circulated of the kind, 500,000 being printed.

At a somewhat earlier date commenced a long series of weekly and monthly periodicals of a more solid character, of which the following list indicates the more important in chronological order: *Die Grenzboten* (1862), weekly; *Das Deutsche Museum* (1851-1857), of Prutz and Frenzel; *Berliner Revue* (1855-1873); *Westermanns Monatshefte* (1856), monthly; *Unsere Zeit* (1857-1891), beginning as a kind of supplement to Brockhaus's *Conversationslexikon*; *Preussische Jahrbücher* (1858), monthly; *Deutsches Magazin* (1861-1863); *Die Gegenwart* (1873), weekly; *Konservative Monatschrift* (1873), preceded by the *Volksblatt für Stadt und Land* (1843); *Deutsche Rundschau* (1874), fortnightly, conducted upon the method of the *Revue des deux mondes*; *Deutsche Revue* (1876), monthly; *Nord und Süd* (1877), monthly; *Das Echo* (1882), weekly; *Die Zukunft* (1882), weekly; *Die neue Zeit* (1883), weekly; *Reclams Universum* (1884), weekly; *Velhagen und Klasing's Monatshefte* (1889), monthly; *Die deutsche Rundschau* (1890), monthly; *Die Wahrheit* (1893-1897); *Kritik* (1894-1902); *Die Umschau* (1897), weekly; *Das literarische Echo* (1898), fortnightly; *Kynast* (1898-1899), known later as *Deutsche Zeitschrift* (1899-1903) and *Iduna* (1903-1906); *Der Türmer* (1898), monthly; *Die Warte* (1900), weekly; *Deutschland* (1902-1907); *Deutsche Monatschrift* (1902-1907); *Hochland* (1903), monthly; *Charon* (1904), monthly; *Süddeutsche Monatshefte* (1904); *Der Deutsche* (1905-1908); *Deutsche Kultur* (1905-1908); *Arena* (1906), monthly; *Das Blaubuch* (1906), weekly; *Eckart* (1906), monthly; *Die Standard* (1906), weekly; *Märs* (1907), fortnightly; *Morgen* (1907), weekly; *Neue Revue* (1907), weekly; *Internationale Wochenschrift für Wissenschaft, Kunst, und Technik* (1907), weekly supplement to the *Münchener allgemeine Zeitung*; *Wissen* (1907), weekly; *Unsere Zeit* (1907), monthly; *Hyperion* (1908), bi-monthly; *Kenien* (1908), monthly; *Das neue Jahrbuch* (1909), monthly; *Die Tat* (1909), monthly.

Periodicals have been specialized in Germany to an extent perhaps unequalled in any other country. No subject of human interest is now without one or indeed several organs. Full details of these serials are supplied by a special class of periodical with which every department of science, art and literature in German-

speaking countries is equipped, the *Jahresberichte und Bibliographien*, which give each year a full account of the literature of the subject with which they are concerned. The chief of these are:—

Bibliography and Librarianship: *Bibliographie des Buch- und Bibliothekswesens* (1905); Chemistry: *Jahresbericht über die Fortschritte der Chemie* (1847); Classical Archaeology and Philology: *Jahresbericht über die Fortschritte der klassischen Altertumswissenschaft* (1873); Education: *Jahrbuch der pädagogischen Literatur* (1901); Geography: *Geographisches Jahrbuch* (1874); *Bibliotheca geographica* (1891); History: *Jahresberichte der Geschichtswissenschaft* (1878); Fine Arts: *Internationale Bibliographie der Kunstwissenschaft* (1902); Law and Political Economy: *Uebersicht der gesamten staats- und rechtswissenschaftlichen Literatur* (1868); Jurisprudence: *Germania* (1905); *Bibliographie des bürgerlichen Rechts* (1888); *Bibliographie der Sozialwissenschaften* (1905); *Bibliographie für Sozial- und Wirtschaftsgeschichte* (1903); *Bibliograph für Volkswirtschaftslehre und Kochwissenschaft* (1906); Literature and Languages: *Bibliographie der vergleichenden Literaturgeschichte* (1903); *Jahresberichte für neuere deutsche Literaturgeschichte* (1900); *Jahresbericht über die Erscheinungen auf dem Gebiete der germanischen Philologie* (1879); *Uebersicht über die auf dem Gebiete der englischen Philologie erschienenen Bücher, Schriften, und Aufsätze* (1878); *Kritischer Jahresbericht über die Fortschritte der romanischen Philologie* (1875); *Bibliographie für romanische Philologie—Suppl. von Zeitschr. f. roman. Philologie* (1875); *Orientalische Bibliographie* (1895); Mathematics: *Jahrbuch über die Fortschritte der Mathematik* (1869); Medicine and Surgery: *Jahresbericht über die Leistungen und Fortschritte der gesamten Medizin* (1866); *Jahresbericht über die Leistungen auf dem Gebiete der Veterinärmedizin* (1881); Military: *Jahresbericht über Veränderungen und Fortschritte im Militärwesen* (1874); *Jahresbericht über die Leistungen und Fortschritte auf dem Gebiete des Militärärztlichen Wesens* (1873); Natural Science: *Naturgeschichte* (1879), fortnightly; *Bibliographie der deutschen naturwissenschaftlichen Literatur* (1901); *Bibliographia zoologica* (1896); Zoological: *Jahresbericht* (1879); *Justi botanischer Jahresbericht* (1873); *Die Fortschritte der Physik* (1847); Technology: *Repertorium der technischen Journalliteratur* (1874); Theology: *Theologischer Jahresbericht* (1881); *Bibliographie der Kirchengeschichtlichen Literatur* (1877).

AUSTRIA

The most notable periodicals of a general character have been the *Wiener Jahrbücher der Literatur* (1818-1848) and the *Oesterreichische Revue* (1863-1867). Among current examples the following may be mentioned: *Heimgarten* (1877), monthly; *Oesterreichisch-ungarische Revue* (1886), monthly; *Allgemeines Literaturblatt* (1892), fortnightly; *Die Kultur* (1890), quarterly; *Deutsche Arbeit* (1900), monthly; *Oesterreichische Rundschau* (1904), fortnightly; *Die Karpathen* (1907), fortnightly.

There were in Austria 22 literary and 41 special periodicals in 1848, and 110 literary and 413 special periodicals in 1873 (see the statistical inquiry of Dr. Johann Winckler, *Die period. Presse Oesterreichs*, 1875). In 1905 the total number had increased to 806, of which 564 were published in Vienna.

According to the *Deutscher Zeitschriften-Katalog* (1874), 2219 periodicals were published in Austria, Germany and Switzerland in 1874 in the German language. In 1905 the number of periodicals in German-speaking countries was 5066, of which 4019 appeared in Germany (in Berlin alone 1107) 806 in Austria and 218 in Switzerland (*Börsenblatt für den deutschen Buchhandel*, 1909, No. 124).

AUTHORITIES.—C. Juncker, *Schediasma de ephemeridibus eruditiorum* (Leipzig, 1692); H. Kurz, *Geschichte der deutschen Literatur* (Leipzig, 1852); R. Prutz, *Geschichte des deutschen Journalismus* (1845) vol. i.,—unfortunately it does not go beyond 1713; H. Wuttke, *Die deutschen Zeitschriften* (1875); P. E. Richter, *Vermischtes der Periodica im Besitze der k. off. Bibl. zu Dresden* (1880); *Generalcatalog der laufenden periodischen Druckschriften an den oesterr. Universitäts- und Studienbibliotheken* hrg. von F. Grassauer (Vienna, 1898); *Königliche Bibliothek zu Berlin, Alphabetisches Verzeichnis der laufenden Zeitschriften* (1908); *Systematisches Verzeichnis der laufenden Zeitschriften* (1908); *Alphabetisches Verzeichnis der laufenden Zeitschriften, welche von der K. Hof- und Staatsbibliothek München und einer Anzahl anderer Bibliotheken Bayern gehalten werden* (München, 1909); *Kärntner Jahrbuch der Presse* (1902); *Sperlings Zeitschriften Adressbuch* (Stuttgart, 1910); *Bibliographisches Repertorium*, Berlin; *Walzel-Houben, Zeitschriften der Romanistik* (1904); *Houben, Zeitschriften des jungen Deutschlands* (1906); *Luck, Die deutsche Fachpresse* (Tübingen, 1908). The *Bibliographie der deutschen Zeitschriftenliteratur*, edited by F. Dieterich, which has appeared annually since 1896, describes about 1300 periodicals (mostly scientific) by subjects and titles; from 1900 it has been supplemented by *Bibliographie der deutschen Rezensionen*, which indexes notices and reviews in over 1000 serials each year, chiefly scientific and technical.

SWITZERLAND

The *Nova litteraria helvetica* (1705-1715) of Zurich is the earliest literary periodical which Switzerland can show. From 1728 to 1754 a *Bibliothèque italique*, and towards the end of the century the *Bibliothèque brisannique* (1796-1815), dealing with agriculture, literature, and science, in three separate series, were published at Geneva. The latter was followed by the leading periodical

of French-speaking Switzerland, the *Bibliothèque universelle* (1816), which has also had a scientific and a literary series. The *Revue suisse* (1838) was produced at Neuchâtel. These two have been amalgamated and appear as the *Bibliothèque universelle et revue suisse*. The *Revue romande* (1885) only lasted twelve months. *Théologie et philosophie* (1868-1872), an account of foreign literature on those subjects, was continued as *Revue de théologie et de philosophie* (1873) at Lausanne. Among current serials may be mentioned *Archives de psychologie de la Suisse romande* (1901) edited by Flournoy and Claparède; *Jahresverzeichnis der schweizerischen Universitätschriften* (1897-1898); *Untersuchungen zur neueren Sprach- und Literaturgeschichte* (1903); *Zwingliana: Mitteilungen zur Geschichte Zwingli und der Reformation* (1897).

ITALY

Prompted by M. A. Ricci, Francesco Nazari, the future cardinal, established in 1668 the *Giornale dei letterati* upon the plan of the French *Journal des sçavants*. His collaborateurs each agreed to undertake the criticism of a separate literature while Nazari retained the general editorship and the analysis of the French books. The journal was continued to 1675, and another series was carried on to 1769. Bacchini brought out at Parma (1688-1690) and at Modena (1692-1697) a periodical with a similar title. A much better known *Giornale* was that of Apostolo Zeno, founded with the help of Maffei and Muratori (1710), continued after 1718 by Pietro Zeno, and after 1728 by Mastraca and Patitoni. Another *Giornale*, to which Fabroni contributed, was published at Pisa from 1771 onwards. The *Galleria di Minerva* was first published at Venice in 1696. One of the many merits of the antiquary Lami was his connexion with the *Novelle letterarie* (1740-1770), founded by him, and after the first two years almost entirely written by him. Its learning and impartiality gave it much authority. The *Frusca letteraria* (1763-1765) was brought out at Venice by Giuseppe Baretti under the pseudonym of Aristarco Scannabue. The next that deserve mention are the *Giornale enciclopedico* (1806) of Naples, followed by the *Progresso delle scienze* (1833-1848) and the *Museo di scienze e letteratura* of the same city, and the *Giornale arcadico* (1810) of Rome. Among the contributors to the *Poligrafo* (1811) of Milan were Monti, Perticari, and some of the first names in Italian literature. The *Biblioteca italiana* (1816-1840) was founded at Milan by the favour of the Austrian government, and the editorship was offered to and declined by Ugo Foscolo. It rendered service to Italian literature by its opposition to the Della-Cruscan tyranny. Another Milanese serial was the *Conciliatore* (1818-1820), which although it only lived two years, will be remembered for the endeavours made by Silvio Pellico, Camillo Ugoni and its other contributors to introduce a more dignified and courageous method of criticism. After its suppression and the falling off in interest of the *Biblioteca italiana* the next of any merit to appear was the *Antologia*, a monthly periodical brought out at Florence in 1820 by Gino Capponi and Giampetro Vieusseux, but suppressed in 1833 on account of an epigram of Tommaseo, a principal writer. Some striking papers were contributed by Giuseppe Mazzini. Naples had in 1832 the *Progresso* of Carlo Troya, helped by Tommaseo and Centofanti, and Palermo owned the *Giornale di statistica* (1834), suppressed eight years later. The *Archivio storico*, consisting of reprints of documents with historical dissertations, dates from 1842, and was founded by Vieusseux and Gino Capponi. The *Civiltà cattolica* (1850), fortnightly, is still the organ of the Jesuits. The *Rivista contemporanea* (1852) was founded at Turin in emulation of the French *Revue des deux mondes*, which has been the type followed by so many continental periodicals. The *Politecnico* (1839) of Milan was suppressed in 1844 and revived in 1859. The *Nuova antologia* (1866) soon acquired a well-deserved reputation as a high-class review and magazine; its rival, the *Rivista europea*, being the special organ of the Florentine men of letters. The *Rassegna settimanale* was a weekly political and literary review, which after eight years of existence gave place to a daily newspaper, the *Rassegna*. The *Archivio trentino* (1882) was the organ of "Italia Irredenta." The *Rassegna nazionale*, conducted by the marchese Alfredo di Passano, a chief of the moderate clerical party, the *Nuova rivista* of Turin, the *Fanfulla della Domenica*, and the *Gazzetta letteraria* may also be mentioned.

Some of the following are still published: *Annali di matematica* (1867); *Annuario di giurisprudenza* (1883); *Archivio di statistica* (1876); *Archivio storico lombardo* (1874); *Archivio veneto* (1871); *Archivio per lo studio delle tradizioni popolari*; *Archivio per la zoologia*; *Il Bibliofilo*; *Il Filangieri* (1876); *La Natura* (1884); *Nuovo giornale botanico* (1869); *Giornale degli eruditi* (1883); *Giornale di filologia romana*; *Nuova rivista internazionale* (1879); *La Rassegna italiana* (1881); *Revue internationale* (1883). In more recent years a great expansion has been witnessed. Local reviews have largely increased, as well as those devoted to history, science and university undertakings. Among representative serials are the following—*Archæologia: Museo italiano di antichità classica* (1885) with atlas in folio; *Oriens christianus* (1901); *Nuovo bollettino di archeologia cristiana*, quarterly at Rome (1895). Bibliography: *Rivista delle biblioteche e degli archivi* (1888), published monthly at Rome and Florence, the official organ of librarians and archivists; *Giornale*

della libreria della tipografia (1888), supplement to the *Bibliografia italiana*; *Bollettino di bibliografia e storia delle scienze matematiche* (1898); *La Bibliofilia* (1899), Florence, monthly; *Raccolta Vinciana* (1904). Philology: *Bollettino di filologia classica* (1894); *Giornale italiano di filologia e linguistica classica* (1886); *Studi di filologia romana* (1885); *Studi italiani di filologia classica* (1893); *Passarione*, bi-monthly. No class has developed more usefully than the historical, among them being: *Bollettino dell' istituto storico italiano* (1886); *Nuovo archivio veneto* (1890); *Rivista di storia antica e scienze affini* (1895); *Rivista storica italiana* (1884). New literary and scientific reviews are: *L'Alighieri, rivista di cose dantesche* (1889); *Giornale dantesco* (1894); *Giornale storico della letteratura italiana* (1883); *Studi di letteratura italiana* (1899); *Studi medievali* (1904); *L'Arcadia, periodico mensile di scienze, lettere, ed arti* (1889); *Periodico di matematica per l'insegnamento secondario* (1885); *Rivista di matematica* (1891); *Rivista filosofica* (1899); *Rivista d'Italia*, monthly at Rome; *Fine Arts: L'Arte*, monthly; *Arte italiana*, monthly; *Rassegna d'arte*, monthly.

AUTHORITIES.—See G. Octino, *La Stampa periodica in Italia* (Milan, 1875); *Raccolta dei periodici presentata all' esposizione in Milano* (1881); A. Roux, *La Littérature contemporaine en Italie* (1871-1883), Paris, 1883.

BELGIUM

The *Journal encyclopédique* (1756-1793) founded by P. Rousseau, made Liège a propagandist centre for the philosophical party. In the same city was also first established *L'Esprit des journaux* (1772-1818), styled by Sainte-Beuve "cette considérable et excellente collection," but "journal voleur et compilateur." The *Journal historique et littéraire* (1788-1790) was founded at Luxembourg by the Jesuit De Feller; having been suppressed there, it was transferred to Liège, and subsequently to Maestricht. It is one of the most curious of the Belgian periodicals of the 18th century, and contains most precious materials for the national history. A complete set is very rare and much sought after. The *Revue belge* (1835-1843), in spite of the support of the best writers of the kingdom, as well as its successor the *Revue de Liège* (1844-1847), the *Trafalgar national* (1842-1843), published at Brussels, and the *Revue de Belgique* (1846-1851) were all short-lived. The *Revue de Bruxelles* (1837-1848), supported by the nobility and the clergy, had a longer career. The *Revue nationale* was the champion of Liberalism, and came to an end in 1847. The *Messenger des sciences historiques* (1833), at Ghent, was in repute on account of its historical and antiquarian character. The *Revue catholique*, the organ of the professors of the university of Louvain, began in 1846 a controversy with the *Journal historique et littéraire* of Kerstner (1834) upon the origin of human knowledge, which lasted for many years and excited great attention. The *Annales des travaux publics* (1843), the *Bulletin de l'industrie* (1842), the *Journal des beaux-arts* (1859), and the *Catholic Précis historiques* (1852), the *Protestant Chrétien belge* (1850), are other examples. The *Revue trimestrielle* was founded at Brussels by Van Bemmel in 1854. The *Athenæum belge* (1868) did not last long.

Among current periodicals in French are the following—Bibliography: *Bulletin bibliographique et pédagogique sur musée belge* (1897); *La Revue des bibliothèques et archives de Belgique* (1903); *Le Glaneur littéraire, musical et bibliographique* (1901); *Archives des arts et de la bibliographie de Belgique* (Tables 1833-1853 and 1875-1894). Philology and ecclesiastical history: *Revue neo-scholastique publiée par la société philosophique de Louvain* (1894); *Revue d'histoire ecclésiastique* (1900), the organ of the Catholic university of Louvain; *Revue théologique* (1884); *Annales pour servir à l'histoire ecclésiastique de la Belgique*, 2^e série (1881-1904) and 3^e série (1905); with an *Annexe* for Cartularies. Science: *Archives internationales de physiologie* (1902), published by Léon Fredericq; *La Cellule, recueil de cytologie et d'histologie générale* (1884); *La Museon* (1882); *Le Mouvement géographique* (1884); *Le Musée belge* (1897); *Revue chirurgicale belge et du nord de la France* (1901). *Annales des mines belgiques* appears quarterly, and *L'Art moderne* weekly at Brussels.

Among Flemish serials may be mentioned the *Nederlandsche Letteroefeningen* (1834); the *Belgisch Museum* (1836-1846), edited by Willems; the *Broederhand*, which did not appear after 1846; the *Taalverbond* of Antwerp; the *Kunst- en Letterbond* (1840-1843); and the *Vlaemsche Rederyker* (1844). Current Flemish periodicals include: *Onze kunst en letterde maandschrift voor beledende kunst* (1900); *Averbode's weekblad Godsdiens huisgezins moederlaal* (1907); *De Raadselbode* *tolk van den vlaemschen raadselzefhebber* (1901); *Rechtshandig tijdschrift voor vlaamsch België* (1901).

It has been calculated that in 1860 there were 51 periodicals, published in Belgium. In 1884 the number had increased to 412, and in 1908 to 1701.

See U. Capitaine, *Recherches sur les journaux et les écrits périodiques liégeois* (1850); *Recueil de tous les écrits périodiques qui se publient dans le royaume de Belgique* (1875); *Catalogue des journaux, revues, et publications périodiques de la Belgique* (1910); *Revue bibliographique belge*.

HOLLAND

The first serial written in Dutch was the *Boekhaal van Europa* (1692-1708, and 1715-1748), which had several changes of name

during its long life. The next of any note was the *Republikt der Galeerden* (1710-1748). The English *Spectator* was imitated by J. van Effon in his *Mitschrift* (1711-1712), written in French, and in the *Hollandsche Spectator* (1731-1735), in Dutch. An important serial was the long-lived *Vaderlandsche Letteroefeningen* (1761). The *Algemeene Kunst en Letterbode* (1788) was the leading review of Holland; in 1860 it was joined to the *Nederlandsch Spectator* (1855). Of those founded in the 19th century may be mentioned the *Recessant* (1803), and *Nieuws Reccensent*; the *Nederlandsch Museum* (1835); the *Tijdschrift* (1857); the *Tijdspiegel*, a literary journal of Protestant tendency; the *Theologisch Tijdschrift* (1867), the organ of the Leiden school of theology; and the *Dietsche Warande*, a Roman Catholic review devoted to the national antiquities. Colonial interests have been cared for by the *Tijdschrift voor nederlandische Indië* (1848). Current periodicals are *Hollandische revue*, monthly; *De Gids* (1837), monthly; *De nieuw Gids* (1886), monthly; *De Architect*, bi-monthly; *Cacilia* (for music); *Tijdschrift voor Strafrecht*; *Museum*, for philology (1893), monthly; *Tijdschrift voor nederlandse taal en letterkunde*; *Nederlandsch Archievenblad*; *De Paleograaf*; *Eiseviers geïllustreerd Maandschrift*, monthly; *Groot Nederland*, monthly.

DENMARK

Early in the 18th century Denmark had the *Nye Tidender* (1720), continued down to 1836 under the name of *Dansk-literaturlidende*. The *Minerva* (1785) of Rahbek was carried on to 1819, and the *Skandinavisk Museum* (1798-1803) was revived by the *Litteratur-Selskabs Skrifter* (1805). These were followed by the *Laerde Efterretninger* (1799-1810), afterwards styled *Litteratur-Tidende* (1811-1836), the *Athene* (1813-1817), and *Historisk Tidsskrift* (1840). In more modern times appeared *Tidsskrift for Litteratur og Kunst* (1833-1842, 1843); *Maanedsskrift for Litteratur* (1820-1838); *Nord og Syd* (1848-1849) of Goldschmidt, succeeded by *Ude og Hjemme*, and the *Dansk Maanedsskrift* (1858) of Steenstrup, with signed historical and literary articles. One of the most noteworthy Scandinavian periodicals has been the *Nordisk Universitets Tidsskrift* (1854-1864), a bond of union between the universities of Christiania, Upsala, Lund and Copenhagen. Current periodicals are: *Studier fra Sprog- og Oldtidsforskning* (1891), quarterly; *Danske Magazin*, yearly; *Nyi Tidsskrift for Mathematik*, monthly; *Theologisk Tidsskrift*, monthly; *Nationaløkonomisk Tidsskrift*, bi-monthly; *Dansk bogforlegelse*, bi-monthly for bibliography; *Athenaeum finsk*; *Tilskuere*, monthly; *Aarboger for Nordisk Oldkyndighed* (archaeology) quarterly.

Iceland has had the *Isensk Sagnabld* (1817-1826), *N9 Fjeldsvrit* (1841-1873), and *Gefn* (1870-1873). *Skirnir* (1831), which absorbed in 1905 *Tumari hins islenzka Bokmenntislags* (1880-1904), is still published.

NORWAY

The first trace of the serial form of publication to be found in Norway is in the *Ugentlige korte Ahandlinger* (1760-1761), "Weekly Short Treatises," of Bishop Fr. Nannestad, consisting of moral and theological essays. The *Maanedlige Ahandlinger* (1762), "Monthly Treatises," was supported by several writers and devoted chiefly to rural economy. These two were followed by *Politisk og Historie* (1807-1810); *Saga* (1816-1820), a quarterly review edited by J. S. Munch; *Den norske Tilskuer* (1817-1821), a miscellany brought out at Bergen; *Hermøder* (1821-1827), a weekly aesthetic journal; *Iduna*, (1822-1823), of the same kind but of less value; *Vidar* (1832-1834), a weekly scientific and literary review; *Nor* (1840-1846), of the same type; *Norsk Tidsskrift for Videnskab og Litteratur* (1847-1855); *Illustreret Nyhedsblad* (1851-1866), "Illustrated News"; *Norsk Maanedsskrift* (1856-1860), "Monthly Review for Norway," devoted to history and philology; and *Norden* (1866), a literary and scientific review. Popular serials date from the *Skilling Magazin* (1835), which first introduced wood-engraving. Representative current periodicals are: *Samtiden*, monthly; *Elektroteknisk tidsskrift*; *nordisk musik-revue*, fortnightly; *Naturen*; *Norsk hoveidende*, monthly; *Urd*; *Noregia*.

SWEDEN

The *Svenska Argus* (1735-1734) of Olof Dalin is the first contribution of Sweden to periodical literature. The next were the *Tidningar om den Lärdes Arbeten* (1742) and the *Lärda Tidningar*. The patriotic journalist C. C. Gjörwell established about twenty literary periodicals of which the most important was the *Svenska Mercurius* (1755-1789). Afterborn and some fellow-students founded about 1810 a society for the deliverance of the country from French pedantry, which with this end carried on a periodical entitled *Phosphoros* (1810-1813), to propagate the opinions of Schlegel and Schelling. The *Svensk Litteratur-Tidning* (1813-1825) of Palmblad and the *Polysem* (1810-1812) had the same objects. Among later periodicals we may mention *Skandia* (1833-1837); *Literaturladet* (1838-1840); *Ställningar och Förhållanden* (1838) of Crusenstolpe, a monthly review of Scandinavian history; *Tidsskrift for Litteratur* (1850); *Norsk Tidsskrift* (1852), weekly, *Förr och Nu*; and the *Revue suédoise* (1858) of Kramer, written in French. Among the monthlies which now appear are the following: *Social Tidsskrift*, *Nordisk Tidsskrift* and *Ord och Bild*.

SPAIN

Spain owes her intellectual emancipation to the monk Benito Feijóo, who in 1726 produced a volume of dissertations somewhat after the fashion of the *Spectator*, but on graver subjects, entitled *Teatro crítico*, which was continued down to 1739. His *Cartas eruditas* (1742-1760) were also issued periodically. The earliest critical serial, the *Diario de los literatos* (1737-1742), kept up at the expense of Philip V., did not long survive court favour. Other periodicals which appeared in the 18th century were Manier's *Mercurio* (1748); the *Diario noticioso* (1758-1781); *El Pensador* (1762-1767) of Joseph Clavijo y Fajardo; *El Belianso literario* (1765), satirical in character; the *Semanario erudito* (1778-1791), a clumsy collection of documents; *El Correo literario de la Europa* (1784-1788); *El Censor* (1781); the valuable *Memorial literario* (1784-1808); *El Correo literario* (1786-1791), devoted to literature and science; and the special organs *El Correo mercantil* (1792-1798) and *El Semanario de agricultura* (1797-1805). In the 19th century were *Varietades de ciencias, literatura, y artes* (1803-1805), among whose contributors have been the distinguished names of Quintana, Moratín and Antillon; *Miscelánea de comercio* (1819); and *Diario general de las ciencias medicas*. The Spanish refugees in London published *Ocios de españoles refugiados* (1823-1826) and *Miscelánea hispano-americana* (1824-1828), and at Paris *Miscelánea escolida americana* (1826). The *Crónica científica y literaria* (1817-1820) was afterwards transformed into a daily newspaper. Subsequently to the extinction of *El Censor* (1820-1823) there was nothing of any value until the *Cartas españolas* (1832), since known as the *Revista española* (1832-1836) and as the *Revista de Madrid* (1838). Upon the death of Ferdinand VII. periodicals had a new opening; in 1836 there were published sixteen journals devoted to science and art. The fashion of illustrated serials was introduced in the *Semanario pintoresco español* (1836-1857), noticeable for its biographies and descriptions of Spanish monuments. *El Panorama* (1839-1841) was another literary periodical with engravings. Of later date have been the *Revista ibérica* (1861-1863), conducted by Sanz del Río; *La America* (1857-1870), specially devoted to American subjects and edited by the brothers Asquerino; *Revista de Cataluña*, published at Barcelona; *Revista de España*; *Revista contemporánea*; *España moderna* (1880), and *Revista crítica* (1893). Current special periodicals are: *Ensal-encia, revista boscunegada* (1880, San Sebastián); *Monumenta historica socialistas Jesu* (1894); *El Progreso matemático* afterwards *Revista de matematicas puras y aplicadas* (1891); *Revista de bibliografía Catalana* (Catalunya, Balnear, Rosselló, Valencia, 1901); *La Naturaleza*, fortnightly; *La Energía eléctrica*, fortnightly; *Revista misra*, weekly; *Revista de medicina*, weekly; *Biografías españolas*, fortnightly; *La Lectura*; *España y America*, monthly.

See E. Hartzenbusch, *Periódicos de Madrid* (1876); Lapeyre, *Catalogo-tarifa de los periódicos, revistas, y ilustraciones en España* (1882); Georges le Gentil, *Les Revues littéraires de l'Espagne pendant les premiers mois du XIX. siècle* (Paris, 1909).

PORTUGAL

Portugal could long boast of only one review, the *Jornal enciclopédico* (1779-1806), which had many interruptions; then came the *Jornal de Coimbra* (1812-1820); the *Panorama* (1826-1857), founded by Herculano; the *Revista universal lisboense* (1841-1853), established by Castilho; and the *Instituto* (1853) of Coimbra; the *Archivo pittoresco* (1857) of Lisbon; and the *Jornal do sociedade dos amigos das letras*. In 1868 a review called *Voz feminina*, and conducted by women, was established at Lisbon. Current periodicals include: *O Archeologo portuguez* (1895); *Jornal de ciencias mathematicas et astronomicas* (1877); *Revista lusitana*, *Archivo de estudos philologicos et ethnologicos relativos á Portugal* (1887); *Ta-ssi-Yang-Kuo*, *Archivos e annaes do extremo orientis portuguez* (1899); *Portugal artistico*, fortnightly; *Revista militar*; *Arte musical*, fortnightly; *Boletim do agriculor*, monthly; *Archivo historico portuguez*, monthly.

GREECE

The periodical literature of modern Greece commences with 'O *Abvros* 'Ephos, brought out at Vienna in 1811 by Antimos Gazi and continued to 1821. In Aegina the *Atrvvaia* appeared in 1831, edited by Mustoxidis; and at Corfu, in Greek, Italian and English, the *'Avblovva* (1834). After the return of King Otho in 1833 a literary review called 'Ios was commenced. *Le Spectateur de l'Orient*, in French, pleaded the national cause before Europe for three years from 1853. A military journal was published at Athens in 1855, and two years later the archaeological periodical conducted by Pittakis and Rangabes. For many years *Harbotta* (1850-1872), edited by Rangabes and Paparrigopoulos, was the leading serial. *Evros* dealt with natural science, the *Γεωργικὴ* with agriculture, and *Ἱερατικὴ* with theology. *Ἐβδωμὴ περὶ κρητικῶν* (1831) and *Φιλολογικὴ ἀδελφότης Ἑλληνιστῶν* (1863) appear annually, and *Ἄδωνις* (1890) quarterly.

See A. R. Rangabé, *Hist. littéraire de la Grèce moderne* (Paris, 1879); R. Nicolai, *Geschichte der griechischen Literatur* (1876).

RUSSIA

The historian Gerhard Friedrich Müller made the first attempt to establish periodical literature in Russia in his *Večnyy yazychnyiy*,

Sotchineniya (1755-1764), or "Monthly Works." In 1759 Sumarokov founded the *Trudolybnaya Pchelka*, or "Industrious Bee," giving translations from the *Spectator*, and, for the first time, critical essays. Karamsin brought out in 1802 the *V'estnik Evropy*, an important review with Liberal tendencies. The Conservative *Russkoi V'estnik* (1808) was revived at Moscow in 1856 by Kattkov. The two last named are still published each month. The romantic school was supported by *Sin Otechestva* (1812). "Son of the Fatherland," united in 1825 to the *Svernoi Arkhiv* (1822), which dwindled and came to an end soon after 1830. One of the most successful Russian reviews has been the *Biblioteka dlya Tselniya* (1834) or "Library of Reading." The *Russkaya Missi*, "Russian Thought," published in Moscow, represented the Slavophil party. The following are some representative periodicals of the day: *Zurnal ministerstva narodnogo prosveteniya*, monthly; *Baltische Monatschrift* (1860), monthly; *V'estnik vospitaniya* (for education); *Mir iskusstva* (for fine art); *Russkoe bogalstvo* (for literature); *Russki arkhiv* (archives); *Mir Boji*, monthly; *Istorichesky v'estnik* (history); *Russkaya starina* (archaeology). In Finland *Svenska* (1841), written in Swedish, is still published.

OTHER COUNTRIES

Bohemia has the *Časopis musea království českého* (1827), quarterly, founded by Palacky; *Náše doba*, monthly; *Cechische Revue* (1907) quarterly. Hungary can show the *Ungarisches Magazin* (1781-1787, 1791), published at Pressburg, and the *Magyar Museum* (1788). The *Tudományos gyűjtemény* (1817-1841) and the *Figyelmző* (1837-1843) deserve mention. *Uj Magyar Museum* was a scientific magazine, and the *Budapesti Szemle* (1857) of a more general character. Among current Hungarian periodicals are: *Magyar Könyvszemle* (1876), and *Magyar Nyomatászat*. Before the revolution of 1830 Poland had the *Pamiętnik Warszawski* of Lach Szeyma. Among other Polish reviews may be mentioned the *Dziennik Literacki* of Lemberg; the *Biblioteka Warszawska* (1841), monthly; *Przegląd Polski* (1866), monthly; *Przewodnik naukowy i literacki* (1873), monthly; *Przewodnik bibliograficzny* (1878), monthly; *Przegląd penzechny* (1884), monthly. Rumania commenced with the *Magazin istorica pentru Dacia* (1845), containing valuable historical documents; and Moldavia with *Dacia Literaria* (1840) and *Arhiva Romanesca* (1841). Rumania now has the *Comorbiri literare* (1868), monthly, and *Romanul, revistă literară ilustrată săptămânală*. The best literary review Servia has had was the *Wila*, edited by Novakovic.

Japan now possesses native periodicals of the European type, of which the following are representative examples: *Fudzoku-Gako* (native customs); *The Kokka* (art); *Toyo-Gakugei-Zasshi* (science); *Jogoku-Zasshi* (domestic economy); *Taisyaku-Zasshi* (philosophy); *Keisai-Zasshi* (political economy); *Taiyo* (literature).

GENERAL INDEXES TO PERIODICALS.—The most complete collection of periodicals in all languages ever brought together is that preserved in the British Museum, and the excerpt from the printed catalogue of the library, entitled *Periodical Publications* (London, 1899-1900, 2nd ed. 6 parts folio, with index), includes journals, reviews, magazines and other works issued periodically, with the exception of transactions and proceedings of learned societies and of British and Colonial newspapers later than 1700. The titles of these periodicals, which number about 23,000, are arranged under the town or place of their publication.

The *Edinburgh and Quarterly Reviews*, the *Revue des deux mondes*, the *Revue historique*, *Deutsche Rundschau* and others issue from time to time general indexes of their contents, while the periodical literature of special departments of study and research are noted in the various *Jahresberichte* published in Germany, and indexed monthly in such English and American magazines as the *Engineering Magazine*, the *Geographical Journal*, *English Historical Review*, *American Historical Review*, *Economic Journal* (for political economy), *Library Journal* and *Library Association Record* (for bibliography), and the *Educational Review*. The *Cat. of Scientific Papers* (1800-1900) of the Royal Society (1867-1908), and the *Reperitorium der techn. Journ. Literatur* (1879-1899) of the German Patent Office, are specimens of indexes of special periodicals. There are also annual indexes such as those in the *Zoological Record* and *Annales de géographie*. Complete lists are given by A. B. Kroeger (*Guide to Reference Books*, 1908) and Stein (*Manuel de bibliographie générale*, 1897). See also *Bibliography of Books reviewed in American Periodicals*, by G. F. Daalorff (1902-1903); *Book Review Digest* (1906), &c.; H. C. Bolton's *Cat. of Scientific and Technical Periodicals 1665-1895*, Smithsonian Inst. (2nd ed., 1897); Harrison's *Int. Cat. of Scientific Lit.* (1903-1904); S. H. Scudder's *Cat. of Scientific Serials, 1633-1876* (Camb. [Harvard Univ.] 1876); *Cat. of Periodicals* (English and Foreign) in *Bod. Lib.*, 1878-1880; *Bibliothèque Nationale, Liste des périodiques étrangers* (1896). A useful select list, including all languages, is J. D. Brown's *Classified List of Current Periodicals* (1904). (H. R. T.)

PERIOECI (περιοεῖται, those who dwell around, in the neighbourhood), in ancient Laconia the class intermediate between the Spartan citizens and the serfs or helots (q.v.). Ephorus says (Strabo viii. 364 seq.) that they were the original Achaean inhabitants of the country, that for the first generation after

the Dorian invasion they shared in the franchise of the invaders, but that this was afterwards taken from them and they were reduced to a subject condition and forced to pay tribute. The term, however, came to denote not a nationality but a political status, and though the main body of the perioeci may have been Achaean in origin, yet they afterwards included Arcadians on the northern frontier of Laconia, Dorians, especially in Cythera and in Messenia, and Ionians in Cynuria. They inhabited a large number of settlements, varying in size from important towns like Gythium to insignificant hamlets (Isocrates xii. 179); the names of these, so far as they are known, have been collected by Clinton (*Fasti hellenici*, 2nd ed. i. 401 sqq.). They possessed personal freedom and some measure of communal independence, but were apparently under the immediate supervision of Spartan harmosts (governors) and subject to the general control of the ephors, though Isocrates is probably going too far in saying (xii. 181) that the ephors might put to death without trial as many of the perioeci as they pleased. Certain it is that they were excluded not merely from all Spartan offices of state, but even from the assembly, that they were absolutely subject to Spartan orders, and that, owing to the absence of any legal right of marriage (ἐγγαμία) the gulf between the two classes was impassable. They were also obliged to pay the "royal tribute," perhaps a rent for domain-land which they occupied, and to render military service. This last burden grew heavier as time went on; 5000 Spartiates and 5000 perioeci hoplites fought at Plataea in 479 B.C., but the steady decrease in the number of the Spartiates necessitated the increasing employment of the perioeci. Perioeci might serve as petty officers or even rise to divisional commands, especially in the fleet, but seemingly they were never set over Spartiates. Yet except at the beginning of the 4th century the perioeci were, so far as we can judge, fairly contented, and only two of their cities joined the insurgent helots in 464 B.C. (Thuc. i. 101). The reason of this was that, though the land which they cultivated was very unproductive, yet the prohibition which shut out every Spartiate from manufacture and commerce left the industry and trade of Laconia entirely in the hands of the perioeci. Unlike the Spartiates they might, and did, possess gold and silver and the iron and steel wares from the mines on Mt Taÿgetus, the shoes and woollen stufts of Amyclae, and the import and export trade of Laconia and Messenia probably enabled some at least of them to live in an ease and comfort unknown to their Spartan lords.

See G. Grote, *History of Greece*, pt. ii., ch. 6; C. O. Müller, *Dorians* (Eng. trans.), bk. iii., ch. 2; A. H. J. Greenidge, *Greek Constitutional History*, p. 78 sqq.; G. Gilbert, *Greek Constitutional Antiquities* (Eng. trans.) p. 35 sqq.; G. F. Schömann, *Antiquities of Greece* (Eng. trans.) p. 201 sqq.; G. Busolt, *Die griech. Staats- und Rechtsaltertümer*, § 84; *Griech. Geschichte*, i. 528 sqq. (2nd ed.); V. Thumser, *Lehrbuch der griech. Staatsaltertümer* (6th ed.), § 19; B. Niese, *Nachrichten von der wissenschaftlichen Gesellschaft zu Göttingen*, Phil.-Hist. Klasse, (1906), 101 sqq. (M. N. T.)

PERIPATETICS (from Gr. περιπατεῖν, to walk about), the name given in antiquity to the followers of Aristotle (q.v.), either from his habit of walking up and down as he lectured to his pupils, or from the περιπατος (covered walk) of the Lyceum. Aristotle's immediate successors, Theophrastus and Eudemus of Rhodes, were diligent scholars rather than original thinkers. They made no innovations upon the main doctrines of their master, and their industry is chiefly directed to supplementing his works in minor particulars. Thus they amplified Theophrastus the Aristotelian logic by the theory of the hypothesis, thetical and disjunctive syllogism, and added to the first figure of the categorical syllogism the five moods out of which the fourth figure was afterwards constructed. The impulse towards natural science and the systematizing of empirical details which distinguished Aristotle from Plato was shared by Theophrastus (q.v.). The same turn for detail is observable in his ethics, where, to judge from the imperfect evidence of the *Characters*, he elaborated still farther Aristotle's portraiture of the virtues

See Gellius, *Noct. Att.* xiii. 5, for the story of how Aristotle chose Theophrastus as his successor.

and their relative vices. In his doctrine of virtue the distinctive Peripatetic position regarding the importance of external goods was defended by him with emphasis against the assaults of the Stoics. He appears to have laid even more stress on this point than Aristotle himself, being doubtless led to do so, partly by the heat of controversy and partly by the importance which leisure and freedom from harassing cares naturally assumed to a man of his studious temperament. The metaphysical *dōxai* of Theophrastus which have come down to us show that he was fully alive to the difficulties that beset many of the Aristotelian definitions. But we are ignorant how he proposed to meet his own criticisms; and they do not appear to have suggested to him an actual departure from his master's doctrine, much less any radical transformation of it. In the difficulties which he raises we may perhaps detect a leaning towards a naturalistic interpretation. The tendency of Eudemus,

Eudemus of Rhodes.

on the other hand, is more towards the theological or Platonic side of Aristotle's philosophy. The *Eudemean Ethics* (which, with the possible exception of the three books common to this treatise and the *Nicomachean Ethics*, there need be no hesitation in ascribing to Eudemus) expressly identify Aristotle's ultimate ethical ideal of *theoria* with the knowledge and contemplation of God. And this supplies Eudemus with a standard for the determination of the mean by reason, which Aristotle demanded; but himself left vague. Whatever furthers us in our progress towards a knowledge of God is good; every hindrance is evil. The same spirit may be traced in the author of the chapters which appear as an appendix to book i. of Aristotle's *Metaphysics*. They have been attributed to Pasicles, the nephew of Eudemus. For the rest, Eudemus shows even less philosophical independence than Theophrastus. Among the Peripatetics of the first generation who had been personal disciples of Aristotle, the other chief names are those of Aristoxenus (*q.v.*) of Tarentum and Dicaearchus (*q.v.*) of Messene. Aristoxenus, who had formerly belonged to the Pythagorean school, maintained the position, already combated by Plato in the *Phaedo*, that the soul is to be regarded as nothing more than the harmony of the body. Dicaearchus agreed with his friend in this naturalistic rendering of the Aristotelian entelechy, and is recorded to have argued formally against the immortality of the soul.

The naturalistic tendency of the school reached its full expression in Strato of Lampsacus, the most independent, and probably the ablest, of the earlier Peripatetics. His system is based upon the formal denial of a transcendent deity. Cicero attributes to him the saying that he did not require the aid of the gods in the construction of the universe; in other words, he reduced the formation of the world to the operation of natural forces. We have evidence that he did not substitute an immanent world-soul for Aristotle's extra-mundane deity; he recognized nothing beyond natural necessity. He was at issue, however, with the atomistic materialism of Democritus in regard to its twin assumptions of absolute atoms and infinite space. His own speculations led him rather to lay stress on the qualitative aspect of the world. The true explanation of things was to be found, according to Strato, in the forces which produced their attributes, and he followed Aristotle in deducing all phenomena from the fundamental attributes or elements of heat and cold. His psychological doctrine explained all the functions of the soul as modes of motion, and denied any separation of the reason from the faculties of sense-perception. He appealed in this connexion to the statement of Aristotle that we are unable to think without a sense-image.

The successors of Strato in the headship of the Lyceum were Lyco, Arieto of Ceos, Critolaus (*q.v.*), Diodorus of Tyre, and Erymneus, who brings the philosophic succession down to about 100 B.C. Other Peripatetics belonging to this period are Hieronymus of Rhodes, Frytanis and Phormio of Ephesus, the *delirus senex* who attempted to instruct Hannibal in the art of war (Cic. *De orat.* ii. 18). Sotion, Herinippus and Sisyrtus were historians rather than philosophers. Heraclides Lembus,

Agatharchides and Antisthenes of Rhodes are names to us and nothing more. The fact is that, after Strato, the Peripatetic school has no thinker of any note for about 200 years.

Early in the 1st century B.C. all the philosophic schools began to be invaded by a spirit of eclecticism. This was partly due to the influence of the practical Roman spirit. This influence is illustrated by the proconsul Lucius Gellius Publicola (about 70 B.C.), who proposed to the representatives of the schools in Athens that he should help them to settle their differences (Cic. *De leg.* i. 20). This atmosphere of indifference imperceptibly influenced the attitude of the contending schools to one another, and we find various movements towards unity in the views of Boethus the Stoic, Parnethus and Antiochus of Ascalon, founder of the so-called "Fifth Academy." Meanwhile the Peripatetic school may be said to have taken a new departure and a new lease of life. The impulse was due to Andronicus of Rhodes. His critical edition of Aristotle indicated to the later Peripatetics the direction in which they could *Andronicus* profitably work, and the school devoted itself henceforth almost exclusively to the writing of commentaries on Aristotle, e.g. those of Boethus of Sidon, Arieto of Alexandria; Staseas, Cratippus, and Nicolaus of Damascus. The most interesting Peripatetic work of the period is the treatise *De mundo*, which is a good example within the Peripatetic school of the eclectic tendency which was then in the air. The admixture of Stoic elements is so great that some critics have attributed the work to a Stoic author; but the writer's Peripateticism seems to be the more fundamental constituent of his doctrine.

Our knowledge of the Peripatetic school during the first two centuries of the Christian era is very fragmentary; but those of its representatives of whom anything is known confined themselves entirely to commenting upon the different treatises of Aristotle. Thus Alexander of Aegae, the teacher of Nero, commented on the *Categories* and the *De caelo*. In the 2nd century Aspasius (*q.v.*) and Adrastus of Aphrodisias wrote numerous commentaries. The latter also treated of the order of the Aristotelian writings in a separate work. Somewhat later, Herminus, Achaicus and Sosigenes commented on the logical treatises. Aristocles of Messene, the teacher of Alexander of Aphrodisias, was the author of a complete critical history of Greek philosophy. This second phase of the activity of the school closes with the comprehensive labours of Alexander of Aphrodisias (Scholarach, c. 200), the exegete *par excellence*, called sometimes the second Aristotle. Alexander's interpretation proceeds throughout upon the naturalistic lines which have already become familiar to *Alexander of Aphrodisias* us. Aristotle had maintained that the individual alone is real, and had nevertheless asserted that the universal is the proper object of knowledge. Alexander seeks consistency by holding to the first position alone. The individual is prior to the universal, he says, not only "for us," but also in itself, and universals are abstractions which have merely a subjective existence in the intelligence which abstracts them. Even the deity must be brought under the conception of individual substance. Such an interpretation enables us to understand how it was possible, at a later date, for Aristotle to be regarded as the father of Nominalism. Form, Alexander proceeds, is everywhere indivisible from matter. Hence the soul is inseparable from the body whose soul or form it is. Reason or intellect is bound up with the other faculties. Alexander's commentaries formed the foundation of the Arabian and Scholastic study of Aristotle. Soon after Alexander's death, the Peripatetic school was merged, like all others, in Neoplatonism (*q.v.*).

PERIPATUS, a genus of animals belonging to the air-breathing division of the phylum Arthropoda. It differs, however, from all other Arthropoda in such important respects that a special class, equivalent in rank to the old-established Arthropod classes, had been created for its sole occupancy. This class has been named the Prototracheata or Onychophora (see ARTHROPODA), and may be most appropriately placed in the system in the

neighbourhood of the Myriapoda, though it must not be forgotten that it differs from the Myriapoda more than the Myriapoda differ from other Arthropoda, and that in some respects it presents features which recall the segmented worms (Annelida). The genus has a wide distribution (see below), but it has not been found in Europe or in North America. There is but little variety of structure in the genus, and the species are limited in number. They live beneath the bark of trees, in the crevices of rock and of rotten stumps of trees, and beneath stones. They require a moist atmosphere, and are exceedingly susceptible to drought. They avoid light, and are therefore rarely seen. They move slowly, picking their course by means of their antennae. When irritated they eject with considerable force the contents of their slime reservoirs by means of the sudden contraction of the muscular body-wall. The slime, which appears to be harmless, is extremely sticky, but it easily comes away from the skin of the animal itself. Locomotion is effected by means of the legs, with the body fully extended. Hutton describes his specimens as sucking the juices of flies, which they had stuck down with their slime, and they have been observed in captivity to devour the entrails which have been removed from their fellows, and to eat raw sheep's liver. They move their mouths in a suction manner, tearing the food with their jaws. They have the power of extruding their jaws from the mouth, and of working them alternately backwards and forwards. They are viviparous; the young are fully formed at birth, and differ from the adult only in size and colour. The mother does not appear to pay any special attention to her offspring, which wander away and get their own living. It has lately been stated that some of the Australian species are normally oviparous, but this has not been fully proved. Sexual differences are not strongly marked, and are sometimes absent. There does not appear to be any true copulation. In some species the male deposits small oval spermatophores indiscriminately on any part of the body of the female. It seems probable that in such cases the spermatozoa make their way from the adherent spermatophore through the body-wall into the body, and so by traversing the tissues reach the ovary. In other species which possess *receptacula seminis* it is probable that fertilization is effected once only in early life before any ova pass into the uterus.

External Features.—The anterior part of the body may be called the head, though it is not sharply marked off from the rest of the body (fig. 1). The head carries three pairs of appendages, a pair of simple eyes, and a ventrally placed mouth. The body is elongated and vermiform; it bears a number of paired appendages, each terminating in a pair of claws, and all very much alike. The number varies in the different species. The anus is always at the

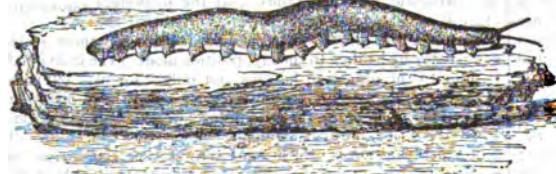

(After Sedgwick.)

FIG. 1.—*Peripatus capensis*, drawn from life. Life size.

posterior end of the body, and the generative opening is on the ventral surface, just in front of the anus; it may be between the legs of the penultimate pair, or between the legs of the last pair, or it may be subterminal. The colour varies considerably in the different species, and even in different individuals of the same species. The skin has a velvety appearance, and is thrown into a number of transverse ridges, along which wart-like papillae are placed. These papillae, which are found everywhere, are the primary papillae; they are covered with small, scale-like projections called secondary papillae, and are specially developed on the dorsal surface, less so on the ventral. Each papilla carries at its extremity a well-marked spine. Among the primary papillae smaller accessory papillae are sometimes present.

The appendages of the head are the antennae, the jaws and the oral papillae. The mouth is at the hinder end of a depression

called the buccal cavity, and is surrounded by an annular tannid lip, raised into papilliform ridges and bearing a few spines (fig. 2). Within the buccal cavity are the two jaws. They are short, stump-like, muscular structures, armed at their free extremities by a pair of cutting blades or claws, and are placed one on each side of the mouth. In the median lino of the buccal cavity in front is placed a thick muscular protuberance, which may be called the tongue, though attached to the dorsal instead of to the ventral wall of the mouth (fig. 2). The tongue

bears a row of small, chitinous teeth. The jaw-claws (figs. 3 and 4), which resemble in all essential points the claws borne by the feet, and like these, are thickenings of the cuticle, are sickle-shaped. They have their convex edge directed forwards, and their concave, or cutting edge, turned backwards. The inner cutting plate (fig. 3) usually bears a number of cutting teeth. The oral papillae are placed at the sides of the head (fig. 2). The ducts of the slime-glands open at their free end. They possess two main rings of projecting tissue, and their extremities bear papillae irregularly arranged. The ambulatory appendages vary in number. There are seventeen pairs in *P. capensis* and eighteen in *P. balfouri*, while in *P. jamaicensis* the number varies from twenty-nine to forty-three. They consist of two main divisions, which we may call the leg and the foot (fig. 5). The leg (l) has the form of a truncated cone, the broad end of which is attached to

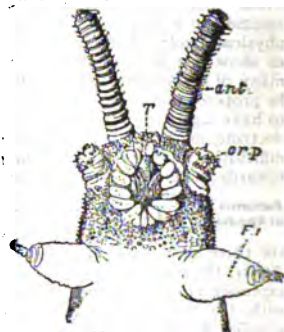

(After Sedgwick.)

FIG. 2.—Ventral view of the head of *P. capensis*.

ant, Antennae; or.p., Oral papillae; F.1, First leg; T, Tongue.

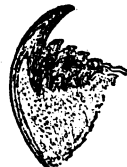

(After Balfour.)

FIG. 3.—Inner jaw-claw of *P. capensis*.



(After Balfour.)

FIG. 4.—Outer jaw-claw of *P. capensis*.

the ventro-lateral wall of the body, of which it is a prolongation. It is marked by a number of rings of papillae placed transversely to its long axis, the dorsal of which are pigmented like the dorsal surface of the body, and the ventral like the ventral surface. At the narrow distal end of the leg there are on the ventral surface three or

four (rarely five) spiniferous pads, each of which is continued dorsally into a row of papillae. The foot is attached to the distal end of the leg. It is slightly narrower at its attached extremity than at its free end. It bears two sickle-shaped claws, and at its distal end three (rarely four) papillae. The part of the foot which carries the claws is especially retractile, and is generally found more or less telescoped into the proximal part. The legs of

the fourth and fifth pairs differ from the others in the fact that the third pad (counting from the distal end of the leg) carries the opening of the enlarged nephridia of these segments. In some species certain of the legs bear on their ventral sides furrows with tumid lips and lined by smooth non-tuberculate epithelium; they are called coxal organs, and it appears that they can be everted. The males are generally rather smaller and less numerous than the females. In those species in which the number of legs varies the male has a smaller number of legs than the female.



(After Sedgwick.)

FIG. 5.—Ventral view of the leg of a male *P. capensis*.

f, Foot; l, leg; p, spiniferous pads. The white papilla of the proximal part of this leg is characteristic of this species.

Breeding.—As already stated, *Peripatus* is viviparous. The Australasian species come nearest to laying eggs, inasmuch as the eggs are large, full of yolk, and enclosed in a shell; but development normally takes place in the uterus, though abnormally, incompletely developed eggs are extruded. The uterus always contains several young, which are usually at different stages of development and are born at different times of the year. In most of the African species, however, the embryos of the uterus are almost of the same age and are born at a definite season. The young of *P. capensis* are born in April and May. They are almost colourless at birth, excepting the antennae, which are green, and their length is 10 to 15 mm. A large female will produce thirty to forty young in one year. The period of gestation is thirteen months, that is to say, the ova pass into the oviducts about one month before the young of the preceding year are born.

Alimentary.—The alimentary canal (fig. 6). The buccal cavity, as explained above, is a secondary formation around the true mouth, which is at its dorsal posterior end. It contains the tongue and the jaws, which have already been described, and into the hind end of it there open ventrally by a median opening the salivary glands. The mouth leads into a muscular pharynx, which is connected by a short oesophagus with the stomach. The stomach forms by far the largest part of the alimentary canal. It is a dilated soft-walled tube, and leads behind into the short narrow rectum, which opens at the anus.

There are no glands opening into the alimentary canal. The central nervous system, the anterior part of which is shown in fig. 7, is of the "rope-ladder" type, and the ventral cords meet over the rectum. The cuticle is a thin layer, of which the spines, jaws and claws are special developments. Its surface is not, however, smooth, but is everywhere, with the exception of the perioral region, raised into minute secondary

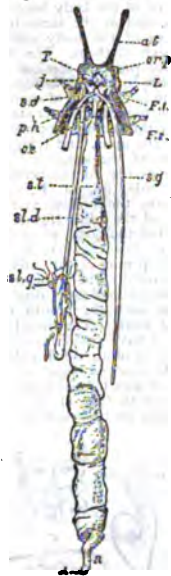

(After Ballour.)

FIG. 6.—*Peripatus capensis* dissected so as to show the alimentary canal, slime glands and salivary glands. The dissection is viewed from the ventral side, and the lips (*L*) have been cut through in the middle line behind and pulled outwards so as to expose the jaws (*J*), which have been turned outwards, and the tongue (*T*) bearing a median row of chitinous teeth, which branches behind into two. The muscular pharynx, extending back into the space between the first and second pairs of legs, is followed by a short tubular oesophagus. The latter opens into the large stomach with plicated walls, extending almost to the hind end of the animal. The stomach at its point of junction with the rectum presents an S-shaped ventro-dorsal curve.

A., Anus; *al.*, antenna; *F.1*, *F.2*, first and second feet; *j.*, jaws; *L*, lips; *os.*, oesophagus; *or.p.*, oral papilla; *ph.*, pharynx; *R*, rectum; *s.d.*, salivary duct; *s.g.*, salivary gland; *s.l.*, slime reservoir; *s.l.g.*, portion of tubules of slime gland; *st.*, stomach; *T*, tongue in roof of mouth.

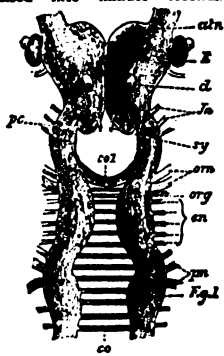

(After Ballour.)

FIG. 7.—Brain and anterior part of the ventral nerve-cords of *Peripatus capensis* enlarged and viewed from the ventral surface.

antn., Antennary nerves; *co.*, commissures between ventral cords; *d.*, ventral appendages of brain; *E.*, eye; *en.*, nerves passing outwards from ventral cord; *F.g.1*, ganglionic enlargements from which nerves to feet pass off; *jn.*, nerves to feet; *Jo.*, ganglionic enlargement from which nerves to oral papillae pass off; *orn.*, nerves to oral papillae; *os.*, posterior lobe of brain; *pn.*, nerves to feet; *sy.*, symmetrical nerves.

papillae, which in most instances bear at their free extremity a somewhat prominent spine. The epidermis, placed immediately within the cuticle, is composed of a single row of cells. The pigment which gives the characteristic colour to the skin is deposited in the protoplasm of the outer ends of the cells in the form of small granules. Beneath the epidermis is a thin cutis, which is followed by the muscular layers (external circular and internal longitudinal). The muscular fibres of the jaws are transversely striated, the other muscles are unstriated.

The apertures of the tracheal system are placed in the depressions between the papillae or ridges of the skin. Each of them leads into a tube, which may be called the tracheal pit (fig. 8); the walls



(After Ballour.)

FIG. 8.—Section through a tracheal pit and diverging bundles of tracheal tubes taken transversely to the long axis of the body. *tr.*, Tracheae, showing rudimentary spiral fibre; *tr.a.*, Cells resembling those lining the tracheal pits, which occur at intervals along the course of the tracheae; *tr.o.*, Tracheal stigma; *tr.p.*, Tracheal pit. Of this are formed of epithelial cells, bounded towards the lumen of the pit by a very delicate cuticular membrane continuous with the cuticle covering the surface of the body. Internally it expands in the transverse plane, and from the expanded portion the tracheal tubes arise in diverging bundles. The tracheae are minute tubes exhibiting a faint transverse striation which is probably the indication of a spiral fibre. They appear to branch, but only exceptionally. The tracheal apertures are diffused over the surface of the body, but are especially developed in certain regions.

The vascular system consists of a dorsal tubular heart with paired ostia leading into it from the pericardium, of the pericardium, and the various other divisions of the perivisceral cavity (fig. 12, D). As in all Arthropoda, the perivisceral cavity is a haemocoel, *i.e.* contains blood, and forms part of the vascular system. It is divided by septa into chambers (fig. 12, D), of which the most important are the central chamber containing the alimentary canal and the dorsal chamber or pericardium. Nephridia are present in all the legs. In all of them (except the first three) the following parts may be recognized (fig. 9): (1) a vesicular portion

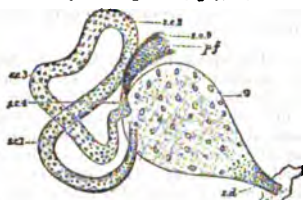

FIG. 9.—Nephridium from the ninth pair of legs of *P. capensis*.

o.s., External opening of segmental organ. *s.c.1*, *s.c.2*, *s.c.3*, *s.c.4*, Successive regions of coiled portion of nephridium. *p.f.*, Internal opening of nephridium into the body cavity (lateral compartment). *s.o.f.*, Third portion of nephridium broken off at *p.f.* from the internal vesicle, which is not shown. *v.*, Vesicle of segmental organ.

(1) opening to the exterior on the ventral surface of the legs by a narrow passage (*s.d.*); (2) a coiled portion, which is again subdivided into several sections (*s.c.*); (3) a section with closely-packed nuclei ending by a somewhat enlarged opening (*p.f.*); (4) the terminal portion, which consists of a thin-walled vesicle. The nephridia of the first three pairs of legs are smaller than the rest, consisting only of a vesicle and duct. The fourth and fifth pairs are larger than those behind, and are in other respects peculiar; for instance, they open on the third pad (counting from the distal end of the

leg), and the external vesicular portion is not dilated. The external opening of the other nephridia is placed at the outer end of a transverse groove at the base of the legs. The salivary glands are the modified nephridia of the segment of the oral papillae.

The male generative organs (fig. 10) consist of a pair of testes (te), a pair of seminal vesicles (v), vasa deferentia (v.d.), and accessory glandular tubules (f). All the above parts lie in the central

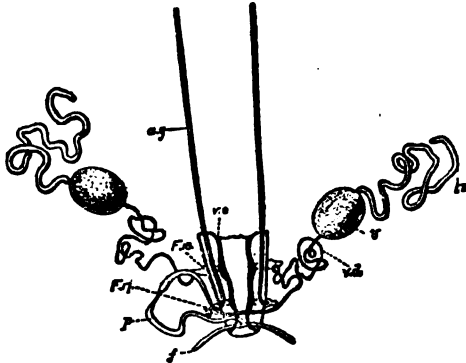

(After Balfour.)

FIG. 10.—Male Generative Organs of *Peripatus capensis*. Dorsal view.

a.g. Enlarged crural glands of last pair of legs. f. Small accessory glandular tubules. F. 16, 17, Last pair of legs. p. Common duct into which vasa deferentia open. te. Testes. v. Seminal vesicles. v.d. Vas deferens.

compartment of the body cavity. The ovaries consist of a pair of tubes closely applied together, and continued posteriorly into the oviducts. Each oviduct, after a short course, becomes dilated into the uterus. The two uteri join behind and open to the exterior by a median opening. The ovaries always contain spermatozoa, some of which project through the ovarian wall into the body cavity. Spermatozoa are not found in the uterus and oviducts, and it appears probable, as we have said, that they reach the ovary directly by boring through the skin and traversing the body cavity. In all the species except the African species there is a globular receptaculum seminis opening by two short ducts close together into the oviduct, and in the neotropical species there is in addition a small receptaculum ovorum, with extremely thin walls, opening into the oviduct by a short duct just in front of the receptaculum seminis. The epithelium of the latter structure is clothed with actively moving cilia. There appear to be present in most, if not all, of the legs some accessory glandular structures opening just externally to the nephridia. They are called the crural glands.

Development.—*Peripatus* is found in Africa, in Australasia, in South America and the West Indies, in New Britain, and in the Malay Peninsula and Sumatra. The species found in these various localities are closely similar in their anatomical characters, the principal differences relating to the structure of the female generative organs and to the number of the legs. They, however, differ in the most striking manner in the structure of the ovum and the early development. In all the Australasian species the egg is large and heavily charged with food-yolk, and is surrounded by a tough membrane. In the Cape species the eggs are smaller, though still of considerable size; the yolk is much less developed, and the egg membrane is thinner though dense. In the New Britain species the egg is still smaller (.1 mm.), and there is a large trophic vesicle. In the neotropical species the egg is minute, and almost entirely devoid of yolk. The unsegmented uterine ovum of *P. novae zealandiae* measures 1.5 mm. in length by .8 mm. in breadth; that of *P. capensis* is .56 mm. in length; and that of *P. trinidadensis* .04 mm. in diameter. In correspondence with these differences in the ovum there are differences in the early development, though the later stages are closely similar.

The development has been worked out in *P. capensis*, to which species the following description refers. The segmentation is peculiar, and leads to the formation of a solid gastrula, consisting of a cortex of ectoderm nuclei surrounding a central endodermal mass, which is exposed at one point—the blastopore. The enteron arises as a space in the endoderm, and an opacity—the primitive streak—appears at the hind end of the blastopore (fig. 11, B). The elongation of the embryo is accompanied by an elongation of the blastopore, which soon becomes dumb-bell shaped (fig. 11, C). At the same time the mesoblastic somites (embryonic segments of mesoderm) make their appearance in pairs at the hind end, and gradually travel forwards on each side of the blastopore to the front end, where the somites of the anterior pair soon meet in front of the blastopore (fig. 11, D). Meanwhile the narrow middle part of the blastopore has closed by a fusion of its lips, so that the blastopore is represented by two openings, the future mouth and anus. A primitive groove makes its appearance behind the blastopore (fig. 11, D). At this stage the hind end of the body becomes curved ventrally into a spiral (fig. 11, E), and at the same time the appendages appear as hollow processes of the body-wall, a mesoblastic somite being prolonged into each of them. The first to appear are the antennae, into which the praecoral somites are prolonged. The remainder appear from before backwards in regular order, viz. jaw, oral papillae, legs 1-17. The full number of somites and their appendages is not, however, completed until a later stage. The nervous system is formed as an annular thickening of ectoderm passing in front of the mouth and behind the anus, and lying on each side of the blastopore along the lines of the somites. The praecoral part of this thickening, which gives rise to the cerebral ganglia, becomes pitted inwards on each side (fig. 11, F, c.g.). These pits are eventually closed, and form the hollow ventral appendages of the suprapharyngeal ganglia of the adult (fig. 7, d). The lips are formed as folds of the side wall of the body, extending from the praecoral lobes to just behind the jaw (fig. 11, F, l). They enclose the jaws (j), mouth (M), and opening of the salivary glands (o.s.), and so give rise to the buccal cavity. The embryo has now lost its spiral curvature, and becomes completely doubled upon itself, the hind end being in contact with the mouth (fig. 11, C). It remains in this position until birth. The just-born young are from 10 to 15 mm. in length, and have green antennae, but the rest of the body is either quite white or of a reddish colour. This red colour differs from the colour of the adult in being soluble in spirit. The mesoblastic somites are paired sacs formed from the anterior lateral portions of the primitive streak (fig. 11, C). As they are formed they become placed in pairs on each side of the

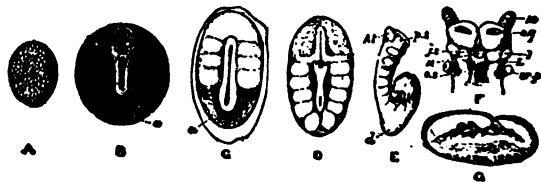

(After Sedgwick.)

FIG. 11.—A Series of Embryos of *P. capensis*. The hind end of embryos B, C, D is uppermost in the figures, the primitive streak is the white patch behind the blastopore.

- A, Gastrula stage, ventral view, showing blastopore.
 B, Older gastrula stage, ventral view, showing elongated blastopore and primitive streak.
 C, Ventral view of embryo with three pairs of mesoblastic somites, dumb-bell shaped blastopore and primitive streak.
 D, Ventral view of embryo, in which the blastopore has completely closed in its middle portion. The anterior pair of somites have moved to the front end of the body.
 E, side view of later embryo. A, Antenna; d, dorsal projection; p.s., praecoral somite.
 F, Ventral view of head of embryo, intermediate between E and G. A, Antennae; c.g. cerebral groove; j, jaws; j.s. swelling at base of jaws; L, lips; M, mouth; o.p., oral papillae; o.s., opening of salivary gland.
 G, side view of older embryo.

blastopore. The somites of the first pair eventually obtain a position entirely in front of the blastopore (Fig. 11, D). They form the somites of the praecoral lobes. The full complement of somites is acquired at about the stage of fig. 11, E. The relations of the mesoblastic somites are shown in fig. 12, A, which represents a transverse section taken between the mouth and anus of an embryo of the stage of fig. 11, D. The history of these somites is an exceedingly interesting one, and may be described shortly as follows: They divide into two parts—a ventral part which extends into the appendage, and a dorsal part (fig. 12, B). Each of the ventral parts acquires an opening to the exterior, just outside the nerve-cord,

and becomes entirely transformed into a nephridium (fig. 12, D, 2'). The dorsal part shifts dorsally and diminishes relatively in size (fig. 12, C). Its fate differs in the different parts of the body. In the anterior somites it dwindles and disappears, but in the posterior part it unites with the dorsal divisions of contiguous somites of the same side, and forms a tube—the generative tube (fig. 12, D, 2). The last section of this tube retains its connection with the ventral portion of the somite, and so acquires an external opening, which is at first lateral, but soon shifts to the middle line, and fuses with its fellow, to form the single generative opening. The praesoral somite develops the rudiment of a nephridium, but eventually entirely disappears. The jaw somite also disappears; the oral papilla somite forms ventrally the salivary glands, which are thus serially homologous with nephridia. The various divisions of the perivisceral cavity develop as a series of

though not characteristic of all the classes of the Arthropoda, are found nowhere outside that group, and constitute a very important additional reason for uniting *Peripatus* with it. *Peripatus*, though indubitably an Arthropod, differs in such important respects from all the old-established Arthropod classes, that a special class, equivalent in rank to the others, and called Prototracheata or Onychophora, has had, as we have seen, to be created for its sole occupancy. This unlikeness to other Arthropoda is mainly due to the Annelidan affinities which it presents, but in part to the presence of the following peculiar features: (1) the number and diffusion of the tracheal apertures; (2) the restriction of the jaws to a single pair; (3) the disposition of the generative organs; (4) the texture of the skin; and (5) the simplicity and similarity of all the segments of the body behind the head. The Annelidan affinities are superficially indicated in so marked a manner by the thinness of the cuticle, the dermo-muscular body-wall, the hollow appendages, that, as already stated, many of the earlier zoologists who examined *Peripatus* placed it among the segmented worms; and the discovery that there is some solid morphological basis for this determination constitutes one of the most interesting points of the recent work on the genus. The Annelidan features are: (1) the paired nephridia in every segment of the body behind the first two (Saenger, Ballour); (2) the presence of cilia in the generative tracts (Gaffron). It is true that neither of these features is absolutely distinctive of the Annelida, but when taken in conjunction with the Annelidan disposition of the chief systems of organs, viz. the central nervous system, and the main vascular trunk or heart, they may be considered as indicating affinities in that direction.

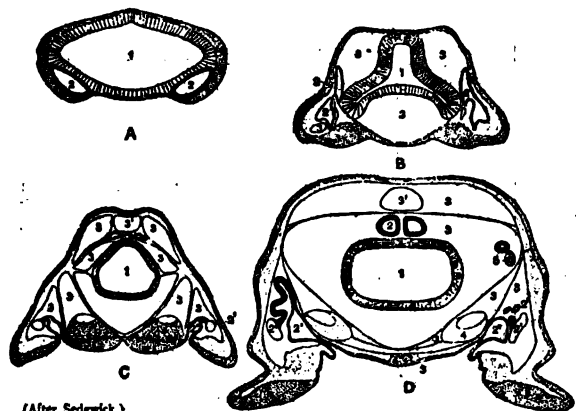

(After Sedgwick.)
FIG. 12.—A series of diagrams of transverse sections through *Peripatus* embryos to show the relations of the coelom at successive stages.

- A, Early stage; no trace of the vascular space; endoderm and ectoderm in contact.
B, Endoderm has separated from the dorsal and ventral ectoderm. The somite is represented as having divided on the left side into a dorsal and ventral portion.
C, The haemocoel (3) has become divided up into a number of spaces, the arrangement of which is unimportant. The dorsal part of the somite has travelled dorsally, and now constitutes a small space (triangular in section) just dorsal to the gut. The ventral portion (2) has assumed a tubular character, and has acquired an external opening. The internal vesicle is already indicated, and is shown in the diagram by the thinner black line: 1, gut; 2, somite; 2', nephridial part of coelom; 3, haemocoel; 3', part of haemocoel which will form the heart—the part of the haemocoel on each side of this will form the pericardium; 4, nerve-cord; 4, slime glands.
D represents the conditions at the time of birth. The coelom is represented as surrounded by a thick black line, except in the part which forms the internal vesicle of the nephridium.

spaces between the ectoderm and endoderm, and later in the mesoderm. The mesoderm seems to be formed entirely from the proliferation of the cells of the mesoblastic somites. It thus appears that in *Peripatus* the coelom does not develop a perivisceral portion, but gives rise only to the renal and reproductive organs.

The genus *Peripatus* was established in 1826 by L. Guilding, who first obtained specimens of it from St. Vincent in the Antilles. He regarded it as a mollusc, being no doubt deceived by the slug-like appearance given by the antennae. Specimens were subsequently obtained from other parts of the neotropical region, and from South Africa and Australia, and the animal was variously assigned by the zoologists of the day to the Annelida and Myriapoda. Its true place in the system, as a primitive member of the group Arthropoda, was first established in 1874 by H. N. Moseley, who discovered the tracheae. *Peripatus* is an Arthropod, as shown by (1) the presence of appendages modified as jaws; (2) the presence of paired lateral ostia perforating the wall of heart and putting its cavity in communication with the pericardium; (3) the presence of a vascular body cavity and pericardium (haemocoelic body cavity); (4) absence of a perivisceral section of the coelom. Finally, the tracheae,

SYNOPSIS OF SPECIES.

PERIPATUS (Guilding).—Soft-bodied vermiform animals, with one pair of ringed antennae, one pair of jaws, one pair of oral papillae, and a varying number of claw-bearing ambulatory legs. Dorsal surface arched and more darkly pigmented than the flat ventral surface. Skin transversely ridged and beset by wart-like spiniferous papillae. Mouth anterior, ventral; anus posterior, terminal. Generative opening single, median, ventral and posterior. One pair of simple eyes. Brain large, with two ventral hollow appendages; ventral cords widely divaricated, without distinct ganglia. Alimentary canal simple, uncoiled. Segmentally arranged paired nephridia are present. Body cavity is continuous with the vascular system, and does not communicate with the paired nephridia. Heart tubular, with paired ostia. Respiration by means of tracheae. Dioecious; males smaller and generally less numerous than females. Generative glands tubular, continuous with the ducts. Viviparous. Young born fully developed. Distribution: Africa (Cape Colony, Natal, and the Gaboon), New Zealand, Australia and Tasmania, New Britain, South and Central America and the West Indies, the Malay Peninsula [and in Sumatra?].

The genus *Peripatus*, so far as adult conformation is concerned, is a very homogeneous one. It is true, as was pointed out by Sedgwick, that the species from the same part of the world resemble one another more closely than they do species from other regions, but recent researches have shown that the line between them cannot be so sharply drawn as was at first supposed, and it is certainly not desirable in the present state of our knowledge to divide them into generic or subgeneric groups, as has been done by some zoologists. (The following genera have been proposed: *Peripatus* for the neotropical species, *Peripatoides* for the Australasian, *Peripatopsis* and *Opishopatus* for the African, *Paraperipatus* for the New Britain, *Eoperipatus* for the Malayan species, and *Ooperipatus* for the supposed oviparous species of Australia and New Zealand.) The colour is highly variable in species from all regions; it is perhaps more constant in the species from the neotropical region than in those from elsewhere. The number of legs tends to be variable whenever it exceeds 19 praegenital pairs; when the number is less than that it is usually, though not always, constant. More constant points of difference are the form of the jaws, the position of the generative orifice, the presence of a receptaculum seminis and a receptaculum ovorum, the arrangement of the primary papillae on the distal end of the feet, and above all the early development.

South African Species.—With three spinous pads on the legs,

and feet with two primary papillae on the anterior side and one on the posterior side; outer jaw with one minor tooth at the base of the main tooth, inner jaw with no interval between the large tooth and the series of small ones; last fully developed leg of the male with enlarged crural gland opening on a large papilla placed on its ventral surface; coxal organs absent; the nephridial openings of the 4th and 5th pairs of legs are placed in the proximal spinous pad. Genital opening subterminal, behind the last pair of fully developed legs; oviduct without receptacula seminis or receptacula ovorum; the terminal unpaired portion of vas deferens short. Ova of considerable size, but with only a small quantity of yolk. The embryos in the uterus are all nearly of the same age, except for a month or two before birth, when two broods overlap.

The following species are aberrant in respect of these characters: *Peripatus (Opisthopatus) cinctipes*, Purcell (Cape Colony and Natal), presents a few Australasian features; there is a small receptaculum seminis on each oviduct, some of the legs are provided with well-developed coxal organs, the feet have one anterior, one posterior and one dorsal papilla, and the successive differences in the ages of the embryos in the uterus, though nothing like that found in the neotropical species, is slightly greater than that found in other investigated African species. Several pairs of legs in the middle region of the body are provided with enlarged crural glands which open on a large papilla. Male with four accessory glands, opening on each side of and behind the genital aperture. *P. tholloni*, Bouvier, (Equatorial West Africa [Gaboon]), shows some neotropical features; there are 24 to 25 pairs of legs, the genital opening is between the penultimate legs, and though there are only three spinous pads the nephridial openings of the 4th and 5th legs are proximal to the 3rd pad, coxal organs are present, and the jaws are of the neotropical type; the oviducts have receptacula seminis. The following South African species may be mentioned: *P. capensis* (Grube), with 17 (rarely 18) pairs of claw-bearing legs; *P. balfouri* (Sedgw.) with 18 (rarely 19) pairs; *P. moseleyi* (Wood-M.), with 20 to 24 pairs.

Australasian Species.—With 14, 15 or 16 pairs of claw-bearing ambulatory legs, with three spinous pads on the legs, and nephridial opening of the 4th and 5th legs on the proximal pad; feet with one anterior, one posterior and one dorsal primary papilla; inner jaw without diastema, outer with or without a minor tooth. Last leg of the male with or without a large white papilla on its ventral surface for the opening of a gland, and marked papillae for the crural glands are sometimes present on other legs of the male; well-developed coxal glands absent. Genital opening between the legs of the last pair; oviducts with receptacula seminis, without receptacula ovorum; the terminal portion of the vas deferens long and complicated; the accessory male glands open between the genital aperture and the anus, near the latter. Ova large and heavily charged with yolk, and provided with a stout shell. The uterus appears to contain embryos of different ages. Specimens are recorded from West Australia, Queensland, New South Wales, Victoria and New Zealand. The Australasian species are in some confusion. The number of claw-bearing legs varies from 14 to 16 pairs, but the number most often found is 15. Whether the number varies in the same species is not clear. There appears to be evidence that some species are occasionally or normally oviparous, and in the supposed oviparous species the oviduct opens at the end of a papilla called from its supposed function an ovipositor, but the oviparity has not yet been certainly proved as a normal occurrence. Among the species described may be mentioned *P. leuckarti* (Saenger), *P. insignis* (Dendy), *P. oviparus* (Dendy), *P. viridimaculatus* (Dendy), *P. novae zealandiae* (Hutton), but it is by no means certain that future research will maintain these. Mr J. J. Fletcher indeed is of opinion that the Australian forms are all varieties of one species, *P. leuckarti*.

Neotropical Species.—With three to five spinous pads on the legs, nephridial opening of the 4th and 5th legs usually proximal to the 3rd pad, and feet either with two primary papillae on the anterior side and one on the posterior, or with two on the anterior and two on the posterior; outer jaw with small minor tooth or teeth at the base of the main tooth, inner jaw with diastema. A variable number of posterior legs of the males anterior to the genital opening with one or two large papillae carrying the openings of the crural glands; well-developed coxal organs present on most of the legs. The primary papillae usually divided into two portions. Genital opening between the legs of the penultimate pair; oviduct provided with receptacula seminis and ovorum; unpaired part of vas deferens long and complicated; accessory organs of male opening at the sides of the anus. Ova minute, with little food-yolk; embryos in the uterus at very different stages of development. The number of legs usually if not always variable in the same species; the usual number is 28 to 32 pairs, but in some species 40 to 43 pairs are found. The neotropical species appear to fall into two groups: (1) the so-called Andean species, viz. those which inhabit the high plateaus or Pacific slope of the Andes; in these there are 4 (sometimes 5) pedal papillae, and the nephridial openings of the 4th and 5th legs are on the third pad; and (2) the Caribbean species, viz. the remaining neotropical species, in which there are 3 papillae on the foot and the nephridial openings of the

4th and 5th legs are between the 3rd and 4th pads. The Andean species are *P. eiseni* (Wh.), *P. tuberculatus* (Bouv.), *P. lankesteri* (Bouv.), *P. quiniensis* (Schm.), *P. corradi* (Cam.), *P. cameranoi* (Bouv.) and *P. balsani* (Cam.). Of the remaining species, which are the majority, may be mentioned *P. edwardsi* (Blanch), *P. jamaicensis* (Gr. and Cock.), *P. trinidadensis* (Sedgw.), *P. torquatus* (Ken.), *P. im thurni* (Schl.).

New Britain Peripatus.—With 22 to 24 pairs of claw-bearing legs, with three spinous pads on the legs, and nephridial openings of legs 4 and 5 (sometimes of 6 also) on the proximal pad; feet with one primary papilla on the anterior, one on the posterior side, and one on the dorsal side (median or submedian); outer jaw with a minor tooth, inner jaw without diastema; crural glands absent; well-developed coxal organs absent. Genital opening subterminal behind the last pair of legs; oviduct with receptaculum seminis, without receptaculum ovorum; unpaired part of vas deferens very short; accessory glands two, opening medially and dorsally. Ova small, .1 mm. in diameter, with little yolk, and the embryos provided with large trophic vesicles (Willely). Embryos in the uterus of very different ages, and probably born all the year round. One species only known, *P. novae britanniae* (Willely).

Sumatran Peripatus.—Peripatus with 24 pairs of ambulatory legs, and four spinous pads on the legs. The primary papillae of the neotropical character with conical bases. Generative opening between the legs of the penultimate pair. Feet with only two papillae. Single species, *P. sumatranus* (Sedgw.). The existence of this species is doubtful.

Peripatus from the Malay Peninsula.—With 23 to 25 pairs of claw-bearing legs, four spinous pads on the legs, and nephridial openings of legs 4 and 5 in the middle of the proximal pad or on its proximal side; feet with two primary papillae, one anterior and one posterior; outer jaw with two, inner jaw with two or three minor teeth at the base of the main tooth, separated by a diastema from the row of small teeth; crural glands present in the male only, in the two pairs of legs preceding the generative opening; coxal glands present. Genital opening between the penultimate legs; oviduct with receptacula seminis and ovorum; unpaired part of vas deferens long; male accessory glands two, opening medially between the legs of the last pair. Ova large, with much yolk and thick membrane, like those of Australasian species; embryos with slit-like blastopore and of very different ages in the same uterus, probably born all the year round. The species are *P. solidus* (Evans), *P. borsti* (Evans) and *P. bulleri* (Evans). It will thus be seen that the Malay species, while resembling the neotropical species in the generative organs, differ from them in many features of the legs and feet, in the important characters furnished by the size and structure of the ovum, and by their early development.

AUTHORITIES.—F. M. Balfour, "The Anatomy and Development of *P. capensis*," posthumous memoir, edited by H. N. Moseley and A. Sedgwick, *Quart. Journ. Mic. Sci.* vol. xxiii. (1883); E. L. Bouvier, "Sur l'organisation de *Peripatus tholloni*, Bouv.," *Comptes rendus*, cxxvii. 1358-1361 (1898); "Contributions à l'histoire des Péripates Américains," *Ann. de la société entomologique de France*, lxxviii. 385-450 (1899); "Quelques observations sur les onychophores du musée britannique," *Quart. Journ. Mic. Sci.* xliii. 367 (1900); A. Dendy, "On the Oviparous Species of Onychophora," *Quart. Journ. Mic. Sci.* xlv. 362 (1902); R. Evans, "On Onychophora from the Siamese Malay States," *Quart. Journ. Mic. Sci.* xlv. 473 (1901); and "On the Development of Ooperipatus," *ibid.* xlv. 1 (1901); J. J. Fletcher, "On the Specific Identity of the Australian *Peripatus*, usually supposed to be *P. leuckarti*, Saenger," *Proc. Linn. Soc. New South Wales*, x. 172 (1895); E. Gaffron, "Beiträge z. Anat. u. Physiol. v. *Peripatus*," *Ib.* 1 and 2. *Zool. Beiträge* (Schneider), i. 35, 145; L. Guiding, "Mollusca caribbaeana: an account of a new genus of Mollusca," *Zool. Journ.* ii. 443; pl. 12 (1836); reprinted in *Isis*, xxi. 158, pl. ii. (1838); H. N. Moseley, "On the Structure and Development of *Peripatus capensis*," *Phil. Trans.* (1874); R. I. Pocock, "Contributions to our Knowledge of the Arthropod Fauna of the West Indies," pt. 2, *Malacopoda*, &c., *Journ. Linn. Soc.* xxiv. 518; W. F. Purcell, "On the South African Species of *Peripatus*," &c., *Annals of the South African Museum*, i. 331 (1898-1899); and "Anatomy of *Opisthopatus cinctipes*," *ibid.* vol. ii. (1900); W. L. Sclater, "On the Early Stages of the Development of a South American Species of *Peripatus*," *Quart. Journ. Mic. Sci.* xviii. 343-361 (1888); A. Sedgwick, "A Monograph of the Development of *Peripatus capensis*" (originally published in various papers in the *Quart. Journ. Mic. Sci.*, 1885-1888); *Studies from the Morphological Lab. of the University of Cambridge*, iv. 1-146 (1889); "A Monograph of the Species and Distribution of the Genus *Peripatus*, Guiding," *Quart. Journ. Mic. Sci.* xxviii. 431-494 (1888); L. Sheldon, "On the Development of *Peripatus novae zealandiae*," pts. 1 and 2, *Quart. Journ. Mic. Sci.* xxvii. and xxix. (1888 and 1889). The memoirs quoted by Sclater, Sedgwick and Sheldon are all reprinted in vol. iv. of the *Studies from the Morphological Lab. of the University of Cambridge*, vol. iv. (Cambridge University Press, 1889). T. Steel, "Observations on *Peripatus*," *Proc. Linn. Soc. New South Wales*, p. 94 (1896); A. Willey, "The Anatomy and Development of *P. novae britanniae*," *Zoological Results*, pt. 1, pp. 1-32 (Cambridge, 1898). (A. S. 7)

PERIPTERAL (Gr. *perip*, round, and *pteron*, a wing), in architecture, the term applied to a temple or other structure where the columns of the front portico are returned along its sides as wings at the distance of one or two intercolumniations from the walls of the naos or cella. Almost all the Greek temples were peripteral, whether Doric, Ionic, or Corinthian (see **TEMPLE**).

PERISSODACTYLA (i.e. odd-toed), the name proposed by Sir R. Owen for that division of ungulate mammals in which the toe corresponding to the middle (third) digit of the human hand and foot is symmetrical in itself, and larger than those on either side (when such are present). The Perissodactyla have been brigaded with the Artiodactyla (*q.v.*) to form the typical group of the ungulates, under the name of Diplarthra, or Ungulata Vera, and the features distinguishing the combined group from the less specialized members of the order Ungulata will be found under the heading of that order.

The following are the leading characteristics by means of which the sub-order Perissodactyla is distinguished from the Artiodactyla. The cheek-teeth (premolars and molars) form a

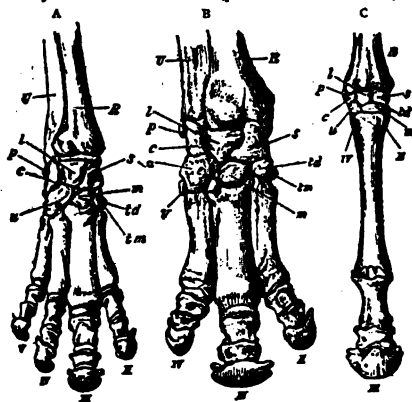

FIG. 1.—Bones of Right Fore-Foot of existing Perissodactyla.

- A, Tapir (*Tapirus indicus*).
 B, Rhinoceros (*Rhinoceros sumatrensis*).
 C, Horse (*Equus caballus*).
 U, ulna; R, radius; c, cuneiform; l, lunar; s, scaphoid; m, ungiform;
 m, magnum; id, trapezoid; tm, trapezium.

continuous series, with massive, quadrate, transversely ridged or complex crowns—the posterior premolars usually resembling the molars in structure. Crown of the last lower molar commonly bilobed. Dorsal-lumbar vertebrae never fewer than twenty-two, usually twenty-three in the existing species. Nasal bones expanded posteriorly. An alisphenoid canal. Femur with a third trochanter. The middle or third digit on both fore and hind feet larger than any of the others, and symmetrical in itself, the free border of the terminal phalanx being evenly rounded (see fig. 1). This may be the only functional toe, or the second and fourth may be subequally developed on each side. In the tapirs and many extinct forms the fifth toe also remains on the fore-limb, but its presence does not interfere with the symmetrical arrangement of the remainder of the foot on each side of the median line of the third or middle digit. The astragalus has a pulley-like surface above for articulation into the tibia, but its lower surface is flattened and unites to a much greater extent with the navicular than with the cuboid, which bone is of comparatively less importance than in the Artiodactyles. In existing forms the calcaneum does not articulate with the lower end of the fibula. The stomach is simple, the caecum large and capacious, the placenta diffused, and the teats inguinal. The Perissodactyla may be divided into the four following sections, namely the extinct Titanotheroidea, the Hippoidea, represented by the horse tribe and their ancestors, the Tapiroidea,

typified by the tapirs, and the Rhinocerotoides, which includes the modern rhinoceroses and their fore-runners.

1. *Titanotheres*.—In the Titanotheroidea the dentition may be expressed by the formula $\frac{2+1+2}{2+1+2}$ c₁, p₁², m₁. There is usually a short gap between the canine and first premolar; the upper molars are short-crowned and transitional between the bunodont (tubercular) and selenodont (creascentic) types, with two outer concave tubercles and two inner conical ones; while the lower molars are creascentic, with three lobes in the last of the series. The skull is elongated, with the orbit not separated from the temporal fossa and the nasals, which may or may not carry horns, reaching at least as far forwards as the union of the premaxillae. The post-glenoid, post-tympanic and paroccipital processes of the skull are large, and there is an alisphenoid canal. There are four functional toes in front and three behind; while the calcaneum, unlike that of the other three groups, articulates with the fibula. The group is represented by the families *Palaeosyopidae* and *Titanotheriidae* in the Tertiary deposits of North America. Both families are described under the heading **TITANOTHEROIDEA**.

2. *Horse Group*.—In the Hippoidea there is generally the full series of 44 teeth, but the first premolar, which is always small, is often deciduous or even absent in the lower or in both jaws. The incisors are chisel-shaped, and the canines tend to become isolated, so as in the more specialized forms to occupy a more or less midway position in a longer or shorter gap between the incisors and premolars. In the upper molars the two outer columns or tubercles of the primitive tubercular molar coalesce to form an outer wall, from which proceed two creascentic transverse crests, the connexion between the crests and the wall being slight or imperfect, and the crests themselves sometimes tubercular. Each of the lower molars carries two creascentic ridges. In the earlier forms the cheek-teeth are low-crowned, but in the higher types they become high-crowned. The number of front toes ranges from four to one, and of hind ones from three to one. The post-glenoid, post-tympanic and paroccipital processes of the skull are large; the second of these being always distinct. Nasals long, normally without traces of horns.

The section is divisible into the families *Equidae* and *Palaeotheriidae*, of which the latter is extinct.

In the *Equidae* the premolars are generally $\frac{3}{3}$ or $\frac{4}{4}$. In the earlier short-crowned forms these teeth are unlike the molars, and the first of the series is separated by a gap from the second. In the high-crowned types, as well as in some of the intermediate ones, they become molar-like, and roots are not developed in the whole cheek-series till late. Orbit in higher forms closed by bone; and ridges of lower cheek-teeth terminating in large loops. Front toes 4, 3 or 1, hind; 3 or 1. (See **EQUIDAE** and **HORSES**.)

In the *Palaeotheriidae* the premolars may be $\frac{4}{4}$ or $\frac{3}{3}$, and are generally molar-like, while the first (when present) is always close to the second; all the cheek-teeth short-crowned and rooted, with or without cement. Outer walls of upper cheek-teeth W-shaped, and transverse crests oblique. Orbit open behind; and ridges of lower cheek-teeth generally terminating in small loops. Feet always 3-toed. (See **PALAEOTHERIUM**.)

3. *Tapir Group*.—In the Tapiroidea the dentition may be either the full 44, or lack the first premolar in the lower or in both jaws. The incisors are chisel-shaped; and (unlike the early Hippoidea) there is no gap between the first premolar, when present, and the second. The upper cheek-teeth are short-crowned and without cement, and show distinct traces of the primitive tubercles; the two outer columns form a more or less complete external wall, connected with the inner ones by a pair of nearly straight transverse crests; and the premolars are originally simpler than the molars. Lower cheek-teeth with two straight transverse ridges. Nasals long in early, but abort in later forms, hornless; orbit open behind. Front toes, 4; hind toes, 3.

This group is also divided into two families, the *Tapiridae* and *Lophiodontidae*, the latter extinct.

In the *Tapiridae* the dentition may be reduced below the typical 44, by the loss of the first lower premolar. Hinder premolars either simple or molar-like. Outer columns of upper molars similar, the hinder ones not flattened; ridges of lower molars oblique or directly transverse, a third ridge to the last molar in the earlier forms. The *Lophiodontidae*, which date from the Eocene, come very close to *Hypocotherium* in the horse-line; and it is solely on the authority of American palaeontologists that the division of these early forms into equoids and tapiroids is attempted. In North America the earliest representative of the group is *Systemodon* of the Lower Eocene, in which all the upper premolars are quite simple; while the molars are of a type which would readily develop into that of the modern tapirs, both outer columns being conical and of equal size. The absence of a gap between the lower canine and first premolar and between the latter and the following tooth is regarded as an essentially tapir-like feature. *Lophiodon* apparently represents this stage in the European Lower Eocene; *Isotelophus*, of the American Middle Eocene, represents a distinct advance, the last upper premolar becoming molar-like, while a second species from the Upper Eocene is still more advanced: the third lobe is, however, retained in the last lower molar. In the

Oligocene of both hemispheres appears *Protapirus*, which ranges well into the Miocene, and is essentially a tapir, having lost the third lobe of the last lower molar, and being in process of acquiring molar-like upper premolars, although none of these teeth have two complete inner columns. Finally, *Tapirus* itself, in which the last three upper premolars, makes its appearance in the Upper Miocene, and continues till the present day. The characters of the genus may be expressed as follows in a more detailed manner.

The dentition is $i \frac{1}{1}, c \frac{1}{1}, p \frac{1}{1}, m \frac{1}{1}$, total 42. Of the upper incisors the first and second are nearly equal, with short, broad crowns, the third is large and conical, considerably larger than the canine, which is separated from it by an interval. Lower incisors diminishing in size from the first to the third; the canine, which is in contact with the third incisor, large and conical, working against (and behind) the canine-like third upper incisor. In both jaws there is a long space between the canines and the commencement of the teeth of the cheek-series, which are all in contact. First upper premolar with a triangular crown narrow in front owing to the absence of the anterior inner column. The other upper premolars and molars all formed on the same plan and of nearly the same size, with four roots and quadrate crowns, rather wider transversely than from before backwards, each having four columns, connected by a pair of transverse ridges, anterior and posterior. The first lower premolar compressed in front; the others composed of a single pair of transverse crests, with a small anterior and posterior basal ridge. Skull elevated and compressed; with the orbit and temporal fossae widely continuous, there being no true post-orbital process from the frontal bone. Nasal apertures very large, and extending high on the face between the orbits; nasal bones short, elevated, triangular and pointed in front. Vertebrae: cervical, 7; dorsal, 18; lumbar, 5; sacral, 6; caudal about 12. Limbs short and stout. Fore-feet with four toes, having distinct hoofs: the first toe being absent, the third the longest, the second and fourth nearly equal, and the fifth the shortest and scarcely reaching the ground in the ordinary standing position. Hind-feet with the typical perissodactyle arrangement of three toes—the middle one being the largest, the two others nearly equal. Nose and upper lip elongated into a flexible, mobile snout or short proboscis, near the end of which the nostrils are situated. Eyes rather small. Ears of moderate size, ovate, erect. Tail very short. Skin thick and but scantily covered with hair. Tapirs are common to the Malay countries and tropical America; two species from the latter area differ from the rest in having a vertical bony partition to the nasal septum, and are hence subgenerically or generically separated as *Tapiria* (*Elasmognathus*) (see TAPIR).

Nearly related is the extinct family *Lophiodontidae* (inclusive of the American *Healedontidae*), in which both the upper and lower first premolar may be absent, while the upper molars present a more rhinoceros-like form, owing to the lateral compression and consequent lengthening of the outer columns, of which the hinder is bent somewhat inwards and is more or less concave externally, thus forming a more complete outer wall. In America the family is represented by *Heptodon*, of the Middle Eocene, which differs from the early members of the tapir-stock in having a long gap between the lower canine and first premolar; the dentition is complete, and the upper premolars are simple. The next stage is *Healedontes*, also of Middle Eocene age, in which the first lower premolar has disappeared, and the last two upper premolars have become molar-like. Finally, in the Oligocene *Colodon* the last three upper premolars are like the molars, and the first pair of lower incisors is lost. In Europe the group is represented by the long-known and typical genus *Lophiodon* with three premolars in each jaw, of which the upper are simpler than the molars. The genus is especially characteristic of the Middle and Upper Eocene, and some of the species attained the size of a rhinoceros.

4. *Rhinoceros Group*.—The last section of the Perissodactyle is that of the Rhinocerotidae, represented by the modern rhinoceroses and their extinct allies. In this group the incisors and canines are very variable in number and form; the lower canine being separated by only a short gap from the outer incisor (when present), but by a long one from the first premolar, which is in contact with the second. The second and third premolars, which are always present, are large and molar-like; the whole of these teeth being essentially of the lophodont type of *Lophiodon*, but the last upper molars assume a more or less triangular form, with an oblique outer wall, and there are certain complications in the structure of all these teeth in the more specialized types (fig. 2). The lower cheek-teeth have, unlike those of the Tapiroidea, crescentic ridges, which have not the loops at their extremities characteristic of the advanced Hippoidea; the last lower molar has no third lobe. The facial portion of the skull is generally shorter than the cranial; the orbit is freely open behind; and the premaxillae tend to be reduced and fused with the nasals. Front toes, 3 or 4; hind toes, 3.

The most primitive group is that of the American *Hyracodontidae*, represented in the Oligocene by *Hyrachyus*, *Hyracodon* and *Triplopus*. With the exception of the first lower premolar, the dentition is complete; the incisors being normal, but the canine rudimentary, and the last upper molar distinctly triangular. The upper molars have a crista and a crochet (fig. 2). The skull is high, with the facial and cranial portions approximately equal. There

are only three front toes, and the limbs are long and adapted for running.

In the *Amylodontidae*, represented by the North American Middle Eocene *Amylodon* and *Metamyodon*, the premolars may be either $\frac{1}{1}$ or $\frac{2}{1}$, making the total number of teeth either 44 or 46. The incisors tend to become lateral, the canines are enlarged, and the last upper molar is sub-quadrangular. The upper molars have a crista but no crochet (fig. 2). As in the last family, the post-glenoid process of the skull is broad; the whole skull being depressed with a shortened facial portion. The fore-foot is five-toed and spreading; indicating that the members of the family were swamp-dwelling animals.

Finally, we have the family *Rhinocerotidae*, which includes the existing representatives of the group. In this family the dentition has undergone considerable reduction, and may be represented inclusive of all the variations, by the formula $i \frac{1}{1} c \frac{1}{1} p \frac{1}{1} m \frac{1}{1}$. The first upper incisor, when present, has an antero-posteriorly elongated crown, but the second is small; when fully developed, the lower canine is a large forwardly directed tusk-like tooth with sharp cutting-edges, and biting against the first upper incisor. The third upper molar is triangular, and most of the teeth of the upper cheek-series may have both crochet and crista (fig. 2). The post-glenoid process is small, and the facial and cranial portions of the skull are approximately of equal length. Usually there are three, but occasionally four front toes; and the limb-bones are short.

A large number of representatives of the group are known from both the Old and the New World; specialization displaying itself in the later ones in the development of dermal horns over the nasal bones, either in laterally placed pairs as in some of the early forms, or in the median line, either single or double. In North America rhinoceroses became extinct before the close of the Pliocene period; but in the Old World, although their geographical distribution has become greatly restricted, at least five well-marked species survive. The group is unknown in South America.

As regards the dentition of the existing species, the cheek-series consists of the four premolars and three molars above and below, all in contact and closely resembling each other, except the first, which is much smaller than the rest and often deciduous; the



FIG. 2.—Grinding Surface of moderately worn Right Upper Second Molars of Rhinoceros.

A. *Rhinoceros unicornis*.

- 1, Anterior surface.
- 2, Inferior surface.
- 3, Internal surface.
- 4, External surface (wall or dorsum).
- 5, Antero-internal pillar or column.

B. *Rhinoceros sondaicus*.

- 6, Postero-internal pillar or column.
- 7, Anterior valley.
- 8, Median valley.
- 9, Posterior valley.
- 10, Accessory valley.
- 11, Crista.
- 12, Crochet.

others gradually increasing in size up to the penultimate. The upper molars present a characteristic pattern of crown, having a much-developed flat or more or less sinuous outer wall, and two transverse ridges running obliquely inwards and backwards from it, terminating internally in conical eminences or columns, and enclosing a deep valley between. The posterior valley is formed behind the posterior transverse ridge, and is bounded externally by a backward continuation of the outer wall and behind by the cingulum. The anterior valley is formed in the same manner, but is much smaller. The middle valley is often intersected by vertical "crista" and "crochet" plates projecting into it from the anterior surface of the posterior transverse ridge or from the wall, the development of which is a useful guide in discriminating species, especially those known only by teeth and bones. The depressions between the ridges are not filled up with cement. As stated above, the lower molars have the crown formed by a pair of crescents; the last having no third lobe.

The head is large, and the skull elongated, and elevated posteriorly into a transverse occipital crest. No post-orbital processes or any separation between orbits and temporal fossae. Nasal bones large and stout, co-ossified, and standing out freely above the premaxillae, from which they are separated by a deep and wide fissure; the latter small, generally not meeting in the middle line in front, often rudimentary. Tympanics small, not forming a bulla. Brain-cavity small for the size of the skull. Vertebrae: cervical, 7; dorsal 19-20; lumbar, 3; sacral, 4; caudal, about 22.

Limbs stout, and of moderate length. These completely developed toes, with distinct broad rounded hoofs on each foot. Teats two, inguinal. Eyes small. Ears of moderate size, oval, erect, prominent, placed near the occiput. Skin very thick, in many species thrown into massive folds. Hairy covering scanty. One or two median horns on the face. When one is present it is situated over the conjoined nasal bones; when two, the hinder one is over the frontals. These horns, which are of a more or less conical form and usually recurved, and often grow to a great length (three or even four feet), are composed of a solid mass of hardened epidermic cells growing from a cluster of long dermal papillae. The cells formed on each papilla constitute a distinct horny fibre, like a thick hair, and the whole is cemented together by an intermediate mass of cells which grow up from the interspaces between the papillae. It results from this that the horn has the appearance of a mass of agglutinated hairs, which, in the newly growing part at the base, readily fray out on destruction of the softer intermediate substance; but the fibres differ from true hairs in growing from a free papilla of the derm, and not within a follicular involution of the same. Considerable difference of opinion exists with regard to the best classification of the family, some authorities including most of the species in the typical genus *Rhinoceros*, while others recognize quite a number of sub-families and still more genera. Here the family is divided into two groups *Rhinocerotinae* and *Elasmotheriinae*, the latter including only *Elasmotherium*, and the former all the rest. In the Lower Oligocene of Europe we have *Ronotherium* and in that of America *Leptaerotherium* (*Trigonia*), which were primitive species with persistent upper canines and three-toed fore-feet. Possibly they belonged to the *Amyndonitidae*, but they may have been related to the Upper Oligocene *Diceratherium*, in which the nasal bones formed a transverse pair; this genus being common to Europe and North America. *Caenopus* is an allied American type. Hornless rhinoceroses, with five front-toes, ranging from the Oligocene to the Lower Pliocene in Europe, represent the genus *Aceratherium*, which may also occur in America, as it certainly does in India. With the short-skulled, short-toed, three-toed and generally horned rhinoceroses ranging in Europe and America from the Lower Miocene to the Lower Pliocene, typified by the European *R. goldfursi* and *R. brachypus*, we may consider the genus *Rhinoceros* to commence; these species constituting the subgenus *Teloceros*. The living *R. (Dicerorhinus) sumatrensis* of south-eastern Asia indicates another subgenus, represented in the European Miocene by *R. sarsenensis* and in the Indian Pliocene by *R. palasius*, in which two horns are combined with the presence of upper incisors and lower canines. Next we have the living African species, representing the subgenus *Diceros*, in which there are two horns but no front teeth. To this group belongs the extinct European and Asiatic woolly rhinoceros, *Rhinoceros (Diceros) antiquitatis*, of Pleistocene age, of which the frozen bodies are sometimes found in Siberia, and *R. (D.) pachynathus* of the Lower Pliocene of Greece. Finally the Great Indian rhinoceros *R. unicornis*, the Javan *R. sondaicus*, and the Lower Pliocene Indian *R. sivalensis* and *R. palaenidicus*, represent *Rhinoceros* proper, in which front teeth are present, but there is only one horn. (See RHINOCEROS.)

The subfamily *Elasmotheriinae* is represented only by the huge *E. sibiricum* of the Siberian Pleistocene, in which the premolars were reduced to § while front-teeth were probably wanting, and the cheek teeth developed tall crowns, without roots, but with cement in the valleys, and the enamel of the central parts curiously crimped. A hump on the forehead probably indicates the existence of a large frontal horn.

LITERATURE.—J. L. Wortman and C. Earle, "Ancestors of the Tapir from the Lower Miocene of Dakota," *Bull. Amer. Mus.* vol. v. art. 11, (1893); H. F. Osborn, "Phylogeny of the Rhinoceroses of Europe," *op. cit.* vol. xiii. art. 19 (1900); O. Thomas, "Notes on the Type Specimen of *Rhinoceros lasiotis*, with Remarks on the Generic Position of the Living Species of Rhinoceros," *Proc. Zool. Soc. (London)*, 1901. (R. L.*)

PERISTYLE (Gr. *περί*, round, and *στυλος*, column), in architecture, a range of columns (whether rectangular or circular on plan) in one or two rows, enclosing the sanctuary of a temple; the term is also applied to the same feature when built round the court in which the temple is situated and in Roman houses to the court in the rear, round which the private rooms of the family were arranged, which were entered from the covered colonnade round the court.

PERITONITIS, inflammation of the peritoneum—the serous membrane which lines the abdominal and pelvic cavities and gives a covering to their viscera. It may exist in an acute or a chronic form, and may be either localized or diffused.

Acute peritonitis may be brought on, like other inflammations, by exposure to wet or cold, or in connexion with injury to, or disease of, some abdominal organ, or with general feebleness of health. It is an occasional result of hernia and of obstruction

of the bowels, of wounds penetrating the abdomen, of the perforation of viscera, as in ulcer of the stomach, and of the intestine in typhoid fever, of the bursting of abscesses or cysts into the abdominal cavity, and also of the extensions of inflammatory action from some abdominal or pelvic organ, such as the appendix, the uterus, or bladder. At first localized, it may afterwards become general. The changes effected in the peritoneum are similar to those undergone by other serous membranes when inflamed. Thus, there are congestion; exudation of lymph in greater or less abundance, at first greyish and soft, thereafter yellow, becoming tough and causing the folds of the intestine to adhere together; effusion of fluid, either clear, turbid, bloody or purulent. The tough, plastic lymph connecting adjacent folds of intestine is sometimes drawn out like spun-glass by the movements of the intestines, forming bands and loops through or beneath which a piece of bowel may become fatally snared.

The symptoms of acute peritonitis usually begin by a shivering fit or rigor, together with vomiting, and with pain in the abdomen of a peculiarly severe and sickening character, accompanied with extreme tenderness, so that pressure, even of the bed-clothes, causes aggravation of suffering. The patient lies on the back with the knees drawn up so as to relax the abdominal muscles; the breathing becomes rapid and shallow, and is performed by movements of the chest only, the abdominal muscles remaining quiescent—unlike what takes place in healthy respiration. The abdomen becomes swollen by flatulent distension of the intestines, which increases the distress. There is usually constipation. The skin is hot, although there may be perspiration; the pulse is small, hard and wiry; the urine is scanty and high coloured, and is passed with pain. The face is pinched and anxious. These symptoms may pass off in a day or two; if they do not the case is apt to go on to a fatal termination. In such event the abdomen becomes more distended; hicough, and the vomiting of brown or blood-coloured matter occur; the temperature falls, the face becomes cold and clammy; the pulse is exceedingly rapid and feeble, and death takes place from collapse, the mental faculties remaining clear till the close. When the peritonitis is due to perforation—as may happen in the case of gastric ulcer or of ulcers of typhoid fever, or in the giving way of a loop of strangulated bowel—the above-mentioned symptoms and the fatal collapse may all take place in from twelve to twenty-four hours. The puerperal form of this disease, which comes on within a day or two after childbirth, is often rapidly fatal. The actual cause of death is the absorption of the poisonous inflammatory products which have been poured out into the peritoneal cavity, as well as of the toxic fluids which have remained stagnant in the paralysed bowel.

Perhaps the commonest cause of septic peritonitis is the escape of micro-organisms (*bacillus coli*) from the ulcerated, mortified or inflamed appendix (see APPENDICITIS). A generation or so ago deaths from this cause were generally placed under the single heading of "peritonitis," but at the present time the primary disease is shown upon the certificate which too often runs thus: appendicitis five days, acute peritonitis two days.

Chronic peritonitis may occur as a result of the acute attack, or as a tuberculous disease. In the former case, the gravest symptoms having subsided, some abdominal pain continues, and there is considerable swelling of the abdomen, corresponding to a thickening of the peritoneum, and to the presence of fluid in the peritoneal cavity. This kind of peritonitis may also develop slowly without there having been any preceding acute attack. There is a gradual loss of strength and flesh. The disease is essentially a chronic one; it is not usually fatal.

Tuberculous peritonitis occurs either alone or in association with tuberculous disease of a joint or of the lungs. The chief symptoms are abdominal discomfort, or pain, and distension of the bowels. The patient may suffer from either constipation or diarrhoea, or each alternately. Along with these local manifestations there may exist the usual phenomena of tuberculous disease, viz. high fever, with rapid emaciation and loss of strength. But some cases of tuberculous peritonitis present symptoms which are not only obscure, but actually misleading.

There may be no abdominal distension, and no pain or tenderness. The patient may lie quietly in bed, flat on his back, with the legs down straight, and he may have no marked elevation of temperature. There may be no vomiting and no constipation or diarrhoea. In some cases, the neighbouring coils of intestine having been glued together, a collection of serous fluid takes its place in the midst of the mass, and, being walled in by the adhesions, forms a rounded tumour, dull on percussion, but not tender or painful. Such cases, especially when occurring in women, are apt to be mistaken for cystic disease of the ovary.

As regards the *treatment of acute peritonitis*, the first thing that the surgeon has to do is to assure himself that the disease is not due to some cause which itself should be dealt with, to a septic disease of appendix or Fallopian tube, for instance, or to a toxic condition of the uterus, the result, perhaps, of a criminal or innocent abortion, or to a perforated ulcer of stomach or intestine. In many obscure cases the safest treatment is likely to be afforded by an exploratory abdominal section. If the medical attendant has made up his mind that the question of exploration is not to be entertained—a decision which should be arrived at only after most deliberate consultation—the best thing will be to apply fomentations to the abdomen, and to administer small and repeated doses of morphia by the skin— $\frac{1}{4}$ or $\frac{1}{2}$ grain—repeated every hour or so until the physiological effect is produced. As regards other drugs, it may be a question as to whether calomel or Epsom salts should be given. As regards food, the only thing that can be safely recommended is a little hot water taken in sips. A bed-cradle should be placed over the patient in order to keep the weight of the bed-clothes from the abdomen. (E. O.*)

PERIZONIUS (or **ACCINCTUS**), the name of **JAKOB VOORBROEK** (1651–1715), Dutch classical scholar, who was born at Appingedam in Groningen on the 26th of October 1651. He was the son of Anton Perizonius (1626–1672), the author of a once well-known treatise, *De ratione studii theologicæ*. Having studied at the university of Utrecht, he was appointed in 1682 to the chair of eloquence and history at Franeker through the influence of J. G. Graevius and Nicolas Heinsius. In 1693 he was promoted to the corresponding chair at Leiden, where he died on the 6th of April 1715. The numerous works of Perizonius entitle him to a very high place among the scholars of his age. Special interest attaches to his edition of the *Minerva* of Francisco Sanchez or Sanctius of Salamanca (1st ed., 1587; ed. C. L. Bauer, 1793–1801), one of the last developments of the study of Latin grammar in its pre-scientific stage, when the phenomena of language were still regarded as for the most part disconnected, conventional or fortuitous. Mention should also be made of his *Animadversiones historice* (1685), which may be said to have laid the foundations of historical criticism, and of his treatises on the Roman republic, alluded to by Niebuhr as marking the beginning of that new era of historical study with which his own name is so closely associated.

The article on Perizonius in Van der Aa's *Biographisch Woordenboek der Nederlanden* contains full biographical and bibliographical particulars; see also F. A. Eckstein in Ersch and Gruber's *Allgemeine Encyclopædie*.

PERJURY (through the Anglo-Fr. *perjurie*, modern *parjure*, Lat. *perjuriū*, a false oath, *perjurare*, to swear falsely), an assertion upon an oath duly administered in a judicial proceeding before a competent court of the truth of some matter of fact, material to the question depending in that proceeding, which assertion the asserter does not believe to be true when he makes it, or on which he knows himself to be ignorant (Stephen, *Digest of the Criminal Law*, art. 135). In the early stages of legal history perjury seems to have been regarded rather as a sin than as a crime, and so subject only to supernatural penalties. The injury caused by a false oath was supposed to be done not so much to society as to the Divine Being in whose name the oath was taken (see OATH). In Roman law, even in the time of the empire, the perjurer fell simply under divine reprobation, and was not dealt with as a criminal, except where he had been bribed to withhold true or give false evidence, or where the oath was by the genius of the emperor. In the latter case punishment was no doubt inflicted more for the insult to the emperor than for the perjury. False testimony leading to the conviction of a

person for a crime punishable with death constituted the offence of homicide rather than of perjury. In England, perjury, as being a sin, was originally a matter of ecclesiastical cognisance. At a later period, when it had become a crime, the jurisdiction of the spiritual courts became gradually confined to such perjury as was committed in ecclesiastical proceedings, and did not extend to perjury committed in a temporal court. The only perjury which was for a long time noticed at common law was the perjury of jurors. Attaint of jurors (see ATTAIN, WARR OF) who were originally rather in the position of witnesses than of judges of fact, incidentally subjected them to punishment for perjury. Criminal jurisdiction over perjury by persons other than jurors seems to have been first assumed by the Star Chamber, acting under the powers supposed to have been conferred by an act of Henry VII. (1487). After the abolition of the Star Chamber by the Long Parliament in 1641 and the gradual diminution of the authority of the spiritual courts, perjury (whether in the strict sense of the word or the taking of a false oath in non-judicial proceedings) practically fell entirely within the jurisdiction of the ordinary criminal tribunals. At common law only a false oath in judicial proceedings is perjury. But by statute the penalties of perjury have been extended to extra-judicial matters e.g. false declarations made for the purpose of procuring marriage (The Marriage and Registration Act 1856), and false affidavits under the Bills of Sale Act 1878. False affirmation by a person permitted by law to affirm is perjury (The Evidence Further Amendment Act 1869; The Evidence Amendment Act 1870).

In order to support an indictment for perjury the prosecution must prove the authority to administer the oath, the occasion of administering it, the taking of the oath, the substance of the oath, the materiality of the matter sworn, the falsity of the matter sworn, and the corrupt intention of the defendant. The indictment must allege that the perjury was wilful and corrupt, and must set out the false statement or statements on which perjury is assigned, subject to the provisions of the Prosecutions for Perjury Act 1749 (which also applies to subornation of perjury). By that act it is sufficient to set out the substance of the offence, without setting forth the bill, answer, &c., or any part of the record and without setting forth the commission or authority of the court before whom the perjury was committed. The matter sworn to must be one of fact and not of mere belief or opinion. It is not homicide, as in Roman law, to procure the death of another by false evidence, but the Criminal Code, ss. 118, 164, proposed to make such an offence a substantive crime of greater gravity than ordinary perjury, and punishable by penal servitude for life. It is a rule of evidence, founded upon obvious reasons, that the testimony of a single witness is insufficient to convict on a charge of perjury. There must be corroboration of his evidence in some material particular. Perjury is a common law misdemeanour, not triable at quarter-sessions. Most persons in a judicial position have the right of directing the prosecution of any witness, if it appears to them that he has been guilty of perjury (The Criminal Procedure Act 1851). The provisions of the Vexatious Indictments Act 1859 extend to perjury and subornation of perjury. By that Act no indictment for either of such offences can be preferred unless the prosecutor or accused is bound by recognisance, or the accused is in custody, or the consent of a judge is obtained, or (in the case of perjury) a prosecution is directed under the act of 1851.

Subornation of perjury is procuring a person to commit a perjury which he actually commits in consequence of such procurement. If the person attempted to be suborned do not take the oath, the person inciting him, though not guilty of subornation, is liable to fine and corporal punishment. Perjury and subornation of perjury are punishable at common law with fine and imprisonment. By the combined operation of the Perjury Act 1728 and later statutes, the punishment at present appears to be penal servitude for any term, or imprisonment with or without hard labour for a term not exceeding seven years (see Stephen, *Digest*, art. 148). The punishment at common law was whipping, imprisonment, fine and pillory.

Perjury or pervarication committed before a committee of either House of Parliament may be dealt with as a contempt or breach of privilege as well as by prosecution. As to false oaths not perjury, it is a misdemeanor at common law, punishable by fine and imprisonment, to swear falsely before any person authorized to administer an oath upon a matter of common concern, under such circumstances that the false swearing, if committed in judicial proceedings, would have amounted to perjury. There are some cases of making false declarations which are punishable on summary conviction, e.g. certain declarations under the Registration of Births and Deaths Act 1874, and the Customs Consolidation Act 1876.

In Scotland the law, as a general rule, agrees with that of England. Perjury may be committed by a party on reference to oath as well as by a witness. A witness making a false affirmation is guilty of perjury (The Affirmation [Scotland] Act, 1865). The acts of 1851 and 1859 do not extend to Scotland. The trial, though usually by the court of judicatory, may be by the court of session if the perjury is committed in the course of an action before that court. The punishment is penal servitude or imprisonment at the discretion of the court. Formerly a person convicted of perjury was disabled from giving evidence in future; this disability was abolished by the Evidence (Scotland) Act 1852.

In the United States the common law has been extended by most states to embrace false affirmations and false evidence in proceedings not judicial. Perjury in a United States court is dealt with by an act of Congress of the 3rd of March 1855, by which the maximum punishment for perjury or subornation of perjury is a fine of \$2000 or imprisonment for not more than five years. Jurisdiction to punish perjury committed in the state courts belongs to the states, as the Federal Constitution did not give it to the Federal government. Statutory provisions founded upon the English act of 1749, have been adopted in some states. In the states which have not adopted such provisions, the indictment must set out the offence with the particularity necessary at common law.

On the continent of Europe perjury is also regarded as an offence of gravity punishable by imprisonment for varying periods. In Germany, as in England, it was at one time a matter for the spiritual courts. In Austria it is treated as a form of fraud, and the punishment is proportioned to the estimated amount of damage done to the party aggrieved. In France the term perjury (*parjure*) is specifically applied only to the making of false oaths by parties in a civil suit.

PERKIN, SIR WILLIAM HENRY (1838-1907), English chemist, was born in London on the 12th of March 1838. From an early age he determined to adopt chemistry as his profession, although his father, who was a builder, would have preferred him to be an architect. Attending the City of London School he devoted all his spare time to chemistry, and on leaving, in 1853, entered the Royal College of Chemistry, then under the direction of A. W. Hofmann, in whose own research laboratory he was in the course of a year or two promoted to be an assistant. Devoting his evenings to private investigations in a rough laboratory fitted up at his home, Perkin was fired by some remarks of Hofmann's to undertake the artificial production of quinine. In this attempt he was unsuccessful, but the observations he made in the course of his experiments induced him, early in 1856, to try the effect of treating aniline sulphate with bichromate of potash. The result was a precipitate, aniline black, from which he obtained the colouring matter subsequently known as aniline blue or mauve. He lost no time in bringing this substance before the managers of Pullar's dye-works, Perth, and they expressed a favourable opinion of it, if only it should not prove too expensive in use. Thus encouraged, he took out a patent for his process, and leaving the College of Chemistry, a boy of eighteen, he proceeded, with the aid of his father and brother, to erect works at Greenford Green, near Harrow, for the manufacture of the newly discovered colouring matter, and by the end of 1857 the works were in operation. That date may therefore be reckoned as that of the foundation of the coal-tar colour industry, which has since attained such important dimensions—in Germany, however, rather than in England, the country where it originated. Perkin also had a large share in the introduction of artificial alizarin (*q.v.*), the red dye of the madder root. C. Graebe and C. T. Liebermann in 1868 prepared that substance synthetically from anthracene, but their process was not practicable on a large scale, and it was left to him to patent a method that was commercially valuable. This

he did in 1869, thus securing for the Greenford Green works a monopoly of alizarin manufacture for several years. About the same time he also carried out a series of investigations into kindred substances, such as anthrapurpurin. About 1874 he abandoned the manufacture of coal-tar colours and devoted himself exclusively to research in pure chemistry, and among the discoveries he made in this field was that of the reaction known by his name, depending on the condensation of aldehydes with fatty acids (see CINNAMIC ACID). Later still he engaged in the study of the relations between chemical constitution and rotation of the plane of polarisation in a magnetic field, and enunciated a law expressing the variation of such rotation in bodies belonging to homologous series. For this work he was in 1889 awarded a Davy medal by the Royal Society, which ten years previously had bestowed upon him a Royal medal in recognition of his investigations in the coal-tar colours. The Chemical Society, of which he became secretary in 1869 and president in 1883, presented him with its Longstaff medal in 1889, and in 1890 he received the Albert medal of the Society of Arts. In 1906 an international celebration of the fiftieth anniversary of his invention of mauve was held in London, and in the same year he was made a knight. He died near Harrow on the 14th of July 1907.

His eldest son, **WILLIAM HENRY PERKIN**, who was born at Sudbury, near Harrow, on the 17th of June 1860, and was educated at the City of London School, the Royal College of Science, and the universities of Würzburg and Munich, became professor of chemistry at the Heriot-Watt College, Edinburgh, in 1887, and professor of organic chemistry at Owens College, Manchester, in 1892. His chief researches deal with the polymethylene compounds, the alkaloids, in particular hydrastine and berberine, and the camphors and terpenes (*q.v.*). He received the Davy medal from the Royal Society in 1904.

PERKINS, CHARLES CALLAHAN (1823-1886), American artist and author, was born in Boston and educated at Harvard, subsequently studying art in Rome and Paris. Returning to Boston, he helped to found the Museum of Fine Arts, of which he was honorary director, and for many years he played a leading part in artistic circles as a cultured critic and writer. His chief publications were *Tuscan Sculptors* (1864) and *Italian Sculptors* (1868)—replaced in 1883 by *The Historical Handbook of Italian Sculptors—Art in Education* (1870), and *Sepulchral Monuments in Italy* (1885).

PERKINS, JACOB (1766-1849), American inventor and physicist, was born at Newburyport, Massachusetts, in 1766, and was apprenticed to a goldsmith. He soon made himself known by a variety of useful mechanical inventions, and in 1818 came over to England with a plan for engraving bank-notes on steel, which ultimately proved a signal success, and was carried out by Perkins in partnership with the English engraver Heath. His chief contribution to physics lay in the experiments by which he proved the compressibility of water and measured it by a piezometer of his own invention (see *Phil. Trans.*, 1820, 1826). He retired in 1834, and died in London on the 30th of July 1849.

His second son, **ANGEL MARCH PERKINS** (1799?-1881), also born at Newburyport, went to England in 1827, and was the author of a system of warming buildings by means of high-pressure steam. His grandson, **LOFTUS PERKINS** (1834-1891), most of whose life was spent in England, experimented with the application to steam engines of steam at very high pressures, constructing in 1880 a yacht, the "Antiracite," whose engines worked with a pressure of 500 lb to the sq. in.

PERLEBERG, a town of Germany, in the Prussian province of Brandenburg, on the Stepenitz, 6 m. N.E. from Wittenberge by the railway to Neustrelitz. Pop. (1905), 9502. It contains a fine Gothic Evangelical church, a Roman Catholic church, a synagogue and several schools, and has a town-hall, dating from the 15th century, and a Roland column. Its chief manufactures are machinery, soap, blacking and clogs.

See Höpfner, *Perleberger Reimchronik*. *Perleberg von 1200 bis 1700* (Perleberg, 1876).

PERLES, JOSEPH (1835-1894), Jewish rabbi, was born in Hungary in 1835, and died at Munich in 1894. He was one of the first rabbis trained at the new type of seminary (Breslau). Perles' most important essays were on folk-lore and custom. There is much that is striking and original in his history of marriage (*Die jüdische Hochzeit in nachbiblischer Zeit*; 1860), and of mourning customs (*Die Leichenfeierlichkeiten im nachbiblischen Judentum*, 1861), his contributions to the sources of the Arabian Nights (*Zur rabbinischen Sprach- und Sagenkunde*, 1873), and his notes on rabbinic antiquities (*Beiträge zur rabbinischen Sprach- und Altertumskunde*, 1893). Perles' essays are rich in suggestiveness, and have been the starting-point of much fruitful research. He also wrote an essay on Nachmanides, and a biography and critical appreciation of Rashba (1863). (I. A.)

PERLITE, or **PEARLSTONE**, a glassy volcanic rock which, when struck with a hammer, breaks up into small rounded masses that often have a pearly lustre. The reason for this peculiarity is obvious in microscopic sections of the rock, for many small cracks may be seen traversing the glassy substance. These mostly take a circular course, and often occur in groups, one within another. The circular cracks bound the little spheres into which the rock falls when it is struck, and the concentric fissures are the cause of the pearly lustre, by the reflection of light from enclosed films of air. Longer straight cracks run across the sections separating areas in which the circular fissures preponderate. By decomposition the fissures may be occupied by deposits of limonite, which make them more obvious, or by other secondary minerals. The glass itself often undergoes change along the cracks by becoming finely crystalline or devitrified, dull in appearance and slightly opaque in section. In polarized light the perlitic glass is usually quite isotropic, but sometimes the internal part of some of the spheres has a slight double refraction which is apparently due to strain. The glass found on the waste-heaps of glass-furnaces is sometimes very coarsely perlitic.

Perlitic structure is not confined to glass, but may be seen also in that variety of opal which is called hyalite. This forms small transparent rounded masses like drops of gum, and in microscopic section exhibits concentric systems of cracks. Hyalite, like perlitic obsidian, is amorphous or non-crystalline. It is easy to imitate perlitic structure by taking a little Canada balsam and heating it on a slip of glass till most of the volatile matters are driven out; then drop it in a basin of cold water and typical perlitic structure will be produced. The reason is apparently the sudden contraction when the mass is chilled. In the glaze on tiles and china rounded or polygonal systems of cracks may often be seen which somewhat resemble perlitic structure but are less perfect and regular. Many rocks which are cryptocrystalline or felsitic, and not glassy, have perfect perlitic structure, and it seems probable that these were originally vitreous obsidians or pitchstones and have in process of time been changed to a finely crystalline state by devitrification. Occasionally in olivine and quartz rounded cracks not unlike perlitic structure may be observed.

Many perlitic rocks contain well-developed crystals of quartz, feldspar, augite or magnetite, &c., usually more or less corroded or rounded, and in the fine glassy base minute crystallites often abound. Some of the rocks have the resinous lustre and the high percentages of combined water which distinguish the pitchstones; others are bright and fresh obsidians, and nearly all the older examples are dull, cryptocrystalline felsites. According to their chemical compositions they range from very acid rhyolites to trachytes and andesites, and the dark basaltic glasses or tachylites are sometimes highly perlitic. It is probable that most perlitic rocks are of intrusive origin, and the general absence of steam cavities in these rocks would support this conclusion, but some perlitic Hungarian rhyolites are believed to be lavas.

Very well known rocks of this kind are found in Meissen, Saxony, as dikes of greenish and brownish pitchstone. Other examples are furnished by the Tertiary igneous rocks of Hungary (Tokai, &c.), the Euganean Hills (Italy) and Ponza Island (in the Mediterranean).

In mineralogical collections rounded nodules of brown glass

varying from the size of a pea to that of an orange may often be seen labelled *Marekanite*. They have long been known to geologists and are found at Ockotsk, Siberia, in association with a large mass of perlitic obsidian. These globular bodies are, in fact, the more coherent portions of a perlitic; the rest of the rock falls down in a fine powder, setting free the glassy spheres. They are subject to considerable internal strain, as is shown by the fact that when struck with a hammer or sliced with a lapidary's saw they often burst into fragments. Their behaviour in this respect closely resembles the balls of rapidly cooled, unannealed glass which are called Prince Rupert's drops. In their natural conditions the marekanite spheres are doubly refracting, but when they have been heated and very slowly cooled they lose this property and no longer exhibit any tendency to sudden disintegration.

In Great Britain Tertiary vitreous rocks are not common, but the pitchstone which forms the Scur of Eigg is a dark andesitic porphyry with perlitic structure in its glassy matrix. A better example, however, is provided by a perlitic dacitic pitchstone porphyry that occurs near the Tay Bridge in Fifeshire. The tachylitic basalt dikes of Mull are occasionally highly perlitic. As Sandy Braes in Antrim a perlitic obsidian has been found, and the Loos Rock, near Wellington in Shropshire, is a devitrified obsidian which shows perlitic cracks and the remains of spherulites. (J. S. F.)

PERM, a government of east Russia, bounded S. by the governments of Orenburg and Ufa, W. by Vyatka, N.W. by Vologda, and E. by Tobolsk (Siberia). It has an area of 128,173 sq. m. Though administratively it belongs entirely to Russia in Europe, its eastern part (about 57,000 sq. m.) is situated in Siberia, in the basin of the Ob. The government is traversed from north to south by the Ural Mountains, 30 to 45 m. in width, thickly clothed with forests, and deeply excavated by rivers. The highest summits do not rise above 3600 ft. in the northern section of the range (the Vogulian Ural); in the central portion, between 59° and 66° 30' N., they once or twice exceed 5000 ft. (Deneshkin, 5360 ft.); but the chain soon sinks towards the south, where it barely attains an elevation of 3000 ft. Where the great Siberian road crosses it the highest point is 1400 ft.

The government is very well drained by rivers belonging to the Pechora, Tobol (affluent of the Ob) and Kama systems. The Pechora itself rises in the northern corner of the government, and its tributary the Volosnitsa is separated by a distance of less than 3 m. from the navigable Vogulka, a tributary of the Kama, a circumstance of some commercial importance. The chief river of Perm, is however, the Kama, whose navigable tributaries the Chusovaya, Sylva and Kolva are important channels for the export of heavy iron goods to Russia. The government is dotted with a great number of lakes of comparatively trifling size, their total area being 730 sq. m., and with marshes, which are extensive in the hilly tracts of the north. Granites, diorites, porphyries, serpentines and Laurentian gneisses and limestones, containing iron, copper and zinc ores, constitute the main axis of the Ural chain; their western slope is covered by a narrow strip of Huronian crystalline slates, which disappear in the east under the Post-Tertiary deposits of the Siberian lowlands, while on the west narrow strips of Silurian limestones, quartzites and slates, and separate islands of Devonian deposits, appear on the surface. These in their turn are overlain with Carboniferous clays and sandstones, containing Coal Measures in several isolated basins. The Permian deposits extend as a regular strip, parallel to the main ridge, over these last, and are covered with the so-called "variegated marls," which are considered as Triassic, and appear only in the western corner of the territory.

Perm is the chief mining region of Russia, owing to its wealth in iron, silver, platinum, copper, nickel, lead, chrome ore, manganese and auriferous alluvial deposits. Many rare metals, such as iridium, osmium, rhodium and ruthenium, are found along with the above, as also a great variety of precious stones, such as diamonds, sapphires, jaspers, tourmalines, beryls, phenacites, chrysoberyls, emeralds, aquamarines, topazes, amethysts, jades, malachite. Salt-springs occur in the west; and the mineral waters, though still little known, are worthy of mention. No less than 70% of the total area is occupied with forest; but the forests are distributed very unequally, covering 05% of the area in the north and only 25% in the south-east. Firs, the pine, cedar, larch, birch, alder and lime are the most common; the oak appears only in the south-west. The flora of

Perm presents a mixture of Siberian and Russian species, several of which have their north-eastern or south-western limits within the government. The climate is severe, the average temperature at different places being as follows—

	Lat. N.	Altitude.	Yearly Average.	January Average.	July Average.
Bogalovsk	59° 45'	Ft. 630	F. 29·3°	F. 3° 0'	F. 62·6°
Usoyle (Kama)	59° 25'	300	34·0°	4·5°	63·8°
Nizhny-Tagibile	57° 55'	390	33·1°	2·0°	64·9°
Ekaterinburg	56° 48'	890	32·9°	2·5°	63·5°

The estimated population in 1906 was 3,487,100, and consists chiefly of Great Russians, besides Bashkirs (including Meshcher-yaks and Teptyars), Permyaks or Permlians, Tatars, Cheremisses, Sryrenians, Votyaks and Voguls. Agriculture is the general occupation; rye, oats, barley and hemp are raised in all parts, and wheat, millet, buckwheat, potatoes and flax in the south. Cattle-breeding is specially developed in the south-east among the Bashkirs, who have large numbers of horses. Mining is developing steadily though slowly. The ironworks employ nearly 200,000 hands (12,000 being in the Imperial ironworks), and their aggregate output reaches an estimated value of £6,000,000 annually. The annual production of gold is valued at nearly half a million sterling, and of platinum at approximately a quarter of a million, the output of platinum being equal to 95% of the world's total output. Coal and coke to the extent of 300,000 to 500,000 tons, salt to 300,000 tons, asbestos and other minerals are also obtained. The first place among the manufacturing industries is taken by flour-mills. The cutting of precious stones is extensively carried on throughout the villages on the eastern slope of the Ural Mountains, the chief market for them being at Ekaterinburg. An active trade, greatly favoured by the easy communication of the chief centres of the mining industry with the market of Nizhnyi Novgorod on the one side and with the network of Siberian rivers on the other, is carried on in metals and metal wares, minerals, timber and wooden wares, tallow, skins, cattle, furs, corn and linseed. Large caravans descend the affluents of the Kama every spring, and reach the fairs of Laishev and Nizhnyi Novgorod, or descend the Volga to Samara and Astrakhan; while Ekaterinburg is an important centre for the trade with Siberia. The fairs at Irbit, second in importance only to that of Nizhnyi Novgorod, and Ivanov (in the district of Shadrinsk) are centres for supplying Siberia with groceries and manufactured wares, as also for the purchase of tea, of furs for Russia, and of corn and cattle for the mining districts. The chief commercial centres are Ekaterinburg, Irbit, Perm, Kamyslov, Shadrinsk and Cherdyn.

Perm is more largely provided with educational institutions and primary schools than most of the governments of central Russia. Besides the ecclesiastical seminary at Perm there is a mining school at Ekaterinburg. The Perm zemstvo or provincial council is one of the most active in Russia in promoting the spread of education and agricultural knowledge among the peasants.

The government is intersected by a railway from Perm eastwards across the Urals, and thence southwards along their eastern slope to Ekaterinburg, Chelyabinsk (main Siberian trunk line) and Tyumen; also by a railway from Perm to Kotlas, at the head of the Northern Dvina.

History.—Remains of palaeolithic man, everywhere very scarce in Russia, have not yet been discovered in the upper basins of the Kama and Ob, with the exception, perhaps, of a single human skull found in a cavern on the Chanva (basin of Kama), together with a skull of *Ursus spelaeus*. Neolithic remains are met with in immense quantities on both Ural slopes. Still larger quantities of implements belonging to an early Finnish, or rather Ugrian, civilisation are found everywhere in the basin of the Kama. Herodotus speaks of the richness of this country inhabited by the Ugrians, who kept up a brisk traffic with the Greek colony of Olbia near the mouth of the Dnieper, and with the Bosphorus by way of the Sea of Azov and the Volga. The precise period at which the Ugrians left the district for the southern steppes

of Russia (the *Lebedia* of Constantine Porphyrogenitus) is not known. In the 9th century, if not earlier, the Norsemen were acquainted with the country as Bjarmeland, and Byzantine annalists knew it as Permia. Nestor describes it as a territory of the Perm or Permlians, a Finnish people.

The Russians penetrated into this region at an early date. In the 11th century Novgorod levied tribute from the Finnish inhabitants, and undertook the colonization of the country, which in the treaties of the 13th century is dealt with as a separate territory of Novgorod. In 1471 the Novgorod colonies in Perm were annexed to Moscow, which in the following year erected a fort to protect the Russian settlers and traders against the Voguls, Ostiaks and Samoyedes. The mineral wealth of the country attracted the attention of the Moscow princes, and in the end of the 15th century Ivan III. sent two Germans to search for ores; these they succeeded in finding south of the upper Pechora. The Stroganovs in the 16th century founded the first salt- and ironworks, built forts, and colonized the Ural region. The rapidly-growing trade with Siberia gave a new impulse to the development of the country. This trade had its centres at Perm and Solikamsk, and later at Irbit.

(P. A. K.; J. T. Bz.)

PERM, a town of Russia, capital of the government of the same name, stands on the left bank of the Kama, on the great highway to Siberia, 1130 m. by rail and river N.E. from Moscow. Pop. (1879), 32,350; (1897), 45,403. During summer it has regular steam communication with Kazan, 605 m. distant, and it is connected by rail (311 m.) with Ekaterinburg on the east side of the Urals. The town is mostly built of wood, with broad streets and wide squares, and has a somewhat poor aspect, especially when compared with Ekaterinburg. It is the seat of a bishop of the Orthodox Greek Church, and has an ecclesiastical seminary and a military school, besides several scientific institutions (the Ural society of natural sciences, archives committee, technical society), and a scientific museum. Its industries develop but slowly, the chief works being ship-building yards, tanneries, chemical works, saw-mills, brickfields, copper foundries, machinery works, soap and candle factories and rope-works. The government has a manufactory of steel guns and munitions of war in the immediate neighbourhood of the town.

The present site of Perm was occupied, as early as 1568, by a settlement named Brukhanovo, founded by one of the Stroganovs; this settlement seems to have received the name of Perm in the 17th century. A copperworks was founded in the immediate neighbourhood in 1723, and in 1781 it received officially the name of Perm, and became an administrative centre both for the country and for the mining region.

PERMEABILITY, MAGNETIC, the ratio of the magnetic induction or flux-density in any medium to the inducing magnetic force. In the C.G.S. electromagnetic system of units the permeability is regarded as a pure number, and its value in empty space is taken as unity. The permeability of a metal belonging to the ferromagnetic class—iron, nickel, cobalt and some of their alloys—is a function of the magnetic force, and also depends upon the previous magnetic history of the specimen. As the force increases from zero the permeability of a given specimen rises to a maximum, which may amount to several thousands, and then gradually falls off, tending to become unity when the force is increased without limit. Every other substance has a constant permeability, which differs from unity only by a very small fraction; if the substance is paramagnetic, its permeability is a little greater than 1; if diamagnetic, a little less. The conception of permeability (Lat. *per*, through, and *meas*, to wander), is due to Faraday, who spoke of it as "conducting power for magnetism" (*Experimental Researches*, xrv.), and the term now in use was introduced by W. Thomson (Lord Kelvin), in 1872, having been suggested by a hydrokinetic analogy (*Reprint of Papers on Electrostatics and Magnetism*, xxxi., xlii.). It is generally of importance that the iron employed in the construction of electrical machinery should possess high permeability under the magnetic force to which it is to be subjected. (See ELECTROMAGNETISM and MAGNETISM.)

PERMEAMETER, an instrument for rapidly measuring the permeability of a sample of iron or steel with sufficient accuracy for many commercial purposes. The name was first applied by S. P. Thompson to an apparatus devised by himself in 1890, which indicates the mechanical force required to detach one end of the sample, arranged as the core of a straight electromagnet, from an iron yoke of special form; when this force is known, the permeability can be easily calculated. (See **MAGNETISM**.)

PERMIAN, in geology, the youngest and uppermost system of strata of the Palaeozoic series, situated above the Carboniferous and below the Trias. The term "Permian" (derived from the

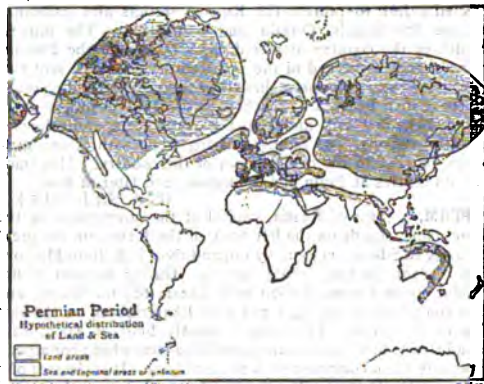

Russian province of Perm, where the rocks are extensively developed) was introduced in 1841 by Sir R. I. Murchison. In England the series of red sandstones, conglomerates, breccias and marls which overlie the Coal Measures were at one time grouped together in one great formation as the "New Red Sandstone," in contradistinction to the Old Red Sandstone below the Carboniferous; they were likewise known as the *Poikilitic series* (from Gr. ποικίλος, mottled) from their mottled or variegated colour. They are now divided into two systems or groups of formations; the lower portion being included in the Palaeozoic series under the name Permian, the upper portion being relegated to the Mesozoic series and termed Trias. In Germany the name *Dyas* was proposed by J. Märcou for the rocks of this age on account of the twofold nature of the series in Thuringia, Saxony, &c. The intimate stratigraphical relationship that exists in many quarters between the Permian rocks and the Carboniferous beds, and the practical difficulties in the way of drawing a satisfactory base-line to the system, have led to the adoption of the term *Permo-carboniferous*: in South Africa, southern Asia, America, Australia and Russia, for strata upon this horizon: C. W. von Gümbel used "Post-carbon" in this sense. In a similar manner *Permo-triassic* has been employed in cases where a stratigraphical passage from rocks with Permian fossils to others bearing a Triassic fauna is apparent.

The Permian system in England consists of the following subdivisions—

		W. of England.	E. of England.
3. Upper ...	Red sandstones, clays, and gypsum	600 ft.	50-100 ft.
2. Middle ..	Magnesian limestone Marl slate	10-30 "	600 "
1. Lower ...	Red and variegated sandstone Reddish-brown and purple sandstones and marls, with calcareous conglomerates and breccias of volcanic rocks.	3000 "	100-250 "

From the thicknesses here given it is evident that the Permian rocks have a very different development on the two sides of England. On the east side, from the coast of Northumberland southwards to the plains of the Trent, they consist chiefly of a great central mass of limestone. But on the west side of the Pennine Chain, and extending southwards into the central counties, the calcareous

zone disappears, and we have a great accumulation of red, arenaceous and gravelly rocks.

The lower subdivision attains its greatest development in the vale of the Eden, where it consists of brick-red sandstones, the Penrith sandstone series, with some beds of calcareous conglomerate or breccia, locally known as "brockram," derived from the waste of the Carboniferous Limestone. These red rocks extend across the Solway into the valleys of the Nith and Annan, in the south of Scotland, where they lie unconformably on the Lower Silurian rocks. Their breccias consist of fragments of the adjacent Silurian greywackes and shales, but near Dumfries some calcareous breccias or "brockrams" occur. These brecciated masses have evidently accumulated in small lakes or narrow fords. Much farther south, in Staffordshire, and in the districts of the Clent and Abberley Hills, the brecciated conglomerates in the Permian series attain a thickness of 400 ft. They have been shown by Sir A. C. Ramsay to consist in large measure of volcanic rocks, grits, slates and limestones, which can be identified with rocks on the borders of Wales. Some of the stones are 3 ft. in diameter and show distinct striation. The same writer pointed out that these Permian drift-beds cannot be distinguished by any essential character from modern glacial drifts; on the other hand, W. W. King and others have opposed this view.

The middle subdivision is the chief repository of fossils in the Permian system. Its strata are not red, but consist of a lower zone of hard brown shale with occasional thin limestone bands (Marl Slate) and an upper thick mass of dolomite (Magnesian Limestone). The latter is the chief feature in the Permian development of the east of England. It corresponds with the *Zechstein* of Germany, as the Marl Slate does with the *Kupfer-schiefer*. It is a very variable rock in its lithological characters, being sometimes dull, earthy, fine-grained and fossiliferous, in other places quite crystalline, and composed of globular, reniform, botryoidal, or other irregular concretions of crystalline and frequently internally radiated dolomite. Though the Magnesian Limestone runs as a thick persistent zone down the east of England, it is represented on the Lancashire and Cheshire side by bright red and variegated sandstone covered by a thin group of red marls, with numerous thin courses of limestone, containing *Schizodus*, *Bakerella* and other characteristic fossils of the Magnesian Limestone.

Concerning the rocks classed as Permian in the central counties of England there exists some doubt, for recent work tends to show that the lower parts are clearly related to the Carboniferous rocks by their fossils; while there is little evidence to warrant the exclusion of the higher beds from the Trias. Similarly in south Devon, where red sandstones and coarse breccias are well exposed, it has been found difficult to say whether the series should be regarded as Triassic or Permian, though the prevailing tendency is to retain them in the latter system.

The "Dyas" type of the system is found in enormous masses of strata flanking the Harz Mountains, and also in the Rhine provinces, Saxony, Thuringia, Bavaria and Bohemia. In general terms it may be said that in this region there is a lower sandy and conglomeratic subdivision with an upper one more calcareous; the former is known as the *Rothliegende*, the latter as the *Zechstein* group. On the south side of the Harz Mountains the following subdivisions are recognized:—

Group	Subdivision	Description
Zechstein Group.	Upper	Anhydrite, gypsum, rock-salt, dolomite, marl, fetid shale and limestone. The anorthous gypsum is the chief member of this group; the limestone is sometimes full of bitumen.
	Middle	Dolomite (<i>Haupt-dolomit</i>), crystalline granular (<i>Rauchwacke</i>), and fine powdery (<i>Asche</i>) with gypsum at bottom.
	Lower	Zechstein-limestone, an argillaceous, thin-bedded compact limestone 15 to 90 ft. thick. Kupfer-schiefer, a black bituminous-copper-bearing shale, not more than 2 ft. thick, often much less, but very constant.
Rothliegende Group.	Upper	Zechstein-conglomerate and calcareous sandstone. Red sandstones (<i>Kreuznach</i> beds), red shales (<i>Monsig</i> beds) with sheets of melaphyre tuff, and quartz-porphry-conglomerate (<i>Wadern, Oberhof, Solern</i> and <i>Tambach</i> beds). Sandstones and glomerates (<i>Tholayer</i> beds) on black shales with poor coal seams and clay ironstones (<i>Lebach</i> and <i>Goldammer</i> beds).
	Lower	Sandstones and shales with seams of coal on red and grey sandstones and shales with impure limestones (<i>Casal</i> beds, including <i>Manebach</i> beds, upper, and <i>Gehren</i> beds, lower).

The name *Rothliegende* or *Rothliegende* (red-dead-layer) was given by the miners because their ores disappeared in the red rocks below the copper-bearing *Kupfer-schiefer*. The *Kupfer-schiefer*, although so thin, has been worked in the Mansfeld district for a long period; it contains abundant remains of fish (*Palaeoniscus*, *Platysomus*) and plants (*Ullmannia*). The beds of rock-salt in the German Zechstein are of the greatest importance; at Spessberg near Berlin it has been penetrated to a depth of 4000 ft. Associated with the salt, gypsum and anhydrite are numerous

potassium and magnesium salts, including carnallite, kieserite and polyhalite, which are exploited at Staassfurt and are the only important potassium deposits known. Permian rocks of the Rothliegende type are scattered over a wide area in France, where the lower beds are usually conformable with the Coal Measures. In the upper beds occur the bituminous or "Boghead" shale of Autun. In Russia strata of this age cover an enormous area, in the Ural region, in the governments of Perm, Kasan, Kostroma, and in Armenia. The Russian Permian shows no sharp division into two series; the two types of deposit tend to be more mixed and include in addition some deposits of the more open sea. The general sequence begins with the *Artinsk* beds, sandy and marly or conglomeratic beds in close connexion with the Carboniferous, overlain by the *Kungur* limestones and dolomites; these are followed by red fresh-water sandstones, over which comes an important series of copper-bearing sandstones and conglomerates. Above this, in Kostroma, Vyatka and Kasan there is a calcareous and dolomitic series, the so-called "Russian Zechstein" with marine fossils; the uppermost beds are red marls, with few fresh-water fossils, the *Tartarian* beds.

The character of the fossils in the Permian of the Mediterranean and south-east Europe—well exemplified in the deposits of Sicily—together with their more generally calcareous nature, indicate a more open sea and more stable marine conditions than obtained farther north. This sea is traceable across south-east Russia into the middle of Asia, through Turkestan and Persia, into the Salt Range of India, where the *Productus* limestone may be taken as representative of the normal marine plan of Permian times. Southwards, however, of the Nerubudda River another and quite distinct continental assemblage of deposits holds the ground, viz. the lower portion of the great fresh-water Gondwana system. The coarse *Talchir conglomerates* at the base are succeeded by the sandstones and shales of the *Karharbari group*, with numerous coal seams, and these in turn are followed by the *Damuda series* (upwards of 10,000 ft.) of similar rocks, with ironstones and very valuable coal seams. All these strata are characterized by the presence of the *Glossopteris* flora. A similar succession of beds has been recorded in north-west Afghanistan. In close relationship with the lower members of the Indian Gondwana series, both as regards fossil contents and lithological characters, are the lower *Karoo beds* of South Africa (*Dwyka* conglomerate, *Ecca* shales and mudstones, *Beaufort* beds and *Kimberley shales*), also the coal-bearing beds of the *Transvaal*; the *Permian-Carboniferous* rocks of Australia (including the rich coal measures of Newcastle, the *Greta* coal measures and marine beds, upper and lower, of New South Wales; those of Tasmania, the *Bower River* beds of Queensland, and the *Bacchus Marsh* glacial beds of Victoria), and similar rocks in New Zealand (*Maitai* formation, south island; *Dun Mountain* limestone and *Rimutaka* beds of the north island) and South America. In North America Permian rocks occur in the east in Pennsylvania, West Virginia, Maryland and Ohio ("Upper Barren Measures"), and in Prince Edward Island, New Brunswick, where they succeed the Carboniferous rocks very regularly. West of the Mississippi, in Texas (7000 ft.), including the *Wichita* beds, *Clear Fork* and *Double Mountain* beds, Kansas and Nebraska, the Permian is more extensive and on the whole is more readily separable from the Carboniferous. Here the lower beds are marine and contain many limestones and dolomites; the higher beds are mainly red sand-

stones and marls with gypsum: in Texas it is of interest to note the occurrence of copper-stained strata. These upper "Red Beds" are often not clearly distinguishable from the *Texas*.

Life of the Permian Period.—The records of the plants and animals of this period are comparatively meagre. The plants show that a gradual change from the Carboniferous types was in progress. Two floral regions are clearly indicated, a northern and a southern. In the latter, which may be regarded as continuous with the continent of Gondwana, the *Lepidodendrons*, *Sigillarias*, *Calamites*, &c., of the Coal Measures gave place to a distinct flora, named from the prevalence of *Glossopteris*, the *Glossopteris* (tongue-fern) flora. Traces of this southern flora have been found in northern Russia. *Gangamopteris*, *Calopteris*, *Taeniopteris*, *Schiaopteris*, *Walchia*, *Valtsia*, *Ullmannia*, *Sporoptera*, *Baiera* are characteristic Permian genera. Among the larger animals amphibians occupied a prominent position, their footprints being very common in the sandstones; they include numerous Labyrinthodonts, *Archegosaurus*, *Stereosuchus*, *Branchiosaurus*. At this time the true reptiles began to leave their remains in the rocks; many highly interesting forms are known—*Palaeohatteria*, *Proterosaurus*, *Stereosernum*; others having certain mammalian characteristics include *Parotosaurus*, *Cynognathus*, *Dicynodon*. Among the fishes may be mentioned *Platysomus*, *Palaoniscus*, *Amylopterus*, *Plesurocaulus*. Turning to the invertebrates, undoubtedly the most interesting feature is gradual introduction into the Cephalopoda of the ammonite-like forms such as *Mediolithia*, *Waagenoceras*, *Popanoceras*, in place of the more simple lobed goniatites of the Carboniferous. Brachiopods (*Productus horridus*, *Bahenolia tumida*), Bryozoa and corals were by no means scarce in the more open Permian seas. *Schizodus Schlotheimii*, *Strophalosia Goldfussi*, *Myophoria*, *Leimysalinda*, *Bellerophon* are characteristic Permian mollusca. The last of the trilobites appears in the Permian of North America.

The evidence so far obtained indicates that in Permian times much of the land in the northern hemisphere was near the general sea-level, and that conditions of considerable aridity prevailed which involved the repeated isolation and evaporation of marine lagoons and land-locked seas. South of this region in Europe and Asia there extended an open "Mediterranean" sea, the "Tethys" of E. Suess; while over an enormous area in the southern hemisphere a great land area was spread, "Gondwana land," the land of the *Glossopteris* flora. At many points in this vast tract, as we have seen, coarse conglomeratic deposits, *Talchir*, *Dwyka*, *Bacchus Marsh*, &c., indicate profound glacial conditions, which some have thought were present also in Britain, Germany and elsewhere in the north. Moderate earth movements were taking place in North America, where the Appalachian and Ouachita mountains were in course of elevation, and in Europe this was a time of great volcanic activity. In the Saal region volcanic rocks in the lower Rothliegende have been penetrated for 1100 ft. without reaching the bottom, and elsewhere in central Europe great sheets of contemporaneous quartz porphyry, granite porphyry, melaphyre and porphyrite are abundant with their corresponding tufts. Melaphyres and tufts appear in the Voges, which in the south of France are enormous masses of melaphyre and quartz porphyry. Basic lavas and tufts—diabase, picrite, olivine basalt and andesite tufts—were erupted from many small vents in Ayrshire and the Nith basin, and basic lavas occur also in Devonshire. Volcanic rocks occur also in New Zealand, Sumatra and the *Transvaal*.

Table of Permian Strata, showing approximate correlations.

Stages.	Britain.	Saxony, Thuringia, Bohemia.	Basin of the Saar.	Alps.	Russia.	India.	North America.
Thuringian	Marls and gypsum Staassfurt Permian limestone. Marl slate.	Salt beds of Staassfurt. Zechstein limestones. Kupfer-schiefer.	Zechstein. Upper red sandstones, breccias and conglomerates.	Bellerophon limestone. Dolomites and shales of Neumarkt. Sandstones of Gröden.	Tartarian Marl. Cephalopod beds of Armenia. Copper-bearing sandstones in Ural region. Limestones and dolomites of Kostroma (Russian Zechstein). Kungur and Artinsk sandstones. Beds of Novaya Zembla and Spitzbergen.	Talchir beds. Karharbari group. (1) <i>Productus</i> limestone. <i>Dan</i> and <i>dot</i> group. <i>Limestone of Chitichan</i> .	Kansas. Kiger stage. Salt Fork stage. Double Mountain beds of Texas. Measures of Pennsylvania, Nova Scotia, New Brunswick.
Punjabian or Saxonian	Red sandstones, conglomerates, breccias and marls doubtfully assigned to this period. Volcanic rocks in Scotland and Devonshire.	Weisliegende. Tambach beds. Oberhöf beds. Goldlauter beds.	Red sandstones with eruptive rocks. The beds of Kreuznach, Wadern, Sötern, Tholey.	Verrucano. Fusulina limestones.		Part of Lower Gondwana equivalents in South Africa, Australasia and South America.	Wellington beds. Marion beds. Chase stage.
Artinskian (marine) or Autunian (continental)	Contemporaneous eruptive rocks.	Manebach beds. Brandschiefer beds of Wessig. Gehren beds. Braunau beds of Bohemia.	Rothliegende. Lebach beds. Cusel beds.	Verrucano.		Big Blue series. Red beds, Cimarron series.	Wichita beds. Upper-Barren Measures of Pennsylvania, Nova Scotia, New Brunswick.

PERMEAMETER — PERMIAN

R, an instrument for rapidly measuring the sample of iron or steel with sufficient accuracy for practical purposes. The name was first applied to an apparatus devised by himself in 1890, when he applied the mechanical force required to detach one end ranged as the core of a straight electromagnet, of special form; when this force is known, the permeability can be easily calculated. (See MAGNETISM.) In geology, the youngest and uppermost system of the Mesozoic series, situated above the Carboniferous series. The term "Permian" (derived from the



Permian rocks are introduced in 1841 by Sir R. I. Murchison. The series of red sandstones, conglomerates which overlie the Coal Measures were first named after them in one great formation as the Permian, in contradistinction to the Carboniferous; they were likewise named (from Gr. *permeios*, mottled colour). They are now divided into two formations; the lower part is called the Permian, and the upper part is called the Mesozoic series. The name *Dyas* was proposed by Murchison as a synonym of the Permian, &c. The Permian is found in many quarters of the world, especially in Asia, America, and Europe. The Permian is a similar system to other Permian systems.

zone disappears, and we have a zone of gravelly rocks. The lower subdivision at the vale of the Eden, where the Penrith sandstone series, or breccia, locally known as the Carboniferous L. of the Solway into the vale of Scotland, where the rocks. Their breccia greywackes and shales or breccians are accumulated in the hills in Staffordshire. The thickness of the Permian consists of sandstones, which are some of the same as those distinguished on the Permian zone.

(24 m.). All these lines are the capital of the state is Pernambuco. The state, but the census is those of the *municípios*. The most important are: Recife (240,000), Brejo da Madre de Deus (24,554), Goyanna (24,554), colonial capital and Timbaúba (9514) and

Christovão Jacques was that was after the settlement was made in four years later from the mouth of the Paraíba. Adjacent to Itamaracá, the remainder of the French settlement was able to move toward to their settlement and active part in the revolution. The Portuguese was expelled, and the proceedings of Dom Pedro I. revolution for the Federação do Equador. frequent disorders down other unsuccessful revolution. Pernambuco has always been noted for the population is concentrated, communication, and partly to the person has long been the refuge of criminals

Duchy-Washington
of Pernambuco, Brazil
of Pernambuco, Brazil

Indian corn, Mangrove, piassava fibre collected for export in Cotton-weaving and manufacturing industries, after Recife and São Francisco (77 m.), and Sul de Pernambuco (120 m.) since 1901. Besides these there are the Araripe and Timbaúba (112 m.), with an

Founded on the right side of the river in 1255 by one of the bishops of Oesel, Pernau soon became a flourishing place. In the 16th century it was occupied in succession by the Swedes, transferred the town to the left side of the river; and in 1648 the Swedes, who had been in possession since 1617, strengthened it with regular fortifications. In 1710 it was taken by the Russians, and the fortress is now demolished.

PERNE, ANDREW (c. 1519-1580), vice-chancellor of Cambridge University and dean of Ely, born about 1519, was son of John Perne of East Bilney, Norfolk. He was educated at St John's college, Cambridge, graduating B.A. in 1539, B.D. in 1547 and D.D. in 1552. He was elected fellow of Queens' in 1540, and vice-president in 1551, and was five times vice-chancellor; but he owes his notoriety to his remarkable versatility, and, like the vicar of Bray, he was always faithful to the national religion, whatever it might be. In April 1547 he advocated Catholic doctrines, but recanted two months later, and his

Protestant faith was strengthened during Edward VI.'s reign; he was appointed a royal chaplain and canon of Windsor. Soon after Mary's accession, however, he perceived the error of his ways and was made master of Peterhouse in 1554 and dean of Ely in 1557. He preached the sermon in 1556 when the bodies of Bucer and Fagius were disinterred and burnt for heresy, and also in 1560 when these proceedings were reversed and the dead heretics were rehabilitated. In Elizabeth's reign he subscribed the Thirty-nine Articles, denounced the pope and tried to convert Abbot Feckenham to Protestantism; and in 1584 Whitgift in vain recommended him for a bishopric. He died on the 26th of April 1589. He was selected as the type of Anglican prelate by the authors of the Martin Mar-prelate tracts and other Puritans, who nicknamed him "Old Andrew Turncoat," "Andrew Ambo," "Old Father Palinode." Cambridge wits, it was said, translated "perno" by "I turn, I rat, I change often"; and a coat that had often been turned was said to have been "perned." (A. F. P.)

PÉRONNE, a town of northern France, capital of an arrondissement of the department of Somme, on the right bank of the Somme at its confluence with the Cologne, 35 m. E. by N. of Amiens by rail. Pop. (1906), 3698. The church of St Jean (1509-1525) was greatly damaged during the bombardment of 1870-71, but has since been restored. The castle of Péronne still retains four large conical-roofed towers dating from the middle ages, one of which is said to have been the prison of Louis XI. in 1468, when he was forced to agree to the "Treaty of Péronne." Péronne has a sub-prefecture, a tribunal of first instance and a communal college. Its trade and industry are of little importance.

The Frankish kings had a villa at Péronne, which Clovis II. gave to Erchinoaldus, mayor of the palace. The latter founded a monastery here, and raised in honour of St Fursy a collegiate church, which was a wealthy establishment until the Revolution; it is the burial-place of Charles the Simple, who died of starvation in a dungeon in Péronne, into which he had been thrown by the count of Vermandois (929). After the death of Philip of Alsace, Péronne, which he had inherited through his wife, escheated to the French Crown in the reign of Philip Augustus, from whom in 1209 it received a charter. By the treaty of Arras (1435) it was given to the Burgundians; bought back by Louis XI., it passed again into the hands of Charles the Bold in 1465. On the death of Charles, however, in 1477, Louis XI. resumed possession. In 1536 the emperor Charles V. besieged Péronne, but without success; in its defence a woman called Marie Fouré greatly distinguished herself. A statue of her stands in the town; and the anniversary of the raising of the siege is still celebrated annually. It was the first town after Paris at which the League was proclaimed in 1577. Péronne's greatest misfortunes occurred during the Franco-German War. It was invested on the 27th of December 1870, and bombarded from the 28th to the 9th of the following January, upon which date, on account of the sufferings of the civil population, among whom small-pox had broken out, it was compelled to capitulate.

PEROVSKITE, or **PEROVSKITZ**, a mineral consisting of calcium titanate, CaTiO_3 , usually with a small proportion of the calcium replaced by iron. The crystals found in schistose rocks have the form of cubes, which are sometimes modified on the edges and corners by numerous small planes; on the other hand, the crystals occurring as an accessory constituent of eruptive rocks are octahedral in form and microscopic in size. Although geometrically cubic, the crystals are always doubly refracting, and they sometimes show evidence of complex mimetic twinning; their structure as shown in polarized light is very similar to that of the mineral boracite, and they are therefore described as pseudo-cubic. There are distinct cleavages parallel to the faces of the cube. The colour varies from pale yellow to blackish-brown and the lustre is adamantine to metallic; the crystals are transparent to opaque. The index of refraction is high, the hardness $5\frac{1}{2}$ and the specific gravity 4.0. The mineral was discovered at Achatovsk near Zlatoust in the Urals by G. Rose in 1839, and named in honour of Count L. A. Perovsky;

at this locality large cubes occur with calcite and magnetite in a chlorite-schist. Similar crystals are also found in talc-schist at Zermatt in Switzerland. The microscopic octahedral crystals are characteristic of mellilite basalt and nepheline basalt; they have also been found in peridotite and serpentine. (L. J. S.)

PEROWNE, JOHN JAMES STEWART (1823-1904), English bishop, was born, of Huguenot ancestry, at Burdwan, Bengal, on the 13th of March 1823. He was educated at Norwich and at Corpus Christi College, Cambridge, becoming a fellow in 1849. After holding a chair in King's College, London, he was appointed vice-principal at St David's College, Lampeter (1862-1872). In 1868 he was Hulsean lecturer, taking as his subject *Immortality*. He was elected canon of Llandaff in 1869, dean of Peterborough 1878, and in 1891 succeeded Henry Philpott as bishop of Worcester. Perowne was a good Hebrew scholar of the old type and sat on the Old Testament Revision Committee. He is best remembered as the general editor of the *Cambridge Bible for Schools and Colleges*. His chief works were a *Commentary on the Book of Psalms* (2 vols., 1864-1868) and a life of Bishop Thirlwall (1877-1878). He resigned his see in 1901, and died on the 6th of November 1904.

PERŪZ (*Peirosas*, Priscus, fr. 33; *Peroses*, Procop. *Pers.* i. 3 and Agath. iv. 27; the modern form of the name is Ferōz, Firuz, cf. FIRUZABAD), Sassanid king of Persia, A.D. 457-484, son of Yasdegerd II. He rebelled against his brother Homizd III., and in 459 defeated and killed him with the help of the Ephthalites, or White Huns, who had invaded Bactria. He also killed most of his other relatives, and persecuted the Christians. But he favoured the introduction of Nestorianism, in opposition to the orthodox creed of Byzantium. With the Romans he maintained peace, but he tried to keep down the Ephthalites, who began to conquer eastern Iran. The Romans supported him with subsidies; but all his wars were disastrous. Once he was himself taken prisoner and had to give his son Kavadh as hostage till after two years he was able to pay a heavy ransom. Then he broke the treaty again and advanced with a large army. But he lost his way in the eastern desert and perished with his whole army (484). The Ephthalites invaded and plundered Persia for two years, till at last a noble Persian from the old family of Karen, Zarmihr (or Sokhra), restored some degree of order. He raised Balash, a brother of Perōz, to the throne. (Ed. M.)

PERPENDICULAR PERIOD, the term given by Thomas Rickman to the third period of Gothic architecture in England, in consequence of the great predominance of perpendicular lines. In the later examples of the Decorated period the omission of the circles in the tracery had led to the employment of curves of double curvature which developed into flamboyant tracery, and the introduction of the perpendicular lines was a reaction in the contrary direction. The mullions of the windows (which are sometimes of immense size, so as to give greater space for the stained glass) are carried up into the arch mould of the windows, and the upper portion is subdivided by additional mullions. The buttresses and wall surface are likewise divided up into vertical panels. The doorways are frequently enclosed within a square head over the arch mouldings, the spandrels being fitted with quatrefoils or tracery. Inside the church the triforium disappears, or its place is filled with panelling, and greater importance is given to the clerestory windows which constitute the finest features in the churches of this period. The mouldings are flatter and less effective than those of the earlier periods, and one of the chief characteristics is the introduction of large elliptical hollows. The finest features of this period are the magnificent timber roofs, such as those of Westminster Hall (1395), Christ Church Hall, Oxford, and Crosby Hall.

The earliest examples of the Perpendicular period, dating from 1360, are found at Gloucester, where the masons of the cathedral would seem to have been far in advance of those in other towns. Among other buildings of note are the choir and tower of York Cathedral (1389-1407); the nave and western transepts of Canterbury Cathedral (1378-1411), and the tower

(towards the end of the 13th century); New College, Oxford (1380-1386); the Beauchamp Chapel, Warwick (1381-1391); the nave and aisles of Winchester Cathedral (1399-1419); the transept and tower of Merton College, Oxford (1424-1450); Manchester Cathedral (1422); the central tower of Gloucester Cathedral (1454-1457), and that of Magdalen College, Oxford (1475-1480). To those examples should be added the towers at Wrexham, Coventry, Evesham, and St Mary's at Taunton, the first being of exceptional magnificence.

PERPENT, or PARPENT STONES, in architecture, bond or "through stones," the *δαρῶνος* of the Greeks and Romans, long stones going right through walls, and tying them together from face to face. The O. Fr. *parpain*, modern *parpaing*, from which this word is derived, is obscure in origin. It may be from a supposed Lat. *perpago*, *perpaginis*, formed like *compago*, a joint, from the root of *paragere*, to fasten, and meaning "something fastened together," or from some popular corruption of Lat. *perpendicularum*, plummet or plumb-line (*pir* or *pendere*, to hang), referring to the smooth perpendicular faces of the stone.

PERPETUAL MOTION, or PERPETUUM MOBILE, in its usual significance, not simply a machine which will go on moving for ever, but a machine which, once set in motion, will go on doing useful work without drawing on any external source of energy, or a machine which in every complete cycle of its operation will give forth more energy than it has absorbed. Briefly, a perpetual motion usually means a machine which will create energy.

The earlier seekers after the "perpetuum mobile" did not always appreciate the exact nature of their quest; for we find among their ideals a clock that would periodically rewind itself, and thus go without human interference as long as its machinery would last. The energy created by such a machine would simply be the work done in overcoming the friction of its parts, so that its projectors might be held merely to have been ignorant of the laws of friction and of the dynamic theory of heat. Most of the perpetual motionists, however, had more practical views, and explicitly declared the object of their inventions to be the doing of useful work, such as raising water, grinding corn, and so on. Like the exact quadrature of the circle, the transmutation of metals and other famous problems of antiquity, the perpetual motion has now become a venerable paradox. Still, like these others, it retains a great historical interest. Just as some of the most interesting branches of modern pure mathematics sprang from the problem of squaring the circle, as the researches of the alchemists developed into the science of modern chemistry, so, as the result of the vain search after the perpetual motion, there grew up the greatest of all the generalizations of physical science, the principle of the conservation of energy.

There was a time when the problem of the perpetual motion was one worthy of the attention of a philosopher. Before that analysis of the action of ordinary machines which led to the laws of dynamics, and the discussion of the dynamical interdependence of natural phenomena which accompanied the establishment of the dynamical theory of heat, there was nothing plainly unreasonable in the idea that work might be done by the mere concatenation of machinery. It had not then been proved that energy is uncreatable and indestructible in the ordinary course of nature; even now that proof has only been given by induction from long observation of facts. There was a time when wise men believed that a spirit, whose maintenance would cost nothing, could by magic art be summoned from the deep to do his master's work; and it was just as reasonable to suppose that a structure of wood, brass and iron could be found to work under like conditions. The disproof is in both cases alike. No such spirit has ever existed, save in the imagination of his describer, and no such machine has ever been known to act, save in the fancy of its inventor.

The principle of the conservation of energy, which in one sense is simply denial of the possibility of a perpetual motion, rests on facts drawn from every branch of physical science; and, although its full establishment only dates from the middle of the

19th century, yet so numerous are the cases in which it has been tested, so various the deductions from it that have been proved to accord with experience, that it is now regarded as one of the best-established laws of nature. Consequently, on any one who calls it in question is thrown the burden of proving his case. If any machine were produced whose source of energy could not at once be traced, a man of science (complete freedom of investigation being supposed) would in the first place try to trace its power to some hidden source of a kind already known; or in the last resort he would seek for a source of energy of a new kind and give it a new name. Any assertion of creation of energy by means of a mere machine would have to be authenticated in many instances, and established by long investigation, before it could be received in modern science. The case is precisely as with the law of gravitation; if any apparent exception to this were observed in the case of some heavenly body, astronomers, instead of denying the law, would immediately seek to explain the occurrence by a wider application of it, say by including in their calculations the effect of some disturbing body hitherto neglected. If a man likes to indulge the notion that, after all, an exception to the law of the conservation of energy may be found, and, provided he submits his idea to the test of experiment at his own charges without annoying his neighbours, all that can be said is that he is engaged in an unpromising enterprise. The case is otherwise with the projector who comes forward with some machine which claims by the mere ingenuity of its contrivance to multiply the energy supplied to it from some of the ordinary sources of nature and sets to work to pester scientific men to examine his supposed discovery, or attempts therewith to induce the credulous to waste their money. This is by far the largest class of perpetual-motion-mongers nowadays. The interest of such cases is that attaching to the morbid anatomy of the human mind. Perhaps the most striking feature about them is the woful sameness of the symptoms of their madness. As a body perpetual-motion seekers are ambitious, lovers of the short path to wealth and fame, but wholly superficial. Their inventions are very rarely characterized even by mechanical ingenuity. Sometimes indeed the inventor has simply bewildered himself by the complexity of his device; but in most cases the machines of the perpetual motionist are of child-like simplicity, remarkable only for the extraordinary assertions of the inventor concerning them. Wealth of ideas there is none; simply assertions that such and such a machine solves the problem, although an identical contrivance has been shown to do no such thing by the brutal test of standing still in the hands of many previous inventors. Hosts of the seekers for the perpetual motion have attacked their insoluble problem with less than a schoolboy's share of the requisite knowledge; and their confidence as a rule is in proportion to their ignorance. Very often they get no further than a mere prospectus, on the strength of which they claim some imaginary reward, or offer their precious discovery for sale; sometimes they get the length of a model which wants only the last perfection (already in the inventor's brain) to solve the great problem; sometimes fraud is made to supply the motive power which their real or pretended efforts have failed to discover.

It was no doubt the barefaced fallacy of most of the plans for perpetual motion that led the majority of scientific men to conclude at a very early date that the "perpetuum mobile" was an impossibility. We find the Paris Academy of Sciences refusing, as early as 1775, to receive schemes for the perpetual motion, which they class with solutions of the duplication of the cube, the trisection of an angle and the quadrature of the circle. Stevinus and Leibnitz seem to have regarded its impossibility as axiomatic; and Newton at the beginning of his *Principia* states, so far as ordinary mechanics are concerned, a principle which virtually amounts to the same thing.

The famous proof of P. De la Hire simply refers to some of the more common gravitational perpetual motions. The truth is, as we have said already, that, if proof is to be given, or considered necessary, it must proceed by induction from all physical phenomena.

It would serve no useful purpose here to give an exhaustive historical account of the vagaries of mankind in pursuit of the "perpetuum mobile." The reader may refer to Henry Dircks's *Perpetuum Mobile* (2 vols., 1861 and 1870), from which, for the most part, we select the following facts.

By far the most numerous class of perpetual motions is that which seeks to utilize the action of gravity upon rigid solids. We have not read of any actual proposal of the kind, but the most obvious thing to imagine in this way would be to procure some substance which intercepts gravitational attraction. If this could be had, then, by introducing a plate of it underneath a body while it was raised, we could elevate the body without doing work; then, removing the plate, we could allow the body to fall and do work; eccentrics or other imposing device being added to move the gravitation intercepter, behold a perpetual motion complete! The great difficulty is that no one has found the proper material for an intercepter.

Fig. 1 represents one of the most ancient and oft-repeated of gravitational perpetual motions. The idea is that the balls rolling in the compartments between the felloe and the rim of the wheel will, on the whole, so comport themselves that the moment about the centre of those on the descending side exceeds the moment of those on the ascending side. Endless devices, such as curved spokes, levers with elbow-joints, eccentrics, &c., have been proposed for effecting this impossibility. The student of dynamics at once convinces himself that no machinery can effect any such result; because if we give the wheel a complete turn, so that each ball returns to its original position, the whole work done by equal that done on it. We know, that if the laws of motion be true, in each step the kinetic energy given to the whole system of wheel and balls is equal to that taken from the potential energy of the balls less what is dissipated in the form of heat by frictional forces, or vice versa, if the wheel and balls be losing kinetic energy—save that the friction in both cases leads to dissipation. So that, whatever the system may lose, it can, after it is left to itself, never gain energy during its motion.

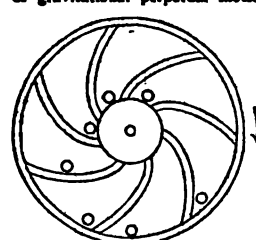

FIG. 1.

The two most famous perpetual motions of history, the wheels of the marquis of Worcester (d. 1667) and of Vicencior Orffyreus, were probably of this type. The marquis of Worcester gives the following account of his machine in his *Century of Inventions* (art. 56):—

"To provide and make that all the Weights of the descending side of a Wheel shall be perpetually further from the Centre than those of the mounting side, and yet equal in number and belt to one side as the other. A most incredible thing, if not seen but tried before the late king (of blessed memory) in the Tower, by my directions, two Extraordinary Embassadors accompanying His Majesty, and the Duke of Richmond, and Duke Hamilton, with most of the Court, attending him. The Wheel was 14. Foot over, and 40. Weights of 50. pounds apiece. Sir William Balfore, then Lieutenant of the Tower, can justify it, with several others. They all saw that no sooner these great Weights passed the Diameter-line of the lower side, but they hung a foot further from the Centre, nor no sooner passed the Diameter-line of the upper side but they hung a foot nearer. Be pleased to judge the consequence."

"We may here notice, so far as more recent times are concerned, the claim of an American enthusiast, who, having worked a Hampson plant for liquefying air, stated that 3 lb of liquid air sufficed to liquefy ten, and of these ten seven could be employed as a source of motive power, whilst the remaining three could be utilised in the production of another 10 lb of the liquid gas. There was thus available an inexhaustible supply of energy! The absurdity of the proposition is obvious to any one acquainted with the laws of thermodynamics. Of more interest is the radium clock devised by the Hon. R. J. Strutt. This consists of a vacuum vessel from the top of which depends a short tube containing a fragment of a radioactive substance. At the lower end of this tube there are two gold leaves as in an electroscope. Fused into the sides of the vacuum vessel at points where the extended gold leaves touch the glass are two platinum wires, the outer ends of which are earthed. The "clock" acts as follows. The radio-active substance emits a preponderating number of positively electrified particles, so that the leaves become charged and hence extended. On contact with the wires fused into the vessel, this charge is conducted away and the leaves fall together. The process is then repeated, and will continue until all the energy of the radium has been dissipated. This period is extremely long, for 1000 years must elapse before even half the radium has disappeared. [—E.D.]

Orffyreus (whose real name was Johana Ernst Elias Bessler) (1680-1745) also obtained distinguished patronage for his invention. His last wheel, for he appears to have constructed more than one, was 12 ft. in diameter and 1 ft. 2 in. broad; it consisted of a light framework of wood, covered in with oilcloth so that the interior was concealed, and was mounted on an axle which had no visible connexion with any external work. It was examined and approved of by the landgrave of Hesse-Cassel, in whose castle at Weissenstein it is said to have gone for eight weeks in a sealed room. The most remarkable thing about this machine is that it evidently imposed upon the mathematician W. J. 'sGravesande, who wrote a letter to Newton giving an account of his examination of Orffyreus's wheel undertaken at the request of the landgrave, wherein he professes himself dissatisfied with the proofs theretofore given of the impossibility of perpetual motion, and indicates his opinion that the invention of Orffyreus is worthy of investigation. He himself, however, was not allowed to examine the interior of the wheel. The inventor seems to have destroyed it himself. One story is that he did so on account of difficulties with the landgrave's government as to a licence for it; another that he was annoyed at the examination by 'sGravesande, and wrote on the wall of the room containing the fragments of his model that he had destroyed it because of the impertinent curiosity of 'sGravesande.

The overbalancing wheel perpetual motion seems to be as old as the 13th century. Dircks quotes an account of an invention by Wilars de Honcourt, an architect whose sketchbook is still preserved in the Ecoles des Chartes at Paris. De Honcourt says, "Many a time have skilful workmen tried to contrive a wheel that shall turn of itself; here is a way to do it by means of an uneven number of mallets, or by quicksilver." He thereupon gives a rude sketch of a wheel with mallets jointed to its circumference. It would appear from some of the manuscripts of Leonardo da Vinci that he had worked with similar notions.

Another scheme of the perpetual motionist is a water-wheel which shall feed its own mill-stream. This notion is probably as old as the first miller who experienced the difficulty of a dry season. One form is figured in the *Mathematical Magic* (1648) of Bishop Wilkins (1614-1672); the essential part of it is the water-screw of Archimedes, which appears in many of the earlier machines of this class. Some of the later ones dispense with even the subtlety of the water-screw, and boldly represent a water-wheel pumping the water upon its own buckets.

Perpetual motions founded on the hydrostatical paradox are not uncommon; Denis Papin exposes one of these in the *Philosophical Transactions* for 1685. The most naive of these devices is that illustrated in fig. 2, the idea of which is that the larger quantity of water in the wider part of the vessel weighing more will overbalance the smaller quantity in the narrower part, so that the water will run over at C, and so on continually.

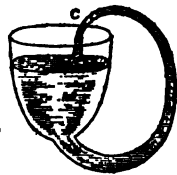

FIG. 2.

Capillary attraction has also been a favourite held for the vain quest; for, if by capillary action fluids can be made to disobey the law of never rising above their own level, what so easy as thus to produce a continual ascent and overflow, and thus perpetual motion? Various schemes of this kind, involving an endless band which should raise more water by its capillary action on one side than on the other, have been proposed. The most celebrated is that of Sir William Congreve (1772-1828). EFG (fig. 3) is an inclined plane over pulleys; at the top and bottom travels an endless band of sponge, *abcd*, and over this again an endless band of heavy weights jointed together. The whole stands over the surface of still water. The capillary action raises the water in *ab*, whereas the same thing cannot happen in the part *cd*, since the weights squeeze the water out. Hence, inch for inch, *ab* is heavier than *cd*; but we know that if *ab* were only just as heavy inch for inch as *cd* there would be equilibrium, if the heavy chain be also uniform; therefore the extra weight of *ab* will cause the chain to move round in the direction of the arrow, and this will go on continually.

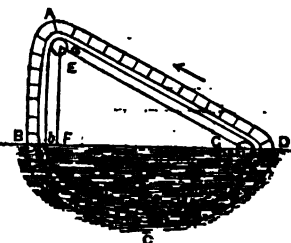

FIG. 3.

The more recondite vehicles of energy, such as electricity and magnetism, are more seldom drawn upon by perpetual-motion inventors than might perhaps be expected. William Gilbert, in his treatise *De Magnete*, alludes to some of them, and Bishop Wilkins mentions among others a machine "wherein a loadstone is so disposed

that it shall draw unto it on a refined plane a bullet of steel, which, still, as it ascends near to the loadstone, may be contrived to fall through some hole in the plane and so to return unto the place whence at first it began to move, and being there, the loadstone will again attract it upwards, till, coming to this hole, it will fall down again, and so the motion shall be perpetual." The fact that screens do exist whereby electrical and magnetic action can be cut off would seem to open a door for the perpetual-motion seeker. Unfortunately the bringing up and removing of these screens involves in all cases just that gain or loss of work which is demanded by the law of the conservation of energy. A shoemaker of Lanthryhow called Spence pretended that he had found a black substance which intercepted magnetic attraction and repulsion, and he produced two machines which were moved, as he asserted, by the agency of permanent magnets, thanks to the black substance. The fraud was speedily exposed, but it is worthy of remark that Sir David Brewster thought the thing worth mentioning in a letter to the *Annales de chimie* (1818), wherein he states "that Mr Playfair and Captain Kater have inspected both of these machines and are satisfied that they resolve the problem of perpetual motion."

The present writer once was sent an elaborate drawing of a locomotive engine which was to be worked by the agency of permanent magnets. He forgets the details, but it was not so simple

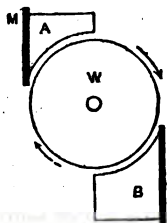

FIG. 4.

cylinders on equal bases will be in the inverse ratio of L to G. (2) Accordingly, if the height AC of one fluid, contained in the vase AD, be in this ratio to the height EF of the other liquid, which is in a tube open at both ends, the liquids so placed will remain at rest. (3) Wherefore, if AC be to EF in a greater ratio than L to G, the liquid in the tube will ascend; or if the tube be not sufficiently long the liquid will overflow at the orifice E (this follows from hydrostatic principles). (4) It is possible to have two liquids of different density that will mix. (5) It is possible to have a filter, colander, or other separator, by means of which the lighter liquid mixed with the heavier may be separated again therefrom.

Construction.—These things being presupposed (says Bernoulli), I thus construct a perpetual motion. Let there be taken in any

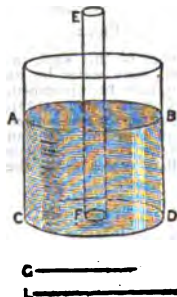

FIG. 5.

(by constr.) which separates the lighter liquid from the heavier, it follows that, if the tube be immersed to the bottom of the vessel, the lighter liquid alone which is mixed with the heavier ought to rise through the filter into the tube, and that, too, higher than the surface of the surrounding liquid (by hyp. 2), so that AC:EF > 2L:G+L; but since by constr. AC:EF > 2L:G+L it necessarily follows (by hyp. 3) that the lighter liquid will flow over by the orifice E into the vessel below, and there will meet the heavier, and be again mixed with it; and it will then penetrate the filter, again ascend the tube, and be a second time driven through the upper orifice. Thus, therefore, will the flow be continued for ever—Q. E. D.

Bernoulli then proceeds to apply this theory to explain the perpetual rise of water to the mountains, and its flow in rivers to the

sea, which others had falsely attributed to capillary action—his idea being that it was an effect of the different densities of salt and fresh water.

One really is at a loss with Bernoulli's wonderful theory, whether to admire most the conscientious statement of the hypothesis, the prim logic of the demonstration, so carefully cut according to the pattern of the ancients, or the weighty superstructure built on so frail a foundation. Most of our perpetual motions were clearly the result of too little learning; surely this one was the product of too much. (G. CH.)

PERPETUITY (Lat. *perpetuus*, continuous), the state of being perpetual or continuing for an indefinite time; in law the tying-up of an estate for a lengthened period, for the purpose of preventing or restricting alienation. As being opposed to the interest of the state and individual effort, the creation of perpetuities has been considerably curtailed, and the rule against perpetuities in the United Kingdom now forbids the making of an executory interest unless beginning within the period of any fixed number of existing lives and an additional period of twenty-one years (with a few months added, if necessary, for the period of gestation). The rule applies to dispositions of personal property (see ACCUMULATION) as well as of real property. There are certain exceptions to the rule, as in the case of limitations in mortmain and to charitable uses, and also in the case of a perpetuity created by act of parliament (e.g. the estate of Blenheim, settled on the duke of Marlborough, and Stratfieldsaye on the duke of Wellington). In the United States the English common-law rule against perpetuities obtains in many of the states; in others it has been replaced or reinforced by statutory rules (see Gray on Alienation, § 42). Charities may be established in perpetuity, and provision may be made for an accumulation of the funds for a reasonable time, e.g. for 100 years (*Woodruff v. Marsh*, 63 Conn. Rep. 125; 38 Amer. St. Rep. 346). The general tendency of American legislation is to favour tying up estates to a greater extent than was formerly approved.

PERPIGNAN, a town of south-western France, capital of the department of Pyrénées-Orientales, on the right bank of the Têt, 7 m. from the Mediterranean and 42 m. S. by W. of Narbonne by rail. Pop. (1906), town, 32,683; commune, 38,898. The north-west quarter of the town is traversed by the Basse, a tributary of the Têt, while to the south it is overlooked by a citadel enclosing a castle (13th century) of the kings of Majorca. The chapel is remarkable as being a mixture of the Romanesque, Pointed and Moorish styles. The ramparts surrounding the citadel are the work of Louis XI., Charles V. and Vauban. The sculptures and caryatides still to be seen on the gateway of the citadel were placed there by the duke of Alva. The cathedral of St Jean was begun in 1324 and finished in 1509. The most noteworthy feature in the building is an immense reredos of white marble (early 17th century) by Bartholomew Soler of Barcelona.

In the north of the town commanding the gateway of Notre-Dame (1481) there stands a curious machicolated stronghold known as the Castillet (14th and 15th centuries), now used as a prison. The buildings of the old university (18th century) contain the library and the museum, the latter possessing the first photographic proofs executed by Daguerre and a collection of sculptures and paintings. Statues of François Arago, the astronomer, and Hyacinthe Rigoud, the painter, stand in the squares named after them.

Perpignan is a fortified place of the first class, and seat of a prefect, a bishop and a court of assizes, and has tribunals of first instance and of commerce, a chamber of commerce, a branch of the Bank of France, a communal college for boys, a school of music and training colleges for both sexes. The higher tribunal of Andovic sits at Perpignan. Trade is in wine, iron, wool, oil, corks and leather.

Perpignan dates at least from the 10th century. In the 11th and 12th centuries it was a capital of the counts of Roussillon, from whom it passed in 1172 to the kings of Aragon. Philip the Bold, king of France, died there in 1285, as he was returning from an unsuccessful expedition into Aragon. At that time it belonged to the kingdom of Majorca, and its sovereigns resided there until, in 1344, that small state reverted to the possession of the

kings of Aragon, who in 1349 founded a university at Perpignan. When Louis XI. occupied Roussillon as security for money advanced by him to the king of Aragon, Perpignan resisted the French arms for a considerable time, and only yielded through stress of famine (March 15, 1475). Roussillon was restored to Aragon by Charles VIII. and Perpignan was again besieged in 1542 under Francis I., but without success. Later on, however, the inhabitants, angered by the tyranny and cruelty of the Spanish governor, surrendered the town to Louis XIII. The citadel held out until the 9th of September 1642, and the place has ever since belonged to France, to which it was formally ceded by the treaty of the Pyrenees (1659). In 1602 the bishopric of Elne was transferred to Perpignan.

See P. Vibal, *Perpignan depuis les origines jusqu'à nos jours* (Paris, 1898).

PERQUISITE (Lat. *perquisitum*, that which has been acquired by careful search; *perquisire*, to search diligently), a term properly used of the profits which accrue to the holder of an office over and above the regular emoluments; also, in law, the casual profits, such as accrue by heriots, fines, reliefs, &c., to a lord of a manor above the yearly revenue from the copyhold. The word is used generally of the casual profits allowed by custom to servants or other employes from superfluous articles which the employer has enjoyed the use of or which are supposed not to be needed.

FERRAULT, CHARLES (1628-1703), French author, was born in Paris on the 12th of January 1628. His father, Pierre Ferrault, was a barrister, all of whose four sons were men of some distinction: Claude (1613-1688), the second, was by profession a physician, but became the architect of the Louvre, and translated Vitruvius (1673). Charles was brought up at the Collège de Beauvais, until he chose to quarrel with his masters, after which he was allowed to follow his own bent in the way of study. He took his degree of *licencié en droit* at Orleans in 1651, and was almost immediately called to the Paris bar, where, however, he practised for a very short time. In 1654 his brother became receiver-general of Paris, and made Charles his clerk. After nearly ten years of this employment he was, in 1663, chosen by Colbert as his secretary to assist and advise him in matters relating to the arts and sciences, not forgetting literature. He was controller-general of the department of public works, member of the commission that afterwards developed into the *Académie des inscriptions*, and in 1671 he was admitted to the *Académie française*. Ferrault justified his election in several ways. One was the orderly arrangement of the business affairs of the Academy, another was the suggestion of the custom of holding public *séances* for the reception of candidates. Colbert's death in 1683 put an end to Ferrault's official career, and he then gave himself up to literature, beginning with *Saint Paulin évêque de Nole, avec une épitre chrétienne sur la pénitence, et une ode aux nouveaux convertis*. The famous dispute of the ancients and moderns arose from a poem on the *Sicèle de Louis le Grand* (1687), read before the Academy by Ferrault, on which Boileau commented in violent terms. Ferrault had ideas and a will of his own, and he published (4 vols., 1688-1696) his *Parallèle des anciens et des modernes*. The controversy that followed in its train raged hotly in France, passed thence to England, and in the days of Antoine Houdart de la Motte and Fénelon broke out again in the country of its origin. As far as Ferrault is concerned he was inferior to his adversaries in learning, but decidedly superior to them in wit and politeness.

It is not known what drew Ferrault to the composition of the only works of his which are still read, but the taste for fairy stories and Oriental tales at court is noticed by Mme de Sevigné in 1676, and at the end of the 17th century gave rise to the fairy stories of Mlle L'Héritier de Villandon, whose *Bigarrures ingénieuses* appeared in 1696, of Mme d'Aulnoy and others, while Antoine Galland's translation of the *Thousand-and-One Nights* belongs to the early years of the 18th century. The first of Ferrault's contes, *Grisélidis*, which is in verse, appeared in 1691, and was reprinted with *Peas d'âne* and *Les Sombats ridicules*, also in verse, in a *Recueil de pièces curieuses*—published at the

Hague in 1694. But Perrault was no poet, and the merit of these pieces is entirely obscured by that of the prose tales, *La Belle au bois dormant*, *Petit chaperon rouge*, *La Barbe bleue*, *Le Chat botté*, *Les Fées*, *Cendrillon*, *Riquet à la houppe* and *Le Petit ponceau*, which appeared in a volume with 1697 on the title-page, and with the general title of *Histoires ou contes du temps passé avec des moralités*. The frontispiece contained a placard with the inscription, *Contes de ma mère l'oisie*. In 1876 Paul Lacroix attributed the stories to the authorship of Perrault's son, P. Darmaucour, who signed the dedication, and was then, according to Lacroix, nineteen years old. Andrew Lang has suggested that the son was a child, not a young man of nineteen, that he really wrote down the stories as he heard them, and that they were then edited by his father. This supposition would explain the mixture of naïveté and satire in the text. Perrault's other works include his *Mémoires* (in which he was assisted by his brother Claude), giving much valuable information on Colbert's ministry; an *Essai travestie* written in collaboration with his two brothers, and *Les Hommes illustres qui ont paru en France pendant ce siècle* (2 vols., 1696-1700). He died on the 16th of May 1703, in Paris. His son, Perrault d'Armaucourt, was the author of a well-known book, *Contes des fées*, containing the story of Cinderella, &c.

Except the tales, Perrault's works have not recently been reprinted. Of these there are many modern editions, e.g. by Paul Lacroix (1876), and by A. Lefebvre ("Nouvelle collection Jaquet," 1875); also Perrault's *Popular Tales* (Oxford, 1888), which contains the French text edited by Andrew Lang, with an introduction, and an examination of the sources of each story. See also Hippolyte Rigault, *Hist. de la querelle des anciens et des modernes* (1856).

FERRERS (or DE WINNOR), ALICE (d. 1400), mistress of the English king Edward III., belonged probably to the Hertfordshire family of Ferrers, although it is also stated that she was of more humble birth. Before 1366 she had entered the service of Edward's queen, Philippa, and she appears later as the wife of Sir William de Windsor, deputy of Ireland (d. 1384). Her intimacy with the king began about 1366, and during the next few years she received from him several grants of land and gifts of jewels. Not content with the great influence which she obtained over Edward, Alice interfered in the proceedings of the courts of law to secure sentences in favour of her friends, or of those who had purchased her favour; actions which induced the parliament of 1376 to forbid all women from practising in the law courts. Alice was banished, but John of Gaunt, duke of Lancaster, allowed her to return to court after the death of Edward the Black Prince in June 1376, and the parliament of 1377 reversed the sentence against her. Again attempting to pervert the course of justice, she was tried by the peers and banished after the death of Edward III. in June 1377; but this sentence was annulled two years later, and Alice regained some influence at court. Her time, however, was mainly spent in lawsuits, one being with William of Wykeham, bishop of Winchester, and another with her dead husband's nephew and heir, John de Windsor.

FERRON, PIERRE CULLIAER (1755-1834), French military adventurer in India, whose name was originally Pierre Cullier, was born in 1755 at Château du Loire in France, the son of a cloth merchant. In 1780 he went out to India as a sailor on a French frigate, deserted on the Malabar coast, and made his way to upper India, where he enlisted in the rana of Gohad's corps under a Scotsman named Sangster. In 1790 he took service under De Boigne, and was appointed to the command of his second brigade. In 1795 he assisted to win the battle of Kardla against the nizâm of Hyderabad, and on De Boigne's retirement became commander-in-chief of Sindhia's army. At the battle of Malpura (1800) he defeated the Rajput forces. After the defeat of Ujjain (1801) he refused to send his troops to the aid of Sindhia. His treachery on this occasion shook his position, and on the outbreak of war between Sindhia and the British in 1803 Ferron was superseded and fled to the British camp. In the battles of Delhi, Laswari and Assaye, Ferron's battalions were completely destroyed by Lord Lake and

Sir Arthur Wellesley. He returned to France with a large fortune, and died in 1834.

See H. Compton, *European Military Adventurers of Hindustan* (1892).

PERRON (a French word meaning properly a "large stone," Ital. *petrone*, from Lat. *petra*, Fr. *pierre*, stone), in architecture, a term applied to a raised platform reached by steps in front of the entrance to a building. The grand flight of external steps entering the mansions of the medieval nobility or high officials was considered in itself a mark of jurisdiction, as it is said that sentence was there pronounced against criminals, who were afterwards executed at the foot of the steps—as at the Giant's Stairs of the Doge's palace at Venice.

PERRONE, GIOVANNI (1794–1876), Italian theologian, was born at Chieri (Piedmont) in 1794. He studied theology at Turin, and in his twenty-first year went to Rome, where he joined the Society of Jesus. In 1816 he was sent as professor of theology to Orvieto, and in 1823 was appointed to a similar post in the Collegium Romanum. From Ferrara, where he was rector of the Jesuit College after 1830, he returned to his teaching work in Rome, being made head of his old college in 1850. He took a leading part in the discussions which led up to the promulgation of the dogma of the Immaculate Conception (1854), and in 1869 was prominent on the Ultramontane side in the Vatican Council. His numerous dogmatic works are characteristic of orthodox modern Roman theology. They include *Prælectiones theologice* (9 vols., Rome, 1835 sqq.), *Prælectiones theologice in compendium redactæ* (4 vols., Rome, 1845), *Il Hermesianismo* (Rome, 1838), *Il Protestantismo e la regola di fede* (3 vols., 1853), *De divinitate D. N. Jesu Christi* (3 vols., Turin, 1870). He died on the 26th of August 1876.

PERROT, SIR JOHN (c. 1527–1592), lord deputy of Ireland, was the son of Mary Berkeley, who afterwards married Thomas Perrot, a Pembrokeshire gentleman. He was generally reputed to be a son of Henry VIII., and was attached to the household of William Paulet, 1st marquis of Winchester. He was in this way brought to the notice of Henry VIII., who died, however, before fulfilling his promises of advancement, but Perrot was knighted at the coronation of Edward VI. During Mary's reign he suffered a short imprisonment on the charge of harbouring his uncle, Robert Perrot, and other heretics. In spite of his Protestantism he received the castle and lordship of Carew in Pembrokeshire, and at the beginning of Elizabeth's reign he was entrusted with the naval defence of South Wales. In 1570 Perrot reluctantly accepted the newly created post of lord president of Munster. He landed at Waterford in February of the next year, and energetically set about the reduction of the province. In the course of two years he hunted down James Fitzmaurice Fitzgerald, whose submission he received in 1572. Perrot resented the reinstatement of Gerald Fitzgerald, 15th earl of Desmond, and after vainly seeking his own recall left Ireland without leave in July 1573, and presenting himself at court was allowed to resign his office, in which he was succeeded by Sir William Drury. He returned to his Welsh home, where he was fully occupied with his duties as vice-admiral of the Welsh seas and a member of the council of the marches. Although in 1578 he was accused by the deputy-admiral, Richard Vaughan, of tyranny, subversion of justice and of dealings with the pirates, he evidently retained the royal confidence, for he was made commissioner for piracy in Pembrokeshire in 1578, and in the next year was put in command of a squadron charged to intercept Spanish ships on the Irish coast.

The recall of Arthur Grey, Lord Grey de Wilton, in 1582, left vacant the office of lord deputy of Ireland, and Perrot was appointed to it early in 1584. Sir John Norris became lord president of Munster, and Sir Richard Bingham went to Connaught. Perrot's chief instructions concerned the plantation of Munster, where the confiscated estates, some 600,000 acres in extent, of the earl of Desmond were to be given to English landlords at a nominal rent, provided that they brought with them English farmers and labourers. Before he had had time to embark on this enterprise he heard that the Highland clans

of Maclean and MacDonnell were raiding Ulster at the invitation of Sorley Boy MacDonnell, the Scots-Irish constable of Dunluce Castle. He marched into Ulster, but Sorley Boy escaped him, and crossed to Scotland, only to return later with reinforcements. The lord deputy was roundly abused by Elizabeth for undertaking "a rash, unadvised journey," but Sorley Boy was reduced to submission in 1586. In 1585 Perrot succeeded in completing the "composition of Connaught," a scheme for a contract between Elizabeth and the landholders of the province by which the queen should receive a small quitrent. During his career as lord deputy he had established peace, and had deserved well of Elizabeth. But a rash and violent temper, coupled with unsparing criticism, not to say abuse, of his associates, had made him numerous enemies. A hastily conceived plan for the conversion of the revenues of St Patrick's Cathedral, Dublin, to provide funds for the erection of two colleges, led to a violent quarrel with Adam Loftus, archbishop of Armagh. Perrot had interfered in Bingham's government of Connaught, and in May 1587 he actually struck Sir Nicholas Bagenal, the knight marshal, in the council chamber. Elizabeth decided to supersede him in January 1588, but it was only six months later that his successor, Sir William Fitzwilliam, arrived in Dublin. After his return to England his enemies continued to work for his ruin, and a forged letter purporting to be from him to Philip II. of Spain gave colour to an accusation of treasonable correspondence with the queen's enemies, but when he was tried before a special commission in 1592 the charge of high treason was chiefly based on his alleged contemptuous remarks about Elizabeth. He was found guilty, but died in the Tower in September 1592. Elizabeth was said to have intended his pardon.

A life of Sir John Perrot from a MS. dating from the end of Elizabeth's reign was printed in 1728. Sir James Perrot (1571–1637), writer and politician, was his illegitimate son.

PERRY, MATTHEW CALBRAITH (1794–1858), American naval officer, was born in South Kingston, Rhode Island, on the 10th of April 1794. He became a midshipman in 1809, and served successively in the schooner "Revenge" (then commanded by his brother, Oliver H. Perry) and the frigate "President." In 1813 he became a lieutenant, and during the War of 1812 served in the frigate "United States" (which, when abandoned by Perry, was blockaded in the harbour of New London, Connecticut), the "President" and the "Chippewa." Soon after the war Perry was assigned to the Brooklyn (New York) navy yard, where he served till 1819. He became a commander in 1826, and during 1826–1830 was in the recruiting service at Boston, where he took a leading part in organizing the first naval apprentice system of the United States navy. He was promoted in 1837 to the rank of captain (then the highest actual rank in the United States navy), and in 1838–1840 commanded the "Fulton II.," the first American steam war vessel. He also planned the "Missouri" and the "Mississippi," the first steam frigates of the United States navy, and was in command of the Brooklyn navy yard from June 1841 until March 1843, when he assumed command of a squadron sent to the African coast by the United States, under the Webster-Ashburton treaty, to aid in suppressing the slave trade. This command of a squadron entitled him to the honorary rank of commodore. On the 23rd of October 1846, during the Mexican War, Perry, in command of the steam vessels "Vixen" and "McLane," and four schooners, attacked and captured Frontera, at the mouth of the Tobasco river, then pushed on up the river and (on the 24th) captured the town of Tobasco, thereby cutting off Mexico from Yucatan. He relieved Commodore David Conner at Vera Cruz on the 21st of March 1847, and after a two days' bombardment by a battery landed from the ships the city wall was breached sufficiently to admit the entrance of troops.

Commodore Perry's distinctive achievement, however, was his negotiation in 1854 of the treaty between the United States and Japan, which opened Japan to the influences of western civilization. Perry sailed from Norfolk, Virginia, on the 24th of November 1852, in the "Mississippi." He reached Hong-Kong

on the 7th of April and on the 8th of July dropped anchor off the city of Uruga, on the western shore of the Bay of Yedo with the "Susquehanna," his flagship, the "Mississippi," and the sloops-of-war "Saratoga" and "Plymouth." On the 14th of July, accompanied by his officers and escorted by a body of armed marines and sailors (in all about 300 men), he went ashore and presented to commissioners especially appointed by the shōgun to receive them, President Fillmore's letters to the emperor, and his own credentials. A few days later the American fleet sailed for Hong-Kong with the understanding that Perry would return in the following spring to receive the emperor's reply. On the 11th of February, accordingly, he reappeared in the Bay of Yedo with his fleet—this time composed of the "Susquehanna," "Powhatan" and "Mississippi," and the sailing vessels "Vandalia," "Lexington" and "Southampton," and despite the protests of the Japanese selected an anchorage about 12 m. farther up the bay, nearly opposite the present site of Yokohama, and within about 10 m. of Yedo (Tōkyō). Here, on the 31st of March 1854, was concluded the first treaty (ratified at Simoda, on the 21st of February 1855, and proclaimed on the 22nd of June following) between the United States and Japan. The more important articles of this treaty provided that the port of Simoda, in the principality of Idzu, and the port of Hakodate, in the principality of Matsmai, were constituted as ports for the reception of American ships, where they could buy such supplies as they needed; that Japanese vessels should assist American vessels driven ashore on the coasts of Japan, and that the crews of such vessels should be properly cared for at one of the two treaty ports; that shipwrecked and other American citizens in Japan should be as free as in other countries, within certain prescribed limits; that ships of the United States should be permitted to trade at the two treaty ports under temporary regulations prescribed by the Japanese, that American ships should use only the ports named, except under stress of weather, and that privileges granted to other nations thereafter must also be extended to the United States. Commodore Perry died in New York City on the 4th of March 1858.

A complete and readable account of this expedition, and its results, scientific as well as political, compiled from the journals and reports of Commodore Perry and his officers, was published by the United States government under the title, *Narrative of the Expedition of an American Squadron to the China Seas and Japan* (3 vols., Washington, 1856). The first volume of this work, containing Commodore Perry's narrative, was also published separately. A brief biography of Perry is included in Charles Morris's *Heroes of the Navy in America* (Philadelphia and London, 1907). See also William E. Griffis's *Matthew Calbraith Perry, a Typical American Naval Officer* (Boston, 1887).

PERRY, OLIVER HAZARD (1785-1819), American naval officer, was born at South Kingston, Rhode Island, on the 23rd of August 1785. He entered the navy as midshipman (1799) with his father, Christopher Raymond Perry (1761-1818), a captain in the navy, and saw service against the Barbary pirates. At the beginning of the War of 1812 he was in command of a flotilla at Newport, but was transferred (Feb. 1813) to the Lakes. He served with Commodore Chauncey, and then was sent from Lake Ontario to Lake Erie, where he took up the chief command at the end of March 1813. With the help of a strong detachment of officers and men from the Atlantic coast he equipped a squadron consisting of one brig, six fine schooners and one sloop. Other vessels were laid down at Presque Isle (now Erie), where he concentrated the Lake Erie fleet in July. When Captain Perry appeared off Amherstburg, where Captain Robert Heriot Barclay (d. 1837), the British commander, was lying with his squadron, he had a very marked superiority. Captain Barclay, after a hot engagement—the Battle of Lake Erie—in which Captain Perry's flagship the "Lawrence," a brig, was so severely shattered that he had to leave her, was completely defeated. Perry commanded the "Java" in the Mediterranean expedition of 1815-1816, and he died at Port of Spain in Trinidad on the 23rd of August 1819, of yellow fever contracted on the coast of Brazil.

See O. H. Lyman, *Commodore O. H. Perry and the War on the Lakes* (New York, 1905).

PERRY, a city and the county-seat of Noble county, Oklahoma, U.S.A., 30 m. N. by E. of Guthrie. Pop. (1900), 3351 (399 negroes); (1910) 3133. Perry is served by the Atchison, Topeka & Santa Fé railway and by the St. Louis & San Francisco system. It is the commercial centre of a large agricultural and stock-raising region, which produces cotton and grain. Perry was settled in 1889.

PERRY (from Fr. *poiré*, from *poire*, a pear), an alcoholic beverage, obtained by the fermentation of the juice of pears. The manufacture is in all essentials identical with that of CIDER (*q.v.*).

PERRYVILLE, a town of Boyle county, Kentucky, U.S.A., about 10 m. W. of Danville. Pop. (1910), 407. Here on the 8th of October 1863 General Braxton Bragg, in command of the Confederate army of the Mississippi of about 16,000 men, with which he had invaded Kentucky, faced about in his slow retreat across the state and gave battle to the Union army of the Ohio of about 40,000 (of whom only about 22,000 were actually engaged) commanded by Major-General Don Carlos Buell. Bragg's order to attack was disregarded by Major-General Leonidas Polk, who preferred adopting the "defensive-offensive" rather than engage all of Buell's force. Bragg himself came on the field about 10 a. m. and repeated his orders for an attack, but it was 2 p. m. before there was an actual engagement. Then after much delay on Polk's part the Confederate army joined battle with McCook's corps. The Confederate lines were broken and driven back through Perryville, where caissons, ammunition wagons and 140 officers and men were captured. Darkness had now come on, and in the night Bragg withdrew. His losses were reported as 510 killed, 2635 wounded and 251 missing. The Union loss was 845 killed, 2851 wounded and 515 captured or missing. The battle was drawn tactically, but strategically it was a Union victory and it virtually closed Bragg's unsuccessful Kentucky campaign, which is sometimes called the Perryville campaign.

PERSEPOLIS, an ancient city of Persia, situated some 40 m. N.E. of Shiraz, not far from where the small river Pulwar flows into the Kur (Kyrus). The site is marked by a large terrace with its east side leaning on Kuhl Rahmet ("the Mount of Grace"). The other three sides are formed by a retaining wall, varying in height with the slope of the ground from 14 to 41 ft.; on the west side a magnificent double stair, of very easy steps, leads to the top. On this terrace are the ruins of a number of colossal buildings, all constructed of dark-grey marble from the adjacent mountain. The stones were laid without mortar, and many of them are still *in situ*. Especially striking are the huge pillars, of which a number still stand erect. Several of the buildings were never finished. F. Stolze has shown that in some cases even the mason's rubbish has not been removed.¹ These ruins, for which the name *Kizil minare* or *Chihil menare* ("the forty columns or minarets"), can be traced back to the 13th century, are now known as *Takhti Jamshid* ("the throne of Jamshid"). That they represent the Persepolis captured and partly destroyed by Alexander the Great has been beyond dispute at least since the time of Pietro della Valle.²

Behind *Takhti Jamshid* are three sepulchres hewn out of the rock in the hillside, the façades, one of which is incomplete, being richly ornamented with reliefs. About 8 m. N.N.E., on the opposite side of the Pulwar, rises a perpendicular wall of rock, in which four similar tombs are cut, at a considerable height from the bottom of the valley. The modern Persians call this place *Nakshi Rostam* ("the picture of Rostam") from the Sassanian reliefs beneath the opening, which they take to be a representation of the mythical hero Rostam. That the

¹ Cf. J. Chardin, E. Kaempfer, C. Niebuhr and W. Onseley. Niebuhr's drawings, though good, are, for the purposes of the architectural student, inferior to the great work of C. Texier, and still more to that of E. Flandin and P. Coste. Good sketches, chiefly after Flandin, are given by C. Kossowicz, *Inscriptiones palaeopersicae* (St. Petersburg, 1872). In addition to these we have the photographic plates in F. Stolze's *Persepolis* (2 vols., Berlin, 1882).

² *Lettera XV.* (ed. Brighton, 1843), ii. 246 seq.

occupants of these seven tombs were kings might be inferred from the sculptures, and one of those at Nakshi Rostam is expressly declared in its inscription to be the tomb of Darius Hystaspis, concerning whom Ctesias relates that his grave was in the face of a rock, and could only be reached by means of an apparatus of ropes. Ctesias mentions further, with regard to a number of Persians kings, either that their remains were brought "to the Persians," or that they died there.¹ Now we know that Cyrus was buried at Pasargadae (q.v.) and if there is any truth in the statement that the body of Cambyses was brought home "to the Persians" his burying-place must be sought somewhere beside that of his father. In order to identify the graves of Persepolis we must bear in mind that Ctesias assumes that it was the custom for a king to prepare his own tomb during his lifetime. Hence the kings buried at Nakshi Rostam are probably, besides Darius, Xerxes I., Artaxerxes I. and Darius II. Xerxes II., who reigned for a very short time, could scarcely have obtained so splendid a monument, and still less could the usurper Sogdianus (Secy-dianus). The two completed graves behind Takhti Jamshid would then belong to Artaxerxes II. and Artaxerxes III. The unfinished one is perhaps that of Ares, who reigned at the longest two years, or, if not his, then that of Darius III. (Codomannus), who is one of those whose bodies are said to have been brought "to the Persians"² (see ARCHITECTURE, fig. 12). Another small group of ruins in the same style is found at the village of Hājjiābād, on the Pulwar, a good hour's walk above Takhti Jamshid. These formed a single building, which was still intact 900 years ago, and was used as the mosque of the then existing city of Istakhr.

Since Cyrus was buried in Pasargadae, which moreover is mentioned in Ctesias as his own city,³ and since, to judge from the inscriptions, the buildings of Persepolis commenced with Darius I., it was probably under this king, with whom the sceptre passed to a new branch of the royal house, that Persepolis became the capital (see PERSIA: *Ancient History*, V. 2) of Persia proper. As a residence, however, for the rulers of the empire, a remote place in a difficult alpine region was far from convenient, and the real capitals were Susa, Babylon and Ecbatana. This accounts for the fact that the Greeks were not acquainted with the city until it was taken and plundered by Alexander the Great. Ctesias must certainly have known of it, and it is possible that he may have named it simply Πέρσαι, after the people, as is undoubtedly done by certain writers of a somewhat later date.⁴ But whether the city really bore the name of the people and the country is another question. And it is extremely hazardous to assume, with Sir H. Rawlinson and J. Oppert, that the words *and Pārsā*, "in this Persia," which occur in an inscription on the gateway built by Xerxes (D. I. 14), signify "in this city of Pārsā," and consequently prove that the name of the city is identical with the name of the country. The form Persepolis (with a play on *πέποις*, destruction) appears first in Cleitarchus, one of the earliest, but unfortunately one of the most imaginative annalists of the exploits of Alexander.

It has been universally admitted that "the palaces" or "the palace" (*ἡ βασιλεία*) burned down by Alexander are those now in ruins at Takhti Jamshid. From Stolze's investigations it appears that at least one of these, the castle built by Xerxes, bears evident traces of having been destroyed by fire. The locality described by Diodorus after Cleitarchus corresponds in important particulars with Takhti Jamshid, for example, in being supported by the

mountain on the east.⁵ There is, however, one formidable difficulty. Diodorus says that the rock at the back of the palace containing the royal sepulchra is so steep that the bodies could be raised to their last resting-place only by mechanical appliances. This is not true of the graves behind Takhti Jamshid, to which, as F. Stolze expressly observes, one can easily ride up; on the other hand, it is strictly true of the graves at Nakshi Rostam. Stolze accordingly started the theory that the royal castle of Persepolis stood close by Nakshi Rostam, and has sunk in course of time to shapeless heaps of earth, under which the remains may be concealed. The vast ruins, however, of Takhti Jamshid, and the terraces constructed with so much labour, can hardly be anything else than the ruins of palaces; as for temples, the Persians had no such thing, at least in the time of Darius and Xerxes. Moreover, Persian tradition at a very remote period knew of only three architectural wonders in that region, which it attributed to the fabulous queen Humāi (Khumai)—the grave of Cyrus at Murghā, the building at Hājjiābād, and those on the great terrace.⁷ It is safest therefore to identify these last with the royal palaces destroyed by Alexander. Cleitarchus, who can scarcely have visited the place himself, with his usual recklessness of statement, confounded the tombs behind the palaces with those of Nakshi Rostam; indeed he appears to imagine that all the royal sepulchres were at the same place.

In 316 B.C. Persepolis was still the capital of Persia as a province of the great Macedonian Empire (see Diod. xix, 21 seq., 46; probably after Hieronymus of Cardia, who was living about 316). The city must have gradually declined in the course of time; but the ruins of the Achaemenidae remained as a witness to its ancient glory. It is probable that the principal town of the country, or at least of the district, was always in this neighbourhood. About A.D. 200 we find there the city Istakhr (properly *Stakhr*) as the seat of the local governors. There the foundations of the second great Persian Empire were laid, and Istakhr acquired special importance as the centre of priestly wisdom and orthodoxy. The Sassanian kings have covered the face of the rocks in this neighbourhood, and in part even the Achaemenian ruins, with their sculptures and inscriptions, and must themselves have built largely here, although never on the same scale of magnificence as their ancient predecessors. The Romans knew as little about Istakhr as the Greeks had done about Persepolis—and this in spite of the fact that for four hundred years the Sassanians maintained relations, friendly or hostile, with the empire.

At the time of the Arabian conquest Istakhr offered a desperate resistance, but the city was still a place of considerable importance in the 1st century of Islam (see CALIPHATE), although its greatness was speedily eclipsed by the new metropolis Shiraz. In the 10th century Istakhr had become an utterly insignificant place, as may be seen from the descriptions of Istakhr, a native (c. 950), and of Mukaddasi (c. 985). During the following centuries Istakhr gradually declines, until, as a city, it ceased to exist. This fruitful region, however, was covered with villages till the frightful devastations of the 18th century; and even now it is, comparatively speaking, well cultivated. The "castle of Istakhr" played a conspicuous part several times during the Mahomedan period as a strong fortress. It was the middlemost and the highest of the three steep crags which rise from the valley of the Kur, at some distance to the west or north-west of Nakshi Rostam. We learn from Oriental writers that one of the Buyid (Buwaihid) sultans in the 10th century of the Flight constructed the great cisterns, which may yet be seen, and have been visited, amongst others, by James Moxer and E. Flandin. W. Ouseley points out that this castle was still used in the 16th century, at least as a state prison. But when Pietro della Valle was there in 1621 it was already in ruins.

¹ This statement is not made in Ctesias (or rather in the extracts of Photius) about Darius II., which is probably accidental; in the case of Sogdianus, who as a usurper was not deemed worthy of honourable burial, there is a good reason for the omission.

² Arrian, iii, 22, 1.

³ Cf. also in particular Plutarch, *Ariax*, iii., where Pasargadae is distinctly looked on as the sacred cradle of the dynasty.

⁴ The story of Aelian (*H. A.* l. 59), who makes Cyrus build his royal palace in Persepolis, deserves no attention.

⁵ See Arrian (iii, 13, 1, 10), or rather his best authority, King Ptolemy. So, again, the Babylonian Berossus, shortly after Alexander. See Clemens Alex. *Admon. ad gentes*, c. 5, where, with Georg Hoffmann (*Pers. Martyrs*, 137), *sal* is to be inserted before Πέρσαι, and this to be understood as the name of the metropolis.

⁶ The name of this mountain too, *Βασιλειῶν ὄρος*, is identical with *Shāhshāh*, which is at least tolerably well established by W. Ouseley (ii, 417) as a synonym of *Kāshī rukmet*.

⁷ See especially Hamza Isf., 38; Tabari, i. 690, 816 (cf. T. Nöldeke; *Geschichte der Perser*, i. 487; Tabari, p. 8). The ruins at Takhti Jamshid are alluded to as the work of Humāi, in connection with an event which occurred shortly after A.D. 200.

BIBLIOGRAPHY.—E. Flaminio and P. Coete, *Voyage en Perse (1843-1847)*; F. Stolze, *Die Achaemenidischen und Sassanidischen Denkmäler und Inschriften von Persepolis*, 8c. (1882); G. Perrot and C. Chipiez, *Histoire de l'art dans l'antiquité*, v. (1890). See also DARIUS; PERSIA; *Ancient History*; and CALIPHATE.

(Tr. N.; A. H. S.)

PERSEUS, in Greek legend, son of Danaë and Zeus. When Perseus was grown to manhood Polydectes, king of Seriphus, cast his eye on Danaë; and, in order to rid himself of the son, exacted of him a promise that he would bring him the head of the Gorgon Medusa. The Gorgons dwelt with their sisters the Graeae (the grey women) by the great ocean, far away in the west. Guided by Hermes and Athena, Perseus came to the Graeae. They were three hags, with but one eye and one tooth between them. Perseus stole the eye and the tooth, and would not restore them till the Graeae had guided him to the Nymphs, from whom he received the winged sandals, a wallet (*klepeus*, resembling a gamekeeper's bag) and the helmet of Hades, which rendered him invisible. Thus equipped and armed by Hermes with a sharp sword like a sickle, he came upon the Gorgons as they slept, and cut off Medusa's head, while with averted eyes he looked at her reflection which Athena showed him in the mirror of her shield. Perseus put the Gorgon's head in his wallet and fled, pursued by Medusa's sisters, to Ethiopia, where he delivered and married Andromeda (*g. v.*). With her he returned to Seriphus in time to rescue his mother and Dictys from Polydectes, whom he turned to stone with all his court by showing them the Gorgon's head. The island itself was turned to stone, and the very groves of Seriphus (so ran the proverb) were dumb (*Aelian, Nat. anim.* iii. 37). Perseus then gave the head of Medusa to Athena, and, with Danaë and Andromeda, hastened to Argos to see his grandfather, Acrisius, once more. But before his arrival Acrisius, fearing the oracle, had fled to Larissa in Thessaly. Thither Perseus followed him, and at some funeral games held in honour of the king of that country unwittingly slew his grandfather by the throw of a quoit, which struck him on the foot. Ashamed to return to Argos, Perseus gave his kingdom to Megapenthes (Acrisius's nephew), and received from him Tiryns in exchange. There he reigned and founded Midea and Mycenae, and became the ancestor of the Persides, amongst whom were Eurystheus and Heracles.

The legend of Perseus was localized in various places. Italy claimed that the chest containing Danaë and Perseus drifted ashore on the Italian coast (*Virgil, Aen.* vii. 372, 410). The Persian kings were said to have been descended from Perseus a son of Perseus, and, according to Pausanias of Damascus,¹ he taught the Persians to worship fire, and founded the Magian priesthood. His cult was transferred to the kings of Pontus, for on coins of Amisus he is represented with the features of Mithradates Eupator. Like Andromeda, Hesione, the daughter of Laomedon, king of Troy, was rescued by Heracles from a sea-monster, and both stories have been interpreted of the sun slaying the darkness, Andromeda and Hesione being the moon, which the darkness is about to devour. In one version of the story of Hesione, Heracles is said to have spent three days, like Jonah, in the belly of the beast, and it is noteworthy that the Greek representations of Andromeda's monster were the models for Jonah's fish in early Christian art. Its bones and Andromeda's chains were shown on a rock at Joppa. Perseus appears on coins of Pontus and Cappadocia, and of Tarsus in Cilicia, which he was said to have founded. The legend of St George was influenced by the traditions current regarding Perseus in Syria and Asia Minor.

For the slaying of the Medusa, see F. H. Knatz, *Quomodo Perseus fabulam arifites graeci et romani tractaverint* (1893); and, on the whole story, E. S. Hartland, *The Legend of Perseus* (1894-1896).

PERSEUS, in astronomy, a constellation of the northern hemisphere, called after the Greek legendary hero, it is mentioned by Eudoxus (4th century B.C.) and Aratus (3rd century B.C.);

¹ Author of a history of Antioch; he is quoted by John Malalas, *Chronographia*, pp. 37-38, ed. Bonn (1831). Nothing further is known of him (see C. W. Müller, *Fragmenta historicorum graecorum*, iv. 467).

Ptolemy and Tycho Brahe catalogued 29 stars, Hevelius 46. The most important member of this constellation is β *Persei* or Algol (*g. v.*), a famous variable star. θ *Persei* is a triple star, composed of one 4th magnitude star and two of the 10th magnitude; ρ *Persei* is an irregular variable, with a range in magnitude of 3.4 to 4.1. *Nova Persei* is a "new" star discovered in 1827 and subsequently recognized on Harvard plates by Mrs Fleming in 1895; another new star was discovered by Anderson on the 21st of February 1901, which, after increasing in magnitude, gradually became fainter and ultimately disappeared. There is a nebula surrounding *Nova Persei* (1901) which was photographed at Yerkes observatory in September 1901; a pair of star clusters, appearing as a bright patch in the Milky Way; and the meteoric swarm named the Perseids, which appear in August and have their radiant in Perseus. (See METEOR.)

PERSEUS OF MACEDONIA (b. c. 212 B.C.), the last king of Macedonia, eldest son of Philip V. He had his brother Demetrius killed, and thus cleared his way to the throne in 179. War broke out with Rome in 171 B.C. when P. Licinius Crassus was sent to attack him. Perseus defeated Crassus at Callinicus in Thessaly, but in 168 he was annihilated at Pydna by L. Aemilius Paulus. He was led in triumph through Rome, and died in captivity at Alba Fucena. (See MACEDONIA.)

PERSHORE, a market town in the Evesham parliamentary division of Worcestershire, England, 113 m. W.N.W. of London and 7 S.E. of Worcester by the Great Western railway. Pop. (1901), 3348. The station is 1½ m. from the town. Market gardening and fruit-growing (especially plums) are carried on and agricultural implements are manufactured. The churches of the two parishes of Holy Cross and St Andrew face one another across a road. Holy Cross is a remnant of a mitred abbey of Benedictines, said to have been founded about 970 by King Edgar, on the site of a Mercian religious settlement. There remain only the fine Early English choir, with Decorated additions, the Norman south transept and the majestic Decorated tower; while slight fragments of a Norman nave are seen.

PERSIA, a kingdom of western Asia, bounded on the N. by the Caspian Sea and the Russian Transcaucasian and Transcaucasian territories, on the E. by Afghanistan and Baluchistan, on the S. by the Arabian Sea and the Persian Gulf, and on the W. by Turkish territory. Long before the Christian era the satrapies of Darius comprehended roughly an immense range of territory, from the Mediterranean to the Indus and from the Caucasian chain and Jaxartes to the Persian Gulf and Arabian Ocean. In the 17th and 18th centuries A.D. the conquests of 'Abbas and Nadir kept up these boundaries more or less on the east, but failed to secure them on the west, and were limited to the Caucasus and Oxus on the north. Persia of the present day is not only, in the matter of geographical definition, far from the vast empire of Sacred Writ and remote history, but it is not even the less extensive dominion of the Safawi kings and Nadir Shah. It may be said, however, to comprise now quite as much settled and consolidated territory as at any period of its political existence of which we can speak with authority.

Boundaries.—The region of Ararat presents a good starting point for the definition of the western and northern frontiers of Persia. A line 20 m. in length from a point on the river Aras, in 39° 45' N. and 44° 40' E. to Mt Ararat, in the south-westerly direction; divides Persia from Russia. Southwards from Mt Ararat the Perso-Turkish frontier extends about 700 m. to the mouth of the Shatt el Arab in the Persian Gulf in 30° N. and 48° 40' E., but is undefined with the exception of the western boundary of the little district of Kotur. A mixed commission was appointed in 1843 for the settlement of the Perso-Turkish frontier. The labours of this commission resulted in the Erzerum treaty of 1847, by which both powers abandoned some lands and agreed to appoint commissioners to define the frontier. The commissioners met in 1849, 1850 and 1851 at Bagdad and Muhamrah without arriving at any result. In 1851 Lord Palmerston proposed that the general line of frontier should be traced by the agents of Turkey and Persia at Constantinople, assisted by the

commissioners, in conformity with the treaty of Erzerum, leaving doubtful localities to be settled in future. The Russian government agreed to this proposal, and the work of surveying the country from Mt Ararat to the Persian Gulf was then undertaken. When this was done the preparation of a map, embracing territory 700 m. in length by 20 to 40 m. broad, was

unsettled, and disputes have frequently arisen between the Turkish and Persian governments with regard to their respective claims to land (Hertslet, *Persian Treaties*). In the autumn of 1907 Turkish troops occupied not only "doubtful localities" but also adjoining lands which were indisputably Persian territory. The want of a determined line of demarcation



put in hand, and this work lasted from November 1857 till March 1865, when the Porte was informed in May of that year that "in the opinion of the mediating Powers, the future line of boundary between the respective dominions of the sultan and the shah was to be found within the limits traced on the map; that the two Mahomedan governments should themselves mark out the line; and that in the event of any differences arising between them in regard to any particular locality, the points in dispute should be referred to the decision of the governments of England and Russia." This boundary has remained

between the two countries may have political advantages, but is inconvenient to the geographer and most unfavourable to the cause of order and good government.

From the point on the Aras River 20 m. north-east of Mt Ararat, the river forms the northern boundary down to 48° E. The frontier line then runs about 35 m. in a south-easterly direction through the Moghan steppe to Pilsowar on the Bulgharu River and then south with a bend to the west to the Astara River and the port of Astara in 38° 27' N. and 48° 53' E. From Astara eastwards the boundary

is formed by the shore of the Caspian until it touches the Bay of Hassan Kul north of Asarabad. East of the Caspian Sea and beginning at Hasan Kul Bay the river Atrak serves as the frontier as far as Chat. It then extends east and south-east to Serrakhs on the Tejen River in $36^{\circ} 40' N.$ and $61^{\circ} 20' E.$ The distance from Mt Ararat to Serrakhs in a straight line is about 930 m. The frontier from Mt Ararat to Astara was defined by the treaty of Turkmanchai (Feb. 22, 1828), and a convention of the 8th of July 1893. The frontier east of the Caspian was defined by the Akhal-Khorasan Boundary Convention of the 21st of December 1881 and the frontier convention of the 8th of July 1893.

The eastern frontier extends from Serrakhs to near Gwetter on the Arabian Sea in $25^{\circ} N.$ and $61^{\circ} 30' E.$, a distance of about 800 m. From Serrakhs to near Kuhsan the boundary is formed by the Tejen River (called Hari Rud, or river of Herat, in its upper course); it then runs almost due south to the border of Seistan in $31^{\circ} N.$, and then through Seistan follows the line fixed by Sir Frederick Goldsmid's and Sir Henry McMahon's commissions in 1872 and 1903-1905 to Kuli Malik Siah. From this point to the sea the frontier separates Persian territory from British Baluchistan and runs south-east to Kuhak and then south-west to Gwetter. This last section was determined by Sir Frederick Goldsmid's commission in 1871.

The southern boundary is the coast line of the Arabian Sea and the Persian Gulf from Gwetter to the mouth of the Shatt el Arab, a distance of about 870 m., comprised between $48^{\circ} 40' E.$ and $61^{\circ} 30' E.$ The islands situated close to the northern shore of the Persian Gulf are Persian territory; they are, from east to west, Hormuz (Ormus), Larak, Kishm, Hengam, Furur, Kish (Kais), Hindarabi, Shaikh-Shu'ab, Jebrin, Kharak, Kharaku (Khorgu).

Physical Geography.—Modern Persia occupies the western and larger half of the great Iranian plateau which, rising to a height of from 400 to 8000 ft. between the valleys of the Indus and Tigris, covers more than a million square miles. Taking the Kuren Dagh or Kopet Dagh to form the northern scarp of this plateau east of the Caspian, we find a prolongation of it in the highlands north of the political frontier on the Aras, and even in the Caucasus itself. On the north-west Persia is united by the highlands of Armenia to the mountains of Asia Minor; on the north-west the Paropamisus and Hindu Kush connect it with the Himalayas. The lines of boundary on the western and eastern faces are to be traced amid high ranges of mountains broken here and there by deserts and valleys. These ranges lie for the most part north-east and south-east, as do those in the interior, with a marked exception between Teheran and Bujrud, and in Baluchistan, where they lie rather north-east and south-west, or, in the latter case, sometimes east and west. The real lowlands are the tracts near the sea-coast belonging to the forest-clad provinces of the Caspian in the north and the shores of the Persian Gulf below Basra and elsewhere. The Persians have no special names for the great ranges. Mountains and valleys are known only by local names which frequently cover but a few miles. Even the name Elburz, which European geographers apply to the chains and ranges that extend for a length of over 500 m. from Azerbaijan in the west to Khorasan in the east, stands with the Persians only for the 60 or 70 m. of mountains north and north-east of Teheran, including the cone of Demavend. The great central range, which extends, almost unbroken, for nearly 800 m. from Azerbaijan in the north-west to Baluchistan in the south-east, may aptly be called the *Central Range*. It has many peaks 9000 to 10,000 ft. in height, and some of its summits rise to an elevation of 11,000 ft. and near Kerman of nearly 13,000 ft. (Kuh-i-Jupar). The valleys and plains west of the Central Range, as for instance those of Mahallat, Joshakan, Isfahan, Sirjan, have an elevation of 3000 to 6500 ft.; those within the range, as Jaep, Ardahal, So, Fariz, are about 1000 ft. higher; and those east of it slope from an elevation of 5000 to 6000 ft. down to the depressions of the central plateau which, east of Kum, are not more than 2600 ft. and east of Kerman 1500 to 1700 ft. above the sea-level. Some of the ranges west of the Central Range, which form the highlands of Kurdistan, Luristan, Bakhtiari and Fars, and are parallel to it, end near the Persian Gulf; others follow the Central Range, and take a direction to the east as some point between Kerman and the sea on the western frontier of Baluchistan. Some of these western ranges rise to considerable elevations; those forming the Turkish-Persian frontier west of the lake of Urmia have peaks 11,000 ft. in height, while the Saband, east of the lake and south of Tabriz, has an elevation of 12,000 ft. Farther south, the Takht-i-Brikh, in the Afshar district, rises to 11,200 ft., the Elvend (ancient

Orontes), near Hamadan, to 11,600. The Shanturin Kuh, south of Burujird, is over 11,000 ft. in height, the Shahaan Kuh, Kuh-i-Gerra, Zardeta Kuh and Kuh-i-Karan (by some writers called Kuh-i-Rang), all in the Bakhtiari country west of Isfahan, are 12,800 to 13,000 ft. in height; and the Kuh-i-Dina (by some writers wrongly called Kuh-i-Dinar) has an elevation of over 14,000 ft. Still farther south, towards Kerman, there are several peaks (Bid-Khan, Lalehzar, Shah-Kuh, Jamal Bariz, &c.) which rise to an elevation of 13,000 ft. or more; and the Kuh-i-Hazar, south of Kerman, is 14,700 ft. in height. Beginning near Ardabil in Azerbaijan, where the cone of Savakta rises to an elevation of 15,798 ft. (Russian trigonometrical survey), and ending in Khorasan, the great Elburz range presents on its southern, or inward, face a more or less abrupt scarp rising above immense gravel slopes, and reaches in some of its summits a height of nearly 13,000 ft.; and the peak of Demavend, north-west of Teheran, has a height of at least 18,000 ft. These are several important ranges in Khorasan, and one of them, the Binalud, west of Meshed and north of Nishapur, has several peaks of 11,000 to 12,000 ft. in height. In south-eastern Persia the Kuh-i-Basman, a dormant volcano, 11,000 to 12,000 ft. in height, in the Basman district, and the Kuh-i-Taftan, &c. the hot or burning mountain (also called Kuh-i-Nushadar from the "sal ammoniac," *nushadar*, found on its slopes), an active triple-peaked volcano in the Sarhad district and 12,681 ft. in height (Captain Jennings), are notable features.

Taking the area of Persia at 628,000 sq. m. the drainage may thus be distributed: (1) into the Arabian Sea and Persian Gulf, 135,000 sq. m.; (2) into the Caspian, 100,000; (3) into the Seistan depression, 43,000; (4) into the Urmia Lake, 20,000; (5) into the interior of Persia, 330,000. The first district comprises most of the south-western provinces and the whole of the coast region as far east as Gwetter; the second relates to the tracts west, south and east of the southern part of the Caspian Sea. The tracts south of the Caspian are not more than 20 to 50 m. wide; those on the west widen out to a depth of 250 m. meeting the watershed of the Tigris on the one side and that of the Euphrates and Lake Van on the other, and embracing between the two the basin of Lake Urmia. On the east the watershed of the Caspian gradually increases in breadth, the foot of the scarp extending considerably to the north of the south-eastern angle of that sea, three degrees east of which it turns to the south-east, parallel to the axis of the Kopet Dagh. The third drainage area comprises Persian Seistan with part of the Helmund (Hilمند) basin and a considerable tract adjoining it on the west. The fourth is a comparatively small area on the western frontier containing the basin of Lake Urmia, shut off from the rest of the inland drainage, and the fifth area takes in a part of Baluchistan, most of Kerman, a part of Fars, all Yazd, Isfahan, Kashan, Kum, Irak, Khamseh, Kazvin, Teheran, Samnan, Damghan, Shahrud, Khorasan and the central desert regions.

Four rivers belonging essentially to Persia, in reference to the Caspian watershed, are the Seafid Rud or Kizil Uzun on the south-west, the Herhaz on the south and the Gurgan and Atrak at the south-eastern corner of that inland sea. The Seafid Rud rises in Persian Kurdistan in about $35^{\circ} 50' N.$ and $46^{\circ} 45' E.$, a few miles from Senejdij. It has a very tortuous course of nearly 500 m., for the distance from its source to the Caspian, 57 m. east of Resht, is only 210 m. in a straight line. The Kizil Uzun takes up some important affluents and is called Seafid Rud from the point where it breaks through the Elburz to the sea, a distance of 70 m. It drains 25,000 to 30,000 sq. m. of the country. The Herhaz, though not important in length of course or drainage, also, like the Seafid Rud, breaks through the Elburz range from the inner southern scarp to the north. It rises on the slopes of the Kasli Kuh, a peak 12,000 ft. in height within the Elburz, and about 25 m. north of Teheran, flows easterly through the Lar plateau, where it is known as the Lar River, and takes up several affluents; turns to the north-east at the foot of Demavend, leaving that mountain to the left, and flows due north past Amol to the Caspian. Its length is about 120 m. The Gurgan rises on the Armutlu plateau in Khorasan east of Astarabad, and enters the Caspian in $37^{\circ} 4' N.$, north-west of Astarabad, after a course of about 200 m. The Atrak rises a few miles from Kuchan and enters the Caspian at the Bay of Haasan Kul in $37^{\circ} 21' N.$, after a course of about 300 m. From the sea to the Russian frontier post of Chat the river forms the frontier between Persia and the Russian Transcaucasian region.

The drainage of the rivers which have no outlet to the sea and form inland lakes and swamps (*kavirs*) may be estimated at 350,000 sq. m., including the drainage of Lake Urmia, which is about 20,000 sq. m. Fourteen rivers flow into this lake: the Ah Chai, Safi Chai, Murdi Chai and Jaghatu from the east, the Tatau (Tatava) from the south; and nine smaller rivers from the west. During heavy rains and when the snows on the hills melt, thousands of streams flow from all directions into the innumerable depressions of inner Persia, or help to swell the perennial rivers which have no outlet to the sea. These latter are few in number, and some of them barely suffice for purposes of agricultural irrigation, and in summer dwindle down to small rills. The perennial streams which help to form the kavirs (salt swamps) east of Kum and Kashan are the Hableh-rud, rising east of Demavend, the Jajrud,

rising north of Teherán, the Kend and Kerej rivers, rising north-west of Teherán, the Shureh-rud (also called Abhar-rud), rising near Sultanieh on the road between Kasvin and Tabriz, and the Kara-ou, which rises near Hamadan and is joined by the Zarin-rud (also known as Do-ab), the Reza Chai (also called Mazdak-an-rud), the Jehrud River and the Kum-rud. The river of Isfahan, Zende-rud, i.e. "the great river" (from Persian *zendek* [Pehlevi, *zendek*], great), but now generally known as *Zayende-rud*, i.e. "the life-giving river," flows into the Gavkhaní or Gavkhanesh swamp, east of Isfahan. In Fars the Kur with its affluents forms the lake of Bakhtegan (also known as Lake of Niriz), and in its lower course, is generally called *Bandamir* (made famous by Thomas Moore) from the band (dam) constructed by the Amir (prince) Asad-ed-dowleh in the 10th century. ("Note on the Kur River in Fars," *Proc. Royal Geog. Soc.*, London, 1891.) The rivers flowing into the Persian Gulf and Arabian Sea diminish in importance from west to east. There are first the Diyala and Kerkheh flowing into the Tigris from the hills of Kurdistan; the Abi Diz and Karun which unite below Shushter, and reach the Shatt el Arab at Muhamrah; and the Jarahi and Tab, which with the Karun form "the delta of Persian Arabistan, the most extensive and fertile plain in Persia." There are many streams which though fordable at most seasons (some of them are often quite dry) are unfordable during the rains. Two of these may be mentioned here, viz. the Mand and the Minab, which St John (*loc. cit.* p. 9) considered as being "of far more importance than the maps would lead the observer to suppose." The former, after a run of over 300 m. from its sources in the hills west of Shiraz, debouches at Khor-i-Ziaret about 60 m. south of Bushire. It is mentioned by the old Arab and Persian geographers as the Sitakan (in some MSS. misspelt Sakkan), and is the Sitakos of Arrian and the Sitogonous of Pliny. In its upper course it is now known as the Kara-aghach (Wych-elm) River (cf. "Notes on the River Mand in Southern Persia," *Royal Geog. Soc.*, London, December 1883). The Minab has two outlets into the Persian Gulf, one the Khor-i-Minab, a salt-water creek into which the river overflows during the rains, about 30 m. east of Bander Abbas; the other the true Minab, at Khasan, some miles south of the creek. It rises in the hills about 100 m. north of Bander Abbasi, and has a considerable drainage. Its bed near the town of Minab (15 m. from the coast) is nearly a mile in width, and during the rains the water covers the whole bed, rendering it quite unfordable. During ordinary weather, in March 1884, the water flowing past the town was 100 yds. in width and 2 ft. deep (Preece, *Proc. Royal Geog. Soc.*, January 1885). In ordinary seasons very little water of the river runs into its original bed, being diverted into canals, &c. The creek, the Anamis of Nearchus, is navigable nearly all through the year as far as Shahbandar, the custom-house, about 7 m. inland, for vessels of 20 tons burden.

"The great desert region of Persia," writes Le Strange (*Lands of the Eastern Caliphate*, 1905), "stretches right across the high plateau of Iran going from north-west to south-east, and dividing the fertile provinces of the land into two groups; for the desert is continuous from the southern base of the Elburz mountains, that to the north overlook the Caspian, to the arid ranges of Makrán, which border the Persian Gulf. Thus it measures nearly 800 m. in length, but the breadth varies considerably; for in shape this immense area of drought is somewhat that of an hour-glass with a narrow neck, measuring only some 100 m. across, dividing Kermán from Seistán, while both north and south of this the breadth expands and in places reaches to over 200 m. At the present day the desert, as a whole, is known as the Lút or Dash-i-Lút; the saline swamps and the dry salt area being more particularly known as the Dash-i-Kavir, the term Kavir being also occasionally applied to the desert as a whole."

A three-wire telegraph line on iron posts, completed in March 1907, passes through this region, and it is the unenviable lot of some Englishmen stationed at Bam and Nuretabad Ispí (Ispid of medieval Arab geographers) on the confines of the desert regularly to inspect and test it. Of the northerly Great Kavir Dr Tietze thought that it was composed of a complex of isolated salt swamps separated by sand-dunes, low ridges of limestone and gypsum, perhaps also by volcanic rocks (*Jahrbuch k. k. geolog. Reichsanstalt*, Vienna, 1877). Dr Sven Hedin explored the northern part of the Great Desert in 1906. (A. H.-S.)

Geology.—Persia consists of a central region covered by Quaternary deposits and bordered on the north, west and south by a raised rim composed of older rocks. These older rocks also form the isolated ranges which rise through the Quaternary deposits of the central area.

In northern Persia the rocks of the elevated rim are thrown into folds which form a curve round the southern shore of the Caspian. The mountain ranges of Khorasan show the western portion of a second curve of folding which is probably continued into the Hindu Kush. In the western rim of Persia the folds run from north-west to south-east, and in the south these folds appear to curve gradually eastward, following the trend of the coast. The folds in the central Persian chains run from north-west to south-east, parallel to those of the western border. It is seldom that the old crystalline rocks, which form the floor upon which the sedimentary strata were

deposited, are exposed to view. Gneiss, granite and crystalline schist, however, are found in the Elburz and in some of the central ranges; and similar rocks form a large part of the Zagros. Some of these rocks are probably Archean, but some appear to be metamorphosed sedimentary deposits of later date. The oldest beds in which fossils have yet been found belong to the Upper Devonian. They are well developed in the Elburz range, where they attain a thickness of some 9000 to 10,000 ft., and they have been found also in some of the central ranges and in the Bakhtiari Mountains. In the Elburz range the Devonian is succeeded by a series of limestones with *Productus*. The greater part of the series belongs to the Carboniferous, but the upper beds are probably of Permian age. The limestones are followed by sandstones and shales with occasional seams of coal. The plants which have been found in these beds indicate a Rhaetic or Liassic age. The Middle and Upper Jurassic form a considerable portion of the Elburz and have yielded marine fossils belonging to several different horizons. The Cretaceous system is very widely spread in Persia. It is one of the most conspicuous formations in the Zagros and in the central ranges, and probably forms a large part of the plateau, beneath the Quaternary deposits. The most prominent member of the series is a massive limestone containing *Hippurites* and belonging to the upper division of the system. The Tertiary deposits include nummulitic limestone (Eocene); a series of limestones, sandstones and conglomerates, with marine Miocene fossils; and red marls, clays and sandstones with rock-salt and gypsum, believed to belong to the Upper Miocene. In the Elburz there is a considerable deposit of palagonite tuff which appears to be of Oligocene age. The nummulitic limestone takes part in the formation of the mountain chains. The Miocene deposits generally lie at the foot of the chains, or in the valleys; but occasionally they are found at higher levels. Pliocene deposits cover a considerable area near the coast. Both in the Elburz range and near the Baluchistan frontier there are numerous recent volcanoes. Some of these seem to be extinct, but several continue to emit vapours and gases. Demavend in the Elburz and Kuh-i-Taftan on the Baluchistan frontier are among the best-known. (P. L. A.)

See W. K. Loftus, "On the Geology of Portions of the Turko-Persian Frontier, and of the Districts adjoining," *Quart. Journ. Geol. Soc.* vol. xi. pp. 247-344, pl. ix. (London, 1855); W. T. Blanford, *Eastern Persia*, vol. ii. (Zoology and Geology) (London, 1876); C. L. Griesbach, *Field-notes*: No. 5, to accompany a Geological Sketch Map of Afghanistan and North-Eastern Khorasan, *Rec. Geol. Surv. India*, xx. 93-103 (1887), with map; A. F. Stahl, "Zur Geologie von Persien," *Peterm. Mitt.*, Ergänzungsheft 122 (1897); J. de Morgan, *Mission scientifique en Perse*, vol. iii. (completed 1905, Paris). A summary by H. Douville of the principal geological results of de Morgan's expedition will be found in *Bull. soc. géol. France*, 4th series, vol. iv. pp. 539-553.

Climate.—For the rainfall on the watershed of the Persian Gulf there are two places of observation, Bushire and Jask; at the first it is a little in excess of that of inner Persia, while at the second it is very much less. The rainfall on the Caspian watershed greatly exceeds that of inner Persia; at Atarabad and Ashurada, in the south-eastern corner of the Caspian, it is about 50% more; and at Resht and Lenkoran, in the south-western corner, it is four and five times that of the adjoining districts across the ridges to the south. With the exception of the Caspian watershed and that of the Urmia basin, the country has probably in no part a yearly rainfall exceeding 13 or 14 in., and throughout the greater part of central and south-eastern Persia the yearly rainfall probably does not exceed 6 in. The following mean values of the rainfall at Teherán have been derived from observations taken by the writer during 1892-1907:—

	Jan.	Feb.	Mar.	April.	May.	June.	
Mean.	in. 1-76	in. 1-17	in. 1-87	in. 1-41	in. -50	in. -06	Total for Year. 9-86 in.
	July.	Aug.	Sept.	Oct.	Nov.	Dec.	
	in. -05	in. -05	in. -06	in. .32	in. 1-35	in. 1-26	

Good harvests depend on the rainfall from October to April, and on an amount of snow sufficient to cover the crops during frosts. During normal winters in Teherán and surrounding districts the rainfall amounts to 9 or 10 in., with 3 to 4 of snow, but in the winter 1898-1899 it was only 5½ in., with only 1 in. of snow; and in 1899-1900 the harvests were in consequence exceptionally bad, and large quantities of wheat and flour had to be brought from the provinces and even from Russia at high freights, causing the price of bread at Teherán to rise 200%. The first table on p. 192 shows the mean annual rainfall in inches at fifteen stations in and near Persia.

The prevailing winds throughout Persia and the Persian Gulf are from the north-west and south-east owing partly to the position of the Black Sea and Mediterranean and of the Arabian Sea, and partly

to the bearing of the axes of the great mountain chains. A dry and warm wind comes down from the snowy Elburz to Gilan in December and January, and much resembles the föhn of the Alps (Dr Tholozan, "Sur les vents du Nord de la Perse et sur le föhn du Gilan," *Comptes rendus, Acad. d. Sciences*, March 1882).

Frequently when the temperature in the shade at Bushire is not more than 85° or 90°, and the great humidity of the air causes much bodily discomfort, life is almost pleasant 12 or 20 m. inland with a temperature of over 100°.

Fauna.—Mr W. T. Blanford has described with great care and minuteness the zoology of Persia. In company with Major St John, R.E., he made a large collection of the vertebrate fauna in a journey from Gwetter to Teherán in 1872. Having added to this a previous collection made by the same officer with the assistance of a native from Calcutta, he had before him the principal materials for his work. Before commencing his analysis he adverted to his predecessors in the same field, *Lz. Gmelin* (whose travels were published in 1774-1784), *Olivier* (1807), *Pallas* (1811), *Ménétries* (1832), *Belanger* (1834), *Eichwald* (1834-1841), *Aucher Eloy* (1851), *Loftus*, *Count Keyserling*, *Koleschy*, *Ghesney*, the *Hon. C. Murray*, *De Filippi* (1865), *Hume* (1873), and *Professor Strauch* of St. Petersburg. All of these had, more or less, contributed something to the knowledge of the subject, whether as writers or as collectors, or in both capacities, and to all the due meed of credit was assigned. Blanford divided Persia into five zoological provinces: (1) the Persian plateau, or from the Kopet Dagh southwards to nearly 28° N. lat., including all Khorasan to the Perso-Afghan border, its western limit being indicated by a long line to the north-west from near Shiraz, taking in the whole upper country to the Russian frontier and the Elburz; (2) the provinces south and south-west of the Caspian;

Station.	Lat. N.	Long. E.	Altitude.		Year.	Authority.
			Feet.	Years.		
Lenkoran	38° 46'	48° 51'	-60	281	46-82	Supan. ¹
Resht	37° 17'	49° 35'	-50	2	56-45	British Consul. ²
Ashurada	36° 54'	53° 55'	-80	19	17-17	Supan. ¹
Astarabad	36° 51'	54° 25'	-40	7	16-28	Symons. ³
Meshed	36° 17'	59° 36'	3180	9	9-33	British Consul. ⁴
Quetta	30° 11'	67° 3'	5500	19	10-09	Supan. ¹
Kalat	28° 53'	66° 28'	6500	15	8-98	"
Masbat	23° 29'	58° 33'	—	3	6-13	"
Jask	25° 39'	57° 46'	—	10	3-24	English Telegraph. ⁵
Bushire	28° 59'	50° 49'	—	19	13-36	Supan. ¹
Isfahan	32° 37'	51° 40'	5370	7	5-44	English Telegraph. ⁵
Teherán	35° 41'	51° 25'	3810	15	9-86	The writer.
Urmia (Sair).	37° 28'	45° 8'	6225	1	21-51	Symons. ³
Bagdad	33° 19'	44° 26'	—	7	10-59	Supan. ¹
Merv	37° 35'	61° 0'	700	1	6-36	Symons. ³

Observations for temperature have been taken for many years at the stations of the Indo-European Telegraph and for a few years at the British consulate in Meshed, and the monthly and annual means shown in the following table have been derived from the indications of maximum and minimum thermometers in degrees Fahrenheit.

(3) a narrow strip of wooded country south-west of the Zagros range, from the Diyala River in Turkey in Asia to Shiraz; (4) the Persian side of the Shatt-el-Arab, and Aralictan, east of the Tigris; and (5) the shores of the Persian Gulf and Baluchistan. The fauna of the Persian plateau he described as "Palaeartic, with a great prevalence of desert forms; or, perhaps more correctly,

Station.	Jan.	Feb.	Mar.	April.	May.	June.	July.	Aug.	Sept.	Oct.	Nov.	Dec.	Year.	Highest observed.	Lowest observed.	Difference between Extremes.
Meshed	32	34	49	59	68	76	78	70	67	55	48	40	56.3	91	15	76
Teherán	38	38	48	51	71	81	84	81	73	64	53	43	60.4	111	3	108
Tabriz ⁶	17	25	39	54	63	74	79	81	73	62	48	34	54.1	99	-18	117
Kashan ⁷	35	36	43	60	74	83	90	85	77	68	53	42	62.2	113	9	104
Isfahan	—	—	—	—	—	—	—	—	—	—	—	—	58.0	106	-3	109
Abadeh ⁸	41	41	47	56	68	75	79	75	71	59	55	46	59.5	96	14	82
Dehbid ⁹	27	30	38	45	57	65	69	65	61	52	43	36	49.0	91	-19	110
Shiraz ¹⁰	48	47	55	63	73	80	85	81	76	67	55	49	65.0	113	21	92
Kazerun ¹¹	51	50	52	67	84	93	95	94	87	79	70	56	73.2	110	36	74
Borazjan ¹²	55	57	66	80	94	97	100	99	92	83	72	64	80.0	117	48	69
Bushire	58	60	65	74	82	86	90	90	87	80	71	62	75.4	109	41	68

Very few hygrometrical observations have been taken, and only those of the British residency at Bushire are more or less trustworthy, and have been regularly registered for a number of years. In inner Persia the air is exceptionally dry, and in many districts polished steel may be exposed in the open during a great part of the year without becoming tarnished. Along the shores of the Caspian, particularly in Gilan and Mazandaran, and of the Persian Gulf from the mouth of the Shatt el Arab down to Bander Abbas, the air during a great part of the year contains much moisture—dry- and wet-bulb thermometers at times indicating the same temperature—and at nights there are heavy falls of dew. In Gilan and Mazandaran the air contains much moisture up to considerable elevations and as far as 30 to 40 m. away from the sea; but along the Persian Gulf, where vegetation is very scanty, stations only a few miles away from the coast and not more than 20 or 30 ft. above the sea-level have a comparatively dry climate.

as being of the desert type with Palaeartic species in the more fertile regions." In the Caspian provinces he found the fauna, on the whole, Palaeartic also. "most of the animals being identical with those of south-eastern Europe." But some were essentially indigenous, and he observed "a singular character given to the fauna by the presence of certain Eastern forms, unknown in other parts of Persia, such as the tiger, a remarkable deer of the Indo-Malayan group, allied to *Cervus axis*, and a pit viper (*Halsys*)."¹ Including the oak-forests of Shiraz with the wooded slopes of the Zagros, he found in his third division that, however little known was the tract, it appeared to contain, like the second, "a Palaeartic fauna with a few peculiar species." As to Persian Mesopotamia, he considered its fauna to belong to the same Palaeartic region as Syria, but could scarcely speak with confidence on its characteristic forms. The fifth and last division, Baluchistan and the shores of the Persian Gulf, presented, however, in the animals common to the Persian highland "for the most part desert types, whilst the characteristic Palaeartic species almost entirely disappear, their place being taken by Indian or Indo-African forms." The Persian Gulf Arab, though not equal to the pure Arabian, is a very serviceable animal, and has always a value in the Indian market. Among others the wandering Turkish tribes in Fars have the credit of possessing good steeds. The Turkoman horse of Khorasan and the Atak is a large, bony and clumsy-looking quadruped, with marvellous power and endurance. Colonel C. E. Stewart stated that the Khorasan camel is celebrated for its size and strength, that it has very long hair, and bears cold and exposure far better than the ordinary Arabian or Persian camel, and that, while the ordinary Persian camel only carries a load of some 320 lb and an Indian camel one of some 400 lb, the Khorasan camel will carry from 600 to 700 lb. The best animals, he notes, are a cross between the Bactrian or two-humped and the Arabian or one-humped camel. Sheep, goats, dogs and cats are good of their kind; but not all the last are the beautiful creatures which, bearing the name of the

¹ Dr A. Supan, "Die Vertheilung des Niederschlag's auf der festen Erdoberfläche," *Pet. Mit.*, Suppl. 124 (1898).

² Consul's report (Gilan, 1897).

³ Symons's *Monthly Meteorological Mag.* (Dec. 1893).

⁴ 1899-1907.

⁵ Observations taken at the telegraph stations, and kindly communicated by Mr R. C. Barker, C.I.E., director of the Indo-European Telegraph Department in Persia. Those for Isfahan are during the years 1900-1907.

⁶ 38° 5' N.; 46° 18' E.; altitude 4423 ft.
⁷ 34° " " 51° 27' " " 3190 "
⁸ 31° 18' " 52° 38' " " 6200 "
⁹ 30° 37' " 53° 10' " " 8000 "
¹⁰ 29° 37' " 52° 38' " " 5000 "
¹¹ 29° 37' " 51° 43' " " 2800 "
¹² 29° 15' " 51° 3' " " 100 "

country, have arrived at such distinction in Europe. Nor are these to be obtained, as supposed, at Angora in Asia Minor. Van or Isfahan is a more likely habitat. The cat at the first place, called by the Turks "Van kediai," has a certain local reputation. Among the wild animals are the lion, tiger, leopard, lynx, brown bear, hyena, hog, badger, porcupine, pole-cat, weasel, marten, wolf, jackal, fox, hare, wild ass, wild sheep, wild cat, mountain-goat, gazelle and deer. The tiger is peculiar to the Caspian provinces. Lovett says they are plentiful in Astrabad; he measured two specimens, one 10 ft. 8 in., the other 8 ft. 10 in. from the tip of the nose to the end of the tail. Lynxes and bears were to be found in the same vicinity, and the wild pig was both numerous and destructive.

According to Blanford there are about four hundred known species of birds in Persia. The game birds have admirable representatives in the pheasant, "karkavud" (*Phasianus colchicus*, L.); snowcock or royal partridge, "kekle-dari" (*Tetrao galus Caspius*, Gmel.); black partridge, "durra" (*Francoisius vulgaris*, Steph.); red-legged partridge, "kek" (*Caccabis chukar*, Gray); sand-partridge or scabee, "tihu" (*Ammodramus bonhami*, Gray); Indian grey partridge, "jirufi" (*Oryzomys ponticolaris*, Gmel.); quail, "belderjin" (*Coturnix communis*, Bonn.); sandgrouse, "siyah-sineh" (*Pterodius armenicus*, Pall.); bustard, "hubareh" (*Otis letrax*, L. and *O. McQueenii*, Gray); woodcock, snipe, pigeon, many kinds of goose, duck, &c. The flamingo comes up from the south as far north as the neighbourhood of Teheran; the stork abounds. Poultry is good and plentiful. A large kind of fowl known as "Lari" (from the province Lar, in southern Persia) is said to be a descendant of fowls brought to Persia by the Portuguese in the 16th century.

The fish principally caught along the southern shore of the Caspian are the sturgeon, "sagmahi, dogfish (*Acipenser ruthenus* and *A. huso*); sheat-fish or silure, "simn," "sumn" (*Silurus glanis*); salmon, "asad mahi" (*Salmo salar*); trout, "masch" (*Salmo trutta*); carp, "kupur" (*Cyprinus balerus* and *C. carpio*); bream, "subulu" (*Abramis brama*); pike-perch, "mahisaid" (*Ercis luciopeca* or *Luciopeca sandra*). There is also a herring which frequents only the southern half of the Caspian, not passing over the shallow part of the sea which extends from Baku eastwards. As it was first observed near the mouth of the river Kur it has been named *Clupea kurensis*. Fish are scarce in inner Persia; salmon trout and mud-trout are plentiful in some of the mountain streams. Many underground canals are frequented by carp and roach. The silure has also been observed in some streams which flow into the Urmia lake, and in Kurdistan.

Flora.—In the provinces of Gilan, Mazandaran and Astarabad on the Caspian, from the shore to an altitude of about 3000 ft. on the northern slopes of the great mountain range which separates those provinces from the highlands of Persia, the flora is similar to that of Grisebach's "mediterranean region." At higher altitudes many forms of a more northern flora appear. As we approach inner Persia the flora rapidly makes place to "steppe vegetation" in the plains, while the mediterranean flora predominates in the hills. The steppe vegetation extends in the south to the outer range of the hills which separate inner Persia from the Persian Gulf and the Indian Ocean. Beyond this outer range and along the shore of the sea the flora is that of the "Sahara region," which extends eastwards to Sind.

Generally speaking, everywhere, excepting in the northern lowlands and in a few favoured spots in the hilly districts, the vegetation is scanty. In inner Persia the hills and plains are bare of trees, and steppe and desert predominate. The date-palm thrives well as far north as Tabbes in latitude 35° 36' and at an altitude of 2000 ft. and in the south extensive date-groves, producing excellent fruit, exist at altitudes of 2000 to 5000 ft. The olive is cultivated at Rudbar south of Resht in Gilan, and a few isolated olive-trees have been observed in central and southern Persia.

Of fruits the variety is great, and nearly all the fruits of Europe are well represented. The common, yet excellent melons, water-melons, grapes, apricots, cherries, plums, apples, are within the reach of the poorest. Less common and picked fruits are expensive, particularly so when cost of transport has to be considered; for instance, a good orange costs 2d. or 3d. in Teheran, while in Mazandaran (only 100 m. distant) when the oranges are brought, it costs 1d. Some fruits are famous and vie in excellence with any that European orchards produce; such are the peaches of Tabriz and Meshed, the sugar melons of Kashan and Isfahan, the apples of Demavend, pears of Natanz, figs of Kermanshah, &c. The strawberry was brought to Persia about 1859, and is much cultivated in the gardens of Teheran and neighbourhood; the raspberry was introduced at about the same time, but is not much appreciated. Currants and gooseberries are now also grown. The common vegetables also are plentiful and cheap, but only a few, such as the broad-bean, egg-plant (*Solanum melongena*), onion, carrot, beetroot, black turnip, are appreciated by the natives, who generally do not take kindly to newly-introduced varieties. The potato, although successfully cultivated in Persia since about 1780, has not yet found favour, and the same may be said of the tomato, asparagus, celery and others. Flowers are abundant, but it is only since the beginning of Nasr ed din Shah's reign (1848), when European

gardeners were employed in Persia, that they were rationally cultivated. Nearly all the European garden flowers, even the rarer ones, can now be seen not only in the parks and gardens of the rich and well-to-do but in many unpretentious courtyards with only a few square yards of surface.

Population.—In 1881 the present writer estimated the population of Persia at 7,653,600; 1,963,800 urban, 3,780,000 rural and 1,909,800 wandering ("Bevölkerung der Erde," p. 28; *Ency. Brit.* 9th ed. p. 628); and, allowing for an increase of about 1% per annum the population for 1910 may be estimated at 10 millions. No statistics whatever being kept, nothing precise is known of the movement of the population. During the ninth decade of the 19th century many Persian subjects emigrated, and many Persian villages were deserted and fell to ruins; since then a small immigration has set in and new villages have been founded. Persians say that the females exceed the males by 10 to 20%, but wherever the present writer has been able to obtain trustworthy information he found the excess to be less than 2%. Of the deaths in any place the only check obtainable is from the public body-washers, but many corpses are buried without the aid of the public body-washers; and the population of the place not being accurately known, the number of deaths, however correct, is useless for statistical purposes. Medical men have stated that the number of deaths, in times when there are no epidemics, amounts to 19 or 20 per thousand, and the number of births to 25 to 40 per thousand.

The prices of the staple articles of food and all necessaries of life have risen considerably since 1880, and, particularly in the large cities, are now very high. As salaries and wages have not increased at the same rate, many of the upper classes and officials are not so well off as formerly. By dismissing their servants in order to reduce expenditure, they have thrown great numbers of men out of employment, while many labourers and workmen are living very poorly and often suffer want. Tradesmen are less affected, because they can sell the articles which they manufacture at values which are more in proportion with the increased prices of food. In 1880 a labourer earning 25 kranas, or £1 sterling a month, could afford to keep a family; by 1908, in kranas, he earned double what he did in 1880, but his wage, expressed in sterling, was the same, and wherever the prices of food have risen more than his wages he could not afford to keep a family. In many districts and cities the number of births is therefore reduced, while at the same time the mortality, in consequence of bad and often insufficient food, is considerably increased.

The description of the Persian character by C. J. Wills, in his *In the Land of the Lion and Sun* (1883), is still worth quoting:—

"The character of the Persian is that of an easy-going man with a wish to make things pleasant generally. He is hospitable, obliging, and specially well disposed to the foreigner. His home virtues are many; he is very kind and indulgent to his children and, as a son, his respect for both parents is excessive, developed in a greater degree to his father, in whose presence he will rarely sit, and whom he is in the habit of addressing and speaking of as 'master.' The full stream of his love and reverence is reserved for his mother; he never leaves her to starve, and her wishes are laws to him. The mother is always the most important member of the household, and the grandmother is treated with veneration. The presence of the mother-in-law is coveted by their sons-in-law, who look on them as the guardians of the virtue of their wives. The paternal uncle is a much nearer tie than with us; while men look on their first cousins on the father's side as their most natural wives.

"Black slaves and men-nurses or 'lallahs' are much respected; the 'dayah' or wet nurse is looked on as a second mother and usually provided for for life. Persians are very kind to their servants; a master will often be addressed by his servant as his father, and the servant will protect his master's property as he would his own. A servant is invariably spoken to as 'bacha' (child). The servants expect that their master will never allow them to be wronged. The slaves in Persia have a good time; well fed, well clothed, treated as spoiled children, given the lightest work, and often given in marriage to a favourite son or taken as 'segah' or concubine by the master himself, slaves have the certainty of a well-cared-for old age. They are looked on as confidential servants, are entrusted with large sums of money, and the conduct of the most important affairs; and seldom abuse their trust. The greatest punishment to an untrustworthy slave is to give him his liberty and let him earn his living. They vary in colour and value; the 'Habashi' or Abyssinian is the most valued; the Sahuli or Somali, next in blackness, is next in price; the Bombasi, or coal-black negro of the interior, being of much less price, and usually only used as a cook. The prices of slaves in Shiraz are, a good Habashi girl of twelve to fourteen £40, a good Somali

same age, half as much; while a Boudnah is to be got for 514, being chosen merely for physical strength. They are never sold, save on importation, though at times they are given away. . . . I have never seen a Persian unkind to his own horse or his slave, and when overtaken by poverty he will first sell his shirt, then his slave.

"In commercial morality, a Persian merchant will compare not unfavourably with the European generally. . . . To the poor, Persians are unostentatiously generous; most of the rich have regular pensioners, old servants, or poor relations who live on their bounty; and though there are no workhouses, there are in ordinary times no deaths from starvation; and charity, though not organized, is general. . . . Procrastination is the attribute of all Persians, 'to-morrow' being ever the answer to any proposition, and the 'to-morrow' means indefinite delay. A great dislike is shown generally to a written contract binding the parties to a fixed date; and, as a rule, on breaking it the Persian always appeals for and expects delay and indefinite days of grace. . . .

Persians are clean in their persons, washing themselves and their garments frequently. The Persian always makes the best of his appearance; he is very neat in his dress, and is particular as to the wit of his hat and the cut of his coat. All Persians are fond of animals, and do not treat them badly, when their own property. Cruelty is not a Persian vice; torture and punishments of an unusual and painful nature being part of their judicial system. There are no vindictive punishments, such as a solitary confinement, penal servitude for long terms of years, &c. Seldom, indeed, is a man imprisoned more than twelve months, the rule being that there is a general jail delivery at the New Year. Royal clemency is frequently shown, often, perhaps, with want of judgment."

Costume.—The costume of the Persians may be shortly described as fitted to their active habits. The men invariably wear an un-starched shirt of cotton, sewn with white silk, often, particularly in the south of Persia, elaborately embroidered about the neck. It fastens in front by a flap, having two small buttons or knots at the left shoulder, and seldom comes below the hips. It has no collar, and the sleeves are loose. The lower orders often have it dyed blue; but the servant and upper classes always prefer a white shirt. Silk shirts are now seldom seen on men. Among the very religious during the mourning month ("Muharram") the shirt is at times dyed black. The "zir-jamah," or trousers, are of cloth among the higher classes, particularly those of the military order, who affect a garment of a tightness approaching that worn by Europeans. The ordinary "zir-jamah" are of white, blue or red cotton, very loose, and are exactly similar to the pyjamas worn by Europeans in India. They are held up by a thin cord of red or green silk or cotton round the waist, and the labouring classes, when engaged in heavy or dirty work, or when running, generally tuck the end of these garments under the cord, which leaves their legs bare and free to the middle of the thigh. The amplitude of this part of his attire enables the Persian to sit without discomfort on his heels; chairs are only used by the rich, great or Europeanized. Over the shirt and "zir-jamah" comes the "arkhalik," generally of quilted chintz or print, a closely-fitting garment, collarless, with tight sleeves to the elbow, whence, to the wrist, are a number of little metal buttons, fastened in winter, but not in summer. Above this is the "kamarchin," a tunic of coloured calico, cloth, Kashmir or Kermin shawl, silk, satin or velvet (gold embroidered, or otherwise), according to the time of the year and the purse and position of the wearer. This, like the "arkhalik," is open in front, and shows the shirt. It sometimes has a small standing collar, and is double-breasted. It has a pocket-hole on either side, giving access to the pockets, which are always in the "arkhalik," where also is the breast-pocket in which watch, money, jewels, and seals are kept. The length of the "kamarchin" denotes the class of the wearer. The military and official classes and the various servants wear it short, to the knee, while fops and sharpers wear it even shorter. Priests, merchants, villagers, especially about Shiraz, townsmen, shopkeepers, doctors and lawyers wear it very long, often nearly to the heels. Over the "kamarchin" is worn the "kuljah," or coat. This, as a rule, cast off in summer, save on formal occasions, and is often borne by a servant, or carried over the shoulder by the owner. It is of cloth, shawl or camel-hair cloth, and is lined with silk or cloth, flannel or fur. It has, like the Turkish frockcoat, a very loose sleeve, with many plaits behind. It has lapels, as with us, and is trimmed with gold lace, shawl or fur, or is worn quite plain. It has a roll collar and false pockets.

Besides these garments there are others: the long "jubba," or cloth cloak, worn by "mirzas" (secretaries), government employés of high rank, as ministers, farmers of taxes, courtiers, physicians, priests; the "abba," or camel-hair cloak of the Arab, worn by travellers, priests and horsemen; the "pustin," or Afghan skin-cloak, used by travellers and the sick or aged; the "nimtan," or common sheepskin jacket, with short sleeves, used by shopkeepers and the lower class of servants, grooms, &c., in winter; the "yapanjah," or woollen Kurdish cloak, a kind of felt, having a shaggy side, of immense thickness, worn generally by shepherds, who use it as greatcoat, bed and bedding. There is also the felt coat of the

villager, very warm and inexpensive, the cost being from 5 to 15 krans (a kran = rod.). The "kamarbund," or girdle, is also characteristic of class. It is made of muslin, shawl or cotton cloth among the priests, merchants, bazaar people, the secretary class and the more aged government employés. In it are carried, by literati and merchants, the pen-case and a roll of paper; its voluminous folds are used as pockets; by the bazaar people and villagers, porters and merchants' servants, a small sheath knife is struck in it; while by "farrashees," the carpet-spreader class, a large "khanjar," or curved dagger, with a heavy ivory handle, is carried. The headgear is very distinctive. The turban worn by priests is generally white, consisting of many yards of muslin. When the wearers are "sayyid" of the Prophet, a green turban is worn, also a "kamarbund" of green muslin, or shawl or cotton cloth. Merchants generally wear a turban of muslin embroidered in colours, or of a yellow pattern on straw-coloured muslin, or of calico, or shawl. The distinctive mark of the courtier, military, and upper servant class is the belt, generally of black varnished leather with a brass clasp; princes and courtiers often replace this clasp by a huge round ornament of cut stones. The "kulah," or hat, is of cloth or sheepskin on a frame of pasteboard. The fashions in hats change yearly. The Isfahan merchant and the Armenian at times wear the hat very tall. (The waist of the Persian is generally small, and he is very proud of his fine figure and broad shoulders.)

The hair is generally shaved at the crown, or the entire head is shaved, a "lakul," or long thin lock, being sometimes left, often 2 ft. long, from the middle of the crown. This is to enable the prophet Mahomet to draw up the believer into paradise. The lower orders generally, have the hair over the temporal bone long, and brought in two long locks turning backwards behind the ear, termed "sulf"; the beaux and youths are constantly twisting and combing these. The rest of the head is shaven. Long hair, however, is going out of fashion in Persia, and the more civilized affect the cropped hair worn by Europeans, and even have a parting in it. The chin is never shaved, save by "beauty men," or "kashangs," though often clipped, while the moustache is usually left long. At forty a man generally lets his beard grow its full length, and cherishes it much; part of a Persian's religious exercises is the combing of his beard. Socks, knitted principally at Isfahan, are worn; they are only about 2 in. long in the leg. The rich, however, wear them longer. They are of white cotton in summer and coloured worsted in winter. Villagers only wear socks on state occasions. Shoes are of many patterns. The "urusi," or Russian shoe is the most common; next, the "kash" or slipper of various kinds. The heel is folded down and remains so. The priests wear a peculiar heavy shoe, with an ivory or wooden lining at the heel. Green shoes of shagreen are common at Isfahan. Blacking is unknown to Persians generally. Boots are only used by horsemen, and are then worn much too large for ease. Those worn by courtiers often come up to the thigh. With boots are worn "shalwars," or baggy riding breeches, very loose, and tied by a string at the ankle; a sort of kilt is worn by courtiers. Pocket-handkerchiefs are seldom used, save by the rich or the Tiberians. Most Persians wear a "shab kulah," or night hat, a loose baggy cap of shawl or quilted material, often embroidered by the ladies.

Arms are usually carried only by tribesmen. The natives of the south of Persia and servants carry a "kamamah," or dirk. The soldiery, on or off duty, always carry one of these or their side-arms, sometimes both. They hack but never thrust with them. On the road the carrying of weapons is necessary.

The costume of the women has undergone considerable change in the last century. It is now, when carried to the extreme of fashion, highly indecent and must be very uncomfortable. The garment doing duty as a chemise is called a "pirahan"; it is, with the lower orders, of white or blue calico, and comes down to the middle of the thigh, leaving the leg nude. Among the upper classes it is frequently of silk. At Shiraz it is often of fine cotton, and elaborately ornamented with black embroidery. With the rich it is often of gauze, and much embroidered with gold thread, pearls, &c. The head is usually covered with a "char-kadd," or large square of embroidered silk or cotton, folded so as to display the corners, and fastened under the chin by a brooch. It is often of considerable value, being of Kashmir shawl, embroidered gauze, &c. A "jika," a jewelled feather-like ornament, is often worn at the side of the head, while the front hair, cut to a level with the mouth, is brought up in two locks on either cheek. Beneath the "char-kadd" is generally a small kerchief of dark material, only the edge of which is visible. The ends of the "char-kadd" cover the shoulders, but the gauze "pirahan" is quite transparent. A profusion of jewellery is worn of the most solid description, none hollow; silver is worn only by the very poor, coral only by negroesses. Necklaces and bracelets are much affected, and chains with scent-caskets attached, while the arms are covered with clanking glass bangles called "alangu" some twenty even of these being on one arm. Jewelled "barbands," containing talismans, are often worn on the upper arm, while among the lower orders and south Persian or Arab women nose-rings are not uncommon, and bangles or anklets of beads.

¹ Zir jamah are loose trousers and also drawers worn under the shalwar, or tight trousers.

² Green turbans are now rarely seen; the colour is generally dark blue, or black.

The face on important occasions is usually much painted, save by young ladies in the heyday of beauty. The colour is very freely applied, the cheeks being as much raddled as a clown's, and the neck smeared with white, while the eyelashes are marked round with "kuhl." This is supposed to be beneficial to the eyes, and almost every woman uses it. The eyebrows are widened and painted till they appear to meet, while sham moles or stars are painted on the chin and cheek; even spangles are stuck at times on the chin and forehead. Tattooing is common among the poor and in villages, and is seen among the upper classes. The hair, though generally hidden by the "char-kadd," is at times exposed and plaited into innumerable little tails of great length, while a coquetish little skull-cap of embroidery, or shawl, or coloured silk is worn. False hair is common. The Persian ladies' hair is very luxuriant and never cut; it is nearly always dyed red with henna, or with indigo to a blue-black tinge; it is naturally a glossy black. Fair hair is not esteemed. Blue eyes are not uncommon, but brown ones are the rule. A full-wood face is much admired, and a dark complexion termed "namak" (salt) is the highest native idea of beauty. Most Persian women are small, with tiny feet and hands. The figure is always lost after maternity, and no support of any kind is worn.

A very short jacket, of gay colour, quite open in front, having tight sleeves with many metal buttons, is usually worn in summer, and a lined outer coat in cold weather. In winter a pair of very short white cotton socks are used, and tiny slippers with a high heel; in summer in the house ladies go often barefoot. The rest of the costume is composed of the "tumbun" or "shalvar," short skirts of great width, held by a running string—the outer one being usually of silk, velvet, or Kashmir shawl, often trimmed with gold lace, or, among the poor, of loud-patterned chintz or print. Beneath are innumerable other garments of the same shape, varying in texture from silk and satin to print. The whole is very short, among the women of fashion extending only to the thigh. In winter an over-mantle like the "kuljah," or coat of the man, with short sleeves, lined and trimmed with furs, is worn. Leg-coverings are now being introduced. In ancient days the Persian ladies always wore them, as may be seen by the pictures in the South Kensington Museum. Then the two embroidered legs, now so fashionable as Persian embroideries ("nakah"), occupied a girl from childhood to marriage in making; they are all sewing in elaborate patterns of great beauty, worked on muslin in silk. The outdoor costume of the Persian women is quite another thing. Enveloped in a huge blue sheet, with a yard of linen as a veil perforated for two inches square with minute holes, the feet thrust into two huge bags of coloured stuff, a wife is perfectly unrecognizable, even by her husband, when out of doors. The dress of all is the same; and, save in quality or costliness, the effect is similar.

As for the children, they are always when infants swaddled; when they can walk they are dressed as little men and women, and with the dress they generally ape the manners. It is a strange custom with the Persian ladies to dress little girls as boys, and little boys as girls, till they reach the age of seven or eight years; this is often done for fun, or on account of some vow—oftener to avert the evil eye.

Towns.—The principal cities of Persia with their populations as estimated in 1908 are: Teheran (280,000); Tabriz (200,000); Isfahan (100,000); Meshed (80,000); Kermān, Resht, Shiraz (60,000); Barfurush, Kazvin, Yazd (50,000); Hamadan, Kermānshāh (40,000); Kashan, Khoi, Urmia (35,000); Birjend, Burujird, Bushire, Dizful, Kum, Senendj (Sinna), Zenjan (25,000 to 30,000); Amol, Ardebil, Ardistan, Astarabad, Abekuh, Bam, Bander, Abbasi, Bander Lingah, Damghan, Dilman, Istahbanat, Jahrum, Khunsar, Kumishah, Kuchan, Marand, Maragha, Nishapur, Sari, Sabzevar, Samnan, Shahrud, Shushter (10,000 to 20,000).

Political and Administrative Divisions.—The empire of Persia, officially known as *Mamalik i Mahruseh i Iran*, "the protected kingdoms of Persia," is divided into a number of provinces, which, when large, and containing important sub-provinces and districts, are called *mamlikat*, "kingdom," when smaller, *vilayat* and *ayalat*, and are ruled by governors-general and governors appointed by and directly responsible to the Crown. These provinces are further divided into sub-provinces, *vilayats*, districts, sub-districts and parishes, *buluk*, *mahiyek*, *mahal*, and towns, cities, parishes and villages, *shehr*, *kassabek*, *mahallek*, *deh*, which are ruled by lieutenant-governors and other functionaries appointed by and responsible to the governors. All governors are called *hakim*, or *hukmran*, but those of large provinces generally have the title of *wali*, and sometimes *firman-firma*. A governor of a small district is a *zabit*; a deputy-governor is called *naib el hukumeh*, or *naib el ayalek*; an administrative division is a *kalamro*, or *hukumal*. Until recently the

principal governorships were conferred upon the shah's sons, brothers, uncles and other near relatives, but now many of them are held by men who have little if any connexion with the royal family. Also, the governors are now, as a rule, resident in their provinces instead of being absentees at the capital. There are also some small districts or dependencies generally held in *fiel*, *turyul*, by princes or high functionaries who take the revenues in lieu of salaries, pensions, allowances, &c., and either themselves govern or appoint others to do so.

Every town has a mayor, or chief magistrate, called *beglerbegi*, "lord of lords," *kalantar*, "the greater," and sometimes *darogha*, "overseer," or chief of police; every ward or parish, *mahallek*, of a town and every village has a head-man called *ked khoda*, "house-lord." These officers are responsible to the governor for the collection of the taxes and the orderly state of their towns, parishes and villages. In the important provinces and sub-provinces the governors are assisted by a man of experience, to whom the accounts and details of the government are entrusted. This person, called *visir*, or *paishkar*, is often nominated by the shah, and his functions in the provincial-government are similar to those of the grand vizir in the central government, and comprise very extended administrative powers, including at times the command of the military forces in his province. Among the nomads a different system of titles prevails, the chiefs who are responsible for the taxes and the orderly conduct of their tribes and clans being known as *ikhshani*, *ibegi* (both meaning "tribe-lord," but the latter being considered an inferior title to the former), *khan*, *rais*, *amir*, *mir*, *shaikh*, *tushmal*, &c.

The governors and chiefs, excepting those possessing hereditary rights, are frequently changed; appointments are for one year only and are sometimes renewed, but it does not often occur that an official holds the same government for longer than that period, while it happens rarely that a province is governed by the same person for two or three years. This was not so formerly, when not infrequently an official, generally a near relation of the shah, held the same governorship for five, ten or even more years. The governorship of the province of Azerbaijan was an exception until the end of 1906, being always held by the *Valiash*, "heir apparent," or crown prince.

The political divisions of Persia, provinces, sub-provinces, districts, &c., ruled by *hakims* number over 200 (cf. the statement in Noldeke's *Geschichte des Ariachir Pápakán*, "after Alexander's death there were in Iran 240 local governors"), but the administrative divisions, *hukumal*, or *kalamro*, with governors appointed by the Crown and responsible to it for the revenues, have been under fifty for sixty-five years or more. In 1840 there were twenty-nine administrative divisions, in 1868 twenty-two, in 1875 twenty-nine, in 1884 nineteen, in 1890 forty-six, and in 1908 thirty-five, as follows:—

- | | |
|-------------------------------------------------------|--------------------------------------|
| (a) <i>Provinces:—</i> | |
| 1. Arabistan and Bakhtiari. | 14. Kamsch. |
| 2. Astarabad and Gurgan. | 15. Khar. |
| 3. Azerbaijan | 16. Khorasan. |
| 4. Fars. | 17. Kum. |
| 5. Gerrua. | 18. Kurdistan. |
| 6. Gilan and Talish. | 19. Luristan and Burujird. |
| 7. Hamadan. | 20. Mazandaran. |
| 8. Irak, Gulpaigan, Khunsar, Kamereh, Kezzaz, Ferkān. | 21. Nehavend, Malayir and Tusirkhan. |
| 9. Isfahan. | 22. Savah. |
| 10. Kashan. | 23. Samnan and Damghan. |
| 11. Kazvin. | 24. Shahrud and Bostam. |
| 12. Kermān and Baluchistan. | 25. Teherān. |
| 13. Kermānshāh. | 26. Zerend and Bagdādi Shāheveva. |
| (b) <i>Dependencies, or Fiefs:—</i> | |
| 1. Asadabad. | 6. Natahz. |
| 2. Demavend. | 7. Talikan. |
| 3. Firuzkuh. | 8. Tarom Uliā. |
| 4. Josehekan. | 9. Kharakan. |
| 5. Kangavar. | |

Roads.—With the exception of five short roads, having an aggregate length of less than 900 m., all the roads of the country are mere mule tracks, carriageable in the plains and during the dry season, but totally unfit for continuous wheeled traffic during all seasons, and in the hilly districts often so difficult as to cause much damage to goods and the animals carrying them. There are a few miles of roads in the immediate neighbourhood of Teherān leading from the city to royal palaces but not of any commercial

importance. The five exceptions are: (1) Resht-Kazvin-Teherán, 227 m.; (2) Julfa-Tabriz, 80 m.; (3) Teherán-Kum-Sultanabad, 160 m.; (4) Meshed-Kuchan-Askabad, 150 m.; 30 of which are on Russian territory; (5) Isfahan-Ahvaz, 280 m. The first of these roads consists of two sections: Resht-Kazvin, 135 m., and Kazvin-Teherán, 92 m. The first section was constructed in 1897-1899 by a Russian company, in virtue of a concession which the Persian government granted in 1893; and the second section was constructed in 1878-1879 by the Persian government at a cost of about £20,000, ceded to the concessionaire of the first section in 1896, and repaired and partly reconstructed by the Russian company in 1898-1899. Both sections were officially opened to traffic in August 1899. The capital of the company is 3,200,000 roubles (£341,330), of which 1,700,000 is in shares taken by the public, and 1,500,000 in debentures taken by the Russian government, which also guarantees 5% on the shares. About two-thirds of the capital has been expended on construction. The company's income is derived from tolls levied on vehicles and animals using the road. These tolls were at first very high but were reduced by 15% in 1904, and by another 10% in 1909. If all the trade between Russia and Teherán were to pass over this road, the tolls would no doubt pay a fair dividend on the capital, but much of it goes by way of the Teherán-Meshed-i-Sar route, which is much shorter and has no tolls. The second road, Julfa-Tabriz, 80 m., was constructed by the same Russian company in 1903. The third road, Teherán-Kum-Sultanabad, 160 m., also consists of two sections: the first, Teherán-Kum, 92 m., the other, Kum-Sultanabad, 68 m. The first section was constructed by the Persian government in 1883 at a cost of about £12,000, purchased by the Imperial Bank of Persia in 1890 for £10,000, and reconstructed at a cost of about £45,000. The second section formed part of the "Ahvaz road concession" which was obtained by the Imperial Bank of Persia in 1890 with the object of connecting Teherán with Ahvaz on the Karun by a direct cart road via Sultanabad, Burujird, Khorramabad (Luristan), Dizful and Shushter. The concession was ceded to Messrs Lynch, of London, "The Persian Road and Transport Company," in 1903. The fourth cart-road, Meshed-Askabad, 120 m., to the Persian frontier, was constructed by the Persian government in 1889-1892 in accordance with art. v. of the Khoreasan Boundary Convention between Russia and Persia of December 1881. The Persian section cost £13,000. The fifth road, Isfahan-Ahvaz, 280 m., is the old mule track provided with some bridges, and improved by freeing it of boulders and stones, &c., at a total cost of £5,500. The concession for this road was obtained in 1897 by the Bakhtiari chiefs and ceded to Messrs Lynch, of London, who advanced the necessary capital at 6% interest and later formed the Persian Road and Transport Company. The road was opened for traffic in the autumn of 1900. The revenue is derived from tolls levied on animals passing with loads. The tolls collected in 1907 amounted to £3100.

Railways.—Persia possesses only 8 m. of railway and 6½ m. of tramway, both worked by a Belgian company. The railway consists of a single line, one-metre gauge, from Teherán to Shah-ahmed-Azim, south of Teherán, and of two branch lines which connect the main line with some limestone quarries in the hills south-east of the city. The tramway also is a single line of one-metre gauge, and runs through some of the principal streets of Teherán. The length of the main railway line is 5½ m., that of the branches 2½. The main line was opened in 1888, the branches were constructed in 1893, and the tramway started in 1889. The capital now invested in this enterprise, and largely subscribed for by Russian capitalists, amounts to £320,000. There are also ordinary shares to the amount of £200,000 put down in the company's annual balance-sheets as of no value. The general opinion is that if Russian capitalists had not been interested in the enterprise the company would have liquidated long ago. (On railways in Persia, the many concessions granted by the Persian government, and only one having a result, ch. xviii. of Lord Curzon's *Persia* [i. 613-639], and on the Belgian enterprise, Lorini's *La Persia economica* [pp. 157-158] may be consulted.)

Posts.—Down to 1874 the postal system was in the hands of an official called *chakparchi bashi*, who was the head farmer of the post, or *chakpar*, and letters and small parcels were conveyed by him and his agents at high and arbitrary rates and without any responsibility. The establishment of a regular post was one of the results of the shah Naas-ed-din's first visit to Europe (1873). Two officials of the Austrian postal department having been engaged in 1874, an experiment of a post office upon European lines was made in the following year with a postal delivery in the capital and some of the neighbouring villages where the European legations have their summer quarters. In the beginning of 1876 a regular weekly post was established between Teherán, Tabriz and Julfa (Russo-Persian frontier) and Resht. Other lines, connecting all the principal cities with the capital, were opened shortly afterwards, and on the 1st of September 1877 Persia joined the international postal union with the rates of 2½d. per ½ oz. for letters, 1d. for post-cards, ½d. per 2 oz. for newspapers, &c., between Persia and any union country. The inland rates were a little less. There are now between Persia and foreign countries a bi-weekly service via Russia (Resht-Baku; Tabriz-Tiflis) and a weekly service via India (Bushire-Bombay). On the inland lines, with the exception of that between Teherán

and Tabriz, the service is weekly. There are reported to be 140 post offices. Statistics as to the number of letters, post-cards, newspapers, &c., conveyed are kept but not published; and since 1885, when a liberal-minded director communicated those for the year 1884-1885 to the present writer, no others, although many times promised, have been obtained. In the year 1884-1885 there were conveyed 1,368,835 letters, 2050 post-cards, 7455 samples, and 173,993 parcels, having a value of £304,720; and the receipts exceeded the expenditure by £466. Since then the traffic has much increased, and the excess of receipts over expenditure in the year 1898-1899 was reported to have been £10,000, but was probably more than that, for the minister of posts farmed the department for £12,000 per annum. The farm system was abolished in 1901 and in the following year the post office was joined to the customs department worked by Belgian officials. Under the most favourable conditions letters from London via Russia are delivered at Tabriz in 9 days, at Teherán in 10, at Isfahan in 14, and at Shiraz in 18 days; and via India, at Bushire in 26 days, at Shiraz in 31, at Isfahan in 36, and at Teherán in 40 days; but during the winter letters between London and Teherán sometimes take a month. In the interior the mails are conveyed on horseback, and, being packed in badly-made soft leather bags, are frequently damaged through careless packing and wet. The first Persian postage stamps were issued in 1875 and roughly printed in Persia. Since then there have been numerous issues, many practically bogus ones for collectors. Authentic specimens of the early ones are much valued by stamp collectors. (For information on the postal system of Persia, see G. Riederer, *Aus Persien*, Vienna, 1882; Fr. Schueller, *Die persische Post und die Postwertzeichen von Persien*, Vienna, 1893.)

Telegraphs.—The first line of telegraphs—from Teherán to Sulthanieh, about 160 m. on the road to Tabriz—was constructed in 1859. In the following year it was continued to Tabriz, and in 1863 to Julfa on the Russian frontier. With the object of establishing a direct telegraphic communication between England and India, by connecting the European and Indian systems by a land line through Persia from Bagdad—then the most easterly Turkish telegraphic station—to Bushire and by a cable from Bushire eastwards, a telegraphic convention was concluded in the same year between the British and Persian governments, and a one-wire line on wooden posts from the Turkish frontier, near Bagdad, to Bushire via Kermánsháh, Hamadan, Teherán, Isfahan and Shiraz, was constructed at the cost and under the supervision of the British government. In 1865 a new convention, providing for a second wire, was concluded, and for some years messages between Europe and India were transmitted either via Constantinople, Bagdad, Teherán, Bushire, or via Russia, Tiflis, Tabriz, Teherán, Bushire. An alternative line between Bagdad and India was created by the construction of a land line to Fao, at the head of the Persian Gulf, and the laying of a cable thence to Bushire. The service was very inefficient, and messages between England and India took several days and sometimes weeks to reach their destination. In 1869 Messrs Siemens of Berlin, in virtue of concessions obtained in the year before and later disposed of to the Indo-European Telegraph Company, Ltd.—who also took over Reuter's cable from Lowestoft to Emden (274 knots)—constructed a two-wire line on iron posts through Germany and Russia, and in Persia from Julfa to Teherán. This line was opened on the 31st of January 1870. The British government then handed the Bagdad-Teherán section, which had become unnecessary for international through traffic between Europe and India, over to the Persian government, and changed its Teherán-Bushire line into one of two wires on iron posts. In 1873, according to a convention signed December 1872, a third wire was added to the line, and there was then a three-wire line on iron posts (439 m. Indo-European Telegraph Company, 675 m. Indian government) from Julfa to Bushire. In August 1901 a convention was concluded between the British and Persian governments for a three-wire line on iron posts from Kashan (a station on the Teherán-Bushire line) to Baluchistan via Yazd, Kermán and Bam (805 m.). The construction of this "Central Persia line," as it is known officially, was begun in December 1902 and completed in March 1907. The section Kashan-Isfahan of the old Teherán-Bushire was then taken up and Isafahan was connected with the Central Persia line by a two-wire line from Ardistan, 71 m. south-east from Kashan. One of the three wires between Isfahan and Bushire was also taken up, and there are now a five-wire line from Teherán to Ardistan (224½ m.), a three-wire line from Ardistan to the Baluchistan frontier (734 m.) and a two-wire line from Ardistan to Bushire (497 m.). These lines, as well as that of the Indo-European Telegraph Company from Julfa to Teherán, are worked throughout by an English staff and may be classed among the finest and most efficient in the world. The central line is continued through Baluchistan to Karachi, and from Bushire messages go by cable (laid in 1864) to Jask, and thence either by cable or by land to Karachi, Bombay, &c. The telegraphic convention between the British and Persian governments has again been renewed, and is in force until 1925; and the concessions to the company were prolonged to the same year by the Russian government in March 1900. In addition to these lines, Persia possesses 4191 m. of single-wire lines on wooden poles belonging to the Persian government and worked by a Persian staff; the

Teherân-Meshed line (555 m.), however, is looked after by an English inspector and two English clerks at Meshed, and since 1885 the Indian government has allowed a sum not exceeding 20,000 rupees per annum for its maintenance; and the Meshed-Seistan line, 523 m., is looked after by twelve Russian inspectors and clerks. The Persian lines are farmed out for 1,800,000 krans (about £36,000) per annum and no statistics are published. There are in all 131 stations. Statistics of the traffic on the Indo-European line are given in the administration reports of the Indo-European telegraph department, published by government, and from them the figures in the following table have been obtained:—

Year.	Traffic over Lines between London and Karachi.	Earnings in thousands of Pounds.		Net Profits of the Government Dept.	
	Number of Messages transmitted.	Government Department.	Indo-European Telegraph Co.	Total amount. Rupees.	Percentage of Capital Outlay.
1887-1888	83,031	74	100	198,381	1.75
1892-1893	117,500	84	116	437,668	3.80
1897-1898	146,988	100	145	758,172	6.57
1902-1903	178,250	111	155	589,571	4.59
1905-1906	211,003	113	157	774,368	5.39
1906-1907	259,335	108	149	458,559	3.99

Manufactures, &c.—The handbook on Persian art published by Colonel Murdoch Smith, R.E., in 1876, with reference to the collection purchased and sent home by him for the Victoria and Albert Museum, has an instructive account of the more common manufactures of the country. They are classified under the respective heads of "porcelain and earthenware," "tiles," "arms and armour," "textile fabrics," "needlework and embroidery," "metal-work," "wood carving and mosaic-painting," "manuscripts," "enamel," "jewelry" and "musical instruments." Specimens of the greater number are not only to be procured in England, but are almost familiar to the ordinary Londoner. It need scarcely be said that tiles have rather increased in value than deteriorated in the eyes of the connoisseur, that the ornamentation of metal-work, wood carving and inlaying, gem and seal engraving, are exquisite of their kind, and that the carpets manufactured by skilled workmen, when left to themselves and their native patterns, are to a great extent unrivalled. Of the above-mentioned articles, carpets, shawls, woollens and cotton fabrics and silk stuffs are the more important. Carpets may be divided into three categories: (1) *Kali*, with a pile, and cut like plush; (2) *güm*, smooth; (3) *nimads*, felts. Only the two first are exported. The *Kali* and its smaller sizes, called *Katicheh* (in Europe, rugs), are chiefly made in Ferahân, Saltanabad (Iraq), Khorasan, Kurdistan, Karadagh, Yezd, Kermân, and among the nomad tribes of southern Persia. From the two first-mentioned localities, where a British firm has been established for many years, great quantities, valued in some years at £100,000, find their way to European and American markets, while rugs to the value of £30,000 per annum are exported from the Persian Gulf ports. Of the second kind, *güm* (used in Europe for curtains, hangings, and chair-covers), considerable quantities are exported from Shushter and Kurdistan. The value of the carpets exported during the year 1906-1907 was close upon £900,000, Turkey taking £613,300, Russia £196,700, United States £40,600, Great Britain £20,700, Egypt £18,500 and India £5400. Shawls are manufactured in Kermân and Meshed, and form an article of export, principally to Turkey. Woollen fabrics are manufactured in many districts, but are not exported in any great quantity. Coarse cotton stuffs, chiefly of the kind called *Kerbas*, used in their natural colour, or dyed blue with indigo, are manufactured in all districts but not exported; cottons, called *Kalamkar*, which are made in Manchester and block-printed in colours at Isfahan and Kumishah, find their way to foreign markets, principally Russian. Of silk fabrics manufactured in Persia, principally in Khorasan, Kashan and Yezd, about £100,000 worth per annum is exported to Turkey, Russia and India. In the environs of Kashan and in Fars, chiefly at Maimand, much rose-water is made, and a considerable quantity of it is exported by way of Bushire to India and Java. Many attempts have been made to start manufactures, supported by foreign capital and conducted by foreigners, but nearly all have resulted in loss. In 1879 the Persian government was induced to spend £30,000 on the erection of a gas factory in Teherân, but work was soon stopped for want of good coal. A few years later a Persian bought the factory and plant for £10,000, and made them over in 1891 to the Compagnie générale pour l'éclairage et le chauffage en Perse, which after bringing out much additional plant, and wasting much capital in trying for some years in vain to make good and cheap gas out of bad and dear coal, closed the factory. In 1891 another Belgian company, Société anonyme des verreries nationales de Perse, opened a glass factory in Teherân, but the difficulty of obtaining the raw material cheaply and in large quantities was too great to make it a paying concern, and the factory

had to be closed. A third Belgian company, Société anonyme pour la fabrication du sucre en Perse, with a large capital, then came to Persia, and began making beetroot sugar in the winter of 1895. But, like the gas and glass companies, it found the cost of the raw material and the incidental expenses too great, and ceased its operations in 1899. In 1890 a Russian company started a match factory near Teherân with an initial outlay, it is said, of about £20,000, but could not successfully compete with Austrian and Swedish matches and ceased operations very soon. A Persian gentleman erected a cotton-spinning factory at Teherân in 1894 with expensive machinery; it turned out some excellent yarn but could not compete in price with imported yarns.

Agricultural Products.—Wheat, barley and rice are grown in all districts, the two former up to considerable altitudes (8000 ft.), the last wherever the water supply is abundant, and in inner Persia generally along rivers; and all three are largely exported. The most important rice-growing districts which produce more than they require for local consumption and supply other districts, or export great quantities, are Astarabad, Mazandaran, Gilan, Veramin, (near Teherân), Lenjan (near Isfahan), and some localities in Fars and Azerbaijan. Peas, beans, lentils, gram, maize, millet, are also universally cultivated, and exported from the Persian Gulf ports to India and the Arabian coast. The export of rice amounted to 52,200 tons in 1906-1907, and was valued at £472,550. The Persian fruit is excellent and abundant, and large quantities, principally dried and called *khushkhar* (dry fruit), as quinces, peaches, apricots, plums (of several kinds), raisins, figs, almonds, pistachios, walnuts and dates (the last only from the south), as well as oranges (only from the Caspian provinces), are exported. The fruit exported during 1906-1907 had a value of £1,019,000. Nothing is being done to improve the vine, and the Persian wines, until recently of world-wide reputation, are yearly getting thinner and poorer. The phylloxera has done much damage. The naturalist S. G. Gmelin, who explored the southern shores of the Caspian in 1771, observed that the wines of Gilan were made from the wild grape. Cotton is largely grown, principally in the central districts and Khorasan, and some qualities are excellent and command high prices in the European markets; 18,400 tons of raw cotton, valued at £838,787, were exported to Russia in 1906-1907. Good hemp grows wild in Mazandaran. Tobacco of two kinds, one the *tumbaku* (*Nicotiana persica*, Lindl.), for water pipes, the other the *tutun* (*Nicotiana rustica*, L.), for ordinary pipes and cigarettes, is much cultivated. The *tumbaku* for export is chiefly produced in the central districts round about Isfahan and near Kashan, while the *tumbaku* of Shiraz, Fessa, and Darab in Fars, considered the best in Persia, is not much appreciated abroad. *Tutun* is cultivated in Azerbaijan, near Urmia and other places near the Turkish frontier, in Kurdistan, and, since 1875, in the district of Resht, in Gilan. About 1885 the quantity of tobacco exported amounted to between 4000 and 5000 tons. In 1906-1907 only 1820 tons, valued at £42,000, were exported. The cultivation of poppy for opium greatly increased after 1880, and it was estimated in 1900 that the annual produce of opium amounted to over 1000 tons, of which about two-fifths was consumed and smoked in the country. The principal opium-producing districts are those of Shiraz, Isfahan, Yezd, Kermân, Khorasan, Burujird and Kermanshâh. While the quantity consumed in the country is now probably the same, the quantity exported is much less: 239 tons, valued at £37,270 in 1906-1907. The value of the silk produced in Persia in the 'sixties was £1,000,000 per annum, and decreased in consequence of silk-worm disease to £30,000, in 1890. The quantity produced has since then steadily increased and its yearly value is estimated at half a million. Cocoons and raw silk valued at £316,140 were exported in 1906-1907. Of oil-yielding plants the castor-oil plant, sesame, linseed and olive are cultivated, the last only in a small district south of and near Resht. Very little oil is exported. The potato, not yet a staple article of food, tomatoes, celery, cauliflower, artichokes and other vegetables are now much more grown than formerly, chiefly in consequence of the great influx of Europeans, who are the principal consumers.

Among the valuable vegetable products forming articles of export are various gums and dyes, the most important being gum tragacanth, which exudes from the astragalus plant in the hilly region from Kurdistan in the north-west to Kermân in the south-east. Other gums are gum-ammoniac, asafetida, galbanum, sagapanum, sarcocolla and opoponax. In 1906-1907, 3310 tons of various gums of a value of £300,000 were exported. Of dye-stuffs there are produced henna (*Lawsonia inermis*) principally grown at Khabis near Kermân, wood and madder; a small quantity of indigo is grown near Dizful and Shushter. The export of dyes in 1906-1907 was 985 tons, valued at £32,326.

Horses, mules and donkeys, formerly exported in great numbers, are at present not very abundant, and their prices have risen much since 1880. Some nomad tribes who owned many brood mares, and yearly sold hundreds of horses, now hardly possess sufficient animals for their own requirements. The scarcity of animals, as well as the dearth of fodder, is one of the causes of the dearth of transport, and freights have risen on the most frequented roads from 3d. per ton-mile in 1880 to 10d., and even 13d., per ton-mile.

The prices of staple articles of food rose steadily from 1880 and

reached a maximum in 1900 and 1901, as will be seen from the following table:—

	Average Price, 1880.		Price, April 1900.		Price, June 1908.	
	s.	d.	s.	d.	s.	d.
Wheat, per kharvar . . . (649 lb)	22	6	102	0	32	0
Rice	56	3	64	0	64	0
Bread, ordinary, per manna (6½ lb.)		3-60		9-60		3-84
Meat, mutton (per manna)	1	2-40	2	9-60	1	5-28
Cheese		1 6		2 4-80		1 0
Clarified butter ..	2	3	4	9-60	5	4-80
Milk		4-50		9-60		7-68
Eggs, per 100 .. .	1	6	3	7-20	3	2-40

Forests and Timber.—Timber from the forests of Mazandaran and Gilan has been a valuable article of export for many years, and since about 1870 large quantities of boxwood have also been exported thence; in some years the value of the timber and boxwood exported has exceeded £50,000. This value represented about 200,000 box trees and quite as many others. Much timber is also used for charcoal-burning, and occasionally large parts of forest are burned by the people in order to obtain clearings for the cultivation of rice. The destruction of the forests by timber-cutters and charcoal-burners has been allowed to go on unchecked, no plantations have been laid out, and nothing has been done for forest conservation. Indiscriminate cutting has occasionally been confined within certain bounds, but such restrictions were generally either of short duration or made for the convenience and profit of local governors. The oak forests of Kurdistan, Luristan and the Bakhtiari district are also being rapidly thinned. A small step in the right direction was made in 1900 by engaging the services of an official of the Prussian forest department, but unfortunately, beyond sending him to inspect the Mazandaran forests belonging to the Crown, and employing him to lay out a small plantation in the Jajrud valley, east of Teherán, nothing was done. The monopoly for cutting and exporting the timber of the Mazandaran forests is leased to European firms, principally for box and oak. Boxwood has become scarce. There are many kinds of good timber-yielding trees, the best known being alder (*Alnus glutinosa*, Willd., *A. barbata*, *A. cordifolia*, Ten.), ash (*Fraxinus excelsior*, L.), beech (*Fagus sylvatica*, Elm) (*Ulmus campestris*, U. *glauca*, U. *pedunculata*), wych-elm (*Ulmus montana*), hornbeam (*Carpinus betulus*, L.), juniper (*Juniperus excelsa*, *J. communis*, *J. sabina*), maple (*Acer incense*, Boiss., *A. campestre*, *A. pseudo-platanus*, L.), oak (*Quercus ballota*, *Q. castaneaeifolia*, *Q. sessiflora*, *Q. pedunculata*), walnut, nettle tree (*Celtis australis*, L.), Siberian elm (*Zelkova crenata*, Spach.), and various kinds of poplar. Pipe-sticks, from the wild cherry tree, are exported to Turkey.

Fisheries.—Fish is a staple food along the shores of the Persian Gulf, but the Crown derives no revenue from fisheries there. The fisheries of the Caspian littoral are leased to a Russian firm (since 1868), and most of the fish goes to Russia (3,112 tons, value £56,125, in 1906-1907). The fish principally caught are sturgeon, gving caviare, sheat fish or silure, salmon, carp, bream and perch.

Minerals and Mining.—Persia possesses considerable mineral riches, but the absence of cheap and easy means of transport, and the scarcity of fuel and water which prevails almost everywhere, make any exploitation on a remunerative scale impossible, and the attempts which have been made to work mines with European capital and under European superintendence have been financially unsuccessful. Deposits of rich ores of copper, lead, iron, manganese, zinc, nickel, cobalt, &c., abound. A few mines are worked by natives in a primitive, systemless manner, and without any great outlay of capital. There are turquoise mines near Nishapur (for description of mines, manner of working, &c., see A. Heintz-Schindler, *Report on the Turquoise Mines in Khorasan*, F. O. Reports, 1884, and "Die Gegend zwischen Sabzar und Mesched," *Jahrbuch k. k. geol. R. A. Wien*, vol. xxvii.; also E. Tietze, *Verhandl. k. k. geol. R. A.*, 1884, p. 93); several copper mines in Khorasan, Samnan, Azerbaijan and Kermán; some of lead, two considerably argentiferous, in Khorasan. Tudarvar (near Samnan), Anguran, Afshar (both west of Zenjan), and Kermán; two of iron at Mesula in Gilan and Nur in Mazandaran; two of orpiment in Afshar and near Urmia; one of cobalt at Kamsar (near Kashan); one of alum in Tarom (near Kazvin); and a number of coal in the Lar district, north-east of Teherán, and at Hiv and Abyek, north-west of Teherán. There are also many quarries of rock-salt, gypsum, lime and some of marble, alabaster, soapstone, &c. The annual revenue of the government from the leases, rents and royalties of mines does not amount to more than £15,000, and about £600 of this amount is derived from the turquoise mines near Nishapur. As the rents and royalties, excepting those on the turquoise mines, amount to about one-fifth of the net proceeds, it may be estimated that the value of the annual output does not exceed £30,000, while the intrinsic value of the ores, particularly those of lead, iron, cobalt and nickel, which have not yet been touched can be estimated at

millions. There are also some very rich coal seams in eastern Persia, far away on the fringe of the desert, and under existing conditions quite valueless. The richest deposits of nickel, cobalt and antimony ores are also situated in localities where there is little water and the nearest useful fuel some hundred miles away. Auriferous alluvial strata have been discovered in various localities, but everywhere the scarcity of water has been a bar to their being exploited with profit. A rich naphtha-bearing zone stretches from the Luristan hills near Kermánsháh down to the Persian Gulf. Competent engineers and specialists have declared that borings in the Bakhtiari hills, west of Shushter, would give excellent results, but the difficult hilly country and the total absence of roads, as well as the antipathy of the inhabitants of the district, would make the transport and establishment of the necessary plant a most difficult matter. A British syndicate has been boring at several places in the zone since 1903.

Commerce.—The principal centres of commerce are Tabriz, Teherán, Resht, Meshed and Yazd; the principal ports Bander Abbasi, Lingah, Bushire and Muhamrah on the Persian Gulf, and Astara, Enzeli, Meshed i Sar and Bander i Gez on the Caspian.

Until 1899 all the customs were farmed out (1898-1899 for £300,000), but in March of that year the farm system was abolished in the two provinces of Azerbaijan and Kermánsháh, and, the experiment there proving successful, in all other provinces in the following year. At the same time a uniform duty of 5% *ad valorem* was established. In October 1901 a treaty fixing a tariff and reserving "the most favoured nation" treatment for the countries already enjoying it was concluded between Persia and Russia. It was ratified in December 1902 and came into force on the 14th of February 1903. The commercial treaty with Great Britain, concluded in 1857, provided for the "most favoured nation" treatment, but nevertheless a new treaty under which the duties levied on British imports would be the same as on Russian imports was made with Great Britain a few days before the new tariff came into force and was ratified in May.

For the value of imports and exports previous to 1901 the only statistics available were the figures given in consular reports, which were not always correct. In 1897 it was estimated that the value of the imports from and exports to Great Britain, including India, amounted to £3,250,000. About a quarter of this trade passed over the western frontier of Persia, while three-quarters passed through the Persian Gulf ports. The value of the trade between Russia and Persia was then about £3,500,000. Since 1901 detailed statistics have been published by the customs department, and according to them the values of the imports and exports in thousands of pounds sterling for the six years 1901-1907 were as follows:—

	Imports.	Exports.	Total.
1901-1902	5429	2738	8,167
1902-1903	4970	3388	8,358
1903-1904	7000	4632	11,632
1904-1905	5832	4132	9,964
1905-1906	6441	4886	11,327
1906-1907	7982	6544	14,526

The imports and exports during the year 1906-1907 (total value £14,526,234) were distributed as follows (values in thousands sterling):—

Russia	8292	U.S. America	69
Great Britain	3128	Italy	65
Turkey	1335	Egypt	41
France	700	Netherlands	37
Austria	277	Belgium	24
Afghanistan	203	Switzerland	22
Germany	182	Sweden	8
China	142	Other countries	1

14,526

While the value of the trade between Great Britain and Persia in 1906-1907 was almost the same as in 1897, that of the trade with Russia had increased from 3½ millions to 8½ or 137%. The average yearly value of the trade between Great Britain and Persia during the six years was £2,952,185 (imports £2,435,016, exports £517,169); between Russia and Persia £6,475,866 (imports £3,350,072, exports £3,125,794). The average values of the trade with other countries were: France £666,000, Austria £246,000, Germany £124,000, Italy £79,000, United States of America £52,000, Netherlands £39,000.

The principal imports into Persia in approximate order of value are cottons, sugar, tea, woollens, cotton yarn, petroleum, stuffs of wool and cotton mixed, wool, hardware, ironmongery, matches, iron and steel, dyes, ice, spices and glassware. The principal exports are fruits (dried and fresh), carpets, cotton, fish, rice, guma, wool, opium, silk cocoons, skins, live animals, silks, cottons, wheat, barley, drugs and tobacco.

Shipping and Navigation.—Shipping under the Persian flag is restricted to vessels belonging to the Persian Gulf ports. Some of the larger craft, which are called *baglah*, and vary from 50 to 300 tons, carry merchandise to and from Bombay, the Malabar

coast, Zanzibar, &c.; while the smaller vessels, called *bagaraks*, and mostly under 20 tons, are employed in the coasting trade and the pearl-fisheries on the Arabian coast. It is estimated that the four principal ports and the many smaller ones (as Mashur, Hindian, Zaidia, Bander, Dilam, Rig, Kongan, Taberi, Kishm, Hormuz, &c.) possess at least 100 *baglaks* and several hundred *bagaraks*, besides a large number of small boats. The following figures from the commercial statistics published by the Persian Customs Department show the total shipping at the four principal Persian Gulf ports, Bushire, Bander Lingah, Bander Abbasi and Muhamrah during the years 1904-1907.

	1904-1905.	1905-1906.	1906-1907.
	Tons.	Tons.	Tons.
British . . .	671,386	827,539	826,594
Persian . . .	36,797	25,069	6,425
Russian . . .	24,121	29,182	40,616
Arabian . . .	22,487	16,749	7,932
Turkish . . .	3,176	3,877	5,005
French . . .	2,901	570	—
German . . .	—	—	52,935
Total . . .	760,868	902,986	939,507

The British shipping amounted to 89.2% of the total shipping at the four ports during the years 1904-1907. There was no German shipping in the gulf before 1906, but in the first year of its appearance (1906-1907), its tonnage at the gulf ports was almost as much as that of all other nations with the exception of Great Britain.

The shipping of 1906-1907 was distributed among the four ports as follows:—

Bushire . . .	354,798 tons.	Bander Abbasi . . .	245,746 tons.
Bander Lingah	153,720 "	Muhamrah . . .	183,243 "

Bander Lingah being the port where most of the pearls obtained on the Arabian coast of the gulf are brought to and exported from, has more native shipping (all sailing vessels) than the other ports.

All the shipping on the Caspian is under the Russian flag¹ and no returns of the arrivals and departures of vessels at the Persian ports were published before 1906. According to the statistics of the customs department the shipping of the Persian ports amounted in 1906-1907 to 650,727 tons. The shipping at the principal Persian ports on the Caspian in the year 1906-1907 was: Astara 137,935 tons; Enzeli 202,132 tons; Meshed i Sar 90,799 tons; Bander-i-Goz 36,135 tons. Two or three flat-bottomed sailing vessels navigate the lake of Urmia in north-western Persia, carrying merchandise, principally agricultural produce, from the western and south-western shores to the eastern for the supply of Tabriz. The navigation is a state monopoly, leased out for £250 per annum.

Coinage, Weights and Measures.—The monetary unit is the kran, a silver coin, formerly weighing 28 nakhods (88 grains), then reduced to 26 nakhods (77 grains), and now weighing only 24 nakhods (71 grains) or somewhat less. Before the new coinage came into use (1877) the proportion of pure silver was from 92 to 95%; subsequently the proportion was for some time 90%; now it is about 89½%. In consequence of this depreciation of the coinage and the fall in the price of silver, partly also in consequence of exchange transactions by banks, the value of the kran has since 1895 rarely been more than 4-8od., or half what it was in 1874, and fell to less than 4d. in 1905. In 1874 the kran was worth a franc; in June 1908 the exchange for a £1 bill on London was 50 krans which gives the value of 1 kran as 4d. Taking this value of the kran, the values of the various nickel and silver coins in circulation work out as:—

Nickel Coins.		Silver Coins.	
Shahi = 2 pul . . .	0.24d.	Five shahis = ½ kran . . .	1.20d.
Two shahis = 4 pul . . .	0.48d.	Ten shahis = ½ kran . . .	2.40d.
		One kran = 20 shahis =	
		40 pul . . .	4.80d.
		Two krans . . .	9.60d.

In 1899 from 80 to 83 copper shahis (weighing about ½ lb) were being given for one silver kran. This was owing to the depreciation of the copper coinage from 1896 onwards, consequent upon there being an excess of coinage due to the excessive quantities formerly put in circulation from the mint. Accordingly the government in 1900 replaced the copper by a nickel coinage (face value of nickel coin in circulation end of 1907, 4,000,000 krans). Accounts are

¹ By article v. of the Treaty of Gullistan of 1813, confirmed by article viii. of the Treaty of Turkmanchai of 1828, it was declared that Russia alone should have the right of maintaining vessels of war on the Caspian, and that no other Power should fly the military flag on that sea; and by a decision of the council of the Russian Empire, published on the 24th of November 1869, the establishment of companies for the navigation of the Caspian, except by Russian subjects, and the purchase of shares of such companies by foreigners were prohibited. (*State Papers*, vol. lxiii. 925.)

kept in dinars, formerly a gold piece, now an imaginary coin value of a kran. Ten thousand dinars are equal to one toman (a word meaning ten thousand), or 10 krans silver, and 50 dinars are one shahi.

Gold coins are: ½, 1, 2, 5, and 10 toman pieces, but they are not in circulation as current money because of their ever-varying value in silver krans, which depends upon the exchange on London.

The unit of weight is the miskal (71 grains), subdivided into 24 nakhods (2.96 grains), a nakhod being further subdivided into 4 gandum (.74 grains). Larger weights, again, are the air (16 miskals) and the abassi, wakkeh, or kervankeh (5 air). Most articles are bought and sold by a weight called batman, or man, of which there are several kinds, the principal being:—

Man-i-Tabriz = 8 abassis	= 640 miskals	= 6.49 lb
Man-i-Noh abassi = 9 abassis	= 720 "	= 7.30 "
Man-i-Kohneh (the old man)	= 1000 "	= 10.14 "
Man-i-Shah = 2 Tabriz mans	= 1280 "	= 12.98 "
Man-i-Rey = 4 "	= 2560 "	= 25.96 "
Man-i-Bander abassi	= 840 "	= 8.52 "
Man-i-Hashemi = 16 mans of	720 "	= 116.80 "

Corn, straw, coal, &c., are sold by kharvar = 100 Tabriz mans = 649 lb.

The unit of measure is the zar or gez, of which, as in the case of the man, there are several variants. 40.95 in. is the most common length for the zar, but in Azerbaijan the length is 44.09 in. Long distances are calculated in farsakhs, a farsakh being equal to 6000 zar. Probably the zar in this measure = 40.95 in., which makes the farsakh 3.87 m., but the other length of the zar is sometimes used, when the farsakh becomes 4.17 m. Areas are measured in jeribs of from 1000 to 1066 square zar of 40.95 in., the surface unit thus being from 1294 to 1379 sq. yds.

Constitution and Government.—Up to the year 1906 the government of Persia was an absolute monarchy, and resembled in its principal features that of the Ottoman Empire, with the exception, however, that the monarch was not the religious head of the community. The powers of the Shah (Shahanshah,² or "king of kings") over his subjects and their property were absolute, but only in so far as they were not opposed to the *shari'*, or "divine law," which consists of the doctrines of the Mahomedan religion, as laid down in the Koran, the oral commentaries and sayings of the Prophet, and the interpretations by his successors and the high priesthood. In 1905, however, the people began to demand judicial reforms, and in 1906 cried out for representative institutions and a constitution. By a rescript dated the 5th of August Muzaffar-ud-Din Shah gave his assent to the formation of a national council (*Majlis i shura i milli*), to be composed of the representatives of the various classes: princes, clergy, members of the Kajar family and tribe—chiefs and nobles, landowners, agriculturists, merchants and tradesmen. By an ordinance of the 10th of September the number of members was fixed at 162 (60 for Teheran, 102 for the provinces) to be raised to 200 if necessary, and elections were held soon after. Electors must be males and Persian subjects of not less than 25 years of age and of good repute. Landowners must possess land of at least 1000 toman (£200) in value, merchants and tradesmen must have a fixed and well-known place of business or shop with an annual value of not less than the average values in the localities where they are established. Soldiers and persons convicted of any criminal offence are not entitled to vote. The qualifications for membership are knowledge of the Persian language and ability to read and write it and good repute in the constituency. No person can be elected who is an alien, is under the age of 30 years or over the age of 70 years, is in the employ of the government, is in the active service of the army or navy, has been convicted of any criminal offence, or is a bankrupt.

On the 7th of October the national council, or as many members of it as could be got together, was welcomed by the shah and elected a president. This was considered as the inauguration and formal opening of parliament. An ordinance signed

² We see this title in its old Persian form, *Kshshayathi Kshshayathi*, in the cuneiform inscriptions as *Bashbar Barshbar* on the coins of the Arsacides, and as the Pahlavi *Mulhar Mulha* on the coins and in the inscriptions of the Sassanians. With the Mahomedan conquest of Persia and the fall of the Sassanians the title was abolished; it was in use for a short time during the 10th century, having been granted to Shah Ismail Samani by the Caliph Motadid A.D. 900; it appeared again on coins of Nadir Shah, 1736-1747, and was assumed by the present dynasty, the Kajars, in 1799.

by Muzaffar-ud-Din Shah, Mahommed Ali Mirza (his successor) and the grand vizir, on the 30th of December 1906, deals with the rescript of the 5th of August, states the powers and duties of the national council and makes provision for the regulation of its general procedure by the council itself. The members have immunity from prosecution except with the knowledge of the national council. The publicity of their proceedings except under conditions accepted by the council is secured. Ministers, or their delegates may appear and speak in the national council and are responsible to that body, which also has special control of financial affairs and internal administration. Its sanction is required for all territorial changes, for the alienation of state property, for the granting of concessions, for the contracting of loans, for the construction of roads and railways, for the ratification of treaties, &c. There was to be a senate of 60 members of whom 30 were to be appointed to represent the shah and 30 to be elected on behalf of the national council, 15 of each class being from Teheran and 15 from the provinces (the senate, however, was not immediately formed).

By a rescript dated February 2, 1907, Mahommed Ali Shah confirmed the ordinance of the 30th of December, and on the 8th of October 1907 he signed the final revised constitution, and took the oath which it prescribes on the 12th of November in the presence of the national council.

In accordance with the constitution the shah must belong to the Shiah faith, and his successor must be his eldest son, or next male in succession, whose mother was a Kajar princess. The shah's civil list amounts to 500,000 tomans (\$100,000).

The executive government is carried on under a cabinet composed of seven or eight vizirs (ministers), of whom one, besides holding a portfolio, is vizir azam, prime minister. The vizirs are the ministers of the interior, foreign affairs, war, justice, finance, commerce, education, public works.

Until 1906 the shah was assisted in the task of government by the *sadr azam* (grand vizir), a number of vizirs, ministers or heads of departments somewhat on European lines, and a "grand council of state," composed of some ministers and other members nominated by the shah himself as occasion required. Many of the "ministers" would have been considered in Europe merely as chiefs of departments of a ministry, as, for instance, the minister for Crown buildings, that for Crown domains, the minister of ceremonies, those for arsenals, army accounts, &c.; also an accumulation of several offices without any connexion between their functions, in the hands of a single person, was frequently a characteristic departure from the European model. The ministers were not responsible to the Crown in a way that ministers of a European government are; they rarely took any initiative, and generally referred their affairs to the grand vizir or to the shah for final decision.

There were twenty-seven vizirs (ministers), but only some of them were consulted on affairs of state. The departments that had a vizir at their head were the following: court, ceremonies, shah's secretarial department, interior, correspondence between court and governors, revenue accounts and budget, finance, treasury, outstanding accounts, foreign affairs, war, army accounts, military stores, arsenals, justice, commerce, mines and industries, agriculture and Crown domains, Crown buildings, public works, public instruction, telegraphs, posts, mint, religious endowments and pensions, customs, press. In addition to these twenty-seven vizirs with portfolios, there were some titular vizirs at court, like *Vizir-i-Hazar* or *Humayun* (minister of the imperial presence), *Vizir-i-Mahkhus* (extraordinary minister), &c., and a number in the provinces assisting the governors in the same way as the grand vizir assists the shah. Most of these ministers were abolished under the new constitution, and the heads of subsidiary departments are entitled *mudir* or *rats*, and are placed under the responsible ministers.

Religion.—About 9,000,000 of the population are Mahomedans of the Shiah faith, and 800,000 or 900,000, principally Kurds in north-western Persia, are said to belong to the other great branch of Islam, the Sunnah, which differs from the former in religious doctrine and historical belief, and is the state religion of the Turkish Empire and other Mahomedan countries. Other religions are represented in Persia by about 80,000 to 90,000 Christians (Armenians, Nestorians, Greek Orthodox and Roman Catholics, Protestants), 36,000 Jews, and 9000 Zoroastrians.

Society in Persia, being based almost exclusively on religious law, is much as it was in Biblical times among the Jews, with this

difference, however, that there exists no sacerdotal caste. In Persia any person capable of reading the Koran and interpreting its laws may act as a priest (*mullah*), and as soon as such a priest becomes known for his just interpretation of the *shar'* and his superior knowledge of the traditions and articles of faith, he becomes a *muftahid*, literally meaning "one who strives" (to acquire knowledge), and is a chief priest. The *mullahs* are referred to in questions concerning religious law, hold religious assemblies, preach in mosques, teach in colleges, and are appointed by the government as judges, head-preachers, &c. Thus the dignitaries, whose character seems to us specially a religious one, are in reality doctors, or expounders and interpreters of the law, and officiating ministers charged with the ordinary accomplishment of certain ceremonies, which every other Mussulman, "true believer," has an equal right to fulfil. Formerly there were only four or five *muftahids* in Persia, now there are many, sometimes several in one city—Teheran, for instance, has ten; but there are only a few whose decisions are accepted as final and without appeal. The highest authority of all is vested in the *muftahid* who resides at Kerbela, or Nejed, near Bagdad, and is considered by many *Shi'ites* as the vicegerent of the Prophet and representative of the *imam*. The shah and the government have no voice whatever in the matter of appointing *mullahs* or *muftahids*, but frequently appoint *sheikhs-ul-islam* and *cadis*, and occasionally chief priests of mosques that receive important subsidies out of government funds. The chief priest of the principal mosque of a city, the *masjid-i-jami'*, is called *imam juma'*, and he, or a representative appointed by him, reads the *khutba*, "Friday oration," and also preaches. The reader of the *khutba* is also called *khutib*. The leader of the prayers in a mosque is the *pishnamas*, and the crier to prayers is the *mu'azzin*. Many priests are appointed guardians of shrines and tombs of members of the Prophet's family (*imams* and *imamsadehs*) and are responsible for the proper administration of the property and funds with which the establishments are endowed. The guardian of a shrine is called *mutawali*, or, if the shrine is an important one with much property and many attendants, *mutawali-bashi*, and is not necessarily an ecclesiastic, for instance, the guardianship of the great shrine of Imam Reza in Meshed is generally given to a high court functionary or minister as a reward for long services to the state. In the precincts of a great shrine a malefactor finds a safe refuge from his pursuers and is lodged and fed, and from the security of his retreat he can arrange the ransom which is to purchase his immunity when he comes out.

Formerly all cases, civil and criminal, were referred to the clergy, and until the 17th century the clergy were subordinate to a kind of chief pontiff, named *sadr-us-sodar*, who possessed a very extended jurisdiction, nominated the judges, and managed all the religious endowments of the mosques, colleges, shrines, &c. Shah Safi (1629-1642), in order to diminish the influence of the clergy, appointed two such pontiffs, one for the court and nobility the other for the people. Nadir Shah (1736-1747) abolished these offices altogether, and seized most of the endowments of the ecclesiastical establishments in order to pay his troops, and the lands appropriated by him not having been restored, the clergy have never regained the power they once possessed. Many members of the clergy, particularly those of the higher ranks, have very liberal ideas and are in favour of progress and reforms so long as they are not against the *shar'*, or divine law; but, unfortunately, they form the minority.

The Armenians of Persia, in so far as regards their ecclesiastical state, are divided into the two dioceses of Azerbaijan and Isfahan, and, since the late troubles in Turkey, which caused many to take refuge in Persia, are said to number over 50,000. About three-fifths of this number belong to the diocese of Azerbaijan, with a bishop at Tabriz, and reside in the cities of Tabriz, Khof, Selmas, Urmia and Maragha, and in about thirty villages close to the north-western frontier; the other two-fifths, under the diocese of Isfahan, with a bishop in Julfa, reside in Teheran, Hamadan, Julfa, Shiraz, Bushire, Resht, Enzeli and other towns, and in some villages in the districts of Chahar Mahal, Ferdan, Barbarud, Kamarch, Kazas, Karabak, &c. Many Persian Armenians are engaged in trade and commerce, and some of

their merchants dispose of much capital, but the bulk live on the proceeds of agriculture and are poor.

The *Nestorians* in Persia, all living in cities and villages close to the Turkish frontier, numbered about 25,000 to 30,000 but many of them, some say half, together with two or three bishops, recently went over to the Greek Orthodox (Russian) Church, in consequence of the unsatisfactory protection afforded them by their patriarch, who resides in Mosul. These latter are now cared for by an arch-mandrite of Russian nationality and some Russian priests.

The *Greek Orthodox Catholics* are represented by Russians, who reside in the northern Persia; they have a church at the Russian legation in Teherán, and another at the Russian consulate in Tabriz.

The *Roman Catholics* in Persia, Europeans and natives (mostly Armenians), number about three or four thousand, and have churches in Teherán, Julfa and Azerbaijan, served by members of the French Lazarist Mission. They also have some orphanages, schools and medical dispensaries, under the care of sisters of charity of St Vincent de Paul.

The *Protestants*, Europeans and natives (converted Armenians and Nestorians), number about 6500. The religious missions ministering to their spiritual welfare are: (1) The board of foreign missions of the Presbyterian Church in the United States of America, which has six establishments in Persia: Urmia since 1835, Teherán since 1872, Tabriz since 1873, Hamadan since 1880, Resht since 1902 and Kazvin since 1903. The establishments of Tabriz and Urmia form the Western Persia Mission, those of Teherán, Hamadan, Resht and Kazvin the Eastern Persia Mission. The former mission has 24 churches, 118 schools, 2 hospitals and 4 dispensaries; the latter has 4 churches, 11 schools, 2 hospitals and 4 dispensaries. (2) The Church Missionary Society, established in Persia since 1869. In June 1908 it had 4 places of worship (Julfa, Yezd, Kermán, Shiraz), 5 schools (Julfa, Isfahan, Yezd, Kermán and Shiraz). There are also hospitals and dispensaries for men and women at Julfa, Isfahan, Yezd and Kermán. The hospitals at Julfa and Isfahan have accommodation for 100 patients each, and are sometimes full to overflowing; the dispensaries are generally overcrowded. The establishment of the Church Missionary Society is under the care of a bishop, who resides at Julfa and is under the bishop of London.

(3) The Anglican mission, which was established by Dr Benson, archbishop of Canterbury, and has its work among the Nestorians in Azerbaijan. (4) The London Society for promoting Christianity among the Jews, which was established at Teherán in 1876, and at Isfahan and Hamadan in 1889. It has in Teherán a church and a school, at Isfahan a school and at Hamadan a small school. (5) The British and Foreign Bible Society has been represented at Isfahan since 1879.

The *Jews* in Persia number about 36,000, and are found in nearly all cities of the country, but communities with synagogues and priests exist only in the larger cities like Teherán, Isfahan, Yezd, Shiraz, Hamadan, &c.

The *Zoroastrians*, commonly called "gahrs," numbering about 9000, reside principally in the cities and villages of Yezd and Kermán, and only three or four hundred live in Teherán, Kashan, Isfahan and Shiraz, some engaged in trade and commerce, but most of them employed in agricultural work and gardening. Their interests are attended to by a delegate who is appointed by the Bombay Parsis and resides at Teherán.

The non-Mussulman Persian subjects, particularly those in the provinces, were formerly much persecuted, but since 1873, when Nasru'd-Din Shah returned to Persia from his first journey to Europe they have been treated more liberally. In cities where many non-Mussulman subjects reside a special official is appointed to protect them; and the ministry of justice has a special section to look after them and see that they are protected against fanaticism and injustice.

Instruction.—Primary schools, *maktabs* (where Persian and a little Arabic, sufficient for reading the Koran, and sometimes also a little arithmetic, are taught to boys between the ages of seven and twelve), are very numerous. These schools are private establishments, and are under no supervision whatever. The payment for tuition varies from fourpence or fivepence to tenpence a month for each child. Colleges, *madrasahs* (where young men are instructed, fed, and frequently also lodged gratuitously), exist in nearly every town. Most of them are attached to mosques, and the teachers are members of the clergy, and receive fixed salaries out of the college funds. The students are instructed in Arabic and Persian literature, religion, interpretation of the Koran, Mussulman law, logic, rhetoric, philosophy and other subjects necessary for admittance to the clergy, for doctors of law, &c., while modern sciences are neglected. Families who have means and do not desire their children to become members of the clergy, employ private tutors, and several have latterly obtained the services of English and French professors to educate their children, while others send their boys to school in England, France, Germany and Russia. At

the beginning of Nasru'd-Din Shah's reign, a public school on the lines of a French lycée was opened in Teherán, principally with the object of educating officers for the army, but also of introducing a knowledge of Western science and languages, and a ministry of public instruction was created at the same time. Military and civilian teachers were obtained from Europe, and the state granted a large sum of money for the support of the establishment. The tuition is gratuitous, and the pupils are clothed and partly fed at government expense. Some years later a similar school, but on a much smaller scale, was opened in Tabriz. After a time the annual grant for the support of these two schools was reduced, and during the years 1890-1908 amounted to only £5000. The average number of pupils was about 250, and until the beginning of 1899 these two schools were the only establishments under the supervision of the minister of public instruction. Soon after his accession in 1896 Muzaffar-ud-Din Shah expressed a desire that something more should be done for public instruction, and in the following year a number of Persian notables formed a committee and opened some schools in Teherán and other places in the beginning of 1898. A year later the new schools, until then private establishments, were placed under the minister of public instruction. The new schools at Teherán have from 1000 to 1400 pupils.

A German school with an annual grant of £2400 from Persia and of £1000 from Germany was opened at Teherán in 1907. There is also established a French school under the auspices of the Alliance Française. Much has been and is being done for education by the Armenians and the Protestant and Roman Catholic missions in Persia, and a large percentage of the pupils is composed of Mussulmans. The Alliance Israélite has opened a school in Teherán. In 1907 the American Protestant mission had 129 schools with 3423 pupils, the English Protestant missions had 5 schools with 425 pupils, the Roman Catholic mission (Lazarists) had 3 schools with 400 pupils, and the Armenians had 4 schools and 646 pupils. All these schools are supported by voluntary subscriptions and donations, and instruct both boys and girls.

Army.—Persia had no regular army until 1807, when some regiments of regular infantry (*sarbas*) were embodied and drilled by the first French military mission to Persia under General Gardane. Since then seven other military missions (two British, two French, two Austrian, and one Russian) have come to Persia at the request of the Persian government, and many officers and non-commissioned officers, and even civilians, of various nationalities, have been engaged as army instructors. The last serious attempt to reorganize the Persian army was made in 1879, when the second Austrian mission formed the "Austrian corps" of seven new battalions of 800 men each. These new battalions were disbanded in 1882. The Russian mission of 1879 has been the most successful, and the so-called "Cossack brigade" which it formed has always been commanded by Russian officers. The brigade has a strength of about 1800 men and costs £50,000 per annum. The total annual expenditure for the army amounts to about a third of the total revenues of the government.

According to statistics published for 1905 the Persian army has an effective force of about 91,000 men, but not more than 35,000 are actually serving with the colours and do not exceed 35,000:—

Artillery	5309
Irregular cavalry	14,957
Infantry, 79 battalions of 400-1000 men each	63,865
Cossack brigade, artillery, horse and foot	1800
Road and frontier guards, horse and foot	5403
Total	91,334

Navy.—The Persian government possesses nine steamers. One is the "Nasru'd-Din," an old yacht of about 120 tons, presented in the seventies by the emperor of Russia, and stationed at Enzeli, the port of Resht. The others, all employed in the customs service in the Persian Gulf, are the following: The "Persepolis," built 1884, 600 tons, 450 h.p., with three 7½ cm. and one 8½ cm. Krupp. The "Susa," built 1884, 36 tons, with one Krupp. An old Belgian yacht "Selika," purchased 1905 and renamed "Muzafferi," with two Hotchkiss guns. Five launches built in the Royal Indian Marine Docks, Bombay, in 1905, at a cost of 60,000 rupees each, of about 80 tons.

Justice.—By the theory of a Mahomedan state there should be no other courts of justice except those established for the administration of the *shari*, the "divine or written law," but in Persia there is another judicature, which is called *shari* and represents the "customary" or "known and unwritten law." Justice, therefore, is administered by the shah and his representatives according to one law and by the clergy according to another, but the decisions of the former must not be opposed to the fundamental doctrines of Islam. The shah's representatives for the administration of justice are the governors and other officials already mentioned. The officials charged with the administration of justice according to the *shari* are judges, called *sheikh-ul-islam* and *kazi* (*haddi*, *kadi* or *cadi* of Arabs and Turks), members of the clergy appointed by the government and receiving a fixed salary, but some cities are without regular appointed judges and the title of *shari* is almost obsolete; decisions according to the *shari* are given by all members of the clergy, ranging from ignorant *mutahids* of little villages and cantons to learned *mutahids* of the great cities. If the parties to the suit are dissatisfied with the judgment, they may appeal to a priest who stands higher in public estimation, or one of the parties may induce a higher authority by bribery to quash the judgment of the first. Unfortunately, many members of the clergy are corrupt, but the *mutahids*, as a rule are honest and entirely trustworthy. The functions of the representatives of the *shari* are now limited to civil cases, while all criminal cases are referred to the *shari*, which, however, also takes cognizance of civil disputes, should the parties desire it.

In criminal cases the dispensation of justice is always summary, and, when the offence is small, the whole procedure, including the examination of witnesses and criminal, as well as the decision and the punishment, a *bastinado*, is a matter of some minutes. For commercial cases, not paying a bill in time, bankruptcies, &c., a kind of jurisdiction is exercised by the minister of commerce, or a board of merchants, but the decisions of the minister, or those of the board, are rarely final. In Teheran the board of merchants is presided over by the *malik ul-tujjar*, "King of Merchants," in the provincial cities by a person called *malik amir*, and *malik* of merchants.

After his second journey to Europe in 1878 Nasru'd-Din Shah desired to organize a police for the whole of Persia on the European system, but only a small body of police, in the capital and its immediate neighbourhood, was created in 1879. Its strength is 60 mounted policemen and 190 foot, with 11 superior and 40 subaltern officers.

There is also a "Tribunal of the Ministry for Foreign Affairs," presided over at Teheran by an official of the foreign office, and in the provincial cities by the *karguzars*, "agents," of that department. The functions of this tribunal are to inquire into and judge differences and suits between Persian subjects and foreigners, and it is stipulated in the treaty of Turkmanchai, which is the basis of all existing treaties between Persia and other countries, that "such differences and suits shall only be examined and judgment given in the presence of the dragoman of the mission or consulate (of the foreign subject), and that, once judicially concluded, such suits shall not give cause to a second inquiry. If, however, circumstances should be of a nature to require a second inquiry, it shall not take place without previous notice given to the minister, or the *chargé d'affaires*, or the consul, and in this case the business shall only be proceeded with at the supreme chancery of the shah at Tabriz or Teheran, likewise in the presence of a dragoman of the mission, or of the consulate." (Article viii.)

A foreign subject implicated in a criminal suit cannot be pursued or molested in any way unless there exist full proofs of his having taken part in the crime imputed to him, and should he be duly convicted of the crime, he is handed over to his legation, which either sends him back to his own country to undergo the punishment established by law, or, according to more recent usage, punishes him in Persia by fine, imprisonment, &c. In this respect the powers of the foreign representatives in Persia, now numbering ten (Great Britain, Russia, France, Turkey, Austria-Hungary, Germany, United States of America, Italy, Belgium and the Netherlands) vary considerably, some having the power of condemning a criminal to death, while others cannot do more than fine and imprison for short periods. Suits, civil and criminal, between foreign subjects are altogether out of Persian jurisdiction, and are judged by the representatives of the foreign powers accredited to Persia.

In 1889, after Nasru'd-Din Shah's return from his third visit to Europe, the council of state was instructed to compile a code of law for the regulation of justice. A beginning was made by ordering the translation of the Code Napoléon, the Indian Mahomedan code, and the Code Napoléon as modified for Algeria; but nothing further was done.

Finance.—The fixed revenues of Persia are derived from (i) regular taxation (*malial*) composed of taxes on lands, flocks, herds, shopkeepers, artisans and trade; (2) revenues from Crown lands; (3) customs; (4) rents and leases of state monopolies. There is also a kind of irregular revenue derived from public requisitions, presents, fines, confiscations, &c., nowadays not producing much. The land tax, which varies according to localities, is paid in money

and kind, and should amount on an average to about 25% of the yield of the soil. The taxation on flocks and herds exists either as a supplementary method of land taxation, or as a contribution of a certain sum per animal, and the tax on shopkeepers, artisans and trades sometimes takes the form of a poll-tax, sometimes that of an impost on the profits of the trades. The revenue from Crown lands consists of a certain proportion of the produce, and also varies much according to localities. Until March 1899 all the customs were farmed out, but since then they have been organized on European principles, with the help of Belgian officials. By treaties with Russia and Great Britain, concluded in 1901 and 1903 respectively, the 5% duty fixed by the Turkmanchai treaty was abolished, and an equitable tariff was established. The revenues from rents and leases of state monopolies are derived from posts, telegraphs, mines, mint, forests, banks, fisheries, factories, &c., and amount to about £110,000 per annum.

The total revenue of Persia, from all sources, amounted in 1876 to 58,700,000 kranas, in 1884 to 50,800,000, in 1890 to 60,000,000; and in 1907-1908 to about 80,000,000 kranas. This would seem to show a steady increase, but when we consider that the value of the kran in 1876 was nearly 8½ d., and has fallen in consequence of the great depreciation of silver to only 4½ d., the total revenue really decreased from £1,950,000 in 1876 to £1,600,000 in 1907-1908. Out of the actual total revenue £500,000 is represented by customs and £110,000 by rents and leases of state monopolies, leaving £990,000 for malial and revenues of Crown lands. In 1876 the two latter items amounted to about £1,600,000, while the two former were only £350,000 instead of £610,000 in 1907-1908. While the prices in kranas of agricultural produce, and hence the profits of the landowners and the wages and profits of artisans and tradesmen, were in 1907-1908 more than double what they were in 1876, the malial, the backbone of the revenue, has hardly increased at all, being 50,000,000 kranas (£1,000,000) against 43,200,000 kranas (£1,600,000) in 1876, and showing a decrease of over 37% in sterling money. A new assessment of the malial, based upon the present value of the produce of lands and actual profits of artisans and tradesmen, has frequently been spoken of, and government, aided by a strong minister of the interior and an able minister of finance, ought to have no difficulty in raising the malial to its proper level and the total revenues of the country to about two millions sterling.

Until 1888 the yearly expenditure was less than the yearly income, but subsequently the revenues were not sufficient to cover the expenditure, and many payments fell in arrear in spite of emptying the treasury of its reserve and contracting numerous loans.

In May 1892 the Persian government concluded a contract with the Imperial Bank of Persia, established by British royal charter in 1889, for a loan of £500,000 at 6% repayable in the course of forty years, and guaranteed by the customs of Fars and the Persian Gulf ports. The produce of this loan served for the payment of an indemnity to the Imperial Tobacco Corporation, which began in 1890 and had to cease its operations in January 1892. In January 1900 the Persian government, in order to pay the arrears and start afresh with a clear balance-sheet, contracted a loan through the Banque des Prêts de Perse, a Russian institution connected with the Russian state bank, and established in 1890. This loan was for 22½ million roubles (£2,400,000) at 4% interest, guaranteed by all the Persian customs with the exception of those of Fars and the Persian Gulf ports, and repayable in the course of seventy-five years. In the contract, which was signed at St Petersburg at the end of January 1900, the Persian government undertook to redeem all its former foreign obligations (the 1892 loan) out of the proceeds of the new loan, and not to contract any other foreign loan before the redemption of the new loan without the consent of the Russian bank. The loan was at 8½, less 1½ for commission and charges, the Persian government thus receiving 85% of the nominal capital, or £2,040,000. The bonds enjoy the full guarantee of the Russian government. The yearly charge for interest and amortization, about £124,000, is to be paid in two half-yearly instalments, and in the event of default the Russian bank will have the right to exercise effective control of the customs with a maximum number of twenty-five European employés. When the contract for the new loan was concluded, the liabilities of the Persian government for the balance of the 1892 loan (about £435,000), temporary loans from various banks, arrears of pays and salaries, and other debts, amounted to over £1,500,000, so that not much margin was left. The shah's visit to Europe in the same year cost the exchequer about £180,000. In March 1902 the Russian bank agreed to grant a further loan of 10 million roubles on the same conditions as those of the first loan, and the whole amount was paid by the end of the year, but another visit of the shah to Europe and excessive expenditure at home made the position worse than before. After November 1903 the expenditure was reduced, and the new customs tariff which came into force on the 14th of February 1903 increased the revenue by nearly 200,000 per annum; it was thought that the expenditure would not exceed the receipts, even if the shah undertook a third voyage to Europe (which he did in 1905). However, in November 1907, when the national assembly or council demanded a budget and made inquiries as to the financial position, it was found that the expenditure for

some years past had been half a million sterling per annum in excess of the receipts and that considerable sums were owing to banks and commercial firms who had lent money. Most of the money borrowed is at 12 to 15% interest.

Banking.—It was only in 1888 that a European bank (the New Oriental Bank Corporation, Limited) established itself in Persia and modern ideas of banking were introduced into the country. Until then the banking was done by the native money-changers (*sarrafs*) and some merchants—foreign and native—who occasionally undertook special outside transactions. In 1889 the shah granted a concession to Baron Julius de Reuter for the formation of a state bank with the exclusive right of issuing bank-notes—not exceeding £800,000 without special assent of the Persian government—on the basis of the local currency, the silver kran. With the title of "The Imperial Bank of Persia" the bank was formed in the autumn of the same year, and incorporated by royal charter granted by Queen Victoria and dated the 2nd of September 1889. The authorized capital was four millions sterling, but the bank started with a capital of one million, and began its business in Persia in October 1889. In April 1890 it took over the Persian business of the New Oriental Bank Corporation, soon afterwards opened branches and agencies at the principal towns, and issued notes in the same year. During the first two years the bank remitted the greater part of its capital to Persia at the then prevailing exchange, and received for every pound sterling 32 to 34 krans; but in consequence of the great fall in silver in 1893 and 1894, the exchange rose to 50 krans per pound sterling and more, and the bank's capital employed in Persia being reduced in value by more than one-third—100 krans, which at the beginning represented £3, then being worth only £2 or less—the original capital of one million sterling was reduced to £650,000 in December 1894. The bank has made steady progress in spite of innumerable difficulties, and paid a fair dividend to its shareholders. In his paper on "Banking in Persia" (*Journal of the Institute of Bankers*, 1891), Mr. Joseph Rabins pointed out the great difficulties which make the easy distribution of funds—that is, the providing them when and where required—a matter of impossibility in Persia, and gives this fact as the reason why the Imperial Bank of Persia has local issues of notes, payable at the issuing branches only, "for, in a country like Persia, where movements of specie are so costly, slow and difficult as to become impracticable except on a small scale, the danger of issuing notes payable at more than one place is obvious." On the 20th of September 1907 the value of the notes in circulation was £395,000, and the bank held £550,000 deposits in Persia.

In 1889 the shah also granted a concession to Jaques de Potiakov of St Petersburg for the establishment of a "loan bank," or, as the original concession said, "mont-de-piété," with exclusive rights of holding public auctions. A company was formed in the same year and started business at Teheran in 1890 as the "Banque des Prêts de Perse." After confining its operations for some years to ordinary pawnbroking, without profits, it obtained the aid of the Russian State Bank, acquired large premises in Teheran, made advances to the Persian government (since 1898), and in January 1900 and March 1902 financed the loans of £2,400,000 and £1,000,000 to Persia. It has branches at Tabriz, Resht, Meshed and other places.

Various Armenian firms, one with branches at many places in Persia and Russia, also do banking business, while various European firms at Tabriz, Teheran, Isfahan, Shiraz and Bushire, facilitate remittances between Europe and Persia.

The chief business of the native *sarrafs* (money-changers, bankers, &c.) is to discount bills at high rates, hardly ever less than 12%, and remit money from place to place in Persia for a commission amounting to from 1 to 5, or even 6% on each transaction; and in spite of the European banks giving lower rates of discount and remitting money at par, the majority of the people and mercantile classes still deal with the natives. For advances with good security a native *sarraf* charges at least 12% interest per annum; as the security diminishes in value the rate of interest increases, and transactions at 10% a month, or more than 120% per annum, are not infrequent. A Persian who obtains an advance of money at less than 12% considers that he gets money "for nothing."

(A. H. S.)

HISTORY

A.—Ancient, to the Fall of the Sassanid Dynasty.

I. *The Name.*—"Persia," in the strict significance of the word, denotes the country inhabited by the people designated as Persians, i.e. the district known in antiquity as Persis (q.v.), the modern Fars. Custom, however, has extended the name to the whole Iranian plateau; and it is in this sense that the term Persia is here employed.

II. *Ancient Ethnography.*—In historical times we find the major portion of Iran occupied by peoples of Indo-European origin, terming themselves Aryans (*Arya*; Zend, *Airya*) and their language Aryan—so in the inscriptions of Darius—the

same name, which is used by the consanguineous tribes of India who were their nearest relations. The whole country is designated Ariana (Zend, *Airyana*)—"the land of the Aryans"—the original of the Middle-Persian *Eran* and the modern *Iran*; the Greek geographers Eratosthenes and Strabo were in error when they limited the name to the eastern districts of Iran. Thus the name of Iranians is understood to comprehend all these people of Aryan nationality.

Besides the Iranians, numerous tribes of alien origin were found in Iran. In Baluchistan, even yet, we find side by side with the eponymous Iranian inhabitants, who only penetrated thither a few centuries ago, the *Alles Tribes in Iran*. ethnologically and philologically distinct race of the Brahui, who are probably connected with the Dravidians of India. In them we may trace the original population of these districts; and to the same original population may be assigned the tribes here settled in antiquity: the Paricani and Gedrosii (Gadrosii), and the Myci (Herod. iii. 93, vii. 68; the *Maka* of Darius, the modern *Mekran*), to whom the name "Aethiopians" is also occasionally applied (Herod. iii. 94, vii. 70). In Media the Greek geographers mention a people of Anariacae (Strabo xi. 508, 514; Pliny, *Nat. Hist.* vi. 48; Ptolem. vi. 25; in Polyb. v. 44. 9, *Ἀναρῆται*), i.e. "Non-Aryans." To these the Tapuri, Amardi, Caspii, and especially the Cadusii or Gelae—situated in Ghilan on the Caspian—probably belonged. Presumably they were also related to the tribes of Armenia and the Caucasus. In the chains of Zagros we find, in Babylonian and Assyrian times, no trace of Iranians; but partly Semitic peoples—the Gutaeans, Lulubaeans, &c.—partly tribes that we can refer to no known ethnological group, e.g. the Coesaei (see below), and in Elymais or Susiana the Elymaeans (Elamites).

That the Iranians must have come from the East to their later home, is sufficiently proved by their close relationship to the Indians, in conjunction with whom they previously formed a single people, bearing the name *Arya* and *Aryans Arya*. Their residence must have lain chiefly in the great steppe which stretches north of the Black Sea and the Caspian, through South Russia, to Turan (Turkestan) and the Oxus and Jaxartes. For here we continually discover traces of Iranian nationality. The names and words of the Scythians (*Scythi*) in South Russia, which Herodotus has preserved, are for the most part perfectly transparent Iranian formations, identified by Zeus and Müllenhoff; among them are many proper names in *Aria* (*Ario*-) and *aspa* (-horse-*auros*; Zend, *aspa*). The predatory tribes of Turan (e.g. the Massagetae) seem to have belonged to the same stock. These tribes are distinguished by the Iranian peasants as *Daha* (Gr. *ἄδαι*), "enemies," "robbers"; by the Persians as *Sacae*; and by the Greeks generally as Scythians.

From the region of the steppes the Aryans must have penetrated into the cultivable land of Eastern Iran: thence one part spread over the district of the Indus, then on again to the Ganges; another moved westward to Zagros and the borders of the Semitic world.

The date of this migration cannot yet be determined with certainty. We know only that the Aryans of India already occupied the Punjab in the Vedic era, c. 1600 B.C. On the other hand, about the same period a number of names, undoubtedly Iranian, made their appearance in Western Asia, (cf. Edward Meyer, "Zur ältesten Geschichte der Iraner," in *Zeitschrift für vergleichende Sprachforschung*, 1907). In the cuneiform letters from Tell el-Amarna in Egypt (1400 B.C.), we find among the princelings of Syria and Palestine names like *Ariamanyu*, *Arasviya*, *Skuwardata*, a name terminating in *-warsana*, &c.; while the kings of Mitanni on the Euphrates are *Ariakama*, *Shutarna*, *Ariashumara*, and *Dushratta*—names too numerous and too genuinely Iranian to allow of the hypothesis of coincidence. Later still, in the Assyrian inscriptions we occasionally meet with Iranian names borne by North-Syrian princes—e.g. Kundaspi and

Kastasi (=Hystaspis). Their subjects, on the contrary, speak absolutely different tongues: for the attempts to explain the languages of the Cossaeans, Mitanniens, and Arzapians as Indo-European (Iranian) have ended in failure (cf. Blomfield in the *American Journal of Philology*, xxv. p. 1 sqq.).

It appears, then, that towards the middle of the second millennium before Christ, the Iranians made a great forward movement to the West, and that certain of their princes—at first, probably in the rôle of mercenary leaders—reached Mesopotamia and Syria and there founded principalities of their own, much as did the Germans under the Roman Empire, the Normans, Turks, &c. With this we may probably connect the well-known fact that it was about this very period (1700 B.C. approximately) that the horse made its appearance in Babylonia, Egypt and Greece, where for centuries subsequently its use was confined to war and the war-chariot. Before this it was as foreign to the Babylonians, even in the time of Khammurabi, as to the Egyptians under the XIIth Dynasty. On the other hand, it had been familiar to the Aryans from time immemorial: indeed they have always been peculiarly a people of riders. Thus it is quite conceivable that they brought it with them into Western Asia: and the quarter from which it came is sufficiently indicated by the fact that the Babylonians write the word "horse" with a group of signs denoting "ass of the East."

Of the Assyrian kings, Shalmaneser (Salmanassar) II. was the first to take the field against the Medes in 836 B.C., and from that period onwards they are frequently mentioned in the Assyrian annals. Sargon penetrated farthest, receiving in 715 B.C. the tribute of numerous Median town-princes. He gives a list of their names, twenty-three of which are preserved either wholly or in part, and almost all are unmistakably Iranian; as is also the case with those preserved by Esar-haddon (Assarhaddon) and elsewhere.

The Medes, then, were an Iranian nation, already occupying in the 9th century B.C. their later home in the centre of the Median highland. On the other hand, among their neighbours in Zagros and the north—corresponding to the Anariacae (Non-Aryans) of the Greeks—Iranian names are at best isolated phenomena. With other Iranian tribes the Assyrians never came in contact: for the oft-repeated assertion, that the Parsua, so prominent in their annals, were the Persians or the Parthians, is quite untenable. The Parsua of the Assyrians are located south of Lake Urmia, and can hardly have been Iranians.

None the less, the Assyrian statements with regard to the Medes demonstrate that the Iranians must have reached the west of Iran before 900 B.C. It is probable that at this period the Persians also were domiciled in their later home, even though we have no direct evidence to adduce. If this reasoning is correct, the Iranian immigration must be assigned to the first half of the second pre-Christian millennium.

The Aryans of Iran are divided into numerous tribes; these, again, being subdivided into minor tribes and clans. The principal, according to the inscriptions of Darius the Great, which closely agree with Herodotus—are the following, several of them being also enumerated in the *Avesta*—

1. The Medes (*Mada*) in the north-west (see MEDIA).
2. The Persians (*Parsa*) in the south (see PERSIS). To these belong the Carmanians and the Utians (*Yutiyā*), who are mentioned expressly by Darius as inhabiting a district in Persis (*Beh.* III. 40).
3. The Hyrcanians (*Varkāna* in Darius, *Zand Vahrkāna*) on the eastern corner of the Caspian, in the fertile district of Astarabad.
4. The Parthians (*Parthiyasi*; Pers. *Parthava*) in Khorasan (see PARTHIA).
5. The Arians (*Āriaia*, Pers. *Āriāna*), in the vicinity of the river Arius (*Hērī-rūd*), which derived its name from them. This name, which survives in the modern Herat, has of course no connexion with that of the Aryans.
6. The Drangians (*Zaranka* in Darius, *Sarangians* in Herod. iii. 93, 117, vii. 67), situated south of the Arians, in the north-west of Afghanistan (*Arachosia*) by the western affluents of Lake Hamun, and extending to the present Seistan.
7. Arachotians (Pers. *Harāmāta*), in the district of the Helmand and its tributaries, round Kandahar. They are mentioned in the lists of Darius, also by the Greeks after Alexander. In Herodotus their place is taken by the Paotyans, whose name survives to the

present day in the word *Pashū*, with which the Afghans denote their language (Herod. iii. 102, iv. 44, vii. 67, 85). Probably it was the old tribal name; Arachosia being the local designation. The Thamanseans, who appear in Herodotus (iii. 93, 117), must be classed with them.

8. The Bactrians (Pers. *Bākhtri*), on the northern declivity of the Hindu Kush, as far as the Oxus. Their capital was Bactra, the modern *Balkh* (see BACTRIA).

9. The Sogdians (Pers. *Sagāsā*), in the mountainous district between the Oxus and Jaxartes.

10. The Chorasmians (Khwarizmians, Pers. *Uvarasviya*), in the great oasis of Khiva, which still bears the name Khwarizm. They stretched far into the midst of the nomadic tribes.

11. The Margians (Pers. *Margā*), on the river Margus (Murgab); chiefly inhabiting the oasis of Merv, which has preserved their name. Darius mentions the district of Margu but, like Herodotus, omits them from his list of peoples; so that ethnographically they are perhaps to be assigned to the Arians.

12. The Sagartians (Pers. *Asagarta*); according to Herodotus (vii. 85), a nomadic tribe of horsemen; speaking, as he expressly declares, the Persian language. Hence he describes them (l. 125) as a subordinate nomad clan of the Persians. They, with the Drangians, Utians and Myci, formed a single satrapy (Herod. iii. 93). Ptolemy (vi. 2, 6) speaks of Sagartians in the Eastern Zagros in Media.

13. We have already touched on the nomadic peoples (*Dāka*, *Dakans*) of Iranian nationality, who occupied the steppes of Turkestan as far as the Sarmatians and Scythians of South Russia. That these were conscious of their Aryan origin is proved by the names *Ariantās* and *Ariapeitās* borne by Scythian (Scolot) kings (Herod. iv. 76, 87). Still they were never counted as a portion of Iran or the Iranians. To the settled peasantry, these nomads of the steppe were always "the enemy" (*dāna*, *dāka*, *dāta*, *Dakae*). Side by side with this name we find "Tūrān" and "Turanian"; a designation applied both by the later Persians and by modern writers to this region. The origin of the word is obscure, derived perhaps from an obsolete tribal name. It has no connexion whatever with the much later "Turks," who penetrated thither in the 6th century after Christ. Though found neither in the inscriptions of Darius nor in the Greek authors, the name Turan must nevertheless be of great antiquity; for not merely is it repeatedly found in the *Avesta*, under the form *Tura*, but it occurs already in a hymn, which, without doubt, originates from Zoroaster himself, and in which "the Turanian *Fryāna*" and his descendants are commemorated as faithful adherents of the prophet (*Yassa*, 46, 62).

The dividing line between Iranian and Indian is drawn by the Hindu Kush and the Soliman mountains of the Indus district. The valley of the Kabul (*Cophen*) is already occupied by Indian tribes, especially the Gandarians; and the Satagydae (Pers. *Thalaga*) there resident were presumably also of Indian stock. The non-Aryan population of Iran itself has been discussed above. Of its other neighbours, we must here mention the Sacae, a warlike equestrian people in the mountains of the pamir plateau and northward; who are probably of Mongol origin. Herodotus relates that the Persians distinguished "all the Scythians"—i.e. all the northern nomads—as Sacae; and this statement is confirmed by the inscriptions of Darius. The Babylonians employ the name *Gimirī* (i.e. Cimmerians) in the same sense.

III. *Civilization and Religion of the Iranians.*—In the period when the ancestors of Indian and Iranian alike still formed a single nation—that of the Aryans—they developed a very marked character, which can still be distinctly traced, not only in their language, but also in their religion and in many views common to both peoples. A great number of gods—Asura, Mithras, the Dragon-slayer Verethraghna (the Indra of the Indians), the Water-shoot Apam napat (the lightning), &c.—date from this era. So, too, fire-worship, especially of the sacrificial flame; the preparation of the intoxicating *soma*, which fills man with divine strength and uplifts him to the gods; the injunction to "good thoughts and good works," imposed on the pious by Veda and Avesta alike: the belief in an unwavering order (*rita*)—a law controlling gods and men and dominating them all; yet with this, a belief in the power of magical formulae (*mantra*), exclamations and prayers, to whose compulsion not merely demons (the evil spirits of deception—*drak*) but even the gods (*daeva*) must submit; and, lastly, the institution of a priesthood of fire-kindlers (*athravasa*), who are at once the repositories of all sacred traditions and the mediators in all intercourse between earth and heaven. The transition, moreover, to settled life and agriculture belongs to the Aryan

Aryan Religion.

period; and to it may be traced the peculiar sanctity of the cow in India and Persia. For the cow is the animal which voluntarily yields nourishment to man and aids him in his daily labours, and on it depends the industry of the peasant as contrasted with the wild desert brigand to whom the cow is unknown.

Very numerous are the legends common to both nations. These, in part, are rooted in the primeval Indo-European days, though their ultimate form dates only from the Aryan epoch. Foremost among them is the myth relating the battle of a sun-god (Ind. *Trita*, generally replaced by *Indra*, Iran. *Thraetona*) against a fearful serpent (Ind. *Ahi*, Iran. *Azhi*; known moreover as *Vrtra*): also, the legend of Yama, the first man, son of Vivasvant, who, after a long and blessed life in the happy years of the beginning, was seized by death and now rules in the kingdom of the departed. Then come a host of other tales of old-world heroes; as the "Glorious One" (Ind. *Sushrava*, Pers. *Husrava*, *Chosrau* or *Chosroes*), or the Son who goes on a journey to seek his father, and, unknown, meets his end at his hands.

These legends have lived and flourished in Iran at every period of its history; and neither the religion of Zoroaster, nor yet Islam, has availed to suppress them. Zoroastrianism—at least in that form in which it became the dominant creed of the Iranians—legitimized not only the old gods, but the old heroes also; and transformed them into pious helpers and servants of Ahuramazda; while the creator of the great national epic of Persia, Firdousi (A.D. 935-1020), displayed astonishing skill in combining the ancient tradition with Islam. Through his poem, this tradition is perfectly familiar to every Persian at the present day; and the primitive features of tales, whose origin must be dated 4000 years ago, are still preserved with fidelity. This tenacity of the Saga stands in the sharpest contrast with the fact that the historical memory of the Persian is extremely defective. Even the glories of the Achaemenid Empire faded rapidly, and all but completely, from recollection; so also the conquest of Alexander, and the Hellenistic and Parthian eras. In Firdousi, the legendary princes are followed, almost without a break, by Ardashir, the founder of the Sassanid dynasty: the intervening episode of Darius and Alexander is not drawn from native tradition, but borrowed from Greek literature (the Alexander-romance of the Pseudo-Callisthenes) in precisely the same way as among the nations of the Christian East in the middle ages.¹

Needless to say, however, this long period saw the Saga much recast and expanded. Many new characters—Siyawush, Rostam, &c.—have swelled the original list: among them is King Gushtasp (Vishtaspa), the patron of Zoroaster, who was known from the poems of the prophet and is placed at the close of the legendary age. The old gods and mythical figures reappear as heroes and kings, and their battles are fought no longer in heaven but upon earth, where they are localized for the most part in the east of Iran. In other words, the war of the gods has degenerated to the war between Iranian civilization and the Turanians. Only the evil serpent Azhi Dahaka (Azhdahak) is domiciled by the *Avesta* in Babylon (*Bawr*) and depicted on the model of Babylonian gods and demons: he is a king in human form with a serpent growing from either shoulder and feeding on the brains of men. In these traits are engrained the general conditions of history and culture, under which the Iranians lived: on the one hand, the contrast between Iranian and Turanian; on the other, the dominating position of Babylon, which influenced most strongly the civilization and religion of Iran. It is idle, however, to read definite historical events into such traits, or to attempt, with some scholars, to convert them into history itself. We cannot deduce from them a conquest of Iran from Babylon: for the Babylonians never set foot in Iran, and even the Assyrians merely conquered the western portion of Media. Nor yet can we make the favourite assumption of a great empire in Bactria. On the contrary, it is historically

¹ The fundamental work on the history of the Iranian Saga is Nöldeke, *Das iranische Nationalepos 1896* (reprinted from the *Grundriss der iran. Philologie*, ii.).

evident that before the Achaemenids there were in Bactria only small local principalities of which Vishtaspa's was one: and it is possible that the primeval empire of the Saga is only a reflection of the Achaemenid and Sassanid empires of reality, whose existence legend dates back to the beginning of the world, simply because legend is pervaded by the assumption that the conditions obtaining in the present are the natural conditions, and, as such, valid for all time.

Closely connected as are the Mythology and Religion of Indian and Iranian, no less clearly marked is the fundamental difference of intellectual and moral standpoint, which has led the two nations into opposite paths of history and culture. The tendency to religious thought and to a speculative philosophy, comprehending the world as a whole, is shared by both and is doubtless an inheritance from the Aryan period. But with the Indians this speculation leads to the complete abolition of all barriers between God and man, to a mystic pantheism, and to absorption in the universal Ego, in contrast with which the world becomes an unsubstantial phantasm and sinks into nothingness. For the Iranian, on the contrary, practical life, the real world, and with them the moral commandment, fill the foreground. The new gods created by Iran are ethical powers; those of India, abstractions of worship (*brahman*) or of philosophy (*atman*). These fundamental features of Iranian sentiment encounter us not only in the doctrine of Zoroaster and the confessions of Darius, but also in that magnificent product of the Persia of Islam—the Sufi mysticism. This is pantheistic, like the Brahman philosophy. But the pantheism of the Persian is always positive,—affirming the world and life, taking joy in them, and seeking its ideal in union with a creative god: the pantheism of the Indian is negative—denying world and life, and desecrating its ideal in the cessation of existence.

This contrast in intellectual and religious life must have developed very early. Probably, in the remote past violent religious disputes and feuds broke out: for otherwise it is almost inexplicable that the old Indo-European word, which in India, also, denotes the gods—*devo*—should be applied by the Iranians to the malignant demons or devils (*daeo*; mod. *dia*); while they denote the gods by the name *ahya*. Conversely the *Asuras*, whose name in Iran is the title of the supreme god (*akura*, *aura*), have in India degenerated to evil spirits. It is of great importance that among the Slavonic peoples the same word *bogu* distinguishes the deity; since this points to ancient cultural influences on which we have yet no more precise information. Otherwise, the name is only found among the Phrygians, who, according to Hesychius, called the Heaven-god (Zeus) Bagneus; there, however, it may have been borrowed from the Persians. We possess no other evidence for these events; the only document we possess for the history of Iranian religion is the sacred writing, containing the doctrines of the prophet who gave that religion a new form. This is the *Avesta*, the Bible of the modern Parsee, which comprises the revelation of Zoroaster.

As to the home and time of Zoroaster, the Parsee tradition yields us no sort of information which could possibly be of historical service. Its contents, even if they go back to lost parts of the *Avesta*, are merely a late patch-work, based on the legendary tradition and devoid of historical foundation. The attempts of West (*Pahlavi Texts Translated*, vol. v.) to turn to historical account the statements of the *Bundahish* and other Parsee books, which date Zoroaster at 258 years before Alexander, are, in the present writer's opinion, a complete failure. Jackson (*Zoroaster, the Prophet of Ancient Iran*, 1901) sides with West. The Greek theory, which relegates Zoroaster to the mists of antiquity, or even to the period of the fabulous Ninus and Semiramis, is equally valueless. Even the statement that he came from the north-west of Media (the later Atropatene), and his mother from Rai (Rhagae) in eastern Media, must be considered as problematic in the extreme. Our only trustworthy information is to be gleaned from his own testimony and from the history of his religion. And here we may take it as certain that the scene of his activity was laid in

the east of Iran, in Bactria and its neighbouring regions. The contrast there existing between peasant and nomad is of vital consequence for the whole position of his creed. Among the adherents whom he gained was numbered, as already mentioned, a Turanian, one Fryana and his household. The west of Iran is scarcely ever regarded in the *Avesta*, while the districts and rivers of the east are often named. The language, even, is markedly different from the Persian; and the fire-priests are not styled Magians as in Persia—the word indeed never occurs in the *Avesta*, except in a single late passage—but *athravan*, identical with the *atharvan* of India (*śrīpado*, "fire-kindlers," in Strabo xv. 733). Thus it cannot be doubted that the king Vishtaspa, who received Zoroaster's doctrine and protected him, must have ruled in eastern Iran: though strangely enough scholars can still be found to identify him with the homonymous Persian Hystaspes, the father of Darius. The possibility that Zoroaster himself was not a native of East Iran, but had immigrated thither (from Rhagæ?), is of course always to be considered; and this theory has been used to explain the phenomenon that the Gathas, of his own composition, are written in a different dialect from the rest of the *Avesta*. On this hypothesis, the former would be his mother-tongue: the latter the speech of eastern Iran.

This district is again indicated as the starting-point of Zoroastrianism, by the fact that dead bodies are not embalmed and then interred, as was usual, for instance, in Persia, but cast out to the dogs and birds (cf. Herod. i. 140), a practice, as is well known, strictly enjoined in the *Avesta*, ruthlessly executed under the Sassanids, and followed to the present day by the Parsees. The motive of this, indeed, is to be found in the sanctity of Earth, which must not be polluted by a corpse; but its origin is evidently to be traced in a barbaric custom of nomadic or semi-nomadic tribes who leave the dead to lie on the steppe; and we know from Greek sources that this custom was widely diffused among the tribes of eastern Iran.

The next clue towards determining the period of Zoroaster is, that Darius I. and all his successors, as proved by their inscriptions and by Greek testimony, were zealous adherents of the pure word of Zoroastrianism; which consequently must already have been accepted in the west of Iran. That Cyrus too owned allegiance to the creed, cannot be doubted by an unprejudiced mind, although in the dearth of contemporary monuments we possess no proof at first hand. The Assyrian inscriptions demonstrate, however, that Zoroaster's teaching was dominant in Media two centuries before Cyrus. For in the list of Median princes, to which we have already referred, are two bearing the name of Mazda—evidently after the god Mazda. Now this name was the invention of Zoroaster himself; and he who names himself after Mazda thereby makes a confession of faith in the religion of Zoroaster whose followers, as we know, termed themselves Mazdayasna, "worshippers of Mazda."

Thus, if the doctrine of Zoroaster predominated in Media in 714 B.C., obviously his appearance in the rôle of prophet must have been much earlier. A more definite date cannot be deduced from the evidence at our disposal, but his era may safely be placed as far back as 1000 B.C.

The religion which Zoroaster preached was the creation of a single man, who, having pondered long and deeply the problems of existence and the world, propounded the solution he found as a divine revelation. Naturally he starts from the old views, and is indebted to them for many of his tenets and ideas; but out of this material he builds a uniform system which bears throughout the impress of his own intellect. In this world, two groups of powers confront each other in a timeless war, the powers of Good, of Light, of creative Strength, of Life and of Truth, and the powers of Evil, of Darkness, Destruction, Death and Deceit. In the van of the first stands the Holy Spirit (*spenta mainyu*) or the "Great Wisdom" Mazdao. His helpers and vassals are the six powers of Good Thought (*vohu manô*, "Quarrels"), of Right Order (*asha*, Ind. *ṛta*, Pers. *arîta*, "lawfulness"), of the Excellent Kingdom (*khskaithra vaîrya*), of Holy Character (*spenta Armaiti*), of Health (*haurovatî*), and of Immortality (*amertaiti*). These are comprised under the general title of "undying holy ones" (*amashê spenta, amehaspand*); and a host of subordinate angels (*yasna*) are ranked with them.

The powers of evil are in all points the opposite of the good; at their head being the Evil Spirit (*angra mainyu, Ahriman*). These evil demons are identical with the old gods of the popular faith—the *devas* (div)—while Mazda bears the name *Akura*, above discussed; whence *Ahuramazda* (Ormuzd).

From this it will be manifest that the figures of Zoroaster's religion are purely abstractions; the concrete gods of vulgar belief being set aside. All those who do not belong to the *devas* (*deas*), might be recognized as inferior servants of Ahuramazda: chief among them being the Sun-god Mithras (see MITHRAS); the goddess of vegetation and fertility, especially of the Oxus-stream, *Anahita Ardivisura* (*Anahiti*); and the Dragon-slayer *Vrethraghna* (*Gr. Artagnes*), with the god of the intoxicating *Haoma* (the Indian *Soma*). In the religion of the people, these divinities always survived; and the popularity of Mithras is evinced by the numerous Aryan proper names thence derived (Mithradates, &c.). The educated community who had embraced the pure doctrine in its completeness scarcely recognized them, and the inscriptions of Darius ignore them. Only once he speaks of "the gods of the clans," and once of "the other gods which there are." Not till the time of Artaxerxes II. were Mithra and Anahiti received into the official religion of the Persian kings. But they always played a leading part in the propaganda of the Persian cults in the West.

Only one element in the old Aryan belief was preserved by Zoroaster in all its sanctity: that of Fire—the purest manifestation of Ahuramazda and the powers of Good. Thus fire-altars were everywhere erected; and, to the prophet also, the Fire-kindlers (*athravan*) were the ministers and priests of the true religion and the intermediaries between God and man; at last in the popular mind, Zoroastrianism was identified with Fire-worship pure and simple, —inadequate though the term in reality is, as a description of its essentials.

Midway in this opposition of the powers of Good and Evil, man is placed. He has to choose on which side he will stand: he is called to serve the powers of Good: his duty lies in speaking the truth and combating the lie. And this is fulfilled when he obeys the commands of law and the true order; when he tends his cattle and fields, in contrast with the lawless and predatory nomad (*Dahae*); when he wars on all harmful and evil creatures, and on the devil-worshippers; when he keeps free from pollution the pure creations of Ahuramazda—fire foremost, but also earth and water; and, above all, when he practises the Good and True in thought, word and work. And as his deeds are, so shall be his fate and his future lot on the Day of judgment; when he must cross the Bridge *Crowat*, which, according to his works, will either guide him to the Paradise of Ahuramazda or precipitate him to the Hell of Ahriman. Obviously, it was through this preaching of a judgment to come and a direct moral responsibility of the individual man, that, like Mahomet among the Arabs, Zoroaster and his disciples gained their adherents and exercised their greatest influence.

In this creed of Zoroastrianism three important points are especially to be emphasized: for on them depend its peculiar characteristics and historical significance:—

1. The abstractions which it preaches are not products of metaphysical speculation, as in India, but rather the ethical forces which dominate human life. They impose a duty upon man, and enjoin on him a positive line of action—a definite activity in the world. And this world he is not to eschew, like the Brahman and the Buddhist, but to work in it, enjoying existence and life to the full. Thus a man's birthday is counted the highest festival (Herod. i. 133); and thus the *joie de vivre*, rich banquets and carousals are not rejected by the Persian as godless and worldly, but are even prescribed by his religion. To create offspring and people the world with servants of Ahuramazda is the duty of every true believer.¹

2. This religion grew up in the midst of a settled peasant population, whose mode of life and views it regards as the natural disposition of things. Consequently, it is at once a product of, and a main factor in civilization; and is thereby sharply differentiated from the Israelite religion, with whose moral precepts it otherwise coincides so frequently.

3. The preaching of Zoroaster is directed to each individual man, and requires of him that he shall choose his position with regard to the fundamental problems of life and religion. Thus, even though it arose from national views, in its essence it is not national (as, for instance, the Israelite creed), but individualistic, and at the same time universal. From the first, it aims at propaganda; and the nationality of the convert is a matter of indifference. So Zoroaster himself converted the Turanian Fryana with his kindred (see above); and the same tendency to proselytize alien peoples survived in his religion. Zoroastrianism, in fact, is the first creed to work by missions or to lay claim to universality of acceptance. It was, however, only natural that its adherents should be won, first and chiefly, among the countrymen of the prophet, and its further success in gaining over all the Iranian tribes gave it a national stamp. So the Susan translation of Darius' Behistun inscription

¹These ideas are strongly exposed in a polemic against the Christians contained in an official edict of the Persian creed to the Armenians by Mihr Narseh, the vizier of Yazdegerd II. (about A.D. 450), preserved by the Armenian historian, Eusebe.

terma Ahuramazda "the god of the Aryans." Thus the creed became a powerful factor in the development of an united Iranian nationality.

That a religion, which lays its chief stress upon moral precepts, may readily develop into casuistry and external formalism, with an infinity of minute prescriptions, injunctions on purity and the like, is well known. In the *Avesta* all these recur *ad nauseam*, so much so that the primitive spirit of the religion is stifled beneath them, as the doctrine of the ancient prophets was stifled in Judaism and the Talmud. The Sassanid Empire, indeed, is completely dominated by this formalism and ritualism; but the earlier testimony of Darius in his inscriptions and the statements in Herodotus enable us still to recognize the original healthy life of a religion capable of awakening the enthusiastic devotion of the inner man. Its formal character naturally germinated in the priesthood (Herod. i. 140; cf. Strabo xv. 733, &c.). The priests diligently practise all the precepts of their ritual—e.g. the extermination of noxious animals, and the exposure of corpses to the dogs and birds, that earth may not be polluted by their presence. They have advice for every contingency in life, and can say with precision when a man has been defiled, and how he may be cleansed again; they possess an endless stock of formulae for prayer, and of sentences which serve for protection against evil spirits and may be turned to purposes of magic.

How the doctrine overspread the whole of Iran, we do not know. In the West, among the Medes and Persians, the guardianship and ministry of Zoroastrianism is vested in an exclusive priesthood—the Magians. Whence this name—unknown as already mentioned, to the *Avesta*—took its rise, we have no knowledge. Herodotus (i. 101) includes the Magians in his list of Median tribes; and it is probable that they and their teaching reached the Persians from Media. At all events, they play here not merely the rôle of the "Fire-kindlers" (*dhravan*) in the *Avesta*, but are become an hereditary sacerdotal caste, acting an important part in the state—advisers and spiritual guides to the king, and so forth. With them the ritualism and magical character, above mentioned, are fully developed. In the narrations of Herodotus, they interpret dreams and predict the future; and in Greece, from the time of Herodotus and Sophocles (*Oed. Tyr.* 387) onward, the word *Magian* connotes a magician-priest.

See further, ZOROASTER and works there quoted.

IV. *Beginnings of History.*—A connected chain of historical evidence begins with the time when under Shalmaneser (Sal-
Assyrian manassar II.), the Assyrians in 836 B.C. began for
Conquest the first time to penetrate farther into the moun-
of Media. tains of the east; and there, in addition to several non-Iranian peoples, subdued a few Median tribes. These wars were continued under successive kings, till the Assyrian power in these regions attained its zenith under Sargon (*q.v.*), who (715 B.C.) led into exile the Median chief Dayuku (see DEIOCES), a vassal of the Minni (Mannaeans), with all his family, and subjected the princes of Media as far as the mountain of Bikni (Elburz) and the border of the great desert. At that time twenty-eight Median "town-lords" paid tribute to Nineveh; two years later, (713 B.C.) no fewer than forty-six. Sargon's successors, down to Assur-bani-pal (668–626 B.C.), maintained and even augmented their suzerainty over Media, in spite of repeated attempts to throw off the yoke in conjunction with the Mannaeans, the Saparda, the Cimmerians—who had penetrated into the Armenian mountains—and others. Not till the last years of Assur-bani-pal, on which the extant Assyrian annals are silent, can an independent Median Empire have arisen.

As to the history of this empire, we have an ancient account in Herodotus, which, with a large admixture of the legendary, still contains numerous historical elements, and a completely fanciful account from Ctesias, preserved
The Median in Diodorus (ii. 32 sqq.) and much used by later
Empire. writers. In the latter Nineveh is destroyed by the Mede Arbaces and the Babylonian Belesys about 880 B.C., a period when the Assyrians were just beginning to lay the foundations of their power. Arbaces is then followed by a long list of Median kings, all of them fabulous. On the other hand, according to Herodotus the Medes revolt from Assyria about 710 B.C., that is to say, at the exact time when they were subdued by Sargon. Deioces founds the monarchy; his son Phraortes begins the work of conquest; and his son Cyaxares is first overwhelmed by the Scythians, then captures Nineveh, and raises Media to a great power. A little supplementary information may be gleaned from the inscriptions of King Nabonidus of Babylon (555–539)

and from a few allusions in the Old Testament. Of the Median Empire itself we do not possess a single monument. Consequently its history still lies in complete obscurity (cf. MEDIA; DEIOCES; PHRAORTES; CYAXARES).

The beginnings of the Median monarchy can scarcely go farther back than 640 B.C. To all appearance, the insurrection against Assyria must have proceeded from the desert tribe of the Manda, mentioned by Sargon: for Nabonidus invariably describes the Median kings as "kings of the Manda." According to the account of Herodotus, the dynasty was derived from Deioces, the captive of Sargon, whose descendants may have found refuge in the desert. The first historical king would seem to have been Phraortes, who probably succeeded in subduing the small local princes of Media and in rendering himself independent of Assyria. Further development was arrested by the Scythian invasion described by Herodotus. We know from Zephaniah and Jeremiah that these northern barbarians, in 626 B.C., overran and harried Syria and Palestine (cf. CYAXARES; JEWS). With these inroads of the Cimmerians and Scythians (see SCYTHIA), we must doubtless connect the great ethnographical revolution in the north of anterior Asia; the Indo-European Armenians (*Haik*), displacing the old Alarodians (*Urartu, Ararat*), in the country which has since borne their name; and the entry of the Cappadocians—first mentioned in the Persian period—into the east of Asia Minor. The Scythian invasion evidently contributed largely to the enfeeblement of the Assyrian Empire: for in the same year the Chaldean Nabopolassar founded the New-Babylonian empire; and in 606 B.C. Cyaxares captured and destroyed Nineveh and the other Assyrian cities. Syria and the south he abandoned to Nabopolassar and his son Nebuchadrezzar; while, on the other hand, Assyria proper, east of the Tigris, the north of Mesopotamia with the town of Harran (*Carrhae*) and the mountains of Armenia were annexed by the Medes. Cappadocia also fell before Cyaxares; in a war with the Lydian Empire the decisive battle was broken off by the celebrated eclipse of the sun on the 28th of May 585 B.C., foretold by Thales (Herod. i. 74). After this a peace was arranged by Nebuchadrezzar of Babylon and Sycænes of Cilicia, recognizing the Halys as the borderline. To the east, the Median Empire extended far over Iran, even the Persians owning its sway. Ecbatana (*q.v.*) became the capital.

Of the states which arose out of the shattered Assyrian Empire (Media, Babylon, Egypt, Cilicia and Lydia), Media was by far the strongest. In Babylon the kings feared, and the exiled Jews hoped, an attack from the Medes (cf. Isa. xiii., xiv., xxi.; Jer. i., li.); and Nebuchadrezzar sought by every means—great fortifications, canals and so forth—to secure his empire against the menace from the north. He succeeded in maintaining the *status quo* practically unimpaired, additional security being found in intermarriage between the two dynasties. In this state of equilibrium the great powers of Anterior Asia remained during the first half of the 6th century.

V. *The Persian Empire of the Achaemenids.*—The balance, however, was disturbed in 553 B.C., when the Persian Cyrus, king of Anshan in Elam (*Susiana*), revolted against his suzerain Astyages, the son of Cyaxares, and
Conquests three years later defeated him at Pasargadae (*q.v.*).¹
of Cyrus and
and Cambyses. Shortly afterwards Astyages was taken prisoner, Ecbatana reduced, and the Median Empire replaced by the Persian. The Persian tribes were welded by Cyrus into a single nation, and now became the foremost people in the world (see PERSIS and CYRUS). At first Nabonidus of Babylon hailed the fall of the Medes with delight and utilized the opportunity by occupying Harran (*Carrhae*). But before long he recognized the danger threatened from that quarter. Cyrus and his Persians paid little heed to the treaties which the Median king had concluded with the other powers; and the result was a great coalition against him, embracing Nabonidus of Babylon, Amasis of Egypt, Croesus of Lydia, and the Spartans, whose highly efficient army seemed to the Oriental states of great value. In the spring of 546 B.C., Croesus opened the attack. Cyrus

¹ See further, BABYLONIA AND ASSYRIA: § v. *History*.

slung himself upon him, beat him at Pteria in Cappadocia and pursued him to Lydia. A second victory followed on the banks of the Pactolus; by the autumn of 546 Sardis had already fallen and the Persian power advanced at a bound to the Mediterranean. In the course of the next few years the Greek littoral towns were reduced, as also the Carians and Lycians. The king of Cilicia (Syennesis) voluntarily acknowledged the Persian suzerainty. In 539 Nabonidus was defeated and Babylon occupied, while, with the Chaldean Empire, Syria and Palestine also became Persian (see JEWS). The east of Iran was further subdued, and, after Cyrus met his end (528 B.C.) in a war against the eastern Nomads (Dahae, Massagetae), his son Cambyses conquered Egypt (525 B.C.). Cyprus and the Greek islands on the coast of Asia Minor also submitted, Samos being taken by Darius. On the other hand, an expedition by Cambyses against the Ethiopian kingdom of Napata and Meroe came to grief in Nubia. The usurpation of Smerdis (522-521 B.C.) and his death at the hands of Darius was the signal for numerous insurrections in Babylon, Susiana, Persis, Media, Armenia and many of the Eastern provinces. But, within two years (521-519), they were all crushed by Darius and his generals.

The causes of this astonishing success, which, in the brief space of a single generation, raised a previously obscure and secluded tribe to the mastery of the whole Orient, can only be partially discerned from the evidence at our disposal. The decisive factor was of course their military superiority. The chief weapon of the Persians, as of all Iranians, was the bow, which accordingly the king himself holds in his portraits, e.g. on the Behistun rock and the coins (*darics*). In addition to the bow, the Persians carried short lances and short daggers. But it was not by these weapons, nor by hand to hand fighting, that the Persian victories were won. They overwhelmed their enemy under a hail of arrows, and never allowed him to come to close quarters. While the infantry knelt to shoot, the cavalry swarmed round the hostile squadrons, threw their lines into confusion, and completed their discomfiture by a vigorous pursuit. In a charge the infantry also might employ lance and dagger; but the essential point was that the archers should be mobile and their use of the bow unhampered.

Consequently, only a few distinguished warriors wore shirts of mail. For purposes of defence the rank and file merely carried a light hide-covered shield; which the infantry, in shooting, planted before them as a sort of barrier against the enemy's missiles. Thus the Persian army was lost, if heavy-armed hoplites succeeded in gaining their lines. In spite of all their bravery, they succumbed to the Greek phalanx, when once the generalship of a Miltiades or a Pausanias had brought matters to a hand to hand conflict; and it was with justice that the Greeks—Aeschylus, for instance—viewed their battles against the Persian as a contest between spear and bow. None the less, till Marathon the Persians were successful in discomfiting every enemy before he could close, whether that enemy consisted of similarly accoutred bowmen (as the Medes), of cavalry armed with the lance (as the Lydians), or of heavily armoured warriors (as the Babylonians, Egyptians and Greeks).

To all this should be added the superiority of their leaders; Cyrus especially must have been an exceedingly able general. Obviously, also, he must have understood the art of organizing his people and arousing the feeling of nationality and the courage of self-sacrifice. In his time the Persians were a strong manly peasantry, domiciled in a healthy climate and habituated to all hardships—a point repeatedly emphasized, in the tales preserved by Herodotus, as the cause of their successes (e.g. Herod. ix. 122). Herodotus, however, also records (i. 135) that the Persians were "of all mankind the readiest to adopt foreign customs, good or bad," a sentence which is equally applicable to the Romans, and which in the case of both nations goes far to explain, not merely their successes, but also the character of their empires.

The fundamental features of the imperial organization must have been due to Cyrus himself. Darius followed in his steps and completed the vast structure. His rôle, indeed, was peculiarly that of supplementing and perfecting the work of his great predecessor. The organization of the empire is planned throughout on broad, free lines; there is nothing mean and timorous in it. The great god Ahuramazda, whom king and people alike acknowledge, has given them dominion "over this earth afar, over many peoples and tongues;" and the consciousness is strong in them that they are masters of the world. Thus their sovereign styles himself "the king of kings" and "the king of the lands"—that is to say, of the

whole civilized world. For the provinces remaining unsubdued on the extreme frontiers to the west, the north and the east are in their view almost negligible quantities. And far removed as the Persians are from disavowing their proud sense of nationality ("a Persian, the son of a Persian, an Aryan of Aryan stock" says Darius of himself in the inscription on his tomb)—yet equally vivid is the feeling that they rule the whole civilized world, that their task is to reduce it to unity, and that by the will of Ahuramazda they are pledged to govern it aright.

This is most clearly seen in the treatment of the subject races. In contrast with the Assyrians and the Romans the Persians invariably conducted their wars with great humanity. The vanquished kings were honourably dealt with, the enemy's towns were spared, except when grave offences and insurrections, as at Miletus and Athens, rendered punishment imperative; and their inhabitants were treated with mildness. Like Cyrus, all his successors welcomed members of the conquered nationalities to their service, employed them as administrators or generals and made them grants of land; and this not only in the case of Medes, but also of Armenians, Lydians, Jews and Greeks. The whole population of the empire was alike bound to military service. The subject-contingents stood side by side with the native Persian troops; and the garrisons—in Egypt, for instance—were composed of the most varied nationalities.

Among the subject races the Medes particularly stood high in favour. Darius in his inscriptions always names them immediately after the Persians. They were the predecessors of the Persians in the empire and the more civilized people. Their institutions, court ceremonial and dress were all adopted by the Achaemenids. Thus the tribal distinctions began to recede, and the ground was prepared for that amalgamation of the Iranians into a single, uniform nation, which under the Sassanids was completely perfected—at least for west of Iran.

The lion's share, indeed, falls to the dominant race itself. The inhabitants of Persis proper—from which the eastern tribes of Carmanians, Utians, &c., were excluded and formed into a separate satrapy—pay no taxes. Instead, they bring the best of their possessions (e.g. a particularly fine fruit) as a gift to their king on festival days; peasants meeting him on his excursions do the same (Plut. *Artax.* 4, 5; *Dion ap. Aelian. var. hist.* 1, 31; *Xen. Cyr.* viii. 5, 21, 7, 1). In recompense for this, he distributes on his return rich presents to every Persian man and woman—the women of Pasargadae, who are members of Cyrus's tribe, each receiving a piece of gold (Nic. *Dam. fr.* 66. *Plut. Alex.* 69). In relation to his Persians, he is always the people's king. At his accession he is consecrated in the temple of a warrior-goddess (Anaitis?) at Pasargadae, and partakes of the simple meal of the old peasant days—a mess of figs, terebinths and sour milk (Plut. *Artax.* 3). The Persians swear allegiance to him and pray to Ahuramazda for his life and the welfare of the people, while he vows to protect them against every attack, and to judge and govern them as did his fathers before him (Herod. i. 132; *Xen. Cyr.* xviii. 5, 25, 27). For helpers he has at his side the "law-bearers" (*databara* Dan. iii. 2, and in *Babyl. documents*; cf. Herod. iii. 31, v. 25, vii. 194; *Ether* i. 13, &c.). These—the Persian judges—are nominated by the king for life, and generally bequeath their office to their sons. The royal decision is based on consultation with the great ones of his people; and such is the case with his officials and governors everywhere (cf. the Book of Ezra).

Every Persian able to bear arms is bound to serve the king—the great landowners on horseback, the commonalty on foot. The noble and well-to-do, who need not till their fields in person, are pledged to appear at court as frequently as possible. Their children are brought up in company with the princes "at the gates of the king," instructed in the handling of arms, in riding and hunting, and introduced to the service of the state and the knowledge of the law, as well as the commandments of religion. Then such as prove their worth are called to high office and rewarded, generally with grants of land.

The highest rank was held by the descendants of the six great families, whose heads stood by Darius at the killing of the Magian. The Greeks class them and the king together, under the name of "the seven Persians." These enjoyed the right of entering the presence unannounced, and possessed princely estates in the provinces. Besides these, however, numbers of other Persians were despatched to the provinces, settled there, and endowed with lands. There existed, in fact, under the Achaemenids a strong colonizing movement, diffused through the whole empire; traces of this policy occur more especially in Armenia, Cappadocia and Lycia, but also in the rest of Asia Minor, and not rarely in Syria and Egypt. These colonists formed the nucleus of the provincial military levy, and were a tower of strength to the Persian dominion. They composed, moreover, the Persian council, and vice-regal household of the Satraps, exactly as the Persians of the home-country composed that of the king.

Though the world-empire of Persia was thus deeply impressed by a national character, care was nevertheless exercised that the general duties and interests of the subject races should receive due consideration. We find their representatives, side by side with the Persians, occupying every sort of position in the regal and vice-regal courts. They take their part in the councils of the satraps, precisely as they do in military service (cf. the evidence of Ezra); and they, too, are rewarded by bounties and estates. To wield a peaceful authority over all the subjects of the empire, to reward merit, and to punish transgression—such is the highest task of king and officials.

On his native soil Cyrus built himself a town, with a palace and a tomb, in the district of Pasargadae (now the ruins of Murghab). This Darius replaced by a new capital, deeper in the centre of the country, which bore the name "Persian" (*Pārsa*), the Persepolis (*g.v.*) of the later Greeks. But the district of Persis was too remote to be the administrative centre of a world-empire. The natural centre lay, rather, in the ancient fertile tract on the lower Tigris and Euphrates. The actual capital of the empire was therefore Susa, where Darius I. and Artaxerxes II. erected their magnificent palaces. The winter months the kings chiefly spent in Babylon: the hot summer, in the cooler situation of Ecbatana, where Darius and Xerxes built a residence on Mt Elvend, south of the city. From a palace of Artaxerxes II. in Ecbatana itself, the fragments of a few inscribed columns (now in the possession of Mr Lindo Myers and published by Evetts in the *Zeitschr. f. Assyriol.* V.) have been preserved. To Persis and Persepolis the kings paid only occasional visits especially at their coronations.

Within the empire, the two great civilized states incorporated by Cyrus and Cambyses, Babylon and Egypt, occupied a position of their own. After his defeat of Nabonidus, Cyrus proclaimed himself "King of Babel"; and the same title was born by Cambyses, Smerdis and Darius. So, in Egypt, Cambyses adopted in full the titles of the Pharaohs. In this we may trace a desire to conciliate the native population, with the object of maintaining the fiction that the old state still continued. Darius went still farther. He encouraged the efforts of the Egyptian priesthood in every way, built temples, and enacted new laws in continuance of the old order. In Babylon his procedure was presumably similar, though here we possess no local evidence. But he lived to see that his policy had missed its goal. In 486 B.C. Egypt revolted and was only reduced by Xerxes in 484. It was this, probably, that induced him in 484 to renounce his title of "king of Babel," and to remove from its temple the golden statue of Bel-Marduk (Mero-dach), whose hands the king was bound to clasp on the first day of each year. This proceeding led to two insurrections in Babylon (probably in 484 and 479 B.C.), which were speedily repressed. After that the "kingship of Babel" was definitely abolished. In Egypt the Persian kings still retained the style of the Pharaohs; but we hear no more of concessions to the priesthood or to the old institutions, and, apart from the great oasis of el-Kharga, no more temples were erected (see *Egypt: History*).

At the head of the court and the imperial administration stands the commandant of the body-guard—the ten thousand "Immortals," often depicted in the sculptures of Persepolis with lances surmounted by golden apples. This grandee, whom the Greeks termed "Chiliarch," *Officials*, corresponds to the modern vizier. In addition to him, we find seven councillors (Ezra vii. 14; cf. Esther i. 14). Among the other officials, the "Eye of the King" is frequently mentioned. To him was entrusted the control of the whole empire and the superintendence of all officials.

The orders of the court were issued in a very simple form of the cuneiform script, probably invented by the Medes. This comprised 36 signs, almost all of which denote single sounds. In the royal inscriptions, a translation into Susian (Elam-Official Language), and Babylonian was always appended to the Persian text. In Egypt one in hieroglyphics was added, as in the inscriptions of the Suez canal; in the Grecian provinces, another in Greek (e.g. the inscription of Darius on the Bosphorus, Herod. iv. 37, cf. iv. 91). The cuneiform script could only be written on stone or clay. Thus there has been discovered in Babylon a copy of the Behistun (*g.v.*) inscription preserved on a block of dolerite (Weissbach, *Babylonische Miscellen*, p. 24). For administrative purposes, however, it would seem that this inconvenient material was not employed; its place being taken by skins (*Schäfers*, parchment), the use of which was adopted from the western peoples of the empire. On these were further written the journals and records kept at the court (cf. Diod. ii. 22, 32; Ezra iv. 15, v. 17, vi. 2; Esther vi. 1, ii. 23). With such materials the cuneiform script could not be used; instead, the Persian language was written in Aramaic characters, a method which later led to the so-called Pahlavi, i.e. Parthian script. This mode of writing was obviously alone employed in the state-services since Darius I.; and so may be explained the fact that, under the Achaemenids, the Persian language rapidly declined, and, in the inscriptions of Artaxerxes III., only appears in an extremely neglected guise (see CUNEIFORM INSCRIPTIONS, ALPHABET).

Side by side with the Persian, the Aramaic, which had long been widely diffused as the speech of commerce, enjoyed currency in all the western half of the empire as a second dominant language. Thus all deeds, enactments and records designed for these provinces were furnished with an official Aramaic version (Ezra iv. 7). Numerous documents in this tongue, dating from the Persian period, have been discovered in Egypt (cf. Sayce and Cowley, *Aramaic Papyri discovered at Assuan* 1906), and the coins minted by the satraps and generals usually bear an Aramaic inscription. (So, also, a lion-weight from Abydos, in the British Museum.) The Demotic in Egypt was employed in private documents alone. Only in the Hellenic provinces of the empire Greek replaced Aramaic (cf. the letter to Pausanias in Thuc. i. 129; an edict to Gadatas in Magnesia, Cousin et Deschamps, *Bulletin de corresp. hellénique* xii. 530, Dittenberger, *Sylloge* 2; 80, also, on coins)—a clear proof that the Persians had already begun to recognize the independent and important position of Greek civilization.¹

Darius I. divided the Persian Empire into twenty great provinces, satrapies, with a "guardian of the country" (*kshathrapavan*; see SATRAP) at the head of each. A list is preserved in Herodotus (iii. 89 sqq.); but the boundaries were frequently changed. Each satrapy was again subdivided into several minor governorships. The satrap is the head of the whole administration of his province. He levies the taxes, controls the legal procedure, is responsible for the security of roads and property, and superintends the subordinate districts. The heads of the great military centres of the empire and the commandants of the royal fortresses are outside his jurisdiction: yet the satraps are entitled to a body of troops of their own; a privilege which they need to the full, especially in later periods. The satrap is held in his position as a subject by the controlling machinery of the empire, especially the "Eye of the King"; by the council of Persians in his province with

¹ For the editions of the Persian inscriptions see BEHISTUN. For the Persian documents, Ed. Meyer *Entstehung des Judentums*, p. 19 sqq. The hieroglyphic inscriptions of the Suez Canal are published in the *Recueil de Iran, d'Égypte, et d'Assyrie*, vols. vii. ix. xi. xiii; the private documents from Babylonia and Nippur, by Strassmaier, *Babyl. Urkunden*, and Hilprecht and Clay, *Babyl. Exped. of Univ. of Pennsylvania*, vols. ix. x. Numerous Jewish documents in Aramaic have been found at Elephantine (Sayce and Cowley, *Aramaic Papyri discovered at Assuan*, 1906), among them an official complaint of the Jewish colony settled at Elephantine, addressed to the Persian satrap of Judaea, in 408 B.C., which throws a new light on many passages in Ezra and Nehemiah, published by Sachau in *Abhandlungen der berl. Akademie*, 1907.

whom he is bound to debate all matters of importance; and by the army: while in the hands of the messengers (Pers. *δορυβάται* or *ἄγγαροι*—a Babylonian word: see ANGARIA) the government despatches travel "swifter than the crane" along the great imperial highways, which are all provided with regular postal stations (cf. the description of the route from Susa to Sardis in Herod. v. 32).

Within the satrapies the subject races and communities occupied a tolerably independent position; for instance, the *Subject Jews*, under their elders and priests, who were even *Communitable* to convene a popular assembly in Jerusalem (cf. the Books of Ezra and Nehemiah). Obviously also, they enjoyed, as a rule, the privilege of deciding law-suits among themselves; their general situation being similar to that of the Christian nationalities under the Ottomans, or to that of many tribes in the Russian Empire at the present day. The pressure of despotism was manifest, not so much in that the king and his officials consistently interfered in individual cases, but that they did so on isolated and arbitrary occasions, and then swept aside the privileges of the subject, who was impotent to resist.

For the rest, the subject population falls into a number of distinct groups. In the desert (as among the Arabian and Turanian nomads), in wild and sequestered mountains (as in Zagros in north Media, and Mysia, Pisidia, Paphlagonia and Bithynia in Asia Minor), and also in many Iranian tribes, the old tribal constitution, with the chieftain as its head, was left intact even under the imperial suzerainty. The great majority of the civilized provinces were subdivided into local administrative districts governed by officials of the king and his satraps. These the Greeks named *ἔθνη*, "peoples." Within these, again, there might lie large town settlements whose internal affairs were controlled by the elders or the officials of the community: as, for instance, Babylon, Jerusalem, the Egyptian cities, Tarsus, Sardis and others. On the same footing were the spiritual principalities, with their great temple-property; as Bamyce in Syria, the two Comanas in Cappadocia, and so forth. Besides these, however, vast districts were either converted into royal domains (*ραπιδύσεις*) with great parks and hunting grounds under royal supervision, or else bestowed by the king on Persians or deserving members of the subject-races (the "benefactors") as their personal property. Many of these estates formed respectable principalities: e.g. those of the house of Otanes in Cappadocia, of Hydarnes in Armenia, Pharnabazus in Phrygia, Demaratus in Teuthrania, Themistocles in Magnesia and Lampascus. They were absolute private property, handed down from father to son for centuries, and in the Hellenistic period not rarely became independent kingdoms. These potentates were styled by the Greeks *δυνάστες* or *μνησάρχαι*.

The last class, quite distinct from all these organizations, was formed by the city-states (*πόλεις*) with an independent constitution—whether a monarchy (as in Phoenicia), an aristocracy (as in Lycia), or a republic with council and popular assembly (as in the Greek towns). The essential point was that they enjoyed a separate legalized organization (autonomy). This was only to be seen in the extreme western provinces of the empire among the Phoenicians, Greeks and Lycians, whose cities were essentially distinct from those of the east; which, indeed, to Greek eyes, were only great villages (*κομποπόλεις*). It is readily intelligible that their character should have proved practically incomprehensible to the Persians, with whom they came into perpetual collision. These sought, as a rule, to cope with the difficulty by transferring the government to individual persons who enjoyed their confidence: the "tyrants" of the Greek towns. Mardonius, alone, after his suppression of the Ionic revolt—which had originated with these very tyrants—made an attempt to govern them by the assistance of the democracy (492 B.C.).

The provinces of the Persian Empire differed as materially in economy as in organization. In the extreme west, a money currency in its most highly developed form—that of coinage minted by

the state, or an autonomous community—had developed since the 7th century among the Lydians and Greeks. In the *Commerce* main portion, however, of the Oriental world—Egypt, and *Finances* Syria, Phœnicia and Babylonia—the old mode of commerce was still in vogue, conducted by means of gold and silver bars, weighed at each transaction. Indeed, a money currency only began to make headway in these districts in the 4th century B.C. In the eastern provinces, on the other hand, the primitive method of exchange by barter still held the field. Only in the auriferous and civilized frontier districts of India (the Punjab) did a system of coinage find early acceptance. There Persian and Attic money was widely distributed, and imitations of it struck, in the fifth and fourth pre-Christian centuries.

Thus the empire was compelled to grapple with all these varied conditions and to reconcile them as best it might. At the court, "natural economy" was still the rule. The officials and Oriental troops received payment in kind. They were fed "by the table of the king," from which 15,000 men daily drew their sustenance (cf. Heracleides of Cyme in Athen. iv. 145 B, &c.) and were rewarded by gifts and assignments of land. The Greek mercenaries, on the contrary, had to be paid in currency; nor could the satraps of the west dispense with hard cash. The king, again, needed the precious metals, not merely for bounties and rewards, but for important enterprises in which money payment was imperative. Consequently, the royal revenues and taxes were paid partly in the precious metals, partly in natural produce—horses and cattle, grain, clothing and its materials, furniture and all articles of industry (cf. Theopomp. fr. 124, 125, &c.). The satraps, also, in addition to money payments, levied contributions "for their table," at which the officials ate (Nehem. v. 14).

The precious metals brought in by the tribute were collected in the great treasure-houses at Susa, Persepolis, Pasargadae and Ecbatana, where gigantic masses of silver and, more especially, of gold, were stored in bullion or partially wrought into vessels (Herod. ii. 96; Strabo xv. 731; 735; Arrian iii. 16, &c.); exactly as is the case today in the shah's treasure-chamber (Curzon, *Persia*, ii. 484). It is also observable that the conjunction of payments in kind and money taxes still exists. The province of Khorasan, for instance, with some half million inhabitants, paid in 1885 £154,000 in gold, and in addition natural produce to the value of £43,000 (Curzon, *op. cit.* i. 181, ii. 380). When the king required money he minted as much as was necessary. A reform in the coinage was effected by Darius, who struck the Daric (Pers. *Zarig*, i. e. "piece of gold"; the word has nothing to do with the name of Darius), a gold piece of 130 grains (value about 23s.); this being equivalent to 20 silver pieces ("Median shekels," *σέληνα*) of 86.5 grains (value according to the then rate of silver—131 silver to 1 gold—about 1s. 2d.). The coining of gold was the exclusive prerogative of the king; silver could be coined by the satraps, generals, independent communities and dynasts.

The extent of the Persian Empire was, in essentials, defined by the great conquests of Cyrus and Cambyses. Darius was no more a *conquistador* than Augustus. Rather, *Imperial Policy*, the task he set himself was to round off the empire and secure its borders: and for this purpose in Asia Minor and Armenia he subdued the mountain-tribes and advanced the frontier as far as the Caucasus; Colchis alone remaining an independent kingdom under the imperial suzerainty. So, too, he annexed the Indus valley and the auriferous hill-country of Kafiristan and Cashmir (*Κάσσιροι* or *Κάσπεροι*, Herod. iii. 93, vii. 67, 86; Steph. Byz.), as well as the Dardae in Dardistan on the Indus (Ctesias, *Ind. fr.* 12: 70, &c.). From this point he directed several campaigns against the Amyrgian Sacaë, on the Pamir Plateau and northwards, whom he enumerates in his list of subject races, and whose mounted archers formed a main division of the armies despatched against the Greeks. It was obviously an attempt to take the nomads of the Turanian steppe in the rear and to reduce them to quiescence, which led to his unfortunate expedition against the Scythians of the Russian steppes (c. 512 B.C.; cf. DARIUS).

Side by side, however, with these wars, we can read, even in the scanty tradition at our disposal, a consistent effort to further the great civilizing mission imposed on the empire. In the district of Herat, Darius established a great water-basin, designed to facilitate the cultivation of the steppe (Herod. iii. 117). He had the course of the Indus explored by the Carian captain Scylax (q.v.) of Caryanda, who then navigated the Indian Ocean back to Suez (Herod. iv. 44) and wrote an account of his voyage in Greek. The desire to create a direct communication between the seclusion of Persis and the commerce of the world is evident.

in his foundation of several harbours, described by Nearchus, on the Persian coast. But this design is still more patent in his completion of a great canal, already begun by Necho, from the Nile to Suez, along which several monuments of Darius have been preserved. Thus it was possible, as says the remnant of an hieroglyphic inscription there discovered, "for ships to sail direct from the Nile to Persia, over Saba." In the time of Herodotus the canal was in constant use (ii. 158, iv. 39): afterwards, when Egypt regained her independence, it decayed, till restored by the second Ptolemy. Even the circumnavigation of Africa was attempted under Xerxes (Herod. iv. 43).

It has already been mentioned, that, in his efforts to conciliate the Egyptians, Darius placed his chief reliance on the priesthood: and the same tendency runs throughout the imperial policy toward the conquered races. Thus Cyrus himself gave the exiled Jews in Babylon permission to return and rebuild Jerusalem. Darius allowed the restoration of the Temple; and Artaxerxes I., by the protection accorded to Ezra and Nehemiah, made the foundation of Judaism possible (see Jews: §§ 19 sqq.). Analogously in an edict, of which a later copy is preserved in an inscription (see above), Darius commands Gadatas, the governor of a domain (*ραπιδέσας*) in Magnesia on the Maeander, to observe scrupulously the privileges of the Apollo-sanctuary. With all the Greek oracles—even those in the mother-country—the Persians were on the best of terms. And since these might reasonably expect an enormous extension of their influence from the establishment of a Persian dominion, we find them all zealously medizing during the expedition of Xerxes.

For the development of the Asiatic religions, the Persian Empire was of prime importance. The definite erection of a single, vast, religious world-empire cost them their original connexion with the state, and compelled them in future to address themselves, not to the community at large, but to individuals, to promise, not political success nor the independence of the people, but the welfare of the man. Thus they became at once universal and capable of extension by propagation; and, with this of entering into keen competition one with the other. These traits are most clearly marked in Judaism; but, after the Achaemenid period, they are common to all Oriental creeds, though our information as to most is scanty in the extreme.

In this competition of religions that of Iran played a most spirited part. The Persian kings—none more so than Darius, whose religious convictions are enshrined in his inscriptions—and, with the kings, their people, were ardent professors of the pure doctrine of Zoroaster; and the Persians settled in the provinces diffused his creed throughout the whole empire. Thus a strong Persian propagandism arose especially in Armenia and Cappadocia, where the religion took deep root among the people, but also in Lydia and Lycia. In the process, however, important modifications were introduced. In contrast with Judaism, Zoroastrianism did not enter the lists against all gods save its own, but found no difficulty in recognizing them as subordinate powers—helpers and servants of Ahuramazda. Consequently, the foreign creeds often reacted upon the Persian. In Cappadocia, Aramaic inscriptions have been discovered (1900), in which the indigenous god, there termed Bel the king, recognizes the "Mazdayasnan Religion" (*Dis Masdayasnik*)—i.e. the religion of Ahuramazda personified as a woman—as his sister and wife (Lidzbarski, *Ephem. f. semit. Epigr.* i. 59 sqq.).

The gorgeous cult of the gods of civilization (especially of Babylon), with their host of temples, images and festivals, exercised a corresponding influence on the mother-country. Moreover, the unadulterated doctrine of Zoroaster could no more become a permanent popular religion than can Christianity. For the masses can make little of abstractions and an omnipotent, omnipresent deity; they need concrete divine powers, standing nearer to themselves and their lot. Thus the old figures of the Aryan folk-religion return to the foreground, there to be amalgamated with the Babylonian divinities. The goddess of springs and streams (of the Orus in particular) and of all fertility—*Artemisura Anahita, Anahitis*—is endowed with the form of the Babylonian Ishtar and Belit. She is now depicted as a beautiful and strong woman, with prominent breasts, a golden crown of stars and golden raiment. She is worshipped as the goddess of generation and all sexual life (cf. Herod. i. 131, where the names of Mithras and Anaitis are interchanged); and religious prostitution is transferred to her service (Strabo xi. 532, xii. 559). At her side stands the sun-god Mithras, who is represented as a young and victorious hero. Both deities occupy the very first rank in the popular creed; while to the theologian they are the most potent of the good powers—Mithras being the herald and propagator of the service of Light and the mediator betwixt man and Ahuramazda, who now fades more into the background. Thus, in the subsequent period, the Persian religion

appears purely as the religion of Mithras. The festival of Mithras is the chief festival of the empire, at which the king drinks and is drunken, and dances the national dance (Ctes. fr. 55; Duris fr. 13). This development culminated under Artaxerxes II., who, according to Berossus (fr. 16 ap. Clem. Alex. prot. i. 5, 65), first erected statues to Anaitis in Persepolis, Ecbatana, Bactria, Susa, Babylon, Damascus and Sardis. The truth of this account is proved by the fact that Artaxerxes II. and Artaxerxes III. are the only Achaemenids who, in their inscriptions, invoke Anaitis and Mithras side by side with Ahuramazda. Other gods, who come into prominence, are the dragon-slayer Verethraghna (Artagnes) and the Good Thought (Vohumano, Omanos); and even the Sacaea festival is adopted from Babylon (Berossus fr. 3; Ctes. fr. 16; Strabo xi. 512, &c.). The chief centres of the Persian cults in the west were the district of Acilicene in Armenia (Strabo xi. 532, &c.), the town of Zela in Cappadocia (Strabo xii. 559), and several cities in Lydia.

The position of the Persian monarchy as a world-empire is characteristically emphasized in the buildings of Darius and Xerxes in Persepolis and Susa. The peculiarly national basis, still recognizable in Cyrus's architecture at Pasargadae, recedes into insignificance. The royal edifices and sculptures are dependent, mainly, on Babylonian models, but, at the same time, we can trace in them the influence of Greece, Egypt and Asia Minor; the last in the rock-sarcophagi. All these elements are combined into an organic unity, which achieved the greatest creations that Oriental architecture has found possible. Nevertheless, the result is not a national art, but the art of a world-empire; and it is obvious that foreign craftsmen must have been active in the royal services—among them, the Greek sculptor Telephanes of Phocaea (Pliny xxiv. 68). So, with the collapse of the empire, the imperial art vanishes also: and when, some 500 years later, a new art arose under the Sassanids, whose achievements stand to those of Achaemenid art in much the same relation as the achievements of the two dynasties to each other, we discover only isolated reminiscences of its predecessor.

For the organization and character of the Persian Empire, see Barnabas Brissou, *De regno Persarum principatus libri iii.* (1590); Heeren, *Ideen über Politik, Handel und Verkehr der alten Welt*, I.; G. Rawlinson, *History of Herodotus*, ii. 555 sqq.; *Five Eastern Monarchies*, iii.; Eduard Meyer, *Geschichte des Altertums*, iii. On the Satrapies, cf. Krumpholtz, *De Asiae minoris satrapis persicis* (1883). See also MITHRAS.

3. *History of the Achaemenian Empire.*—The history of the Persian Empire was often written by the Greeks. The most ancient work preserved is that of Herodotus (*q.v.*), who supplies rich and valuable materials for the period ending in 479 B.C. These materials are drawn partly from sound tradition, partly from original knowledge—as in the account of the satrapies and their distribution, the royal highway, the nations in Xerxes' army and their equipment. They also contain much that is admittedly fabulous: for instance, the stories of Cyrus and Croesus, the conquest of Babylon, &c. Forty years later (c. 390 B.C.), the physician Ctesias of Cnidus, who for 17 years (414–398 B.C.) remained in the service of the Great King, composed a great work on the Persian history, known to us from an extract in Photius and numerous fragments. Ctesias (*q.v.*) possesses a more precise acquaintance with Persian views and institutions than Herodotus; and, where he deals with matters that came under his own cognisance, he gives much useful information. For the early period, on the other hand, he only proves how rapidly the tradition had degenerated since Herodotus; and here his narrations can only be utilized in isolated cases, and that with the greatest caution. Of more value was the great work of Dinon of Colophon (c. 340), which we know from numerous excellent fragments; and on the same level may be placed a few statements from Hecataeus of Cyrene, which afford specially important evidence on Persian institutions. To these must be added the testimony of the other Greek historians (Thucydides, Ephorus, Theopompus, &c., with the histories of Alexander), and, before all, that of Xenophon in the *Anabasis* and *Hellenica*. The *Cyropaedia* is a didactic romance, written with a view to Greek institutions and rarely preserving genuine information on the Persian Empire. Of Oriental sources, only the contemporary books of Ezra and Nehemiah are of much importance; also, a few statements in the much later Esther romance. Berossus's history of Babylon contained much valuable and trustworthy information, but next to nothing has survived. That the native tradition almost entirely forgot the Achaemenid Empire, has been mentioned above. For a more detailed account

of these sources see separate articles on HERODOTUS, &c.; EZRA; and NEHEMIAH.

Of modern accounts see especially Th. Nöldeke, *Aufsätze zur persischen Geschichte* (1887). The works of Marquart, *Untersuchungen zur Geschichte von Erass* (2 pts., 1896-1908), abound in daring theories and must be used with caution. On the chronology, cf. Eduard Meyer, *Forschungen zur alten Geschichte*, II.

The external history of the empire is treated under the individual kings (see also history sections of articles GREECE; EGYPT; &c.). The order is as follows:—

CYRUS (558-528); conquered the Medes in 550; king of Babylon from 538.
CAMBYSES (528-521).
SMERDIS (521).
DARIUS I. (521-485).
XERXES I. (485-465).
ARTAXERXES I. (465-425).
(XERXES II. and Sogdianus or Sogdianus, 425-424.)
DARIUS II. Nothus (424-404).
ARTAXERXES II. (404-359).
ARTAXERXES III. Ochus (359-338).
ARSES (338-336).
DARIUS III. (336-330).

The chronology is exactly verified by the Ptolemaic canon, by numerous Babylonian and a few Egyptian documents, and by the evidence of the Greeks. The present article gives only a brief conspectus of the main events in the history of the empire.

Though, unlike Cyrus and Cambyses, Darius made no new expeditions of conquest, yet a great empire, which is not bounded *The Wars* by another equally great, but touches on many small *against* tribes and independent communities, is inevitably *Greeks.* driven to expansion. We have already seen that the attempt of Darius to control the predatory nomads in the north led to his expedition against the Scythians; this, again, led to the incorporation of Thrace and Macedonia, whose king Perdicas submitted. And since a great portion of the Mediterranean coast-line belonged to the empire, further complications resulted automatically. In contrast with the Greeks Carthage took the part of Persia. Darius, indeed, numbers the city—under the name of Karka—among his dominions: as also the Maryans (Macya) on the Syrtes (Andreas, *Verhandl. d. xiii. oriental. Congresses*, Hamburg, 1902, p. 97). But, above all, the Greek cities with their endless feuds and violent internal factions, were incessant in their appeals for intervention. Nevertheless, Darius left European Greece to itself, till the support accorded to the Ionian and Carian insurgents by Athens and Eretria (499 B.C.) made war inevitable. But not only the expeditions of Mardonius (492) and Datis (490), but even the carefully prepared campaign of Xerxes, in conjunction with Carthage, completely failed (480-479). On the fields of Marathon and Plataea, the Persian archers succumbed to the Greek phalanx of hoplites; but the actual decision was effected by Themistocles, who had meanwhile created the Athenian fleet which at Salamis proved its superiority over the Perso-Phoenician armada, and thus precluded beforehand the success of the land-forces.

The wreck of Xerxes' expedition is the turning-point in the history of the Persian Empire. The superiority of the Greeks was so pronounced that the Persians never found courage to repeat their attack. On the contrary, in 466 B.C. their army and fleet were again defeated by Cimon on the Eurymedon, the sequel being that the Greek provinces on the Asiatic coast, with all the Thracian possessions, were lost. In itself, indeed, this loss was of no great significance to such a vast empire; and the attempts of Athens to annex Cyprus and conquer the Nile valley, in alliance with the revolted Egyptians, ended in failure. Athens, in fact, had not sufficient strength to undertake a serious invasion of the empire or an extensive scheme of conquest. Her struggles with the other Hellenic states constrained her, by the peace of Callias (448), definitely to renounce the Persian war; to abandon Cyprus and Egypt to the king; and to content herself with his promise—not that he would surrender the littoral towns, but that he would abstain from an armed attack upon them. The really decisive point was, rather, that the disasters of Salamis and Plataea definitely shattered the offensive power

of the empire; that the centre of gravity in the world's history had shifted from Susa and Babylon to the Aegean Sea; and that the Persians were conscious that in spite of all their courage they were henceforward in the presence of an enemy, superior in arms as well as in intellect, whom they could not hope to subdue by their own strength.

Thus the great empire was reduced to immobility and stagnation—a process which was assisted by the deteriorating influences of civilization and world-dominion upon the character *Internal State of the* of the ruling race. True, the Persians continued *Empire.* to produce brave and honourable men. But the *Revolts.* influences of the harem, the eunuchs, and similar court officials, made appalling progress, and men of energy began to find the temptations of power stronger than their patriotism and devotion to the king. Thus the satraps aspired to independence, not merely owing to unjust treatment, but also to avarice or favourable conditions. As early as 465 B.C., Xerxes was assassinated by his powerful vizier (chiliarch) Artabanus, who attempted to seize the reins of empire in fact, if not in name. A similar instance may be found in Bagoas (*q.v.*), after the murder of Artaxerxes III. (338 B.C.). To these factors must be added the degeneration of the royal line—a degeneration inevitable in Oriental states. Kings like Xerxes and more especially Artaxerxes I. and Artaxerxes II., so far from being gloomy despots, were good-natured potentates, but weak, capricious and readily accessible to personal influences. The only really brutal tyrants were Darius II., who was completely dominated by his bloodthirsty wife Parysatis, and Artaxerxes III. who, though he shed rivers of blood and all but exterminated his whole family, was successful in once more uniting the empire, which under the feeble sway of his father had been threatened with dissolution.

The upshot of these conditions was, that the empire never again undertook an important enterprise, but neglected more and more its great civilizing mission. In considering, however, the subsequent disorders and wars, it must be borne in mind that they affected only individual portions of the empire, and only on isolated occasions involved more extensive areas in long and serious strife. To most of the provinces the Achaemenid dominion was synonymous with two centuries of peace and order. Naturally, however, the wild tribes of the mountains and deserts, who could be curbed only by strict imperial control, asserted their independence and harassed the neighbouring provinces. Among these tribes were the Carduchians in Zagros, the Cossaeans and Uxians in the interior of Elam, the Cadusians and other non-Aryan tribes in northern Media, the Pisidians, Issaurians and Lycaonians in the Taurus, and the Mysians in Olympus. All efforts to restore order in these districts were fruitless; and when the kings removed their court to Ecbatana, they were actually obliged to purchase a free passage from the mountain tribes (Strabo xi. 524; Arrian iii. 17, 1). The kings (*e.g.* Artaxerxes II.) repeatedly took the field in great force against the Cadusians, but unsuccessfully. When, in 400 B.C., Xenophoa marched with the mercenaries of Cyrus from the Tigris to the Black Sea, the authority of the king was non-existent north of Armenia, and the tribes of the Pontic mountains, with the Greek cities on the coast, were completely independent. In Paphlagonia, the native dynasts founded a powerful though short-lived kingdom, and the chieftains of the Bithynians were absolutely their own masters. The frontier provinces of India were also lost. Egypt, which had already revolted under Libyan princes in the years 486-484, and again with Athenian help in 460-454, finally asserted its independence in 404. Henceforward the native dynasties repelled every attack, till they succumbed once more before Artaxerxes III. and Mentor of Rhodes.

In the other civilized countries, indeed, the old passion for freedom had been completely obliterated; and after the days of Darius I.—apart from the Greek, Lycian and Phoenician towns—not a single people in all these provinces dreamed of shaking off the foreign dominion. All the more clearly, then, was the inner weakness of the empire revealed by the revolts

of the satraps. These were facilitated by the custom—quite contrary to the original imperial organization—which entrusted the provincial military commands to the satraps, who began to receive great masses of Greek mercenaries into their service. Under Artaxerxes I. and Darius II., these insurrections were still rare. But when the revolt of the younger Cyrus against his brother (401 B.C.) had demonstrated the surprising ease and rapidity with which a courageous army could penetrate into the heart of the empire—when the whole force of that empire had proved powerless, not only to prevent some 12,000 Greek troops, completely surrounded, cut off from their communications, and deprived through treachery of their leaders, from escaping to the coast, but even to make a serious attack on them—then, indeed, the imperial impotence became manifest. After that, revolts of the satraps in Asia Minor and Syria were of everyday occurrence, and the task of suppressing them was complicated by the foreign wars which the empire had to sustain against Greece and Egypt.

At this very period, however, the foreign policy of the empire gained a brilliant success. The collapse of the Athenian power before Syracuse (413 B.C.) induced Darius II. to order his satraps Tissaphernes and Pharnabazus, in Asia Minor, to collect the tribute overdue from the Greek cities. In alliance with Sparta (see PELOPONNESIAN WAR), Persia intervened in the conflict against Athens, and it was Persian gold that made it possible for Lysander to complete her overthrow (404 B.C.). True, war with Sparta followed immediately, over the division of the spoils, and the campaigns of the Spartan generals in Asia Minor (390-395) were all the more dangerous as they gave occasion to numerous rebellions. But Persia joined the Greek league against Sparta, and in 394 Pharnabazus and Conon annihilated the Lacedaemonian fleet at Cnidus. Thus the Spartan power of offence was crippled; and the upshot of the long-protracted war was that Sparta ruefully returned to the Persian alliance, and by the Peace of Antalcidas (q.v.), concluded with the king in 387 B.C., not only renounced all claims to the Asiatic possessions, but officially proclaimed the Persian suzerainty over Greece. Ninety years after Salamis and Plataea, the goal for which Xerxes had striven was actually attained, and the king's will was law in Greece. In the following decades, no Hellenic state ventured to violate the king's peace, and all the feuds that followed centred round the efforts of the combatants—Sparta, Thebes, Athens and Argos—to draw the royal powers to their side (see GREECE: *Ancient History*).

But, for these successes, the empire had to thank the internecine strife of its Greek opponents, rather than its own strength. Its feebleness, when thrown on its own resources, is evident from the fact that, during the next years, it failed both to reconquer Egypt and to suppress completely King Evagoras of Salamis in Cyprus. The satrap revolts, moreover, assumed more and more formidable proportions, and the Greek states began once more to tamper with them. Thus the reign of Artaxerxes II. ended, in 359 B.C., with a complete dissolution of the imperial authority in the west. His successor, Artaxerxes Ochus, succeeded yet again in restoring the empire in its full extent. In 355 B.C., he spoke the fatal word, which, a second—or rather a third—time, demolished the essentially unsound power of Athens. In 343 he reduced Egypt, and his generals Mentor and Memnon, with his vizier Bagos (q.v.), crushed once and for all the resistance in Asia Minor. At his death in 338, immediately before the final catastrophe, the empire to all appearances was more powerful and more firmly established than it had been since the days of Xerxes.

These successes, however, were won only by means of Greek armies and Greek generals. And simultaneously the Greek civilization—diffused by mercenaries, traders, artists, prostitutes and slaves,—advanced in ever greater force. In Asia Minor and Phoenicia we can clearly trace the progress of Hellenism (q.v.), especially by the coinage. The stamp is cut by Greek hands and the Greek tongue predominates more and more in the inscription. We can see that

the victory of Greek civilisation had long been prepared on every side. But the vital point is that the absolute superiority of the Hellenic was recognized as incontestable on both hands. The Persian sought to protect himself against danger, by employing Greeks in the national service and turning Greek policy to the interests of the empire. In the Greek world itself the disgrace that a people, called to universal dominion and capable of wielding it, should be dependent on the mandate of an impotent Asiatic monarchy, was keenly felt by all who were not yet absorbed in the rivalry of city with city. The spokesman of this national sentiment was Isocrates; but numerous other writers gave expression to it; notably, the historian Callisthenes of Olynthus. Union between Greeks, voluntary or compulsory, and an offensive war against Persia, was the programme they propounded.

Nor was the time for its fulfilment far distant. The new power which now rose to the first rank, created by Philip of Macedonia, had no engrained tendency inimical to the Persian *Rite of Empire*. Its immediate programme was rather Macedonian expansion, at the expense of Thrace and Illyria, and the subjection of the Balkan Peninsula. But, in its efforts to extend its power over the Greek states, it was bound to make use of the tendencies which aimed at the unification of Greece for the struggle against Persia: and this ideal demand it dared not reject.

Thus the conflict became inevitable. In 340, Artaxerxes III. and his satraps supported the Greek towns in Thrace—Perinthus and Byzantium—against Macedonian aggression; in 338 he concluded an alliance with Demosthenes. When Philip, after the victory of Chaeronea, had founded the league of Corinth (337) embracing the whole of Greece, he accepted the national programme, and in 336 despatched his army to Asia Minor. That he never entertained the thought of conquering the whole Persian Empire is certain. Presumably, his ambitions would have been satisfied with the liberation of the Greek cities, and, perhaps, the subjection of Asia Minor as far as the Taurus. With this his dominion would have attained much the same compass as later under Lysimachus; farther than this the boldest hopes of Isocrates never went.

But Philip's assassination in 336 fundamentally altered the situation. In the person of his son, the throne was occupied by a soldier and statesman of genius, saturated with Greek culture and Greek thought, and intolerant of every goal but the highest. To conquer the whole world for Hellenic civilization by the aid of Macedonian spears, and to reduce the whole earth to unity, was the task that this heir of Heracles and Achilles saw before him. This idea of universal conquest was with him a conception much stronger developed than that which had inspired the Achaemenid rulers, and he entered on the project with full consciousness in the strictest sense of the phrase. In fact, if we are to understand Alexander aright, it is fatal to forget that he was overtaken by death, not at the end of his career, but at the beginning, at the age of thirty-three.

VI. *The Macedonian Dominion*.—How Alexander conquered Persia, and how he framed his world-empire, cannot be related here. The essential fact, however, is that after the victory of Gaugamela (Oct. 1, 331 B.C.) and, still *Alexander the Great*, more completely, after the assassination of Darius—avenged according to the Persian laws, on the perpetrators—Alexander regarded himself as the legitimate head of the Persian Empire, and therefore adopted the dress and ceremonial of the Persian kings.

With the capture of the capitals, the Persian war was at an end, and the atonement for the expedition of Xerxes was complete—a truth symbolically expressed in the burning of the palace at Persepolis. Now began the world-conquest. For an universal empire, however, the forces of Macedonia and Greece were insufficient; the monarch of a world-empire could not be bound by the limitations imposed on the tribal king of Macedonia or the general of a league of Hellenic republics. He must stand as

¹ See ALEXANDER THE GREAT; MACEDONIAN EMPIRE; HELLENISM (for later results).

an autocrat, above them and above the law, realizing the theoretical doctrines of Plato and Aristotle, as the true king, who, is a god among men, bound no more than Zeus by a law, because "himself he is the law." Thus the divine kingship of Alexander derives in direct line, not from the Oriental politics—which (Egypt apart) know nothing of royal apotheosis—but from these Hellenic theories of the state. Henceforward it becomes the form of every absolute monarchy in a civilized land, being formally mitigated only in Christian states by the assumption that the king is not God, but king "by the grace of God." The expedition of 332 B.C. to the shrine of Ammon was a preliminary to this procedure, which, in 324, was sealed by his official elevation to divine rank in all the republics of Greece. To this corresponds the fact that, instead of acting on the doctrines of Aristotle and Callisthenes, and treating the Macedonians and Greeks as masters, the Asiatics as servants, Alexander had impartial recourse to the powers of all his subjects and strove to amalgamate them. In the Persians particularly he sought a second pillar for his world-empire. Therefore, as early as 330 B.C., he drafted 30,000 young Persians, educated them in Greek customs, and trained them to war on the Macedonian model. The Indian campaign showed that his Macedonian troops were in fact inadequate to the conquest of the world, and in the summer of 326 they compelled him to turn back from the banks of the Hyphasis. On his return to Persia, he consummated at Susa (Feb. 324 B.C.) the union of Persian and Macedonian by the great marriage-feast, at which all his superior officers, with some 10,000 more Macedonians, were wedded to Persian wives. The Macedonian veterans were then disbanded, and the Persians taken into his army. Simultaneously, at the Olympian festival of 324, the command was issued to all the cities of Greece to recognize him as god and to receive the exiles home.¹ In 323 B.C. the preparations for the circumnavigation and subjection of Arabia were complete: the next enterprise being the conquest of the West, and the battle for Hellenic culture against Carthage and the Italian tribes. At that point Alexander died in Babylon on the 13th of June 323 B.C.

Alexander left no heir. Consequently, his death not only ended the scheme of universal conquest, but led to an immediate Macedonian reaction. The army, which was considered as the representative of the people, took over the government under the direction of its generals. The Persian wives were practically all discarded and the Persian satraps removed—at least from all important provinces. But the attempt to maintain the empire in its unity proved impracticable; and almost immediately there began the embittered war, waged for several decades by the generals (diadochi), for the inheritance of the great king.² It was soon obvious that the eastern rulers, at all events, could not dispense with the native element. Peucestas, the governor of Persia, there played the rôle of Alexander and won the Persians completely to his side; for which he was dismissed by Antigonus in 315 (Diod. xix. 48). A similar position was attained by Seleucus—the only one of the diadochi, who had not divorced his Persian wife, Apama—in Babylonia, which he governed from 319 to 316 and regained in the autumn of 312. While Antigonus, who, since 315, had striven to win the kingdom of Alexander for himself—was detained by the war with his rivals in the west, Seleucus, with Babylon as his headquarters, conquered the whole of Iran as far as the Indus. In northern Media alone, which lay outside the main scene of operations and had only been partially subject to the later Achaemenids, the Persian-satrap Atropates, appointed by Alexander, maintained his independence and bequeathed his province to his successors. His name is borne by north Media to the present day—Atropatene, modern Azerbaijan or Adherbeijan (see MEDIA). So, too, in Armenia the Persian dynasty of the

Hydarnids held its ground; and to these must be added, in the east of Asia Minor, the kingdoms of Pontus and Cappadocia, founded c. 301, by the Persians Mithradates I. and Anarathes I. These states were fragments of the Achaemenid Empire, which had safely transferred themselves to the Hellenistic state-system.

The annexation of Iran by Seleucus Nicator led to a war for the countries on the Indian frontier, his opponent being Sandracottus or Chandragupta Maurya (q.v.), the founder of the great Indian Empire of Maurya (Palimbohra) ^{Seleucus I. Nicator, and Antiochus I.} The result was that Seleucus abandoned to the Indian king, not merely the Indian provinces, but even the frontier districts west of the Indus (Strabo xv. 680-724), receiving as compensation 500 elephants, with other presents (Appian, *Syr.* 55, Justin xv. 4; Plut. *Alex.* 62, Athen. i. 18 D.). His next expedition was to the west to assist Lysimachus, Ptolemy and Cassander in the overthrow of Antigonus.

The battle of Ipsus, in 301, gave him Syria and the east of Asia Minor; and from then he resided at the Syrian town of Antiochia on the Orontes. Shortly afterwards he handed over the provinces east of the Euphrates to his son Antiochus, who, in the following years, till 282, exercised in the East a very energetic and beneficial activity, which continued the work of his father and gave the new empire and the Oriental Hellenistic civilization their form. In order to protect his conquests Alexander had founded several cities in Bactria, Sogdiana and India, in which he settled his veterans. On his death, these revolted and endeavoured to return to Greece, but were attacked and cut to pieces by Piton (Diod. xviii. 7). Of ^{Greek towns in Asia.} the other Greek towns in Asia scarcely any were founded by Alexander himself, though the plan adopted by his successors of securing their dominions by building Greek cities may perhaps be due to him (cf. Polyb. x. 27). Most of these new cities were based on older settlements; but the essential point is, that they were peopled by Greek and Macedonian colonists, and enjoyed civic independence with laws, officials, councils and assemblies of their own, in other words, an autonomous communal constitution, under the suzerainty of the empire. A portion, moreover, of the surrounding land was assigned to them. Thus a great number of the country districts—the *χωρὰ* above mentioned—were transformed into municipal corporations; and thereby withdrawn from the immediate government of the king and his officials (satraps or *strategi*), though still subject to their control, except in the cases where they received unconditional freedom and so ranked as "confederates." The native population of these villages and rural districts, at first, had no civic rights, but were governed by the foreign settlers. Soon, however, the two elements began to coalesce, in the Seleucid Empire, the process seems generally to have been both rapid and complete. Thus the cities became the main factors in the diffusion of Hellenism, the Greek language and the Greek civilization over all Asia as far as the Indus. At the same time they were the centres of commerce and industrial life: and this, in conjunction with the royal favour, and the privileges accorded them, continually drew new settlers (especially Jews), and many of them developed into great and flourishing towns (see further under HELLENISM).

Shortly after his conquest of Babylonia, Seleucus had founded a new capital, Seleucia (q.v.), on the Tigris: his intention being at once to displace the ancient Babylon from its former central position, and to replace it by a Greek city. This was followed by a series of other foundations in Mesopotamia, Babylonia and Susiana (Elam). "Media," says Polybius (x. 27), "was encircled by a sequence of Greek towns, designed as a barrier against the barbarians." Among those mentioned are: Rhagae (Rai), which Seleucus metamorphosed into a Hellenic city, Europus, Laodicea, Apamea and Heraclea (Strabo xi. 525; Plin. vi. 43: cf. MEDIA). To these must be added Achaea in Parthia, and, farther to the east, Alexandria Arion in Aria, the modern Herat: also Antiochia Margiana (Strabo xi. 514, 516; Plin. 46, 93), now Merv, and many others. Further, Alexandria in Aradrosia, near Kandahar, and the towns founded by Alexander on the Hindu-Kash and in Sogdiana.

¹The discussion of these events by Hogarth "The Deification of Alexander the Great," in the *English Historical Review*, II. (1887), is quite unsatisfactory.

²See PROLEMBIA; SELEUCID DYNASTY.

Thus an active Hellenic life soon arose in the East; and Greek settlers must have come in numbers and founded new cities, which afterwards formed the basis of the Graeco-Bactrian kingdom. Antiochus's general Demodamas crossed the Jaxartes and set up an altar to the Didymaeon Apollo (Plin. vi. 49). Another general, Patrocles, took up the investigation of the Caspian, already begun by Alexander. In contrast with the better knowledge of an older period, he came to the conclusion that the Caspian was connected with the ocean, and that it was possible to reach India on ship-board by that route (Strabo ii. 74, xi. 518; Plin. vi. 38). A project of Seleucus to connect the Caspian with the Sea of Azov by means of a canal is mentioned by Pliny (vi. 31). To Patrocles is due the information that an active commerce in Indian wares was carried on with the shores of the Black Sea, via the Caspian (Strabo xi. 509).

While Hellenism was thus gaining a firm footing in all the East, the native population remained absolutely passive. Apart from the rude mountain tribes, no national resistance was dreamed of for centuries. The Iranians quietly accepted the foreign yoke, and the higher classes adopted the external forms of the alien civilization (cf. the dedication of a Bactrian, Hyspasines, son of Mithroaxes, in the inventory of the temple of Apollo in Delos, Dittenberger, *Sylloge*, 588, l. 109) even though they were unable to renounce their innate characteristics. Eratosthenes, for instance, speaks (*op. cit.* Strabo i. 66) in high terms of the Iranians (*Ariani*), ranking them (as well as the Indians, Romans and Carthaginians) on a level with the Greeks, as regards their capacity for adopting city civilization. The later Parsee tradition contends that Alexander burned the sacred books of Zoroaster, the *Avesta*, and that only a few fragments were saved and afterwards reconstructed by the Arsacids and Sassanids. This is absolutely unhistorical. The Persian religion was never attacked by the Macedonians and Greeks. Under their dominion, on the contrary, it expanded with great vigour, not only in the west (Armenia, north Syria and Asia Minor, where it was the official religion of the kings of Pontus and Cappadocia), but also in the east, in the countries of the Indian frontier. That the popular gods—Mithras, Anaitis, &c.—had come to the forefront has already been mentioned. This propagandism, however, was void of all national character, and ran on precisely the same lines as the propagandism of the Syrian, Jewish and Egyptian cults. Only in Persia itself, so far as we can judge from a few scanty traces, the national character of the religion seems to have survived among the people side by side with the memory of their old imperial position.

In 282 B.C. Seleucus took the field against Lysimachus, and annexed his dominions in Asia Minor and Thrace. In 281 he was assassinated in crossing to Europe, and his son Antiochus I. was left supreme over the whole empire. From that time onward the Seleucid Empire was never at rest. Its gigantic extent, from the Aegean to the Indus, everywhere offered points of attack to the enemy. The Lagidae, especially, with their much more compact and effective empire, employed every means to weaken their Asiatic rivals; and auxiliaries were found in the minor states on the frontier—Atropatene, Armenia, Cappadocia, Pontus and Bithynia, the Galatians, Pergamum, Rhodes and other Greek states. Moreover, the promotion of Greek civilization and city life had created numerous local centres, with separate interests and centrifugal tendencies, struggling to attain complete independence, and perpetually forcing new concessions from the empire. Thus the Seleucid kings, courageous as many of them were, were always battling for existence (see SELEUCID DYNASTY).

These disturbances severely affected the borders of Iran. While the Seleucid Empire, under Antiochus II. Theos (264–247), was being harried by Ptolemy II. Philadelphus, and the king's attention was wholly engaged in the defence of the western provinces, the Greeks revolted in Bactria, under their governor Diodotus (q.v.). Obviously, it was principally the need of

protection against the nomadic tribes which led to the foundation of an independent kingdom; and Diodotus soon attained considerable power over the provinces north of the Hindu-Kush. In other provinces, too, insurrection broke out (Strabo xi. 575, Justin xli. 4), and Arsaces, a chief of the Parni or Aparani—an Iranian nomad tribe (therefore often called Dahan Scythians), inhabiting the steppe east of the Caspian—made himself master of the district of Parthia (q.v.) in 248 B.C. He and his brother Tiridates (q.v.) were the founders of the Parthian kingdom, which, however, was confined within very modest limits during the following decades. Seleucus II. Callinicus (247–226) successfully encountered Arsaces (or Tiridates), and even expelled him (c. 238), but new risings recalled Seleucus to Syria, and Arsaces was enabled to return to Parthia.

Greater success attended Antiochus III., the Great (222–187). At the beginning of his reign (220) he subdued, with the help of his minister Hermias, an insurrection of the satrap Molon of Media, who had assumed the royal title and was supported by his brother Alexander, satrap of Persis (Polyb. v. 40 sqq.). He further seized the opportunity of extorting an advantageous peace from King Artabazanes of Atropatene, who had considerably extended his power (Polyb. v. 55). After waging an unsuccessful war with Ptolemy IV. for the conquest of Coele-Syria, but suppressing the revolt of Achaeus in Asia Minor, and recovering the former provinces of the empire in that quarter, Antiochus led a great expedition into the East, designing to restore the imperial authority in its full extent. He first removed (211) the Armenian king Xerxes by treachery (Polyb. viii. 25; John of Antioch, *fr.* 53), and appointed two governors, Artaxias and Zariadris, in his place (Strabo xi. 531). During the next year he reduced the affairs of Media to order (Polyb. x. 27); he then conducted a successful campaign against Arsaces of Parthia (209), and against Euthydemus (q.v.) of Bactria (208–206), who had overthrown the dynasty of Diodotus (Polyb. x. 28 sqq., 48 sqq., xi. 34; Justin xli. 5). In spite of his successes he concluded peace with both kingdoms, rightly considering that it would be impossible to retain these remote frontier provinces permanently. He next renewed his old friendship with the Indian king Sophaganesa (Subhagasesa), and received from him 190 elephants (206 B.C.). Through Arachosia and Drangiane, in the valley of the Etymander (Helmand), he marched to Carmania and Persis (Polyb. xi. 34). Both here and in Babylonia he re-established the imperial authority, and in 205 undertook a voyage from the mouth of the Tigris, through the Arabian gulf to the flourishing mercantile town of Gerrha in Arabia (now Bahrein) (Polyb. xiii. 9).

Shortly afterwards, however, his successful campaign against Ptolemy V. Epiphanes led to a war with Rome in which the power of the Seleucid Empire was shattered (190 B.C.), *Decree of the Asia Minor* lost, and the king compelled to pay a *Subsidy* heavy contribution to Rome for a long term of years. In order to raise money he plundered a wealthy temple of Bel in Elam, but was killed by the inhabitants, 187 B.C. (Diod. xviii. 3, xxix. 15; Strabo xvi. 744; Justin xxxii. 2; S. Jerome (Hieronymus) on *Dan.* xi. 19; Euseb. *Chron.* i. 253). The consequence of this enfeeblement of the empire was that the governors of Armenia asserted their independence. Artaxias founded the kingdom of Great Armenia; Zariadris, that of Sophene on the Euphrates and the sources of the Tigris (Strabo xi. 531). In other districts, also, rebellions occurred; and in the east, Euthydemus and his successors (Demetrius, Eucratidas, &c.) began the conquest of the Indus region and the Iranian borderland (Arachosia, Aria). (See BACTRIA; EUTHYDEMUS; EUCRATIDAS; DEMETRIUS; MENANDER.)

But the energetic Seleucids fought desperately against their fate. Antiochus IV. Epiphanes (176–163) restored once more the Eastern dominion, defeated Artaxias of Armenia (Apollon, *Syr.* 45, Diod. xxxi. 174; S. Jerome on *Dan.* xi. 40), restored several towns in Babylonia and subdued the Etymians. His attempt, however, to plunder the sanctuary of Anaitis failed (Polyb. xxxi. 22; cf. *Maccab.* i. 6, ii. 1, 13; *App. Syr.* 66). Persis, also, and

Media were still subject to him. But after his death at Tabae in Persia (163 B.C.; cf. Polyb. xxxi. 11; Maccab. i. 6, ii. 9; Jos. Ant. Jud. xii. 9, 1), the Romans took advantage of the dynastic broils to destroy the Seleucid Empire. They reduced its army and fleet, and favoured every rebellion: among others, that of the Jews. In spite of all, Demetrius I. Soter (161-150) succeeded in suppressing (150) a revolt of Timarchus of Miletus, governor of Babylon, who had occupied Media, assumed the title of "great king," and had been recognized by the Romans (Appian, Syr. 45-47; Trogus, Procl. 34; Diod. xxxi. 27 A: cf. the coins of Timarchus).¹

VII. *The Parthian Empire of the Arsacids.*—Meanwhile, in the east, the Arsacids had begun their expansion. Phraates I. (c. 175-170) subdued the Mardians in Elburz. His brother Mithradates I. (c. 170-138) had to sustain a difficult war with Eucratides of Bactria, but eventually succeeded in wresting from him a few districts on the Turanian frontier *Mithradates I.* and indeed, he penetrated as far as, and farther than, the Phraates II. Indus (Diod. xxxiii. 18; Oros. v. 4, 16). In the west he conquered Media, and thence subdued Babylonia. He further reduced the Elymaeans, sacked their temple in the mountains, and captured the Greek city of Seleucia on the Hedyphon (Strabo xvi. 744; Justin li. 6). The Seleucids, meanwhile, were harassed by aggravated disorders and insurrections. Nevertheless, in 140, Demetrius II. Nicator took the field in order to save the east, but was defeated and captured. Shortly afterwards Mithradates I. died. His son Phraates II. (c. 138-127) was attacked in 130 by Antiochus VII. Sidetes, the brother of Demetrius II., on which the Parthian king released the latter Antiochus pressed successfully on, and once more recovered Babylonia, but in 129 was defeated in Media and fell in a desperate struggle. With this battle the Seleucid dominion over the countries east of the Euphrates was definitely lost. The Babylonian towns, especially Seleucia (q.v.), were handed over by Phraates to his favourite, the Hyrcanian Himerus, who punished them severely for their resistance.

During these was great changes had taken place in eastern Iran. In 159 Mongolian tribes, whom the Chinese call Yue-chi and the Greeks Scythians, forced their way into *Mithradates II. and his Successors.* and, in 139, conquered Bactria (Strabo xi. 571; Justin xlii. 1; Trog. Procl. 41; see BACTRIA). From Bactria they tried to advance farther into Iran and India. Entering into an alliance with Antiochus VII., they assailed the Parthian Empire. Phraates II. marched to encounter him, but was himself defeated and slain, and his country ravaged far and wide. His successor Artabanus I. (c. 127-124), the uncle of Phraates, also fell in battle against the Tocharians, the principal Scythian tribe (Justin xlii. 1, 2; Jos. Ant. fr. 66); but his son Mithradates II., surnamed "The Great" (c. 124-88), defeated the Scythians and restored for a while the power of the Arsacids. He also defeated Artavasdes, the king of Great Armenia, his son Tigranes, a hostage in the hands of the Parthians, was only redeemed by the cession of 70 valleys (Strabo xi. 532). When Tigranes attempted to seize Cappadocia, and the Roman praetor P. Cornelius Sulla advanced against him, Mithradates in 92 B.C. concluded the first treaty between Parthia and Rome (Plut. Sulla, v.; Liv. epit. 70). The dynastic troubles of the Seleucids in Syria gave him an opportunity for successful intervention (Jos. Ant. Jud. xiii. 13, 4; 14, 3). Shortly afterwards he died, and, with his death, the Arsacid power collapsed for the second time. The possession of the western provinces and the dominant position in western Asia passed to the Armenian Tigranes (q.v.), who wrested from the Parthians Mesopotamia and the suzerainty of Atropatene, Gordyene, Adiabene, Osroene. Simultaneously began a new and severe conflict with the Scythians. Parthian coins, probably dating from this period (Wroth, Catal. of the Coins of Parthia, 1903, p. xxx. and p. 40), mention victorious campaigns of Parthian kings and a conquest of the provinces of Aria, Margiane and (?) Traxiane (cf. Strabo xi. 505). But how

¹ For the whole of this period see further ANTIGONUS; ANTIOCHUS I.-IV.; SELEUCID DYNASTY; HELLLENISM.

confused the situation was shown by the fact that in 76 B.C. the octogenarian king Sanatruces was seated on the Parthian throne by the Scythian tribe of the Sacaracians (cf. Strabo xi. 511; Trog. Procl. 42). The names of his predecessors are not known to us. Obviously this period was marked by continual dynastic feuds (cf. Trog. Procl. 42: "ut varia complurium regum in Parthia successione imperium accepit Orodus qui Crasum delevit"). Not till Sanatruces' successor Phraates III. (70-57) do we find the kingdom again in a settled state.

A fact of decisive significance was that the Romans now began to advance against Tigranes. In vain Mithradates of Pontus and Tigranes turned to the Parthian king, the latter even proffering restitution of the conquered frontier provinces. Phraates, though rightly distrusting Rome, nevertheless concluded a treaty with Lucullus (69 B.C.) and with Pompey, and even supported the latter in his campaign against Tigranes in 66. But after the victory it was manifest that the Roman general did not consider himself bound by the Parthian treaty. When Tigranes had submitted, Pompey received him into favour and extended the Roman supremacy over the vassal states of Gordyene and Osroene; though he had allured the Parthian king with the prospect of the recovery of his old possessions as far as the Euphrates. Phraates complained, and simultaneously attacked Tigranes, now a Roman vassal (64 B.C.) But when Pompey refused reparation Phraates recognized that he was too weak to begin the struggle with Rome, and contented himself with forming an alliance with Tigranes, in hopes that the future would bring an opportunity for his revenge (Dio Cass. xxxvi. 3, 5; xxxvii. 5 sqq.; Plut. Luc. 30; Pomp. 33, 38, cf. Sallust's letter of Mithradates to Arsaces).

Although Phraates III. had not succeeded in regaining the full power of his predecessors, he felt justified in again assuming the title "king of kings"—which Pompey declined to acknowledge—and even in proclaiming himself as "god" (Phlegon, fr. 12 ap. Phot. cod. 97; and on part of his coins), but in 57 B.C. the "god" was assassinated by his sons Orodus and Mithradates.

The Parthian Empire, as founded by the conquests of Mithradates I. and restored, once by Mithradates II. and again by Phraates III., was, to all exterior appearance, a continuation of the Achaemenid dominion. Thus the Arsacids now began to assume the old title "king of kings" (the *shahanshah* of modern Persia), though previously their coins, as a rule, had borne only the legend "great king." The official version, preserved by Arrian in his *Parthica* (ap. Phot. cod. 58; see PARTHIA), derives the line of these chieftains of the Parnian nomads from Artaxerxes II. In reality, however, the Parthian Empire was totally different from its predecessor, both externally and internally. It was anything rather than a world-empire. The countries west of the Euphrates never owned its dominion, and even of Iran itself not one half was subject to the Arsacids. There were indeed vassal states on every hand, but the actual possessions of the kings—the provinces governed by their satraps—consisted of a rather narrow strip of land, stretching from the Euphrates and north Babylonia through southern Media and Parthia as far as Arachosia (north-west Afghanistan), and following the course of the great trade-route which from time immemorial had carried the traffic between the west of Asia and India. We still possess a description of this route by Isidore of Charax, probably dating from the Augustan period (in C. Müller, *Geographi graeci minores*, vol. 1), in which is contained a list of the 18 imperial provinces, known also to Pliny (vi. 112, cf. 41). Isidore, indeed, enumerates nineteen; but, of these, Sacastene formed no part of the Parthian Empire, as has been shown by von Gutschmid.

The lower provinces (i.e. the districts west of Parthia) are: (1) Mesopotamia, with northern Babylonia, from the Euphrates bridge at Zeugma to Seleucia on the Tigris; (2) Apolloniatis, the provinces plain east of the Tigris, with Artemita; (3) Chalonitis, the hill-country of Zagros; (4) Western Media; (5) Cambadene, with Bagistana (Behistun)—the mountainous portions of Media; (6) Upper Media, with Ecbatana; (7) Rhagiane or Eastern Media. Then with the Caspian Gates—the pass between Elburz and the central desert, through which lay the route from west Iran to east Iran—the upper provinces begin; (8) Choresene and (9)

Comisene, the districts on the verge of the desert; (10) Hyrcania; (11) Astabene, with the royal town Asaac on the Attruck (see PARTHIA); (12) Parthene with Parthauisena, where the sepulchres of the kings were laid; (13) Apavartcene (now Abiward, with the capital Kelat); (14) Margiane (Merv); (15) Aria (Herat); (16) Anauoa, the southern portion of Aria; (17) Zarangiane, the country of the Drangians, on the lake of Hamun; (18) Arachosia, on the Etymander (Helmand), called by the Parthians "White India," extending as far as Alexandropolis (Kandahar), the frontier city of the Parthian Empire.

On the lower Etymander, the Sacae had established themselves—obviously on the inroad of the Scythian tribes—and after them the country was named Sacastene (now Seistan, Seistan). Through it lay the route to Kandahar; and for this reason the district is described by Isidore, though it formed no part of the Parthian Empire.

Roads these provinces lay a ring of numerous minor states, which as a rule were dependent on the Arsacids. They might, however, partially transfer their allegiance on the rise of a new power (e.g. Tigranes in Armenia) or a Roman invasion. Thus it is not without justice that the Arsacid period is described, in the later Persian and Arabian tradition, as the period of "the kings of the part-kingdoms"—among which the Ashkanians (i.e. the Arsacids, from *Ashak*, the later pronunciation of the name *Arsak*=Arsaces) had won the first place. This tradition, however, is nebulous in the extreme, the whole list of kings, which it gives, is totally unhistorical; only the names of one Balash (=Vologaeses) and of the last Ardewan (=Artabanus) having been preserved. The period, from the death of Alexander to the Sassanid Ardashir I., is put by the Persian tradition at 266 years; which was afterwards corrected, after Syro-Grecian evidence, to 523 years. The actual number is 548 years (i.e. 323 B.C. to A.D. 225). The statements of the Armenian historians as to this period are also absolutely worthless.

The ten most important of the vassal states were:—

1. The kingdom of Osroene (s.p.) in the north-east of Mesopotamia, with Edessa as capital, founded about 130 B.C. by the chieftain of an Arabian tribe, the Orrhoi, which established itself there.

2. To this must be added the numerous Arabian tribes of the Mesopotamian desert, under their chiefs, among whom one Alchaulonius comes into prominence in the period of Tigranes and Crassus. Their settlement in Mesopotamia was encouraged by Tigranes, according to Plutarch (*Luc.* 21) and Pliny (vi. 142). In later times the Arabic town Atra in an oasis on the west of the Tigris, governed by its own kings, gained special importance.

3 and 4. To the east of the Tigris lay two kingdoms. Gordyene (or Cordyene), the country of the Carduchians (now Bohtan), a wild, mountainous district south of Armenia; and Adiabene (Hadyab), the ancient Assyria, on either side of the Zab (Lycur).

5. On the farther side of Zagros, adjoining Adiabene on the east, was the kingdom of Atropatene in north Media, now often simply called Media (s.p.).

While the power of Armenia was at its height under Tigranes (86-69 B.C.) all these states owned his rule. After the victories of Pompey, however, the Romans claimed the suzerainty, so that, during the next decades and the expeditions of Crassus and Antony, they oscillated between Rome and Parthia, though their inclination was generally to the latter. For they were all Orientals and, consciously or unconsciously, representatives of a reaction against that Hellenism which had become the heritage of Rome. At the same time the loose organization of the Parthian Empire, afforded them a greater measure of independence than they could hope to enjoy under Roman suzerainty.

6. In the south of Babylonia, in the district of Mesene (the modern *Masan*), after the fall of Antiochus Sidetes (129 B.C.), an Arabian prince, Hyaspasines or Spasines (in a cuneiform inscription of 127, on a clay tablet dated after this year, he is called *Aspasine*) founded a kingdom which existed till the rise of the Sassanid Empire. Its capital was a city (mod. *Mohammerah*), first founded by Alexander on an artificial hill by the junction of the Eulaeus (Karun) with the Tigris, and peopled by his veterans. The town, which was originally named *Alexandria* and then rebuilt by Antiochus I. as *Antiochia*, was now re fortified with dikes by Spasines, and christened *Spasinu Charax* ("the wall of Spasines"), or simply *Charax* (Plin. vi. 138 seq.). In the following centuries it was the main mercantile centre on the Tigris estuary.

The kingdom of Mesene, also called *Characene*, is known to us from occasional references in various authors, especially Lucian (*Macrobis*, 16), as well as from numerous coins, dated by the Seleucian era, which allow us to frame a fairly complete list of the kings. The Arabian dynasty speedily assimilated itself to the native population; and most of the kings bear Babylonian—in a few cases, Parthian—names. The official language was Greek, till, on the destruction of Seleucia (A.D. 164), it was replaced on the coinage by Aramaic. Another Babylonian dynast must have

¹ See Saint-Martin, *Recherches sur la Mésène et la Characène* (1838); Reinaud, *Mémoires sur le royaume de la Mésène* (1861); E. Babelon, "Numism. et chronol. des dynasties de la Characène," in *Journ. internat. d'archéol. summim.* vol. 4 (1898).

been *Hadadnadinachep* (c. 100 B.C.), who built in Tello the fortified palace which has been excavated by de Sarzec.

7. East of the Tigris lay the kingdom of Elymais (Elam), to which belonged Susa and its modern representative Ahwas, farther down on the Eulaeus. The Seleucians, who had already offered a repeated resistance to the Elymaeans, were subdued by Mithradates I., as we have mentioned above; but they remained a separate state, which often rebelled against the Arsacids (Strabo xvi. 744; cf. Plut. *Pomp.* 36; *Tac. Ann.* vi. 50). Of the kings who apparently belonged to a Parthian dynasty, several bearing the name *Carmanas* are known to us from coins dated 81 and 71 B.C. One of these is designated by Lucian (*Macrobis*, 16) "king of the Parthians"; while the coinage of another, Orodes, displays Aramaic script (Allotte de la Fuye, *Ren. num.* 4me série, t. vi. p. 92 sqq., 1902). The kingdom, which is seldom mentioned, survived till Ardashir I. In its neighbourhood Strabo mentions "the minor dynasties of the Sagapenians and Silaceniens" (xvi. 745). The Uxians, moreover, with the Cosseans and other mountain tribes, maintained their independence exactly as under the later Achæmenids (Strabo xvi. 744; Plin. vi. 133).

8. The district of Persis, also, became independent soon after the time of Antiochus IV., and was ruled by its own kings, who perpetuated the Achæmenian traditions, and on their coins—which bear the Persian language in Aramaic characters, i.e. the so-called Pahlavi—appear as zealous adherents of Zoroastrianism and the Fire-cult (see PERSIS). They were forced, however, to acknowledge the suzerainty of Parthia, to which they stood in the same position as the Persians of Cyrus and his forefathers to the Median Empire (cf. Strabo xv. 728, 733, 736; Lucian, *Macrob.* 15). In later times, before the foundation of the Sassanid dominion, Persis was disintegrated into numerous small local states. Even in Carmania we find independent kings, one of whom gave his name to a town *Vologesocerta* (*Balashker*).

9. The east of Iran—Bactria with Sogdians, Eastern Arachosia and Gedrosia—was never subject to the Arsacids. Here the Graeco-Bactrian and Graeco-Indian kingdoms held their own, till, in 139 B.C., they succumbed before the invading Mongolians and Scythian tribes (see BACTRIA and works quoted there). But in the Indus district the Greek kings held their ground for an appreciably longer period and, for a while, widely extended their power (see MENANDER OF INDIA). Among the kings then following, only known to us from their coins, there appears a dynasty with Iranian and sometimes peculiarly Parthian names which seems to have reigned in the Punjab and Arachosia. Its best-known representative, Gondophares or Hyndopheres, to whom legend makes the apostle Thomas write, reigned over Arachosia and the Indus district about A.D. 20. Further, about A.D. 70, the *Periplus* of the Erythraean Sea, mentions that the great commercial town of Minnagar in the Indus Delta was under Parthian kings, "who spent their time in expelling one another." Here, then, it would seem there existed a Parthian dynasty, which probably went back to the conquests of Mithradates I. (cf. Vincent A. Smith, "The Indo-Parthian Dynasties from about 120 B.C. to A.D. 100," in the *Zeitschr. der deutschen morgenl. Geschl.* 60, 1906). Naturally, such a dynasty would not long have recognized the suzerainty of the Arsacids. It succumbed to the Indo-Scythian Empire of the Kushana, who had obtained the sovereignty of Bactria as early as about A.D. 50, and thence pressed onward into India. In the period of the *Periplus* (c. A.D. 70) the Scythians were already settled in the Indus valley (pp. 38, 41, 48), their dominion reaching its zenith under Kanishka (c. A.D. 123-153).

This empire of the Kushana merits special mention here, on account of its peculiar religious attitude, which we may gather from the coins of its kings, particularly those of Kanishka and his successor Huvishka, on which an alphabet adapted from the Greek is employed (cf. Aurel Stein, "Zoroastrian Deities on Indo-Scythian Coins," in *The Babylonian and Oriental Record*, vol. i. 1887). Kanishka, as is well known, had embraced Buddhism, and many of his coins bear the image and name of Buddha. Iranian divinities, however, predominate on his currency: Mithras (*Mithro* or *Helios*), the Moon *Mah* (also *Selene*), *Athra*, the Fire: *Ohrmazd* (*Verethraghna*): *Pharro*=Farna (Svarena), "the majesty of kingship"; *Tero*=Tir (Tistrya "the archer"); *Nana* (Nanaia), and others. Here, then, we have a perfect example of syncretism: as in the Mithras cult in Armenia, Asia Minor, and still further in the Roman Empire Buddhism and Zoroastrianism have been wedded in the state religion, and, in characteristic Indian fashion, are on the best of terms with one another, precisely as, in the Chinese Empire at the present day, we find the most varied religions, side by side, and on an equal footing.

10. Originally a part of the Turanian steppe belonged to the Arsacids; it was the starting-point of their power. Soon, however, the nomads (*Dahae*) gained their independence, and, as we have seen, repeatedly attacked and devastated the Parthian Empire in conjunction with the Tocharians and other tribes of Sacae and Scythians. In the subsequent period, again, we shall frequently meet them.

It may appear surprising that the Arsacids made no attempt to incorporate the minor states in the empire and

create a great and united dominion, such as existed under the Achaemenids and was afterwards restored by the Sassanids. This fact is the clearest symptom of the inner weakness of the Parthians "king of kings." In contrast alike with its predecessors and its successors, the Arsacid dominion was peculiarly a chance formation—a state which had come into existence through fortuitous external circumstances, and had no firm foundation within itself, or any intrinsic *raison d'être*.

Three elements, of widely different kinds, contributed to its origin and defined its character. It was sprung from a predatory nomad tribe (the Parthian Dahae, Scythians) which had established itself in Khorasān (Parthia), on the borders of civilization, and thence gradually annexed further districts as the political situation or the weakness of its neighbours allowed. Consequently, these nomads were the main pillar of the empire, and from them were obviously derived the great magnates, with their huge estates and hosts of serfs, who composed the imperial council, led the armies, governed the provinces and made and unmade the kings (Strabo xi. 515; Justin xli. 2; the former terming them *εργασις*, "kingsmen" of the king; the latter, *προβουλι*). Of these great families that of Surenas held the privilege of setting the diadem on the head of the new king (Plut. *Cass* 21, Tac. *Ann* vi. 42).

The military organization, moreover, was wholly nomadic in character. The nucleus of the army was formed of armoured horsemen, excellently practised for long-distance fighting with bow and javelin, but totally unable to venture on a hand-to-hand conflict their tactics being rather to swarm round the enemy's squadrons and overwhelm them under a hail of missiles. When attacked they broke up, as it seemed, in hasty and complete flight, and having thus led the hostile army to break its formation, they themselves rapidly reformed and renewed the assault. How difficult it was for infantry to hold their own against these mounted squadrons was demonstrated by the Roman campaigns, especially in broad plains like those of Mesopotamia. In winter, however, the Parthians were powerless to wage war, as the moisture of the atmosphere relaxed their bows. The infantry, in contrast with its earlier status under the Persians, was wholly neglected. On the other hand, every magnate put into the field as many mounted warriors as possible, chiefly servants and bought slaves, who, like the Janissaries and Mamelukes, were trained exclusively for war. Thus Surenas, in 53 B.C., is said to have put at the king's disposal 1000 mailed horsemen and, in all, 20,000 men, including the train, which also comprised his attendants and harem (Plut. *Cass* 21; description of the military organization; Dio Cass. 40, 15; Justin xli. 2). In the army of 50,000 mounted men which took the field against Mark Antony there were, says Justin, only 400 freemen.

How vital was the nomadic element in the Parthian Empire is obvious from the fact that, in civil wars, the deposed kings consistently took refuge among the Dahae or Scythians and were restored by them. But, in Parthia, these nomads were amalgamated with the native peasantry, and, with their religion, had adopted their dress and manners. Even the kings, after the first two or three, wear their hair and beard long, in the Iranian fashion, whereas their predecessors are beardless. Although the Arsacids are strangers to any deep religious interest (in contrast to the Achaemenids and Sassanids), they acknowledge the Persian gods and the leading tenets of Zoroastrianism. They erect fire-altars, and even obey the command to abandon all corpses to the dogs and fowls (Justin xli. 3). The union, moreover, recommended by that creed, between brother and sister—and even son and mother—occurs among them. Consequently, beside the council of the nobility, there is a second council of "Magians and wise men" (Strabo xi. 515).

Again, they perpetuate the traditions of the Achaemenid Empire. The Arsacids assume the title "king of kings" and derive their line from Artaxerxes II. Further, the royal apothecosis, so common among them and recurring under the Sassanids, is probably not so much of Greek origin as a development of Iranian views. For at the side of the great god Ahuramazda there stands a host of subordinate divine beings who execute his will—among these the deified heroes of legend, to whose circle the king is now admitted, since on him Ahuramazda has bestowed victory and might.

This gradual Iranianization of the Parthian Empire is shown by the fact that the subsequent Iranian traditions, and Firdousi in particular, apply the name of the "Parthian" magnates (*Pahlavan*) to the glorious heroes of the legendary epoch. Consequently, also, the language and writing of the Parthian period, which are retained under the Sassanids, received the name *Pahlavi*, i.e. "Parthian." The script was derived from the Aramaic.

But to these Oriental elements must be added that of Hellenism, the dominant world-culture which had penetrated into Parthia and Media. It was indispensable to every state which hoped to play some part in the world and was not so utterly secluded as Persia and Atropatene; and the Arsacids entertained the less thought of opposition as they were destitute of an independent national basis. All their

external institutions were borrowed from the Seleucid Empire: their coinage with its Greek inscriptions and nomenclature; their Attic standard of currency; and, doubtless, a great part of their administration also. In the towns Greek merchants were everywhere settled. Mithradates I. even followed the precedent of the Seleucids in building a new city, Arsacia, which replaced the ancient Rhagae (Ral, Europus) in Media. The further the Arsacids expanded the deeper they penetrated into the province of Hellenism; the first Mithradates himself assumed, after his great conquests, the title of *Philhellen*, "the protector of Hellenism," which was retained by almost all his successors. Then follow the surnames *Epiphanes* "the revealed god," *Dicaeus* "the just," *Euergetes* "the benefactor," all of them essentially Greek in their reference, and also regularly borne by all the kings. After the conquest of the Euphrates and Tigris provinces it was imperative that the royal residence should be fixed there. But as no one ventured to transfer the royal household and the army, with its hordes of wild horsemen, to the Greek town of Seleucia, and thus disorganize its commerce, the Arsacids set up their abode in the great village of Ctesiphon, on the left bank of the Tigris, opposite to Seleucia, which accordingly retained its free Hellenic constitution (see Ctesiphon and Seleucia). So, also, Ordes I. spoke good Greek, and Greek tragedies were staged at his court (Plut. *Cass* 33).

In spite of this, however, the rise of the Arsacid Empire marks the beginning of a reaction against Hellenism—not, indeed, a conscious or official reaction, but a reaction which was *Reaction* all the more effective because it depended on the impetus *against* *Hellenism*. of circumstances working with all the power of a natural force. The essential point is that the East is completely divorced from the Mediterranean and the Hellenic world, that it can derive no fresh powers from that quarter, and that, consequently, the influence of the Oriental elements must steadily increase. This process can be most clearly traced on the coins—almost the sole memorials that the Parthian Empire has left. From reign to reign the portraits grow poorer and more stereotyped, and the inscriptions more neglected, till it becomes obvious that the engraver himself no longer understood Greek but copied mechanically the signs before his eyes, as is the case with the contemporary Indo-Scythian coinage, and also in Mesene. Indeed, after Vologaes I. (51-77), the Aramaic script is occasionally employed. The political opposition to the western empires, the Seleucids first, then the Romans, precipitated this development. Naturally enough the Greek cities beheld a liberator in every army that marched from the West, and were ever ready to cast in their lot with such—a disposition for which the subsequent penalty was not lacking. The Parthian magnates, on the other hand, with the army, would have little to do with Greek culture and Greek modes of life, which they contemptuously regarded as effeminate and unmanly. Moreover, they required of their rulers that they should live in the fashion of their country, practise arms and the chase, and appear as Oriental sultans, not as Grecian kings.

These tendencies taken together explain the radical weakness of the Parthian Empire. It was easy enough to collect a great army and achieve a great victory; it was absolutely impossible to hold the army together (or any longer period, or to conduct a regular campaign. The Parthians proved incapable of creating a firm, united organization, such as the Achaemenids before them, and the Sassanids after them gave to their empire. The kings themselves were toys in the hands of the magnates and the army who, tenaciously as they clung to the anointed dynasty of the Arsacids, were utterly indifferent to the person of the individual Arsacid. Every moment they were ready to overthrow the reigning monarch and to seat another on his throne. The kings, for their part, sought protection in craft, treachery and cruelty, and only succeeded in aggravating the situation. More especially they saw an enemy in every prince, and the worst of enemies in their own sons. Sanguinary crimes were thus of everyday occurrence in the royal household; and frequently it was merely a matter of chance whether the father anticipated the son, or the son the father. The conditions were the same as obtained subsequently under the Mahomedan Caliphate (q.v.) and the empire of the Ottomans. The internal history of the Parthian dominion is an unbroken sequence of civil war and dynastic strife.

For the literature dealing with the Parthian Empire and numismatics, see PARTHIA, under which heading will be found a complete list of the kings, so far as we are able to reconstitute them.

These conditions elucidate the fact that the Parthian Empire, though founded on annexation and perpetually menaced by hostile arms in both the East and the West, yet *Later History of the Arsacids* never took a strong offensive after the days of Mithradates I. It was bound to protect itself against Scythian aggression in the East and Roman aggression in the West. To maintain, or regain, the suzerainty over Mesopotamia and the vassal states of that region, as also over Atropatene and Armenia, was its most imperative task. Yet it always remained on the defensive and even so was

lacking in energy. Whenever it made an effort to enforce its claims, it retreated so soon as it was confronted by a resolute foe.

Thus the wars between Parthia and Rome proceeded, not from the Parthians—deeply injured though they were by the Wars with encroachments of Pompey—but from Rome herself. Crassus and Antiochus. Rome had been obliged, reluctantly enough, to enter upon the inheritance of Alexander the Great; and, since the time of Pompey, had definitely subjected to her dominion the Hellenistic countries as far as the Euphrates. Thus the task now faced them of annexing the remainder of the Macedonian Empire, the whole East from the Euphrates to the Indus, and of thereby saving Greek civilization (cf. Plut. *Comp. Nic. et Crass.* 4). The aristocratic republic quailed before such an enterprise, though Lucullus, at the height of his successes, entertained the thought (Plut. *Luc.* 30). But the ambitious men, whose goal was to erect their own sovereignty on the ruins of the republic, took up the project. With this objective M. Licinius Crassus, the triumvir, in 54 B.C., took the aggressive against Parthia, the occasion being favourable owing to the dynastic troubles between Orodes I., the son of Phraates III., and his brother Mithradates III. Crassus fell on the field of Carrhae (June 9, 53 B.C.). With this Mesopotamia was regained by the Parthians, and King Artavasdes of Armenia now entered their alliance. But, apart from the ravaging of Syria (51 B.C.) by Pacorus the son of Orodes, the threatened attack on the Roman Empire was carried into effect neither then nor during the civil wars of Caesar and Pompey. At the time of his assassination Caesar was intent on resuming the expedition of Crassus. The Parthians formed a league with Brutus and Cassius, as previously with Pompey, but gave them no support, until in 40 B.C. a Parthian army, led by Pacorus and the republican general Labienus, harried Syria and Asia Minor. But it was easily repulsed by Ventidius Bassus, the lieutenant of Mark Antony. Pacorus himself fell on the 9th of June 38 B.C. at Gindarus in northern Syria. Antony then attacked the Parthians in 36 B.C., and penetrated through Armenia into Atropatene, but was defeated by Phraates IV.—who in 37 B.C. had murdered his father Orodes I.—and compelled to retreat with heavy losses. The continuation of the war was frustrated by the conflict with Octavian. Armenia alone was again subdued in 34 B.C. by Antony, who treacherously captured and executed King Artavasdes.

Roman opinion universally expected that Augustus would take up the work of his predecessors, annihilate the Parthian dominion, and subdue the East as far as the Policy of Augustus. Indians, Scythians and Seres (cf. Horace and the other Augustan poets). But Augustus disappointed these expectations. His whole policy and the needs of the newly organized Roman Empire demanded peace. His efforts were devoted to reaching a *modus vivendi*, by which the authority of Rome and her most vital claims might be peacefully vindicated. This the weakness of Parthia enabled him to effect without much difficulty. His endeavours were seconded by the revolt of Tiridates II., before whom Phraates IV. was compelled to flee (32 B.C.), till restored by the Scythians. Augustus lent no support to Tiridates in his second march on Ctesiphon (26 B.C.), but Phraates was all the more inclined on that account to stand on good terms with him. Consequently in 20 B.C., he restored the standards captured in the victories over Crassus and Antony, and recognized the Roman suzerainty over Osroene and Armenia. In return, the Parthian dominion in Babylonia and the other vassal states was left undisputed.

Thus it was due not to the successes and strength of the Parthians but entirely to the principles of Roman policy as defined by Augustus that their empire appears as a second great independent power, side by side with Rome. The precedence of the Caesars, indeed, was always admitted by the Arsacids; and Phraates IV. soon entered into a state of dependency on Rome by sending (9 B.C.) four of his sons as hostages to Augustus—a convenient method of obviating the danger threatened in their person, without the necessity of killing them. In 4 B.C., however,

Phraates was assassinated by his favourite wife Musa and her son Phraates V. In the subsequent broils a Parthian faction obtained the release of one of the princes interned in Rome as Vonones I. (A.D. 8). He failed, however, to maintain his position for long. He was a stranger to the Parthian customs, and the feeling of shame at dependency on the foreigner was too strong. So the rival faction brought out another Arsacid, resident among the Scythian nomads, Artabanus II., who easily expelled Vonones—only to create a host of enemies by his brutal cruelty, and to call forth fresh disorders.

Similar proceedings were frequently repeated in the period following. In the intervals the Parthians made several attempts to reassert their dominion over Armenia and there install an Arsacid prince; but on each occasion ^{Reign of Vologases I.} they retreated without giving battle so soon as the Romans prepared for war. Only the dynasty of Atropatene was finally deposed and the country placed under an Arsacid ruler. Actual war with Rome broke out under Vologases I. (51-77), who made his brother Tiridates king of Armenia. After protracted hostilities, in which the Roman army was commanded by Cn. Domitius Corbulo, a peace was concluded in A.D. 63, confirming the Roman suzerainty over Armenia but recognizing Tiridates as king (see CORBULO). Tiridates himself visited Rome and was there invested with the diadem by Nero (A.D. 66). After that Armenia continued under the rule of an Arsacid dynasty.

These successes of Vologases were counterbalanced by serious losses in the East. He was hampered in an energetic campaign against Rome by attacks of the Dahae and Sacae. Hyrcania, also, revolted and asserted its independence under a separate line of kings. A little later, the Alans, a great Iranian tribe in the south of Russia—the ancestors of the present-day Ossets—broke for the first time through the Caucasian passes, and ravaged Media and Armenia—an incursion which they often repeated in the following centuries.

On the other side, the reign of Vologases I. is characterized by a great advance in the Oriental reaction against Hellenism. The line of Arsacids which came to the throne in the person of Artabanus II. (A.D. 10) stands in open opposition to the old kings with their leanings to Rome and, at least external, tinge of Hellenism. The new régime obviously laid much more stress on the Oriental character of their state, though Philostratus, in his life of Apollonius of Tyana (who visited the Parthian court), states that Vardanes I. (A.D. 40-45), the rival king to the brutal Gotarzes (A.D. 40-51), was a cultivated man (*Vit. Ap.* i. 22, 28, 31 sqq.); and Vologases I. is distinguished by the excellent relations which subsisted all his life between himself and his brothers Pacorus and Tiridates, the kings of Media and Armenia. But the coins of Vologases I. are quite barbarous, and for the first time on some of them appear the initials of the name of the king in Aramaic letters by the side of the Greek legend. The Hellenism of Seleucia was now attacked with greater determination. For seven years (A.D. 37-43) the city maintained itself in open rebellion (*Tac. Ann.* xi. 8 seq.), till at last it surrendered to Vardanes, who in consequence enlarged Ctesiphon, which was afterwards fortified by Pacorus (A.D. 78-105; v. *Ammian.* 23, 6, 23). In the neighbourhood of the same town Vologases I. founded a city Vologasesocerta (Balashkert), to which he attempted to transplant the population to Seleucia (*Plin.* vi. 122; cf. Th. Nöldeke in *Zeitschr. d. deutsch. morgenl. Gesellschaft*, xviii., 100). Another of his foundations was Vologesias (the Arabian *Ullais*), situated near Hira on the Euphrates, south of Babylon, which did appreciate damage to the commerce of Seleucia and is often mentioned in inscriptions as the destination of the Palmyrene caravans.

After Vologases I. follows a period of great disturbances. The literary tradition, indeed, deserts us almost entirely, but the coins and isolated literary references prove that during the years A.D. 77 to 147, two kings, and sometimes three or more, were often reigning concurrently (Vologases II. 77-79, and 111-147; Pacorus 78-c. 105; Osroes 106-129; Mithradates V. 129-147; also Artabanus III. 80-81; Mithradates IV. and his

son Sanatruces II. 115; and Parthaspates 116-117). Obviously the empire can never have been at peace during these years, a fact which materially assisted the aggressive campaigns ^{Wars with} of Trajan (113-117). Trajan resuscitated the ^{Trajan and} old project of Crassus and Caesar, by which the ^{Marcus} empire of Alexander as far as India was to be won ^{Aurelius} for Western civilization. In pursuance of this plan he reduced Armenia, Mesopotamia and Babylonia to the position of imperial provinces. On his death, however, Hadrian immediately reverted to the Augustan policy and restored the conquests. Simultaneously there arose in the East the powerful Indo-Scythian empire of the Kushana, which doubtless limited still further the Parthian possessions in eastern Iran.

An era of quiet seems to have returned with Volagases III. (147-191), and we hear no more of rival kings. With the Roman Empire a profound peace had reigned since Haddian (117), which was first disturbed by the attack of Marcus Aurelius and Aelius Verus in 162. This war, which broke out on the question of Armenia and Osroene, proved of decisive significance for the future development of the East, for, in its course, Seleucia was destroyed by the Romans under Avidius Cassius (164). The downfall of the great Greek city sealed the fate of Hellenism in the countries east of the Euphrates. Henceforward Greek culture practically vanishes and gives place to Aramaic; it is significant that in future the kings of Mesene stamped their coinage with Aramaic legends. This Aramaic victory was powerfully aided by the ever-increasing progress of Christianity, which soon created, as is well known, an Aramaic literature

^{Christianity} of which the language was the dialect of Edessa, a city in which the last king of Osroene, Abgar IX. (170-214), had been converted to the faith. After that Greek culture and Greek literature were only accessible to the Orientals in an Aramaic dress. Volagases III. is probably also the king Valgash, who, according to a native tradition, preserved in the *Dinkart*, began a collection of the sacred writings of Zoroaster—the origin of the *Avesta* which has come down to us. This would show how the national Iranian element in the Parthian Empire was continually gathering strength.

The Roman war was closed in 165 by a peace which ceded north-west Mesopotamia to Rome. Similar conflicts took place in 195-202 between Volagases IV. (191-209) and Septimius Severus, and again in 216-217 between Artabanus IV. (209-226) and Caracalla. They failed, however, to affect materially the position of the two empires.

VIII. *The Sassanian Empire.*—That the Arsacid Empire should have endured some 350 years after its foundation by ^{Ardashir I.} Mithradates I. and Phraates II., was a result, not of internal strength, but of chance working in its external development. It might equally well have so existed for centuries more. But under Artabanus IV. the catastrophe came. In his days there arose in Persis—precisely as Cyrus had arisen under Astyages the Mede—a great personality. Ardashir (Artaxerxes) I., son of Papak (Babek), the descendant of Sasan, was the sovereign of one of the small states into which Persis had gradually fallen. His father Papak had taken possession of the district of Istakhr, which had replaced the old Persepolis, long a mass of ruins. Thence Ardashir I., who reigned from about A.D. 212, subdued the neighbouring potentates—disposing of his own brothers among the rest. This proceeding quickly led to war with his suzerain Artabanus IV. The conflict was protracted through several years, and the Parthians were worsted in three battles. The last of these witnessed the fall of Artabanus (A.D. 226), though a Parthian king, Artavases—perhaps a son of Artabanus IV—who is only known to us from his own coins, appears to have retained a portion of the empire for some time longer. The members of the Arsacid line who fell into the hands of the victor were put to death; a number of the princes found refuge in Armenia, where the Arsacid dynasty maintained itself till A.D. 429. The remainder of the vassal states—Carmania, Susiana, Mesene—were ended by Ardashir; and the autonomous desert fortress of Hatra in Mesopotamia was destroyed by his son Shapur

(Shapur) I., according to the Persian and Arabian traditions, which, in this point, are deserving of credence. The victorious Ardashir then took possession of the palace of Ctesiphon and assumed the title "King of the kings of the Iranians" (*Βασιλεὺς βασιλέων Ἀριανῶν*).

The new empire founded by Ardashir I.—the Sassanian, or Neo-Persian Empire—is essentially different from that of his Arsacid predecessors. It is, rather, a continuous ^{Sassanian} continuation of the Achaemenid traditions which were still ^{Wars with} alive on their native soil. Consequently the national ^{Rome} impetus—already clearly revealed in the title of the new sovereign—again becomes strikingly manifest. The Sassanian Empire, in fact, is once more a national Persian or Iranian Empire. The religious element is, of course, inseparable from the national, and Ardashir, like all the dynasts of Persia, was an ardent devotee of the Zoroastrian doctrine, and closely connected with the priesthood. In his royal style he assumed the designation "Mazdayasnan" (*Μαζδάσνας*), and the fire-cult was everywhere vigorously disseminated. Simultaneously the old claims to world dominion made their reappearance. After the defeat of Artabanus, Ardashir, as heir of the Achaemenids, formulated his pretensions to the dominion of western Asia (Dio. Cass. 80, 3; Herodian vi. 2, 4; Zonar. xii. 15; similarly under Shapur II.: Ammian. Marc. xvii. 5, 5). He attacked Armenia, though without permanent success (cf. von Gutschmid in *Zeitschr. d. d. morgenl. Ges.* xxxi. 47, on the fabulous Armenian account of these wars), and despatched his armies against Roman Mesopotamia. They strayed as far as Syria and Cappadocia. The inner decay of the Roman Empire, and the widespread tendency of its troops to mutiny and usurpation, favoured his enterprise. Nevertheless, the armies of Alexander Severus, supported by the king of Armenia, succeeded in repelling the Persians, though the Romans sustained severe losses (231-233). Towards the end of his reign Ardashir resumed the attack; while his son Shapur I. (241-272) reduced Nisibis and Carrhae and penetrated into Syria, but was defeated by ^{Shapur I.} Gordian III. at Resaena (243). Soon afterwards, however, the Roman Empire seemed to collapse utterly. The Goths defeated Decius (251) and harried the Balkan Peninsula and Asia Minor, while insurrections broke out everywhere and the legions created one Caesar after the other. Then Shapur resumed the war, subdued Armenia and plundered Antioch. The emperor Valerian, who marched to encounter him, was overthrown at Edessa and taken prisoner (260). The Persian armies advanced into Cappadocia; but here Ballista or Balista (d. c. 264) beat them back, and Odenathus (Odalnath), prince of Palmyra (q.v.), rose in their rear, defeated Shapur, captured his harem, and twice forced his way to Ctesiphon (263-265). Shapur was in no position to repair the defeat, or even to hold Armenia; so that the Sassanid power failed to pass the bounds of the Arsacid Empire. Nevertheless Shapur I., in contrast to his father, assumed the title "King of the kings of the Iranians and non-Iranians" (*Βασιλεὺς βασιλέων Ἀριανῶν καὶ Ἀραβιανῶν*; *shah an shah Iran wa Amiran*), thus emphasizing his claim to world dominion. His successors retained the designation, little as it corresponded to the facts, for the single non-Iranian land governed by the Sassanids was, as under the Parthians, the district of the Tigris and Euphrates as far as the Mesopotamian desert; western and northern Mesopotamia remained Roman.

The Sassanid ruler is the representative of the "Kingly Majesty," derived from Ormuzd, which appears in the *Avesta* as the angel Kavaem Hvareno, "the royal glory," and, according to legend, once beamed in the Iranian kings, unattainable to all but those of royal blood. A picture, which frequently recurs in the rock-reliefs of Ardashir I. and Shapur I., represents the king and the god Ormuzd both on horseback, the latter in the act of handing to his companion the ring of sovereignty. Thus it is explicable that all the Sassanids, as many of the Arsacids before them, include the designation of "god" in their formal style. From this developed (as already under the Arsacids) that strict principle of legitimacy which is still vigorous in Firdousi. It applies, however, to the whole royal house, precisely as in the Ottoman Empire of to-day. The person of the individual ruler

Organiza-
tion.

is, on the other hand, a matter of indifference. He can readily be removed and replaced by another; but no usurper who was not of the legitimate blood can hope to become the genuine king. Therefore the native tradition carries the Sasanid line back to the Achaemenids and, still further, to the kings of the legendary period.

Officially the king is all-powerful, and his will, which is guided by God and bound up in his law, unfettered. Thus, externally, he is surrounded by all the splendour of sovereignty; on his head he wears a great and resplendent crown, with a high circular centre-piece; he is clothed in gold and jewels; round him is a brilliant court, composed of his submissive servants. He sits in dazzling state on his throne in Ctesiphon. All who approach fling themselves to the ground, life and death depend on his nod. Among his people he is accounted the fairest, strongest and wisest man of the empire; and from him is required the practice of all piety and virtue, as well as skill in the chase and in arms—especially the bow. Ardashir I., moreover, and his successors endeavoured to establish the validity of the royal will by absorbing the vassal states and instituting a firmer organization. Nevertheless they failed to attain the complete independence and power of the Achaemenids. Not strong enough to break up the nobility, with its great estates, they were forced to utilize its services and still further to promote its interests; while their dependence on its good-will and assistance led inevitably to incessant gifts of money, lands and men. This state of affairs had also prevailed under the later Achaemenids, and had materially contributed to the disintegration of the empire and the numerous insurrections of the satraps. But the older Achaemenids held an entirely different position; and hardly a single Sasanid enjoyed even that degree of power which was still retained by the later Achaemenids. It was of fundamental importance that the Sasanian Empire could not make good its claim to world dominion; and, in spite of the title of its kings, it always remained essentially the kingdom of Iran—or rather west Iran, together with the districts on the Tigris and Euphrates. This fact, again, is most closely connected with its military and administrative organization. The external and internal conditions of the empire led in mutual reaction upon one another. The empire, which in extent did not exceed that of the Arsacids with its vassal states, was protected on the east and west by the great deserts of central Iran and Mesopotamia. For the defence of these provinces the mounted archers, who formed the basis of the army, possessed adequate strength; and though the Scythian nomads from the east, or the Romans from the west, might occasionally penetrate deep into the country, they never succeeded in maintaining their position. But the power of the neo-Persian Empire was not great enough for further conquests, though its army was capable and animated by a far stronger national feeling than that of the Parthians. It still consisted, however, of levies from the retinue of the magnates led by their territorial lords; and, although these troops would stream in at the beginning of a war, they could not be kept permanently together. For, on the one hand, they were actuated by the most varied personal interests and antipathies, not all of which the king could satisfy; on the other hand he could not, owing to the natural character and organization of his dominions, maintain and pay a large army for any length of time. Thus the great hosts soon melted away, and a war, begun successfully, ended ingloriously, and often disastrously. Under such circumstances an elaborate tactical organization employing different species of arms, or the execution of a comprehensive plan of campaign, was out of the question. The successes of the Sasanids in the east were gained in the later period of their dominion, and the Roman armies, in spite of decay in discipline and military spirit, still remained their tactical and strategical superiors. A great victory might be won—even an emperor might be captured, like Valerian—but immediately afterwards successes, such as those gained against Shapur I. (who was certainly an able general) by Balizha and Odenathus of Palmyra, or the later victories of Carus, Julian and others, demonstrated how far the Persians were from being on an equality with the Romans. That Babylonia permanently remained a Sasanian province was due merely to the geographical conditions and to the political situation of the Roman Empire, not to the strength of the Persians.

Military Achievements.

Among the magnates six great houses—seven, if we include the royal house—were still regarded as the foremost, precisely as under the Achaemenids, and from these were drawn the generals, crown officials and governors (cf. Procop. *Pers.* i. 6, 13 sqq.). In the last of these positions we frequently find princes of the blood, who then bear the royal title (shah). Some of these houses—whose origin the legends derive from King Gushtasp (i.e. Vishtaspa), the protector of Zoroaster (Marquart, *Zeitschr. d. d. morgenl. Ges.* xlix. 635 sqq.), already existed under the Arsacids, e.g. the Suren (Surenas, *vide supra*, p. 798) and Karen (Carenas, *Tac. Ann.* xii. 12 sqq.), who had obviously embraced the cause of the victorious dynasty at the correct moment and so retained their position. The name Pahlavan, moreover, which denoted the Parthian magnates, passed over into the new empire. Below these there was an inferior nobility, the *dikhans* ("village-lords") and the "knights" (*asuar*); who, as among the Parthians, took the field in heavy scale-armor. To an even greater extent than

The Nobility.

under the Arsacids the empire was subdivided into a host of small provinces, at the head of each being a *Marzban* ("boundary-lord," "lord of the marches"). These were again comprised in four great districts. With each of these local potentates the king could deal with as scant consideration as he pleased, always provided that he had the power or understood the art of making himself feared. But to break through the system or replace it by another was impossible. In fact he was compelled to proceed with great caution whenever he wished to elevate a favourite of humbler origin to an office which custom reserved for the nobility. Thus it is all the more worthy of recognition that the Sasanian Empire was a fairly orderly empire, with an excellent legal administration, and that the later sovereigns did their utmost to repress the encroachments of the nobility, to protect the commonalty, and, above all, to carry out a just system of taxation.

Side by side with the nobles ranked the spiritual chiefs, now a far more powerful body than under the Arsacids. Every larger district had its upper Magian (*Magupat*, *mobed*, i.e. "Lord of the Magians"). At their head was the supreme Mobed, resident in Rhagae (Rai), who was regarded as the successor of Zoroaster. In the new empire, of which the king and people were alike zealous professors of the true faith, their influence was extraordinarily strong (cf. Agathias ii. 26)—comparable to the influence of the priesthood in later Egypt, and especially in Byzantium and medieval Christendom. As has already been indicated, it was in their religious attitudes that the essential difference lay between the Sasanid Empire and the older Iranian states. But, in details, the fluctuations were so manifold that it is necessary at this point to enter more fully into the history of Persian religion (cf. especially H. Gelzer, "Eznik u. d. Entwickel. des pers. Religions-systems," in the *Zeitschr. f. armen. Philol.* i. 149 sqq.).

The Persian religion, as we have seen, spread more and more widely after the Achaemenian period. In the Indo-Scythian Empire the Persian gods were zealously worshipped; in Armenia the old national religion was almost entirely banished by the Persian cults (Gelzer, "Zur armen. Götterlehre," in *Ber. d. sächs. Gesch. d. Wissensch.*, 1895); in Cappadocia, North Syria and the west of Asia Minor, the Persian gods were everywhere adored side by side with the native deities. It was in the third century that the cult of Mithras, with its mysteries and a theology evolved from Zoroastrianism, attained the widest diffusion in all Latin-speaking provinces of the Roman dominion; and it even seemed for a while as though the *Sol invictus Mithras*, highly favoured by the Caesars, would become the official deity-in-chief of the empire. But in all these cults the Persian gods are perfectly tolerant of other native or foreign divinities; vigorous as was their propagandism, it was yet equally far removed from an attack on other creeds. Thus this Parsecism always bears a syncretic character; and the supreme god of Zoroastrian theory, Ahuramazda (i.e. Zeus or Jupiter), in practice yields place to his attendant deities, who work in the world and are able to lead the believer, who has been initiated and keeps the commandments of purity, to salvation.

But, meanwhile, in its Iranian home and especially in Persia, the religion of Zoroaster lived a quiet life, undisturbed by the proceedings of the outside world. Here the poems of the prophet and fragments of ancient religious literature survived, understood by the Magians and rendered accessible to the faithful laity by versions in the modern dialect (Pahlavi). Here the opposition between the good spirit of light and the demons of evil—between Ormuzd and Ahriman—still remained the principal dogma of the creed; while all other gods and angels, however estimable their aid, were but subordinate servants of Ormuzd, whose highest manifestation on earth was not the sun-god Mithras, but the holy fire guarded by his priests. Here all the prescriptions of purity—partly connected with national customs, and impossible of execution abroad—were diligently observed; and even the injunction not to pollute earth with corpses, but to cast out the dead to vulture and dog, was obeyed in its full force. At the same time Ahuramazda preserved his character as a national god, who bestowed on his worshippers victory and world dominion. In the sculptures of the Sasanids, as also in Armenian traditions, he appears on horseback as a war-god. Here, again, the theology was further developed, and an attempt made to annul the old dualism by envisaging both Ormuzd and Ahriman as emanations of an original principle of infinite time (Zervan), a doctrine which long enjoyed official validity under the Sasanids till, in the reign of Chosroes I., "the sect of Zervanites" was pronounced heretical! But, above all, the ritual and the doctrine of purity were elaborated and expanded, and there was evolved a complete and detailed system of casuistry, dealing with all things allowed and forbidden, the forms of pollution and the expiation for each, &c., which, in its arid and spiritless monotony vividly recalls the similar prescriptions in the Pentateuch. The consequences of this development were that orthodoxy and literal obedience to all priestly injunctions now assumed an importance far greater than previously; henceforward, the great commandment of Zoroastrianism, as of Judaism, is to combat the heresies

! It may be observed that this innovation was also known to the Mithras-cult of the West, where Zervan appears as *aiōs*.

of the heathen, a movement which had already had an energetic representative in the prophet himself. Heathenish cults and forbidden manners and customs are a pollution to the land and a deep insult to the true God. Therefore the duty of the believer is to combat and destroy the unbeliever and the heretic. In short, the tolerance of the Achaemenids and the indifference of the Arsacids are now replaced by intolerance and religious persecution.

Such were the views in which Ardashir I. grew up, and in their energetic prosecution he found a potent instrument for the building up of his empire. It has previously been mentioned that Vologases III. had already begun a collection of the holy writings; and the task was resumed under Ardashir. At his order the orthodox doctrines and texts were compiled by the high priest Jansar; all divergent theories were prohibited and their adherents proscribed. Thus arose the *Avesta*, the sacred book of the Parsees. Above all, the sacred book of laws, the *Vendidad*, breathes throughout the spirit of the Sassanian period, in its intolerance, its casuistry degenerating into absurdity, and its soulless monotony. Subscription to the restored orthodox doctrine was to the Iranian a matter of course. The schismatics Ardashir imprisoned for a year; if, at its expiration, they still refused to listen to reason, and remained stiff-necked, they were executed. It is even related that, in his zeal for uniformity of creed, Ardashir wished to extinguish the holy fires in the great cities of the empire and the Parthian vassal states, with the exception of that which burned in the residence of the dynasty. This plan he was unable to execute. In Armenia, also, Ardashir and Shapur, during the period of their occupation, sought to introduce the orthodox religion, destroyed the heathen images—even those of the Iranian gods which were here considered heathen,—and turned the shrines into fire-altars (Götzler, *Ber. z. d. Ges.*, p. 135 (1895)). Shapur I., who appears to have had a broader outlook, added to the religious writings a collection of scientific treatises on medicine, astronomy, mathematics, philosophy, zoology, &c., partly from Indian and Greek sources.

This religious development was most strongly influenced by the fact that, meanwhile, a powerful opponent of Zoroastrianism had arisen with an equally zealous propagandism and an equal exclusiveness and intolerance. More especially in the countries of the Tigris and Euphrates, now altogether Aramaic, Christianity had everywhere gained a firm footing.¹ But its missionary enterprise stretched over the whole of Iran, and even farther. The time was come when, in the western and eastern worlds alike, the religious question was for large masses of people the most important question in life, and the diffusion of their own creed and the suppression of all others the highest and holiest of tasks. The man who thinks thus knows no compromise, and so Zoroastrianism and Christianity confronted each other as mortal enemies. Still the old idea that every religion contained a portion of the truth, and that it was possible to borrow something from one and amalgamate it with another, had not yet lost all its power. From such a conception arose the teaching of Mani or Manes. For Manichaeism (*g.v.*) is an attempt to weld the doctrine of the Gospel and the doctrine of Zoroaster into a uniform system, though naturally not without an admixture of other elements, principally Babylonian and Gnostic. Mani, perhaps a Persian from Babylonia, is said to have made his first appearance as a teacher on the coronation day of Shapur I. At all events he found numerous adherents, both at court and among the magnates of the empire. The king even inclined to him, till in a great disputation the Magians gained the predominance. None the less Mani found means to diffuse his creed far and wide over the whole empire. Even the heir to the throne, Hormizd I. (reigned 272-273), was favourably disposed to him; but Shapur's younger son, Bahram I. (273-276), yielded to sacerdotal pressure, and Mani was executed. After that Manichaeism was persecuted and extirpated in Iran. Yet it maintained itself not merely in the west, where its head resided at Babylon—propagating thence far into the Roman Empire—but also in the east, in Khorasan and beyond the bounds of the Sassanian dominion. There the seat of its pontiff was at Samarkand; thence it penetrated into Central Asia, where, buried in the desert sands which entomb the cities of eastern Turkestan, numerous fragments of the works of Mani and his disciples, in the Persian language (Pahlavi) and Syrian script, and in an East Iranian dialect, called Sogdian, which was used by the Manicheans of Central Asia, have been discovered (K. Müller, "Handschriftenreste in Estrangelo-schrift aus Turfan, in *Chinesisch-Turkestan*," in *Abh. d. berl. Akad.*, 1904); among them translations of texts of the New Testament (K. Müller, *Berichte der Berl.*, 1907, p. 260 seq.). In these texts God the Father is identified with the Zervan of Zoroastrianism, the devil with Ahriman. The further religious development of the Sassanian Empire will be touched upon later.

Manichaeism.

¹ For the propagation and history of the Christians in the Sassanian Empire, cf. Labourt, *La Christianisme dans l'empire perse sous la dynastie sassanide* (1904); Harnack, *Die Mission und Ausbreitung des Christentums in den ersten drei Jahrhunderten*, 2. Aufl. (1906). Bd. II, p. 121 seq.; Chabot, *Synodicon orientale* (1902) (a collection of the acts of the Nestorian synods held under the rule of the Sassanids),

Like the Arsacids the kings resided in Ctesiphon, where, out of the vast palace built by Chosroes I., a portion at least of the great hall is still erect. On the ruins of Seleucia, on the opposite bank of the Tigris, Ardashir I. built the city *Architectura et Artia* of Veh-Ardashir ("good in Ardashir"), to which the later Sassanian kings added new towns, or rather, new quarters. In Susiana Shapur I. built the great city of Gondévar-Shapur, which succeeded the ancient capital of the Persian Empire. At the same time the mother-country again gained importance; especially the capital of Persis, Istakhr, which had replaced the former Persepolis (now the ruins of Hajji-abad). Farther in the south-east, Ardashir I. built Gur (now Firuzabad), under the name of Ardashir-khurra ("the glory of Ardashir"). At these places and in Sarwistan, near Shiraz and elsewhere, lie ruins of the Sassanian palaces, which in their design go back to the Achaemenid architecture, blending with it, however, Græco-Syrian elements and serving in their turn as models for the structures of the Caliphs (see ARCHITECTURE: § Sassanian). After its long quiescence under the Arsacids native art underwent a general renaissance, which, though not aspiring to the Achaemenid creations, was still of no small importance. Of the Sassanian rock-sculptures some have already been mentioned; besides these, numerous engraved signet-stones have been preserved. The metal-work, carpets and fabrics of this period enjoyed a high reputation; they were widely distributed and even influenced western art.

In the intellectual life and literature of the Sassanid era the main characteristic is the complete disappearance of Hellenism and the Greek language. Ardashir I. and Shapur I. still appended Greek translations to some of their inscriptions. The coins invariably bear a Pahlavi legend—on the obverse the king's head with his name and title; on the reverse, a fire-altar (generally with the inscription "fire of Ardashir, Shapur, &c.," i.e. the fire of the royal palace), and the name of the place of coinage, usually abbreviated. The real missionaries of culture in the empire were the Aramaeans (Syrians), who were connected with the West by their Christianity, and in their translations diffused Greek literature through the Orient. But there also developed a rather extensive Pahlavi literature, not limited to religious subjects, but containing works in *belles lettres*, modernizations of the old Iranian sagas and native traditions, e.g. the surviving fabulous history of Ardashir I., ethical tales, &c., with translations of foreign literature, principally Indian,—one instance being the celebrated book of tales *Kalilah and Dimnah* (see SYRIAC LITERATURE), dating from Chosroes I., in whose reign chess also was introduced from India.

AUTHORITIES.—Side by side with the accounts of Roman and Greek authors stands the indigenous tradition which, especially for the later years of the empire, is generally trustworthy. It goes back to a native work, the *Khadai nama* ("book of lords"), compiled under Chosroes I. and continued to Yazdegerd III. Its narrations are principally preserved in Tabari, though there combined with numerous Arabian traditions; also in the poetical adaptation of Firdousi. To these may be added Syrian accounts, particularly in the martyrologies, which have been excellently treated by G. Hoffmann, *Aussätze aus syrischen Akten persischer Märtyrer* (1880); also the statements of the Armenian historians.

The fundamental work on Sassanian history is Theodor Nöldeke's *Gesch. der Perser u. Araber zur Zeit der Sassaniden, aus der arabischen Chronik des Tabari* (1879, trans. with notes and excursus chiefly on the chronology and organization of the empire). On this is based Nöldeke's *Aufstiege des pers. Gesch.* (1887; containing a history of the Sassanian Empire, pp. 86 seq.). The only other works requiring mention are: G. Rawlinson, *The Seventh Great Oriental Monarchy* (1876), and F. Justi's sketch in the *Grundriss der iranischen Philologie*, vol. ii. (1904). For the geography and numerous details of administration: J. Marquart, "Eranahahr" (*Abh. d. philol. Ges. d. Wissensch.*, 1901). For the numismatology the works of A. D. Mordtmann are of prime importance, especially his articles in the *Zeitschr. d. d. morgenl. Ges.* (1879), xxxiii. 113 seq. and xxxiv. 1 seq. (1880), where the inscriptions of the individual kings are also enumerated. Also Nöldeke, *ibid.* xxxi. 147 seq. (1877). For facsimiles of coins the principal work is J. de Bartholomæi, *Collection de monnaies sassanides* (2nd ed., St. Petersburg, 1875). For the inscriptions: Edward Thomas, "Early Sassanian Inscriptions," *Journ. R. A. Soc.* vol. ii. (1868); West, "Pahlavi Literature" in the *Grundriss d. iran. Philol.* vol. ii. For the monuments: Flaudia and Coate, *Voyage en Perse* (1851); Stolze, *Persepolis* (1882); Fr. Sarre, *Iran. Felsreliefs a. d. Z. der Achaemeniden und Sassaniden* (1908).

In foreign policy the problems under the Sassanid kings²

- ² List of kings (after Nöldeke, *Tabari*, p. 435):
 Ardashir I., 226-241.
 Shapur I., 241-272.
 Hormizd I., 272-273.
 Bahram I., 273-276.
 Bahram II., 276-293.
 Bahram III., 293.
 Narseth (Narces), 293-302.
 Hormizd III., 302-310.
 Shapur II., 310-379.
 Ardashir II., 379-383.
 Shapur III., 383-385.
 Bahram IV., 388-399.
 Yazdegerd I., 399-420.
 Bahram V., Got., 420-458.
 Yazdegerd II., 458-457.
 Hormizd III., 457-459.
 Peroz, 457-484.
 Balash, 484-488.

remained as of old, the defence and, when possible, the expansion of the eastern and western frontiers. In the first two centuries of the Sassanid Empire we hear practically nothing of its relations with the East. Only occasional notices show that the inroads of the Oriental nomads had not ceased, and that the extent of the empire had by no means exceeded the bounds of the Parthian dominion—Sacestene (Seistan) and western Afghanistan. Far to the east, on both sides of the Indus, the Kushana Empire was still in existence, though it was already hastening to decay, and about A.D. 320 was displaced from its position in India by the Gupta dynasty. In the west the old conflict for Osroene and northern Mesopotamia (now Roman provinces), with the fortresses of Edessa, Carrhae and Nisibis, still smouldered. Armenia the Sassanids were all the more eager to regain, since there the Arsacid dynasty still survived and turned for protection to Rome, with whom, in consequence, new wars perpetually broke out. In the reign of Bahram II. (276-293), the emperor Carus, burning to avenge the disaster of Valerian, penetrated into Mesopotamia without meeting opposition, and reduced Coche (near Seleucia) and Ctesiphon; but his sudden death, in December of 283, precluded further success, and the Roman army returned home. Bahram, however, was unable to effect anything, as his brother Hormizd was in arms, supported by the Sacae and other tribes. (Mamertin, *Poneygyr. Maximin.* 7, 10; *Geneth. Maximin.* 5, 17.) He chose, consequently, to buy peace with Diocletian by means of presents. Some years later his uncle and successor, Narses, after subduing his rival Bahram III., occupied Armenia and defeated the emperor Galerius at Callinicum (296). But in the following year he sustained a severe reverse in Armenia, in which he lost his war-chest and harem. He then concluded a peace, by the terms of which Armenia remained under Roman suzerainty, and the steppes of northern Mesopotamia, with Singara and the hill-country on the left bank of the Tigris as far as Gordyene, were ceded to the victor (Amnian. *Marc. xxv.* 7, 9; *Petr. Patr. jr.* 13, 14; *Rufus brev.* 25). In return Narses regained his household. This peace, ratified in 297 and completely expelling the Sassanids from the disputed districts, lasted for forty years.

For the rest, practically nothing is known of the history of the first six successors of Shapur I. After the death of Hormizd II. (302-310), the son of Narses, the magnates imprisoned or put to death his adult sons, one of whom, Hormisdas, later escaped to the Romans, who used him as a pretender in their wars. Shapur II., a posthumous child of the late king, was then raised to the throne, a proof that the great magnates held the sovereignty in their own hands and attempted to order matters at their own pleasure. Shapur, however, when he came to manhood proved himself an independent and energetic ruler.

Meanwhile the Roman Empire had become Christian, the sequel of which was that the Syro-Christian population of Mesopotamia and Babylonia—even more than the Hellenic cities in former times—gravitated to the west and looked to Rome for deliverance from the infidel yoke. On similar grounds Christianity, as opposed to the Mazdaism enforced officially by the Sassanids, became predominant in Armenia. Between these two great creeds the old Armenian religion was unable to hold its own; as early as A.D. 294 King Tiridates was converted by Gregory the Illuminator and adopted the Christian faith. For this very reason the Sassanid Empire was the more constrained to champion Zoroastrianism. It was under Shapur II. that the compilation of the *Avesta* was completed and the state orthodoxy perfected by the chief *mohed*, Aturpad. All heresy was proscribed by the

Kavadh I., 488-531.
(Djamasap, 496-498).
Chosroes (Khosrau) I., Anushir-
vaa, 531-579.
Hormizd IV., 579-590.
Chosroes II., Paroes, 590-628.

(Bahram VI., Cobin, Bistam 590-596).
Kavadh II., Skeroes, 628.
Ardashir III., 628-630.
(Shahrbaraz, 630).
(Boran and others, 630-632).
Yazdegerd III., 632-651.

On most of these kings there are separate articles.

state, defection from the true faith pronounced a capital crime, and the persecution of the heterodox—particularly the Christians—began (cf. Sachall, "Die rechtlichen Verhältnisse der Christen in Sasanidenreich," in *Mitteilungen des Seminars für orientalische Sprachen für Berlin*, Bd. X., Abt. 2, 1907). Thus the duel between the two great empires now becomes simultaneously a duel between the two religions.

In such a position of affairs a fresh war with Rome was inevitable.¹ It was begun by Shapur in A.D. 337, the year that saw the death of Constantine the Great. The conflict centred round the Mesopotamian fortresses; Shapur thrice besieged Nisibis without success, but reduced several others, as Amida (359) and Singara (360), and transplanted great masses of inhabitants into Susiana. The emperor Constantius conducted the war feebly and was consistently beaten in the field. But, in spite of all, Shapur found it impossible to penetrate deeper into the Roman territory. He was hampered by the attack of nomadic tribes in the east, among whom the Chionites now begin to be mentioned. Year after year he took the field against them (353-358), till finally he compelled them to support him with auxiliaries (Ammian. *Marc.* 14, 3; 16, 9; 17, 5; 18, 4, 6). With this war is evidently connected the foundation of the great town New-Shapur (Nishapur) in Khorasan.

By the resolution of Julian (363) to begin an energetic attack on the Persian Empire, the conflict, after the lapse of a quarter of a century, assumed a new phase. Julian pressed forward to Ctesiphon but succumbed to a wound; and his successor Jovian soon found himself in such straits, that he could only extricate himself and his army by a disgraceful peace at the close of 363, which ceded the possessions on the Tigris and the great fortress of Nisibis, and pledged Rome to abandon Armenia and her Arsacid protégé, Arsaces III., to the Persians.

Shapur endeavoured to occupy Armenia and introduce the Zoroastrian orthodoxy. He captured Arsaces III. by treachery and compelled him to commit suicide; but the Armenian magnates proved refractory, placed Arsaces' son Pap on the throne, and found secret support among the Romans. This all but led to a new war; but in 374 Valens sacrificed Pap and had him killed in Tarsus. The subsequent invasions of the Goths, in battle with whom Valens fell at Adrianople (375), definitely precluded Roman intervention; and the end of the Armenian troubles was that (c. 390) Bahram IV. and Theodosius the Great concluded a treaty which abandoned the extreme west of Armenia to the Romans and confirmed the remainder in the Persian possession. Thus peace and friendship could at last exist with Rome; and in 408 Yazdegerd I. contracted an alliance with Theodosius II. In Armenia the Persians immediately removed the last kings of the house of Arsaces (430), and thenceforward the main portion of the country remained a Persian province under the control of a *marzban*, though the Armenian nobles still made repeated attempts at insurrection. The introduction of Zoroastrianism was abandoned; Christianity was already far too deeply rooted. But the sequel to the Roman sacrifice of Armenian interests was that the Armenian Christians now seceded from the orthodoxy of Rome and Constantinople, and organized themselves into an independent national church. This church was due, before all, to the efforts of the Catholicos Sahak (390-439), whose colleague Mesrob, by his translation of the Bible, laid the foundations of an Armenian literature (see ARMENIAN CHURCH).

In the interior of the Sassanid Empire the old troubles broke out anew on the death of Shapur II. (379). At first the magnates raised his aged brother Ardashir II. to the throne, then in 383 deposed him and enthroned Shapur's son as Shapur III. In 388, however, he was assassinated, Yazdegerd I. as was also his brother, Bahram IV., in 399. But the son of the latter, Yazdegerd II. (399-420), was an energetic and intelligent sovereign, who held the magnates within bounds and severely chastised their attempts at encroachment. He even sought to emancipate himself from the Magian Church,

¹ For the succeeding events see also under **ROME: Ancient History**; and articles on the Roman emperors and Persian kings.

Conquest of Armenia.

put an end to the persecutions, and allowed the Persian Christians an individual organization. In the Persian tradition he is consequently known as "the sinner." In the end he was probably assassinated. So great was the bitterness against him that the magmats would admit none of his sons to the throne. One of them, however, Bahram V., found an auxiliary in the Arab chief Mondhir, who had founded a principality in Hira, west of the lower Euphrates; and, as he pledged himself to govern otherwise than his father, he received general recognition. This pledge he redeemed, and he is, in consequence, the darling of Persian tradition, which bestows on him the title of *Gor* ("the wild ass"), and is eloquent on his adventures in the chase and in love. This reversal of policy led to a Christian persecution and a new war with Rome. Bahram, however, was worsted; and in the peace of 422 Persia agreed to allow the Christians free exercise of their religion in the empire, while the same privilege was accorded to Zoroastrianism by Rome. Under his son, Yazdegerd II. (438-457), who once more revived the persecutions of the Christians and the Jews, a short conflict with Rome again ensued (441): while at the same time war prevailed in the east against the remnants of the Kushan Empire and the tribe of Kidarites, also named Huns.

Here a new foe soon arose in the shape of the Ephthalites (*Haitab*), also known as the "White Huns," a barbaric tribe which shortly after A.D. 450 raided Bactria and terminated the Kushana dominion (Procop. *Pers.* i. 3). These Ephthalite attacks harassed and weakened the Sassanids, exactly as the Tocharians had harassed and weakened the Arsacids after Phraates II. Peroz (457-484) fell in battle against them; his treasures and family were captured and the country devastated far and near. His brother Balash (484-488), being unable to repel them, was deposed and blinded, and the crown was bestowed on Kavadh I. (488-531), the son of Peroz. As the external and internal distress still continued he was dethroned and imprisoned, but took refuge among the Ephthalites and was restored in 499 by their assistance—like so many Arsacids by the arms of the Dahae and Sacae. To these struggles obviously must be attributed mainly the fact that in the whole of this period no Roman war broke out. But, at the same time, the religious duel had lost in intensity, since, among the Persian Christians, the Nestorian doctrine was now dominant. Peroz had already favoured the diffusion of Nestorianism, and in 483 it was officially adopted by a synod, after which it remained the Christian Church of the Persian Empire, its head being the patriarch of Seleucia—Ctesiphon.

Kavadh proved himself a vigorous ruler. On his return he restored order in the interior. In 502 he attacked the Romans and captured and destroyed Amida (mod. Diarbekr), but was compelled to ratify a peace owing to an inroad of the Huns. Toward the close of his reign (527) he resumed the war, defeating Belisarius at Callinicum (531), with the zealous support of the wild Arab Mondhir II. of Hira. On his death his son Chosroes I. concluded a peace with Justinian (532), pledging the Romans to an annual subsidy for the maintenance of the Caucasus fortresses. In his home policy Kavadh is reminiscent of Yazdegerd I. Like him he had little inclination to the orthodox church, and favoured Mazdak, the founder of a communistic sect which had made headway among the people and might be used as a weapon against the nobles, of whom Mazdak demanded that they should cut down their luxury and distribute their superfluous wealth. Another feature of his programme was the community of wives. The crown-prince, Chosroes, was, on the other hand, wholly orthodox; and, towards the close of his father's reign, in conjunction with the chief Magian, he carried through a sacrifice of the Mazdakites, who were butchered in a great massacre (528). Chosroes I. (531-579), surnamed Anushirvan ("the blessed"), then restored the orthodox doctrine in Persia, full, publishing his decision in a religious edict.

At the same time he produced the official exposition of the *Avesta*, an exegetical translation in the popular tongue

(Pahlavi), and declared its contents binding. Defection from Zoroastrianism was punished with death, and therefore also the proselytizing of the Christians, though the Syrian martyr-ologies prove that the kings frequently ignored these proceedings so long as it was at all possible to do so.

Chosroes I. was one of the most illustrious sovereigns of the Sassanian Empire. From him dates a new and equitable adjustment of the imperial taxation, which was later adopted by the Arabs. His reputation as an enlightened ruler stood so high that when Justinian, in 529, closed the school of Athens, the last Neoplatonists bent their steps to him in hopes of finding in him the true philosopher-king. Their disillusionment, indeed, was speedy and complete, and their gratitude was great, when, by the conditions of the armistice of 549, he allowed their return. From 540 onward he conducted a great war against Justinian (527-565), which, though interrupted by several armistices, lasted till the fifty years' peace of 562. The net result, indeed, was merely to restore the *status quo*; but during the campaign Chosroes sacked Antioch and transplanted the population to a new quarter of Ctesiphon (540). He also extended his power to the Black Sea and the Caucasus; on the other hand, a siege of Edessa failed (544). A second war broke out in 577, chiefly on the question of Armenia and the Caucasus territory. In this Chosroes ravaged Cappadocia in 575; but the campaign in Mesopotamia was unsuccessful. In the interval between these two struggles (570) he despatched assistance to the Arabs of Yemen, who had been assailed and subdued by the Abyssinian Christians; after which period Yemen remained nominally under Persian suzerainty till its fate was sealed by the conquest of Mahomet and Islam.

Meanwhile, about A.D. 560, a new nation had sprung up in the East, the Turks. Chosroes concluded an alliance with them against the Ephthalites, and so conquered Bactria south of the Oxus, with its capital Balkh. Thus this province, which, since the insurrection of Diodotus in 250 B.C., had undergone entirely different vicissitudes from the rest of Iran, was once more united to an Iranian Empire, and the Sassanid dominions, for the first time, passed the frontiers of the Arsacids. This, however, was the limit of their expansion. Neither the territories north of the Oxus, nor eastern Afghanistan and the Indus provinces, were ever subject to them. That the alliance with the Turks should soon change to hostility and mutual attack was inevitable from the nature of the case; in the second Roman war the Turkish Khan was leagued with Rome.

Chosroes bequeathed this war to his son Hormizd IV. (579-590), who, in spite of repeated negotiations, failed to re-establish peace. Hormizd had not the ability to retain the authority of his father, and he further affronted the Magian priesthood by declining to proceed against the Christians and by requiring that, in his empire, both religions should dwell together in peace. Eventually he succumbed to a conspiracy of his magnates, at whose head stood the general Bahram Cobin, who had defeated the Turks, but afterwards was beaten by the Romans. Hormizd's son, Chosroes II., was set up against his father and forced to acquiesce in his execution. But immediately new risings broke out, in which Bahram Cobin—though not of the royal line—attempted to secure the crown, while simultaneously a Prince Bistam entered the lists. Chosroes fled to the Romans and the emperor Maurice undertook his restoration at the head of a great army. The people flocked to his standard; Bahram Cobin was routed (591) and fled to the Turks, who slew him, and Chosroes once more ascended the throne of Ctesiphon; Bistam held out in Media till 596. Maurice made no attempt to turn the opportunity to Roman advantage, and in the peace then concluded he even abandoned Nisibis to the Persians.

Chosroes II. (590-628) is distinguished by the surname of *Parvez* ("the conqueror"), though, in point of fact, he was immeasurably inferior to a powerful sovereign like his grandfather, or even to a competent general. He lived, however, to witness unparalleled vicissitudes of fortune. The assassination

First Appearance of the Turks, Sassanid Conquest of Bactria.

Chosroes II.

of Maurice in 602 impelled him to a war of revenge against Rome, in the course of which his armies—in 608 and, again, in 615 and 626—penetrated as far as Chalcedon opposite Constantinople, ravaged Syria, reduced Antioch (611), Damascus (613), and Jerusalem (614), and carried off the holy cross to Ctesiphon; in 619 Egypt was occupied. Meanwhile, the Roman Empire was at the lowest ebb. The great emperor Heraclius, who assumed the crown in 610, took years to create the nucleus of a new military power. This done, however, he took the field in 623, and repaid the Persians with interest. Their armies were everywhere defeated. In 624 he penetrated into Atropatene (Azerbaijan), and there destroyed the great fire-temple; in 627 he advanced into the Tigris provinces. Chosroes attempted no resistance, but fled from his residence at Dastagerd to Ctesiphon. These proceedings, in conjunction with the avarice and licence of the king, led to revolution. Chosroes was deposed and slain by his son Kavadh II. (628); but the parricide died in a few months and absolute chaos resulted. A whole list of kings and pretenders—among them the General Shahbaraz and Boran, a daughter of Chosroes—followed rapidly on one another, till finally the magnates united and, in 632, elevated a child to the throne, Yazdegerd III., grandson of Chosroes. In the interval—presumably during the reign of Queen Boran—peace was concluded with Heraclius, the old frontier being apparently restored. The cross had already been given back to the emperor.

Thus the hundred years' struggle between Rome and Persia, which had begun in 527 with the attack of the first Kavadh on Justinian, had run its fruitless course, utterly enfeebling both empires and consuming their powers.

So it was that room was given to a new enemy who now arose between either state and either religion—the Arabs and Islam. In the same year that saw the coronation of Yazdegerd III.—the beginning of 633—the first Arab squadrons made their entry into Persian territory. After several encounters there ensued (637) the battle of Kadisiya (Qadisiya, Cadesia), fought on one of the Euphrates canals, where the fate of the Sassanian Empire was decided. A little previously, in the August of 636, Syria had fallen in a battle on the Yarmuk (Hieromax), and in 639 the Arabs penetrated into Egypt. The field of Kadisiya laid Ctesiphon, with all its treasures, at the mercy of the victor. The king fled to Media, where his generals attempted to organize the resistance; but the battle of Nehavend (? 641) decided matters there. Yazdegerd sought refuge in one province after the other, till, at last, in 651, he was assassinated in Merv (see CALIPHATE: § A, § 1).

Thus ended the empire of the Sassanids, no less precipitately and ingloriously than that of the Achaemenids. By 650 the Arabs had occupied every province to Balkh and the Oxus. Only in the secluded districts of northern Media (Tabaristan), the "generals" of the house of Karen (Spahpat, Ispehbed) maintained themselves for a century as vassals of the caliphs—exactly as Atropates and his dynasty had done before them.

The fall of the empire sealed the fate of its religion. The Moslems officially tolerated the Zoroastrian creed, though occasional persecutions were not lacking. But little by little it vanished from Iran, with the exception of a few remnants (chiefly in the oasis of Yazd), the faithful finding a refuge in India at Bombay. These Parsees have preserved but a small part of the sacred writings; but to-day they still number their years by the era which begins on the 16th of June A.D. 632, with the accession of Yazdegerd III., the last king of their faith and the last lawful sovereign of Iran, on whom rested the god-given Royal Glory of Ormuzd.

AUTHORITIES.—Besides the works on special periods quoted above, the following general works should be consulted: Spiegel, *Iranische Altertumskunde* (3 vols., 1876 sqq.); W. Geiger and Ernst Kuhn, *Grundriss der iranischen Philologie herausg.*, vol. ii. (Literature, History and Civilization, 1896 sqq.); G. Rawlinson, *The Five Great Monarchies, The Sixth Monarchy, The Seventh Monarchy*. Further the mutually supplementary work of Th. Nöldeke, *Aufsätze zur persischen Geschichte* (1887, Medes, Persians and Sassanids), and A. v. Gutschmid, *Geschichte Irans von Alexander d. Gr. bis zum Uebergang der Arsaciden* (1883). A valuable work of reference is F. Justi, *Iranisches Namenbuch* (1895).

The most important works on the monuments are: Flandin et Coste, *Voyage en Perse* (6 vols., 1840 sqq.); Texier, *L'Arménie, la Perse, et la Mésopotamie* (2 vols., 1842); Stolze, *Persepolis* (2 vols., 1882); Sarre, *Iranische Felsreliefs* (1908).

For works on the external history of Persia see those quoted under articles on Persian kings; also ROMÉ; GRÆCÆ; EGYPT; SYRIA; &c. (Ed. M.)

B.—Transition Period: from the Fall of the Sassanid Dynasty to the Death of Timur (1405).

With the final defeat of the Sassanids under Yazdegerd III. at the battles of Kadisiya (Kadessia) (637) and Nehavend (642) Persia ceased to exist as a single political unit. The country passed under a succession of alien rulers Allied Rulers. who cared nothing for its ancient institutions or its religion. For about 150 years it was governed, first from Medina and afterwards from Bagdad, by officers of the Mahomedan caliphs whose principal aim it was to destroy the old nationality by the suppression of its religion. The success of this policy was, however, only apparent, especially in Iran, the inhabitants of which adopted Islam only in the most superficial manner, and it was from Persia that the blow fell which destroyed the Omayyad caliphate and set up the Abbasids in its place (see CALIPHATE). Even before this event adventurers and dissatisfied Moslem officers had utilized the slumbering hostility of the Persian peoples to aid them in attacks on the caliphs (e.g. Ziyad, son of Abu Sofan, in the reign of Moawiya I.), and the policy of eastern expansion brought the Arab armies perpetually into the Persian provinces.

In the reign of Merwan I. the Persians (who were mostly Shi'ites) under a Moslem officer named Mokhtar (Mukhtar), whom they regarded as their mahdi, vainly attempted to assert their independence in Kufa, but were soon defeated. This rising was followed by many more (see CALIPHATE: § B) in which the caliphs were generally successful, and Abdalmalik (d. 705) considerably strengthened the Moslem power by instituting a thorough system of Moslem coins and enforcing Arabic as the official language throughout the empire. In the succeeding reign Persia was further subdued by the great conqueror Qoteiba (Qotaiba) b. Moslim, the Arabic governor of Khorasan. Omar II., however, extended to non-Arabic Moslems immunity from all taxes except the *sakat* (poor-rate), with the result that a large number of Persians, who still smarted under their defeat under Mokhtar, embraced Islam and drifted into the towns to form a nucleus of sedition under the Shi'ite preachers. In the reign of Yazid II. (720-724) serious risings took place in Khorasan, and in spite of the wise administration of his successor Hisham (d. 743), the disorder continued to spread, fanned by the Abbasids and the Shi'ite preachers. Ultimately in the reign of Merwan II. the non-Arabic Moslems found a leader in Abu Moslim, a *mawla* (client) of Persian origin and a henchman of Ibrahim b. Mahommed b. Ali, the Shi'ite imam, who raised a great army, drove the caliph's general Nasr b. Sayyar into headlong flight, and finally expelled Merwan. Thus the Abbasids became masters of Persia and also of the Arab Empire. They had gained their success largely by the aid of the Persians, who began thenceforward to recover their lost sense of nationality; according to the Spanish author Ibn Hazm the Abbasids were a Persian dynasty which destroyed the old tribal system of the Arabs and ruled despotically as Chosroes had done. At the same time the Khorasanians had fought for the old Alid family, not for the Abbasids, and with the murder of Abu Moslim discontent again began to grow among the Shi'ites (q.v.). In the reign of Harun al-Rashid disturbances broke out in Khorasan which were temporarily appeased by a visit from Harun himself. Immediately afterwards Rafi' b. Laith, grandson of the Omayyad general Nasr b. Sayyar, revolted in Samarkand, and Harun on his way to attack him died at Tus (809). Harun's sons Amin and Mamun quarrelled over the succession; Amin became caliph, but Mamun by the aid of Tahir b. Hosain Dhul-Yaminain ("the man with two right hands") and others succeeded in deposing and killing him. Tahir ultimately (830) received the governorship of Khorasan, where he succeeded in establishing

a practically independent Moslem dynasty (the Tahirids)¹ which ruled until about 873 in nominal obedience to Bagdad. From 825 to about 898 a similar dynasty, the Dulafids² or Dolafids reigned nominally as governors under the caliphs till they were put down by Motamid. In the reign of the caliph Motasim a serious revolt of Persian Mazdakite sectaries (the Khorrami) in alliance with Byzantium was with difficulty suppressed, as also a rising of Tabaristan under an hereditary chief Maziyar who was secretly supported by the Turkish mercenaries (e.g., Afshin) whom the caliph had invited to his court. To another Turk, Itakh, the caliph Wathiq gave a titular authority over all the eastern provinces. In the reign of the tenth caliph Motawakkil the Tahirids fell before Yakub b. Laith al-Saffar, who with the approbation of the caliph founded a dynasty, the Saffarid (q.v.), in Seistan.

It is convenient at this point to mention several other minor dynasties founded by nominal governors in various parts of Persia and its borderland. From 879 to about 930 the Sajids ruled in Azerbaijan, while in Tabaristan an Alid dynasty (the Zaidites) was independent from 864 to 928, when it fell before the Samanids. Subsequently descendants of this house ruled in Dailam and Gilan. Throughout this period the caliphate was falling completely under the power of the Turkish officers. Mohtadi, the fourteenth Abbasid caliph, endeavoured vainly to replace them by Persians (the Abna). His successor Motamid was attacked by the Saffarid Yakub who however was compelled to flee (see CALIPHATE: § C, § 15). Yakub's brother Amr (reigned 878-900) received the vacant position, but was taken prisoner by Isma'il b. Ahmad, the Samanid, and the Saffarids were henceforward a merely nominal dynasty under the Samanids (900-1220). The Samanids (q.v.) were the first really important non-Arabic Persian dynasty since the fall of Yazdegerd III. They held sway over most of Persia and Transoxiana, and under their rule scholarship and the arts flourished exceedingly in spite of numerous civil wars. Ultimately they fell before the Ghaznevid dynasty of Sabuktigin.

In the reign of Motamid (CALIPHATE: § C, § 16) who, as we have seen, put down the Dolafids, and also checked the Sajids of Azerbaijan in their designs on Syria and Egypt, the Kharijites of Mesopotamia were put down by the aid of the Hamdanites of Mosul, who were to become an important dynasty (see below). Subsequently the caliphate, which had temporarily recovered some of its authority, resumed its downward course, and the great families of Persia once again asserted themselves. In the reign of Qahir (d. 934), a new dynasty arose in Persia, that of the Buyids (Buwayhids). This family was descended from one Abu Shaja Buya, who claimed to be of the old Sassanian house and had become a chieftain in Dailam. He had successively fought for the Samanids and the Ziyarids,³ a dynasty of Jorjan, and his son Imad addaula (ed-dowleh, originally Abu 'l Hasan Ali) received from Mardawij of the latter house the governorship of Karaj; his second son Rukn addaula (Abu Ali Hasan) subsequently held Rai and Isfahan, while the third, Moizz addaula (Abu 'l Hosain Ahmad) secured Kerman, Ahvaz and even Bagdad.

The reign of the caliph Mottaqi (CALIPHATE: § C, § 21) was a period of perpetual strife between the Dailamites, the Turks and the Hamdanid Nasir addaula of Mosul. In the next reign Moizz addaula took Bagdad (945) and was recognized by the caliph Mostakfi as sultan⁴ and amir al-Omra. It was at this

time that the three brothers took the titles Imad, Rukn (Rokn), and Moizz addaula. The authority of the family was absolute, though they paid outward respect to the caliphs. Moizz addaula repelled an attack of the Hamdanids of Mosul. The Buyids, and especially Adod addaula (Azud-ed-Dowleh, and similar forms), ruled Bagdad wisely and improved the city by great public works such as the great dike, still known as the Bend Amir on the Kur (Cyrus) near Persepolis. Their sway extended from the Persian Gulf to the Caspian Sea (CALIPHATE: § C, § 24). Ultimately, however, the Buyid dynasty grew weaker under the quarrels of its members and fell an easy prey to the Ghaznevids. In the meantime (999) the Samanids fell before the Ilk-Khans of Turkestan, to the great advantage of the Ghaznevid princes.

¹ Tahir died 822 or 824; Talha d. 828; Abdallah, 828-844; Tahir II., 844-862; Mahommed, 862-873.
² Abu Dolaf Qasim b. Idris-Ijhi (825); 'Abdalfazil (842); Dolaf (873); Ahmad (878); Omar 893-998.

³ The Ziyarid dynasty was founded by Mardawij b. Ziyar (928-935). His successors were Zahir addaula (ud-daula, ed-dowleh) Abu Mansur Washmagir (935-967), Bistun (967-976), Shams al Ma'ali Qabus (976-1012), Falak al Ma'ali Manushahr (1012-1029), Anushirwan (1029-1042). They were Alyite in religion. They were of progressively less importance under the Samanids, and were ultimately expelled by the Ghaznevids.

⁴ This is denied by S. Lane Poole, who points out that they did not use the title on their coins.

For these and other minor dynasties such as the Hasanwayhids of Kurdistan (c. 959-1015) and the Kakwayhids of Kurdistan (1007-1051), see Stockvis, *Manuel d'histoire*, I. 113 sqq. (Leyden, 1888).

The centre of force in Persian politics now changes from west to east. Hitherto the ultimate power, at least nominally, had resided in the caliphate at Bagdad, and all the dynasties which have been noticed derived their authority formally from that source. With the rise of the Ghaznevids and later Ghaznevids, the Seljuks, the Abbasid caliphate ceased to count as an independent power. As we have seen, the Ghaznevid armies in a brief space destroyed most of the native dynasties of Persia. The first of the house was Alptagin, a Turkish slave of the Samanid Mansur I., who, having quarrelled with his master, took refuge in Afghanistan and founded a semi-independent authority. After his death three unimportant governors of his house held sway, but in 977 the power fell to another former slave, Sabuktigin, who was recognized by the Samanid Nuh II. His son and successor Mahmud (q.v.) was attacked by a brother, Isma'il, and retired from Khorasan (of which he had been governor). The Samanids then fell under the power of the Tatar Ilkhans, but Mahmud returned, triumphed over both the Samanids and the Tatars, and assumed the independent title of sultan with authority over Khorasan, Transoxiana and parts of north-west India. Mahmud was a great conqueror, and wherever he went he replaced the existing religion by Mahommedanism. He is described as the patron (if a somewhat ungenerous one) of literature; it was under his auspices that Firdousi collected the ancient myths of Persia and produced the great epic *Shahnama* (Book of the Kings). His descendants held a nominal rule till 1187, but in 1152 they lost all their extra-Indian territories to the Ghorids, and during the last thirty-five years reigned in diminished splendour at Lahore. Even before this time, however, the supremacy which they enjoyed under Mahmud in Persia had fallen into the hands of the Seljuks who, in the reign of Mas'ud I., son of Mahmud, conquered Khorasan. In 1037 Seljuk princes were recognized in Merv and Nishapur, and in the ensuing eighteen years the Seljuks conquered Balkh, Jorjan, Tabaristan, Khwarizm, Hamadan, Rai, Isfahan, and finally Bagdad (1055). The Abbasid caliphs, who still enjoyed a precarious and shadowy authority at the pleasure of Turkish viziers, gladly surrendered themselves to the protection of the Mahommedan Seljuks, who paid them all outward respect.

Thus for the first time since the Arab conquest of the Sassanian realm Persia was ruled by a single authority, which extended its conquests westward into Asia Minor, where it checked the rulers of Byzantium, and eastward to India and Central Asia. The history of this period is treated at length in the articles CALIPHATE: § C, §§ 26 sqq.; and SELJUKS. A bare outline only is required here.

The first three Seljuk rulers were Toghrul Beg, Alp Arslan and Malik Shah. On the death of the last the empire was distracted by civil war between his sons Barkiyarok, Mahommed and Sinjar, with the result that, although the Seljuks of the direct line maintained nominal supremacy till the death of Sinjar (1157), other branches of the family established themselves in various parts of the empire—Syria, Rum (Asia Minor),

Kermān, and Irak with Kurdistan. Sinjar himself lost all his dominions except Khorasan in wars with the Karakitai. The sultans of Kermān were rarely independent in the full sense, but they enjoyed comparative peace and prosperity till the death of Toghrul Shah (1170), after which their power fell before the Ghuzz tribes; Kermān was finally captured in 1195 by the Khwarizm shahs. Meanwhile an independent dynasty was formed about 1136 in Azerbaijan by the governors (atabegs) appointed by the Seljuks; this dynasty was overthrown by the Khwarizm shahs in 1225. Similar dynasties existed in Laristan and Fars.

The empire of the Seljuks was essentially military. Their authority over their own officers was so precarious that they preferred to entrust the command to Turkish slaves. These officers, however, were far from loyal to their lords. In every part of the empire they gradually superseded the Seljuk princes, and the minor dynasties above mentioned all owed their existence to the ambition of the Turkish regents or atabegs. The last important dynasty in Persia prior to the Mongol invasion was that of the Salgharids in Fars, founded by the descendants of a Turkish general Salghar, who had formerly been a Turkoman leader and ultimately became chamberlain to Toghrul Beg. The first ruler was Sonkor b. Modud, who made himself independent in Fars in 1148. The fourth, Sa'd, became tributary to the Khwarizm shahs in 1195, and the fifth acknowledged allegiance to the Mongol Ogotai and received the title Kutbegh Khan. His successors were vassals of the Mongols, and the last, the Princess 'Abish (d. 1287), was the wife of Hulagu's son Mangu Timur.

Before passing on to the Mongol conquerors of Persia it is necessary briefly to notice the shahs of Khwarizm, who were frequently mentioned as overthrowing the minor dynasties which arose with the decay of the Seljuks. These rulers were descended from Anushtajin, a Turkish slave of Ghazni, who became cupbearer to the Seljuk Malik Shah, and afterwards governor of Khwarizm (Khiva) in 1077. In 1138 the third of the line, Atsiz, revolted but was defeated and expelled by Sinjar. Shortly afterwards he returned, firmly established his power, and extended the Khwarizm Empire as far as Jand on the Sihun. The brief reigns of Il-Arslan and Sultan Shah Mahmud were succeeded by that of Tukush (1177-1199) and Ala ed-din Mohammed¹ (1199-1220). The former of these subdued Khorasan, Rai and Isfahan, while the latter brought practically all Persia under his sway, conquered Bokhara, Samarkand and Otrar, capital of the Karakitai, and had even made himself master of Ghazni when his career was stopped by the hordes of the Mongol Jenghiz Khan. In 1231 the last of his house, Jelal ud-din (Jalaluddin) Mangbarti, or Mango-berti, was banished, and thus the empire of the Khwarizm shahs, which for a brief period had included practically all the lands conquered by the Seljuks, passed away.

Thus from the fall of the Samanids to the invasion of the Mongols five or at most six important dynasties held sway over Persia, while some forty small dynasties enjoyed a measure of local autonomy. During the whole of this period the Abbasid caliphs had been nominally reigning throughout the Mohammedan world with their capital at Bagdad. But with hardly any exceptions they had been the merest puppets, now in the hands of Turkish ministers, now under the protection of practically independent dynasts. The real rulers of Persia during the years 874-1231 were, as we have seen, the Samanids, the Buyids, the Ghaznevids, the Seljuks, the Salgharids and the Khwarizm shahs. We now come to a new period in Persian history, when the numerous petty dynasties which succeeded the Seljuks were all swallowed up in the great Mongol invasion.

In the later years of the 12th century the Mongols began their westward march and, after the conquest of the ancient kingdom of the Karakitai, reached the borders of the territory of the Khwarizm shahs, which was at once overwhelmed. Jenghiz Khan died in 1227, and the Mongol

¹ It was this prince who destroyed the Ghori dynasty, which claimed descent from the legendary Persian monarch Zohak. Except for a brief period of submission to the Ghaznevids (1009-1099) they ruled at Ghor until 1215, when they were conquered after a fierce struggle.

Empire stretching from the Caspian to the Yellow Sea was divided up among his sons. Persia itself fell partly in the domain of Jagatai and partly in that of the Golden Horde. The actual governor of Persia was Tului or Tule, whose son Hulagu or Hulaku is the first who can be rightly regarded as the sovereign of Persia. His accession occurred in 1256, and henceforward Persia becomes after 600 years of spasmodic government a national unit. Hulagu at once proceeded to destroy a number of nascent dynasties which endeavoured to establish themselves on the ruins of the Khwarizm Empire; about 1255 he destroyed the dynasty of the Assassins² by the capture of their stronghold of Alamut (Eagle's Nest), and finally in 1258 captured Bagdad. The thirty-eighth and last Abbasid caliph, Mostasim, was brutally murdered, and thus the Mohammedan caliphate ceased to exist even as an emasculated pontificate. The Persian Empire under Hulagu and his descendants extended from the dominions of Jagatai on the north to that of the Egyptian dynasts on the south, and from the Byzantine Empire on the west to the confines of China. Its rulers paid a nominal homag to the Khakhan (Great Khan) in China, and officially recognized this dependence in their title of Ilkhan, i.e. provincial or dependent khan. From 1258 to 1335 the Ilkhans were not seriously challenged. Hulagu fixed his capital at Maragha (Meragha) in Azerbaijan, where he erected an observatory for Nasir ud-din Tusi, who at his request prepared the astronomical tables known as the *Zij-i-Ilkhani*. He died in 1265 and was succeeded by his son Abagha or Abaka, who married the daughter of Michael Palaeologus, the Byzantine ruler. Abagha was a peaceful ruler and endeavoured by wise administration to give order and prosperity to a country torn asunder by a long period of intestine war and the Mongol invasion. He succeeded in repelling two attacks by other Mongolian princes of the house of Jenghiz Khan; otherwise his reign was uneventful. His brother Nikudar (originally Nicolas) Ahmad Khan succeeded him in 1281. This prince was converted to Islam, an event of great moment both to the internal peace and to the external relations of Persia. His persecution of the Christians led them into alliance with the Mongols, who detested Islam; the combined forces were too strong for Nikudar, who was murdered in 1284. The external results were of more importance. The Ilkhans, who had failed in their attempt to wrest Syria from the Mameluke rulers of Egypt, had subsequently endeavoured to effect their object by inducing the European Powers to make a new crusade. The conversion of Nikudar put an end to this policy and Egypt was for some time free from Persian attack (see *EGYPT: History*). The Mongol leaders put on the throne a son of Abagha, by name Arghun. His reign was troubled. His first minister Shams ud-din was suspected of having poisoned Abagha, and was soon put to death. His successor, the amir Bogha, conspired against Arghun and was executed. Under the third minister (1289-1291), a Jewish doctor named Sa'd addaula (ed-Dowleh), religious troubles arose owing to his persecution of the Mohammedans and his favouring the Christians. The financial administration of Sa'd was prudent and successful, if somewhat severe, and the revenue benefited considerably under his care. But he committed the tactical error of appointing a disproportionate number of Jews and Christians as revenue officials, and thus made many enemies among the Mongol nobles, who had him assassinated in 1291 when Arghun was lying fatally ill. It is possible that it was Sa'd's diplomacy which led Pope Nicholas IV. to send a mission to Arghun with a view to a new crusade. The reign of Arghun was also disturbed by a rebellion of a grandson of Hulagu, Baidu Khan. Arghun died soon after the murder of Sa'd, and was succeeded by his brother Kaikhatu, or Gaykhatu, who was taken prisoner by Baidu Khan and killed (1295). Baidu's reign was cut short in the same year by Arghun's son Ghazan Mahmud, whose reign (1295-1304) was a period of prosperity in war and administration. Ghazan

² The dynasty of the Assassins or Isma'ilites was founded in 1090 and extended its rule over much of western Persia and Syria (for the rulers see Stockvis, *op. cit.* l. 131, and article ASSASSINS).

was a man of great ability. He established a permanent staff to deal with legal, financial and military affairs, put on a firm basis the monetary system and the system of weights and measures, and perfected the mounted postal service. Ghazan fought with success against Egypt (which country had already from 1293 to December 1294 been ruled by a Mongol usurper Kitboga), and even held Damascus for a few months. In 1303, however, his troops were defeated at Merj al-Safar, and Mongol claims on Syria were definitely abandoned. It was even suggested that the titular Abbasid caliphs (who retained an empty title in Cairo under Mameluke protection) should be reinstated at Bagdad, but this proposal was not carried into effect. Ghazan is historically important, however, mainly as the first Mongol ruler who definitely adopted Islam with a large number of his subjects. He died in 1304, traditionally of anger at the Syrian fiasco, and was succeeded by his brother Uljaitu (Oeljeitu). The chief events of his reign were a successful war against Tatar invaders and the substitution of the new city of Suktania as capital for Tabriz, which had been Ghazan's headquarters. Uljaitu was a Shi'ite and even stamped his coins with the names of the twelve Shi'ite imams. He died in 1316, and was succeeded by Abu Sa'id, his son. The prince, under whom a definite peace was made with Malik al-Nasir, the Mameluke ruler of Egypt, had great trouble with powerful viziers and generals which he accentuated by his passion for Bagdad-Khatun, wife of the amir Hosain and daughter of the amir Chupan. This lady he eventually married, with the result that Chupan headed a revolt of his tribe, the Selduz. Abu Sa'id died of fever in 1335, and with him the first Mongol or Ilkhan dynasty of Persia practically came to an end. The real power was divided between Chupan and Hosain the Jelair (or Jalair), or the Ilkhanian, and their sons, known respectively as the Little Hasan (Hasan Kuchuk) and the great Hasan (Hasan Buzurg). Two puppet kings, Arpa Khan, a descendant of Hulagu's brother Arikbuhga, and Musa Khan, a descendant of Baidu, nominally reigned for a few months each. Then Hasan Kuchuk set up one Sati-beg, Abu Sa'id's daughter, and wife successively of Chupan, Arfa Khan and one Sulciman, the last of whom was khan from 1339 to 1343; in the same time Hasan Buzurg set up successively Mahommed, Tugha-Timur and Jahan-Timur. A sixth nonentity, Nushirwan, was a Chupani nominee in 1344, after which time Hasan Buzurg definitely installed himself as the first khan of the Jelairid or Ilkhanian-Jelairid dynasty.

Practically from the reign of Abu Sa'id Persia was divided under five minor dynasties, (1) the Jelairids, (2) the Mozaffarids,

(3) the Sarbadarids (Serbedarids), (4) the Beni Kurt, and (5) the Jubanians, all of which ultimately fell before the armies of Timur.

1. The Jelairid rulers were Hasan Buzurg (1336, strictly 1344-1356), Owais (1356-1374), Hosain (1374-1382), Sultan Ahmad (1382-1410), Shah Walad (1410-1411). Their capital was Bagdad, and their dominion was increased under Hasan. Owais added Azerbaijan, Tabriz, and even Mosul and Diarbekr. Hosain fought with the Mozaffarids of Shiraz and the Black Sheep Turkomans (Kara Kuyunli) of Armenia, with the latter of whom he ultimately entered into alliance. On his death Azerbaijan and Irak fell to his brother, Sultan Ahmad, while another brother-Bayezid ruled for a few months in part of Kurdistan. It was about this time that Timur (*q.v.*) began his great career of conquest, under which the power of the various Persian dynasties collapsed. By 1393 he had conquered northern Persia and Armenia, Bagdad, Mesopotamia, Diarbekr and Van, and Ahmad fled to Egypt, where he was received by Barkuk (Barquq) the Mameluke sultan. Barkuk, who had already excited the enmity of Timur by slaying one of his envoys, espoused Ahmad's cause, and restored him to Bagdad after Timur's return to his normal capital Samarkand. Timur retaliated and until his death Ahmad ruled only from time to time. In 1406 Ahmad was finally restored, but almost immediately entered upon a quarrel with Kara Yusuf, leader of the Black Sheep Turkomans (Kara Kuyunli), who defeated and killed him in 1410. His nephew Shah Walad reigned for a few months only and the throne was occupied by his widow Tandu, formerly wife of Barkuk, who ruled over Basra, Wasit and Shuster till 1416, paying allegiance to Shah Rukh, the second Timurid ruler. Walad's sons Mahmud, Owais and Mahommed, and Hosain, grandson of Sultan Ahmad, successively occupied the throne. The last of these was killed by the Kara

Kuyunli, who had established a dynasty in western Persia after Kara Yusuf's victory in 1410.

2. The Mozaffarids, who ruled roughly from 1313 to 1399 in Fars, Kermān and Kurdistan, were descended from the Amir Mozaffar, or Muzaffar, who held a post as governor under the Ilkhan ruler. His son Mobariz ud-din Mahommed, who followed him in 1313, became governor in Fars under Abu Sa'id, in Kermān in 1340, and subsequently made himself independent at Fars and Shiraz (1353) and in Isfahan (1356). In 1357 he was deposed and blinded, and though restored was exiled again and died in 1364. His descendants, except for Jelial ed-din (Jalaluddin) Shah Shuja', the patron of the poet Hafiz, were unimportant, and the dynasty was wiped out by Timur about 1392.

3. The Sarbadarids (so called from their motto *Sar-ba-dar*, "Head to the Gibbet"), descendants of Abd al-Razzak, who rebelled in Khorasan about 1337, enjoyed some measure of independence under twelve rulers till they also were destroyed by Timur (c. 1380).

4. The Beni Kurt (or Kart), who had governed in Khorasan from 1245, became independent in the early 14th century; they were abolished by Timur (c. 1383).

5. The Jubanians had some power in Azerbaijan from 1337 to 1355, when they were dethroned by the Kipchaks of the house of Jenghiz Khan.

The authority of Timur, which, as we have seen, was dominant throughout Persia from at least as early as 1395 till his death in 1405, was never unchallenged. He passed from one victory to another, but the conquered districts were never really settled under his administration. Fresh risings of the defeated dynasties followed each new enterprise, and he had also to deal with the Mongol hordes whose territory marched with northern Persia. His descendants were for a brief period the overlords of Persia, but after Shah Rukh (reigned 1409-1446) and Ala addaula (1447), the so-called Timurid dynasty ceased to have any authority over Persia. There were Timurid governors of Fars under Shah Rukh, Pir Mahommed (1405-1409), Iskendar (1409-1414), Ibrahim (1415-1434) and Abdallah (1434); in other parts of Persia many of the Timurid family held governorships of greater or less importance.

AUTHORITIES.—The works relating to Persia will be found under articles on the main dynasties (CALIPHATE; SASSANIDS; MONGOLS), and the great rulers (JENGHIZ KHAN; MAHMUD OF GHAZNI; TIMUR). For general information and chronology see S. Lane Poole, *Mohammedan Dynasties* (London, 1894); Stockvis, *Manuel d'histoire*, vol. i. (Leiden, 1888); Sir H. Howorth, *History of the Mongols* (1876-1888). (J. M. M.)

C.—From the Death of Timur to the Fall of the Safawid Dynasty, 1405-1736.

Timur died in 1405, when in the seventieth year of his age and about to invade China. Besides exercising sovereignty over Transoxiana and those vast regions more or less absorbed in Asiatic Russia of the 10th century, *ides and inclusive of the Caucasus, Astrakhan and the Turkomans, lower Volga, and overrunning Mesopotamia, Syria, Asia Minor, Afghanistan and India, he had at this time left his indelible mark upon the chief cities and provinces of Persia. Khorasan and Mazandaran had submitted to him in 1381, Azerbaijan had shortly after followed their example, and Isfahan was seized in 1387. From Isfahan he passed on to Shiraz, and thence returned in triumph to his own capital of Samarkand. Five years later he subdued Mazandaran, and later still he was again at Shiraz, having effected the subjugation of Luristan and other provinces in the west. It may be said that from north to south, or from Astarabad to Hormuz, the whole country had been brought within his dominion.*

The third son of Timur, Miran Shah, had ruled over part of Persia in his father's lifetime; but he was said to be insane, and his incapacity for government had caused the loss of Bagdad and recolt in other provinces. His claim to succession had been put aside by Timur in favour of Pir Mahommed, the son of a deceased son, but Khalil Shah, a son of the discarded prince, won the day. His waste of time and treasure upon a fascinating mistress named Shadu'l-Mulk; the "delight of the kingdom," soon brought about his deposition, and in 1408 he gave way to Shah Rukh, who, with the exception of Miran Shah, was the only surviving son of Timur. In fact the uncle and nephew changed places—the one quitting his government of Khorasan

to take possession of the Central-Asian throne, the other consenting to become governor of the vacated Persian province and abandon the cares of the empire at Samarkand. In 1409 Khalil Shah died; and the story goes that Shadu 'L-Mulk stabbed himself and was buried with her royal lover at Rai, one of the towns which his grandfather had partly destroyed.

Shah Rukh, the fourth son of Timur, reigned for thirty-eight years, and appears to have been a brave, generous, and enlightened monarch. He removed his capital from Samarkand to Herat, of which place he rebuilt the citadel, restoring and improving the town. Merv also profited from his attention to its material interests. Sir John Malcolm speaks of the splendour of his court and of his encouragement of science and learning. He sent an embassy to China; and an English version of the travels to India of one of his emissaries, Abd ur-Razzak, is to be found in R. H. Major's *India in the Fifteenth Century* (London, Hakluyt Society, 1857). As regards his Persian possessions, he had some trouble in the north-west, where the Turkomans of Asia Minor, known as the Kara Kuyun, or "Black Sheep," led by Kara Yusuf¹ and his sons Iskandar and Jahan Shah, had advanced upon Tabriz, the capital of Azerbaijan. On the death of the Shah Rukh in 1446 he was succeeded by his son Ulugh Bey, whose scientific tastes are demonstrated in the astronomical tables bearing his name, quoted by European writers when determining the latitude of places in Persia. He was, moreover, himself a poet and patron of literature, and built a college as well as an observatory at Samarkand. There is no evidence to show that he did much to consolidate his grandfather's conquests south of the Caspian. Ulugh Bey was put to death by his son Abd ul-Latif, who, six months later, was slain by his own soldiers. Babar—not the illustrious founder of the Moghul dynasty in India, but an elder member of the same house—next obtained possession of the sovereign power, and established himself in the government of Khorasan and the neighbouring countries. He died after a short rule, from habitual intemperance. After him Abu Sa'id, grandson of Miran Shah, and once governor of Fars, became a candidate for empire, and allied himself with the Uzbek Tatars, seized Bokhara, entered Khorasan, and waged war upon the Turkoman tribe aforesaid, which, since the invasion of Azerbaijan, had, under Jahan Shah, overrun Irak, Fars and Kermān, and pillaged Herat. But he was eventually taken prisoner by Uzun Hasan, and killed in 1468.

It is difficult to assign dates to a few events recorded in Persian history for the eighteen years following the death of Abd ul-Latif; and, were it not for chance European missions, the same difficulty would be felt in dealing with the period after the death of Abu Sa'id up to the accession of Isma'il Sufi in 1499. Sultan Ahmad, eldest son of Abu Sa'id, reigned in Bokhara; his brother, Omar Sheikh, in Ferghana; but the son of the latter, the great Babar, was driven by the Uzbeks to Kabul and India. More to the purpose is it that Sultan Hosain Mirza, great-grandson of Omar Sheikh, son of Timur, reigned in Herat from 1487 to 1506. He was a patron of learned men, among others of the historians Mirk-hond and Khwadamir, and the poets Jami and Hatifi. But at no time could his control have extended over central and western Persia. The nearest approach to a sovereignty in those parts on the death of Abu Sa'id is that of Uzun Hasan, the leader of the Ak Kuyun, or "White Sheep" Turkomans, and conqueror of the "Black Sheep," whose chief, Jahan Shah, he defeated and slew. Between the two tribes there had long been a deadly feud. Both were composed of settlers in Asia *Uzun Hasan* Minor, the "Black Sheep" having consolidated their power at Van, the "White" at Diarbekr.

Sir John Malcolm states that at the death of Abu Sa'id, Sultan Hosain Mirza "made himself master of the empire,"

¹ They were commonly called Kara Kuyun-lu and the "White Sheep" Turkomans Ak Kuyun-lu, the affix "lu" signifying possession, i.e. possession of a standard bearing the image of a black or white sheep.

² According to Erskine, this chief killed Miran Shah, whose dwelling-place was Tabriz.

and, a little later, that "Uzun Hasan, after he had made himself master of Persia, turned his arms in the direction of Turkey"; but the reader is left to infer for himself what the real "empire" of Hosain Mirza, and what the limit of the "Persia" of Uzun Hasan. The second could not well be included in the first, because the Turkomans were in possession of the greater part of the Persian plateau, while the "sultan" was in Herat, to which Khorasan belonged. It may be assumed that an empire like that acquired by Timur could not long be maintained by his descendants in its integrity.

The Turkish adjective *uzun*, اوزون "long," applied to Hasan, the Turkoman monarch of Persia (called also by the Arabs Hasan u 't-Tawil), is precisely the qualifying Persian word *شاه* used in the compound designation of Artaxerxes Longimanus; and Malcolm quotes the statement of a Venetian envoy in evidence that Uzun Hasan was "a tall thin man, of a very open and engaging countenance." This reference, and a further notice in Markham's history, supply the clue to a store of valuable information made available by the publications of the Hakluyt Society. The narratives of Caterino Zeno, Barbaro and Contarini, envoys from Venice to the court of Uzun Hasan, are in this respect especially interesting. Zeno was sent in 1471 to incite this warlike ruler against the Ottoman sultan, and succeeded in his mission. That the result was disastrous to the shah is not surprising, but the war seems to hold a comparatively unimportant place in the annals of Turkey.

Uzun Hasan had married Despina (Gr. Δέσποινα), daughter of the emperor of Trebizond, Calo Johannes of the house of the Comneni; and Zeno's wife was niece to this Christian prince. The relationship naturally strengthened the envoy's position at the court, and he was permitted to visit the queen in the name of the republic which he represented. Barbaro and Contarini met at Isfahan in 1474, and there paid their respects to the shah together. Kum and Tauris or Tabriz (then the capital) were also visited by the Italian envoys following in the royal suite; and the incidental notice of these cities, added to Contarini's formal statement that "the extensive country of Ussu-cassan [sic] is bounded by the Ottoman Empire and by Carmania," and that Siras (Shiraz) is comprehended in it, proves that at least Azerbaijan, Irak, and the main part of the provinces to the south, inclusive of Fars, were within the dominions of the reigning monarch.

There is good reason to suppose that Jahan Shah, the Black Sheep Turkoman, before his defeat by Uzun Hasan, had set up the standard of royalty; and Zeno, at the outset of his travels, calls him "king of Persia"² in 1450. Chardin alludes to him in the same sense; but Hasan the Long is a far more prominent figure, and has hardly received justice at the hands of the historian. Indeed, his identity seems to have been lost in the various modes of spelling his name adopted by the older chroniclers, who call him indiscriminately Alymbeius, Asembeius, Asembec, Assimbeo, or Ussan Cussano. He is said to have earned the character of a wise and valiant monarch, to have reigned eleven years, to have lived to the age of seventy, and, on his death in 1477 or (according to Krusinski and Zeno) 1478, to have been succeeded on the throne of Persia by his son Ya'qub. This prince, who had slain an elder brother, died by poison (1485), after a reign of seven years. The dose was offered to him by his wife, who had been unfaithful to him and sought to set her paramour on his throne.

Writers differ as to the succession to Ya'qub. Zeno's account is that a son named Allamur (called also, Alamut, Alvante, El-wand and Alwng Bey) was the next king, who, besides Persia, possessed Diarbekr and part of greater Armenia near the Euphrates. On the other hand, Krusinski states that, Ya'qub dying childless, his relative Julaver, one of the grandes of the kingdom, seized the throne, and held possession of it for three years. Baisingar, it is added, succeeded him in 1488 and reigned till 1490, when a young nobleman named Rustan (Rustam?) obtained the sovereign power and exercised it for seven years. This account is confirmed by

² See also Ramusio's preface. ³ Knolles. Purchas. Zeno.

Angiolello, a traveller who followed his countrymen Barbaro and Contarini to Persia; and from the two authorities combined may be gathered the further narration of the murder of Rustam and usurpation of the throne by a certain Ahmad, whose death, under torture, six months afterwards, made way for Alamut, the young son of Hasan. These discrepancies can be reconciled on reference to yet another record bound up with the narratives of the four Italians aforesaid, and of much the same period. In the *Travels of a Merchant in Persia* the story of Ya'qub's death is supplemented by the statement that "the great lords, hearing of their king's decease, had quarrels among themselves, so that for five or six years all Persia was in a state of civil war, first one and then another of the nobles becoming sultans. At last a youth named Alamut, aged fourteen years, was raised to the throne, which he held till the succession of Sheikh Isma'il." Who this young man was is not specified; but other writers call Alamut and his brother Murad the sons of Ya'qub, as though the relationship were unquestionable.

New little is known, save incidentally, of Julaver or Rustam; but Baisingar is the name of a nephew of Omar Sheikh, king of Ferghana and contemporary of Uzun Hasan. There was no doubt much anarchy and confusion in the interval between the death of Ya'qub and the restoration, for two years, of the dynasty of the White Sheep. But the tender age of Alamut would, even in civilized countries, have necessitated a regency; and it may be assumed that he was the next legitimate and more generally recognized sovereign. Markham, in designating this prince the last of his house, states that he was dethroned by the renowned founder of the Safawi dynasty. This event brings us to one of the most interesting periods of Persian history, any account of which must be defective without a prefatory sketch of Isma'il Sufi.

The Saifu or Safawid (Safawi) Dynasty (1499-1735).—Sheikh Saifu 'd-Din Izhak—lineally descended from Musa, the seventh imam—was a resident at Ardebil (Ardabil) south-west of the Caspian, some time during the 14th century. It is said that his reputation for sanctity, attracted the attention of Timur, who sought him out in his abode, and was so charmed by the visit that he released, at the holy man's request, a number of captives of Turkish origin, or Georgians, taken in the wars with Bayezid. The act ensured to the Sheikh the constant devotion and gratitude of these men—a feeling which was loyally maintained by their descendants for the members of his family in successive generations.

His son Sadru'd-Din and grandson Kwaja 'Ali (who visited Mecca and died at Jerusalem) retained the high reputation of their pious predecessor. Junaid, a grandson of the last, married a sister of Uzun Hasan, and by her had a son named Sheikh Haidar, who married his cousin Martha, daughter of Uzun Hasan and Queen Despina. Three sons were the issue of this marriage, Sultan 'Ali, Ibrahim Mirza, and the youngest, Isma'il, the date of whose birth is put down as 1480 for reasons which will appear hereafter. So great was the influence of Sheikh Haidar, and so earnestly did he carry out the principles of conduct which had characterized his family for five generations, that his name has become, as it were, inseparable from the dynasty of his son Isma'il; and the term "Haidari" (Ieonie) is applied by many persons to indicate generally the Safawids of Persia. The outcome of his teaching was a division of Mahomedanism vitally momentous to the world of Islam. The Persian mind was peculiarly adapted to receive the form of religion prepared for it by the philosophers of Ardebil. The doctrines presented were dreamy and mystic; they rejected the infallibility of human wisdom, and threw suspicion on the order and arrangement of human orthodoxy. There was free scope given for the indulgence of that political imagination which revels in revolution and chafes at prescriptive bondage. As Malcolm remarks, "the very essence of Sufi-ism is poetry."

¹ According to Langlès, the annotator of Chardin, his real designation was Abu 'l-Fath Izhak, the Sheikh Saifu 'l-Hakk wu 'd-Din or pure one of truth and religion."

Those authorities who maintain that Ya'qub Shah left no son to succeed him consider valid the claim to the vacant throne of Sheikh Haidar Sufi. Purchas says that Ya'qub himself, "jealous of the multitude of Aidar's disciples and the greatness of his fame, caused him to be secretly murdered"; but Krusinski attributes the act to Rustam a few years later. Zeno, the anonymous merchant and Angiolello affirm that the devotee was defeated and killed in battle—the first making his conqueror to be Alamut, the second a general of Alamut's, and the third an officer sent by Rustam named Suleiman Bey. Malcolm, following the *Zubdatu 'l-tawarikh*, relates that Sheikh Haidar was vanquished and slain by the governor of Shirvan. The subsequent statement that his son, Sultan 'AE, was seized, in company with two younger brothers, by Ya'qub, "one of the descendants of their grandfather Usun Hasan, who, jealous of the numerous disciples that resorted to Ardebil, confined them to the hill fort of Istakhr in Fars," seems to indicate a second interpretation of the passage just extracted from Purchas, and that there is confusion of persons and incident somewhere. One of the sons here alluded to was Isma'il, whom Malcolm makes to have been only seven years of age when he fled to Gilan in 1492. Zeno states that he was then thirteen, which is much more probable,² and the several data available for reference are in favour of this supposition.

The life of the young Sufi from this period to his assumption of royalty in 1499 was full of stirring adventure; and his career as Isma'il I. was a brilliant one. According to *Isma'il* Zeno, who seems to have carefully recorded the events of the time, he left his temporary home on an island of Lake Van before he was eighteen, and, passing into Karabakh,³ between the Aras and Kur, turned in a south-easterly direction into Gilan. Here he was enabled, through the assistance of a friend of his father, to raise a small force with which to take possession of Baku on the Caspian, and thence to march upon Shemakha in Shirvan, a town abandoned to him without a struggle. Hearing, however, that Alamut was advancing to meet him, he was compelled to seek new levies from among the Jenglan Christians and others. At the head of 16,000 men, he thoroughly routed his opponents, and, having cleared the way before him, marched straight upon Tabriz, which at once surrendered. He was soon after proclaimed shah of Persia (1499), under the designation which marked the family school of thought.

Alamut had taken refuge at Diarbekr; but his brother Murad, at the head of an army strengthened by Turkish auxiliaries, was still in the field with the object of contesting the paternal crown. Isma'il lost no time in moving against him, and won a new victory on the plains of Tabriz. Murad fled with a small remnant of his soldiers to Diarbekr, the rallying-point of the White Sheep Turkomans. Zeno states that in the following year Isma'il entered upon a new campaign in Kurdistan and Asia Minor, but that he returned to Tabriz without accomplishing his object, having been harassed by the tactics of Ala ud-Daula, a beylerbey, or governor in Armenia and parts of Syria. Another writer says that he marched against Murad Khan in Irak-I Ajami and Shiraz. This last account is extremely probable, and would show that the young Turkoman had wished to make one grand effort to save Isfahan and Shiraz (with Kazvin and the neighbouring country), these being, after the capital Tabriz, the most important cities of Uzun Hasan's Persia. His men, however, apparently dismayed at the growing prestige of the enemy, did not support him, and he was defeated and probably slain. There is similar evidence of the death of Alamut, who, it is alleged, was treacherously handed over to be killed by the shah's own hands.

Isma'il returned again to Tabriz (1501) "and caused great rejoicings to be made on account of his victory." In 1503 he had added to his conquests Bagdad, Mosul and Jezira on the Tigris. The next year he was called to the province of

² So thinks the editor and annotator of the Italian *Travels in Persia*, Charles Grey.

³ Possibly Kara-dagh, as being the more direct road.

Gilan to chastise a refractory ruler. Having accomplished his end, he came back to his capital and remained there in comparative quiet till 1507.¹ Malcolm's dates are somewhat at variance with the above, for he infers that Bagdad was subdued in that particular year, but the facts remain. All writers seem to agree that in 1508 the king's attention was drawn to an invasion of Khorasan by Shaibani, or Shahi Beg, the Uzbek, a descendant of Jenghiz and the most formidable opponent of Babar, from whom he had, seven years before, wrested the city of Samarkand, and whom he had driven from Turkestan to Kabul. Since these exploits he had obtained great successes in Tashkent, Ferghana, Hissar, Kunduz, and Khwarizm (Kharezm), and, at the time referred to, had left Samarkand intent upon mischief south and west of the Oxus, had passed the Murghab, and had reached Sarakhs (Serakhs). Isma'il encamped on this occasion at Isfahan, and there concentrated the bulk of his army—strengthening his northern (and probably north-eastern) frontier with large bodies of cavalry, but maintaining an attitude of simple watchfulness. In 1510, when Shaibani had invaded Khorasan the second time, and had ravaged the Persian province of Kermān, Shah Isma'il asked for redress, referring to the land encroached on as "hereditary"; and Shaibani replied that he did not understand on what was founded the claim "to inherit." Eventually the Persian troops were put in movement, and the Uzbeks, having been divided into small detachments scattered over the country, fell back and retreated to Herat. Their leader repaired to Merv, but Isma'il quickly followed him and enticed him out to battle by taunt and reproach. Shaibani was defeated and fled, but was overtaken in his flight, and put to the sword, together with numerous relatives and companions.

The next remarkable event in Isma'il's reign is his war with Sultan Selim I. Its origin may be traced to the Ottoman emperor's hatred and persecution of all heretical Moslems in his dominions, and the Shah's anger at the fanaticism which had urged him to the slaughter of 40,000 Turks suspected to have thrown off the orthodox Sunni doctrines. The Sultan's army advanced into Azerbaijan and western Persia through Tokat and Erzangan. Isma'il had at this time the greater number of his soldiers employed in his newly-conquered province of Khorasan and was driven to raise new levies in Kurdistan to obtain a sufficient force to resist the invasion. It is asserted by some that his frontier then extended westward to Sivas, a city situated in a large high plain watered by the Kizil Irmak, and that hence to Khoi, 90 m. west of Tabriz, he followed the approved and often successful tactics of ravaging and retreating, so as to deprive his advancing enemy of supplies. There is good evidence to show that the Turkish janissaries were within an ace of open revolt, and that but for extraordinary firmness in dealing with them they would have abandoned their leader in his intended march upon Tabriz. In fine, at or near Khoi, the frontier-town of Azerbaijan, the battle (1514) was fought between the two rival monarchs, ending in the defeat of the Persians and the triumphant entry of Selim into their capital.

There are stirring accounts of that action and of the gallant deeds performed by Selim and Isma'il, both personally engaged in it, as well as by their generals.² Others maintain that Isma'il was not present at all.³ It is tolerably certain that the Turks won the day by better organization, superiority of numbers, and more especially the use of artillery. On the side of the Persians the force consisted of little more than cavalry.

¹ Angiolello.
² Knolles, Malcolm, Creasy, Markham, &c.
³ Zeno. Angiolello says that "the Sophi monarch had left for Tauris (Tabriz) in order to assemble more troops." Krusinski infers much to the same effect, for he notes that "Selim came in person and took Tauris from Ismail, but at the news of his approach was obliged to retreat with precipitation." The battle must thus have been fought and the victory gained when the Shah was himself absent. Yet Markham quotes a journal which thus records his feats of prowess: "It was in vain that the brave Shah, with a blow of his sabre, severed a chain with which the Turkish gups were fastened together to resist the shock of the Persian cavalry."

Selim remained at Tabriz no more than eight days. Levying a contribution at that city of a large number of its skilled artisans whom he sent off to Constantinople, he marched thence towards Karabagh with intent to fix his winter quarters in those parts and newly invade Persia in the spring, but the insubordination of his troops rendered necessary his speedy return to Turkey. His expedition, if not very glorious, had not been unproductive of visible fruits. Besides humbling the power of an arrogant enemy, he had conquered and annexed to his dominions the provinces of Diarbekr and Kurdistan.⁴

From 1514 to 1524, although the hostile feeling between the two countries was very strong, there was no serious nor open warfare. Selim's attention was diverted from Persia to Egypt; Isma'il took advantage of the Sultan's death in 1519 to overrun and subdue unfortunate Georgia, as Jahan Shah of the "Black Sheep" had done before him; but Suleiman, who succeeded Selim, was too strong to admit of retaliatory invasion being carried out with impunity at the cost of Turkey.

In 1524 Isma'il died⁵ at Ardebil when on a pilgrimage to the tomb of his father. "The Persians dwell with rapture on his character," writes Sir John Malcolm, for they deem him "not only the founder of a great dynasty, but the person to whom that faith in which they glory owes its establishment as a national religion." And he quotes a note handed down by Purchas from a contemporary European traveller which reports of him thus: "His subjects deemed him a saint, and made use of his name in their prayers. Many disdained to wear armour when they fought under Isma'il; and so enthusiastic were his soldiers in their new faith that they used to bare their breasts to their enemies and court death, exclaiming 'Shiah! Shiah!' to mark the holy cause for which they fought."

Shah Tahmasp,⁶ the eldest of the four sons of Isma'il, succeeded to the throne on the death of his father.⁷ The principal occurrences in his reign, placed as nearly as possible in chronological order, were a renewal of war with the Uzbeks, who had again invaded Khorasan, and the overthrow of their army (1527); the recovery of Bagdad from a Kurdish usurper (1528); the settlement of an internal feud between Kizil-bash tribes (Shamlu and Tukulu), contending for the custody of the royal person, by the slaughter of the more unruly of the disputants (1529); the rescue of Khorasan from a fresh irruption, and of Herat from a besieging army of Uzbeks (1530); a new invasion of the Ottomans, from which Persia was saved rather by the severity of her climate than by the prowess of her warriors (1533); the wresting of Bagdad from Persia by the Sultan Suleiman (1534); the king's youngest brother's rebellion

⁴ It was about this time that Persia again entered into direct relations with one of the states of western Europe. In 1510 and 1514 Alphonso d'Albuquerque, the governor of Portuguese India, sent envoys to Isma'il, seeking an alliance. In 1515, after occupying Hormuz, he despatched a third embassy under Fernão Gomes de Lemos. His object was to utilize the Shi'ite armies in conjunction with the Portuguese fleet for an attack upon the Sunnite powers—Egypt and Turkey—which were then at war with Portugal in the East. See, for further details and authorities, K. G. Jayne, *Vasco da Gama and his Successors*, pp. 108-110 and App. A. (London, 1910).—Ed.

⁵ Malcolm says 1523, Krusinski 1525; Angiolello heard of his death at Cairo in August 1524. Krusinski adds that he was forty-five years of age.

⁶ Angiolello calls him "Shiacthemes." As an instance of the absurd transliterating current in France as in England the word "Ach-tacon" may be mentioned. It is explained in Chardin's text to mean "les hôpitaux à Tauris: c'est-à-dire lieux où l'on fait profession de vires." Chardin's editor remarks: "La dernière partie de ce mot est méconnaissable, et je ne puis deviner quel mot Persan signifiait profusion a pu donner naissance à la corruption qu'on voit ici." In other words, the first syllable "ach" (Anglicized) was understood in its common acceptance for "food" or "victuals"; but "tacon" was naturally a puzzler. The solution of the whole difficulty is, however, to be found in the Turco-Persian *āsh khāshak khānah*, pronounced by Turks *hāsh khāsh*, or more vulgarly *ashā khāsh* and even to a French ear *ash-tacon*, a hospital, literally a sick-house. This word is undoubtedly current at Tabriz and throughout northern Persia. The other brothers were Ilkhas, Bahram and Sam Mirza, each having had his particular appanage assigned him.

and the actual seizure of Herat, necessitating the recovery of that city and a march to Kandahar (1536); the temporary loss of Kandahar in the following year (1537), when the governor ceded it to Prince Kamran, son of Babar; the hospitable reception accorded to the Indian emperor Humayun (1543); the rebellion of the shah's brother next in age, Ilkhas, who, by his alliance with the sultan, brought on a war with Turkey (1548);¹ and finally a fresh expedition to Georgia, followed by a revengeful incursion which resulted in the enforced bondage of thousands of the inhabitants (1552).

Bayezid, a son of the Turkish emperor, rebelled, and his army was beaten in 1559 by the imperial troops at Konia in Asia Minor. He fled to Persia and took refuge

War with Turkey. with Shah Tahmasp, who pledged himself to give him a permanent asylum. Suleiman's demand,

however, for extradition or execution was too peremptory for refusal, and the prince was delivered up to the messengers sent to take him. Whatever the motive, the act itself was highly appreciated by Suleiman, and became the means of cementing a recently concluded peace between the two monarchs. Perhaps the domestic affliction of the emperor and the anarchy which in his later years had spread in his dominions had, however, more to do with the maintenance of tranquillity than any mere personal feeling. At this time not only was there religious fanaticism at work to stir up the mutual hatred ever existing between Sunni and Shi'ah, but the intrigue of European courts was probably directed towards the maintenance of a hostility which deterred the sultan from aggressive operations north and west of Constantinople. "Tis only the Persian stands between us and ruin" is the reported saying of Busbecq, ambassador at Suleiman's court on the part of Ferdinand of Austria; "the Turk would fain be upon us, but he keeps him back."

In 1561 Anthony Jenkinson arrived in Persia with a letter from Queen Elizabeth to the shah. He was to treat with his majesty of "Traffic and Commerce for our English Marchants,"² but his reception was not encouraging, and led to no result of importance.

Tahmasp died in 1576, after a reign of about fifty-two years. He must have been some sixty-six years of age, having come to the throne at fourteen. Writers describe

Tahmasp's Death. him as a robust man, of middle stature, wide-lipped, and of tawny complexion. He was not wanting

in soldierly qualities; but his virtues were rather negative than decided. The deceased shah had a numerous progeny, and on his death his fifth son, Haidar Mirza, proclaimed himself king, supported in his pretensions by the Kizil-bash tribe of Ustujulu. Another tribe, the Afshar, insisted on the succession of the fourth son, Isma'il. Had it not been that there were two candidates in the field, the contention would have resembled that which arose shortly after Tahmasp's accession. Finally Isma'il, profiting from his brother's weak character and the intrigues set on foot against him, obtained his object, and was brought from a prison to receive the crown.

The reign of Isma'il II. lasted less than two years. He was found dead in the house of a confectioner in Kazvin, having

Isma'il II. left the world either drunk, drugged or poisoned. No steps were taken to verify the circumstances, for the event itself was a cause of general relief and joy. He was succeeded by his eldest brother, Mahommed Mirza, otherwise

Mahommed Khudabanda. called Mahommed Khudabanda, whose claim to sovereignty had been originally put aside on the ground of physical infirmity. He had the good

sense to trust his state affairs almost wholly to an able minister; but he was cowardly enough to deliver up that minister into the hands of his enemies. His kingdom was distracted by intestine divisions and rebellion, and the foe

¹ Creasy says that "Suliman led his armies against the Persians in several campaigns (1533, 1534, 1535, 1548, 1553, 1554), during which the Turks often suffered severely through the difficult nature of the countries traversed, as well as through the bravery and activity of the enemy." All the years given were in the reign of Tahmasp I.

² Purchas.

appeared also from without. On the east his youngest son 'Abbas, held possession of Khorasan; on the west the sultan's troops again entered Azerbaijan and took Tabriz. His eldest son, Hamza Mirza, upheld his fortunes to the utmost of his power, reduced the rebel chieftains, and forced the Turks to make peace and retire; but he was stabbed to death by an assassin. On the news of his death reaching Khorasan, Murshid Kuli Khan, leader of the Ustujulu Kizil-bash, who had made good in fight his claims to the guardianship of 'Abbas, at once conducted the young prince from that province to Kazvin, and occupied the royal city. The object was evident, and in accordance with the popular feeling. 'Abbas, who had been proclaimed king by the nobles at Nishapur some two or three years before this occurrence, may be said to have now undertaken in earnest the cares of sovereignty. His ill-starred father, at no time more than a nominal ruler, was at Shiraz, apparently deserted by soldiers and people. Malcolm infers that he died a natural death, but when or where is not stated.

Shah 'Abbas the Great commenced his long and glorious reign (1586) by retracing his steps towards Khorasan, which had been reinvaded by the Uzbeks almost immediately after his departure thence with the Kizil-bash chief. They had besieged and taken Herat, killed the governor, plundered the town, and laid waste the surrounding country. 'Abbas advanced to Meshed, but owing to internal troubles he was compelled to return to Kazvin without going farther east. In his absence 'Abd-ul-Munim Khan, the Uzbek commander, attacked the sacred city, obtained possession of it while the shah lay helplessly ill at Teheran, and allowed his savage soldiers full licence to kill and plunder. The whole kingdom was perplexed, and 'Abbas had much work to restore confidence and tranquillity. But circumstances rendered impossible his immediate renewal of the Khorasan warfare. He was summoned to Shiraz to put down rebellion in Fars; and before he could drive out the Uzbeks, he had to secure himself against Turkish inroads threatening from the west. He had been engaged in a war with Murad III. in Georgia. Peace was concluded between the two sovereigns in 1590; but the terms were unfavourable to Persia, who lost thereby Tabriz and one or more of the Caspian ports. A stipulation was included in the treaty to the effect that Persians were not to curse any longer the first three caliphs, — a sort of privilege previously enjoyed by Shi'ites as part and parcel of their religious faith.

In 1597 'Abbas renewed operations against the Uzbeks, and succeeded in recovering from them Herat and Khorasan. Eastward he extended his dominions to Balkh, and in the south his generals made the conquest of Bahrain (Bahrein), on the Arabian side of the Persian Gulf, and the territory and islands of the Persian seaboard, inclusive of the mountainous province of Lar. He strengthened his position in Khorasan by planting colonies of Kurdish horsemen on the frontier, or along what is called the "atak" or skirt of the Turkoman mountains north of Persia. In 1601 the war with the Ottoman Empire, which had been partially renewed prior to the death of Sultan Murad in 1595, with little success on the Turkish side, was now entered upon by 'Abbas with more vigour. Taking advantage of the weakness of his ancient enemy in the days of the poor voluptuary Mahommed III., he began rapidly to recover the provinces which Persia had lost in preceding reigns, and continued to reap his advantages in succeeding campaigns under Ahmed I., until under Othman II. a peace was signed restoring to Persia the boundaries which she had obtained under the first Isma'il. On the other side Kandahar, which Tahmasp's lieutenant had yielded to the Great Mogul, was recovered from that potentate in 1609.

At the age of seventy, after a reign of forty-two years, 'Abbas died at his favourite palace of Farahabad, on the coast of Mazandaran, on the night of the 27th of January 1628. Perhaps the most distinguished of all Persian kings, his fame was not merely local but world-wide. At his court were ambassadors from England, Russia, Spain, Portugal, Holland, and India.

² Krusinski says in 1585.

To his Christian subjects he was a kind and tolerant ruler. The establishment of internal tranquillity, the expulsion of interlopers and marauders like Turks and Uzbeks, the introduction of salutary laws and the promotion of public works of utility—these alone would render remarkable his two-score years of enlightened government. With a fine face, "of which the most remarkable features were a high nose and a keen and piercing eye,"¹ he is said to have been below the middle height, robust, active, a sportsman, and capable of much endurance. It is, however, to be regretted that this monarch's memory is tarnished by more than one dark deed. The murder of his eldest son, Şuñi Mirza, and the cruel treatment of the two younger brothers, were stains which could not be obliterated by an after-repentance. All that can be now said or done in the matter is to repeat the testimony of historians that his grief for the loss of Şuñi Mirza was profound, and that, on his death-bed, he nominated that prince's son (his own grandson) his successor.

Şam Mirza was seventeen years of age when the nobles, in fulfilment of the charge committed to them, proclaimed him king under the title of Shah Şuñi. He reigned *Şah Şuñi* fourteen years, and his reign was a succession of barbarities, which can only be attributed to an evil disposition acted upon by an education void of all civilizing influences. When left to his own devices he became a drunkard and a murderer, and is accused of the death of his mother, sister and favourite queen. Among many other sufferers Imam Kuli Khan, conqueror of Lar and Hormuz, the son of one of 'Abbas's most famous generals, founder of a college at Shiraz, and otherwise a public benefactor, fell a victim to his savage cruelty. During his reign the Uzbeks were driven back from Khorasan, and a rebellion was suppressed in Gilan; but Kandahar was again handed over to the Moguls of Delhi, and Bagdad retaken from Persia by Sultan Murad—both serious national losses. Tavernier, without charging the shah with injustice to Christians, mentions the circumstance that "the first and only European ever publicly executed in Persia was in his reign." He was a watchmaker named Rodolph Stadler, who had slain a Persian on suspicion of intrigue with his wife. Offered his life if he became a Moslem, he resolutely declined the proposal, and was decapitated. His tomb is to be recognized at Isfahan by the words "Cy git Rodolphe" on a long wide slab. Shah Şuñi died (1641) at Kashi and was buried at Kum.

His son, 'Abbas II., succeeded him. Beyond regaining Kandahar, an operation which he is said to have directed in 'Abbas II. person when barely sixteen, there is not much to mark his life to the outer world. As to foreign relations, he received embassies from Europe and a deputation from the French East India Company; he sought to conciliate the Uzbeks by treating their refugee chiefs with unusual honour and sumptuous hospitality; he kept on good terms with Turkey; he forgave the hostility of a Georgian prince when brought to him a captive; and he was tolerant to all religions—always regarding Christians with especial favour. But he was a drunkard and a debauchee, and chroniclers are divided in opinion as to whether he died from the effects of drink or licentious living. That he changed the system of blinding his relatives from passing a hot metal over the open eye to an extraction of the whole pupil is indicative of gross brutality. 'Abbas II died (1668) at the age of thirty-eight, after a reign of twenty seven years, and was buried at Kum in the same mosque as his father.

'Abbas was succeeded by his son, Shah Şuñi II., crowned a second time under the name of Shah Suleiman. Though weak, *Suleiman* dissolute and cruel, Suleiman is not without his panegyrist. Chardin, whose testimony is all the more valuable from the fact that he was contemporary with him, relates many stories characteristic of his temper and habits. He kept up a court at Isfahan which surprised and delighted his foreign visitors, among whom were ambassadors from European states, and one learned writer, Kæmpler, credits

¹ Malcolme.

him with wisdom and good policy. During his reign Khorasan was invaded by the ever-encroaching Uzbeks, the Kipchak Tatars plundered the shores of the Caspian, and the island of Kishm was taken by the Dutch; but the kingdom suffered otherwise no material loss. He died in 1694, in the forty-ninth year of his age and twenty-sixth of his reign.

About a year before his death, he is described by Sanson,² a missionary from the French king Louis XIV., as tall, strong and active, "a fine prince—a little too effeminate for a monarch," with "a Roman nose very well proportioned to other parts," very large blue eyes, and "a midling mouth, a beard painted black, shav'd round, and well turn'd, even to his ears." The same writer greatly praises him for his kindness to Christian missionaries.

Krusinski's memoir is full of particulars regarding Shah Hosain, the successor of Suleiman. He had an elder and a younger brother, sons of the same mother, but the *Hosain* eldest had been put to death by his father's orders, and the youngest secreted by maternal precaution lest a similar fate should overtake him. There was, however, a second candidate for power in the person of a half-brother, 'Abbas. The latter prince was the worthier of the throne, but the other better suited the policy of the eunuchs and those noblemen who had the right of election. Indeed Suleiman himself is reported to have told the grandees around him, in his last days, that "if they were for a martial king that would always keep his foot in the stirrup they ought to choose Mirza 'Abbas, but that if they wished for a peaceable reign and a pacific king they ought to fix their eyes upon Hosain." But he himself made no definite choice.

Hosain was selected, as might have been anticipated. On his accession (1694) he displayed his attachment to religious observances by prohibiting the use of wine—causing all wine-vessels to be brought out of the royal cellars and destroyed, and forbidding the Armenians to sell any more of their stock in Isfahan. The shah's grandmother, by feigning herself sick and dependent upon wine only for cure, obtained reversal of the edict. For the following account of Shah Hosain and his successors to the accession of Nadir Shah, Sir Clements Markham's account has been mainly utilised.

The new king soon fell under the influence of mullahs, and was led so far to forget his own origin as to persecute the Sunnis. Though good-hearted he was weak and licentious; and once out of the hands of the fanatical party he became ensnared by women and entangled in harem intrigues. For twenty years a profound peace prevailed throughout the empire, but it was the precursor of a terrible storm destined to destroy the Safawid dynasty and scatter calamity broadcast over Persia. In the mountainous districts of Kandahar and Kabul the hardy tribes of Afghans had for centuries led a wild and almost independent life. They were divided into two great branches—the Ghilzais of Ghazni and Kabul and the Saduzais of Kandahar and Herat. In 1702 a newly-appointed governor, one Shah Nawaz, called Gurji Khan from having been "wali" or ruler of Georgia, arrived at Kandahar with a tolerably large force. He was a clever and energetic man, and had been instructed to take severe measures with the Afghans, some of whom were suspected of intriguing to restore the city to the Delhi emperor. At this time Kandahar had been for sixty years uninterruptedly in the shah's possession. The governor appears to have given great offence by the harshness of his proceedings, and a Ghilzai chief named Mir Wa'iz, who had complained of his tyranny, was sent a prisoner to Isfahan. This person had much ability and no little cunning. He was permitted to go on a pilgrimage to Mecca, and on his return in 1708 he so gained upon the confidence of the Persian court that he was allowed to go back to his country. At Kandahar he planned a conspiracy against the government, slew Gurji Khan and his retinue, seized the city, defeated two Persian armies sent against him, and died a natural death in 1715. His brother, Mir Abdallah, succeeded him in the government of the Afghans; but after a few months, Mahmud, a son of Mir Wa'iz, a very young man, murdered his uncle and assumed the title of a sovereign prince.

In the meanwhile the Saduzai tribe revolted at Herat, and declared itself independent in 1717; the Kurds overran the country round Hamadan; the Uzbeks desolated Khorasan; and the Arabs of Muscat seized the island of Bahrein and threatened Bander Abbas. Thus surrounded by dangers on all sides the wretched shah was bewildered. He made one vain attempt to regain his possessions in the Persian

² Present State of Persia (London, 1695).

Gulf; but the Portuguese fleet which had promised to transport his troops to Bahrein was defeated by the imam of Muscat and forced to retreat to Goa.

The court of Isfahan had no sooner received tidings of this disaster than Mahmud, with a large army of Afghans, invaded

Afghans Persia in the year 1721, seized Kermán, and in the following year advanced to within four days' march of the city of Isfahan. The shah offered him a sum of money to return to Kandahar, but the Afghan answered by advancing to a place called Gulnabad, within 8 m. of the capital. The ill-disciplined Persian army, hastily collected, advanced to attack the rebels. Its centre was led by Sheikh 'Ali Khan, covered by twenty-four field-pieces. The wall of Arabia commanded the right, and the 'Itimadu' d-daulah, or prime minister, the left wing. The whole force amounted to 50,000 men, while the Afghans could not count half that number.

On the 8th of March 1722 the richly dressed hosts of Persia appeared before the little band of Afghans, who were scorched and disfigured by their long marches. The wall of Arabia commenced the battle by attacking the left wing of the Afghans with great fury, routing it, and plundering their camp. The prime minister immediately afterwards attacked the enemy's right wing, but was routed, and the Afghans, taking advantage of the confusion, captured the Persian guns and turned them on the Persian centre, who fled in confusion without striking a blow. The wall of Arabia escaped into Isfahan, and Mahmud the Afghan gained a complete victory. Fifteen thousand Persians remained dead on the field. A panic now seized on the surrounding inhabitants, and thousands of country people fled into the city. Isfahan was then one of the most magnificent cities in Asia, containing more than 600,000 inhabitants. Mahmud seized on the Armenian suburb of Julfa, and invested the doomed city; but Tahmasp, son of the shah, had previously escaped into the mountains of Mazandaran. Famine soon began to press hard upon the besieged, and in September Shah Hosain offered to capitulate. Having been conducted to the Afghan camp, he fixed the royal plume of feathers on the young rebel's turban

Mahmud's with his own hand; and 4000 Afghans were ordered to *Usurpation.* occupy the palace and gates of the city.¹ Mahmud entered Isfahan in triumph, with the captive shah on his left hand, and, seating himself on the throne in the royal palace, he was saluted as sovereign of Persia by the unfortunate Hosain. When Tahmasp, the fugitive prince, received tidings of the abdication of his father, he at once assumed the title of shah at Karvin.

Turkey and Russia were not slow to take advantage of the calamities of Persia. The Turks seized on Tiflis, Tabriz and Hamadan, while Peter the Great, whose aid had been sought by the friendless Tahmasp, fitted out a fleet on the Caspian.² The Russians occupied Shirvan, and the province of Gilan south-west of the Caspian,³ and Peter made a treaty with Tahmasp II. in July 1722, by which he agreed to drive the Afghans out of Persia on condition that Darband (Derbend), Baku, Gilan, Mazandaran and Astarabad were ceded to Russia in perpetuity. These were all the richest and most important northern provinces of Persia.

Meanwhile the invader, in 1723, invited 300 of the principal Persian nobility to a banquet and massacred them. To prevent their children rising up in vengeance they were all murdered also. Then he proceeded to slaughter vast numbers of the citizens of Isfahan, until the place was nearly depopulated. Not content with this, in February 1725 he assembled all the captives of the royal family, except the shah, in the courtyard of the palace, and caused them all to be murdered, commencing the massacre with his own hand. The wretched Hosain was himself wounded in endeavouring vainly to save his infant son, only five years of age. All the males of the royal family, except Hosain himself, Tahmasp, and two children, are said to have perished. At length the inhuman miscreant Mahmud died, at the early age of twenty-seven, on the 22nd of April 1725. With scarcely any neck, he had round shoulders, a broad face with a flat nose, a thin beard, and squinting eyes, which were generally downcast.

Mahmud was succeeded by his first cousin, Ashraf, the son of Mir 'Abdallah. He was a brave but cruel Afghan. He gave the dethroned shah a handsome allowance, and strove, by a mild policy, to acquire popularity. In 1727, after a short war, he signed a treaty with the Turks, acknowledging the sultan as chief of the Moslems. But the fortunate star of Tahmasp II. was now beginning to rise, and the days of Afghan usurpation were numbered. He had collected a small army in Mazandaran, and was supported by Fath 'Ali Khan, the powerful chief of the Kajar tribe. In 1727

the fugitive shah was joined by Nadir Kuli, a robber chief, who murdered Fath 'Ali, and, having easily appeased the shah, received the command of the royal army. In 1729 Ashraf became alarmed, and led an Afghan army into Khorasan, where he was defeated by Nadir at Damghan, and forced to retreat. The Persian general followed close in his rear and again defeated him outside Isfahan in November of the same year. The Afghans fled through the town; and Ashraf, murdering the poor old shah Hosain on his way, hurried with the wreck of his army towards Shiraz. On the 16th of November the victorious Nadir entered Isfahan, and was soon followed by the young shah Tahmasp II., who burst into tears when he beheld the ruined palace of his ancestors. His mother, who had escaped the numerous massacres by disguising herself as a slave and performing the most degrading offices, now came forth and threw herself into his arms. Nadir did not give his enemies time to recover from their defeat. He followed them up, and again utterly routed them in January 1730. Ashraf tried to escape to Kandahar almost alone, but was murdered by a party of Baluch robbers; and thus, by the genius of Nadir, his native land was delivered from the terrible Afghan invaders.

The ambition of Nadir, however, was far greater than his loyalty. On pretext of incapacity, he dethroned Tahmasp II. in 1732, and sent him a prisoner into Khorasan, where he was murdered some years afterwards by Nadir's son while the conqueror was absent on his Indian expedition. For a short time the wily usurper placed Tahmasp's son on the throne, a little child, with the title of 'Abbas III., while he contented himself with the office of regent. Poor little 'Abbas died at a very convenient time, in the year 1736, and Nadir then threw off the mask. He was proclaimed shah of Persia by a vast assemblage on the plain of Moghan.

By the fall of the Safawid dynasty Persia lost her race of national monarchs, considered not only in respect of origin and birthplace but in essence and in spirit. Isma'il, Tahmasp and 'Abbas, whatever their faults and failings, were Persian and peculiar to Persians. Regarded in a sober English spirit, the reign of the great 'Abbas is rendered mythical by crime. But something liberal in the philosophy of their progenitors threw an attractiveness over the earlier Safawid kings which was wanting in those who came after them. The fact is that, two centuries after Shah Isma'il's accession to the throne, the Safawid race of kings was effete; and it became necessary to make room for a more vigorous if not a more lasting rule. Nadir was the strong man for the hour and occasion. He had been designated a "robber chief"; but his antecedents, like those of many others who have filled the position, have redeeming points of melodramatic interest.

A map attached to Krusinski's volumes illustrates the extent of Persian territory in 1728, or one year before Ashraf was finally defeated by Nadir, and some eight years prior to the date on which Nadir was himself proclaimed king. *Persia to 1728.* It shows, during the reign of the Safawids, Tiflis, Erivan, Khoi and Bagdad to have been within the limits of Persia on the west, and in like manner Balkh and Kandahar to have been included within the eastern border. There is, however, also shown, as a result of the Afghan intrusion and the impotency of the later Safawid kings, a long broad strip of country to the west, including Tabriz and Hamadan, marked "conquests of the Turks," and the whole west shore of the Caspian from Astrakhan to Mazandaran marked "conquests of the czar of Muscovy"; Makran, written Mocran, is designated "a warlike independent nation." If further allowance be made for the district held by the Afghan invaders as part of their own country, it will be seen how greatly the extent of Persia proper was reduced, and what a work Nadir had before him to restore the kingdom to its former proportions.

But the former proportions had been partly reverted to, and would doubtless have been in some respects exceeded, both in Afghanistan and the Ottoman dominions and on the shores of the Caspian, by the action of this indefatigable general, had not Tahmasp II. been led into a premature treaty with the Turks. Nadir's anger and indignation had been great at this weak proceeding; indeed, he had made it the ostensible cause of the shah's deposition. He had addressed letters to all the military chiefs of the country, calling upon them for support; he had sent an envoy to Constantinople insisting upon the sultan's restoration of the Persian provinces still in his possession—that is,

¹ We have an account of the Afghan invasion and sack of Isfahan from an eye-witness, Father Krusinski, procurator of the Jesuits at that place, whose interesting work was translated into English in the last century.

² In 1721 Sultan Hosain sent an embassy to the Russians, seeking aid against the Afghans. In May 1722 a flotilla descended the Volga commanded by Tsar Peter and on the 19th of July the Russian flag first waved over the Caspian. Gilan was occupied by 6000 men under General Matushkin.

³ The Russians remained in Gilan until 1734, when they were obliged to evacuate it, owing to the unhealthiness of the climate.

Georgia and part of Azerbaijan—and he had threatened Bagdad with assault. As regent, he had failed twice in taking the city of the caliphs, but on the second occasion he had defeated and killed its gallant defender, Topal Othman, and he had succeeded in regaining Tiflis, Kars and Erivan.¹

Russia and Turkey, naturally hostile to one another, had taken occasion of the weakness of Persia to forget their mutual quarrels and unite to plunder the tottering kingdom of the Safawid kings. A partition treaty had been signed between these two powers in 1723, by which the czar was to take Astarabad, Mazandaran, Gilan, part of Shirvan and Daghistan, while the acquisitions of the Porte were to be traced out by a line drawn from the junction of the Aras and Kur rivers, and passing along by Ardebil, Tabriz and Hamadan, and thence to Kermanshah. Tahmasp was to retain the rest of his paternal kingdom on condition of his recognizing the treaty. The ingenious diplomacy of Russia in this transaction was manifested in the fact that she had already acquired the greater part of the territory allotted to her, while Turkey had to obtain her share by further conquest. But the combination to despoil a feeble neighbour was outwitted by the energy of a military commander of a remarkable type.

D.—From the Accession of Nadir Shah, in 1736, to 1884.

Nadir, it has been said, was proclaimed shah in the plains of Moghan in 1736. Mirza Mahdi relates how this event was brought about by his address to the assembled nobles and officers on the morning of the "Nau-ruz," or Persian New-Year's Day, the response to that appeal being the offer of the crown. The conditions were that the crown should be hereditary in his family, that the claim of the Safawids was to be held for ever extinct, and that measures should be taken to bring the Shi'ites to accept uniformity of worship with the Sunnites. The mulla bashi (or high priest) objecting to the last, Nadir ordered him to be strangled, a command which was carried out on the spot. On the day following, the agreement having been ratified between sovereign and people, he was proclaimed emperor of Persia. At Kazvin the ceremony of inauguration took place. The edict expressing the royal will on the religious question is dated in June, but the date of coronation is uncertain. From Kazvin Nadir moved to Isfahan, where he organized an expedition against Kandahar, then in the possession of a brother of Mahmud, the conqueror of Shah Hosain. But before setting out for Afghanistan he took measures to secure the internal quiet of Persia, attacking and seizing in his stronghold the chief of the marauding Bakhtiaris, whom he put to death, retaining many of his men for service as soldiers. With an army of 80,000 men he marched through Khorasan and Seistan to Kandahar, which city he blockaded ineffectually for a year; but it finally capitulated on the loss of the citadel. Balkh fell to Riza Kuli, the king's son, who, moreover, crossed the Oxus and defeated the Uzbegs in battle. Besides tracing out the lines of Nadirabad, a town since merged in modern Kandahar, Nadir had taken advantage of the time available and of opportunities presented to enlist a large number of men from the Abdali and Ghilzai tribes. It is said that as many as 16,000 were at his disposal. His rejection of the Shi'ite tenets as a state religion seems to have propitiated the Sunnite Afghans.

Nadir had sent an ambassador into Hindustan requesting the Mogul emperor to order the surrender of certain unruly Afghans who had taken refuge within Indian territory, but no satisfactory reply was given, and obstacles were thrown in the way of the return of the embassy. The Persian monarch, not sorry perhaps to find a plausible pretext for encroachment in a quarter so full of promise to booty-seeking soldiers, pursued some of the fugitives through Ghazni to Kabul, which city was then under the immediate control of Nasr Khan, governor of eastern Afghanistan, for Mahommed Shah of Delhi. This functionary, alarmed at the near approach of the Persians, fled to Peshawar. Kabul had

¹ Malcolin.

long been considered not only an integral part but also one of the main gates of the Indian Empire; notwithstanding a stout resistance on the part of its commandant, Shir or Shirzah Khan, the place was stormed and carried (1738) by Nadir, who moved on eastward. Mirza Mahdi relates that from the Kabul plain he addressed a new remonstrance to the Delhi court, but that his envoy was arrested and killed, and his escort compelled to return by the governor of Jalalabad. The same authority notes the occupation of the latter place by Persian troops and the march thither from Gandamak. It was probably through the Khaibar (Khyber) Pass that he passed into the Peshawar plain, for it was there that he first defeated the Imperial force.

The invasion of India had now fairly commenced, and its successful progress and consummation were mere questions of time. The prestige of this Eastern Napoleon was immense. It had not only reached but had been very keenly felt at Delhi before the conquering army had arrived. There was no actual religious war; all sectarian distinction had been disavowed; the contest was between vigorous Mahommedans and effete Mahommedans. Nadir's way had been prepared by circumstances, and as he progressed from day to day his army increased. There must have been larger accessions by voluntary recruits than losses by death or desertion. The victory on the plain of Karnal, whether accomplished by sheer fighting or the intervention of treachery, was the natural outcome of the previous situation, and the submission of the emperor followed as a matter of course.

Delhi must have experienced a sense of relief at the departure of its conqueror, whose residence there had been rendered painfully memorable by carnage and riot. The marriage of his son to the granddaughter of Aurangzeb and the formal restoration of the crown to the dethroned emperor were doubtless politic, but the descendant of Babar could not easily forget how humiliating a chapter in history would remain to be written against him. The return march of Nadir to Persia is not recorded with precision. On the 5th of May 1739 he left the gardens of Shalamar, and proceeded by way of Lahore and Peshawar through the passes to Kabul. Thence he seems to have returned to Kandahar, and in May 1740—just one year after his departure from Delhi—he was in Herat displaying the imperial throne and other costly trophies to the gaze of the admiring inhabitants. Sind was certainly included in the cession to him by Mahommed Shah of "all the territories westward of the river Attok," but only that portion of it, such as Thattah (Tatta), situated on the right bank of the Indus.

From Herat he moved upon Balkh and Bokhara, and received the submission of Abu'l-Fais Khan, the Uzbek ruler, whom he restored to his throne on condition that the Oxus should be the acknowledged boundary between the ^{Northern} ~~Central~~ two empires. The khan of Khwarizm, who had made repeated depredations in Persian territory, was taken prisoner and executed. Nadir then visited the strong fortress of Kelat, to which he was greatly attached as the scene of his boyish exploits, and Meshed, which he constituted the capital of his empire. He had extended his boundary on the east to the Indus, and to the Oxus on the north.

On the south he was restricted by the Arabian Ocean and Persian Gulf; but the west remained open to his further progress. He had in the first place to revenge the death of his brother Ibrahim Khan, slain by a stray assailant; ^{Wars in the} ~~West~~ Lesghians; and a campaign against the Turks might follow in due course. The first movement was unsuccessful, and indirectly attended with disastrous consequences. Nadir, when hastening to the support of some Afghan levies who were doing good service, was fired at and wounded by a stray assailant; suspecting his son, Riza Kuli, of complicity, he commanded the unfortunate prince to be seized and deprived of sight. From that time the heroism of the monarch appeared to die out. He became morose, tyrannical and suspicious. An easy victory over the Turks gave him but little additional glory; and he readily concluded a peace with the sultan which brought but

insignificant gain to Persia.¹ Another battle won from the Ottoman troops near Diarbekr by Nasr Ullah Mirza, the young prince who had married a princess of Delhi, left matters much the same as before.

The last years of Nadir's life were full of internal trouble. On the part of the sovereign, murders and executions; on that of his subjects, revolt and conspiracy. Such a state of things could not last, and certain proscribed persons plotted the destruction of the half-demented tyrant. He was despatched by Salah Bey, captain of his guards (1747). He was some sixty years of age, and had reigned eleven years. About the time of setting out on his Indian expedition he was described as a most comely man, upwards of 6 ft., tall, well-proportioned, of robust make and constitution; inclined to be fat, but prevented by the fatigue he underwent; with fine, large black eyes and eyebrows; of sanguine complexion, made more manly by the influence of sun and weather; a loud, strong voice; a moderate wine-drinker; fond of simple diet, such as pilaos and plain dishes, but often neglectful of meals altogether, and satisfied, if occasion required, with parched peas and water, always to be procured.²

During the reign of Nadir an attempt was made to establish a British Caspian trade with Persia. The names of Jonas Hanway and John Elton were honourably connected with this undertaking; and the former has left most valuable records of the time and country.

From Nadir Shah to the Kajar Dynasty.—After the death of Nadir Shah something like anarchy prevailed for thirteen years

Period of Anarchy. in the greater part of Persia as it existed under Shah 'Abbas. No sooner had the crime become known than Ahmad Khan, chief of the Abdali Afghans, took possession of Kandahar and a certain amount of treasure. By the action of Ahmad Abdali, Afghanistan was at once lost to the Persian crown, for this leader was strong enough to found an independent kingdom. The chief of the Bakhtiari, Rashid, also with treasure, fled to the mountains, and the conspirators invited 'Ali, a nephew of the deceased monarch, to ascend the vacant throne. The Bakhtiari encouraged his brother, 'Ali Mardan, to compete for the succession to Nadir. The prince was welcomed by his subjects; he told them that the murder of his uncle was due to his own instigation, and, in order to conciliate them, remitted the revenues of the current year and all extraordinary taxes for the two years following.

Taking the title of 'Adil Shah, or the "just" king, he commenced his reign by putting to death the two princes Riza Kuli and Nasr Ullah, as well as all relatives whom he considered his competitors, with the exception of Shah Rukh, son of Riza Kuli, whom he spared in case a lineal descendant of Nadir should at any time be required. But he had not removed all dangerous members of the royal house, nor had he gauged the temper of the times or people. 'Adil Shah was soon dethroned by his own brother, Ibrahim, and he in his turn was defeated by the adherents of Shah Rukh, who made their leader king.

This young prince had a better and more legitimate title than that of the grandson of Nadir, for he was also grandson, *Shah Rukh* on the mother's side, of the Safawid Shah Husain. Amiable, generous and liberal-minded, and of prepossessing exterior, he proved to be a popular prince. But he was neither of an age nor character to rule over a people led by turbulent and disaffected chiefs, ever divided by the conflicting interests of personal ambition. Sa'id Mahommed, son of Mirza Daud, a chief mullah at Meshed, whose mother was the reputed daughter of Suleiman, declared himself king, and imprisoned and blinded Shah Rukh. Yusuf 'Ali, the general commanding the royal troops, defeated and slew Suleiman, and replaced his master on the throne, reserving to himself the protectorship or regency. A new combination of chiefs, of which J'afir the Kurd and Mir 'Alam the Arabian are the

principal names handed down, brought about the death of Yusuf 'Ali and the second imprisonment of Shah Rukh. These events were followed by a quarrel terminating in the supremacy of the Arab. At this juncture Ahmad Shah Abdali reappeared in Persian Khorasan from Herat; he attacked and took possession of Meshed, slew Mir 'Alam, and, pledging the local chiefs to support the blinded prince in retaining the kingdom of his grandfather, returned to Afghanistan. But thenceforward this unfortunate young man was a mere shadow of royalty, and his purely local power and prestige had no further influence whatever on Persia as a country.

The land was partitioned among several distinguished persons, who had of old been biding their opportunities, or were born of the occasion. Foremost among these was Mahommed Hasan Khan, hereditary chief of those Kajars *Further Confusion.* who were established in the south-east corner of the Caspian. His father, Fath 'Ali Khan, after sheltering Shah Tahmasp II. at his home in Astarabad, and long acting as one of his most loyal supporters, had been put to death by Nadir, who had appointed a successor to his chiefdom from the "Yukari" or "upper" Kajars, instead of from his own, the "Ashagha," or "lower." Mahommed, with his brother, had fled to the Turkomans, by whose aid he had attempted the recovery of Astarabad, but had not succeeded in regaining a permanent footing there until Nadir had been removed. On the murder of the tyrant he had raised the standard of independence, successfully resisted Ahmad Shah and his Afghans, who sought to check his progress in the interests of Shah Rukh, and eventually brought under his own sway the valuable provinces of Gilan, Mazandaran and Astarabad⁴—quite a little kingdom in itself. In the large important province of Azerbaijan, Azad Khan, one of Nadir's generals, had established a separate government; and 'Ali Mardan, brother of the Bakhtiari chief, took forcible possession of Isfahan, empowering Shah Rukh's governor, Abu'l-Fath Khan, to act for the new master instead of the old.

Had 'Ali Mardan declared himself an independent ruler he would have been by far the most important of the three persons named. But such usurpation at the old Safawid capital would have been too flagrant an act for general assent; so he put forward Isma'il, a nephew of Shah Husain, as the representative of sovereignty, and himself as one of his two ministers—the other being Karim Khan, a chief of the Zend Kurds. Shah Isma'il, it need scarcely be said, possessed no real authority; but the ministers were strong men in their way, and the Zend especially had many high and excellent qualities. After a time 'Ali Mardan was assassinated, and Karim Khan became the sole living power at Isfahan. The story of the period is thus told by R. G. Watson:—

"The three rivals, Karim, Azad and Muhammad Hasan, proceeded to settle, by means of the sword, the question as to which of them was to be the sole master of Persia. A three-sided war then ensued, in the course of which each of the combatants in turn seemed at one time sure to be the final conqueror. Karim, when he had arranged matters at Isfahan, marched to the borders of Mazandaran, where the governor of that province was ready to meet him. After a closely contested battle victory remained with Muhammad Hasan; who, however, was unable to follow up the foe, as he had to return in order to encounter Azad. That leader had invaded Gilan, but on the news reaching him of the victory which the governor of Mazandaran had gained, he thought it prudent to retrace his steps to Sulzaniyah. Karim reunited his shattered forces at Tehran, and retired to Isfahan to prepare for a second campaign. When he again took the field it was not to measure himself once more with the Kajar chief, but to put down the pretensions of Azad. The wary Afghan, however, shut himself up in Karvin, a position from which he was enabled to inflict much injury on the army of Karim, while his own troops remained unharmed, behind the walls of the town. Karim retired a second time to

¹Creasy says the war broke out in 1743, but was terminated in 1746 by a treaty which made little change in the old arrangements fixed under Murad IV.

²Fraser's *History of Nadir Shah* (1742).

³There were three branches of the Kajar tribe, i.e. the Sulduz, Tuuglut and Jalaiyar. The last, according to Watson, became settled in Iran and Turan, and seem at first to have given their name to all the tribe.

⁴Watson. Mahommed says that Gilan was under one of its own chiefs, Hidaiyat Khan.

Ispahan, and in the following spring advanced again to meet Azad. A pitched battle took place between them, in which the army of Karim was defeated. He retreated to the capital, closely pressed by the foe. Thence he continued his way to Shiraz, but Azad was still upon his traces. He then threw himself upon the mercy of the Arabs of the Garmisir or hot country, near the Persian Gulf, to whom the name of the Afghans was hateful, and who rose in a body to turn upon Azad. Karim, by their aid, once more repaired his losses and advanced on Ispahan, while Muhammad Hasan with fifty thousand men was coming from the opposite direction, ready to encounter either the Afghan or the Zend. The Afghan did not await his coming, but retired to his government of Tabriz.

"The Zend issued from Ispahan, and was a second time defeated in a pitched battle by the Kajar. Karim took refuge behind the walls of Shiraz, and all the efforts of the enemy to dislodge him were ineffectual. Muhammad Hasan Khan in the following year turned his attention to Adarbajjan. Azad was no longer in a position to oppose him in the field, and he in turn became master of every place of importance in the province, while Azad had to seek assistance in vain—first from the pasha of Baghdad, and then from his former enemy, the tsar of Georgia. Next year the conquering Kajar returned to Shiraz to make an end of the only rival who now stood in his way. On his side were 80,000 men, commanded by a general who had twice defeated the Zend chief on an equal field. Karim was still obliged to take shelter in Shiraz, and to employ artifice in order to supply the place of the force in which he was deficient. Not were his efforts in this respect unattended with success: seduced by his gold, many of the troops of the Kajar began to desert their banners. In the meantime the neighbourhood of Shiraz was laid waste, so as to destroy the source from which Muhammad Hasan drew his provisions; by degrees his army vanished, and he had finally to retreat with rapidity to Ispahan with the few men that remained to him. Finding his position there to be untenable, he retreated still farther to the country of his own tribe, while his rival advanced to Ispahan, where he received the submission of nearly all the chief cities of Persia. The ablest of Karim's officers, Shaikh 'Ali, was sent in pursuit of the Kajar chief. The fidelity of the commander to whom that chieftain had confided the care of the pass leading into Mazandarân, was corrupted; and, as no further retreat was open to him, he found himself under the necessity of fighting. The combat which ensued resulted in his complete defeat, although he presented to his followers an example of the most determined valour. While attempting to effect his escape he was recognized by the chief of the other branch of the Kajar tribe, who had deserted his cause, and who had a blood-feud with him, in pursuance of which he now put him to death.

"For nineteen years after this event Karim Khan ruled with the title of wâkîl, or regent, over the whole of Persia, excepting the *Karim Khan* province of Khurâsân. He made Shiraz the seat of his government, and by means of his brothers put down every attempt which was made to subvert his authority. The rule of the great Zend chief was just and mild, and he is on the whole, considering his education and the circumstances under which he was placed, one of the most faultless characters to be met with in Persian history."

Karim Khan died at his capital in 1779 in the twentieth year of his reign, and, it is said, in the eightieth of his age. He built the great bazaar of Shiraz, had a tomb constructed over the remains of Hafiz, and repaired the "turbat" at the grave of Sa'di, outside the walls. He encouraged commerce and agriculture, gave much attention to the shores of the Persian Gulf, and carefully studied the welfare of the Armenian community settled in his dominions. In his time the British factory was removed from Bander Abbasi to Bushire.

On Karim's death a new period of anarchy supervened. His brother, Zaki, a cruel and vindictive chief who, when governor of Ispahan, had revolted against Karim, assumed the government. At the same time he proclaimed Abu 'l-Fath Khan, second son of the deceased monarch, and his brother Mahmomed 'Ali, joint-successors to the throne. The seizure of the citadel at Shiraz by the adherents of the former, among whom were the more influential of the Zends, may have induced him to adopt this measure as one of prudent conciliation. But the garrison held out, and, to avoid a protracted siege, he had recourse to treachery. The suspicious nobles were solemnly adjured to trust themselves to his keeping, under promise of forgiveness. They believed his professions, tendered their submission, and were cruelly butchered. Zaki did not long enjoy the fruits of his perfidious dealing. The death of Karim Khan had raised two formidable adversaries to mar his peace.

Aga Mahmomed, son of Mahmomed Hasan, the Kajar chief of Astarabad, a prisoner at large in Shiraz, was in the environs

of that city awaiting intelligence of the old king's decease, and, hearing it, instantly escaped to Mazandarân, there to gather his tribesmen together and compete for the crown of Persia. Taken prisoner by Nadir and barbarously mutilated by 'Adil Shah, he had afterwards found means to rejoin his people, but had surrendered himself to Karim Khan when his father was killed in battle. On the other hand, Sadik, brother to Zaki, who had won considerable and deserved repute by the capture of Basra from the Turkish governor, abandoned his hold of the conquered town on hearing of the death of Karim, and appeared with his army before Shiraz. To provide against the intended action of the first, Zaki detached his nephew, 'Ali Murad, at the head of his best troops to proceed with all speed to the north; and, as to the second, the seizure of such families of Sadik's followers as were then within the walls of the town, and other violent measures, struck such dismay into the hearts of the besieging soldiers that they dispersed and abandoned their leader to his fate. From Kermân, however, where he found an asylum, the latter addressed an urgent appeal for assistance to 'Ali Murad. This chief, encamped at Teherân when the communication reached him, submitted the matter to his men, who decided against Zaki, but put forward their own captain as the only master they would acknowledge. 'Ali Murad, leaving the pursuit of Aga Mahmomed, then returned to Ispahan, where he was received with satisfaction, on the declaration that his one object was to restore to his lawful inheritance the eldest son of Karim Khan, whom Zaki had set aside in favour of a younger brother. The sequel is full of dramatic interest. Zaki, enraged at his nephew's desertion, marched out of Shiraz towards Ispahan. On his way he came to the town of Yazdikhabast, where he demanded a sum of money from the inhabitants, claiming it as part of secreted revenue; the demand was refused, and eighteen of the head men were thrown down the precipice beneath his window; a "saiyid," or holy man, was the next victim, and his wife and daughter were to be given over to the soldiery, when a suddenly-formed conspiracy took effect, and Zaki's own life was taken in retribution for his guilt (1779).

When intelligence of these events reached Kermân, Sadik Khan hastened to Shiraz, proclaimed himself king in place of Abu 'l-Fath Khan, whom he declared incompetent to reign, and put out the eyes of the young prince. He despatched his son Ji'afir to assume the government of Ispahan, and watch the movements of 'Ali Murad, who appears to have been then absent from that city; and he gave a younger son, 'Ali Naki, command of an army in the field. The campaign ended in the capture of Shiraz and assumption of sovereignty by 'Ali Murad, who caused Sadik Khan to be put to death.

From this period up to the accession of Aga Mahmomed Khan the summarized history of Markham will supply the principal facts required.

'Ali Murad reigned over Persia until 1785, and carried on a successful war with Aga Mahmomed in Mazandarân, defeating him in several engagements, and occupying Teherân and Sari. He died on his way from the former place to Ispahan, and was succeeded by Ji'afir, son of Sadik, who reigned at Shiraz, assisted in the government by an able but unprincipled "kalantar," or head magistrate, named Hajji Ibrahim. This ruler was poisoned by the agency of conspirators, one of whom, Saiyid Murad, succeeded to the throne. Hajji Ibrahim, however, contriving to maintain the loyalty of the citizens towards the Zend reigning family, the usurper was killed, and Lutf 'Ali Khan, son of Ji'afir, proclaimed king. He had hastened to Shiraz on hearing of his father's death and received a warm welcome from the inhabitants. Hajji Ibrahim became his chief adviser, and a new minister was found for him in Mirza Hosain Shirazi. At the time of his accession Lutf 'Ali Khan was only in his twentieth year, very handsome, tall, graceful, and an excellent horseman. While differing widely in character, he was a worthy successor of Karim Khan, the great founder of the Zend dynasty. Lutf 'Ali Khan had not been many months on the throne when Aga Mahmomed advanced to attack him, and invested the city of Shiraz, but retreated soon afterwards to Teherân, which he had made the capital of his dominions. The young king then enjoyed a short period of peace.

¹ A five days' usurpation of Bakir Khan, governor of Ispahan, is not taken into account.

Afterwards, in 1790, he collected his forces and marched against the Kajars, in the direction of Isfahan. But Hajji Ibrahim had been intriguing against his sovereign, to whose family he owed everything, not only with his officers and soldiers but also with Aga Mahommed, the chief of the Kajars, and arch-enemy of the Zends. Lutf 'Ali Khan was suddenly deserted by the whole of his army, except seventy faithful followers; and when he retreated to Shiraz he found the gates closed against him by Hajji Ibrahim, who held the city for the Kajar chief. Thence falling back upon Bushire, he found that the sheikh of that town had also betrayed him. Surrounded by treason on every side, he boldly attacked and routed the chief of Bushire and blockaded Shiraz. His unconquerable valour gained him many followers, and he defeated an army sent against him by the Kajars in 1792.

Aga Mahommed then advanced in person against his rival. He encamped with an army of 30,000 men on the plain of Mardasht, near Shiraz. Lutf 'Ali Khan, in the dead of night, suddenly attacked the camp of his enemy with only a few hundred followers. The Kajars were completely routed and thrown into confusion; but Aga Mahommed, with extraordinary presence of mind, remained in his tent, and at the first appearance of dawn his "muezzin," or public crier, was ordered to call the faithful to morning prayer as usual. Astonished at this, the few Zend cavaliers, thinking that the whole army of Kajars had returned, fled with precipitation leaving the field in possession of Aga Mahommed. The successful Kajar then entered Shiraz, and promoted the traitor Hajji Ibrahim to be his vizier. Lutf 'Ali Khan took refuge with the hospitable chief of Tabbas in the heart of Khorasan, where he succeeded in collecting a few followers; but advancing into Fars, he was again defeated, and forced to take refuge at Kandahar.

In 1794, however, the undaunted prince once more crossed the Persian frontier, determined to make a last effort, and either regain his throne or die in the attempt. He occupied the city of Kermān, then a flourishing commercial town, half-way between the Persian Gulf and the province of Khorasan. Aga Mahommed besieged it with a large army in 1795, and, after a stout resistance, the gates were opened through treachery. For three hours the gallant young warrior fought in the streets with determined valour, but in vain. When he saw that all hope was gone he, with only three followers, fought his way through the Kajar host and escaped to Bam-Narmashir, the most eastern district of the province of Kermān on the borders of Seistan.

Furious at the escape of his rival, the savage conqueror ordered a general massacre; 20,000 women and children were sold into slavery, and 70,000 eyes of the inhabitants of Kermān were brought to Aga Mahommed on a platter.

Lutf 'Ali Khan took refuge in the town of Bam; but the governor of Narmashir, anxious to appropriate the conqueror, basely surrounded him as he was mounting his faithful horse Kuran to seek a more secure asylum. The young prince fought bravely; but, being badly wounded and overpowered by numbers, he was secured and sent to the camp of the Kajar chief. The spot where he was seized at Bam, when mounting his horse, was marked by a pyramid, formed by order of his revengeful enemy, of the skulls of the most faithful of his adherents. The most hideous indignities and atrocities were committed upon his person by the cruel Kajar, and finally he was sent to Teherān and murdered, when only in his twenty-sixth year. Every member of his family and every friend was ordered to be massacred by Aga Mahommed; and the successful miscreant thus founded the dynasty of the Kajars at the price of all the best and noblest blood of Iran.

The Zend is said to be a branch of the Lak tribe, dating from the time of the Kaianian kings, and claims to have been charged with the care of the *Zend-Avesta* by Zoroaster himself.¹ The tree attached to Markham's chapter on the dynasty contains the names of eight members of the family only, i.e. four brothers, one of whom had a son, grandson and great-grandson, and one a son. Four of the eight were murdered, one was blinded, and one cruelly mutilated. In one case a brother murdered a brother, in another an uncle blinded his nephew.

Kajar Dynasty.—Aga Mahommed was undoubtedly one of the most cruel and vindictive despots that ever disgraced a throne. But he was not without care for the honour of his empire in the eyes of Europe and the outer world, and his early career in Mazandaran gave him a deeply-rooted mistrust of Russia, with the officers of which power he was in constant contact. The following story, told by Forster,² and varied by a later writer, is characteristic. A party of Russians having obtained permission to build a "counting-house" at Ashraf,

in the bay of that name, erected instead a fort with eighteen guns. Aga Mahommed, learning the particulars, visited the spot, expressed great pleasure at the work done, invited the officers to dine with him, imprisoned ^{Aga Mahommed.} them, and only spared their lives when they had removed the whole of the cannon and razed the fort to the ground. This occurrence must have taken place about 1782.

Forster was travelling homeward by the southern shores of the Caspian in January 1784, and from him we gather many interesting details of the locality and period. He calls Aga Mahommed chief of Mazandaran, as also of Astabad and "some districts situate in Khurasan," and describes his tribe the Kajar, to be, like the Indian Rajput, usually devoted to the profession of arms. Whatever hold his father may have had on Gilan, it is certain that this province was not then in the son's possession, for his brother, Ji'nfir Kuli, governor of Balfrosh (Balfroosh), had made a recent incursion into it and driven Hidayat Khan, its ruler, from Resht to Enzell, and Aga Mahommed was himself meditating another attack on the same quarter. The latter's palace was at Sari, then a small and partly fortified town, thickly inhabited, and with a plentifully-supplied market. As "the most powerful chief in Persia" since the death of Karim Khan, the Russians were seeking to put their yoke upon him.

As Aga Mahommed's power increased, his dislike and jealousy of the Muscovite assumed a more practical shape. His victory over Lutf 'Ali was immediately followed by an *Campaign against Georgia.* expedition into Georgia. After the death of Nadir the wali of that country had looked around him for the safest means of shaking off the yoke of Persia; and in course of time an opportunity had offered of a promising kind. In 1783, when the strength of the Persian monarchy was concentrated upon Isfahan and Shiraz, the Georgian tsar, Heraclius entered into an agreement with the empress Catherine by which all connexion with the shah was disavowed, and a quasi-vassalage to Russia substituted—the said empire extending her aegis of protection over her new ally. Aga Mahommed now demanded that Heraclius should return to his position of tributary and vassal to Persia, and, as his demand was rejected, prepared for war. Dividing an army of 60,000 men into three corps, he sent one of these into Daghestan, another was to attack Erivan, and with the third he himself laid siege to Shusha in the province of Karabakh. The stubborn resistance offered at the last-named place caused him to leave there a small investing force only, and to move on with the remainder of his soldiers to join the *corps d'armée* at Erivan. Here, again, the difficulties presented caused him to repeat the same process and to effect a junction with his first corps at Ganja, the modern Elisavetpol. At this place he encountered the Georgian army under Heraclius, defeated it, and marched upon Tiflis, which he pillaged, massacring and enslaving³ the inhabitants. Then he returned triumphant to Teherān, where (or at Ardebil on the way) he was publicly crowned shah of Persia. Erivan surrendered, but Shusha continued to hold out. These proceedings caused Russia to enter the field. Derbent was taken possession of by Imhov, Baku and Shumakhy were occupied and Gilan was threatened. The death of the empress, however, caused the issue of an order to retire, and Derbent and Baku remained the only trophies of the campaign.

In the meantime Aga Mahommed's attention had been called away to the east. Khorasan could hardly be called an integral part of the shah's kingdom: so long as it was under *Operations even the nominal rule of the blind grandson of his* Nadir. But the eastern division of the province *Khorasan.* and its outlying parts were actually in the hands of the Afghans, and Meashd was not Persian in 1796 in the sense that Delhi was British at the outbreak of the Indian Mutiny. Shah Rukh held his position, such as it was, rather under Ahmad

¹ Markham. Morier says of Karim Khan's family, "it was a low branch of an obscure tribe in Kurdistan."

² *Journey from Bengal to England* (1798), ii. 201; see also Markham, pp. 341, 342.

³ Lady Sheil says (1849): "I saw a few of these unhappy captives who all had to embrace Mahomedanism, and many of whom had risen to the highest stations, just as the Circassian slaves in Constantinople."

Shah and his successors in Afghanistan than under any other sovereign power. Aga Mahommed determined to restore the whole province to Persia, and, after a brief residence in Teherán on his return from the Georgian expedition, he set out for Meshed. It is important to note that on the occasion of his coronation he had girded on the sabre consecrated at the tomb of the founder of the Safawid—thus openly pledging himself to support the Shi'ite faith.

But there had been continual dissatisfaction in the capital of Khorasan, and constant inroads upon it from without, which the royal puppet was unable to prevent. His popularity was real, but never seemed to have effect outside the limited sphere of personal sympathy and regard. Owing to the frequent revolutions in the holy city the generals of Timur Shah, king of the Afghans, had made three expeditions on Shah Rukh's behalf. Meshed had been taken and retaken as though he were not a resident in it, much less its *de jure* king. Moreover, his two sons Nadir Mirza and Wali Ni'amat had long been fighting, and the former was in 1796 the actual ruler of the place. Three years before Timur had died, and his third son, Zaman Shah, by the intrigues of an influential sirdar, Paiyanda Khan, and been proclaimed his successor at Kabul.

Aga Mahommed's entry into Meshed was effected without a struggle on the part of those in possession. The Kajar shah walked on foot to the tomb of Imam Riza, before which he knelt and kissed the ground in token of devotion, and was recognized as a Shi'ite of Shi'ites. Shah Rukh submissively followed in his train. Then began the last act of the local tragedy. The blind king's gradual revelation, under horrible torture, of the place of concealment of his several jewels and treasures, and his deportation and death (of the injuries thus received, at Damghan, en route to Masandaran), must be classed among the darkest records of Oriental history.

From Meshed Aga Mahommed sent an envoy to Zaman Shah, asking for the cession of Balkh, and explaining his invasion of Khorasan; but the Afghan monarch was too perplexed with the troubles in his own country and his own insecure position to do more than send an unmeaning reply. It is not shown what was the understood boundary between the two countries at this particular period; but Watson states that on the shah's departure he had received the submission of the whole of Khorasan, and left in Meshed a garrison of 12,000 men.

Aga Mahommed had now fairly established his capital at Teherán. On his return thither in September 1796 he dismissed his troops for the winter, directing their reassembly in the following spring. The re-invasion by Russia of the provinces and districts he had recently wrested from her west of the Caspian had made great progress, but the circumstance does not seem to have changed his plans for the army. Although, when the spring arrived and the shah led his forces to the Aras, the Russians had, it is true, retreated, yet territory had been regained by them as far south as the Talysh. Aga Mahommed had now arrived at the close of his career. He was enabled, with some difficulty, to get his troops across the river, and take possession of Shusha, which had given them so much trouble a year or two before. There, in camp, he was murdered (1797) by his own personal attendants—men who were under sentence of death, but allowed to be at large. He was then fifty-seven years of age, and had ruled over part of Persia for more than eighteen years—over the kingdom generally for about three years, and from his coronation for about one year only.

The brutal treatment he had experienced in boyhood under the orders of Adil Shah, and the opprobrious name of "eunuch" with which he was taunted by his enemies, no doubt contributed to embitter his nature. His contempt of luxury, his avoidance of hyperbole and dislike of excessive ceremony, his protection to commerce and consideration for his soldiers, the reluctance with which he assumed the crown almost at the close of his reign—all these would have been praiseworthy in another man; but on his death the memory of his atrocious tyranny alone survived. Those who have seen his portrait once will recognize

the face wherever presented. "Beardless and shrivelled," writes Sir John Malcolm, "it resembled that of an aged and wrinkled woman, and the expression of his countenance, at no time pleasant, was horrible when clouded, as it very often was, with indignation. He was sensible of this, and could not bear that any one should look at him."

Aga Mahommed had made up his mind that he should be succeeded by his nephew Fath 'Ali Shah, son of his full brother, Hosain Kuli Khan, governor of Fars. There was a short interval of confusion after the murder. The remains of the sovereign were exposed to insult, the army was disturbed, the recently captured fort on the left bank of the Aras was abandoned, but the wisdom and resolution of the minister, Hajji Ibrahim, and of Mirza Mahommed Khan Kajar secured order and acceptance of the duly appointed heir. The first, proclaiming his own allegiance, put himself at the head of a large body of troops and marched towards the capital. The second closed the gates of Teherán to all comers until Fath 'Ali Shah came himself from Shiraz. Though instantly proclaimed on arrival, the new monarch was not crowned until the spring of the following year (1798).

The so-called rebellions which followed were many, but not of any magnitude. Such as belong to local history are three in number, *i.e.* that of Sadik Khan Shakaki, the general whose possession of the crown jewels enabled him, after the defeat of his army at Karvin, to secure his personal safety and obtain a government; of Hosain Kuli Khan, the shah's brother, which was compromised by the mother's intervention; and of Mahommed, son of Zaki Khan, Zend, who was defeated on more than one occasion in battle, and fled into Turkish territory. Later, Sadik Khan, having again incurred the royal displeasure, was seized, confined and mercilessly bricked up in his dungeon to die of starvation.

Another adversary presented himself in the person of Nadir Mirza, son of Shah Rukh, who, when Aga Mahommed appeared before Meshed, had taken refuge with the Afghans. Fath 'Ali sent to warn him of the consequences, but without the desired effect. Finally, he advanced into Khorasan with an army which appears to have met with no opposition save at Nishapur and Turbet, both of which places were taken, and when it reached Meshed, Nadir Mirza tendered his submission, which was accepted. Peace having been further cemented by an alliance between a Kajar general and the prince's daughter, the shah returned to Teherán.

Now that the narrative of Persian kings has been brought up to the period of the consolidation of the Kajar dynasty and commencement of the 19th century, there remains but to summarize the principal events in the reigns of Fath 'Ali Shah and his immediate successors, Mahommed Shah and Nasru 'd-Din Shah.

Fath 'Ali Shah came to the throne at about thirty-two years of age, and died at sixty-eight, after a reign of thirty-six years. Persia's great aim was to recover in the north-west, as in the north-east of her empire, the geographical limits obtained for her by the Safawid kings, and this was no easy matter when she had to contend with a strong European power whose territorial limits touched her own. Fath 'Ali Shah undertook, at the outset of his reign, a contest with Russia on the western side of the Caspian, which became constant and harassing warfare. Georgia was, clearly, not to revert to a Mahomedan suzerain. In 1800 its tsar, George, son and successor of Heraclius, notwithstanding his former professions of allegiance to the shah, renounced his crown in favour of the Russian emperor. His brother Alexander indignantly repudiated the act and resisted its fulfilment, but he was defeated by General Lazarev on the banks of the Lora. Persia then re-entered the field. Among the more notable occurrences which followed were a three days' battle, fought near Echmiadzin, between the crown prince, 'Abbas Mirza, and General Zissianov, in which the Persians suffered much from the enemy's artillery, but would not admit they were defeated; unsuccessful attempts on the part of the Russian commander to get possession of Erivan; and a surprise, in camp, of the shah's forces, which caused them to disperse, and necessitated the king's own presence with reinforcements. On the latter occasion the shah is credited with gallantly swimming his horse across the Aras, and setting an example of energy and valour. In the following year 'Abbas Mirza advanced upon Shishah, the chief of which place and of the Karabagh had declared for Russia; much fighting ensued, and Erivan was formally taken possession of in the name of

Fath Ali Shah.

Rube Ross.

War with Russia.

the-shah. The Russians, moreover, made a futile attempt on Gilan by landing troops at Enzeh, which returned to Baku, where Zizianov fell a victim to the treachery of the Persian governor. Somewhat later Ibrahim Khalil of Shusha, repenting of his Russophilism, determined to deliver up the Muscovite garrison at that place, but his plans were betrayed, and he and his relatives put to death. Reprials and engagements followed with varied success; and the crown prince of Persia, after a demonstration in Shirvan, returned to Tabriz. He had practically made no progress; yet Russia, in securing possession of Derbent, Baku, Shirvan, Sheki, Ganja, the Talysh and Mughan, was probably indebted to gold as well as to the force of arms. At the same time Persia would not listen to the overtures of peace made to her by the governor-general who had succeeded Zizianov.

Relations had now commenced with England and British India. A certain Mahdi 'Ali Khan had landed at Bushire, entrusted by the governor of Bombay with a letter to the shah, and he was followed shortly by an English envoy from the governor-general, Captain Malcolm of the Madras army. He had not only to talk about the Afghans but about the French, and the trade of the Persian Gulf. The results were a political and commercial treaty, and a return mission to India from Fath 'Ali Shah. To him France next sent her message. In 1801 an Armenian merchant from Bagdad had appeared as the bearer of credentials from Napoleon, but his mission was mistrusted and came to nothing. Some five years afterwards Joubert, after detention and imprisonment on the road, arrived at Teheran and went back to Europe with a duly accredited Persian ambassador, who concluded a treaty with the French emperor at Finkenstein. On the return of the Persian diplomatist, a mission of many officers under General Gardane to instruct and drill the local army was sent from France to Persia. Hence arose the counter-mission of Sir Harford Jones from the British government, which, on arrival at Bombay in April 1808, found that it had been anticipated by a previously sent mission from the governor-general of India, under Malcolm again, then holding the rank of brigadier-general.

The home mission, however, proceeded to Bushire, and Malcolm's return thence to India enabled Sir Harford to move on and reach the capital in February 1809. A few days before his entry General Gardane had been dismissed, as the peace of Tilsit debarred France from aiding the shah against Russia. Sir Harford concluded a treaty with Persia the month after his arrival at the capital; but the government of India were not content to leave matters in his hands: notwithstanding the anomaly of a double mission, Malcolm was in 1810 again despatched as their own particular envoy. He brought with him Captains Lindsay and Christie to assist the Persians in the war, and presented the shah with some serviceable field-pieces; but there was little occasion for the exercise of his diplomatic ability save in his non-official intercourse with the people, and here he availed himself of it to the great advantage of himself and his country.¹ He was welcomed by the shah in camp at Ujani, and took leave a month afterwards to return via Bagdad and Basra to India. The next year Sir Harford Jones was relieved as envoy by Sir Gore Ouseley.

Meanwhile hostilities had been resumed with Russia, and in 1812 the British envoy used his good offices for the restoration of peace, but the endeavour failed. To add to the Persian difficulty, in July of this year a treaty was concluded between England and Russia, and this circumstance caused the envoy to direct that British officers should take no further part in Russo-Persian military operations. Christie and Lindsay, however, resolved to remain at their own risk, and advanced with the Persian army to the Aras. On the 31st of October the force was surprised by an attack of the enemy, and retreated; the next night they were again attacked and routed at Alanduz. Christie fell bravely fighting at the head of his brigade; Lindsay saved two of his nine guns; but neither of the two Englishmen was responsible for the disaster. Lenkoran was taken by Persia, but retaken by Russia during the next three months; and on the 13th of October 1813, through Sir Gore Ouseley's intervention, the Treaty of Gulistan put an end to the war. Persia formally ceded Georgia and the seven provinces before named, with Karabakh.

On the death of the emperor Alexander in December 1825 Prince Meshukov was sent to Teheran to settle a dispute which had arisen between the two governments regarding the prescribed frontier. But, as the claim of Persia to a particular district then occupied by Russia could not be admitted, the special envoy was given his congé, and war was recommenced. The chief of Talysh struck the first blow, and drove the enemy from Lenkoran. The Persians then carried all before them; and the hereditary chiefs of Shirvan, Sheki and Baku returned from exile to co-operate with the shah's general in the south. In the course of three weeks the only

advanced post held by the governor-general of the Caucasus was the obstinate little fortress of Shusha. But before long all was again changed. Hearing that a Russian force of some 6000 men was concentrated at Tiflis, Mahommed Mirza, son of the crown prince, advanced to meet them on the banks of the Zezam. He was defeated; and his father was routed more seriously still at Ganja. The shah made great efforts to renew the war; but divisions took place in his son's camp, not conducive to successful operations, and new proposals of peace were made. But Russia demanded Erivan and Nakhichevan as well as the cost of the war; and in 1827 the campaign was reopened. Briefly, after successive gains and losses, not only Erivan was taken from Persia but Tabriz also, and finally, through the intervention of Sir John Macdonald, the English envoy, a new treaty was concluded at Turkmanchay, laying down the boundary between Russia and Persia. Among the hard conditions for the latter country were the cession in perpetuity of the khanates of Erivan and Nakhichevan, the inability to have an armed vessel in the Caspian, and the payment of a war indemnity of some £3,000,000.

After Russia, the neighbouring state next in importance to the well-being of Persia was Turkey, with whom she was united on the west by a common line of frontier. Selim had not *War with Turkey.* made free use of the south-eastern coasts of the Black Sea, to facilitate operations against the shah's troops; and there had been a passage of arms between the king's eldest son, Mahommed 'Ali Mirza, and Suleiman Pasha, son-in-law of the governor-general of Bagdad, which is locally credited as a battle won by the former. But there was no open rupture between the two sovereigns until 1821, when the frontier disputes and complaints of Persian travellers, merchants and pilgrims culminated in a declaration of war. This made 'Abbas Mirza at once seize upon the fortified places of Toprak Kal'ah and Ak Sarai within the limits of the Ottoman Empire, and, overcoming the insufficient force sent against him, he was further enabled to extend his incursions to Mush, Bitlis, and other known localities. The Turkish government retaliated by a counter-invasion of the Persian frontier on the south. At that time the Pasha of Bagdad was in command of the troops. He was defeated by Mahommed 'Ali Mirza, then prince-governor of Kermanshah, who drove his adversary back towards his capital and advanced to its immediate environs. Being attacked with cholera, however, the Persian commander recrossed the frontier, but only to succumb to the disease in the pass of Kirind. In the sequel a kind of desultory warfare appears to have been prosecuted on the Persian side of Kurdistan, and the shah himself came down with an army to Hamadan. Cholera broke out in the royal camp and caused the troops to disperse.

In the north the progress of 'Abbas Mirza was stopped at Bayazid by a like deadly visitation; and a suspension of hostilities was agreed upon for the winter season. At the expiration of four months the sirdar of Erivan took possession of a Turkish military station on the road to Erzerum, and the crown prince marched upon that city at the head of 30,000 men. The Ottoman army which met him is said to have numbered some 52,000; but victory was on the side of their opponents. Whether the success was owing to the defection of 15,000 Kurds or not the evidence adduced is insufficient to decide. In the English records of the period it is stated that the defeat of the Turks was complete.

Profiting from this victory, 'Abbas Mirza repeated an offer of peace before made without avail to the pasha of Erzerum; and, in order to conciliate him more effectually, he retired within the old limits of the dominions of the shah, his father. But more troubles arose at Bagdad, and other reasons intervened to protract negotiations for a year and a half. At length, in July 1823, the Treaty of Erzerum closed the war between Turkey and Persia. It provided especially against a recurrence of the proved causes of war, such as extorting taxes from Persian travellers or pilgrims, disrespect to the ladies of the royal harem and other ladies of rank proceeding to Mecca or Karbala (Kerbelah), irregular levies of custom-duties, non-punishment of Kurdish depredators transgressing the boundary, and the like.

With respect to the eastern boundaries of his kingdom, Fath 'Ali Shah was fortunate in having to deal with a less dangerous neighbour than the Muscovite of persistent policy and *The Afghan Question.* the Turk of precarious friendship. The Afghan, though equal to the Persian in physical force and prowess, was his inferior in worldly knowledge and experience. Moreover, the family divisions among the ruling houses of Afghanistan grew from day to day more destructive to that patriotism and sense of nationality which Ahmad Shah had held out to his countrymen as the sole specifics for becoming a strong people.

The revolt of Nadir Mirza had, as before explained, drawn the shah's attention to Khorasan in the early part of his reign; but, although quiet had for the moment been restored at Meshed by the presence of the royal camp, fresh grounds of complaint were urged against the rash but powerless prince, and recourse was had to extreme measures. Charged with the murder of a holy sayid, his hands were cut off and his tongue was plucked out, as part of the horrible punishment inflicted on him. It does not appear that Nadir Mirza's cause was ever seriously espoused by the Afghans.

¹ The "wakilu 'l-mulk," governor of Kerman, told Colonel Goldsmid, when his guest in 1866, that "his father had been Sir John Malcolm's *Ambassador*. There never was such a man as Malcolm Sahib. Not only was he generous on the part of his government, but with his own money also."—(*Telegraph and Times*, p. 584.)

nor that Fath 'Ali Shah's claim to Meshed, as belonging to the Persian crown, was actively resisted. But the large Province of Khorasan, of which Meshed was the capital, had never been other than a nominal dependency of the crown since the death of Nadir; and in the autumn of 1830 the shah, under Russian advice, assembled a large force to bring into subjection all turbulent and refractory chiefs on the east of his kingdom. Yazd and Kerman were the first points of attack; Khorasan was afterwards entered by Samnan, or the main road from Teheran. The expedition, led by 'Abbas Mirza, involved some hard fighting and much loss of life; several forts and places were captured, among them Kuchan and Serrakhs; and it may be concluded that the objects contemplated were more or less attained. An English officer, Colonel Shee, commanded what was called the "British detachment," which accompanied the prince. Thus far as regards Yazd, Kerman and Khorasan. It was otherwise with Herat.

Hajji Firuz d-Din, son of Timur Shah, reigned undisturbed in that city from 1800 to 1816. Since Fath 'Ali Shah's accession he and his brother Mahmud had been, as it were, under Persian protection. Persia claimed the principality of Herat as part of the empire of Nadir, but her pretensions had been satisfied by payments of tribute or evasive replies. Now, however, that she marched her army against the place, Firuz d-Din called in the aid of his brother Mahmud Shah of Kabul, who sent to him the famous vizier, Fath Khan Barakzai. The latter, intriguing on his own account, got possession of the town and citadel; he then sallied forth, engaged the Persian forces, and forced them to retire into their own country. In 1824, on a solicitation from Mustafa Khan, who had got temporary hold of Herat, more troops were despatched thither, but, by the use of money or bribes, their departure was purchased. Some eight or nine years afterwards 'Abbas Mirza, when at the head of his army in Meshed, invited Yar Mahommed Khan of Herat to discuss a settlement of differences between the two governments. The meeting was unproductive of good. Again the Persian troops advanced to Herat itself under the command of Mahommed Mirza, son of Abbas; but the news of his father's death caused the commander to break up his camp and return to Meshed.

Sir Gore Ouseley returned to England in 1814, in which year Mr Ellis, assisted by Mr Morier—whose "Hajji Baba" is the un-failing proof of his ability and deep knowledge of Persian character—negotiated on the part of Great Britain the Treaty of Teheran. England was to provide troops or a subsidy in the event of unprovoked invasion, while Persia was to attack the Afghans should they invade India. Captain Wilcock succeeded Morier as chargé d'affaires in 1815, and since that period Great Britain has always been represented at the Persian court. It was in Fath 'Ali Shah's reign that Henry Martyn was in Persia, and completed his able translation of the New Testament into the language of that country. Little more remains to be here narrated of the days of Fath 'Ali Shah. Among the remarkable occurrences may be noted the murder at Teheran in 1828 of M. Grebajadow, the Russian envoy, whose conduct in forcibly retaining two women of Erivan provoked the interference of the mullas and people. To repair the evil consequences of this act a conciliatory embassy, consisting of a young son of the crown prince and some high officers of the state, was despatched to St Petersburg. Shortly afterwards the alliance with Russia was strengthened, and that with England slackened in proportion.

Fath 'Ali Shah had a numerous family. Agreeably to the Persian custom, asserted by his predecessors, of nominating the heir-apparent from the sons of the sovereign without restriction to seniority, he had passed over the eldest, Mahommed 'Ali, in favour of a junior, 'Abbas; but, as the nominee died in the lifetime of his father, the old king had proclaimed Mahommed Mirza, the son of 'Abbas, and his own grandson, to be his successor. Why a younger son had been originally selected, to the prejudice of his elder brother, is differently stated by different writers. The true reason was probably the superior rank of his mother.

Mahommed Shah was twenty-eight years old when he came to the throne in 1834. He died at the age of forty-two, after a reign

of about thirteen and a half years. His accession was not publicly notified for some months after his grandfather's death, for it was necessary to clear the way of

all competitors, and there were two on this occasion—one 'Ali Mirza, governor of Teheran, who actually assumed a royal title, and one Hasan 'Ali Mirza, governor of Shiraz. Owing to the steps taken by the British envoy, Sir John Campbell, assisted by Colonel Bethune, at the head of a considerable force, supplied with artillery, the opposition of the first was neutralized, and Mahommed Shah, entering Teheran on the 2nd of January, was proclaimed king on the 31st of the same month. It cost more time and trouble to bring the second to book. Hasan 'Ali, "farman-farma," or commander-in-chief, and his brother and abettor, had an army at their disposal in Fars. Sir Henry Lindsay Bethune marched his soldiers to Isfahan to be ready to meet them. An engagement which took place near Kumishah, on the road between Isfahan and Shiraz, having been successful, the English commander pushed on to the latter town, where the two rebel princes were seized and imprisoned. Forwarded under escort to Teheran, they were, according to Watson, ordered to be sent on thence as state prisoners to Ardebil, but the

farman-farma died on the way, and his brother was blinded before incarceration. Markham, however, states that both 'Ali Mirza and Hasan 'Ali were allowed to retire with a small pension, and that no atrocities stained the beginning of the reign of Mahommed Shah. It is presumed that the fate of the prime minister or "kaim-malkam," who was strangled in prison, was no more than an ordinary execution of the law. This event, and the prevalence of plague and cholera at Teheran, marked somewhat gloomily the new monarch's first year.

The selection of a premier was one of the first weighty questions for solution. A member of the royal family, the "asafu d-da'ula," governor of Khorasan, left his government to urge his candidature for the post. The king's choice, however, fell on Hajji Mirza Aghasi, a native of Erivan, who in former years, as tutor to the sons of 'Abbas Mirza, had gained a certain reputation for learning and a smattering of the occult sciences, but whose qualifications for statesmanship were craftiness and suspicion. As might have been anticipated, the hajji fell into the hands of Russia, represented by Count Simonich, who urged him to a fresh expedition into Khorasan and the siege of Herat. There was no doubt a plausible pretext for both proposals. The chiefs, reduced to temporary submission by 'Abbas Mirza, had again revolted; and Shah Kamran, supported by his vizier, Yar Mahommed, had broken those engagements and pledged on the strength of which Fath 'Ali Shah had withdrawn his troops. In addition to these causes of offence he had appropriated the province of Seistan, over which Persia had long professed to hold the rights of suzerainty. But the king's ambition was to go farther than retaliation or chastisement. He refused to acknowledge any right to separate government whatever on the part of the Afghans, and Kandahar and Ghazni were to be recovered, as belonging to the empire of the Safawid dynasty. The advice of the British envoy was dissuasive in this respect, and therefore distasteful.

Sir John Campbell, in less than a year after the sovereign's installation, went home, and was succeeded as British envoy by Henry Ellis. The change in personnel signified also a transfer of superintendence of the Persian legation, which passed from the government in India to the authorities in England. The expedition was to commence with a campaign against the Turcomans—Herat being its later destination. Such counter-proposals as Ellis had suggested for consideration had been politely put aside, and the case was now more than ever complicated by the action of the Barakzai chiefs of Kandahar, who had sent a mission to Teheran to offer assistance against their Soduzaï rival at Herat. Fresh provocation had, moreover, been given to the shah's government by the rash and incapable Kamran.

About the close of the summer the force moved from Teheran. The royal camp was near Astarabad in November 1836. Food was scarce; barley sold for ten times the usual price, and wheat was not procurable for any money. The troops were dissatisfied, and, being kept without pay and on short rations, took to plundering. There had been operations on the banks of the Gurgan, and the Turcomans had been driven from one of their strongholds; but little or no progress had been made in the subjection of these marauders, and the Heratis had sent word that all they could do was to pay tributes, and, if that were insufficient, the shah had better march to Herat. A military council was held at Shahrud, when it was decided to return to the capital and set out again in the spring. Accordingly the troops dispersed, and the sovereign's presence at Teheran was taken advantage of by the British minister to renew his attempts in the cause of peace. Although on the present occasion Simonich ostensibly aided the British chargé d'affaires M'Neill, who had succeeded Ellis in 1836, no argument was of any avail to divert the monarch from his purpose. He again set out in the summer, and, invading the Herat territory in November 1837, began the siege on the 23rd of that month.

Not until September in the following year did the Persian army withdraw from before the walls of the city; and then the movement only took place on the action of the British government. M'Neill, who had joined the Persian camp on the 6th of April, left it again on the 7th of June. He had done all in his power to effect a reasonable agreement between the contending parties; but both in this respect and in the matter of a commercial treaty with England, then under negotiation, his efforts had been met with evasion and latent hostility. The Russian envoy, who had appeared among the tents of the besieging army almost simultaneously with his English colleague, no sooner found himself alone in his diplomacy than he resumed his aggressive counsels, and little more than a fortnight had elapsed since M'Neill's departure when a vigorous assault, planned, it is asserted, by Simonich himself, was made upon Herat. The Persians attacked at five points, one of which they would in all likelihood have been successful had not the Afghans been aided by Eldred Pottinger, a young Englishman, who with the science of an artillery officer combined a courage and determination which inevitably influenced his subordinates. Still the garrison was disheartened; but Colonel Stoddart's arrival on the 15th of August to threaten the shah with British intervention put a stop to further action. Colonel Stoddart's refusal to allow any but British mediators to decide the pending dispute won the day; and that officer was able to report that on

Siege of Herat.

the 9th of September Mahommed Shah had "mounted his horse" and gone from before the walls of the beleaguered city.

The siege of Herat, which lasted for nearly ten months, was the great event in the reign of Mahommed Shah. The British expedition in support of Shah Shuj'a, which may be called its natural consequence, involves a question foreign to the present narrative.

The remainder of the king's reign was marked by new difficulties with the British government; the rebellion of Aga Khan Mahlati otherwise known as the chief of the Assassins; a new rupture with Turkey; the banishment of the asafu'd-daula, governor of Khorasan, followed by the insurrection and defeat of his son; and the rise of Babism (q.v.). The first of these only calls for any detailed account.

In the demands of the British Government was included the cession by Persia of places such as Farah and Sabawar, which had been taken during the war from the Afghans, as well

as reparation for the violence offered to the courier of the British legation. M'Neill gave a certain time for decision, at the end of which, no satisfactory reply

having reached him, he broke off diplomatic relations, ordered the British officers left to the shah to proceed towards Bagdad *en route* to India, and retired to Erzerum with the members of his mission. On the Persian side, charges were made against M'Neill, and a special envoy was sent to England to support them. An endeavour was at the same time made to interest the cabinets of Europe in influencing the British government on behalf of Persia. The envoy managed to obtain an interview with the minister of foreign affairs in London, who, in July 1839, supplied him with a statement, fuller than before, of all English demands upon his country. Considerable delay ensued, but the outcome of the whole proceedings was not only acceptance, but fulfilment of all the engagements contracted. In the meantime the island of Kharak had been taken possession of by an expedition from India.

On the 11th of October 1841 a new mission arrived at Teheran from London, under John (afterwards Sir John) M'Neill, to renew diplomatic relations. It was most cordially received by the shah, and as one of its immediate results, Kharak was evacuated by the British-Indian troops.

There had been a long diplomatic correspondence in Europe on the proceedings of Count Siniotich and other Russian officers at Herat. Among the papers is a very important letter from Count Nesselrode to Count Pozzo di Borgo in which Russia declares herself to be the first to counsel the shah to acquiesce in the demand made upon him, because she found "justice on the side of England" and "wrong on the side of Persia." She withdrew her agent from Kandahar and would "not have with the Afghans any relations but those of commerce, and in no wise any political interests."

Aga Khan's rebellion was fostered by the defection to his cause of a large portion of the force sent against him; but he yielded at last to the local authorities of Kerman and fled the province and country. He afterwards resided many years at Bombay, where, while maintaining among natives a quasi-spiritual character, he was better known among Europeans for his doings on the turf.

The quarrel with Turkey was generally about frontier relations. Eventually the matter was referred to an Anglo-Russian commission, of which Colonel Williams (afterwards Sir Fenwick Williams of Kars) was president. A massacre of Persians at Kerbela might have seriously complicated the dispute, but, after a first burst of indignation and call for vengeance, an expression of the regret of the Ottoman government was accepted as a sufficient apology for the occurrence.

The rebellion of the asafu'd-daula, maternal uncle of the shah, was punished by exile, while his son, after giving trouble to his opponents, and once gaining a victory over them, took shelter with the Turcomans.

Before closing the reign of Mahommed Shah note should be taken of a prohibition to import African slaves into Persia, and a commercial treaty with England—recorded by Watson as gratifying achievements of the period by British diplomatists. The French missions in which occur the names of MM. de Lavalette and de Sartiges were notable in their way, but somewhat barren of results.

In the autumn of 1848 the shah was seized with the malady, or combination of maladies, which caused his death. Gout and erysipelas had, it is said,¹ ruined his constitution, and he died at his palace in Shimran on the 4th of September. He was buried at Kum, where is situated the shrine of Fatima, daughter of Imam Riza, by the side of his grandfather, Fath 'Ali, and other kings of Persia. In person he is described as short and fat, with an aquiline nose and agreeable countenance.²

On the occasion of his father's death, Nasru 'd-Din Mirza, who had been proclaimed wali 'abd, or heir apparent, some years before, was absent at Tabriz, the headquarters of his province of

Azerbaijan. Colonel Farman, then chargé d'affaires on the part of the British government, in the absence of Colonel Sheil, who had succeeded Sir John M'Neill, had, in anticipation of the shah's decease and consequent trouble, sent a messenger to summon him instantly to Teheran. The British officer, moreover, associated himself with Prince Dolgoruki, the representative of Russia, to secure the young prince's accession.

The queen-mother, as president of the council, showed much judgment and capacity in conciliating adverse parties. But the six or seven weeks which passed between the death of the one king and the coronation of the other proved a disturbed interval, and full of stirring incident. The old minister, Hajji Mirza Aghasi, shut himself up in the royal palace with 1200 followers, and had to take refuge in the sanctuary of Shah 'Abdul-Azim near Teheran. On the other hand Mirza Aga Khan, a partisan of the asafu'd-daula, and himself an ex-minister of war, whom the hajji had caused to be banished, was welcomed back to the capital. At Isafahan, Shiraz and Kerman serious riots took place, which were with difficulty suppressed. While revolution prevailed in the city, robbery was rife in the province of Yezd; and from Karvin the son of 'Ali Mirza otherwise called the "zillu'sultan," the prince-governor of Teheran, who disputed the succession of Mahommed Shah, came forth to contest the crown with his cousin, the heir-apparent. The last-named incident soon came to an inglorious termination for its hero. But a more serious revolt was in full force at Meshed when, on the 20th of October 1848, the young shah entered his capital and was crowned at midnight king of Persia.

The chief events in the long reign of Nasru 'd-Din, fall under four heads: (1) the insurrection in Khorasan, (2) the insurrection of the Babis, (3) the fall of the amiru 'n-nizam, and (4) the war with England.

It has been stated that the asafu'd-daula was a competitor with Hajji Mirza Aghasi for the post of premier in the cabinet of Mahommed Shah, that he was afterwards, in the same reign, excited for rising in rebellion, and that his son, *Insurrection in Khorasan*, took shelter with the Turcomans. Some four months prior to the Mahommed Shah's decease *the latter chief had reappeared in arms against his authority; he had gained possession of Meshed itself, driving the prince-governor, Hamza Mirza, into the citadel; and so firm was his attitude that Yar Mahommed of Herat, who had come to help the government officials, had retired after a fruitless co-operation, drawing away the prince-governor also. The salar now defied Murad Mirza, Nasru 'd-Din's uncle, who was besieging the city. In April 1850, after a siege of more than eighteen months, fortune turned against the bold insurgent, and negotiations were opened for the surrender of the town and citadel. Treachery may have had to do with the result, for when the shah's troops entered the holy city the salar sought refuge in the mosque of Imam Riza, and was forcibly expelled. He and his brother were seized and put to death, the instrument used being, according to Watson, "the bowstring of Eastern story." The conqueror of Meshed, Murad Mirza, became afterwards himself the prince-governor of Khorasan.*

In the article on BABISM, the facts as to the life of the Bab, Mirza Ali Mahommed of Shiraz, and the progress of the Babiist movement, are separately noticed. The Bab himself was executed *Babiism*, in 1850, but only after serious trouble over the new religious propaganda; and his followers kept up the revolutionary propaganda.

In the summer of 1852 the shah was attacked, while riding in the vicinity of Teheran, by four Babis, one of whom fired a pistol and slightly wounded him. The man was killed, and two others were captured by the royal attendants; the fourth jumped down a well. The existence of a conspiracy was then discovered in which some forty persons were implicated; and ten of the conspirators were put to death—some under cruel torture.

Mirza Taki, the amiru 'n-nizam (vulgarly amir nizam), or commander-in-chief, was a good specimen of the self-made man of Persia. He was the son of a cook of Bahram Mirza, Mahommed Shah's brother, and he had filled high and important offices of state and amassed much wealth when he was *Fall of Mirza Taki*, made by the young shah Nasru 'd-Din, on his accession, both his brother-in-law and his prime-minister. The choice was an admirable one; he was honest, hard-working, and liberal according to his lights; and the services of a loyal and capable adviser were secured for the new régime. Unfortunately, he did not boast the confidence of the queen-mother; and this circumstance greatly strengthened the hands of those enemies whom an honest minister must ever raise around him in a corrupt Oriental state. For a time the shah closed his eyes to the accusations and insinuations against him; but at last he fell under the evil influence of designing counsellors, and acts which should have redounded to the minister's credit became the charges on which he lost his office and his life. He was credited with an intention to grasp in his own hands the royal power; his influence over the army was cited as a cause of danger; and on the night of the 13th of November 1853 he was summoned to the palace and informed that he was no longer premier. Mirza Aga Khan, the "itimadu'd-daulah," was named to succeed him, and had been accordingly raised to the dignity of "sadr-azim." As the hostile faction pressed the necessity of the ex-minister's removal from the capital; he was offered the choice of the government of Fars, Isafahan or Kum. He declined all; but, through the mediation of Colonel Sheil, he was afterwards offered and accepted Khashan. Forty days after his departure an order for his execution was signed, but he anticipated his fate by committing suicide.

When England was engaged in the Crimean War of 1854-55 her alliance with a Mahommedan power in no way added to her

¹ Watson.

² Markham.

popularity or strengthened her position in Persia. The Sunnite Turk was almost a greater enemy to his neighbour the Shi'ite than the formidable Muscovite, who had curtailed him of so large a section of his territory west of the Caspian. Since Sir John M'Neill's arrival in Teherán in 1841, formally to repair the breach with Mahommed Shah, there had been little differences, demands and explanations, and these symptoms had culminated in 1856, the year of the peace with Russia. As to Afghanistan, the vizier Yár Mahommed had in 1842, when the British troops were perishing in the passes, or otherwise in the midst of dangers, caused Kamran to be suffocated in his prison. Since that event he had himself reigned supreme in Herat, and, dying in 1851, was succeeded by his son Sa'id Mahommed. This chief soon entered upon a series of intrigues in the Persian interests, and, among other acts offensive to Great Britain, suffered one 'Abbas Kuli, who had, under guise of friendship, betrayed the cause of the sálar at Meshed, to occupy the citadel of Herat, and again place a detachment of the shah's troops in Ghuriana. Colonel Sheil remonstrated, and obtained a new engagement of non-interference with Herat from the Persian government, as well as the recall of 'Abbas Kuli. In September 1857 Mahommed Yusá Saduzai seized upon Herat, putting Sa'id Mahommed to death with some of his followers who were supposed accomplices in the murder of his uncle Kamran. About this time Kohan Dil Khan, one of the chiefs of Kandahar, died, and Dost Mahommed of Kabul annexed the city to his territory. Some relations of the deceased chief made their escape to Teherán, and the shah, listening to their complaint, directed the prince-governor of Meshed to march across to the eastern frontier and occupy Herat, declaring that an invasion of Persia was imminent. Negotiations were useless, and on the 1st of November 1856 war against Persia was declared.

In less than three weeks after its issue by proclamation of the governor-general of India, the Sind division of the field force left Karachi. On the 13th of January following the Bombay government orders notified the formation of a second division under Lieut.-General Sir James Outram. Before the general arrived the island of Kharak and port of Bushire had both been occupied, and the fort of Rishir had been attacked and carried. After the general's arrival the march upon Borazjan and the engagement at Khushab—two places on the road to Shiraz—and the operations at Muhamrah and the Karun River decided the campaign in favour of England. On the 5th of April, at Muhamrah, Sir James Outram received the news that the treaty of peace had been signed in Paris, where Lord Cowley and Farrukh Khan had conducted the negotiations. The stipulations regarding Herat were much as before; but there were to be apologies made to the mission for past insolence and rudeness, and the slave trade was to be suppressed in the Persian Gulf. With the exception of a small force retained at Bushire under General John Jacob for the three months assigned for execution of the ratifications and giving effect to certain stipulations of the treaty with regard to Afghanistan, the British troops returned to India, where their presence was greatly needed, owing to the outbreak of the Mutiny.

The question of constructing a telegraph in Persia as a link in the overland line to connect England with India was broached in Teherán by Colonel Patrick Stewart and Captain Champlain, officers of engineers, in 1862, and an agreement on the subject concluded by Edward Eastwick, when chargé d'affaires, at the close of that year. Three years later a more formal convention, including a second wire, was signed by the British envoy Charles Alison and the Persian foreign minister; meantime the work had been actively carried on, and communication opened on the one side between Bushire and Karachi and the Makran coast by cable, and on the other between Bushire and Bagdad via Teherán. The untrustworthy character of the line through Asiatic Turkey caused a subsequent change of direction; and an alternative line—the Indo-European—from London to Teherán, through Russia and along the eastern shores of the Black Sea, was constructed, and has worked well since 1872, in conjunction with the Persian land telegraph system and the Bushire-Karachi line.

The Seistan mission, under Major-General (afterwards Sir Frederic) Goldsmid, left England in August 1870, and reached Teherán on the 3rd of October. Thence it proceeded to Isafahan, from which city it moved to Baluchistan, instead of seeking its original destination. Difficulties had arisen both in arranging the preliminaries to arbitration and owing to the disordered state of Afghanistan, and it was therefore deemed advisable to commence operations by settling a frontier dispute between Persia and the Kalat state. Unfortunately, the obstructions thrown in the way of this settlement by the Persian commissioner, the untoward appearance at Bamapur of an unexpected body of Kalatis, and the absence of definite instructions marred the fulfilment of the programme sketched out; but a line of boundary was proposed, which was afterwards accepted by the litigants. In the following year the same mission, accompanied by the same Persian commissioner, proceeded to Seistan, where it remained for more than five weeks, prosecuting its inquiries, until joined by another mission from India, under Major-General (afterwards Sir Richard) Pollock, accompanying the Afghan commissioner. Complications then

ensued by the determined refusal of the two native officials to meet in conference; and the arbitrator had no course available but to take advantage of the notes already obtained on the spot, and return with them to Teherán, there to deliver his decision. This was done on the 19th of August 1872. The contending parties appealed to the British secretary of state for foreign affairs, as provided by previous understanding; but the decision held good, and was eventually accepted on both sides.

Nasru 'd-Din Shah, unlike his predecessors, visited Europe—in 1873 and in 1879. On the first occasion only he extended his journey to England, and was then attended by his "sadr 'azim," or prime minister, Mirza Husain Khan, an able and enlightened adviser, and a Grand Cross of the Star of India. His second visit was to Russia, Germany, France and Austria, but he did not cross the Channel. (F. J. G.; X.)

E.—Persia from 1884 to 1901.

In 1865 the shah had mooted the idea of a Persian naval flotilla in the Persian Gulf, to consist of two or three steamers manned by Arabs and commanded by English naval officers; but the idea was discountenanced by the British government, to whom it was known that the project really concealed aggressive designs upon the independence of the islands and pearl fisheries of Bahrain (Curzon, *Persia*, ii. 294). Fifteen or sixteen years later it was repeatedly pointed out to the authorities that the revenues from the customs of the Persian Gulf would be much increased if control were exercised at all the ports, particularly the small ones where smuggling was being carried on on a large scale, and in 1883 the shah decided upon the acquisition of four or five steamers, one to be purchased yearly, and instructed the late 'Ali Kuli Khan, Mukhber ad-daulah, minister of telegraphs, to obtain designs and estimates from British and German firms. The tender of a well-known German firm at Bremerhaven was finally accepted, and one of the minister's sons then residing in Berlin made the necessary contracts for the first steamer. Sir Ronald Thomson, the British representative in Persia, having at the same time induced the shah to consider the advantages to Persia of opening the Karun River and connecting it with Teherán by a carriageable road, a small river steamer for controlling the shipping on the Karun was ordered as well, and the construction of the road was decided upon. Two steamers, the "Susa" and the "Persepolis," were completed in January 1885 at a cost of £32,000, and despatched with German officers and crew to the Persian Gulf. When the steamers were ready to do the work they had been intended for, the farmer, or farmers, of the Gulf customs raised difficulties and objected to pay the cost of maintaining the "Persepolis"; the governor of Muhamrah would not allow any interference with what he considered his hereditary rights of the shipping monopoly on the Karun, and the objects for which the steamers had been brought were not attained. The "Persepolis" remained idle at Bushire, and the "Susa" was tied up in the Failieh creek, near Muhamrah. The scheme of opening the Karun and of constructing a carriageable road from Ahvaz to Teherán was also abandoned.

Frequent interruptions occurred on the telegraph line between Teherán and Meshed in 1885, at the time of the "Panjeh incident," when the Russians were advancing towards Afghanistan and Sir Peter Lumaden was on the Afghan frontier; and Sir Ronald Thomson concluded an agreement with the Persian government for the line to be kept in working order by an English inspector, the Indian government paying a share not exceeding 20,000 rupees per annum of the cost of maintenance, and an English signaller being stationed at Meshed. Shortly afterwards Sir Ronald Thomson left Persia (he died on the 15th of November 1888), and Arthur (afterwards Sir Arthur) Nicolson was appointed chargé d'affaires. During the latter's tenure of office an agreement was concluded between the Persian and British governments regarding the British telegraph settlement at Jask, and the telegraph conventions of 1868 and 1872 relative to telegraphic communication between Europe and India through Persia, in force until the 1st of January 1895, were prolonged until the 31st of January 1905 by two conventions dated the 3rd of July 1887. Since then these conventions have been prolonged to 1925.

Ayub Khan, son of Shir 'Ali (Shere Ali) of Afghanistan, who had taken refuge in Persia in October 1881, and was kept interned in Teherán under an agreement, concluded on the 17th of April 1884, between Great Britain and Persia, with a pension of £8000 per annum from the British government escaped on the 14th of August 1887. After a futile attempt to enter Afghan territory and raise a revolt

against the Amir Abdur Rahman, he gave himself up to the British consul-general at Meshed in the beginning of November, and was sent under escort to the Turkish frontier and thence via Bagdad to India. Yahya Khan, Mushir-ad-daulah, the Persian minister for foreign affairs (died 1892), who was supposed to have connived at Ayub Khan's escape in order to please his Russian friends, was dismissed from office.

In December 1887 Sir Henry Drummond Wolff was appointed minister to Persia. The appointment greatly pleased the Persian court, and the shah lent a willing ear to his advocacy for the development of trade and commerce, construction of roads, abolition of various restrictions hampering Persian merchants, &c. The shah soon afterwards (May 26, 1888) issued a proclamation assuring freedom of life and property to all his subjects, and (Oct. 30) declared the Karun river open to international navigation up to Ahvaz. At about the same time he appointed Amin-es-Sultan, who had been prime minister since 1884, Grand Vizier (Sad'r azim), in the same year (June 25) the first railway in Persia, a small line of 5½ miles from Teherán to Shah-abdul-Azim, was opened under the auspices of a Belgian company. A few months later (Jan. 30, 1889) Baron Julius de Reuter—in consideration of giving up the rights which he held by his concession obtained in 1873—became the owner of a concession for the formation of a Persian State Bank, with exclusive rights of issuing bank-notes and working the mines of iron, copper, lead, mercury, coal, petroleum, manganese, borax, and asbestos in Persia. Russia now insisted upon what she considered a corresponding advantage; and Prince Dolgoruki, the Russian minister, obtained in February 1889 a document from the shah which gave to Russia the refusal of any railway concession in Persia for a period of five years. The Persian State Bank was established by British royal charter, dated the 2nd of September 1889, and started business in Persia (Oct. 23) as the "Imperial Bank of Persia." The railway agreement with Russia was changed in November 1890 into one intercepting all railways whatsoever in Persia.

In April 1889 the shah set out upon his third voyage to Europe. After a visit to the principal courts, including a stay of a month in England, where he was accompanied by Sir Henry Drummond Wolff, he returned to his capital (Oct. 20). Sir Henry returned to Persia soon afterwards, and in March of the following year the Persian government granted another important concession, that of a tobacco monopoly, to British capitalists. In the autumn bad health obliged the British minister to leave Persia. It was during his stay in England that the shah, for two or three days without his grand vizier, who was mourning for the death of his brother, listened to bad advice and granted a concession for the monopoly of lotteries in Persia to a Persian subject. The latter ceded the concession to a British syndicate for £40,000. Very soon afterwards the shah was made aware of the results of this monopoly, and withdrew the concession, but the syndicate did not get the money paid for it returned. This unfortunate affair had the effect of greatly discrediting Persia on the London Stock Exchange for a long time. The concession for the tobacco monopoly was taken up by the Imperial Tobacco Corporation (1891). The corporation encountered opposition fostered by the clergy and after a serious riot at Teherán (Jan. 4, 1892) the Persian government withdrew the concession and agreed to pay an indemnity of £500,000 (April 5, 1892). In order to pay this amount Persia contracted the 6% loan of £500,000 through the Imperial Bank of Persia, which was redeemed in 1900 out of the proceeds of the Russian 5% loan of that year. (For details of the tobacco concession and an account of the events which led to its withdrawal, see E. Lorini, *La Persia economica*, Rome, 1900, pp. 164-169; and Dr Feuvrier, *Trois ans à la cour de Perse*, Paris, 1899, ch. v., the latter ascribing the failure of the tobacco monopoly to Russian intrigue.)

In November 1889 Malcolm Khan, Nizam-ul-Mulk, who had been Persian representative to the court of Great Britain since October 1872, was recalled, and Mirza Maboomed 'Ali Khan, consul-general at Tiflis, was appointed in his stead, arriving in London the following March. In 1890 the scheme of a carriageable road from Teherán to Ahvaz was taken up again; the Imperial Bank of Persia obtained a concession, and work of construction was begun in the same year, and continued until 1893. In this year, too, the mining rights of the Imperial Bank of Persia were ceded to the Persian Bank Mining Rights Corporation, and a number of engineers were sent out to Persia. The total absence of easy means of communication, the high rates of transport, and the scarcity of fuel and water in the mineral districts made profitable operations impossible, and the corporation liquidated in 1894, after having expended a large sum of money.

Great excitement was caused in the summer of 1891 by the report that an English girl, Kate Greenfield, had been forcibly carried away from her mother's house at Tabriz by a Kurd. **Kate Greenfield Case.** The British authorities demanded the girl's restitution from the Persian government. The Kurd, a Turkish subject, refused to give up the girl, and took her to Saubagh. The Turkish authorities protected him, and serious complications were imminent; but finally an interview between the girl and the British agent was arranged, and the matter

was promptly settled by her declaring that she had left her mother's house of her own accord, and was the wife of the Kurd. It also became known that she was the daughter of a British-protected Hungarian named Grünfeld, who had died some years since, and an American lady of Tabriz.

Sir Frank Lascelles, who had been appointed minister to Persia in July, arrived at Teherán in the late autumn of 1891. In the following year Persia had a visitation of cholera. In Teherán and surrounding villages the number of fatal cases exceeded 28,000, or about 8% of the population. In 1893 the epidemic appeared again, but in a milder form. In June 1893 Persia ceded to Russia the small but very fertile and strategically important district of Firuza and the adjacent lands between Babas Durmas and Lutabad on the northern frontier of Khowsan, and received in exchange the important village of Hisar and a strip of desert ground near Abbasabad on the frontier of Azerbaijan, which had become Russian territory in 1828, according to the Treaty of Turkmenchahi.

Sir Frank Lascelles left Persia in the early part of 1894, and was succeeded by Sir Mortimer Durand, who was appointed in July and arrived in Teherán in November. In the following year the shah, by a firman dated the 12th of May gave the exclusive right of exploring ancient sites in Persia to the French government, with the stipulation that one-half of the discovered antiquities, excepting those of gold and silver and precious stones, should belong to the French government, which also had the preferential right of acquiring by purchase the other half and any of the other antiquities which the Persian government might wish to dispose of. In 1897 M. J. de Morgan, who had been on a scientific mission in Persia some years before and later in Egypt, was appointed chief of a mission to Persia, and began work at Susa in December.

On the 1st of May 1896 Nasur 'd-Din Shah was assassinated while paying his devotions at the holy shrine of Shah-abdul-Azim. Five days later he would have entered the fiftieth (lunar) year of his reign, and great preparations for duly celebrating the jubilee had been made throughout the country. The assassin was a small tradesman of Kermán named Mirza Reza, who had resided a short time in Constantinople and there acquired revolutionary and anarchist ideas from Kemalu 'd-Din, the so-called Afghan sheikh, who, after being very kindly treated by the shah, preached revolution and anarchy at Teherán, fled to Europe, visited London, and finally took up his residence in Constantinople. Kemalu 'd-Din was a native of Hamadan and a Persian subject, and as the assassin repeatedly stated that he was the sheikh's emissary and had acted by his orders, the Persian government demanded the extradition of Kemal from the Porte; but during the protracted negotiations which followed he died. Mirza Keza was hanged on the 12th of August 1896. There were few troubles in the country when the news of the shah's death became known. Serious rioting arose only in Shiraz and Fars, where some persons lost their lives and a number of caravans were looted. European firms who had lost goods during these troubles were afterwards indemnified by the Persian government. The new shah, Muzaffar-'ud-Din (born March 25, 1853), then governor-general of Azerbaijan, residing at Tabriz, was enthroned there on the day of his father's death, and proceeded a few days later accompanied by the British and Russian consuls, to Teherán, where he arrived on the 8th of June.

An excessive copper coinage during the past three or four years had caused much distress among the poorer classes since the beginning of the year, and the small trade was almost paralysed. Immediately after his accession the shah decreed that the coining of copper money should cease and the excess of the copper coinage be withdrawn from circulation. In order to reduce the price of meat, the meat tax, which had existed since ancient times was abolished. The Imperial Bank of Persia, which had already advanced a large sum of money, and thereby greatly facilitated the shah's early departure from Tabriz and enabled the grand vizier at Teherán to carry on the government, started buying up the copper coinage at all its branches and agencies. The nominal value of the copper money was 20 shahis equal to 1 kran, but in some places the copper money circulated at the rate of 80 shahis to the kran, less than its intrinsic value; at other places the rates varied between 70 and 25 shahis, and the average circulating value in all Persia was over 40. If government had been able to buy up the excess at 40 and reissue it gradually after a time at its nominal value when the people required it, the loss would have been small. But although the transport of copper money from place to place had been strictly prohibited, dishonest officials found means to traffic in copper money on their own account, and by buying it where it was cheap and forwarding it to cities where it was dear, the bank bought it at high rates, thus rendering the arrangement for a speedy withdrawal of the excess at small cost to government futile. It was only in 1899 that the distress caused by the excessive copper coinage ceased, and then, only at very great loss to government. The well-intentioned abolition of the tax on meat also had not the desired result, for by a system of "cornering" the price of meat rose to more than it was before.

French
Archaeo-
logical
Concessions.

Assassination
of the
Shah, 1896.

Currency
Difficulties.

In the autumn of 1896 the grand vizier (Amin-es-Sultan) encountered much hostility from some members of the shah's ministerial entourage and various high personages. Amin-ad-Daulah was appointed chief administrator (vizier) of Azerbaijan and sent to Tabriz. Shortly afterwards the grand vizier found it impossible to carry on his work, resigned, and retired to Kum (Nov. 24), and the shah formed a cabinet composed for the greater part of the leading members of the opposition to the grand vizier. After three months of the new régime affairs of state fell into arrears, and the most important department, that of the interior, was completely disorganized. The shah accordingly recalled Amin-ad-daulah from Tabriz (Feb. 1897), and appointed him minister president (rais-i-vuzara) and minister of the interior. In June Amin-ad-daulah was made prime minister (vizir 'azim) and given more extended powers, and in August raised to the dignity of grand vizier (sadr 'azim). Nasru 'l-Mulk was appointed minister of finance (Feb. 1898), and made an attempt to introduce a simple system of accounts, establish a budget, reorganize the revenue department, make a new assessment of the land-tax, &c.; but resistance on the part of the officials rendered it abortive.

In the latter part of 1897 E. Graves, the inspector of the English telegraph line from Jask eastwards, was brutally murdered by Baluchis, and the agents of the Persian government sent to seize the murderers were resisted by the tribes. A considerable district breaking out into open revolt, troops under the command of the governor-general of Kermân were despatched into Baluchistan. The port of Fanooh was taken in March 1898, and order was restored. One of the murderers was hanged at Jask (May 31).

Various attempts to obtain a foreign loan had been made during the previous year, but with the sole result of discrediting the Persian government in Europe. In the beginning of

1898 the shah's medical advisers strongly recommended a cure of mineral waters in Germany or France, and as his departure from Persia without paying the arrears to the army and to thousands of functionaries, or providing a sufficient sum for carrying on the government during his absence, would have created grave discontent, serious negotiations for a loan were entered upon. It was estimated that £1,000,000 would be required to pay all debts, including the balance of the 1892 loan, and leave a surplus sufficient for carrying on the government until the shah's return. London capitalists offered to float a loan for £1,250,000 at 5% and on the guarantee of the customs of Fars and the Persian Gulf ports, and to give £1,025,000, or 82% to the Persian government. They stipulated for a kind of control over the custom-houses by placing their own agents as cashiers in them. This stipulation was agreed to in principle by the grand vizier, Amin ad-daulah, who in March, in order to meet some pressing demands on the treasury borrowed £50,000 on the customs receipts of Kermânshâh and Bushire, and agreed to the lenders, the Imperial Bank of Persia's agents, being placed as cashiers in the custom-houses of both cities. He encountered, however, much opposition from the other ministers. Further negotiations ensued, and the shah's visit to Europe was abandoned. The assistance of the British government not being forthcoming, the grand vizier's position became more and more difficult, and on the 5th of June he had to resign. Muhsin Khan, Mushir-ad-daulah, minister for foreign affairs, then became president of the cabinet, and continued the negotiations, but could not bring them to a successful issue. Moreover, the Persian government, finding that the previous estimate of the money required for paying its debts was about 50% below the mark, now asked for double the amount offered by the London capitalists, without, however, proportionately increasing the guarantee. This disorganized all previous arrangements, and the negotiations for a London loan came to an end for a time at the end of July, leaving in the minds of the Persians the unfortunate impression that the British government had done nothing to aid them.

On the 9th of July the former grand vizier, Amin-es-Sultan, was recalled from Kum, where he had resided since November 1896, arrived at Teherân three days later, and was reinstated as grand vizier on the 10th of August. His immense popularity, his friendly relations with the clergy, and some temporary advances from the banks, tidied over difficulties for some time. The reform of the customs department was now (Sept. 1898) taken up seriously, and the three Belgian custom-house officials who had been engaged by Amin-ad-daulah in the beginning of the year were instructed to collect information and devise a scheme for the reorganization of the department and the abolition of the farm system. In March 1899 the custom-houses of the provinces of Azerbaijan and Kermânshâh were given over to the Belgians. The results of this step were so satisfactory that government was induced to abolish the farm system and set up the new régime in the other provinces in March 1900, and a number of other Belgian custom-houses officials were engaged.

In September, when renewed negotiations for a loan from London were not appearing to progress favourably, and the long-thought-of visit to Europe was considered to be absolutely necessary in the following year, the shah issued a firman authorizing the Russian Banque des Prêts de Perse to float a loan. Shortly after this it was

said that the London capitalists were willing to lend £1,250,000 without insisting upon the objectionable control clause; but the proposal came too late, and on the 30th of January 1900, the Russian government had permitted the issue of a loan for 22½ million roubles (£2,400,000) at 5%, guaranteed by all the customs receipts of Persia, excepting those for Fars and the Persian Gulf ports. Only in the event of any default of paying instalments and interests was the bank to be given control of the custom-houses. Persia received 85% of the nominal capital, and the Russian government guaranteed the bondholders. Money was immediately remitted to Teherân, and nearly all the arrears were paid, while the balance of the 1892 London 6% loan was paid off by direct remittance to London.

Sir Mortimer Durand left Teherân in the early spring, and proceeded to Europe on leave. On the 12th of April the shah, accompanied by the grand vizier and a numerous suite, started on his voyage to Europe. The affairs of State Shah's during his absence were entrusted to a council of *Walis* to ministers, under the presidency of his second son, Europe, Malik Mansur Mirza, Shua-es-Sultanch, who had made 1902, 1902, a long stay on the Continent the year before.

After a residence of a month at Contrexéville, the shah proceeded (July 14) to St Petersburg, and thence to Paris (July 29), intending to go to London on the 8th of August. But on account of the mourning in which several courts were thrown through the death of the king of Italy (July 29) and the duke of Saxe-Coburg-Gotha (July 30), the visits to England, Germany and Italy were abandoned. On the 2nd of August an anarchist made an attempt upon the shah's life in Paris.

F.—Russo-British Rivalry (1902-1907) and the Persian Revolution (1906-1909).

In 1902 Muzaffar-ud-Din Shah revisited the principal European capitals, and was received by King Edward VII. at Portsmouth in August. A mission headed by Viscount Downe was afterwards despatched to Persia, to invest the shah with the order of the Garter, a ceremony which took place in Teherân on the 2nd of February 1903. A week later, a new commercial treaty was concluded between Great Britain and Persia, which instituted various reforms in the customs service, secured to both countries the "most-favoured-nation" treatment, and substituted specific import and export duties for the charge of 5% *ad valorem* provided for in the treaty of 1857. These provisions to some extent counterbalanced the losses inflicted on British trade by the Russo-Persian commercial treaty signed in 1902, which had seriously damaged the Indian tea trade, and had led to a rapid extension of Russian influence. Between 1899 and 1903 the Russian Bank had lent Persia £4,000,000, of which fully half was paid to the shah for his personal requirements. Russian concessionaires were given the right to build roads from Tabriz to Teherân (1902) and from Tabriz to Kazvin (1903); and the Russian Bank opened new branches in Seistan—an example followed in 1903 by the Bank of Persia. It was, however, in the Persian Gulf that the rivalry between Great Britain and Russia threatened to become dangerous. Great Britain had almost a monopoly of maritime commerce in the Gulf, and was alone responsible for buoying, lighting and policing its waters. The British claim to political supremacy in this region had thus a solid economic basis; it had been emphasized by the British action at Kuwait (q.v.) in 1899, and by the declaration made in the House of Lords by Lord Lansdowne, as secretary of state for foreign affairs, to the effect that Great Britain would resist by all means in its power the attempt of any other nation to establish itself in force on the shores of the Gulf. On the 16th of November 1903, Lord Curzon, the viceroy of India, sailed from Karachi for the Persian Gulf. His ship, the "Hardinge," was escorted by four cruisers, and the voyage was regarded as a political demonstration, to be interpreted in connexion with Lord Lansdowne's declaration. At Bushire, on the 1st of December, the Persian governor of Fars, Ala ad-daula, committed a breach of diplomatic etiquette which induced Lord Curzon to sail away without landing. This incident was considered by some British observers to have been brought about by Russian intrigue, and the fact that Ala ad-daula was dismissed in 1904, after the Japanese had achieved several initial successes in the Russo-Japanese war, was held to confirm this opinion. But Russian financial and commercial influence in

Persia continued to increase; in December 1904 a special mission under Mirza Riza Khan was received in audience by the tsar; and in May 1905 Muzaffar-ud-Din Shah himself left Persia to visit the courts of Vienna and St Petersburg.

The Seistan Mission of 1902-1905.—A dispute as to the frontier between Afghanistan and Seistan arose in 1902. The boundary delimited by the Seistan mission of 1870-1872, and known as the "Gokamid line," was drawn along the course of the river Helmund. Between 1872 and 1902 the Helmund took a more westerly direction; no boundary marks had been erected, and a wide strip of territory remained in dispute. The Persians claimed that the boundary was the old bed of the river, the Afghans that it was the new bed; and in accordance with the treaty of 1857 both parties asked the British government to arbitrate. In January 1903, Colonel Arthur Henry MacMahon, who had previously delimited the frontier between Afghanistan and British India, was despatched from Quetta. The Persian officials were at first hostile, but their opposition, which was attributed to Russian influence at Teheran, was eventually overcome, and Colonel MacMahon (who was knighted in 1906) delivered his final award, sustaining the Persian contention, in February 1905.

British Commercial Missions.—Owing to the success of the Maclean mission, which visited and reported upon the markets and trade-routes of north-western Persia in 1903, under the direction of the Board of Trade, a similar mission was sent to southern Persia in 1904, under the auspices of the Upper India Chamber of Commerce, the Bengal Chamber and the Indian Tea Cess Company. The report of this mission (by Gleadowe-Newcomen) was published in 1906. After showing that civilized government was practically non-existent in the regions visited, it suggested as the chief remedy the conclusion of a Russo-British convention, and the division of Persia into "spheres of influence."

Russo-British Convention of 1907.—The political situation created by the Russo-Japanese War and by an internal crisis in Persia itself rendered possible such an agreement between the two rival powers, and a Russo-British convention was signed on the 31st of August 1907. Its chief provisions, in regard to Persia, are as follows: (1) north of a line drawn from Kasr-i-Shirin, Isfahan, Yezd and Kakh to the junction of the Russian, Persian and Afghan frontiers Great Britain undertook to seek no political or commercial concession, and to refrain from opposing the acquisition of any such concession by Russia or Russian subjects; (2) Russia gave to Great Britain a like undertaking in respect of the territory south of a line extending from the Afghan frontier to Gazik, Birjend, Kermān and Bander Abbasi; (3) the territory between the lines above-mentioned was to be regarded as a neutral zone in which either country might obtain concessions; (4) all existing concessions in any part of Persia were to be respected; (5) should Persia fail to meet its liabilities in respect of loans contracted, before the signature of the convention, with the Persian Banque d'Escompte and de Prêts, or with the Imperial Bank of Persia, Great Britain and Russia reserved the right to assume control over the Persian revenues payable within their respective spheres of influence. With this convention was published a letter from the British secretary of state for foreign affairs (Sir E. Grey), stating (1) that the Persian Gulf lay outside the scope of the convention, (2) that Russia admitted the special interests of Great Britain in the Gulf, and (3) that these interests were to be maintained by Great Britain as before.

The Persian Constitution.—The misgovernment and disorder which were revealed to Europe by the Gleadowe-Newcomen report, and by such sporadic outbreaks as the massacre of the Babis in Yezd (1903), had caused widespread discontent in Persia. In 1905, partly owing to the example shown by the revolutionary parties in Russia, this discontent took the form of a demand for representative institutions. On the 5th of August 1906, Muzaffar-ud-Din Shah issued a rescript in which he undertook to form a national council (Majlis) representing the whole people (see above, *Constitution*). The Majlis was duly elected,

and was opened by the shah in person on the 7th of October 1906. In January 1907 the shah died, and was succeeded by his eldest son, Mahommed 'Ali Mirza, who on the 11th of February published a message to his people, pledging himself to adhere to the new constitution.

The Revolution.—On the 12th of November the shah visited the Majlis, and repeated his pledge, but during December a riot in Teheran developed into a political crisis, in which the shah's troops were employed against the civil population. The Majlis issued a manifesto to the powers, declaring that the shah intended to overthrow the constitution, and demanding intervention. The Russian and British ministers in Teheran urged Mahommed 'Ali to maintain the constitution, and he sent a message to the Majlis, promising compliance with its demands and agreeing to place the whole army under the control of the ministry of war. These concessions allayed the prevailing unrest for a time, but the Royalist and Nationalist parties continued secretly to intrigue against one another, and in February 1908, while the shah was driving in Teheran, two bombs were exploded under his motor-car. Two persons were killed, but the shah was unhurt, and the Majlis formally congratulated him on his escape. A prolonged ministerial crisis, in April and May, was attributed by the Nationalists to the influence of reactionary courtiers, and by the Royalists to the influence of the Anjumans, or political clubs, which were alleged to control the Nationalist majority in the Majlis. Early in June the Majlis urged the shah to dismiss the courtiers under suspicion. Mahommed 'Ali consented, but withdrew from Teheran; and on his departure the royal bodyguard of so-called "Cossacks"—Persian soldiers officered by Russians in the shah's service—at once came into conflict with the Nationalists. The house of parliament was bombarded, and when the Majlis appointed commissioners to discuss terms, the shah issued a manifesto dissolving the Majlis, and entrusted the restoration of order in Teheran to military administrators. He also proposed to substitute for the elected Majlis a council of forty members, nominated by himself; but under pressure from Great Britain and Russia he promised to abandon this scheme and to order another general election. Meanwhile, civil war had broken out in the provinces; Kurdish raiders had sacked many villages near Tabriz; Persian brigands had attacked the Russian frontier-guards on the borders of Transcaucasia, and the indemnity demanded by the tsar's government was not paid until several Persian villages had been burned by Russian troops. This incident, combined with the employment of the so-called Cossacks, evoked a protest from the Nationalists, who asserted that Russia was aiding the Royalists; the accusation was true only in so far as it referred to the conduct of certain Russian officials who acted without the consent of the Russian government. Early in 1909, indeed, a Russian force of 2600 men was sent to watch events near Tabriz, and if necessary to intervene in favour of the Nationalists who held the town, and had for some months been besieged by the shah's troops. The presence of the Russians ultimately induced the Royalists to abandon the siege. In January of the same year the revolution spread to Isfahan, where the Bakhtiari chiefs made common cause with the Nationalists, deposed the Royalist governor and marched on the capital. In May and June the shah issued proclamations declaring his fidelity to the constitution, and promising an amnesty to all political offenders; but he was powerless to stay the advance of the combined Bakhtiari and Nationalist troops, who entered Teheran on the 13th of July. After severe street fighting the Cossacks deserted to the rebels, and the shah took refuge in the Russian legation (July 15). This was interpreted as an act of abdication; on the same day the national council met, and chose Mahommed 'Ali's son, Sultan Ahmad Mirza, aged thirteen, as his successor. Asad ul-Mulk, head of the Kajar tribe, was appointed regent. On the 9th of September 1909, the ex-shah departed for his place of exile in the Crimea, escorted by Russian Cossacks and Indian sowars. On the 15th of November a newly elected Majlis was formally opened by the shah.

BIBLIOGRAPHY.—I. General: Lord Curzon of Kedleston, *Persia and the Persian Question* (London, 1892), contains an account of European literature relating to Persia (A. D. 900-1901) and numerous bibliographical notes. See also Lady [M. L.] Shiel, *Life and Manners in Persia* (London, 1856); Sir A. H. Layard, *Early Adventures in Persia* (London, 1887); S. G. W. Benjamin, *Persia and the Persians* (3rd ed., London, 1891); C. E. Yate, *Khurasan and Sistan* (Edinburgh, 1900); H. S. Landor, *Across Coated Lands* (London, 1902); J. de Morgan, *Mission scientifique* (vols. 1-4, 1897-1904), N. Malcolm, *Five Years in a Persian Town (Yezd)* (London, 1903); A. V. W. Jackson, *Persia, Past and Present* (London, 1906); E. C. Williams, *Across Persia* (London, 1907). The works of James Morier (q.v.), especially his *Adventures of Hajji Baba of Ispahan*, throw much light on Persian society in the early years of the 19th century.

2. *History*: Sir J. Malcolm, *History of Persia* (2nd ed., London, 1820); R. G. Watson, *A History of Persia from the Beginning of the Nineteenth Century* (London, 1873); Sir C. K. Markham, *A General Sketch of the History of Persia* (London, 1874), and Curzon, as quoted above, are the standard authorities on modern Persian history. The *Travels of Pedro Teixeira* (London, 1902) and other publications of the Hakluyt Society relating to Persia are also of great historical value. For more recent events see the reports of the Gladstone-Newcomen and MacMahon missions: E. G. Browne, *The Persian Revolution of 1905-09* (London, 1910); A. Hamilton, *Problems of the Middle East* (London, 1909); V. Chirol, *The Middle Eastern Question* (London, 1904); E. C. Williams, *Across Persia* (London, 1907). The commercial convention of 1903 is given in Treaty series, No. 10 (London, 1903), the Russo-British convention in Treaty series, No. 34 (London, 1907). Other official publications of historical importance are the annual British F. O. reports, and the U.S. Consular Reports.

LANGUAGE AND LITERATURE

I. *Persian (Iranian) Languages.*—Under the name of Persian is included the whole of that great family of languages occupying a field nearly coincident with the modern Iran, of which true Persian is simply the western division. It is therefore common and more correct to speak of the Iranian family. The original native name of the race which spoke these tongues was Aryan. King Darius is called on an inscription "a Persian, son of a Persian, an Aryan of Aryan race"; and the followers of the Zoroastrian religion in their earliest records never give themselves any other title but *Airyavō danghawō*, that is to say, "Aryan races." The province of the Iranian language is bounded on the west by the Semitic, on the north and north-east by the Ural-altaic or Turanian, and on the south-east by the kindred language of India.

The Iranian languages form one of the great branches of the Indo-European stem, first recognized as such by Sir William Jones and Friedrich Schlegel. The Indo-European or Indo-Germanic languages are divided by Brugmann into (1) Aryan, with sub-branches (a) Indian, (b) Iranian; (2) Armenian; (3) Greek; (4) Albanian; (5) Italic; (6) Celtic; (7) Germanic, with sub-branches (a) Gothic, (b) Scandinavian, (c) West Germanic; and (8) Balto-Slavonic. (See INDO-EUROPEAN.) The Aryan family (called by Professor Sievers the "Asiatic base-language") is subdivided into (1) Iranian (Erarian, or Erano-Aryan) languages, (2) Pisacha, or non-Sanskritic Indo-Aryan languages, (3) Indo-Aryan, or Sanskritic Indo-Aryan languages (for the last two see INDO-ARYAN); Iranian being also grouped into Persian and non-Persian.

The common characteristics of all Iranian languages, which distinguish them especially from Sanskrit, are as follows:—

- Changes of the original *s* into the spirant *h*. Thus—

Sanskrit.	Zend.	Old Persian.	New Persian.
sindhu (Indus)	hindu	hindu	hind
sarva (all)	haruva	haruva	har
sama (whole)	hama	hama	ham
santi (sunt)	henti	hantiy	hend.
- Change of the original aspirates *gh, dh, bh* (= *x, θ, φ*) into the corresponding medials—

Sanskrit.	Zend.	Old Persian.	New Persian.
bhūmi (earth)	būmi	būmi	būm
dhita (broth)	dāta	dāta	dād
gharma (heat)	garma	garma	garm.
- h, k, t, p* before a consonant are changed into the spirants *kh, th, f*—

Sanskrit.	Zend.	Old Persian.	New Persian.
prathama (first)	fratema	fratama	fradm (Parsi)
kratu (inight)	khratu	khirad.	khirad.

4. The development of soft sibilants—

Sanskrit.	Zend.	Old Persian.	New Persian.
Asurō Medhā ¹	Ahurō Mazdā	Auramaśā	Ormuś
bāhu (arm)	bāzu	bāzi
hima (hiems)	zima	zim.

Our knowledge of the Iranian languages in older periods is too fragmentary to allow of our giving a complete account of this family and of its special historical development. It will be sufficient here to distinguish the main types of the older and the more recent periods. From antiquity we have sufficient knowledge of two dialects, the first belonging to eastern Iran, the second to western.

1. *Zend or Old Bactrian.*—Neither of these two titles is well chosen. The name Old Bactrian suggests that the language was limited to the small district of Bactria, or at least that it was spoken there—which is, at the most, only an hypothesis. *Zend*, again (originally *dāstān*), is not the name of a language, as Anquetil Duperron supposed, but means "interpretation" or "explanation," and is specially applied to the medieval Pahlavi translation of the *Avesta*. Our "*Zend-Avesta*" does not mean the *Avesta* in the *Zend* language, but is an incorrect transcription of the original expression *Avistāk va zand*, i.e. "the holy text (*avestā*) together with the translation." But, since we still lack sure data to fix the home of this language with any certainty, the convenient name of *Zend* has become generally established in Europe, and may be provisionally retained. But the home of the *Zend* language was certainly in eastern Iran; all attempts to seek it farther west—*v.g.* in Media²—must be regarded as failures.

Zend is the language of the so-called *Avesta*, the holy book of the Persians, containing the oldest documents of the religion of Zoroaster. Besides this important monument, which is about twice as large as the *Iliad* and *Odyssey* put together, we only possess very scanty relics of the *Zend* language in medieval glosses and scattered quotations in Pahlavi books. These remains, however, suffice to give a complete insight into the structure of the language. Not only amongst Iranian languages, but amongst all the languages of the Indo-European group, *Zend* takes one of the very highest places in importance for the comparative philologist. In age it almost rivals Sanskrit; in primitiveness it surpasses that language in many points; it is inferior only in respect of its less extensive literature, and because it has not been made the subject of systematic grammatical treatment. The age of *Zend* must be examined in connexion with the age of the *Avesta*. In its present form the *Avesta* is not the work of a single author or of any one age, but embraces collections produced during a long period. The view which became current through Anquetil Duperron, that the *Avesta* is throughout the work of Zoroaster (in *Zend*, *Zarathushtra*), the founder of the religion, has long been abandoned as untenable. But the opposite view, that not a single word in the book can lay claim to the authorship of Zoroaster, also appears on closer study too sweeping. In the *Avesta* two stages of the language are plainly distinguishable. The older is represented in but a small part of the whole work, the so-called *Gāthās* or songs. These songs form the true kernel of the book *Yasna*; they must have been in existence long before all the other parts of the *Avesta*, throughout the whole of which allusions to them occur. These *gāthās* are what they claim to be, and what they are honoured in the whole *Avesta* as being—the actual productions of the prophet himself or of his time. They bear in themselves irrefutable proofs of their authenticity, bringing us face to face not with the Zoroaster of the legends but with a real person, announcing a new doctrine and way of salvation, no supernatural Being assured of victory, but a mere man, struggling with human conflicts of every sort, in the midst of a society of fellow-believers yet in its earliest infancy. It is almost impossible that a much later period could have produced such unpretentious and almost depreciatory representations of the deeds and personality of the prophet. If, then, the *gāthās* reach back to the time of Zoroaster, and he himself, according to the most probable estimate, lived as early as the 14th century B.C., the oldest component parts of the *Avesta* are hardly inferior in age to the oldest Vedic hymns. The *gāthās* are still extremely rough in style and expression; the language is richer in forms than the more recent *Zend*; and the vocabulary shows important differences. The predominance of the long vowels is a marked characteristic, the constant appearance of a long final vowel contrasting with the preference for a final short in the later speech.

¹ Name of the supreme god of the Persians.

² Cf. I. Darmesteter, *Revue iranienne*, I. 10 (Paris, 1883).

³ This, and not *Zend-Avesta*, is the correct title for the original text of the Persian Bible. The origin of the word is doubtful, and we cannot point to it before the time of the Sasanians. Perhaps it means "announcement," "revelation."

⁴ The *Avesta* is divided into three parts: (1) *Yasna*, with an appendix, *Visparad*, a collection of prayers and forms for divine service; (2) *Vendidad*, containing directions for purification and the penal code of the ancient Persians; (3) *Khordān-Avesta*, or the Small *Avesta*, containing the *Yasht*, the contents of which are for the most part mythological, with shorter prayers for private devotion.

Sanskrit.	Gāthā.	Later Zend.
abhi (near)	abhi	abwi
ihā (work)	izā	izha

The clearest evidence of the extreme age of the language of the gāthās is its striking resemblance to the oldest Sanskrit, the language of the Vedic poems. The gāthā language (much more than the later Zend) and the language of the Vedas have a close resemblance, exceeding that of any two Romanic languages; they seem hardly more than two dialects of one tongue. Whole strophes of the gāthās can be turned into good old Sanskrit by the application of certain phonetic laws; for example—

“mat vāo padālah yā frasrūtā izhayāo
 pairijāsai mazdā ustānastō
 āt vāo ashā ardrahāyācā nemanghā
 āt vāo vāngēshū mananghō hūnarētātā,”

becomes in Sanskrit—

“mana vah padāh yā praçrūtā ihāyāh
 parigachāi medha uttānahastā
 āt vah rctna radhrasayā namasā
 āt vō vasor manasāh silrjatyā.”

The language of the other parts of the *Avesta* is more modern, but not all of one date, so that we can follow the gradual decline of Zend in the *Avesta* itself. The later the date of a text, the simpler is the grammar, the more lax the use of the cases. We have no chronological points by which to fix the date when Zend ceased to be a living language; so part of the *Avesta* can well be put later than the 5th or 4th century B.C. Before Alexander's time it is said to have been already written out on dressed cowhides and preserved in the state archives at Persepolis.

The followers of Zoroaster soon ceased to understand Zend. For this reason all that time had spared of the *Avesta* was translated into Middle Persian or PAHLAVI (q.v.) under the Sassanians. This translation, though still regarded as canonical by the Parsees, shows a very imperfect knowledge of the original language. Its value for modern philology has been the subject of much needless controversy amongst European scholars. It is only a secondary means towards the comprehension of the ancient text, and must be used with discrimination. A logical system of comparative exegesis, aided by constant reference to Sanskrit, its nearest ally, and to the other Iranian dialects, is the best means of recovering the lost sense of the Zend texts.

The phonetic system of Zend consists of simple signs which express the different shades of sound in the language with great precision. In the vowel-system a notable feature is the presence of the short vowels *e* and *o*, which are not found in Sanskrit and Old Persian; thus the Sanskrit *śaṣṭi*; Old Persian *ḥaṣṭi*, becomes *ḥeṣṭi* in Zend. The use of the vowels is complicated by a tendency to combinations of vowels and to epenthesis, i.e. the transposition of weak vowels into the next syllable; e.g. Sanskrit *bharati*, Zend *barāti* (he carries); Old Persian *marga*, Zend *mōrva* (Merv); Sanskrit *rinakā*, Zend *rinakāti*. Triphthongs are not uncommon, e.g. Sanskrit *apṛokhyas* (dative plural of *apa*, a horse) is in Zend *apṛōkhyō*; Sanskrit *kravāti* (he does), Zend *kerenawōti*. Zend has also a great tendency to insert irrational vowels, especially near liquids; owing to this the words seem rather inflated; e.g. *savya* (on the left) becomes in Zend *hāavya*; *bhrājati* (it glitters), Zend *burāzaiti*; *gnā* (*gnā*), Zend *gēnd*. In the consonantal system we are struck by the abundance of sibilants (*s* and *sh*, in three forms of modification, *s* and *sh*) and nasals (five in number), and by the complete absence of *k*. A characteristic phonetic change is that of *ri* into *sh*; e.g. Zend *asha* for Sanskrit *śa*, Old Persian *arta* (In Artaxerxes); *fravashī* for Pahlavi *fravardin*, New Persian *farver* (the spirits of the dead). The verb displays a like abundance of primary forms with Sanskrit, but the conjugation by periphrasis is only slightly developed. The noun has the same eight cases as in Sanskrit. In the gāthās there is a special ablative, limited, as in Sanskrit, to the “*a*” stems, whilst in later Zend the ablative is extended to all the stems indifferently.

We do not know in what character Zend was written before the time of Alexander. From the Sassanian period we find an alphabetic and very legible character in use, derived from Sassanian Pahlavi, and closely resembling the younger Pahlavi found in books. The oldest known manuscripts are of the 14th century A.D.¹

Although the existence of the Zend language was known to the Oxford scholar Thomas Hyde, the Frenchman Anquetil Duperron, who went to the East Indies in 1755 to visit the Parsee priests, was the first to draw the attention of the learned world to the subject. Scientific study of Zend texts began with E. Burnouf, and has

since then made rapid strides, especially since the Vedas have opened to us a knowledge of the oldest Sanskrit.

2. *Old Persian*.—This is the language of the ancient Persians properly so-called;² in all probability the mother-tongue of Middle Persian of the Pahlavi texts, and of New Persian. We *Old Persian*. know Old Persian from the rock-inscriptions of the Achaemenians, now fully deciphered. Most of them, and these the longest, date from the time of Darius, but we have specimens as late as Artaxerxes Ochus. In the latest inscriptions the language is already much degraded; but on the whole it is almost as antique as Zend, with which it has many points in common. For instance, if we take a sentence from an inscription of Darius

“Auramazdā hya imām bumim adā hya avam asmānam adā hya martiyam adā hya siyātm adā martiyahyā hya Dārayavauṃ kshāyathiyam akunaush avim paruvānm kshāyathiyam,”

it would be in Zend—

“Ahurō mazdāyo yō imām būmim adāt yō som asmanam adāt yō mashim adāt yō shāitim adāt masyahē yō dārayāvohūm kshāstem akereṇaot gyūm pourunām kshāstem.”

The phonetic system in Old Persian is much simpler than in Zend; we reckon twenty-four letters in all. The short vowels *e*, *o* are wanting; in their place the old “*a*” sound still appears as in Sanskrit, e.g. Zend *bagem*, Old Persian *bagam*, Sanskrit *bhagam*; Old Persian *hamarana*, Zend *hamerena*, Sanskrit *samarana*. As regards consonants, it is noticeable that the older *s* (soft *s*) still preserved in Zend passes into *š*—a rule that still holds in New Persian; compare—

Sanskrit.	Zend.	Old Persian.	New Persian.
hasta (hand)	zasta	dasta	dast
jrāyas (sea)	zrayō	daraya	daryā
aham (I)	azem	adam	...

Also Old Persian has no special *l*. Final consonants are almost entirely wanting. In this respect Old Persian goes much farther than the kindred idioms, e.g. Old Persian *abara*, Sanskrit *abharat*, Zend *abarāt*, *šape*; nominative *bara*, root-form *barō-s*, Sanskrit *bhagas*. The differences in declension between Old Persian and Zend are unimportant.

Old Persian inscriptions are written in the cuneiform character of the simplest form, known as the “first class.” Most of the inscriptions have besides two translations into the more complicated kinds of cuneiform character of two other languages of the Persian Empire. One of these is the Assyrian; the real nature of the second is still a mystery. The interpretation of the Persian cuneiform, the character and dialect of which were equally unknown, was begun by G. F. Grotefend, who was followed by E. Burnouf, Sir Henry Rawlinson and J. Oppert. The ancient Persian inscriptions have been collected in a Latin translation with grammar and glossaries by P. Spiegel (Leipzig, 1862; new and enlarged ed., 1881). The other ancient tongues and dialects of this family are known only by name; we read of peculiar idioms in Sogdiana, Zabulistan, Herat, &c. It is doubtful whether the languages of the Scythians, the Lycians and the Lydians, of which hardly anything remains, were Iranian or not.

After the fall of the Achaemenians there is a period of five centuries, from which no document of the Persian language has come down to us.

Under the Arsacids Persian nationality rapidly declined; all that remains to us from that period—namely, the inscriptions on coins—is in the Greek tongue. Only towards the end of the Parthian dynasty and after the rise of the Sassanians, under whom the national traditions were again cultivated in Persia, do we recover the lost traces of the Persian language in the Pahlavi inscriptions and literature.

3. *Middle Persian*.—The singular phenomena presented by Pahlavi writing have been discussed in a separate article (see PAHLAVI). The languages which it disguises rather than expresses—Middle Persian, as we may call it—*Middle Persian*. presents many changes as compared with the Old Persian of the Achaemenians. The abundant grammatical forms of the ancient language are much reduced in number; the case-ending is lost; the noun has only two inflexions, the singular and the plural; the cases are expressed by prepositions—e.g. *rūdān* (the soul), nom. and acc. sing., plur. *rūdānān*; dat. *vai* or *avo rūdān*, abl. *min* or *as rūdān*. Even distinctive forms for gender are entirely abandoned, e.g. the pronoun *avō* signifies “he,” “she,” “it.” In the verb compound forms predominate. In this respect Middle Persian is almost exactly similar to New Persian.

¹ “With verses of my making, which are now heard, and with prayerful hands, I come before thee, Mazda, and with the sincere humility of the upright man and with the believer's song of praise.”

² *Grammars* by F. Spiegel (Leipzig, 1867) and A. V. W. Jackson (Stuttgart, 1892); *Dictionary* by F. Justi (Leipzig, 1864); editions of the *Avesta* by N. L. Westergaard (Copenhagen, 1852) and C. F. Geldner (Stuttgart, 1886-1895; also in English); translation into German by Spiegel (Leipzig, 1852), and into English by Darmesteter (Oxford, 1880) in Max Müller's *Sacred Books of the East*.

³ And perhaps of the Medes. Although we have no record of the Median language we cannot regard it as differing to any great extent from the Persian. The Medes and Persians were two closely-connected races. There is nothing to justify us in looking for the true Median language either in the cuneiform writings of the second class or in Zend.

⁴ Ormuzd, who created this earth and that heaven, who created man and man's dwelling-place, who made Darius king, the one and only king of many.”

4. *New Persian*.—The last step in the development of the language is New Persian, represented in its oldest form by Firdousi. In grammatical forms it is still poorer than Middle Persian; except English, no Indo-European language has so few inflexions, but this is made up for by the subtle development of the syntax. The structure of New Persian has hardly altered at all since the *Shāhnāma*; but the original purism of Firdousi, who made every effort to keep the language free from Semitic admixture, could not long be maintained. Arabic literature and speech exercised so powerful an influence on New Persian, especially on the written language, that it could not withstand the admission of an immense number of Semitic words. There is no Arabic word which would be refused acceptance in good Persian. But, nevertheless, New Persian has remained a language of genuine Iranian stock.

Among the changes of the sound system in New Persian, as contrasted with earlier periods, especially with Old Persian, the first that claims mention is the change of the tenues *k, l, p, c*, into *g, d, b, z*. Thus we have—

Old Persian or Zend.	Pahlavī.	New Persian.
mahrīca (death)	mark	marġ
Thraētaona	Ferīdūn	Ferīdūn
āp (water)	āp	āb
hvatō (self)	khōt	khōd
raucah (day)	rōj	rūz
haca	aj	az.

A series of consonants often disappear in the spirant; thus—

Old Persian or Zend.	Pahlavī.	New Persian.
kaufa (mountain)	kof	kōh
gāthu (place). Z. gātu	gās	gāh
catware (four)	chār
bandaka (slave)	bandah
spāda (army)	spāh
dādāmi (I give)	dāham.

Old *d* and *dh* frequently become *y*—

Old Persian or Zend.	Pahlavī.	New Persian.
madhu (wine)	mai
baodhō (consciousness)	bōd	bōi
pādha (foot)	pāi
kadha (wheat)	kai.

Old *y* often appears as *j*; Zend *yama* (glass), New Persian *jām*; *yavan* (a youth), New Persian *javān*. Two consonants are not allowed to stand together at the beginning of a word; hence vowels are frequently inserted or prefixed, e.g. New Persian *siādan* or *siādan* (to stand), root *stā*; *birādar* (brother), Zend and Pahlavi *brādar*.¹

Amongst modern languages and dialects other than Persian which must be also assigned to the Iranian family may be mentioned:—

Modern Dialects. 1. *Kurdish*, a language nearly akin to New Persian, with which it has important characteristics in common. It is chiefly distinguished from it by a marked tendency to shorten words at all costs, e.g. Kurd. *berā* (brother) = New Persian *brādar*; Kurd. *dīm* (I give) = New Persian *dāham*; Kurd. *spī* (white) = New Persian *spīd*.

2. *Baluch*, the language of Baluchistan, also very closely akin to New Persian, but especially distinguished from it in that all the old spirants are changed into explosives, e.g. Baluch *vāb* (sleep) = Zend *vaupa*; Baluch *kap* (slime) = Zend *kafsa*, New Persian *kāf*; Baluch *hapi* (seven) = New Persian *haft*.

3. *Ossetic*, true Iranian, in spite of its resemblance in sound to the Georgian.²

4. *Pashāu* (less accurately Afghan), which has certainly been increasingly influenced by the neighbouring Indian languages in inflexion, syntax and vocabulary, but is still at bottom a pure Iranian language, not merely intermediate between Iranian and Indian.

The position of *Armenian* remains doubtful. Some scholars attribute it to the Iranian family; others prefer to regard it as a separate and independent member of the Indo-European group. Many words that at first sight seem to prove its Iranian origin are only adopted from the Persian.³ (K. G.)

II. *Modern Persian Literature*.—Persian historians are greatly at variance about the origin of their national poetry. Most of them go back to the 5th Christian century and ascribe to one of the Sassanian kings, Bahrām V. (420-439), the invention of

metre and rhyme; others mention as author of the first Persian poem a certain Abulhaḥs of Soghd, near Samarkand. In point of fact, there is no doubt that the later Sassanian rulers fostered the literary spirit of their nation (see PAHLAVI). Pahlavi books, however, fall outside of the present subject, which is the literature of the idiom which shaped itself out of the older Persian speech by slight modifications and a steadily increasing mixture of Arabic words and phrases in the 9th and 10th centuries of our era, and which in all essential respects has remained the same for the last thousand years. The death of Hārūn al-Rashid in the beginning of the 9th century, which marks the commencement of the decline of the caliphate, was at the same time the starting-point of movements for national independence and a national literature in the Iranian dominion, and the common cradle of the two was in the province of Khorāsān, between the Oxus and the Jaxartes. In Merv, a Khorāsānian town, a certain 'Abbās composed in 809 A.D. (193 A.H.), according to the oldest biographical writer of Persia, Mohammed 'Aulī, the first real poem in modern Persian, in honour of the Abbāsīd prince Mamūn, Hārūn al-Rashid's son, who had himself a strong predilection for Persia, his mother's native country, and was, moreover, thoroughly imbued with the freethinking spirit of his age. Soon after this, in 820 (205 A.H.), Ṭāhir, who aided Mamūn to wrest the caliphate from his brother Amīn, succeeded in establishing the first semi-independent Persian dynasty in Khorāsān, which was overthrown in 872 (259 A.H.) by the Šāffarīds.

The development of Persian poetry under these first native dynasties was slow. Arabic language and literature had gained too firm a footing to be supplanted at once by a new literary idiom still in its infancy; nevertheless the few poets who arose under the Ṭāhirīds and Šāffarīds show already the germs of the characteristic tendency of all later Persian literature, which aims at amalgamating the enforced spirit of Islamism with their own Aryan feelings, and reconciling the strict deism of the Mahomedan religion with their inborn loftier and more or less pantheistic ideas; and we can easily trace in the few fragmentary verses of men like Ḥanzala, Ḥakīm Fīrūz and Abū Salik those principal forms of poetry now used in common by all Mahomedan nations—the forms of the *ghazal* (the encomiastic, elegiac or satirical poem), the *ghazal* or ode (a love-ditty, wine-song or religious hymn), the *rubā'i* or quatrain (our epigram, for which the Persians invented a new metre in addition to those adopted from the Arabs), and the *mathnawī* or double-rhymed poem (the legitimate form for epic and didactic poetry). The first who wrote such a *mathnawī* was Abū Shukūr of Balkh, the oldest literary representative of the third dynasty of Khorāsān, the Sāmānīds, who had been able in the course of time to dethrone the Šāffarīds, and to secure the government of Persia, nominally still under the supremacy of the caliphs in Bagdad, but in fact with full sovereignty. The undisputed reign of this family dates from the accession of Amr Naṣr II. (913-942; 301-331 A.H.), who, more than any of his predecessors, patronized arts and sciences in his dominions.

The most accomplished minstrels of his time were Mahomed Faralādi (or Faralāwi); Abū 'l-'Abbās of Bokhārā, a writer of very tender verses; Abū 'l-Muzaḥfar Naṣr of Nishāpūr; Abū 'Abdallāh Mahomed of Junaid, equally renowned for his Arabic and Persian poetry; Ma'nawī of Bokhārā, full of original thoughts and spiritual subtleties; Khusravānī, from whom even Firdousi condescended to borrow quotations; Abū 'l-Ḥasan Shāhid of Balkh, the first who made a *diwān* or alphabetical collection of his lyrics; and Rūdāgi (or Rūdaki), the first classic genius of Persia, who impressed upon every form of lyric and didactic poetry its peculiar stamp and individual character (see RŪDAGI). His graceful and captivating style was imitated by Ḥakīm Khabbaz of Nishāpūr, a great baker, poet and quack; Abū Shu'aib Šālih of Herāt, who left a spirited little song in honour of a young Christian maiden; Ranaqi of Bokhārā; Abū 'l-Faḥ of Bust, who was also a good Arabic poet; the amir Abū 'l-Ḥasan 'Alī Alagāichī, who handled the pen as skillfully as the sword; Umāra of Merv, a famous

¹ Grammars of New Persian, by M. Lumsden (Calcutta, 1810), A. B. Chodzko (Paris, 1852; new ed., 1883), D. Forbes (1869), J. A. Vullers (Giessen, 1870), A. Wähmūd (Giessen, 1875), C. Salemann and V. Zhukovski (Leipzig, 1889); J. T. Platts (pt. i. 1984). For the New Persian dialects see Fr. Müller, in the *Sitzungsber. der wien. Akad.*, vols. lxxvii., lxxviii.

² Cf. Hübchmann, in *Kuhn's Zeitschrift*, xiv. 396.
³ Cf. P. de Lagarde, *Armenische Studien* (Göttingen, 1877); H. Hübchmann, *Armenische Studien* (Leipzig, 1883).

astronomer; and Kisâ'i, a native of the same town, a man of stern and ascetic manners, who sang in melodious rhythm the praise of 'Alî and the twelve imâms. All these poets flourished under the patronage of the Sâmanid princes, who also fostered the growing desire of their nation for historical and antiquarian researches, for eretical and medical studies. Mansûr I., the grandson of Rûdagî's patron, ordered (963; 352 A.H.) his vizier Bal'âmî to translate the famous universal history of Tabarî

(838-923 A.D.) from Arabic into Persian; and this *Tabarî* (*Ta'rikh-i-Tabarî*), the oldest prose work in modern Persian, is not merely remarkable from a philological point of view, it is also the classic model of an easy and simple style (French trans. by L. Dubeux and H. Zotenberg, 1867-1874). The same prince employed the most learned among the ulemâ of Transoxiana for a translation of Tabarî's second great work, the *Tafsîr*, or commentary on the Koran, and accepted the dedication of the first Persian book on medicine, a pharmacopœia by the physician Abû Mansûr Muwaffaq b. 'Alî of Herât (edited by Seligmann, Vienna, 1859), which forms a kind of connecting link between Greek and Indian medicine. It was soon after further developed by the great Avicenna (d. 1037; 428 A.H.), himself a Persian by birth and author of pretty wine-songs, moral maxims, psychological tracts, and a manual of philosophic science, the *Dâmshûnâme-i-'Alî*, in his native tongue.

A still greater impulse was given, both to the patriotic feelings and the national poetry of the Persians, by Mansûr's son and successor, Prince Nûh II., who ascended the throne in 976 (365 A.H.). Full of enthusiasm for the glorious past of the old Iranian kingdom, he charged his court poet Daqîqi (*Daqiqi*), who openly professed in his ghazals the Zoroastrian creed, to turn the *Khodâ'înâme*, or "Book of Kings," into Persian verse. Shortly after commencing this work Daqîqi was murdered in the prime of life; his death was soon followed by the fall of the Sâmanid dynasty itself. But Daqîqi's great enterprise was not abandoned; a stronger hand, a higher genius, was to continue and to complete it, and this genius was found in Firdousî (940-1020; 328-411 A.H.), with whom we enter the golden age of the national epopee in Persia (see FIRDOSÛS).

In 1011, after thirty-five years of unremitting labour, he accomplished his gigantic task, and wrote the last distichs of the immortal *Shâhnâme*, that "glorious monument of Eastern genius and learning," as Sir W. Jones calls it, "which, if ever it should be generally understood in its original language, will contest the merit of invention with Homer itself." The *Shâhnâmeh*, from the very moment of its appearance, exercised such an irresistible fascination upon all minds that there was soon a keen competition among the younger poets as to who should produce the most successful imitation of that classic model; and this competition has gone on under different forms through all the following centuries, even to the most recent times. First of all, the old popular traditions, so far as they had not yet been exhausted by Firdousî, were ransacked for new epic themes, and a regular cycle of national epopees gathered round the *Book of Kings*, drawn almost exclusively from the archives of the princes of Sejestân, the family of Firdousî's greatest hero, Rustam. The first and most ambitious of these competitors seems to have been Asadî's own son, 'Alî b. Aḥmad al-Asadî, the author of the oldest Persian glossary, who completed in 1066 (458 A.H.), in upwards of 9000 distichs, the *Garshâspnâme*, or marvellous story of the warlike feats and love adventures of Garshâsp, one of Rustam's ancestors. The heroic deeds of Rustam's grandfather were celebrated in the *Sâmânâme*, which almost equals the *Shâhnâme* in length; those of Rustam's two sons, in the *Jahângîrnâme* and the *Farâmûznâme*; those of his daughter, an amazon, in the Brunhild style of the German Nibelunge, in the *Bâmâ Gushkîspnâme*; those of his grandson in the *Barsîznâme*; those of his great-grandson in the *Shahriyârânâme* (ascribed to Mukhtâr and dedicated to Mas'ûd Shâh, who is probably identical with Mas'ûd b. Ibrâhîm, Sultan Maḥmûd's great-grandson, 1099-1114; 492-508 A.H.); and the wonderful exploits

of a son of Isfandiyr, another hero of the *Shâhnâme*, in the *Bahmânâme*.

When these old Iranian sources were almost exhausted, the difficulty was met in various ingenious ways. Where some slight historical records of the heroic age were still obtainable poetical imagination seized upon them at once; where no traditions at all were forthcoming fiction pure and simple asserted its right; and thus the national epopee gave way to the epic story, and—substituting prose for verse—to the novel and the fairy tale. Models of the former class are the various *Iskandarnâmes*, or "Books of Alexander the Great," the oldest and most original of which is that of Niẓâmî of Ganja, the modern Elizavetpol (completed about 1202; 599 A.H.); the latter begins with the *Kûtâb-i-Samak 'Iyâr*, a novel in three volumes (about 1189; 585 A.H.), and reaches its climax in the *Bâstân-i-Khayâl*, or "Garden of Imagination," a prose romance of fifteen large volumes, by Mahommed Taqî Khayâl, written between 1742 and 1756 (1155 and 1169 A.H.). Some writers, both in prose and verse, turned from the exhausted fields of the national glory of Persia, and chose their subjects from the chivalrous times of their own Bedouin conquerors, or even from the Jewish legends of the Koran. Of this description are the *Anbiyânâme*, or history of the pre-Mahommedan prophets, by Ḥasanî Shabîstârî 'Aynî (before the 8th century of the Hegira); Ibn Ḥusam's *Kāwârnâme* (1427; 830 A.H.), of the deeds of 'Alî; Bâdhil's *Ḥamla-i-Ḥaidarî*, which was completed by Najaf (1723; 1135 A.H.), or the life of Mahommed and the first four caliphs; Kâzîm's *Farâshnâme-i-Fâtîma*, the book of joy of Fâtîma, Mahomet's daughter (1737; 1150 A.H.)—all four in the epic metre of the *Shâhnâme*; and the prose stories of Ḥâimî *Tâ'î*, the famous model of liberality and generosity in pre-Islamic times; of *Amr Ḥamzah*, the uncle of Mahomet; and of the *Mu'jizât-i-Mûsawî*, or the miraculous deeds of Moses, by Mu'în-al-misḳîn (died about 1501; 907 A.H.).

Quite a different turn was taken by the ambition of another class of imitators of Firdousî, especially during the last four centuries of the Hegira, who tried to create a new heroic epopee by celebrating in rhythm and rhyme stirring events of recent date. The gigantic figure of Timûr inspired Ḥâifî (d. 1521; 927 A.H.) with his *Timûrnâme*; the stormy epoch of the first Safawid rulers, who succeeded at last in reuniting for some time the various provinces of the old Persian realm into one great monarchy, furnished Kâsimî (died after 1560; 967 A.H.) with the materials of his *Shâhnâme*, a poetical history of Shâh Isma'îl and Shâh Tahmâsp. Another *Shâhnâme*, celebrating Shâh 'Abbâs the Great, was written by Kamâll of Sabzevâr; and even the cruelties of Nâdir Shâh were duly chronicled in a pompous epic style in 'Ishratî's *Shâhnâme-i-Nâdirî* (1749; 1162 A.H.). But all these poems are surpassed in length by the 33,000 distichs of the *Shâhînshâhnâme* by the poet-laureate of Fath 'Alî Shâh of Persia (1797-1834), and the 40,000 distichs of the *Georgiânâme*, a poetical history of India from its discovery by the Portuguese to the conquest of Poona by the English in 1817. In India this kind of epic versification has flourished since the beginning of Humâyûn's reign (1530-1556); e.g. the *Zafarnâme-i-Shâhjahânî* by Kudîs (d. 1646; 1056 A.H.); the *Shâhînshâhnâme* by Talîb Kalîm (d. 1651; 1061 A.H.), another panegyrist of Shâh Jahân; Atâsh's *'Adî-nâme*, in honour of Shâh Mahommed 'Adîl of Bijâpûr, who ascended the throne in 1629 (1039 A.H.) or 1627; the *Tawârîkh-i-Kuṣhî Kuṣhîshâh*, a metrical history of the Kuṣh shâhs of Golconda; and many more, down to the *Falḥnâme-i-Tîpû Sulṭân* by Ghulâm Ḥasan (1784; 1198 A.H.).

But the national epopee was not the only bequest the great Firdousî left to his nation. This rich genius gave also the first impulse to *romantic, didactic and mystic poetry*; and even his own age produced powerful co-operators in these three most conspicuous departments of Persian literature. *Romantic fiction*, which achieved its highest triumph in Niẓâmî of Ganja's (1141-1203; 535-599 A.H.) brilliant pictures of the struggles and passions in the human heart

¹ After 1572 (979 A.H.) according to H. E. in *Grundriss*, ii. 237.

(see NIZAMI), sent forth its first tender shoots in the numerous love stories of the *Shāhnāma*, the most fascinating of which is that of Zal and Rūdābeh, and developed almost into full bloom in Firdousi's second great mathnawī *Yāsuf u Zalikha*, which the aged poet wrote after his flight from Ghazni, and dedicated to the reigning caliph of Bagdad, al Qadir billah. It represents the oldest poetical treatment of the Biblical story of Joseph, which has proved so attractive to the epic poets of Persia, among others to 'Am'ak of Bokhārā (d. 1149), who was the first after Firdousi to write a *Yāsuf u Zalikha* to Jāmi (d. 1492), Mauji Kāsim Khān, Humāyūn's amir (d. 1571), Nāẓim of Herāt (d. 1670), and Shaukat, the governor of Shirāz under Fath 'Alī Shāh. Perhaps prior in date to Firdousi's *Yāsuf* was his patron 'Unsurī's romance, *Wāmiḡ u Adhrā*, a popular Iranian legend of great antiquity, which had been first written in verse under the Tāhirid dynasty. This favourite story was treated again by Fasḡi Jurjāni (5th century of the Hegira), and by many modern poets—as Damirī, who died under the Safawī shāh Mahommed (1577-1586; 985-994 A.H.), Nāmi, the historiographer of the Zand dynasty, and Ḥosain of Shirāz under Fath 'Alī Shāh, the last two flourishing towards the beginning of the present century. Another love story of similar antiquity formed the basis of Fakr-uddīn As'ad Jorjāni's *Wis u Rāmin*, which was composed in Isfahān about 1048 (440 A.H.)—a poem remarkable not only for its high artistic value but also for its resemblance to Gottfried von Strassburg's *Tristan und Isolde*.

The last-named Persian poet was apparently one of the earliest eulogists of the Seljuks, and it was under this Turkish dynasty *Eccelesiasts* that lyrical romanticism rose to the highest pitch. What Firdousi and the court-poets of Sultan Maḥmūd and Mas'ūd b. Sa'd b. Salḡān (under Sultan Ibrāhīm, 1059-1099) had successfully continued, reached its perfection in the famous group of panegyrist who gathered in the first half of the 6th century of the Hegira round the throne of Sultan Sinjar, and partly also round that of his great antagonist, Atsiz, shāh of Khwārizm. This group included Adīb Šābir, who was drowned by order of the prince in the Oxus about 1145 (540 A.H.), and his pupil Jaubart, the goldsmith of Bokhārā; Amir Mu'izzī, the king of poets at Sinjar's court, killed by a stray arrow in 1147 (542 A.H.), Rashid Waṭwāt (the Swallow) who died in 1182 (578 A.H.), and left, besides his *kaṣīda*, a valuable treatise on poetry (*Ḥadīq-ih-essīr*) and a metrical translation of the sentences of 'Alī, 'Abd-alwāsi' Jabālī, who sang at first, like his contemporary Hasan Ghaznawī (d. 1109; 505 A.H.), the praise of the Ghaznevid shāh Bahrām, but afterwards bestowed his eulogies upon Sinjar, the conqueror of Ghazni; and Aḥmad-uddīn Anwarī, the most celebrated *kaṣīda*-writer of the whole Persian literature. Anwarī (died between 1189 and 1191; 585 and 587 A.H.), who in early life had pursued scientific studies in the madrasa of Tūs, and who ranked among the foremost astronomers of his time, owes his renown as much to the inexhaustible store of poetical similes and epitheta ornamenta which he showered upon Sinjar and other royal and princely personages, as to his cutting sarcasms, which he was careful to direct, not against individuals, but against whole classes of society and the cruel wrong worked by an inexorable fate—thus disregarding the example of Firdousi, whose attack upon Sultan Maḥmūd for having cheated him out of the reward for his eposopee is the oldest and most finished specimen of personal satire. This legitimate branch of high art, however, soon degenerated either into the lower forms of parody and travesty—for which, for instance, a whole group of Transoxanian writers, Sūzān of Samarqānd (d. 1174; 569 A.H.) and his contemporaries, Abū 'Alī Shatrānjī of the same town, Lāmi of Bokhara, and others gained a certain literary reputation—or into mere comic pieces and jocular poems like the "Pleasantries" (*Ḥaziyiyāt*) and the humorous stories of the "Mouse and Cat" and the "Stone-cutter" (*Sanjtarash*) by 'Ubaid Zakānī (d. 1370; 772 A.H.). Anwarī's greatest rival was Khākānī (d. 1199; 595 A.H.), the son of a carpenter in Shirvān, and panegyrist of the shāhs of Shirvān, usually called the Pindar of the East. To European taste only the shorter

epigrams and the double-rhymed poem *Tuḡfat-irākain*, in which Khākānī describes his journey to Mecca and back, give full satisfaction. Among his numerous contemporaries and followers may be noticed Muḡir-uddīn Bālīkānī (d. 1198; 594 A.H.); Zāhir Fāryābī (d. 1202; 598 A.H.) and Athir Akhsikānī (d. 1211; 608 A.H.)—all three panegyrist of the atābegs of Azerbaijan, and especially of Sultan Kizil Arslan—Kamāl-uddīn Isfahānī, tortured to death by the Moguls in 1237 (635 A.H.), who sang, like his father Jamāl-uddīn, the praise of the governors of Isfahān, and gained the epithet of the "creator of fine thoughts" (Khallāṡ-ulma'āni); and Saif-uddīn Isfarāngī (d. 1267, 660 A.H.), a favourite of the shāhs of Khwārizm.

Fruitful as the 6th and 7th centuries of the Hegira were in panegyrics, they attained an equally high standard in didactic and mystic poetry. The origin of both can again be traced to Firdousi and his time. In the ethical reflections, wise maxims and moral exhortations scattered throughout the *Shāhnāma* the didactic element is plainly visible, and equally plain in it are the traces of that mystical tendency which was soon to pervade almost all the literary productions of Persian genius. But the most characteristic passage of the eposopee is the mysterious disappearance of Shāh Kaikhosrau, who suddenly, when at the height of earthly fame and splendour, renounces the world in utter disgust, and, carried away by his fervent longing for an abode of everlasting tranquillity, vanishes for ever from the midst of his companions. The first Persian who employed poetry exclusively for the illustration of Šūfic doctrines was Firdousi's contemporary, the renowned sheikh Abū Sa'd b. Abū l-Khair of Mahna in Khorāsān (968-1049; 357-440 A.H.), the founder of that specific form of the ruba'i which gives the most concise expression to religious and philosophic aphorisms—a form which was further developed by the great free-thinker 'OMAR B. KHAYYĀM (q.v.), and Afḡal-uddīn KĪSH (d. 1307; 707 A.H.). The year of Abū Sa'd's death is most likely that of the first great didactic mathnawī, the *Rāṣha a'nāma*, or "Book of Enlightenment," by NAṢIR KHOSRAU (q.v.), a poem full of sound moral and ethical maxims with slightly mystical tendencies. About twenty-five years later the first theoretical handbook of Šūfism in Persian was composed by 'Alī b. 'Uthmān al-Jullābī al-Hujwiri in the *Kaṣḡ-almabḡūḡ*, or "Revelation of Hidden Things," which treats of the various schools of Šūfis, their teachings and observances. A great mist of the same period, Sheikh 'Abdallāh Anṡārī of Herāt (1006-1080; 396-481 A.H.), assisted in spreading the pantheistic movement by his *Mundūdī* or "Invocations to God," by several prose tracts, and by an important collection of biographies of eminent Šūfis, based on an older Arabic compilation, and serving in its turn as groundwork for Jāmi's excellent *Nafahāt-alsun* (completed in 1478; 883 A.H.). He thus paved the way for the publication of one of the earliest textbooks of the whole sect, the *Ḥadīq-almabḡūḡ*, or "Garden of Truth" (1130; 525 A.H.), by Ḥakīm Sanā'i of Ghazni, to whom all the later-Šūfic poets refer as their unrivalled master in spiritual knowledge. As the most uncompromising Šūfis appear the greatest pantheistic writer of all ages, Jelāl ud-dīn Rūmī (1207-1273; 604-672 A.H.; see RŪMĪ), and his scarcely less renowned predecessor Farīd ud-dīn 'Aṡṡar, who was slain by the Moguls at the age of 114 lunar years in 1290 (627 A.H.). This prolific writer, having performed the pilgrimage to Mecca, devoted himself to a stern ascetic life, and to the composition of Šūfic works, partly in prose, as in his valuable "Biography of Eminent Mystic Divines," but mostly in the form of mathnawīs (upwards of twenty in number), among which the *Pandnāma*, or "Book of Counsels," and the *Mantik-ut-tayyib*, or the "Speeches of Birds," occupy the first rank. In the latter, an allegorical poem, interspersed with moral tales and pious contemplations, the final absorption of the Šūfi in the deity is most ingeniously illustrated.

In strong contrast to these advanced Šūfis stands the greatest moral teacher of Persia, Sheikh Sa'dī of Shirāz (died about 120 lunar years old in 1292; 691 A.H.; see SA'DĪ), whose two best known works are the *Bāṡīda*, or "Fruit-garden," and

the *Gulistan*, or "Rose-garden." However, both have found comparatively few imitations—the former in the *Dastār-nāma*, or "Book of Exemplars," of Nizāri of Kohistan (d. 1320; 720 A.H.), in the *Dah Bāb*, or "Ten Letters," of Kātibī (d. 1434; 838 A.H.), and in the *Gulār*, or "Rose-bower," of Hairatī (murdered 1554; 961 A.H.); the latter in Mu'In-uddīn Juwainī's *Nigāristān*, or "Picture-gallery" (1335; 735 A.H.) and Jamī's *Bahāristān*, or "Spring-garden" (1487; 892 A.H.); whereas an innumerable host of purely Sūfic compositions followed in the wake of Sanā'ī's, 'Attār's and Jalāl ud-dīn Rūmī's mathnawīs. It will suffice to name a few of the most conspicuous. The

Further *Lama'āt*, or "Sparks," of Irāqī (d. between 1287 and 1309; 686 and 709 A.H.), the *Zād-ul-mustafīn*, or "Store of the Wayfarers," by Husainī (d. 1318; 718 A.H.), the *Gulshan-i-Rās*, or "Rose-bed of Mystery," by Mahmūd Shabīstārī (d. 1320; 720 A.H.), the *Jam-i-Jam*, or "Cup of Jamshīd," by Auhādī (d. 1338; 738 A.H.), the *Avīs-ul-'Arīfīn*, or "Friend of the Mystics," by Kāsim (Qāsim)-i-Anwār (d. 1434; 837 A.H.), and others; 'Asqār's *Mīhr u Mushārīf*, or "Sun and Jupiter" (1376; 778 A.H.), 'Arīf's *Gāi u Chaugān*, or "The Ball and the Bat" (1438; 842 A.H.), *Husn u Dil*, or "Beauty and Heart," by Fatihā of Nishāpūr (d. 1448; 852 A.H.), *Sham u Parwana*, or "The Candle and the Moth," by Ahlī of Shirāz (1489; 894 A.H.), *Shāh u Gadd*, or "King and Dervish," by Hīlālī (put to death 1532; 939 A.H.), Bahā-ud-dīn 'Amīlī's (d. 1621; 1030 A.H.) *Nān u Halawā*, or "Bread and Sweets," *Sūr u Shākar*, or "Milk and Sugar," and many more.

During all these periods of literary activity, lyric poetry, pure and simple, had by no means been neglected; almost all the renowned poets since the time of Rūdāqī had sung in endless strains the pleasures of love and wine, the beauties of nature, and the almighty power of the Creator; but it was left to the incomparable genius of Hāfīz (d. 1389; 791 A.H.; see HĀFĪZ) to give to the world the most perfect models of lyric composition; and the lines he had laid down were more or less

strictly followed by all the ghazal-writers of the 9th and 10th centuries of the Hegīra—by Salmān of Sāwa (d. about 1377; 779 A.H.), who excelled besides in *kašīda* and mathnawī; Kamāl Khujandī (d. 1400; 803 A.H.), Hāfīz's friend, and protégé of Sultan Ḥosain (1374-1382 A.D.); Mahommed Shīrīn Maghribī (d. at Tabriz in 1406; 809 A.H.), an intimate friend of Kamāl; Ni'mat-ullāh Wallī (d. 1431; 834 A.H.), the founder of a special religious order; Kāsim-i-Anwār (see above); Amr Shāhī (d. 1453; 857 A.H.), of the princely family of the Sarbadars of Sabzewār; Bannā'ī (d. 1512; 918 A.H.), who also wrote a romantic poem, *Bakrām u Bīkrās*; Bāb Fīghānī of Shirāz (d. 1519; 925 A.H.), usually called the "Little Hāfīz"; Nargīst (d. 1531; 938 A.H.); Lisānī (d. 1534; 941 A.H.), who himself was imitated by Damīrī of Isfahān, Muhtasham Kāshī and Waḥshī Bāfīkī (all three died in the last decade of the 10th century of the Hegīra); Ahlī of Shirāz (d. 1535; 942 A.H.), author of the *Sīr-i-Hādī*, or "Lawful Witchcraft," which, like Kātibī's (d. 1434; 838 A.H.) *Majma'-ul-bakrāin*, of the "Confluence of the Two Seas," can be read in two different metres; Nan'ī (d. 1610; 1019 A.H.), who wrote the charming romance of a Hindu princess who burned herself in Akbar's reign with her deceased husband on the funeral pile, called *Sās u Gūdās*, or "Burning and Melting," &c. Among the immediate predecessors of Hāfīz in the 8th century of the Hegīra, in which also Ibn Yamin, the great *kit'ā*-writer, flourished, the highest fame was gained by the two poets of Delhi, Amr Hasan and Amr Khorasū. The latter, who died in 1325 (725 A.H.), two years before his friend Hasan, occupies the foremost place among all the Persian poets of India by the richness of his imagination, his graphic style, and the historical interest attached to his writings. Five extensive *diwāns* testify to his versatility in all branches of lyric poetry, and nine large mathnawīs to his mastership in the epic line. Four of the latter are poetical accounts of the reigns of

¹ A *kit'ā* or *muḳaṭṭa'a* is a poem containing moral reflections, and differs from the *kašīda* and *ghazal* only by the absence of a *matla'* or initial distich.

the emperors of Delhi, 'Alī-uddīn Khiljī (1296-1316), his predecessor Feroz Shāh and his successor Kutb-uddīn Mubārak Shāh—the *Miftāḥ-ul-futūḥ*, or "Key of Victories," the *Kirān-ussa'dāin*, or "The Conjunction of the Two Lucky Planets," the *Nuh Sīpūr*, or "Nine Spheres," and the love-story of *Khidrkhān u Dāwalrānī*. His other five mathnawīs formed the first attempt ever made to imitate Nizāmi's famous *Khamsah*, or five romantic epopees, and this attempt turned out so well that henceforth almost all epic poets wrote quintuples of a similar description. Khwājū Kirmānī (d. 1352; 753 A.H.) was the next aspirant to Nizāmi's fame, with five mathnawīs, among which *Humāi u Humāyān* is the most popular, but he had to yield the palm to 'Abd-urrahmān Jāmī (1414-1492; 817-898 A.H.), the last classic poet of Persia, in whose genius were summed up all the best qualities of his great predecessors. Many poets followed in Jāmī's footsteps, first of all his nephew Hātifī (see above), and either wrote whole *khamsahs* or imitated at least one or other of Nizāmi's epopees; thus we have a *Lailā u Majnūn*, for instance, by Maktabī (1490), Hīlālī (see above), and Rūh-ulamīn (d. 1637). But their efforts could not stop the growing corruption of taste, and it was only at the court of the Mogul emperors, particularly of the great Akbar (1556-1605), who revived Sultan Maḥmūd's "round table," that Persian literature still enjoyed some kind of "Indian summer" in poets like Ghasālī of Mashhad or Meshed (d. 1572); 'Urfl of Shirāz (d. 1591), who wrote spirited *kašīdas*, and, like his contemporaries Waḥshī and Kautharī, a mathnawī, *Farhād u Shīrīn*; and Faīḏī (d. 1595), the author of the romantic poem, *Nal u Daman*, who also imparted new life into the *rubā'i*. In Persia proper only Zuḥllī, whose clever romance of "Sultan Maḥmūd and his favourite Ayāz" (1592) is widely read in the East, Ṣā'ib (d. 1677), who is commonly called the creator of a new style in lyric poetry, and, among the most modern, Hāfīf of Isfahān, the singer of sweet and tasteful odes (died about 1785), deserve a passing notice.

But we cannot conclude our brief survey of the national literature of Persia without calling attention to the rise of the *drama*, which has only sprung up in the beginning of the nineteenth century. Like the Greek drama and the mysteries of the European middle ages, it is the offspring of a purely religious ceremony, which for centuries has been performed annually during the first ten days of the month Muharram—the recital of mournful lamentations in memory of the tragic fate of the house of the caliph 'Alī, the hero of the Shī'itic Persians. Most of these passion-plays deal with the slaughter of 'Alī's son Ḥosain and his family in the battle of Kerbelā. But lately this narrow range of dramatic subjects has been considerably widened, Biblical stories and even Christian legends have been brought upon the Persian stage; and there is a fair prospect of a further development of this most interesting and important movement. (See further DRAMA: *Persian*.)

In the various departments of general Persian literature not touched upon in the foregoing pages the same wonderful activity has prevailed as in the realm of poetry and fiction, since the first books on history and medicine appeared under the Sāmānids (see above). The most important section is that of historical works, which, although deficient in sound criticism and often spoiled by a highly artificial style, supply us with most valuable materials for our own research. Quite unique in this respect are the numerous histories of India, from the first invasion of Sultan Maḥmūd of Ghazni to the English conquest, and even to the first decades of the present century, most of which have been described and partly translated in the eight volumes of Sir H. M. Elliot's *History of India* (1867-1878). Persian writers have given us, besides, an immense variety of universal histories of the world, with many curious and noteworthy data (see, among others, Mīrkhond's and Khwāndamīr's works under MĪRKHOND); histories of Mahomet and the first caliphs, partly translated from Arabic originals, which have been lost; detailed accounts of all the Persian dynasties, from the Ghaznavids to the still reigning Kajars, of Jenghiz Khān and the Moguls (in Juwainī's and Waḥṣā'ī's elaborate *Ta'riḫās*), and

Samī and Lalar Poets.

The Drama.

Historical Works.

of Timur and his successors (see an account of the *Zafarnāma* under *PETIS DE LA CROIX*); histories of sects and creeds, especially the famous *Dabistān*, or "School of Manners" (translated by Shea and Troyer, Paris 1843); and many local chronicles of Iran and Tūrān. Next in importance to history rank geography, cosmography, and travels (for instance, the *Nushat-ul-fuhūḥ*, by Ḥamdallah Mustaufi, who died in 1349, and the translations of Istakhrī's and Karvīnī's Arabic works), and the various *tadhkiras* or biographies of Sūfīs and poets, with selections in prose and verse, from the oldest of 'Aufī (about 1220) to the last and largest of all, the *Makhsan-ul-gharā'ib*, or "Treasure of Marvellous Matters" (completed 1803), which contains biographies and specimens of more than 3000 poets. We pass over the well-stocked sections of philosophy, ethics and politics, of theology, law and Sūfism, of mathematics and astronomy, of medicine (the oldest thesaurus of which is the "Treasure of the shāh of Khwārizm," 1110), of Arabic, Persian and Turkish grammar and lexicography, and only cast a parting glance at the rich collection of old Indian folk-lore and fables preserved in the Persian version

of *Kālidāsa's Dinnak* (see *RŪDĀCĪ*), of the *Sindhūd-nāma*, the *Tāltūnāma*, or "Tales of a Parrot," and others, and at the translations of standard works of Sanskrit literature, the epics of the *Rāmāyana* and *Mahābhārata*, the *Bhagavad-Gītā*, the *Yoga-Vasishtha*, and numerous *Purānas* and *Upanishads*, for which we are mostly indebted to the emperor Akbar's indefatigable zeal.

AUTHORITIES.—The standard modern discussions of Persian literature are those of E. G. Browne, *Literary History of Persia* (1902, seq.), and Hermant Ethé, in vol. ii. of Geiger and Kuhn's *Grundriss der iranischen Philologie* (Strassburg, 1906); also the latter's *Höfische und romantische Poesie der Perser* (1887), and *Mystische, didaktische und lyrische Poesie und das spätere Schrifttum der Perser* (1888). See also P. Horn, *Geschichte der persischen Litteratur* (1901). Concise sketches of Persian poetry are contained in Sir G. Ouseley's *Biographical Notices of Persian Poets* (1846); in G. L. Flügel's article in Ersch and Gruber's *Allgemeine Encyclopädie* (1842); in N. Bland's papers in the *Journ. of the Roy. As. Soc.*, vii. 345 seq. and ix. 122 seq.; and in C. A. C. Barbier de Meynard's *Poesie en Perse* (Paris, 1877). Real mines of information are the catalogues of A. Sprenger (Calcutta, 1854); W. H. Morley (London, 1854); Flügel (3 vols., Vienna, 1865); and C. Rieu (3 vols., London, 1879-1883). For the first five centuries of the Hegira compare Ethé's *editions and metrical translations of "Kālidāsa's Vorläufer und Zeitgenossen," Morgenländische Forschungen* (Leipzig, 1875); of Kisā'i's songs, Firdousi's lyrics, and Abū Sa'īd b. Abū l-Khair's rubā'īs, in *Sitzungsberichte der bayr. Akademie* (1872, p. 275 seq.; 1873, p. 622 seq.; 1874, p. 133 seq.; 1875, p. 145 seq.; and 1878, p. 38 seq.); of Avicenna's Persian poems, in *Göttinger Nachrichten* (1875, p. 555 seq.); and of Asadi and his munshārāt, in "Persische Tenzen," *Verhandlungen des 1ten Orientalisten-Congresses* (Berlin, 1882, pt. ii., first half, p. 48 seq.); H. Zotenberg's *Chronique de Tabarī* (Paris, 1867-1874); Jurjānī's *Wis u Rāmin*, ed. in the *Bibl. Indica* (1864) (trans. into German by C. H. Graf in *Zeitschrift der morgenländischen Gesellschaft*, xxiii. 375 seq.); and A. de B. Kasimirski's *Spécimen du divān de Menouchchéri* (Versailles, 1876). On Khākāni, see N. de Khanykoff's "Mémoire," in *Journal asiatique*, 6th series, vol. iv. p. 137 seq. and vol. v. p. 296 seq. and C. Salemann's edition of his rubā'īs, with Russian trans. (Petersburg, 1875); on Farid uddin 'Attār, S. de Sacy's edition of the *Pandnāma* (Paris, 1819), and Garcin de Tassy's *Manāsh-uffair* (Paris, 1857); on the *Gulshan-i-rubā'*, E. H. Whinfield's edition (London, 1880); and on Amir Khosrau's mathnawī, the abstracts given in Elliot's *History of India*, iii. 524 seq. German translations of Ibn Yamin were published by O. Schlehta-Wasehrd, *Bruckstücke* (Vienna, 1852); of Jāmi's minor poems, by V. von Rosenzweig (Vienna, 1840); by F. Rückert, in *Zeitschrift für die Kunde des Morgenlandes*, vols. v. and vi., and *Zeitschrift der d. morgenl. Gesellsch.*, vols. ii., iv., v., vi., xvii., xxv. and xxix.; and by M. Wackerhauser (Leipzig, 1855, and Vienna, 1859); German translation of *Yāsfu Zālkhā*, by Rosenzweig (Vienna, 1824), English by R. T. H. Griffith (London, 1881); French translation of *Lailā u Majnun*, by A. L. de Chézy (Paris, 1806), German by A. T. Hartmann (Leipzig, 1807); Hilālī's "König und Derwisch," by Ethé, in *Morgenländ. Stud.* (Leipzig, 1870, p. 107 seq.). On the Persian drama, compare J. A. de Gobineau's *Religions et philosophies dans l'Asie centrale* (Paris, 1866); A. Chodzko's *Théâtre persan* (new ed., Paris, 1878); and Ethé, "Persische Passionspiele," in *Morgenländ. Stud.*, p. 174 seq. (H. E.)

PERSIGNY, JEAN GILBERT VICTOR FIALIN, DUCDE (1808-1872), French statesman, was born at Saint-Germain Lespinasse (Loire) on the 11th of January 1808, the son of a receiver of taxes. He was educated at Limoges, and entered the cavalry

school at Saumur in 1826, becoming *maréchal des logis* in the 4th Hussars two years later. The share taken by his regiment in supporting the revolution of 1830 was regarded as insubordination, and next year Fialin was dismissed from the army. He became a journalist, and in 1833 became a strong Bonapartist, assuming the title of comte de Persigny, said to be dormant in his family. He planned the attempt on Strassburg in 1836 and that on Boulogne in 1840. At Boulogne he was arrested and condemned to twenty years' imprisonment in a fortress, shortly afterwards commuted into mild detention at Versailles, where he wrote a book to prove that the Pyramids were built to prevent the Nile from silting up. This was published in 1845 under the title, *De la Destinatioin et de l'utilité permanente des Pyramides*. At the revolution of 1848 he was arrested by the provisional government, and on his release took a prominent part in securing the election of Louis Napoleon to the presidency. With Morny and the marshal Saint Arnaud he plotted the restoration of the empire, and was a devoted servant of Napoleon III. He succeeded Morny as minister of the interior in January 1852, and later in the year became senator. He resigned office in 1854, being appointed next year to the London embassy, which he occupied with a short interval (1858-1859) until 1860, when he resumed the portfolio of the interior. But the growing influence of his rival Rouher provoked his resignation in 1863, when he received the title of duke. A more dangerous enemy than Rouher was the empress Eugénie, whose marriage he had opposed and whose presence in the council chamber he deprecated in a memorandum which fell into the empress's hands. He sought in vain to see Napoleon before he started to take over the command in 1870, and the breach was further widened when master and servant were in exile. Persigny returned to France in 1871, and died at Nice on the 11th of January 1872.

See *Mémoires du duc de Persigny* (2nd ed., 1896), edited by H. de Laire d'Espagne, his former secretary; an eulogistic life, *Le Duc de Persigny* (1865), by Delarosa; and Emile Olivier's *Empire libéral* (1895, &c.).

PERSIMMON, the name given to the fruits of *Diospyros virginiana* in the United States. The tree which bears them belongs to the order Ebenaceae, is usually from 30 to 50 ft. in height, and has oval entire leaves, and unisexual flowers on short stalks. In the male flowers, which are numerous, the stamens are sixteen in number and arranged in pairs; the female flowers are solitary, with traces of stamens, and a smooth ovary with one ovule in each of the eight cells—the ovary is surmounted by four styles, which are hairy at the base. The fruit-stalk is very short, bearing a subglobose fruit an inch or rather more in diameter, of an orange-yellow colour, and with a sweetish astrigent pulp. It is surrounded at the base by the persistent calyxlobes, which increase in size as the fruit ripens. The astringency renders the fruit somewhat unpalatable, but after it has been subjected to the action of frost, or has become partially rotted or "bletted" like a medlar, its flavour is improved. The fruit is eaten in great quantities in the southern states of America, and is also fermented with hops, corn-meal or wheat-bran into a sort of beer or made into brandy. The wood is heavy, strong and very close-grained and used in turnery. The tree is very common in the South Atlantic and Gulf states, and attains its largest size in the basin of the Mississippi. It was brought to England before 1629 and is cultivated, but rarely if ever ripens its fruit. It is easily raised from seed and can also be propagated from stolons, which are often produced in great quantity. The Chinese and Japanese cultivate another species, the *Diospyros Kaki*, of which there exist numerous ill-defined varieties. The fruits are larger than those of the American kind, variable in shape, but have similar properties. An astringent fluid, known as *skibis*, rich in tannin, is expressed from the green fruit and used in various industries. The tree is hardy in the south of England and in the Channel Islands.

PERSIS (mod. Fars, &c.), the south-western part of Iran (Persia), named from the inhabitants, the Iranian people of the Pārsa (Fars), their name was pronounced by the Ionians *Persai*, with change from *s* to *e*, and this form has become dominant

in Greek and in the modern European languages. The natural features of Persis are described very exactly by Nearchus, the admiral of Alexander the Great (preserved by Arrian *Indic.* 40 and Strabo xv. 727). The country is divided into three parts, of very different character and climate: the coast is sandy and very hot, without much vegetation except date palms, it has no good harbours, and the climate is very unwholesome, the population is scanty. About 50 m. from the coast rise the chains of the mountains, through which some steep passes lead into the interior valleys (called *σοδά*) *Περσείας*, Strabo xv. 729), which lie about 5000 ft. above the sea. Here the climate is temperate, the country watered by many rivers and lakes, the soil fertile, the vegetation rich, the cattle numerous. These regions, which were thickly populated, form the real Persis of history. "This land Persis," says Darius, in an inscription at Persepolis, "which Ahuramazda has given to me, which is beautiful and rich in horses and men, according to the will of Ahuramazda and myself it trembles before no enemy." The third part is the north, which belongs to the central plateau, still much higher, and therefore rough and very cold in the winter. Towards the north-west it borders on the Median district of Paracetaene (about Isfahan); towards the north and north-east it soon passes into the great desert, of which only the oasis of Yezd (*Isatichai* in Ptolem. vi. 4, 2) is inhabitable. In the east, Persis proper is separated by a desert (Laristan) from the fertile province of Carmania (Kerman), a mountainous region inhabited by a Persian tribe. To Carmania belonged also the coast, with the islands and harbours of Hormuz and Bander Abbas. In the west Persis borders on the mountains and plains of Elam or Susiana. For the ancient topography cf. Tomaschek, "Beiträge zur historischen Topographie von Persien," in *Sitzungsber. der Wiener Akademie, phil. Cl. cil. cviii. cxxi*.

The Persians are not mentioned in history before the time of Cyrus; the attempt to identify them with the Parsua, a district in the Zagros chains south of Lake Urmia, often mentioned by the Assyrians, is not tenable. The Parsua are perhaps the non-Arian tribe *Πάρσους* in northern Media, Strabo xi. 508. Herodotus i. 125, gives a list of Persian tribes: the Pasargadae (at Murgab), Maraphii, Maspii, Panthialaei (in western Carmania), Derusiaei, Germanii (i.e. the Carmanians) are husbandmen, the Dahae (i.e. the "enemies," a general name of the rapacious nomads, used also for the Turanian tribes), Mardi, Dropici, Sagartii (called by Darius *Asagaria*, in the central desert; cf. Herod. vii. 85) are nomads. The kings of the Pasargadae, from the clan of the Achaemenidae, had become kings of the Elamitic district Anshan (probably in 596, cf. CYRUS). When, in 553, Cyrus, king of Anshan, rebelled against Astyages, the Maraphians and Maspianians joined with the Pasargadae; after his victory over Astyages all the Persian tribes acknowledged him, and he took the title of "king of Persia." But from then only the inhabitants of Persis proper were considered as the rulers of the empire, and remained therefore in the organization of Darius free from taxes (Herod. iii. 97). But Carmania, with the Sagartians, the Utians (called by Darius *Yauitaya*), and other tribes, formed a satrapy and paid tribute (Herod. iii. 93); the later authors therefore always distinguished between Carmania and Persis. Names of other Persian tribes, partly of very doubtful authority, are given by Strabo xv. 727, and Ptolem. vi. 4 and 8.

The Persians of Cyrus (see PERSIA: *Ancient History*) were a vigorous race of husbandmen, living in a healthy climate, accustomed to hardship, brave and upright; many stories in Herodotus (especially ix. 122) point the contrast between their simple life and the effeminate nations of the civilized countries of Asia. They were firmly attached to the pure creed of Zoroaster (cf. Herod. i. 131 sqq. and the inscriptions of Darius).

When Darius had killed the usurper Smerdis and gained the crown, a new usurper, Vahyazdāta, who likewise pretended to be Smerdis, the son of Cyrus, rose in *Yauitaya*, but was defeated in two battles by Darius's generals and put to death (Behistun inscription). Cyrus had built his capital with his palace and tomb, in Pasargadae (q.v.). Darius founded a new city about 30 m. farther south on the left bank of the Fuhwar, near its confluence with the Kur, with a large terrace, on which his magnificent palace and that of his son Xerxes were built. As Pasargadae was named after the tribe in whose district it lay, so the new capital is by the Persians and Greeks simply called "the Persians"; later authors call it Persepolis (q.v.), "the Persian city." Another Persian palace lay in Taake, near the coast (Strabo xv. 728, Arrian *Ind.* 39; Dionys. *Perieg.* 1069); Gabae, which Strabo mentions besides, is Isfahan in Paracetaene and belonged already to Media.

Both in Persepolis and Pasargadae large masses of gold and silver from the tribute of the subject nations were treasured, as in Susa and Ecbatana. But Persis lies too far off from the centre of the Asiatic world to be the seat of government. Like Arabia and similar countries, it could exercise a great momentary influence in history and produce a sudden change throughout the world; but afterwards it would sink into local insignificance. So the Persian kings fixed their residence at Susa, which is always considered as the capital of the empire (therefore Aeschylus wrongly considers it as a Persian town and places the tomb of Darius here). After the reign of Xerxes, Persis and Persepolis became utterly neglected, in spite of occasional visits, and even the palaces of Persepolis remained in part unfinished. But the national feeling of the Persians remained strong. When Alexander had won the victory of Arbela, and occupied Babylon and Susa, he met (in the spring of 330) with strong resistance in Persis, where the satrap Artobarnanes tried to stop his progress at the "Persian gates," the pass leading up to Persepolis. Here he set fire to the cedar roof of the palace of Xerxes as a symbol that the Greek war of revenge against the Persians had come to an end. Our best information tells us that he soon had the fire extinguished (Plut. *Alex.* 38); the story of This is a pure fiction, and we may well believe that he repented the damage he had done (Arrian vi. 30, 1).

Alexander had planned to amalgamate the former rulers of the world with his Macedonians; but his death was followed by a Macedonian reaction. Peucestas, the new satrap of Persis, followed the example of Alexander, and thus gained a strong hold on his subjects (Diod. xix. 48); nor did Seleucus, to whom the dominion of the east ultimately passed (from 311 onwards), disdain the aid of the Persians; he is the only one among the Diadochi who retained his Persian wife, Apame, daughter of Spitamenes. At the same time Seleucus and his son Antiochus I. Soter tried to introduce Hellenism into Persis. Of Greek towns which they founded here we know Alexandria in Carmania (Plin. vi. 107; Ptol. vi. 8, 14; Ammian. Marc. 23, 6, 40), Laodicea in the east of Persis (Plin. 6, 115), Stasis, "a Persian town on a great rock, which Antiochus, the son of Seleucus, possessed" (Steph. Byz. s.v.), Antiochia in Persis, founded apparently by Seleucus I. and peopled by Antiochus I. with immigrants called together from all Greece, as we learn from a *psphisma* passed by "boule and demos" of this town in 206 in honour of Magnesia on the Maeander (Kern, *Inschriften von Magnesia am Maeander*, No. 61=Dittenberger, *Orientalis gr. inscr.* 233, where they are mentioned together with a great many Seleucid towns in Susiana and Babylonia, and compare Kern, No. 18=Dittenberger, No. 231). An insurrection of the Persians against Seleucus (II.) is mentioned in two stratagems of Polyaeus (vii. 39, 40). When in 221 Molon, the satrap of Media, rebelled against Antiochus III., his brother Alexander, satrap of Persis, joined him, but they were defeated and killed by the king. Persis remained a part of the Seleucid empire down to Antiochus IV. Epiphanes, who at the end of his reign restored once more the authority of the empire in Babylonia, Susiana and Persis; perhaps a battle, in which the satrap Numenius of Mesene (southern Babylonia) defeated the Persians on the shore of Carmania on sea and land (Plin. vi. 152), belongs to this time. But after the death of Antiochus IV. (164) the

¹To the Pateiskhorais belongs the lance-bearer of Darius, "Gobryas (Gauharava) the Patisuhvari," mentioned in his tomb-inscription; they occur also in an inscription of Esarhaddon as Patuh-ara, eastwards of Media, in Choerene at the Caspian gates; the Kyrtii are the Kurds.

Seleucid Empire began to dissolve. While the central provinces, Media and northern Babylonia, were conquered by the Parthians, Mesene, Elymais and Persis made themselves independent.

Persis never became a part of the empire of the Arsacids, although her kings recognized their supremacy when they were strong (Strabo xv. 728, 736). From the periplus of the Erythraean Sea 33-37 we learn that their authority extended over the shores of Carmania and the opposite coasts of Arabia. A Persian king, Artaxerxes, who was murdered by his brother Gosithros at the age of 93 years, is mentioned in a fragment of Isidore of Charax (Lucian, *Macrobii*, 15). Other names occur on their coins, the oldest of which are imitations of Seleucid coins, and were perhaps struck by local dynasts under their supremacy; most of the others show the king's head with the Persian tiara, and on the reverse a fire-altar with the adoring king before it, a standard (perhaps the famous banner of the smith Kavi, which became the standard of Iran under the Sassanids), and occasionally the figure of Ahuramazda; they were first explained by A. D. Mordtmann in *Zeitschrift für Numismatik*, iii. iv. and vii.; cf. *Grundriss der iranischen Philol.* ii. 486 seq. The legends are in Atramaic characters and Persian (Pahlavi) language; among them occur Artaxerxes, Darius (from a dynast of this name the town Darabjird, "town of Darius," in eastern Persia seems to derive its name), Narses, Tiridates, Manocir and others; the name Vahubarz seems to be identical with *Oborzos*, mentioned by Polyneus vii. 40, who put down a rebellion of 3000 settlers (*κέρουσι*) in Persis. From the traditions about Artashir I. we know that at his time there were different petty kingdoms and usurpers in Persis; the principal dynasty is by Tabari called Bâzrangî. The coins demonstrate that Hellenism had become quite extinct in Persis, while the old historical and mythical traditions and the Zoroastrian religion were supreme. There can be no doubt that at this time the true form of Zoroastrianism and the sacred writings were preserved only in Persia, whereas everywhere else (in Parthia, in the Indo-Scythian kingdoms of the east and in the great propagandist movement in Armenia, Syria and Asia Minor, where it developed into Mithraism) it degenerated and was mixed with other cults and ideas. So the revival of Zoroastrianism came from Persis. When Artashir I. attempted to restore the old empire of Cyrus and Darius, and in 212 A.D. rose against the Parthian king, Artabanus, his aim was religious as well as political. The new Sassanid Empire which he founded enforced the restored religion of Zoroaster (Zarathustra) on the whole of Iran.

The new capital of Persis was Istakhr on the Pulwar, about 9 m. above Persepolis, now Hajjiabâd, where even the predecessors of Artashir I. are said to have resided. It was a great city under the Sassanids, of which some ruins are extant. But it shared the fate of its predecessor; when the empire was founded the Sassanids could no longer remain in Persis, but transferred their headquarters to Ctesiphon. (Ed. M.)

PERSIUS, in full AULUS PERSIUS FLACCUS (A.D. 34-62), Roman poet and satirist. According to the *Life* contained in the MSS., Persius was a native of Volaterrae, of good stock on both parents' side. When six years old he lost his father, and his step-father died in a few years. At the age of twelve Persius came to Rome, where he was taught by Remmius Palaemon and the rhetor Verginius Flavius. Four years later began a close intimacy with the Stoic Cornutus. In this philosopher's pupil Lucan, Persius found a generous admirer of all he wrote. Still in early youth he became the friend of the lyric poet Caesius Bassus, whilst with Thrasea Paetus (whose wife Arria was a relative) he had a close friendship of ten years' duration and shared some travels. Seneca he met later, and was not attracted by his genius. In his boyhood Persius wrote a tragedy dealing with an episode of Roman history, and a work, the title of which is rendered uncertain by corruption in our MSS. Pithou's generally accepted reading makes the subject that of travel; the excursions with Thrasea however must have taken place after boyhood. The perusal of Lucilius revealed to Persius his

vocation, and he set to work upon a book of satires. But he wrote seldom and slowly, a premature death (*causa stomachi*) prevented the completion of his task. He is described as possessed of a gentle disposition, girlish modesty and personal beauty, and living a life of exemplary devotion towards his mother Fulvia Sisenna, his sister and his aunt. To his mother and sister he left a considerable fortune. Cornutus supervised all his work except the book of satires in which he made some slight alterations and then handed it over to Bassus for editing. It proved an immediate success.

The scholia add a few details—on what authority is, as generally with such sources, very doubtful. The *Life* itself, though not free from the suspicion of interpolation and undoubtedly corrupt and disordered in places, is probably trustworthy. The MSS. say it came from the commentary of Valerius Probus, no doubt a learned edition of Persius like those of Virgil and Horace by this same famous "grammarian" of Berytus, the poet's contemporary. The only case in which it seems to conflict with the *Satires* themselves is in its statement as to the death of Persius's father. The declamation of a *suasoria* in his presence (*Sat.* 3. 4 seq.) implies a more mature age than that of six in the performer. But *pauper* might here mean "step-father," or Persius may have forgotten his own autobiography, may be simply reproducing one of his models. The mere fact that the *Life* and the *Satires* agree so closely does not of course prove the authenticity of the former. One of the points of harmony is, however, too subtle for us to believe that a large evolved it from the works of Persius. It requires indeed a thoughtful reading of the *Life* before we realize how distinct is the impression it gives of a "bookish" youth, who has never strayed far, at least in spirit, from the domestic hearth and his women-folk. And of course this is notoriously the picture drawn by the *Satires*. So much better does Persius know his books than the world that he knew the names of his characters from Horace. A keen observer of that occurs within his narrow horizon, he cannot but discern the sunny side of life (cf. e.g. such hints as *Sat.* iii. 110); he shows, however, none of Juvenal's undue stress on unsavoury detail or Horace's easy-going acceptance of human weaknesses. The sensitive, home-bred nature of Persius shows itself perhaps also in his frequent references to ridicule, whether of great men by street *passus* or of the cultured by Philistines.

The chief interest of Persius's work lies in its relation to Roman satire, in its interpretation of Roman Stoicism, and in its use of the Roman tongue. The influence of Horace on Persius can, in spite of the silence of the *Life*, hardly have been less than that of Lucilius. Not only characters, as noted above, but whole phrases, thoughts and situations come direct from him. The resemblance only emphasizes the difference between the caricaturist of Stoicism and its preacher. Persius strikes the highest note that Roman satire reached; in earnestness and moral purpose rising far superior to the political rancour or good natured persiflage of his predecessors and the rhetorical indignation of Juvenal, he seems a forerunner of the great Christian Apologists. From him we learn a lesson Seneca never taught, how that wonderful philosophy could work on minds that still preserved the depth and purity of the old Roman *gravitas*. When the *Life* speaks of Seneca's genius as not attracting Persius, it presumably refers to Seneca the philosopher. Some of the parallel passages in the works of the two are very close, and hardly admit of explanation by assuming the use of a common source. With Seneca, Persius censures the style of the day, and imitates it. Indeed in some of its worst failings, straining of expression, excess of detail, exaggeration, he outdoes Seneca, whilst the obscurity, which makes his little book of not seven hundred lines so difficult to read and is in no way due to great depth of thought, compares very ill with the terse clearness of the *Epistolae morales*. A curious contrast to this tendency is presented by his free use of "popular" words. As of Plato, so of Persius we hear that he emulated Sophron; the authority is a late one (Lydus, *De mag.* i. 41), but we can at least recognize in the scene that opens *Sat.* 3. kinship with such work as Theocritus' *Adoniae* and the *Mimes* of Herodas.

Persius's satires are composed in hexameters, except for the seasons of the short prologue above referred to, in which he half ironically asserts that he writes to earn his bread, not because he is inspired. The first satire censures the literary tastes of the day as a reflection of the decadence of the national morals. The theme of Seneca's 114th letter is similar. The description of the *rector* and the literary twaddlers after dinner is vividly natural, but an interesting passage which cites specimens of smooth versification

and the languishing style is greatly spoiled by the difficulty of appreciating the points involved and indeed of distributing the dialogue (a not uncommon crux in Persius). The remaining satires handle in order (2) the question as to what we may justly ask of the gods (cf. Plato's second *Alcibiades*), (3) the importance of having a definite aim in life, (4) the necessity of self-knowledge for public men (cf. Plato's first *Alcibiades*), (5) the Stoic doctrine of liberty (introduced by generous allusions to Cornutus' teaching), and (6) the proper use of money. The *Life* tells us that the *Satires* were not left complete; some lines were taken (presumably by Cornutus or Bassus) from the end of the work so that it might be *quasi finitus*. This perhaps means that a sentence in which Persius had left a line imperfect, or a paragraph which he had not completed, had to be omitted. The same authority says that Cornutus definitely blacked out an offensive allusion to the emperor's literary taste, and that we owe to him the reading of the MSS. in *Sat.* i. 121,—"auriculas aini quis non [for *Mida rex*] habet!" Traces of lack of revision are, however, still visible; cf. e.g. v. 176 (sudden transition from ambition to superstition) and vi. 37 (where criticism of Greek doctors has nothing to do with the context). The parallels to passages of Horace and Seneca are recorded in the commentaries. In view of what the *Life* says about Lucan, the verbal resemblance of *Sat.* iii. 3 to *Phars.* i. 163 is interesting. Examples of bold language or metaphor: i. 25, *rupio secrete exeret caprificus*; 60, *linguae quantum sibi comit; iii. 42, unius palliat, 81, scientia rodit; v. 92, ueteres aures de pulchro reuello*. Passages like iii. 87, 100 sqq. show elaboration carried beyond the rules of good taste. "Popular" words: *bars, cido, ebullire, gluto, lallare, mamma, nutrire, obba, palpo, sllappus*. Fine lines, &c., in i. 116 sqq., ii. 6 sqq., 61 sqq., 73 sqq., iii. 39 sqq.

AUTHORITIES.—The MSS. of Persius fall into two groups, the one represented by two of the best of them, the other by that of Pithocus, so important for the text of Juvenal. Since the publication of J. Bieger's *de Persii cod. pith. recta aestimando* (Berlin, 1890) the tendency has been to prefer the tradition of the latter.

The important editions are. (1) with explanatory notes: Casaubon (Paris, 1605, enlarged edition by Dübner, Leipzig, 1833); O. Jahn (with the scholia and valuable prolegomena, Leipzig, 1843). Conington (with translation, 3rd ed., Oxford, 1893), B. L. Gildersleeve (New York, 1875), G. Némethy (Buda-Pesth, 1903), 2) with critical notes: Jahn-Bücheler (3rd ed., Berlin, 1893), S. G. Owen (with Juvenal, Oxford, 1902). Translations into English by Dryden (1693); Conington (*loc. cit.*) and Hemphill (Dublin, 1901). Criticism, &c., in Marthia, *Les Moralistes sous l'empire romain* (5th ed., Paris, 1886); Nisard, *Poètes latins de la décadence* (Paris, 1834); Hirsch, *Der Dialog* (Leipzig, 1895); Sainsbury, *History of Criticism*, i. 218; Henderson, *Life and Principate of the Emperor Nero* (London, 1903); and the histories of Roman literature (especially Schanz, §§ 382 sqq.). A *Bibliography of Persius*, by M. H. Morgan (Cambridge, U.S.A., 1893). (W. C. Su.)

PERSON, OFFENCES AGAINST THE. This expression is used in English law to classify crimes involving some form of assault or personal violence or physical injury, i.e. offences affecting the life, liberty or safety of an individual: but it is also extended to certain offences against morality which cannot technically be described as assaults. The bulk of the offences thus classified, so far as their definition or punishment depends upon statute law, are included in the Offences Against the Person Act 1861 (24 & 25 Vict. c. 200), and in the Criminal Law Amendment Acts of 1880 and 1885, and the Prevention of Cruelty to Children Act 1904. The classification in these statutes is not scientific: e.g. bigamy is within the act of 1861 (s. 57), and certain offences involving assault, e.g. robbery, are to be found in other statutes. The particular offences dealt with by the acts above named are discussed under their appropriate titles, e.g. abortion, assault, bigamy, homicide, rape, &c. In the Indian penal code most of the offences above referred to fall under the head "offences against the human body" (ch. xvi.). In his *Digest of the Criminal Law* Sir James Stephen includes most of these offences under the title "offences against the person, the conjugal and parental rights, and the reputation of individuals," a classification also to be found in the English draft code of 1880 and adopted in the Queensland code of 1890. In working out this classification offences not involving assault are relegated to another and perhaps more appropriate title, "offences against morality."

PERSONALITY (from Lat. *persona*, originally an actor's mask, from *personare*, to sound through), a term applied in

¹ So Gaius Bassus in *Gell. Noct. Att.* v. 7, 1. Since, however, it is difficult to explain *persona* from *personare* (Skeat suggests by analogy from *epersonare* the Greek equivalent!), Walde, in

philosophy and also in common speech to the identity or individuality which makes a being (person) what he is, or marks him off for all that he is not. The term "person," which is technically used not only in philosophy but also in law, is applied in theology (Gr. *πρόσωπον*) to the three hypostases of the Trinity. It was first introduced by Tertullian, who implied by it a single individual; the Father, the Son and the Holy Ghost were three *personae* though of one and the same substance (*unitas substantiae*). The nature of this unity in difference exercised the minds of the early Christian theologians, and was the subject of many councils and official pronouncements, according as emphasis was laid on the unity or on the separateness of the persons. There was perpetual schism between the Unitarians and Trinitarians (see for example SABELLIUS). The natural sense of the word "person" is undoubtedly individuality; hence those who found a difficulty in the philosophic conception of the three-in-one naturally tended to lay emphasis on the distinctions between the members of the Trinity (see HÆRESY; MONARCHIANISM; LOGOS, &c.). A further theological question arises in connexion with the doctrine of immortality (q.v.), and it is argued that immortality is meaningless unless the soul of the dead man is self-conscious throughout.

In philosophy the term has an important ethical significance. The Greek moralists, attaching little importance to individual citizens as such, found the highest moral perfection in the subordination of the individual to the state. Man, as *πολιτικὸν ζῷον*, is good only when he is a good *πολίτης*. Subsequent ethical systems on the contrary have laid stress on the moral worth of personality, finding the *summum bonum* in the highest realization of the self. This view is specially characteristic of the Neo-hegelian school (e.g. T. H. Green), but it belongs also in various degrees to all intuitional and idealistic systems. Utilitarian universalistic hedonism and evolutionist ethics so far resemble the Greek theory that they tend to minimize the importance of personality, by introducing ulterior reasons (e.g. the perfection of the social organism, of humanity) as the ultimate sanctions of moral principles, whereas the intuitionists by making the criterion abstract and absolute limit goodness to personal obedience to the a priori moral law.

Still more important problems are connected with the psychological significance of personality. What is the origin and character of the consciousness of the self? The consciousness of the identity of another person is comparatively simple; but one's own individuality consists partly in being aware of that individuality; a man cannot use the word "I" unless he is conscious of the unity of his "self," and yet there is involved in the word "I" something more than this consciousness. In what does the unity of the "self" consist prior to its being recognized in consciousness; how does the consciousness arise? The answer to this problem is to be found—in so far as it can be found—in the subject-object relation, in the distinction between the external world and the subjective processes of knowing and willing which that relation involves. I will something, and afterwards perceive a corresponding change within the unity of my external world. Hence, we may suppose, arises the consciousness of a permanent self and not-self.

It should be observed that self-consciousness varies according to the intellectual development, and the term "personality" is usually connected only with the self-consciousness of an advanced type, not, for example, with that of an animal. Even among human beings there is considerable difference. The most elementary form of human self-consciousness includes in the self not only the soul but also the body, while to the developed self-consciousness the physical self is part of the external or objective world. Finally it is necessary to refer to the Kantian distinction of the pure and the empirical ego, the latter ("the Me known") being an object of thought to the former ("the I knowing").

From the use of the term "person" as distinguishing the *lateinisches etymologisches Wörterbuch* (1906), suggests a derivation from Greek *ἴσως*, a zone. In Roman law *persona* was one who had civil rights. For the ecclesiastical *persona ecclesiae*, see PARSON.

self from the not-self arises the phrase "personal equation" for those peculiar characteristics or idiosyncrasies which have to be taken into account in estimating the value of an individual judgment or observation. This phrase, which is commonly used in any connexion, was first applied to the errors detected in the astronomical observations of a Greenwich observer named Kinnebrook in 1795. The recognized fact that the greater or less inaccuracy is habitual to individual observers has been investigated, e.g. by Bessel (*Abhandlungen*, iii. 300) and by Wundt (*Physiol. Psychol.*), and machines have been devised which make allowance for the error caused by the personal equation (see MICROMETER).

For the psychological problem, see PSYCHOLOGY. For the problems connected with sub-conscious action, &c., see SUBLIMINAL SELF; TRANCE; HYPNOTISM; TELEPATHY.

PERSONAL PROPERTY, one branch of the main division of the English law of property, the other being "real property." The division of property into real and personal represents in a great measure the division into immovable and movable incidentally recognized in Roman law and generally adopted since. "Things personal," according to Blackstone, "are goods, money, and all other movables which may attend the owner's person wherever he thinks proper to go" (*Comm.* ii. 16). This identification of things personal with movables, though logical in theory, does not, as will be seen, perfectly express the English law, owing to the somewhat anomalous position of chattels real. In England real property is supposed to be superior in dignity to personal property, which was originally of little importance from a legal point of view. This view is the result of feudal ideas, and had no place in the Roman system, in which immovables and movables were dealt with as far as possible in the same manner, and descended according to the same rules. The main differences between real and personal property which still exist in England are these. (1) In real property there can be nothing more than limited ownership; there can be no estate properly so called in personal property, and it may be held in complete ownership. There is nothing corresponding to an estate-tail in personal property; words which in real property would create an estate-tail will give an absolute interest in personalty. A life-interest may, however, be given in personalty, except in articles *quae ipso usu consumuntur*. Limitations of personal property, equally with those of real property, fall within the rule against perpetuities. (2) Personal property is not subject to various incidents of real property, such as rent, dower or escheat. (3) On the death of the owner intestate real property descends to the heir; personal property is divided according to the Statute of Distributions. (4) Real property as a general rule must be transferred by deed; personal property does not need so solemn a mode of transfer. (5) Contracts relating to real property must be in writing by the Statute of Frauds, 29 Car. II. c. 3, s. 4; contracts relating to personal property need only be in writing when it is expressly so provided by statute, as, for instance, in the cases falling under s. 17 of the Statute of Frauds. (6) A will of lands need not be proved, but a will of personalty or of personal and real property together must be proved in order to give a title to those claiming under it. (7) Devises of real estate fall as a rule within the Mortmain Acts (see CHARITY AND CHARITIES; CORPORATION); bequests of personal property, other than chattels real, are not within the act. (8) Mortgages of real property need not generally be registered; mortgages of personal property for the most part require registration under the Bills of Sale Acts (see PLEDGE, and BILL OF SALE).

Personal estate is divided in English law into *chattels real* and *chattels personal*; the latter are again divided into *choses in possession* and *choses in action* (see CHATTEL; CHOSE).

Interest in personal property may be either absolute or qualified. The latter case is illustrated by animals *ferae naturae*, in which property is only coextensive with detention. Personal property may be acquired by occupancy (including the *accessio, commixtio*, and *confusio* of Roman law), by invention, as patent and copyright, or by transfer, either by the act of the law (as in bankruptcy,

judgment and intestacy), or by the act of the party (as in gift, contract and will).

There are several cases in which, by statute or otherwise, property is taken out of the class of real or personal to which it seems naturally to belong. By the operation of the equitable doctrine of conversion money directed to be employed in the purchase of land, or land directed to be turned into money, is in general regarded as that species of property into which it is directed to be converted. An example of property *prima facie* real which is treated as personal is an estate *pur autre vie*, which, since 14 Geo. II. c. 20, s. 9, 1740-1741 (now replaced by the Wills Act 1837, s. 6) is distributable as personal property in the absence of a special occupant. Examples of property *prima facie* personal which is treated as real are fixtures, heirlooms, such as deeds and family portraits, and shares in some of the older companies, as the New River Company, which are real estate by statute. In ordinary cases shares in companies are personal property, unless the shareholders have individually some interest in the land as land.

The terms *heritable* and *movable* of Scots law to a great extent correspond with the real and personal of English law. The main points of difference are these. (1) Leases are heritable as to the accession to the lessee, unless the destination expressly exclude heirs, but are movable as to the fisk. (2) Money due on mortgages and securities on land is personalty in England. At common law in Scotland debts secured on heritable property are themselves heritable. But by the Titles to Land Consolidation (Scotland) Act 1868, s. 117, heritable securities are movable as far as regards the succession of the creditor, unless executors are expressly excluded. They still, however, remain heritable *quoad fiscum*, as between husband and wife, in computing legitime, and as far as regards the succession of the debtor. (3) Up to 1868 the heir of heritage succeeded to certain movable goods called heirship movables, which bore a strong likeness to the heirlooms of English law. This right of the heir was abolished by the act of 1868, s. 160. (4) Annuities, as having *tractum futuri temporis*, are heritable, and an obligation to pay them falls upon the heir of the deceased (Watson, *Law Dict.* s.v. "Annuities").

The law in the United States agrees in most respects with that of England. Heirlooms are unknown, one reason being, no doubt, that the importance of title-deeds is much less than it is in England, owing to the operation of the Registration Acts. Long terms in some states have annexed to them the properties of freehold estates. In some states estates *pur autre vie* descended like real property; in others an estate *pur autre vie* is deemed a freehold only during the life of the grantee; after his death it becomes a chattel real. In yet other states the heir has a *scintilla* of interest as special occupant (Kent, *Comm.* iv. 27). In some states railway rolling-stock is considered as purely personal, in others it has been held to be a fixture, and so to partake of the nature of real property. Shares in some of the early American corporations were, like New River shares in England, made real estate by statute, as in the case of the Cape Sable Company in Maryland (Schouler, *Law of Personal Property*, i.). In Louisiana animals employed in husbandry are, and slaves were, regarded as immovables. Pews in churches are generally real property, but in some states they are made personal property by statute. The assignment of choses in action is generally permitted, and is in most states regulated by statute. (J. W.)

PERSONATION, in English law, a form of fraud consisting in a false representation by one person (by words or conduct) that he is another person living or dead. It is not an offence by the common law unless the representation is made on oath under circumstances constituting the offence of perjury, or unless the representation if not made on oath is made under circumstances amounting to a common law cheat. Personation has been made an offence by statute in the following cases: (1) where it amounts to a false pretence by words or conduct, and is done with intent to defraud, and property is by such false pretence obtained, 24 & 25 Vict. c. 96 ss. 88-90 (see FALSE PRETENCES); (2) in the case of false and deceitful personation of any person or of the heir, executor, administrator, wife, widow, next of kin or relative of any person with intent fraudulently to obtain any land, estate, chattel, money, valuable security or property (37 & 38 Vict. c. 36 s. 1); (3) in the case of personation of votes at elections (see CORRUPT PRACTICES).

The first of these offences is a misdemeanour only; the second is a felony punishable by penal servitude for life. The second offence was created in 1874 in consequence of the Tichborne case, in which under the law as it then stood it had been necessary

to prosecute the claimant for perjury. Besides the enactments above referred to there are also a number of provisions for dealing with the personation of sailors, soldiers, pensioners and owners of stock in the public funds or shares in joint-stock companies, and of persons who falsely acknowledge in the name of another recognizances, deeds or instruments, before a court or person authorized to take the acknowledgment.

PERSPECTIVE (Lat. *perspicere*, to see through), in mathematics the name given to the art of representing solid objects by a plane drawing which affects the eye as does the object itself. In the article PROJECTION it is shown that if all points in a figure be projected from a fixed centre to a plane, each point on the projection will be the projection of all points on the projecting ray. A complete representation by a single projection is therefore possible only when there is but one point to be projected on each ray. This is the case by projecting from one plane to another, but it is also the case if we project the *visible* parts of objects in nature; for every ray of light meeting the eye starts from that point in which the ray, if we follow its course from the eye backward, meets for the first time any object. Thus, if we project from a fixed centre the *visible* part of objects to a plane or other surface, then the outlines of the projection would give the same impression to the eye as the outlines of the things projected, provided that one eye only be used and that this be at the centre of projection. If at the same time the light emanating from the different points in the picture could be made to be of the same kind—that is, of the same colour and intensity and of the same kind of polarization—as that coming from the objects themselves, then the projection would give sensibly the same impression as the objects themselves. The art of obtaining this result constitutes a chief part of the technique of a painter, who includes the rules which guide him under the name of perspective, distinguishing between *linear* and *aerial* perspective—the former relating to the projection, to the drawing of the outlines, the latter to the colouring and the shading off of the colours in order to give the appearance of distance. Here we deal only with the former, which is in fact a branch of geometry consisting in the applications of the rules of projection.

§ 1. Our problem is the following: *There is given a figure in space, the plane of a picture, and a point as centre of projection; it is required to project the figure from the point to the plane.*

From what has been stated about projection (*q.v.*) in general it follows at once that the projection of a point is a point, that of a line a line. Further, the projection of a point at infinity in a line is in general a finite point. Hence parallel lines are projected into a pencil of lines meeting at some finite point. This point is called the *vanishing point of the direction* to which it belongs. To find it, we project the point at infinity in one of the parallel lines; that is, we draw through the eye a line in the given direction. This cuts the picture plane in the point required.

Similarly all points at infinity in a plane are projected to a line (see PROJECTION: § 6) which is called the *vanishing line of the plane* and which is common to all parallel planes.

All lines parallel to a plane have their vanishing points in a line, viz. in the vanishing line of the plane.

All lines parallel to the picture plane have their vanishing points at infinity in the picture plane; hence parallel lines which are parallel to the picture plane appear in the projection as parallel lines in their true direction.

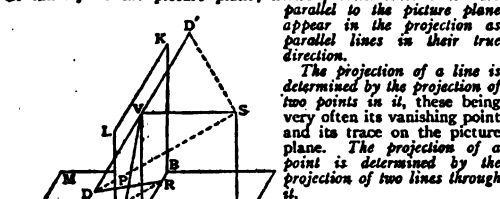

FIG. 1.

In perspective is called the *point of sight*, ABKL the picture plane, ABMN a horizontal plane on which we suppose the objects

to rest of which a perspective drawing is to be made. The lowest plane which contains points that are to appear in the picture is generally selected for this purpose, and is therefore called the ground plane, or sometimes the geometrical plane. It cuts the picture plane in a horizontal line AB called the ground line or base line or fundamental line of the picture. A horizontal line SV, drawn through the eye S perpendicular to the picture, cuts the latter at a point V called the centre of the picture or the centre of vision. The distance SV of the eye from the picture is often called the distance simply, and the height ST of the eye above the ground the height of the eye.

The vanishing line of the ground plane, and hence of every horizontal plane, is got by drawing the projecting rays from S to the points at infinity in the plane—in other words, by drawing all horizontal rays through S. These lie in a horizontal plane which cuts the picture plane in a horizontal line DD' through the centre of vision V. This line is called the horizon in the picture. It contains the vanishing points of all horizontal lines, the centre of vision V being the vanishing point of all lines parallel to SV, that is perpendicular to the picture plane. To find the vanishing point of any other line we draw through S the ray projecting the point at infinity in the line; that is, we draw through S a ray parallel to the line, and determine the point where this ray cuts the picture plane. If the line is given by its plan on the ground plane, and its elevation on the picture plane, then its vanishing point can at once be determined; it is the vertical trace of a line parallel to it through the eye (cf. GEOMETRY: § Description, § 6).

§ 2. To have construction in a single plane, we suppose the picture plane turned down into the ground plane; but before this is done the ground plane is pulled forward till, say, the line MN takes the place of AB, and then the picture plane is turned down. By this we keep the plan of the figure and the picture itself separate. In this new position the plane of the picture will be that of the paper (fig. 2). On it are marked the base line AB, the centre of vision V, and the horizon DD', and also the limits ABKL of the actual picture. These, however, need not necessarily be marked. In the plan the picture plane must be supposed to pass through A₁B₁, and to be perpendicular to the ground plane. If we further suppose that the horizontal plane through the eye which cuts the picture plane in the horizon DD' be turned down about the horizon, then the centre of sight will come to the point S, where VS equals the distance of the eye.

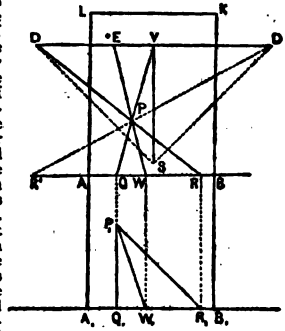

FIG. 2.

To find the vanishing point of any line in a horizontal plane, we have to draw through S a line in the given direction and see where it cuts the horizon. For instance to find the vanishing points of the two horizontal directions which make angles of 45° with the horizon, we draw through S lines SD and SD' making each an angle of 45° with the line DD'. These points can also be found by making VD and VD' each equal to the distance SV. The two points D, D' are therefore called the distance points.

§ 3. Let it now be required to find the perspective P of a point P₁ (figs. 1 and 2) in the ground plane. We draw through P₁ two lines of which the projection can easily be found. The most convenient lines are the perpendicular to the base line, and a line making an angle of 45° with the picture plane. These lines in the ground plane are P₁Q₁ and P₁R₁. The first cuts the picture at Q₁ or at Q, and has the vanishing point V; hence QV is its perspective. The other cuts the picture in R₁, or rather in R, and has the vanishing point D; its perspective is RD. These two lines meet at P, which is the point required. It will be noticed that the line QR = Q₁R₁ = Q₁P, gives the distance of the point P behind the picture plane. Hence if we know the point Q where a perpendicular from a point to the picture plane cuts the latter, and also the distance of the point behind the picture plane, we can find its perspective. We join Q to V, set off QR to the right equal to the distance of the point behind the picture plane, and join R to the distance point to the left; where RD cuts QV is the point P required. Or we set off QR' to the left equal to the distance and join R' to the distance point D' to the right.

§ 4. Let it now be required to find the perspective P of a point P₁ (figs. 1 and 2) in the ground plane. We draw through P₁ two lines of which the projection can easily be found. The most convenient lines are the perpendicular to the base line, and a line making an angle of 45° with the picture plane. These lines in the ground plane are P₁Q₁ and P₁R₁. The first cuts the picture at Q₁ or at Q, and has the vanishing point V; hence QV is its perspective. The other cuts the picture in R₁, or rather in R, and has the vanishing point D; its perspective is RD. These two lines meet at P, which is the point required. It will be noticed that the line QR = Q₁R₁ = Q₁P, gives the distance of the point P behind the picture plane. Hence if we know the point Q where a perpendicular from a point to the picture plane cuts the latter, and also the distance of the point behind the picture plane, we can find its perspective. We join Q to V, set off QR to the right equal to the distance of the point behind the picture plane, and join R to the distance point to the left; where RD cuts QV is the point P required. Or we set off QR' to the left equal to the distance and join R' to the distance point D' to the right.

If the distance of the point from the picture should be very great, the point R might fall at too great a distance from Q to be on the drawing. In this case we might set off QW equal to the *n*th part of the distance and join it to a point E, so that VE equals the *n*th part of VD. Thus if QW = 1/3QR and VE = 1/3VD, then WE will again pass through P. It is thus possible to find for every point in the ground plane, or in fact in any horizontal plane, the perspective;

self from the not-self and for those peculiar to be taken judicious use in

... we may also proceed in the construction of the plan above A₁ because the vertical line (A₁) if we erect at Q a perpendicular in its base and set off on it QA₂ the point A₂ above the ground plane.

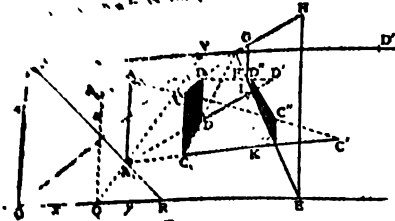

FIG. 3.

then the point A₁ is the elevation of A and hence the line A₁V will pass through the point A. The latter thus is determined by the intersection of the vertical line through A₁ and the line A₁V.

This process differs from the one mentioned before in that the construction for finding the point is not made in the horizontal plane in which it lies, but that its plan is constructed in the ground plane. But this has a great advantage. The perspective of a horizontal plane from the picture to the line at infinity occupies in the picture the space between the line where the plane cuts the picture and the horizon, and this space is the greater the farther the plane is from the eye, that is, the farther its trace on the picture plane lies from the horizon. The horizontal plane through the eye is projected into a line, the horizon; hence no construction can be performed in it. The ground plane on the other hand is the lowest horizontal plane used. Hence it offers most space for constructions, which consequently will allow of greater accuracy.

§ 5. The process is the same if we know the co-ordinates of the point, viz. we take in the base line a point O as origin, and we take the base line, the line OV, and the perpendicular OZ as axes of co-ordinates. If we then know the co-ordinates x, y, z measured in these directions, we make OQ = x, set off on QV a distance QA such that its real length QR = y, make QA₁ = z, and we find A as before. This process might be simplified by setting off to begin with along OQ and OZ scales in their true dimensions and along OV a scale obtained by projecting the scale on OQ from D to the line OV.

§ 6. The methods explained give the perspective of any point in space. If lines have to be found, we may determine the perspective of two points in them and join these, and this is in many cases the most convenient process. Often, however, it will be advantageous to determine the projection of a line directly by finding its vanishing point. This is especially to be recommended when a number of parallel lines have to be drawn.

The perspective of any curve is in general a curve. The projection of a conic is a conic, or in special cases a line. The perspective of a circle may be any conic, not necessarily an ellipse. Similarly the perspective of the shadow of a circle on a plane is some conic.

§ 7. A few words must be said about the determination of shadows in perspective. The theory of their construction is very simple. We have given, say, a figure and a point L as source of light. We join the point L to any point of which we want to find the shadow and produce this line till it cuts the surface on which the shadow falls. These constructions must in many cases first be performed in plan and elevation, and then the point in the shadow has to be found in perspective. The constructions are different according as we take as the source of light a finite point (say, the flame of a lamp), or the sun, which we may suppose to be at an infinite distance.

If, for instance, in fig. 3, A is a source of light, EHGF a vertical wall, and C a point whose shadow has to be determined, then the shadow must lie on the line joining A to C. To see where this ray meets the floor we draw through the source of light and the point C a vertical plane. This will cut the floor in a line which contains the feet A₁, C₁ of the perpendiculars drawn from the points A, C to the floor, or the plans of these points. At C₁ where the line A₁C₁ cuts AC, will be the shadow of C on the floor. If the wall EHGF prevents the shadow from falling on the floor, we determine the intersection K of the line A₁C₁ with the base EF of the wall and draw a vertical through it, this gives the intersection of the wall with the vertical plane through A and C. Where it cuts AC is the shadow C' of C on the wall.

If the shadow of a screen CDD'C' has to be found we find the shadow D' of D which falls on the floor; then D'D' is the shadow of D'D and D'C' is the shadow on the floor of the line DC. The shadow of D'D, however, is intercepted by the wall at L. Here then the wall takes up the shadow, which must extend to D' as the shadow of a line on a plane is a line. Thus the shadow of the screen is found in the shaded part in the figure.

§ 8. If the shadows are due to the sun, we have to find first the perspective of the sun, that is, the vanishing point of its rays. This will always be a point in the picture plane; but we have to distinguish between the cases where the sun is in the front of the picture, and so behind the spectator, or behind the picture plane, and so in front of the spectator. In the second case only does the vanishing point of the rays of the sun actually represent the sun itself. It will be a point above the horizon. In the other case the vanishing point of the rays will lie below the horizon. It is the point where a ray of the sun through the centre of sight S cuts the picture plane, or it will be the shadow of the eye on the picture. In either case the ray of the sun through any point is the line joining the perspective of that point to the vanishing point of the sun's rays. But in the one case the shadow falls away from the vanishing point, in the other it falls towards it. The direction of the sun's rays may be given by the plan and elevation of one ray.

For the construction of the shadow of points it is convenient first to draw a perpendicular from the point to the ground and to find its shadow on the ground. But the shadows of verticals from a point at infinity will be parallel; hence they have in perspective a vanishing point L_v in the horizon. To find this point, we draw that vertical plane through the eye which contains a ray of the sun. This cuts the horizon in the required point L_v and the picture plane in a vertical line which contains the vanishing point of the sun's rays themselves. Let then (fig. 4) L be the vanishing point

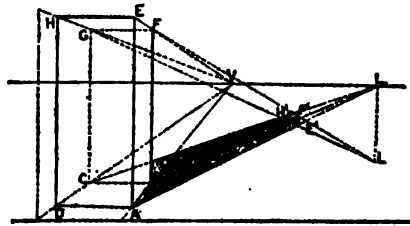

FIG. 4.

of the sun's rays, L_v be that of their projection in a horizontal plane, and let it be required to find the shadow of the vertical column AH. We draw AL_v and EL; they meet at E', which is the shadow of E. Similarly we find the shadows of F, G, H. Then E'F'G'H' will be the shadow of the quadrilateral EFGH. For the shadow of the column itself we join E' to A, &c., but only mark the outlines; F'B, the shadow of BF, does not appear as such in the figure.

If the shadow E has to be found when falling on any other surface we use the vertical plane through E, determine its intersection with the surface, and find the point where this intersection is cut by the line EL_v. This will be the required shadow of E.

§ 9. If the picture is not to be drawn on a vertical but on another plane—say, the ceiling of a room—the rules given have to be slightly modified. The general principles will remain true. But if the picture is to be on a curved surface the constructions become somewhat more complicated. In the most general case conceivable it would be necessary to have a representation in plan and elevation of the figure required and of the surface on which the projection has to be made. A number of points might also be found by calculation, using co-ordinate geometry. But into this we do not enter. As an example we take the case of a panorama, where the surface is a vertical cylinder of revolution, the eye being in the axis. The ray projecting a point A cuts the cylinder in two points on opposite sides of the eye, hence geometrically speaking every point has two projections; of these only the one lying on the half ray from the eye to the point can be used in the picture. But the other has sometimes to be used in constructions, as the projection of a line has to pass through both. Parallel lines have two vanishing points which are found by drawing a line of the given direction through the eye; it cuts the cylinder in the vanishing points required. This operation may be performed by drawing on the ground the plan of the ray through the foot of the axis, and through the point where it cuts the cylinder a vertical, on which the point required must lie. Its height above is easily found by making a drawing of a vertical section on a reduced scale.

Parallel planes have in the same manner a vanishing curve. This will be for horizontal planes a horizontal circle of the height of the eye above the ground. For vertical planes it will be a pair of generators of the cylinder. For other planes the vanishing curves will be ellipses having their centre at the eye.

The projections of vertical lines will be vertical lines on the

cylinder. Of all other lines they will be ellipses with the centre at the eye. If the cylinder be developed into a plane, then these ellipses will be changed into curves of sines. Parallel lines are thus represented by curves of sines which have two points in common. There is no difficulty in making all the constructions on a small scale on the drawing board and then transferring them to the cylinder.

§ 10. A variety of instruments have been proposed to facilitate perspective drawings. If the problem is to make a drawing from nature then a camera obscura or, better, Wollaston's camera lucida may be used. Other instruments are made for the construction of perspective drawings. It will often happen that the vanishing point of some direction which would be very useful in the construction falls at a great distance off the paper, and various methods have been proposed of drawing lines through such a point. For some of these see Stanley's *Descriptive Treatise on Mathematical Drawing Instruments*. (O. H.)

PERSPIRATION (Lat. *per*, through, and *spirare*, to breathe), the excretion of sweat from the sweat-glands of the skin. Sweat is a clear colourless neutral or slightly alkaline fluid containing 2% of solids. Under pathological conditions, sugar urea and other substances are found. The secretion of sweat is constantly going on, the activity of the sweat-glands being under control of the central nervous system. The only function of sweat is the regulation of the heat discharge from the body. The chief morbid conditions of the sweat-glands are excessive sweating (*Hyperidrosis*) and foetid sweating (*Bromidrosis*). Excessive sweating is a symptom observed in various diseases, such as tuberculosis and rheumatic fever, but it may exist apart from such conditions, and either be general, affecting the whole body, or confined to a part, such as the axillae, head, hands, feet, or, as in some rare instances, the one half of the body. Excessive perspiration may often be prevented by the cold bath, and by tonics, such as iron, quinine, strychnia, &c. Locally, the use of astringent lotions of vinegar or a weak solution of lead will also be of service. Foetid sweating most frequently affects the feet, specially in those who have much fatigue, and is apparently due to rapid decomposition in the perspiration which has saturated the stockings; these should be frequently changed and the feet washed several times a day, dried carefully, and dusted with some antiseptic powder.

PERTAB (or **PARTAB**) **SINGH**, SIR, maharaja of Idar (1844-), native Indian soldier and statesman, belonging to the Rahtor Rajputs of the Jodha class, was born in 1844, being the son of Maharaja Takht Singh, ruler of Marwar (or Jodhpur). In 1878 and again in 1879 he was chief minister of Jodhpur. In the following year he accompanied the British mission to Afghanistan, and on his return he carried out many judicious reforms and administered Jodhpur with remarkable success. He visited England to take part in the celebration of the 1887 Jubilee of Queen Victoria's reign. He served on the staffs of Sir William Lockhart and General Elles in the Tirah and Momand expeditions in 1897-98, was slightly wounded, was mentioned in despatches, and promoted to the rank of full colonel. He won the reputation of being one of the keenest sportsmen and the best riders that even Rajputana has produced. When it was decided to send a force from India to China in 1900 to relieve the foreign embassies besieged in Peking, Sir Pertab Singh at once offered the services of the Jodhpur Lancers, and himself accompanied them. His father rendered good services to the British government in the Mutiny, and Pertab Singh always cherished the memory of the protection given to Jodhpur by the East India Company in 1818. His services to the empire in India were universally recognized. From Queen Victoria he received the honour of knighthood and the Bath and the Star of India; from King Edward VII. the distinction of "aide-de-camp"; and the university of Cambridge gave him the degree of LL.D. From his own state of Jodhpur he obtained the title of Maharaja-Dhiraj. In 1901 he succeeded to the rulership of the state of Idar.

PERTH, EARLS AND DUKES OF. The Scottish title of earl of Perth was bestowed upon James, 4th Lord Drummond (d. 1611) in 1605. His ancestor Sir John Drummond (d. 1510) had been created Lord Drummond in 1488. The 1st earl's great-nephew, James, 4th earl and 1st duke of Perth (1648-1716),

was a son of James, the 3rd earl (c. 1615-1675). When John Maitland, duke of Lauderdale, was virtually the dictator of Scotland, Perth was among his opponents, and after Lauderdale's retirement in 1680 he was one of the committee of seven which managed Scottish affairs. He was made justice-general and extraordinary lord of session in 1682, and was lord chancellor of Scotland from 1684 to 1688. As a convert to Roman Catholicism after the death of Charles II., he stood high in the favour of James II. Perth, who is credited with the introduction of the thumbscrew, was very unpopular with the Scottish people, and during the Revolution of 1688 he was imprisoned at Stirling. Released from captivity in 1693 he joined James II. at St Germain, and was made duke of Perth, a titular dignity only after the exiled king's death in 1701. His son James (c. 1675-1720) was with James II. in Ireland, and led the cavalry at the battle of Sheriffmuir. He was attainted in 1715, but claimed the dukedom of Perth after his father's death. His son James (1713-1746), regarded by friends and dependants as the 3rd duke of Perth, fought for the Young Pretender at Prestonpans and Culloden. His brother and heir, John, the 4th duke (c. 1716-1747), also joined Charles Edward, and fought at Falkirk and Culloden. The titular dukedom became extinct when the sixth holder, Edward, another son of the 1st duke, died in 1760.

The earldom was then claimed by Edward's cousin, James Lundin (1707-1781), a grandson of the 1st titular duke of Melfort, who was a brother of the 1st duke of Perth and took the name of Drummond. His son James (1744-1800) secured the Drummond estates in 1783, and was created a British peer as Lord Perth and Baron Drummond in 1797. On his death without sons in July 1800 his barony became extinct, but the claim to the earldom of Perth was inherited by his kinsman, the 4th titular duke of Melfort, and his descendants (see below). The Drummond estates, however, passed to the baron's daughter Clementina (d. 1865), afterwards the wife of Peter Robert, 20th Lord Willoughby de Eresby, and thence to her descendant the earl of Ancaster.

The 1st duke's brother, John (c. 1650-1715), earl of Melfort, rose to favour under Charles II. about the same time as his brother; like him, too, he became a Roman Catholic in 1686. In 1684 he was made secretary of state for Scotland; in 1686 he was created earl of Melfort by James II., and during his reign he took a leading part in Scottish affairs. After the Revolution of 1688 his great influence with James II. and with Mary of Modena drew upon him the hatred both of the French and of the Irish. He was with James II. at St Germain, but lost his former ascendancy, and died in Paris on the 25th of January 1715. In 1694 he was made duke of Melfort, and all his titles were held under the singular condition that they should descend to the children of his second wife, Euphemia (d. 1743), daughter of Sir Thomas Wallace, in preference to his children by his first wife, Sophia Lundin, who were Protestants. In 1701 Melfort was recognized as a French peer, the duc de Melfort, by Louis XIV. In 1695 he had been attainted, but his titles were claimed by John (1682-1754), his eldest son by his second wife, who shared in the rising of 1715. In 1800 John's grandson, James Louis, 4th titular duke of Melfort, claimed the earldom of Perth: This claim was unsuccessful, but in 1853 George (1807-1902), nominally 6th duke of Melfort, obtained a reversal of the various attainders, and his own recognition as earl of Perth and Melfort. The succeeding earl was his kinsman, William Huntly Drummond, Viscount Strathallan (1871-).

See Sir R. Douglas, *The Peerage of Scotland*; and *Histories of Noble British Families*, vol. ii., edited by H. Drummond (1846).

PERTH, the capital of Western Australia, situated on the Swan River, 12 m. by rail from the sea at Fremantle, and about 1700 m. W.N.W. of Melbourne. It is the seat of both Anglican and Roman Catholic bishops, and has two cathedrals. The fashionable street is St George's Terrace; in it are situated the public library, the government boys' school, the stock exchange, the town-hall, the government offices and the parliament buildings. Between it and the broad reach of the river known as Perth Water lie the governor's residence and domain. The

town-hall, built entirely by convict labour, stands on an eminence in the very heart of the city; opposite to it are the government offices, housed in a four-storeyed structure in the style of the French Renaissance. The mint, opened in 1809, is a massive freestone building. There are a public library, built as a memorial of Queen Victoria's Jubilee in 1887, a Scots college, two good theatres, a mechanics' institute, a museum, and a fine Wesleyan church-house, known as Queen's Hall. The Perth Park, containing about 1200 acres, is connected by tram with the city, and in it is a well-equipped observatory. There are several smaller parks and squares in the city, while the esplanade gardens are a feature of the place, being thrown out like a pier into Perth Water. There is a good cricket ground, and three race-courses are in easy reach. South Perth, on the other side of the river, is connected by bridges and steam ferry; and adjoining the city on the north-west are the suburban municipalities of Leederville and Subiaco. Outlying suburbs are Belmont, Victoria Park, Burswood, Claremont, Cottesloe, Peppermint Grove and Bayswater. The city is lighted by electricity, and has a good service of electric trams. Perth has an agreeable climate, the mean temperature is 64.0° F., and the average rainfall 33 in. Perth was founded in 1829, received its municipal charter in 1856, and was created a city in 1880. Between 1801 and 1901 the growth of the city was remarkably rapid; in 1801 the population was only 8447, but in 1901 it had grown to 27,471 in the city proper, and to 36,199 including the suburbs.

PERTH, a city, and royal, municipal and police burgh, and county town of Perthshire, Scotland, 32 m. N. by W. of Edinburgh direct, and 47½ m. by the North British railway, via the Forth Bridge and Kinross Junction. Pop. (1901), 33,566. It is situated on the right bank of the Tay, between the meadows of the North Inch (98 acres) and those of the South Inch (72 acres), both laid out as public parks. The river is crossed by St John's Bridge of nine arches, completed in 1772 from the designs of John Smeaton and widened a century later; by Victoria Bridge, a modern structure connecting South Street with Dundee Road; and farther south (at the end of Tay Street) by a footway alongside of the viaduct belonging to the Caledonian railway. Of earlier bridges one, which crossed at High Street, was swept away by the flood of 1621, and another, constructed by General Wade in 1723-1733, was apparently the predecessor of Smeaton's bridge. On the left bank of the river lie the suburb of Bridgend and Kinnoull Hill (729 ft.). To the south are the wood-clad heights of Moncrieffe Hill (725 ft.), Magdalenes Hill (596 ft.), Kirkton Hill (540 ft.) and Craigie Wood (407 ft.). In the river are Friarton or Moncrieffe Island and the Stanners.

Notwithstanding the importance of Perth in former times, almost the sole relic of the past is the church of St John the Baptist, a large Decorated cruciform building surmounted by a massive square central tower 155 ft. high. The original edifice is believed to have been erected in the time of Columba, but the transept and nave of the existing structure date from the early part of the 13th century, the choir from the 15th. The church was restored in 1891, and is now divided into the East, Middle and West churches. The silver-gilt communion cup used in the Middle Church is said to have been presented by Queen Mary. In May 1550 John Knox preached in St John's his famous sermon in denunciation of idolatry. The Dominican or Blackfriars' monastery, founded by Alexander II. in 1231, occupied a site near the west end of St John's Bridge; in what is now King Street stood the Carthusian monastery, founded by James I. in 1425; the Franciscan or Greyfriars' monastery, founded in 1460 by Laurance, first Lord Oliphant, stood on the present Greyfriars' cemetery; the Carmelite or Whitefriars' monastery, founded in 1260, stood west of the town. The tombstone of James I. and his queen, who were buried in the Charterhouse, was afterwards removed to St John's East Church. During the period between the beginning of the 12th century and the assassination of James I. in 1437, many of the Scottish parliaments were held in Perth. The building in which they met stood off High Street and was only cleared away in 1818, its

site being occupied by the Freemasons' Hall. The earl of Gowrie's palace, built in 1520, stood in spacious grounds near the river and was removed in 1805 to provide room for the county buildings. The castle of Perth stood on the north of High Street, not far from St John's. It was probably built about 860 and demolished about 1400. The Spey or Spy tower, the most important fortress on the city wall, guarded the south gate close to the river, but it was taken down early in the 19th century. The market cross, erected in High Street in 1669 to replace the older cross which Cromwell destroyed, was removed in 1765 as an obstruction. The huge fortress, 466 ft. square, which Cromwell erected in 1651 on the South Inch, close to the river and the Greyfriars' burying-ground, was demolished in 1663. The house of Catherine Glover, the "Fair Maid of Perth," still stands in Curfew Row. James VI.'s Hospital, founded in 1566, occupies the site of the Carthusian monastery, the original structure having been pulled down by Cromwell's orders. The pensioners now live out and the hospital has been converted into artisans' dwellings. Among modern public buildings the principal are St Ninian's Episcopal Cathedral, in the Early Middle Pointed style, an important example (completed 1890) of the work of William Butterfield (1814-1900); the municipal buildings (1881); the city-hall; the Marshall Memorial Hall (1823), housing the public library and the museum of the Perth Literary and Antiquarian Society; the Perthshire natural history museum; the Sandeman public library (1898), founded by a bequest of Professor Sandeman of Owens College, Manchester. The general prison for Scotland, south of the South Inch, was originally erected in 1812 as a dépôt for French prisoners, but was remodelled as a convict prison in 1840 and afterwards enlarged. North-west of the city are the military barracks built in 1793-1794. Besides the regular elementary schools there are the Perth Academy (1807) with which was subsequently amalgamated the Burgh Grammar School, an institution supposed to date from the 12th century; Sharp's institute (1860); the Stewart's free school, an industrial school for girls, and the Fehncy industrial school. The charitable institutions comprise the royal infirmary, in the Italian style, considerably enlarged since its foundation in 1836; the Murray royal lunatic asylum in Bridgend; the Hillside House in Kinnoull and the small-pox hospital.

From the south the city is entered by the North British railway and the Caledonian railway (which also runs west to St Fillans, east to Dundee and north-west to Aberdeen); and from the north by the Highland railway, the three systems utilizing a general station in the south-west of the town. During the season there is communication with Dundee and other river ports by steamer. The navigation of the stream is considerably obstructed by sandbanks, but vessels of 200 tons can unload at the quays, which, with the town and Friarton harbours, lie below the South Inch. The greatest tidal rise is 13 ft. The chief imports are Baltic timber, coal, salt and manure; and the exports, manufactured goods, grain, potatoes and slates. Perth has long been famous for its dyeing and bleaching, the bleach-fields being mostly situated outside of the city, in convenient proximity to the Tay and Almond. The other leading industries include manufactures of gauge-glasses, ink, muslins, India shawls, jute goods, woollens and winceys, floorcloth, and boots and shoes. There are iron foundries, breweries, distilleries, rope and sail works, coach-building yards, steam joinery works, and brick and tile works. The salmon fisheries of the Tay yield a substantial revenue. Perth is under the jurisdiction of a town council, with a lord provost and bailies, and returns one member to parliament.

History.—During the time that it was occupied by the Romans, a period estimated at 320 years, the city was called Victoria; but shortly after their withdrawal it seems to have borne the Celtic appellation of Aber-itha ("at the mouth of the Tay"). The transition to the latinized form Bertha and later to Perth (the Gaelic name being *Pearl*) appears obvious. On the conversion of the original Pictish inhabitants and the dedication of the first church to St John the Baptist, the town

was designated St Johnston, and it continued to be known indifferently by this name and that of Perth down to the 17th century. Roman remains have often been found in excavations carried out within the existing boundaries, which suggests that the Roman settlement was at least twenty feet below the present surface. The obscurity of the early annals of the town is explained by the circumstance that Edward I. caused the records to be removed. Perth is stated to have been a burgh in 1106 and was made a royal burgh by William the Lion in 1270. During the Scottish wars of the Independence its fortifications were strengthened by Edward I. (1298). Robert Bruce several times ineffectually attempted to seize it, but in 1311 he succeeded in scaling the walls during a night attack. This was the fourth and most brilliant of the seven sieges which the city has sustained. Taken by Edward III. in 1335, it was recaptured in 1339. In 1396 the combat between the Clan Chattan and the Clan Quhele, described in Scott's *Fair Maid of Perth*, took place on the North Inch in presence of Robert III. and his queen, Annabella Drummond. The Blackfriars' monastery was the scene of the murder of James I. by Walter, earl of Atholl, in 1437. In consequence Perth lost its status as capital, in which it had succeeded to Scone, and the Parliament Courts were transferred to Edinburgh in 1482. Gowrie Palace was the scene of the mysterious "Gowrie" conspiracy against James VI. in 1600. The town was taken by Montrose in 1644, by Cromwell in 1651, and was occupied by Viscount Dundee in 1689. In 1715 the Old Pretender was proclaimed king at the Mercat Cross (Sept. 16), and the chevalier himself appeared in the city in the following January, only to leave it precipitately on the approach of the earl of Argyll. Prince Charles Edward spent a few days in Perth from the 3rd of September 1745. In both rebellions the magistrates took the side of the Crown and were supported by the townsfolk generally, the Jacobites drawing their strength mainly from the county noblemen and gentry with their retainers. Since then the city has devoted itself to the pursuits of trade and commerce. Perth was visited by plague in 1512, 1585-1587, 1608 and 1645; by cholera in 1832; and the floods of 1210, 1621, 1740, 1773 and 1814 were exceptionally severe.

AUTHORITIES.—Maidment, *The Chronicle of Perth from 1210 to 1668* (1831); Penney, *Traditions of Perth* (1836); Lawson, *The Book of Perth* (1847); Peacock, *Perth, its Annals and Archives* (1849); Samuel Cowen, *The Ancient Capital of Scotland* (1904).

PERTH AMBOY, a city and port of entry of Middlesex county, New Jersey, U.S.A., at the mouth of the Raritan river, on Raritan Bay and Staten Island Sound, about 15 m. S. by W. of Newark. Pop. (1910 census) 32,121. It is served by the Pennsylvania, Lehigh Valley, Central of New Jersey and Staten Island Rapid Transit railways, and by boats to New York City. It is connected by a railway bridge (C.R.R. of N.J.) and by a foot and wagon bridge with South Amboy, on the south shore of the Raritan. Perth Amboy has a good harbour, shipyards and dry-docks. In the city still stands Franklin Palace (erected in 1764-1774), the home of William Franklin (1729-1813), a natural son of Benjamin Franklin and the last royal governor of New Jersey. In the vicinity is the Bartow House, in which William Dunlap (1766-1839), the art historian, made his first drawings. Other buildings of historic interest are the Parker Castle (c. 1729), a centre of Loyalist influence at the time of the War of Independence, and the Kearny Cottage, the home of "Madam Scribblerus," a half-sister of Captain James Lawrence. The city has various manufactures, the factory product in 1905 being valued at \$34,800,402. Clay is obtained in the vicinity, and large shipments of coal are made. Perth Amboy was founded in 1683. It was at first called Amboy after the original Indian name; in 1684 the proprietors named it Perth in honour of James, earl of Perth (1648-1716), one of their number, and a few years later the two names were combined. From 1686 until the end of the proprietary government in 1702 Perth Amboy was the capital of the province of East Jersey, and during the period of royal

government the general assembly and supreme court of New Jersey met alternately here and at Burlington. Perth Amboy was incorporated as a city in 1718, and received a new charter in 1784, and another in 1844, the last being revised in 1870. The township of Perth Amboy was incorporated in 1693 and in 1844 was included in the city.

PERTHES, FRIEDRICH CHRISTOPH (1772-1843), German publisher, nephew of Johan Georg Perthes (q.v.), was born at Rudolstadt on the 21st of April 1772. At the age of fifteen he became an apprentice in the service of Adam Friedrich Böhme, a bookseller in Leipzig, with whom he remained for about six years. In Hamburg, where he settled in 1793 as an assistant to the bookseller B. G. Hoffmann, he started in 1796 a bookselling business of his own, and in 1798 he entered into partnership with his brother-in-law, Johann Heinrich Besser (1775-1826). By his marriage in 1797 with a daughter of the poet, Matthias Claudius, he was brought into intimate relation with a group of Protestant writers, who exercised a powerful influence on the growth of his religious opinions. This, however, did not prevent him from being on friendly terms with a number of eminent Roman Catholic authors. Perthes was an ardent patriot; and during the period of Napoleon's supremacy he distinguished himself by his steady resistance to French pretensions. His zeal for the national cause led him, in 1810-1811, to issue *Das deutsche Museum*, to which many of the foremost publicists in Germany contributed. For some time the French made it impossible for him to live in Hamburg; and when, in 1814, he returned to that city he found that his business had greatly diminished. In 1821, his wife having died, he left Hamburg, transferring his business there to his partner, and went to Gotha, where he established what ultimately became one of the first publishing houses in Germany. It was owing to his initiation that the *Börsenverein der deutschen Buchhändler* (Union of German Booksellers) in Leipzig was founded in 1825. When the foundation-stone of the fine building of the Union was laid in 1834, Perthes was made an honorary freeman of the city of Leipzig, and in 1840 the university of Kiel conferred upon him the degree of doctor of philosophy. Perthes died at Gotha on the 18th of May 1843. His *Life* was written by his son, Klemens Theodor Perthes (1809-1867), professor of law in the university of Bonn, and author of *Das deutsche Staatsleben vor der Revolution* (Hamburg and Gotha, 1845), and *Das Herbergswesen der Handwerkszweige* (Gotha, 1856, and again 1883), whose son Hermann Friedrich Perthes (1840-1883) was the founder of the Fridericianum at Davos Platz. The publishing business at Gotha was carried on by Perthes's younger son, Andreas, (1813-1890) and his grandson, Emil (1841-), until 1889, when it was handed over to a company.

See also O. Adler, *Friedrich and Karoline Perthes* (Leipzig, 1900).

PERTHES, JOHAN GEORG JUSTUS (1749-1816), German publisher, was born at Rudolstadt on the 11th of September 1749. In 1785 he founded at Gotha the business which bears his name (Justus Perthes). In this he was joined in 1814 by his son Wilhelm (1793-1853), who had been in the establishment of Justus' nephew, Friedrich Christoph Perthes, at Hamburg. On the death of Justus at Gotha on the 2nd of May 1816, Wilhelm took entire control of the firm. He laid the foundation of the geographical branch of the business, for which it is chiefly famous, by publishing the *Hand-atlas* (1817-1823) of Adolf Stieler (1775-1836). Wilhelm Perthes engaged the collaboration of the most eminent German geographers of the time, including Heinrich Berghaus, Christian Gottlieb Reichard (1758-1837), who was associated with Stieler in the compilation of the atlas, Karl Spruner (1803-1892) and Emil von Sydow (1812-1873). The business passed to his son Bernard Wilhelm Perthes (1821-1857), who was associated with August Petermann (under whose direction the well-known periodical *Petermanns Mitteilungen* was founded) and Bruno Hassenstein (1839-1902); and subsequently to his son Bernard (1857-). In 1863 the firm first issued the *Almanach de Gotha*, a statistical, historical and genealogical annual (in French) of the various countries of the

world; and in 1866 the elaborate *Geographisches Jahrbuch* was produced under the editorship of Ernst Behm (1830-1884), on whose death it was continued under that of Professor Hermann Wagner.

PERTHSHIRE, an inland county of Scotland, bounded N. by the shires of Inverness and Aberdeen; E. by Forfarshire; S.E. by the Firth of Tay and the counties of Fife and Kinross; S. by the shires of Clackmannan and Stirling; S.W. by the counties of Stirling and Dumbarton; W. by Argyllshire and N.W. by Inverness-shire. It is the fourth largest county in Scotland, having an area of 1,595,774 acres, or 2493.4 sq. m., including the island of Mu Drum in the Firth of Tay. By far the greater part of the county is mountainous. Including the hills on the confines of Inverness-shire and Argyllshire, there are at least fifty mountains exceeding 3000 ft. in height. Of these the most familiar are Ben Lawers (3984 ft.) near Loch Tay, Ben More (3843) east of Crianlarich, Ben Lui (3708) on the Argyllshire border, Schiehallion (3547) south of Loch Rannoch, Ben Vannoch (3125) west of Loch Lyon, and Ben Chonzie (3048) near the head of Glen Almond. Of the immense number of hills of lesser altitude there may be mentioned four that have been popularized by the *Lady of the Lake*—Ben Ledi (2875) and Uam Var (2179) near Callander, and Ben Venue (2393) and Ben A'an (1750), guardians of the Trossachs. The Ochils divide Perthshire from the shires of Clackmannan, Kinross and Fife. The chief stream is the Tay, which rises on the Argyllshire frontier and discharges into the North Sea off Buddon Ness, after a course of 117 m., being thus the longest river in Scotland. Its head-waters are the Fillan and Dochart, and among its affluents are, on the right, the Bran, Almond and Earn and, on the left, the Lyon, Tummel, rising in Argyllshire and receiving the Garry on its left, and Isla. The Earn flows out of Loch Earn and enters the Firth of Tay 6½ m. below Perth. The Forth, the principal natural boundary of the shire on the south, properly belongs to Stirlingshire, in which it rises, but its leading left-hand affluents are Perthshire rivers, namely, the Teith, the Goodie, issuing from the lake of Menteith, and the Allan, rising in the Ochils near Sheriffmuir. All the lakes are narrow, scarcely one exceeding a mile in width. Loch Erich, belonging partly to Inverness-shire, is 14½ m. long. Loch Tay (14½ m. long), situated about the centre, is the largest lake in the county. In the south are the series of lakes which the *Lady of the Lake* has rendered famous—Loch Venachar (4½ m. long), Loch Achray (1½ m. long), Loch Katrine (about 8 m. long); to the west of Aberfoyle is Loch Ard (3 m. long) and to the east Lake Menteith (1½ m. long). Nearly all the glens possess striking natural features, among them, from south to north, being Glens Artney, Almond, Dochart, Ogle, Lochay, Lyon, Garry, Shee, Bruar and Tilt; while the Trossachs, Killiecrankie, Birnam and Leny are the loveliest passes in the Highlands. The low-lying country is represented mainly by Strathmore, Strath Gartney, Strathallan, noted for its annual "gathering" or games, Strathearn, Strath Bran, Strath Tay and Strath Fillan, but more particularly by the fertile alluvial belts of the Carse of Gowrie, on the northern shore of the Firth of Tay, and the Carse of Stirling. The Moor of Rannoch on the borders of Argyllshire is a sterile boulder-strewn waste, and Flanders Moss, to the south-east of Lake Menteith, is a vast boggy tract, which is, however, being gradually reclaimed and brought under cultivation.

Geology.—The Highland portion of this county is built up of a great series of schists and metamorphosed rocks grouped as "Dalradian" or Eastern schists. The general direction of the strike of these rocks is W.S.W.—E.N.E. They are cut off from the Old Red Sandstone, which occupies most of the remainder of the county, by the great fault which traverses the county somewhat to the north of Aberfoyle and Crieff. But for some distance north and east of Crieff the boundary between these two formations is an unconformable one. In the neighbourhood of the fault line the Highland schists are less metamorphosed than they are farther north; about Comrie and Callander they consist of shales, greywackes and igneous rocks with radiolarian cherts and black shales that are suggestive of the rocks of Arenig age in south Scotland. At Aberfoyle, Comrie and Dunkeld roofing slates are worked and massive limestones occur in Glen Tilt, Pitlochry, Callander, Blair Atholl, Loch Rannoch and other places. A gritty series comes on above the

slates and is well seen capping the summit of Ben Vorlich. A great variety of schists form the bulk of the series; but granite masses appear in their midst as at Loch Rannoch, Loch Erich and Glen Tilt, and there are numerous acid and intermediate dikes which are themselves traversed by later basaltic dikes. The Old Red Sandstone consists in the lower portion mainly of coarse volcanic agglomerates and lava flows followed by conglomerates, sandstones and marls. The lowest beds are exposed along the crest of the Ochil Hills which like the Sidlaw Hills are anticlinal in structure, while between the Ochils and the Highland fault the rocks are folded into syncline; near the fault they become very steeply inclined and even inverted, and it is interesting also to note that the sediments become coarser as the fault is approached. The Upper Old Red Sandstone is well exposed near the Bridge of Earn and it extends beneath the marine platform of the Carse of Gowrie. The rocks are mainly red sandstones and marls, let down between two parallel east and west faults but between the Bridge of Earn and Forgandenny, west of the tract, they are seen to rest unconformably upon the lower division. Small outliers of Carboniferous rocks (lower) occur on the north of the Ochils. The marks of ice action left by the Glacial epoch are abundant and striking in Perthshire; moraines are common in the Highland glens, as those at the head of the Glangarry on borders of Loch Katrine; ice-scratched surfaces are found on the Sidlaw Hills, the Ochils, Kinmoull Hill and elsewhere; and erratic blocks of stone, such as "Samson's Putting Stone," a mass of Highland schist resting on a hill of Old Red Sandstone near Coikantogle, are widely distributed. Old high level marine beaches form terraces far up several of the larger streams, and the Carse of Gowrie, as already indicated, is formed by the beach at the 50-ft. level. The gravel cones poured out at the mouths of many of the glens which open on the south of the Ochils on to the 100-ft. or 50-ft. beaches are often the site of villages.

Climate and Agriculture.—The mountainous territory is extremely wet, the rainfall for the year varying from 93 in. in Glengyle at the head of the Loch Katrine to 37 in. at Pitlochry and 23 in. at Perth. Winter and autumn are the rainiest seasons. The temperature is remarkably constant everywhere, averaging 47° F. for the year. January being the coldest month (36.5° F.) and July the hottest (59° F.). Only a little more than one-fifth of the total area is under cultivation, and of this nearly one-third is in permanent pasture, while in addition there are about 930,000 acres of hill pasturage. The arable land is chiefly in the drier regions of the east and south-east, the soil for the most part being fertile. Light soils prevail in the lower undulating districts; clay and alluvial land occur in the Carse of Gowrie, the Carse of Stirling and the lower reach of Strathearn below and above Bridge of Earn. The best heavy carse land is very rich and productive, but requires to be thoroughly worked, limed and manured, being well adapted for wheat. A considerable area is occupied by orchards, the light quick soil of Tayside and the upper districts of Menteith being admirably fitted for apples. The number of holdings is slightly in excess of 5000 and of these the majority are under 50 acres each, chiefly in the Highland valleys and near the villages and small towns. Of grain, oats is the predominating crop, but barley and wheat are also grown. Two-thirds of the area devoted to green crops is occupied by turnips; the rest by potatoes. Most of the horses raised, chiefly Clydesdales, are used solely for agricultural purposes. Although dairy-farming is not an important industry, a large number of cows, principally Ayrshires, are kept on the lowland farms, the herds of the straths and mountain pastures being most usually West Highlands or Kyles. Perthshire, next to Argyllshire, still carries the heaviest flocks in Scotland. Black-faced is the principal breed in the Grampians, but there is also a large number of Cheviots and South Downs, and Leicesters are common on the lower runs. Only one-seventeenth of the surface is under wood. This is well up to the proportion of the other Scottish counties, but compares unfavourably with the conditions existing in 1872, when 203,880 acres were under wood, of which 61,164 were planted and 142,716 natural. In Breadalbane and Menteith there are remains of the ancient Caledonian forest. Perthshire affords exceptional facilities for sport with rod and gun. The lochs and rivers abound with salmon and trout, while hardly any of the streams have suffered pollution from industries or manufactures. The deer forests, exceeding 100,000 acres in area, are frequented by red deer and roe deer, and on the extensive moors and in the woods are found grouse, pheasants, partridge, capercaillie, woodcock, ptarmigan and hare.

Industries.—The shire is famous for its dyeing and bleaching works, which are situated in Perth and its vicinity; but, apart from these, there are flax and jute mills at Rattray and cotton mills at Stanley, Deanston and Crieff; woollens, linen, jute and tartans are woven at Dunblane, Alyth, Blairgowrie, Coupar-Angus, Auchterarder and Crieff; tanning is carried on at Blackford, Coupar-Angus and Crieff; there are breweries and distilleries at various places, as at Auchterarder and Logierait; granite, freestone, limestone and slate are quarried at different centres; and there are sawmills and flour-mills.

Communications.—The Caledonian railway main line to Aberdeen enters the county near Dunblane and runs in a north-easterly

direction via Perth. At Crieff junction it sends off a branch to Crieff and at Perth branches to Dundee and Lochearnhead. The Stirling to Oban line of the same company crosses the shire from Dunblane to Tyndrum. The Highland railway runs northwards from Perth, and has a branch at Ballinluig to Aberfeldy. Branches of the North British railway reach Perth from Mawcarse in Kinross-shire and Ladybank in Fifeshire; part of the branch from Buchlyvie on the Forth and Clyde line runs to Aberfoyle, and the West Highland railway skirts the extreme west of the shire. At several points coaches supplement the rail. In the tourist season steamers ply on Loch Tay and Loch Katrine, and there is a service on the Tay between Perth and Dundee.

Population and Administration.—In 1891 the population amounted to 122,185 and in 1901 to 123,283, or 49 persons to the sq. m. The rate of increase was the smallest of any Scottish county for the decade. In 1901 there were 78 persons speaking Gaelic only and 11,446 Gaelic and English. The chief towns are Perth (pop. 32,873), Crieff (5208), Blairgowrie (3378), Dunblane (2516), Auchterarder (2276), Coupar-Angus (2064), Rattray (2019). Among lesser centres may be mentioned Aberfeldy (1508), a favourite resort on the Tay, well known for the falls of Moness, mentioned in Robert Burns's song "The Birks of Aberfeldy"; Abernethy (623), the seat of an early bishopric, retaining one of the three ancient round towers in Scotland; Alyth (1965); Callander (1458); Comrie (1118), a holiday resort on the Earn; Pitlochry (1541); and Stanley (1035), on the Tay. Of old the county was divided into hereditary jurisdictions, which were abolished in 1748, and in 1795 the county was divided into districts for administrative purposes, a system which obtained until 1889, when county and district councils were established. The sheriffdom is divided into an eastern and western district, the seat of the one being Perth and the other Dunblane. For parliamentary purposes the county is also divided into an eastern and a western division, and the city of Perth returns a member. The shire is under school-board jurisdiction, and there are secondary schools at Perth and Crieff, and Trinity College in Glen Almond is a well-known public school on the English model.

History.—In 83 Agricola explored the lands beyond the Forth and in the following year penetrated to the Grampians, defeating the Caledonians under Galgacus with great slaughter. The site of this battle is conjectured by William Forbes Skene to have been near Meikleour, south of Blairgowrie, but other writers have referred it to Dalginross, near Comrie; to Ardoch (where there are the most perfect remains of a Roman encampment in the British Isles); and even as far north as Raedykes, near Stonehaven in Kincardineshire. The Romans did not pursue their victory, and the Picts were left undisturbed for a considerable period. At this time, according to Ptolemy, the territory now known as Perthshire was occupied by three tribes—the Damnonii, the Venicones and the Vacomagi. The Damnonii held Menteith, Strathearn and Fothrif (the western part of modern Fife and Kinross), with Alauna (Allan), just above Stirling, Lindum (Ardoch) and Victoria (believed by some authorities to be Lochore in Fifeshire, and by others to be Perth city), as their chief towns. The Venicones inhabited north-western Fife and the adjoining tract of Perthshire, with Orca (probably Abernethy) as their chief town and a station at Ardargie. The Vacomagi dwelt in the Highland region, with stations at Inchtuthil (a peninsula in the Tay above Kinclaven) and Banatia (Buchanty on the Almond). The growing lawlessness of the southern Picts and their frequent raids in the more settled country in the south at last compelled the attention of the emperor Severus. He arrived in Britain in 208, but though he led a strong army to the shores of the Moray Firth, he was unable effectually to subdue the tribesmen. The road he constructed ran from Stirling to Ardoch (where there are notable remains) and thence by Strageath, near Muthill, where it branched north-westwards to Dalginross and Buchanty, and north-eastwards to Perth and so to the Grampians. When the Romans finally withdrew from Britain, the Picts established their capital first at Abernethy and then at Forteviot. Abernethy was the centre of the Celtic church after the conversion of the natives by Ninian, Palladius and other missionaries in the

5th and 6th centuries. On the burning of Forteviot by the Norsemen in the 8th century, the seat of Pictish government was removed to Scone. In the latter half of the 9th century Dunkeld—to which Kenneth Macalpine had brought some of the relics of Columba from Iona—became the scene of monastic activity, the abbot succeeding to the position of the abbot of Iona, and exercising great influence for nearly a hundred years. The Danes periodically harried the land, but a crushing defeat at Lumarcy in 961 put an end to their inroads in this quarter. In 1054 Macbeth was defeated at Dunsinane by Siward, earl of Northumberland, who had invaded Scotland in the interest of his kinsman, Duncan's son, who, on the death of the usurper three years later, ascended the throne as Malcolm III., called Canmore. With Malcolm's accession the Celtic rule of the monarchy of Scone came to an end. Nevertheless, the Scottish sovereigns (excepting James II., James III. and Mary) continued to be crowned at Scone, which also retained the position of capital until the beginning of the 12th century, when it was displaced by Perth. From the time of Alexander I. (d. 1124), therefore, the history of the shire is merged in that of the county town, with the exception of such isolated incidents as the removal of the Coronation Stone from Scone to Westminster in 1296, the defeat of Robert Bruce at Methven in 1306, the battle of Dupplin in 1332, the victory of Dundee at Killecrankie in 1689 and the indecisive contest at Sheriffmuir in 1745. Among archaeological remains may be mentioned the hill-fort on Dunsinane; the ship-barrow of the vikings at Rattray, weems (or earth-houses) in the parishes of Monzie, Alyth and Bendochy; the witch-stone near Cairnbeddie, one of the numerous spots where Macbeth is alleged to have met the witches, but probably a sepulchral memorial of some forgotten battle; standing stones near Pitlochry, and an extraordinary assemblage of sculptured stones at Meikle.

BIBLIOGRAPHY.—Robertson, *Comitiatus de Athollis* (Edinburgh, 1860); P. R. Drummond, *Perthshire in Bygone Days* (London, 1879); Marshall, *Historic Scenes of Perthshire* (Perth, 1880); Beveridge, *Perthshire-on-Forth* (2 vols., London, 1885); R. B. Cunningham-Graham, *Notes on the District of Menteith* (London, 1895); Hutchison, *The Lake of Menteith* (Stirling, 1899).

PERTINAX, PUBLIUS HELVIUS (A.D. 126–193), Roman emperor, the son of a charcoal-burner, was born at Alba Pompeia in Liguria. From being a teacher of grammar he rose through many important offices, both civil and military, to the consulate, which he held twice. Chosen, at an advanced age and against his will, on the 1st of January 193, to succeed Commodus, he was himself assassinated in a mutiny of the soldiers, on the 28th of March 193.

PERTZ, GEORG HEINRICH (1795–1876), German historian, was born at Hanover on the 28th of March 1795. From 1813 to 1818 he studied at Göttingen, chiefly under A. H. L. Heeren. His graduation thesis, published in 1819, on the history of the Merovingian mayors of the palace, attracted the attention of Baron Stein, by whom he was engaged in 1820 to edit the Carolingian chronicles for the newly-founded Historical Society of Germany. In search of materials for this purpose, Pertz made a prolonged tour through Germany and Italy, and on his return in 1823 he received at the instance of Stein the principal charge of the publication of *Monumenta germaniae historica*, texts of all the more important historical writers on German affairs down to the year 1500, as well as of laws, imperial and regal archives, and other valuable documents, such as letters, falling within this period. Pertz made frequent journeys of exploration to the leading libraries and public record offices of Europe, publishing notes on the results of his explorations in the *Archiv. der Gesellsch. f. deutsche Geschichtskunde* (1824–1872). In 1823 he had been made secretary of the archives, and in 1827 principal keeper of the royal library at Hanover; from 1832 to 1837 he edited the *Hannoversche Zeitung*, and more than once sat as a representative in the Hanoverian second chamber. In 1842 he was called as chief librarian to Berlin, where he shortly afterwards was made a privy councillor and a member of the Academy of Sciences. He resigned all his appointments in

1874, and on the 7th of October 1876 died at Munich while attending the sittings of the historical commission.

The *Monumenta* began to appear in 1826, and at the date of his resignation 24 volumes folio (*Scriptores, Leges, Diplomata*) had appeared. This work for the first time made possible the existence of the modern school of scientific historians of medieval Germany. In connexion with the *Monumenta* Pertz also began the publication of a selection of sources in octavo form, the *Scriptores rerum germanicarum in usum scholarum*; among his other literary labours may be mentioned an edition of the *Gesammelte Werke* of Leibnitz, and a life of Stein (*Leben des Ministers Freiherrn vom Stein* (6 vols., 1849-1855); also, in an abridged form, *Aus Steins Leben* (2 vols., 1856).

estimated at 439,000 to 480,000 sq. m., the Gotha measurements being 1,137,000 sq. kilometers, or 439,014 sq. m.

With the exception of parts of the Ecuador, Brazil and Bolivia frontiers, all the boundary lines have been disputed and referred to arbitration—those with Colombia and Ecuador to the king of Spain, and that with Bolivia to the president of Argentina, on which a decision was rendered on the 6th of July 1909. There have been misunderstandings with Ecuador in regard to some small areas in the Chira valley, but it may be assumed that the line is fixed between Santa Rosa (3° 21' S.) on the Gulf of Guayaquil, and the Chinchipe river, a tributary of the

Marañon. At the junction of the Cauches with that river, that Ecuadorean line descends the Chinchipe to the Marañon, and the Peruvian ascends to a point where it is intersected by a line following the eastern Cordillera northward to the head-waters of the Caquetá, or Japurá, which forms the northern boundary down to the Brazilian frontier. This claim covers all eastern Ecuador and a large part of south-eastern Colombia. In 1903 there were encounters between small bodies of Peruvian and Ecuadorean troops on the disputed frontier. After arbitration by the king of Spain had been agreed upon, the question was considered by two Spanish commissions, and modifications favouring Peru were recommended. These became known prematurely, and in May 1910 war was threatened between Peru and Ecuador in spite of an offer of mediation by the United States, Brazil and Argentina under the Hague Convention.

From the Japurá southward to the Amazon, in 4° 13' 21" S., 69° 35' W., and thence up the Javary, or Yavari, to its source in 7° 8' 4" S., 73° 46' 30" W., as determined by a mixed commission, the line has been definitely settled. From near the source of the Javary, or lat. 7° 1' 17" S., a line running eastward to the Madeira in lat. 6° 52' 15" S., which is half the distance between the mouth of the Mamoré and the mouth of the Madeira, divides the Spanish and Portuguese possessions in this part of South America, according to the provisions of the treaty of San

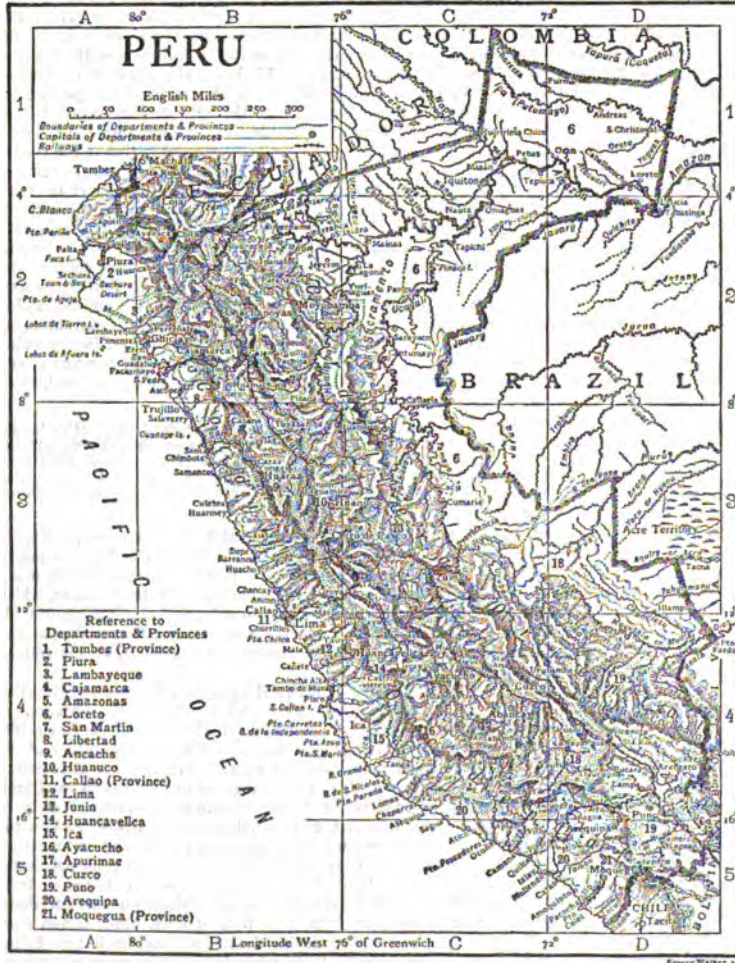

PERU (apparently from *Biru*, a small river on the west coast of Colombia, where Pizarro landed), a republic of the Pacific coast of South America, extending in a general N.N.W.-S.S.E. direction from lat. 3° 21' S. to about 18° S., with a sea-coast of 1240 m. and a width of 300 to 400 m., exclusive of territories in dispute. Its area in 1906, including Tacna and Arica, and other disputed territories occupied by neighbouring states, was officially estimated at 1,752,422 sq. kilometers, or 676,638 sq. m.; exclusive of these territories, the area of Peru is variously

estimated at 439,000 to 480,000 sq. m., the Gotha measurements being 1,137,000 sq. kilometers, or 439,014 sq. m. This line has been twice modified by treaties between Bolivia and Brazil, but without the consent of Peru, which claimed all the territory eastward to the Madeira between the above-mentioned line and the Beni-Madidi rivers, the line of demarcation following the Pablo-bamba, a small tributary of the Madidi, to its source, and thence in a straight line to the village of Conima, on Lake Titicaca. The dispute with Brazil relates to the territory acquired by that republic from Bolivia in 1867 and 1903, and was to be settled, according to an agreement

of 1908, by direct negotiation if possible, or, failing this, by arbitration. The decision of the president of Argentina of the 9th of July 1909, in regard to the remainder of this extensive territory, was a compromise, and divided it into two nearly equal parts. The line adopted starts from Lake Suches, the source of a small river of that name flowing into the north of Lake Titicaca, crosses the Cordillera by the Palomani to the Tambopata river, follows that stream to the mouth of the Lanza, thence crosses to the source of the Heath river, which forms the dividing line down to its junction with the Madre de Dios, descends that river to the mouth of the Toromonas, thence in a straight line north-westerly to the intersection of the Tahuamanu river by the 60th meridian, and thence north on that meridian to the Brazilian frontier. This decision at first gave offence to the Bolivians, but friendly overtures from Peru led to its acceptance by both parties with the understanding that modifications would be made in locating the line wherever actual settlements had been made by either party on territory awarded to the other. With Chile the *de jure* line is that of the Camarones ravine which separated the old department of Moquegua (including the provinces of Tacna and Arica) from that of Tarapacá. The *de facto* line is that of the Sama river (usually dry), which opens on the coast a little south of Sama point, near 18° S., Chile retaining possession of the two above-mentioned provinces in violation of the treaty of Ancon, which she forced upon her defeated antagonist.

Physical Geography.—Peru is divided longitudinally into three well-defined regions, the coast, the sierra and the montaña. The coast, extending from the base of the Western or Maritime Cordillera to the Pacific Ocean, consists of a sandy desert crossed at intervals by rivers flowing through narrow, fertile valleys. The sierra is the region of the Andes, and is about 250 m. in width. It contains stupendous chains of mountains, elevated plains and table-lands, warm and fertile valleys and ravines. The montaña is the region of tropical forests within the valley of the Amazon, and skirts the eastern slopes of the Andes.

The coast has been upraised from the ocean at no very distant geological epoch, and is nearly as destitute of vegetation as the African Sahara. It is watered, however, by fifty streams which cross the desert at intervals.

Half of these have their origin in the summits of the Andes, and run with a permanent supply of water into the ocean. The others, rising in the outer range, which does not reach the snow-line and receives less moisture, carry a volume of water to the sea during the rainy season, but for the rest of the year are nearly dry. The absence of rain here is ascribed to the action of the lofty uplands of the Andes on the trade-wind, and to the influence of the cold Humboldt current sweeping northward along the west coast of the continent. The south-east trade-wind blows obliquely across the Atlantic Ocean until it reaches Brazil. By this time it is heavily laden with vapour, which it continues to bear along across the continent, depositing it and supplying the sources of the Amazon and La Plata. When the wind rises above the snow-capped Andes, the last particle of moisture is wrung from it that a very low temperature can extract. Passing the summit of that range, it rushes down as a cool and dry wind on the Pacific slopes beyond. Meeting with no evaporating surface, and with no temperature colder than that to which it is subjected on the mountain-tops, this wind reaches the ocean before it becomes charged with fresh moisture. The constantly prevailing wind on the Peruvian coast is from the south, which is a cold wind from the Humboldt current. As it moves north it becomes gradually warmed and takes up moisture instead of depositing it as rain. From November to April there are usually constant dryness, a clear sky, and considerable, though by no means oppressive, heat. From June to September the sky is obscured for weeks together by fog, which is often accompanied by drizzling rain called *garwa*. At the time when it is hottest and driest on the coast it is raining heavily in the Andes, and the rivers are full. When the rivers are at their lowest, the *garwa* prevails on the coast. The climate of various parts of the coast, however, is modified by local circumstances.

The Western Cordillera, overhanging the Peruvian coast, contains a long line of volcanic mountains, most of them inactive, but their presence is probably connected with the frequent and severe earthquakes, especially in the southern section of the coast. Since 1570 seventy violently destructive earthquakes have been recorded on the west coast of South America, but the register is incomplete in its earlier part. The most terrible was that of 1746, which destroyed Callao, on the 28th of October, and there were 220 shocks in the following twenty-four hours. The town was overwhelmed by a vast wave, which rose 80 ft.; and the shocks continued until the following February. On the 13th of August 1868 an earthquake

nearly destroyed Arequipa, and great waves rolled in upon the ports of Arica and Iquique. On the 9th of May 1877 nearly all the southern ports were overwhelmed.

The deserts between the river-valleys vary in extent, the largest being more than 70 m. across. On their western margin steep cliffs generally rise from the sea, above which is the *tableau* or plateau, in some places slightly undulating, in others with ridges of considerable height rising out of it. The surface is generally hard, but in many places there are large accumulations of drifting sea-sand. The sand usually forms isolated hillocks, called *medanos*, of a half-moon shape, having their convex sides towards the trade-wind. They are from 10 to 20 ft. high, with an acute crest, the inner side perpendicular, the outer with a steep slope. Sometimes, especially at early dawn, there is a musical noise in the desert, like the sound of distant drums, which is caused by the eddying of grains of sand in the heated atmosphere, on the crests of the *medanos*.

Apparently the deserts are destitute of all vegetation; yet three kinds of herbs exist, which bury themselves deep in the earth, and survive long periods of drought. One is an amar. *Coast Flora*. anthaceous plant, whose stems ramify through the sandhills; the other two are a *Martynia* and an *Amisela*, which maintain a subterranean existence during many years, and only produce leafy stems in those rare seasons when sufficient moisture penetrates to the roots. In a few hollows which are reached by moisture the trees of the desert find support, the *algarrobo* (*Prosopis horrida*), a low tree of very scraggy growth, the *vichaya* (*Capparis crotonoides*), and the *popote del perro* (*Colicodendron scabridum*), mere shrubs. Near the Cordillera and on its lower slopes a tall branched cactus is met with, and there are *Salicornias* and *Salsolias* near the coast. But, when the mists set in, the low hills near the coast bordering the deserts, which are called *lomas*, undergo a change as if by magic. A blooming vegetation of wild flowers for a short time covers the barren hills. Near Lima one of the low ranges is brightened by the beautiful yellow lily called *amasnacas* (*Ismeno Amarancae*). The other flowers of the *lomas* are the *popila de San Juan* (*Begonia geraniifolia*), with red petals contrasting with the white inner sides, valerians, the beautiful *Bomarea ovalis*, several species of *Oxalis*, *Solanum* and crucifers. But this carpet of flowers is very partially distributed and lasts but a short time.

The valleys form a marvellous contrast to the surrounding desert. A great mass of pale-green foliage is usually composed of the *algarrobo* trees, while the course of the river is marked by lines or groups of palms, by fine old willows (*Salix humboldtiana*), fruit-gardens, and fields of cotton, Indian corn, sugar-cane and alfalfa (lucerne). In some valleys there are expanses of sugar-cane, in others cotton, whilst in others vineyards and olive-yards predominate. The woods of *algarrobo* are used for pasture, cattle and horses enjoying the pendulous yellow pods.

For purposes of description the coast-region of Peru may be divided into five sections, beginning from the north: (1) the Piura region; (2) the Lambayeque and Trujillo section; (3) the Santa valleys; (4) the section from Lima to Nasca; (5) the Arequipa and Tacna section.

(1) The great desert-region of Piura extends for nearly 200 m. from the Gulf of Guayaquil to the borders of the Morrope Valley, and is traversed by three rivers—the Tumbes, Chira and Piura, the two former receiving their waters from the inner Cordillera and breaking through the outer range. It is here that the coast of South America extends farthest to the westward until it reaches Capes Blanco and Paríta, and then turns southward to the Bay of Paíta. The climate of Piura is modified by the lower latitude, and also by the vicinity of the forests of Guayaquil. Fog and *garwa* are much less frequent than in the coast-region farther south, while rain sometimes falls. At intervals of three or four years there are occasional heavy showers of rain from February to April. (2) The second section of the coast-region includes the valleys of the Morrope, the Chiclayo, and Lambayeque, the Saña, the Joquetepeque, the Chicama, Moche, Viru and Chao. With the intervening deserts this section extends over 200 m. All these valleys, except Morrope and Chao, are watered by rivers which have their sources far in the recesses of the mountains, and which furnish an abundant supply in the season when irrigation is needed. (3) The third section, also extending for 200 m., contains the valleys of Santa, Nepeña, Casma, Huarmey, Fortaleza, Pativilca, Supé and Huaura. The river Santa, which rises in the lake of Conococha, 12,907 ft. above the sea, and has a length of 180 m., is remarkable for its long course between the outer and central range of the Andes, in a trough known as the "Callejon de Huaylas," 100 m. in length. It then breaks through in a deep gorge, and reaches the sea after a course of 35 m. over the coast-belt, and after fertilizing a rich valley. The Santa and Nepeña valleys are separated by a desert 8 leagues in width, on the shores of which there is a good anchorage in the bay of Ferrol, where the port of Chimbote is the terminus of a railway. The Nepeña, Casma, Huarmey, Fortaleza and Supé rivers rise on the slope of an outer range called the Cordillera Negra, and are consequently dry during the great part of the year. Wells are dug in their beds, and the fertility of the valleys is thus maintained. The Pativilca (or Barranca) river and the Huaura brook

through the outer range from their distant sources in the snowy Cordillera, and have a perennial supply of water. There are 9 leagues of desert between the Nepeña and Caama, 16 between the Caama and Huarney, and 18 between the Huarney and Fortaleza. The latter desert, much of which is loose sand, is called the *Pampa de Mala Cavallos*, from the number of exhausted animals which die there. Between the Supó and Pativica is the desert called the *Pampa del Medio Mundo*. (4) The next coast-section extends for over 300 m., from Chancay to Nasca, and includes the rivers of Chancay or Lacha, of Carabayllo, Rimac, Lurín, Mala, Cañete, Chinchá, Pisco or Chunchanga, Ica and Rio Granga. Here the maritime range approaches the ocean, leaving a narrower strip of coast, but the fertile valleys are closer and more numerous. Those of Carabayllo and Rimac are connected, and the view from the Bay of Callao extends over a vast expanse of fertile plain bounded by the Andes, with the white towers of Lima in a setting of verdure. Lurín and Mala are smaller valleys, but the great vale of Cañete is one green sheet of sugar-cane; and narrow strips of desert separate it from the fertile plain of Chinchá, and Chinchá from the famous vineyards of Pisco. The valleys of Ica, Palpa, San Xavier and Nasca are rich and fertile, though they do not extend to the sea; but between Nasca and Acari there is a desert 60 m. in width. (5) The Arequipa and Tacna section extends over 350 m. and comprises the valleys of Acari, Atequipa, Atico, Ocoña, Majes or Camana, Quilca, with the interior valley of Arequipa, Tambo, Ilo or Moquegua, Ite or Locumba, Sama, Tacna, and Azapa or Arica. Here the Western Cordillera recedes, and the important valley of Arequipa, though on its western slope, is 7000 ft. above the sea and 90 m. from the coast. Most of the rivers here have their sources in the central range, and are well supplied with water. The coast-valleys through which they flow, especially those of Majes and Locumba, are famous for their vineyards, and in the valley of Tambo there are extensive olive plantations.

The coast of Peru has few protected anchorages, and the headlands are generally abrupt and lofty. These and the few islands are frequented by sea-birds, whence come the guano-deposits, the retention of ammonia and other fertilizing properties being due to the absence of rain. The islets off the coast are all barren and rocky.

Islands.

The most northern is Foca, in $5^{\circ} 13' 30''$ S., near the coast to the south of Paita. The islands of Lobos de Tierra and Lobos de Afuera (2) in $6^{\circ} 27' 45''$ S. and $6^{\circ} 36' 45''$ S. respectively, are off the desert of Sechura, and contain deposits of guano. The two Afuera islands are 60 and 36 m. respectively from the coast at the port of San José. The islets of Macabí, in $7^{\circ} 49' 20''$ S., also have guano deposits, now practically exhausted. The two islets of Guáñape, surrounded by many rocks, in $8^{\circ} 34' 30''$ S., contain rich deposits. Chao rises 450 ft. above the sea, off the coast, in $8^{\circ} 46' 30''$ S. Corcobado is in $8^{\circ} 57' 5''$ S. La Viuda is off the port of Casma, in $9^{\circ} 23' 30''$ S.; and Tortuga is 2 m. distant to the north. Santa Islet lies off the bay of Cosca, in $9^{\circ} 1' 40''$, and the three high rocks of Ferrol in $9^{\circ} 8' 30''$ S. Farther south there is the group of islets and rocks called Huaura, in $11^{\circ} 27' 5''$, the chief of which are El Pelado, Tambillo, Chiquitana, Bravo, Quitacalzones and Mazorque. The Hornigmas are in $11^{\circ} 4' 5''$ S. and $11^{\circ} 58''$, and the Pescadores in $11^{\circ} 47' 5''$ S. The island of San Lorenzo, in $12^{\circ} 4' 5''$ S., is a lofty mass, 4½ m. long by 1 broad, forming the Bay of Callao; its highest point is 1050 ft. Off its south-east end lies a small but lofty islet called Frontón, and to the south-west are the Palomitas Rocks. Horadada Islet, with a hole through it, is to the south of Callao Point. Off the valley of Lurín are the Pachacamac Islands, the most northern and largest being half a mile long. The next, called San Francisco, is like a sugar-loaf, perfectly rounded at the top. The others are mere rocks. Asia Island is farther south, 17 m. north-west of Cerro Azul, and about a mile in circuit. Pisco Bay contains San Gallan Island, high, with a bold cliff outline, 2½ m. long by 1 broad, the Ballista Islets, and farther north the three famous Chinchá Islands, whose vast guano deposits are now exhausted. South of the entrance to Pisco Bay is Zarate Island, and farther south the white level islet of Santa Rosa. The Infernillo rock is quite black, about 50 ft. high, in the form of a sugar-loaf, a mile west of the point of Santa Maria, which is near the mouth of the Ica river; Alacran is a small islet off the lofty "morro" of Arica. All these rocks and islets are barren and uninhabitable. The more common sea-birds are the *Sula sarrigala* or guano-bird, a large gull called the *Larus modestus*, the *Pelecanus thuyas*, and the *Sterna Ynca*, a beautiful tern with curved white feathers on each side of the head. The rarest of all the gulls is also found on the Peruvian coast, namely, the *Xema furcatum*. Sea-lions (*Otaria forsteri*) are common on the rocky islands and promontories.

The region of the Cordilleras of the Andes is divided into *puna*, or lofty uninhabited wilderness, and *sierra*, or inhabitable mountain slopes and valleys. This great mountain-system, running south-east to north-west, consists of three chains or cordilleras. The two chains, which run parallel and near each other on the western side, are of identical origin, and have been separated by the action of water during many centuries. On these chains are the volcanoes and many thermal springs. The narrow space between them is for the most part, but not always, a cold and lofty region known as the *puna* containing alpine lakes—the sources of the coast-rivers. The great eastern chain, rising from

the basin of the Amazon and forming the inner wall of the system, is of distinct origin. These three chains are called the Western or Maritime Cordillera, the Central Cordillera and the Andes. Paz Soldán and other Peruvian geographers give the name of Andes, *par excellence*, to the Eastern Cordillera.

The Maritime Cordillera of Peru has no connexion with the coast ranges of Chile, but is a continuation of the Cordillera Occidental of Chile, which under various local names forms the eastern margin of the coastal desert belt from Atacama northward into Peru. It contains a regular chain of volcanic peaks overlooking the coast-region of Tarapacá. Chief among them are the snowy peak of Lirima (19,128 ft.) over the ravine of Tarapacá, the volcano of Isluga overhanging Camiña, the Bolivian peak of Sajama, and Tocora (19,741 ft.) near the Bolivian frontier. In rear of Moquegua there is a group of volcanic peaks, clustering round those of Ubinas and Huaynaputina. A great eruption of Huaynaputina began on the 15th of February 1600 and continued until the 28th. But generally these volcanoes are quiescent. Farther north the Misti volcano rises over the city of Arequipa in a perfect cone to a height of over 20,013 ft., and near its base are the hot sulphur and iron springs of Yura. The peak of Sarasa, in Parinacochas (Ayacucho) is 19,500 ft. above the sea, and in the mountains above Lima the passes attain a height of more than 15,000 ft. In latitude 10° S. the maritime chain separates into two branches, which run parallel to each other for 100 m., enclosing the remarkable ravine of Callejon de Huaylas—the eastern or main branch being known as the Cordillera Nevada and the western as the Cordillera Negra. On the Nevada the peak of Huascan reaches a height of 22,051 ft. The Huandoy peak, above Carhuaz, rises to 21,088 ft.; the Huacra peak, overhanging the town of Yungay, is 19,945 ft. high; and most of the peaks in this part of the chain reach a height of 19,000 ft. During the rainy season, from October to May, the sky is generally clear at dawn, and the magnificent snowy peaks are clearly seen. But as the day advances the clouds collect. In most parts of the Peruvian Andes the line of perpetual snow is at 16,400 ft.; but on the Cordillera Nevada, above the Callejon de Huaylas, it sinks to 15,400 ft. This greater cold is caused by the intervention of the Cordillera Negra, which intercepts the warmth from the coast. As this lower chain does not reach the snow-line, the streams rising from it are scanty, while the Santa, Pativica and other coast-rivers which break through it from sources in the snowy chain have a greater volume from the melted snows. At the point where the river Santa breaks through the Cordillera Negra that range begins to subside, while the Maritime Cordillera continues as one chain to and beyond the frontier of Ecuador.

The Central Cordillera is the true water-parting of the system. No river, except the Marañón, breaks through it either to the east or west, while more than twenty coast streams rise on its slopes and force their way through the maritime chain. The Central Cordillera consists mainly of crystalline and volcanic rocks, on each side of which are aqueous, in great part Jurassic, strata thrown up almost vertically. In $14^{\circ} 30'$ S. the central chain is connected with the Eastern Andes by the transverse mountain-knot of Vilcaflota, the peak of that name being 17,651 ft. above the sea. The great inland basin of Lake Titicaca is thus formed. The central chain continues to run parallel with the Maritime Cordillera until, at Cerro Pasco, another transverse knot connects it with the Andes in $10^{\circ} 30'$ S. lat. It then continues northward, separating the basins of the Marañón and Huallaga; and at the northern frontier of Peru it is at length broken through by the Marañón flowing eastward.

The Eastern Andes is a magnificent range in the southern part of Peru, of Silurian formation, with talcose and clay slates, many quartz veins and eruptions of granitic rocks. Mr Forbes says that the peaks of Illampu (21,709 ft.) and Illimani (21,014 ft.) in Bolivia are Silurian and fossiliferous to their summits. The eastern range is cut through by six rivers in Peru, namely, the Marañón and Huallaga, the Perene, Mantaro, Apurimac, Vilcamayo and Paucartambo, the last five being tributaries of the Ucayali. The range of the Andes in south Peru was a high plateau to the west and the vast plains of the Amazonian basin to the east. The whole range is highly auriferous, and the thickness of the strata is not less than 10,000 ft. It is nowhere disturbed by volcanic eruptions, except at the very edge of the formation near Lake Titicaca, and in this respect it differs essentially from the Maritime Cordillera. To the eastward numerous spurs extend for varying distances into the great plain of the Amazons.

The Andes lose their majestic height to the northward; and beyond Cerro Pasco the eastern chain sinks into a lower range between the Huallaga and Ucayali. But throughout the length of Peru the three ranges are clearly defined.

For purposes of description the sierra of Peru may be divided into four sections, each embracing portions of all three ranges. The first, from the north, comprises the upper basins Sections of the Marañón and the Huallaga, and is 350 m. long by 100 broad. The second extends from the Knot of Cerro Pasco to Ayacucho, about 200 m., including the Lake of Chinchay-cocha and the basin of the river Yauza. The third or Cuzco section extends 250 m. to the Knot of Vilcaflota with the basins of the Pampas, Apurimac, Vilcamayo and Paucartambo. The fourth is the basin of Lake Titicaca.

Lake Junin, or Chinchay-cocha, in the second section, is 36 m. long by 7 m. broad, and 13,232 ft. above the sea. Its marshy banks are overgrown with reeds and inhabited by numerous waterfowl. From this lake the river Xauxa flows southwards through a populous valley for 150 m. before entering the forests. Lake Titicaca (see Bolivia), in the fourth or most southern section, is divided between Peru and Bolivia. It receives a number of short streams from the ranges shutting in the upper end of the valley; the largest is the Ramiz, formed by the two streams of Pucara and Azangaro, both coming from the Knot of Vilcañota to the north. The Suches, which has its source in Lake Suches, falls into Lake Titicaca on the north-west side, as well as the Ylpa and Ylave. The principal islands are Titicaca and Coati (at the south end near the peninsula of Copacabana), Campanaria (9 m. from the east shore), Soto and Esteves. There are two other lakes in the *Collao*, as the elevated region round Titicaca is called. Lake Arapa, a few miles from the northern shore of Titicaca, is 30 m. in circumference. Lake Umayo is on higher ground to the westward. The lake in Peru which is third in size is that of Parinacocha on the coast watershed, near the foot of the snowy peak of Saracasa. It is 12 m. long by 6 broad, but has never been visited and described by any modern traveller. The smaller alpine lakes, often forming the sources of rivers, are numerous.

The great rivers of the sierra are the Marañon, rising in the lake of Lauricocha and flowing northward in a deep gorge between the Maritime and Central Cordilleras for 350 m.; when it forces its way through the mountains at the famous Pongo de Manseriche and enters the Amazonian plain. The Huallaga rises north of Cerro Pasco, and, passing Huanuco, flows northwards on the other side of the Central Cordillera for 300 m. It breaks through the range at the Pongo de Chasuta and falls into the Marañon. The other great rivers are tributaries of the Ucayali. The Pozuzu, flowing eastward from the Knot of Cerro Pasco, joins the Pachitea, which is the most important northern affluent of the Ucayali. The Xauxa, becoming afterwards the Mantaro, receives the drainage of Xauxa, Huanavelica and Ayacucho. The southern valleys of this part of the sierra furnish streams which form the main rivers of Pampas, Pachachaca and Apurimac. These, uniting with the Mantaro, form the Ené, and the Ené and Perené (which drains the province of Tambo) form the Tambo. The Vilcanayu rises on the Knot of Vilcañota, flows north through a lovely valley, received the Yanatile and Paucartambo on its right bank, and, uniting with the Tambo, forms the Ucayali. Most of these main streams flow through profound gorges in a tropical climate, while the upper slopes yield products of the temperate zone, and the plateaus above are cold and bleak, affording only pasture and the hardest cereals.

The great variety of elevation within the sierra produces vegetation belonging to every zone. There is a tropical flora in the

*Sierras
Flora and
Fauna.*

deep gorges, higher up a sub-tropical, then a temperate, then a sub-arctic flora. In ascending from the coast-valleys there is first an arid range, where the great-branched cacti rear themselves up among the rocks. Farther inland, where the rains are more plentiful, is the native home of the potato. Here also are other plants with edible roots—the *oca* (*Oxalis tuberosa*), *ulluca* (*Ullucus tuberosus*), *masnu* (*Tropaeolum tuberosum*), and *leavó* (*Polymnia sonchifolia*). Among the first wild shrubs and trees that are met with are the *chilca* (*Baccharis Feuilletii*), with a pretty yellow flower, the *Mutisia acuminata*, with beautiful red and orange flowers, several species of *Senecio*, *calceolarias*, the *Schinus molle*, with its graceful branches and bunches of red berries, and at higher elevations the *lambrus* (*Ailurus acuminata*), the *sausa* (*Sambucus peruviana*), the *queñuar* (*Buddleia incana*), and the *Polyplepis racemosa*. The *Buddleia* locally called *siso sinestra*, flourishes at a height of 12,000 ft. round the shores of Lake Titicaca. The most numerously represented family is the *Compositae*, the grasses being next in number. The temperate valleys of the sierra yield fruits of many kinds. Those indigenous to the country are the delicious *chirimoyas*, *paltas* or alligator pears, the *pacayá*, a species of *Inga*, the *lucma*, and the *granadilla* or fruit of the passion-flower. Vineyards and sugar-cane yield crops in the warmer ravines; the sub-tropical valleys are famous for splendid crops of maize; wheat and barley thrive on the mountain slopes; and at heights from 7000 to 13,000 ft. there are crops of *quinua* (*Chenopodium quinua*). In the loftiest regions the pasture chiefly consists of a coarse grass (*Stipa ychu*), of which the llamas eat the upper blades and the sheep browse on the tender shoots beneath. There are also two kinds of shrubby plants, a thorny *Composita* called "coanli" and another, called "tola," which is a resinous *Baccharis* and is used for fuel.

The animals which specially belong to the Peruvian Andes are the domestic llama and alpaca and the wild vicuña. There are deer, called *tarsaco* (*Cervus antiscensis*); the *viscachá*, a large rodent; a species of fox called *aloc*; and the puma (*Pelis concolor*) and *ucumari* or black bear with a white muzzle, when driven by hunger, wander into the loftier regions. The largest bird is the condor, and there is another bird of the vulture tribe, with a black and white wing feather formerly used by the Incas in their head-dress, called the *coaqueque* or *alcamari*. The *pito* is a brown speckled creeper which flutters about the rocks. There is a little bird, the size of a starling, with brown back striped with black, and white breast, which the

Indians call *yncahuilpa*; it utters a monotonous sound at each hour of the night. A partridge called *yaitis* frequents the long grass. On the lakes there is a very handsome goose, with white body and dark-green wings shading into violet, called *huachua*, two kinds of ibis, a large gull (*Larus serranus*) frequenting the alpine lakes in flocks, flamingoes called *pariwana*, ducks and water-hens. Many pretty little fitches fly about the maize-fields and fruit-gardens, and a little green parakeet is met with as high as 12,000 ft. above the sea.

The third division of Peru is the region of the tropical forests, at the base of the Andes, and within the basin of the Amazon. It is traversed by great navigable rivers. The Marañon, having burst through the defile of the Pongo de Manseriche (573 ft. above sea level), and the Huallaga through that of Chasuta, enter the forests and unite after separate courses of about 600 and 400 m., the united flood then flowing eastward to the Brazilian frontier. After 150 m. it is joined by the Ucayali, a great navigable river with a course of 600 m. The country between the Huallaga and the Ucayali, traversed by the Eastern Cordillera, is called the Pampa del Sacramento, and is characterized by extensive grassy plains. The forests drained by the Marañon, Huallaga and Ucayali form the northern portion of the Peruvian montaña. The southern half of the *montaña* is watered by streams flowing from the eastern Andes, which go to form the river Madre de Dios or Amaru-mayu, the principal branch of the river Beni, which falls into the Madeira. The region of the Peruvian montaña, which is 800 m. long from the Marañon to the Bolivian frontier, is naturally divided into two sections, the sub-tropical forests in the ravines and on the eastern slopes of the Andes, and the dense tropical forests in the Amazonian plain. The sub-tropical section is important from the value of its products and interesting from the grandeur and beauty of its scenery. Long spurs run off from the Andes, gradually decreasing in elevation, and it is sometimes a distance of 60 or 80 m. before they finally subside into the vast forest-covered plains of the Amazon basin. Numerous rivers flow through the valleys between these spurs, which are the native home of the quinine-yielding cinchona trees. The most valuable species, called *C. calixaya*, is found in the forests of Carabaya in south Peru and in those of Bolivia. The species between Carabaya and the headwaters of the Huallaga yield very little of the febrifuge alkaloid. But the forests of Huanuco and Huamaliós abound in species yielding the grey bark of commerce, which is rich in cinchonine, an alkaloid efficacious as a febrifuge, though inferior to quinine. With the cinchona trees grow many kinds of *melastomaceae*, especially the *Lasiandra*, with masses of purple flowers, tree-ferns and palms. In the warm valleys there are large plantations of coca (*Erythroxylon Coca*), the annual produce of which is stated at 15,000,000 lb. The other products of these warm valleys are excellent coffee, cocoa, sugar, tropical fruits of all kinds, and gold in abundance. In the vast untrodden forests farther east there are timber trees of many kinds, incense trees, a great wealth of rubber trees of the *Hevea* genus, numerous varieties of beautiful palms, sarsaparilla, vanilla, ipecacuanha and copaiba. The abundant and varied fauna is the same as that of the Brazilian forests.

Geology.—The Eastern Cordillera, which, however, is but little known, appears to consist, as in Bolivia, chiefly of Palaeozoic rocks; the western ranges of the Andes are formed of Mesozoic beds, together with recent volcanic lavas and ashes; and the lower hills near the coast are composed of granite, syenite and other crystalline rocks, sometimes accompanied by limestones and sandstones, which are probably of Lower Cretaceous age, and often covered by marine Tertiary deposits. Thus the orographical features of the country correspond broadly with the geological divisions.

The constitution of the Mesozoic band varies. Above Lima the western chain of the Andes is composed of porphyritic tuffs and massive limestones, while the longitudinal valley of the Oroya is hollowed in carbonaceous sandstones. From the analogy of the neighbouring countries it is possible that some of the tuffs may be Jurassic, but the other deposits probably belong for the most part to the Cretaceous system. The carbonaceous sandstone contains Gault fossils. Like the similar sandstone in Bolivia, it includes seams of coal and is frequently impregnated with cinnabar. It is in this sandstone that the rich mercury mines of Huancavelica are worked.

Farther north, in the department of Ancachs, the Mesozoic belt is composed chiefly of sandstones and shales, and the limestones which form so prominent a feature above Lima seem to have disappeared. The Cordillera Negra in this region is in many places cut by numerous dikes of diorite, and it is near these dikes that silver ores are chiefly

¹ See L. Crozier, "Notice géologique sur les départements de Huancavelica et d'Ayacucho," *Ann. des mines*, 5th series, vol. II. pp. 1-43, Pl. 1 (1852); A. Raimondi, *El Departamento de Arequipa y sus riquezas minerales* (Lima, 1873); G. Steinmann, "Ueber Tithon und Kreide in den peruanischen Anden," *Neues Jahrb.* (1882), vol. II. pp. 130-153, Pls. 6-8; C. Gerhardt, "Beitrag zur Kenntnis der Kreideformation in Venezuela und Peru," *Neues Jahrb.*, Bei.-Bd. XI. (1897), pp. 65-117, Pls. 1, 2; J. Grzybowski, "Die Tertiärlagerungen des nördlichen Peru und ihre Molluskenfauna," *Neues Jahrb.*, Bei.-Bd. XI. (1899), pp. 610-664, Pls. 15-20.

found. In the Cordillera Nevada the Mesozoic rocks which form the chain are often covered by masses of modern volcanic rock. Similar rocks are also found in the Cordillera Negra, but the volcanic centres appear to have been in the Sierra Nevada.

Population.—The first trustworthy enumeration of the people of Peru was made in 1793, when there were 617,700 Indians, 241,225 mestizos (Indian and white inter-mixture), 136,311 Spaniards, 40,337 negro slaves and 41,404 mulattoes, making a total of 1,076,977, exclusive of the wild Indians of the *montaña*. Viceroy Toledo's enumeration of the Indians in 1575 gave them a total of 8,000,000, the greater part of whom had been sacrificed by Spanish cruelty. Others had withdrawn into the mountains and forests, and in the native villages under Spanish administration the birth rate had dropped to a small part of what it had been because the great bulk of the male population had been segregated in the mines and on the estates of the conquerors. This tells a story of depopulation under Spanish rule, to which the abandoned terraces (*andenes*) on the mountain sides, once highly cultivated, bear testimony. Several diverse totals have been published as the result of the census taken in 1876, which is considered imperfect. One estimate places the total at 2,660,881, comprising about 13.8% whites, 57.6% Indians, 1.9% negroes, 1.9% Asiatics, chiefly Chinese, and 24.8% mixed races. In 1906 estimates were made under official auspices (see A. Garland, *Peru in 1906*, Lima, 1907), which gave the population as 3,547,829, including Tacna (8000). It is believed, however, that this and other larger estimates are excessive. There is no considerable immigration.

The population of Peru is mixed, including whites, Indians, Africans, Asiatics, and their mixtures and sub-mixtures. The dominant race is of Spanish origin, to a considerable extent mixed with Indian blood. The Indians are in great part descendants of the various tribes organized under the rule of the Incas at the time of the Spanish conquest. There are two distinct general types—the coast tribes occupying the fertile river valleys, who are employed on the plantations, in domestic service in the cities, or in small industries of their own, no longer numerous; and the sierra tribes, who are agriculturists, miners, stock-breeders and packers, still comparatively numerous. In addition to these are the tribes of wild Indians of the *montaña* region, or eastern forests, who were never under Inca rule and are still practically independent. Their number is estimated at 150,000 to 300,000, divided into 112 tribes, and differing widely in habits, customs and material condition. Some live in settled communities and roughly cultivate the soil. Others are hunters and fishermen and are nomadic in habit. Others are intractable forest tribes, having no relations with the whites. The sierra or upland Indians, the most numerous and strongest type, belong largely to the Quichua and Aymará families, the former inhabiting the regions northward of Cuzco, and the latter occupying the Titicaca basin and the sierras of Bolivia. These Indians are generally described as *Cholos*, a name sometimes mistakenly applied to the *mestizos*, while the tribes of the eastern forests are called *Chunchos*, *barbaros*, or simply Indians. The *Cholos* may be roughly estimated at about 1,800,000 and form by far the larger part of the sierra population. Practically all the industries and occupations of this extensive region depend upon them for labourers and servants.

The *mestizos* are of mixed Spanish and Indian blood. There are two general classes—the *costeños* or those of the coast, and the *serranos* or those of the sierras. The *mestizos* of the coast are usually traders, artisans, overseers, petty officers and clerks, and small politicians. In the sierras they have the same general occupations, but there are no social bars to their advancement, and they become lawyers, physicians, priests, merchants, officials and capitalists. The African and Asiatic elements furnish only about 2% each of the population. The Africans were introduced as slaves soon after the conquest, because the coast Indians were physically incapable of performing the work required of them on the sugar estates. All the heavy labour in the coast provinces was performed by them down to 1855, when African slavery was abolished. They have since preferred to live in the towns,

although many continue on the plantations. The first Chinese coolies were introduced in 1849 to supply labourers on the sugar estates, which had begun to feel the effects of the suppression of the African slave traffic. At first the coolies were treated with cruelty. The scandals that resulted led to investigations and severe restrictions, and their employment now has become a matter of voluntary contract, usually for two years, in which fair dealing and good treatment are the rule. Many Chinese are also settled in the coast cities. Commercial relations have also been opened with Japan, and a small Japanese colony has been added to the population. The Spanish and African cross is to be seen in the mulattoes, quadroons and octoroons that inhabit the warm coast cities. Other race mixtures consist of the *zambos* (the African-Indian cross), an Asiatic graft upon these various crosses, and an extremely confusing intermixture of the various crosses, for which the Spanish races have descriptive appellations. The foreign population is chiefly concentrated in Lima and Callao, though mining and other industries have drawn small contingents to other places.

Education.—Universities and colleges were founded in Peru soon after the conquest, and Lima, Cuzco, Arequipa and Chuquisaca (now the Bolivian town of Sucre) became centres of considerable intellectual activity. Something was done for the education of the sons of the Indian "nobility," schools being created at Lima and Cuzco. The university of San Marcos at Lima is the oldest collegiate institution in the New World, originating in a grant from Charles V. in 1551 to the Dominicans for the establishment of a college in their monastery at Lima. Its present name, however, was not adopted until 1574, two years after its first secular rector had been chosen. The college of San Carlos was founded in 1770, and the school of medicine in 1792. At Cuzco the university of San Antonio Abad was founded in 1598, and the college of San Gerónimo at Arequipa in 1616. The instruction given in these institutions was of the religious-scholastic character of that time, and was wholly under the supervision of the Church. Independence opened the way for a larger measure of intellectual and educational progress, especially for the lower classes. As organized under the law of the 5th of December 1905, primary instruction is free and nominally obligatory, and is under the control of the national government. The primary schools are divided into two grades: a free elementary course of two years, and a higher course of three years, in a school called the "scholastic centre," in which learning a trade is included. There were 1508 elementary schools and 862 scholastic centres in 1906. There are, besides these, a large number of private schools, which in 1906 carried about 22,000 pupils on their roll, or three times the number in the public primary schools. To provide teachers six normal schools have been established, two of which (one for males and one for females) are in Lima. For intermediate or secondary instruction there are 23 national colleges for boys in the various departmental capitals, and three similar colleges for girls, in Ayacucho, Cuzco and Trujillo. In these the majority of pupils were under the direction of Belgian and German instructors. The private schools of this grade are still more numerous, and there are a number of special schools that belong to the same category. For higher instruction there are four universities: the Universidad Mayor de San Marcos at Lima; and three provincial institutions at Arequipa, Cuzco and Trujillo. All these have faculties of letters and law, and San Marcos has in addition faculties of theology, medicine, mathematics and science, philosophy and administrative and political economy. The professional schools include a school of civil and mining engineering at Lima (created 1876), a military school at Chorrillos under the direction of French instructors, a naval school at Callao, nine episcopal seminaries (one for each diocese), a national agricultural school in the vicinity of Lima (created 1902), and a few commercial schools. There is also a correctional school at Lima devoted to the education and training of youthful delinquents.

Science and Literature.—Towards the end of the 18th century scientific studies began to receive attention in Peru. M. Godin, a member of the French commission for measuring an arc of the meridian near Quito, became professor of mathematics at San Marcos in 1750; and the botanical expeditions sent out from Spain gave further zest to scientific research. Dr Gabriel Moreno (d. 1809), a native of Huamantanga in the Maritime Cordillera, studied under Dr Jussieu, and became an eminent botanist. Don Hipólito Unanue, born at Arica in 1755, wrote an important work on the climate of Lima and contributed to the *Mercuro peruano*. This periodical was started in 1791 at Lima, the contributors forming a society called "amantes del país," and it was completed in eleven volumes. It contains many valuable articles on history, topography, botany, mining, commerce and statistics. An *epheemeris* and guide to Peru was begun by the learned geographer Dr Cosme Busno, and continued by Dr Unanue, who brought out his guides at Lima from 1793 to 1798. In 1794 a nautical school was founded at Lima, with Andrés Balleato as instructor and Pedro Alvarez as teacher of the use of instruments. Balleato also constructed a map of Peru.

A list of Peruvian authors in viceregal times occupies a long chapter in the life of St Toribio¹ by Montalvo; and the bibliographical labours of the Peruvian Leon Pinedo are still invaluable to Spanish students. The most prolific author of colonial times was Dr Pedro de Peralta y Barauevo, who wrote more than sixty works, including an epic poem entitled *Lima fundada*.

The topographical labours of Cosme Bueno and Unanue were ably continued at Lima by Admiral Don Eduardo Carrasco, who compiled annual guides of Peru from 1826. But the most eminent Peruvian geographer is Dr Don Mariano Felipe Paz Soldan (1821-1886), whose *Geografía del Perú* appeared in 1861. His still more important work, the *Diccionario geográfico estadístico del Perú* (1877), is a gazetteer on a most complete scale. In 1868 appeared his first volume of the *Historia del Perú independiente*, and two others have since been published. His *Historia de la guerra del Pacífico* is the Peruvian version of that disastrous war. The earlier history of Peru has been written in three volumes by Sebastian Lorente (d. 1884); Mariano Rivero has discussed its antiquities; and Manuel Fuentes has edited six volumes of memoirs written by Spanish viceroys. But the most valuable and important historical work by a modern Peruvian is General Mendiburu's (1805-1885) *Diccionario histórico-biográfico del Perú*, a monument of patient and conscientious research, combined with critical discernment of a high order. As laborious historical students, Don José Toribio Polo, the author of an ecclesiastical history of Peruvian dioceses, and Don Enrique Torres Saldamando, the historian of the Jesuits in Peru, have great merit. Among good local annalists may be mentioned Juan Gilberto Valdivia, who has written a history of Arequipa, and Pio Benigno Mesa, the author of the *Annals of Cuzco*.

The leading Peruvian authors on constitutional and legal subjects are Dr José Santistevan, who has published volumes on civil and criminal law; Luis Felipe Villaran (subsequently rector of the university at Lima), author of a work on constitutional right; Dr Francisco García Calderon (once president of Peru), author of a dictionary of Peruvian legislation, in two volumes; Dr Francisco Xavier Mariategui, one of the fathers of Peruvian independence; and Dr Francisco de Paula Vigil (1792-1875), orator and statesman as well as author, whose work, *Defensa de los gobiernos*, is a noble and enlightened statement of the case for civil governments against the pretensions of the court of Rome. Manuel A. Fuentes, an able statistician and the author of the *Estadística de Lima*, has also written a manual of parliamentary practice. Perhaps the most important work on Peru of modern times is that of the Italian savant Antonio Raimondi (1825-1890), who spent the greater part of his life in studying the topography and natural resources of the country. Only four volumes had been published at the time of his death, but he left a mass of papers and manuscripts which the government has put in the hands of the Geographical Society of Lima for publication. His great work is entitled *El Perú: estudios mineralógicos*, &c. (3 vols., Lima, 1890-1902), and one separate volume on the department of Ancachs. Peruvian literature since the independence has also attained high merit in the walks of poetry and romance. The Guayaquil author, Olmedo, who wrote the famous ode on the victory of Junin, and the Limerians Felipe Pardo and Manuel Segura are names well known wherever the Spanish language is spoken. Both died between 1860 and 1870. The comedies of Segura on the customs of Lima society, entitled *Us Paseo a Amancaes* and *La Suya y Manto*, have no equal in the dramatic literature of Spanish America and few in that of modern Spain. From 1848 date the first poetical efforts of Arnaldo Marquez, who is distinguished for his correct diction and rich imagination, as is Nicolas Corpancho for his dramas and a volume of poems entitled *Brisas*, Adolfo Garcia for a beautiful sonnet to Bolivar, which was published at Havre in 1870, in his one volume of poems, and Clemente Althaus for his productivity and style. Pedro Paz Soldan was a classical scholar who published three volumes of poems. Carlos Augusto Salaverry is known as one of Peru's best lyrical poets, and Luis Benjamin Cisneros for his two novels, *Julia* and *Edgardo*. Trinidad Fernandez and Constantino Carrasco were two poets of merit who died young, the principal work of the latter being his metrical version of the Quichua drama, *Ollantay*. José Antonio Lavalle and Narciso Aretegui are chiefly known as novelists. In his youth Ricardo Palma published three books of poems, entitled *Armonías*, *Verbos y Gerundios* and *Pasionarias*, and then, since 1870, devoted his great literary talents to writing the historical traditions of Peru, of which six volumes were published. At the outbreak of the war with Chile he was vice-director of the national library at Lima, which was wantonly pillaged by the Chilean forces. After the evacuation of Lima by the Chileans Palma devoted his life to the recovery of his scattered books and the acquisition of new collections, and he had the satisfaction before his death of re-opening the library, which had obtained about 30,000 volumes, or three-fourths of the number on its shelves before the Chilean invasion.

Of the aboriginal inhabitants of Peru much has been written. The important work of Mariano Eduardo Rivero, of Arequipa,

¹ The city of Lima produced two saints, the archbishop St Toribio, who flourished from 1578 to 1606, and Santa Rosa, the patron saint of the city of the kings (1586-1616), whose festival is celebrated on the 26th of August.

assisted by J. J. von Tschudi, on the antiquities of Peru (*Antigüedades peruanas*, Vienna, 1841; Eng. trans., New York, 1853) has been followed by other investigators into the language, literature, customs and religion of the Incas. The best known of these are José Sebastián Barranca, the naturalist and antiquary, José Fernandez Nodal, and Gavino Pacheco Zagarra of Cuzco, who published translations of the Inca drama of *Ollantay*, and Leonardo Villar, of Cuzco.

Among Peruvian naturalists since the advent of the republic, the most distinguished have been Mariano Eduardo Rivero, the geologist, mineralogist and archaeologist, and his friend and colleague Nicolas de Pierola, authors of *Memorial de ciencias naturales*. The Lima Geographical Society (founded in 1888) is perhaps the best and most active scientific organization in the republic. Its special work covers national geographical exploration and study, archaeology, statistics and climatology, and its quarterly bulletins contain invaluable information. The society receives a government subsidy, and its rooms in the national library in Lima are the principal centre of scientific study in Peru. It had an active membership of 163 in 1906, besides 172 honorary and corresponding members. The historical institute of Peru, also at Lima, is charged by the government, from which it receives a liberal subsidy, with the work of collecting, preparing and publishing documents relating to Peruvian history, and of preserving objects of archaeological and historic character. Its museum, which is of great historical and artistic value and includes a collection of portraits of the Peruvian viceroys and presidents, is in the upper floors of the Exposition Palace. Another subsidized national society is the atheneum, which was founded in 1877 as the "literary club," and reorganized in 1887 under its present title. Its purpose is to foster learning and literary effort, and it is a popular and prominent feature in the intellectual life of the country.

Religion.—According to the constitution of 1860 "the nation professes the apostolic Roman Catholic religion; the state protects it, and does not permit the public exercise of any other." There is a certain degree of tolerance, however, and the Anglican and some of the evangelical churches are permitted to establish missions in the country, but not always without hostile demonstrations from the Catholic priesthood. There are Anglican churches in Lima and Cuzco, belonging to the diocese of the Bishop of the Falkland Islands; but their existence is illegal and is ignored rather than permitted. In its ecclesiastical organization Peru is divided into nine dioceses: Lima, which is an archbishopric, Arequipa, Puno, Cuzco, Ayacucho, Huanuco, Huaraz, Trujillo and Chachapoyas. These dioceses are subdivided into 613 curacies, presided over by *curas*, or curate-priests. Each diocese has its seminary for the education of the priesthood, that of Arequipa being distinguished for its influence in church affairs. Arequipa, like Cordoba and Chuquisaca, is a stronghold of clericalism and exercises a decisive influence in politics as well as in church matters. There are a number of fine churches in Lima and in the sees of the various dioceses. Monasteries and nunneries are numerous, dating back to the 16th and 17th centuries, but their influence is now less potent than in those days and the monastic population is not so large. In modern times many of the convents have been devoted to educational work especially for girls, which is an obstacle to the successful development of a public school system in the country.

Political Divisions.—The empire of the Incas was divided into four main divisions, Chinchay-suyu to the north of Cuzco, Anti-suyu to the east, Colla-suyu to the south and Cunti-suyu to the west, the whole empire being called Ttahuantinsuyu, or the four governments. Each was ruled by a viceroy, under whom were the "huananca-camayocs," or officers ruling over thousands, and inferior officers, in regular order, over 500, 100, 50 and 10 men. All disorders and irregularities were checked by the periodical visits of the *tucuyricos* or inspectors. The Spanish conquest destroyed this complicated system. In 1569 the governor, Lope Garcia de Castro, divided Peru into *corregimientos* under officers named *corregidores*, of whom there were 77, each in direct communication with the government at Lima. An important administrative reform was made in 1784, when Peru was divided into 7 *intendencias*, each under an officer called an *intendente*. These *intendencias* included about 6 of the old *corregimientos*, which were called *partidos*, under officers named *subdelegados*. Thus the number of officers reporting direct to Lima was reduced from 77 to 7, a great improvement. The republic adopted the same system, calling the *intendencias* departments, under a prefect, and the *partidos* provinces, under a sub-prefect. Peru is divided into 18 departments, 2 littoral provinces, and what is called the constitutional province of Callao. This is exclusive of Tacna and its 3 provinces. The departments, which contain 98 provinces, with their areas, capitals and estimated populations of 1906, are as follow: the

list being arranged to show the coast, sierra and montaña divisions:—

Departments.	Area sq. m.	Estimated pop., 1906.	Capital.	Estimated pop., 1906.
<i>Coast:—</i>				
Piura	14,849	154,080	Piura	9,100
Lambayeque	4,615	93,070	Chiclayo	10,000
Libertad	10,209	188,200	Trujillo	6,500
Ancachs	16,567	317,050	Huaraz	13,000
Lima	13,314	250,000	Lima (1903)	140,000
Ica (or Yca)	8,721	68,220	Ica	6,000
Arequipa	21,953	171,750	Arequipa	28,000
<i>Sierra:—</i>				
Cajamarca	12,542	333,310	Cajamarca	9,000
Huanuco	14,028	108,980	Huanuco	6,000
Junin	23,354	305,700	Cerro de Pasco	10,000
Huancavelica	9,254	167,840	Huancavelica	6,000
Ayacucho	18,190	226,850	Ayacucho	15,000
Apurimac	8,189	133,000	Abancay	2,400
Cuzco	156,317	328,980	Cuzco	23,000
Puno	41,211	403,000	Puno	4,500
<i>Montaña:—</i>				
Amazonas	13,947	53,000	Chachapoyas	4,500
Loreto	238,493	120,000	Iquitos	6,000
San Martin	30,745	33,000	Moyobamba	7,500
<i>Litoral</i>				
<i>Provinces:—</i>				
Tumbes	1,981	8,000	Tumbes	2,300
Callao	14	33,879	Callao (1905)	31,128
Moquegua	5,550	31,920	Moquegua	5,000

Apart from the departmental capitals there are few towns of size and importance. The so-called coast towns are commonly at some distance from the seashore, and their shipping ports are little more than a straggling collection of wretched habitations in the vicinity of the landing-stage and its offices and warehouses. Callao (*q.v.*) is a noteworthy exception, and Paita and Pisco are something more than the average coast village. Near Lima, on the south, there are three bathing resorts, Chorrillos, Miraflores and Barranco, which have handsome residences and large populations in the bathing season. North of Lima is the port and bathing resort of Ancon, in an extremely arid locality but having a fine beach, a healthy climate and a considerable population in the season. The towns of the coast region are usually built on the same general plan, the streets crossing each other at right angles and enclosing squares, or *quadras*. In the sierra there is the same regular plan wherever the site is level enough. High-pitched red tiled roofs take the place of the flat roofs of the coast. The upper storey often recedes, leaving wide corridors under the overhanging eaves, and in the "plazas" there are frequently covered arcades. In addition to the capitals of the departments, Tarma (about 4000) and Xauxa, or Jauja (about 3000), are important towns of this region. In the *montaña* there are no towns of importance other than the capitals of the departments and the small river ports.

Communications.—The problem of easy and cheap transportation between the coast and the interior has been a vital one for Peru, for upon it depends the economic development of some of the richest parts of the republic. The arid character of the coastal zone with an average width of about 80 m., permits cultivation of the soil only where water for irrigation is available. Only in the sierra and *montaña* regions is it possible to maintain a large population and develop the industries upon which their success as a nation depends. During colonial times and down to the middle of the 19th century pack animals were the only means of transportation across the desert and over the rough mountain trails. Railway construction in Peru began in 1843 with a short line from Callao to Lima, but the building of railway lines across the desert to the inland towns of the fertile river valleys and the Andean foot-hills did not begin until twenty years later. These roads added much to the productive resources of the country, but their extension to the sierra districts was still a vital necessity. Under the administration (1868-1872) of President José Balta the construction of two transandean and several coastal zone railways was begun, but their completion became impossible for want of funds. Balta's plans covered 1281 m. of state railways and 749 m. of private lines, the estimated cost to be about £37,500,000—a sum far beyond the resources of the republic. The two transandean lines were the famous Oroya railway, running from Callao to Oroya (1893), which crosses the Western Cordillera at an elevation of 15,645 ft.,

and later on to Cerro de Pasco (1904), the Gollarisquiga coal mines (1904) and Hauri (1906); and the southern line from Mollendo to Lake Titicaca, which reached Arequipa in 1866, Puno in 1872 and Checcapuca (Cuzco branch) in 1906. Surveys were completed in 1909 for an extension of the Oroya line from a point on its Cerro de Pasco branch eastward to the Ucayali, and another transandean line frequently discussed is projected from Paita across the Andes to Puerto Limon, on the Marañon—a distance of 410 m.

The most important means of communication in the republic is that of its river system, comprising, as it does, the navigable channels of the Marañon, or upper Amazon, and its tributaries. It is officially estimated that this system comprises no less than 20,000 m. of connected riverways navigable at high water for all descriptions of boats, or 10,000 m. for steamers of 20 to 25 ft. draught, which is reduced to 5800 m. at low water. The rivers forming this system are the Marañon from Puerto Limon to Tabatinga on the Brazilian frontier (484 m.), the Japurá, Putumayo, Javary, Napo, Tigre, Huallaga, Ucayali, Pachitea, Jurujá, Purús, Acra, Curaray and Aguariaco all navigable over parts of their courses for steamers of 4 to 8 ft. draught in periods of high water. As for the Marañon, it is claimed that steamers of 20 ft. draught can ascend to Puerto Limon at all seasons of the year. The inclusion of the upper waters of the Brazilian rivers Jurujá, Purús and Acra is *pro forma* only, as they are wholly under Brazilian jurisdiction. Practically the whole of the region through which these rivers run—the *montaña* of Peru—is undeveloped, and is inhabited by Indians, with a few settlements of whites on the river courses. Its chief port is Iquitos, on the Marañon, 335 m. above the Brazilian frontier and 2653 m. from the mouth of the Amazon. It is visited by ocean-going steamers, and is the centre of the Peruvian river transportation system. The second port in importance is Yauyaguano, on the Huallaga, 143 m. from the mouth of that river and 528 m. from Iquitos, with which it is in regular communication. There are small ports, or trading posts, on all the large rivers, and occasional steamers are sent to them with supplies and to bring away rubber and other forest products. Of the rivers farther south, which discharge into the Amazon through the Madeira, the Madre de Dios alone offers an extended navigable channel, together with some of its larger tributaries, such as the Heath and Chandless. Of a widely different character is the navigation of Lake Titicaca, where steamers ply regularly between Puno and Guaqui, the latter on the south-east shore in railway connection with La Paz, the capital of Bolivia. This is one of the most remarkable steamer routes in the world, being 12,370 ft. above sea-level. The lake is 165 m. long and from 70 to 80 m. wide and has a number of small Indian villages on its shores.

There are two submarine cable lines on the Peruvian coast—the (American) Central and South American Co. extending from Panama to Valparaiso, and the (British) West Coast Cable Co. subsidiary to the Eastern Telegraph Co., with a cable between Callao and Valparaiso. The inland telegraph service dates from 1864, when a short line from Callao to Lima was constructed, and state ownership from 1875, when the government assumed control of all lines within the republic, some of which were subsequently handed over to private administration. They connect all the important cities, towns and ports, but cover only a small part of the republic. The cost of erecting and maintaining telegraph lines in the sierra and *montaña* regions is too great to permit their extensive use, and the government is seeking to substitute wireless telegraphy. From Puerto Bermudez, on the Pachitea or Pichis river, the terminus of a government road and telegraph line, a wireless system connects with Massisea on the Ucayali, and thence with Iquitos, on the Marañon—a distance of 930 m. by steamer, which is much shortened by direct communication between the three radiographic stations. This service was opened to Iquitos on the 8th of July 1908, the first section between Puerto Bermudez and Massisea having been pronounced a success. The Peruvian telegraph system connects with those of Ecuador and Bolivia. The use of the telephone is general, 5256 m. being in operation in 1906. The postal service is unavoidably limited and defective, owing to the rugged character of the country, its sparse population, and the large percentage of illiterates. On the coast, however, in and near the large cities and towns, it compares well with other South American countries. Peru belongs to the international postal union, and had in 1906 a money order and parcels exchange with seven foreign states. A noteworthy peculiarity in the foreign mail service is that an extra charge of 2 cents for each letter and 1 cent for each post-card is collected when they are sent across the isthmus of Panama. No charge is made for the transmission of newspapers within the republic. The letter rate is 5 cents silver for 15 grams, or 10 cents to foreign countries in the postal union.

Commerce.—Owing to political disorder, difficulty in land communications, and the inheritance of vicious fiscal methods from Spanish colonial administration, the commercial development of Peru has been slow and erratic. There are many ports on the coast, but only eight of them are rated as first class, viz. Paita, Eten, Pacasmayo, Salaverry, Callao, Pisco, Mollendo and Ilo, five of which are ports of call for foreign coasting steamers. The inland port of Iquitos, on the Marañon, is also rated as first class, and enjoys special privileges because of its distance from the national

capital. The second-class ports are Tumbes, Talara, Pisco, Chicla, Chimbote, Samanco, Casma, Huacho, Cerro-Azu, Tambo de Mora, Lomas and Chala, on the coast, Puno on Lake Titicaca, and Leticia on the Amazon near the western mouth of the Javary. Callao (see) is the chief port of the republic and monopolizes the greater part of its foreign trade. Its harbour, one of the best on the west coast of South America, has been greatly improved by the port works begun under the administration of President Bata. Paita and Chimbote have good natural harbours, but the others, for the most part, are open roadsteads or unsheltered bays. Mollendo is a shipping port for Bolivian exports sent over the railway from Puno. There were 12 foreign steamship lines trading at Peruvian ports in 1908, some of them making regular trips up and down the coast at frequent intervals and carrying much of its coastwise traffic. Foreign sailing vessels since 1886 have not been permitted to engage in this traffic, but permission is given to steamships on application and under certain conditions. The imports were valued in 1907 at \$5,147,870 soles (10 soles = £1 stg.) and the exports at \$7,477,320 soles—the former showing a considerable increase and the latter a small decrease in comparison with 1906. The exports consist of cotton, sugar, cocaine, hides and skins, rubber and other forest products, wool, guano and mineral products. The most important export is sugar, the products of the mines ranking second. The largest share in Peru's foreign trade is taken by Great Britain, Chile ranking second and the United States third.

Products.—Although her mining industries have been the longest and most widely known, the principal source of Peru's wealth is agriculture. This seems incompatible with the arid character of the country and the peculiar conditions of its civilization, but irrigation has been successfully employed in the fertile valleys of the coast.

Agriculture.—Sugar-cane is cultivated in most of the coast valleys, and with exceptional success in those of the Canete, Rimac, Chancay, Huaura, Supe, Santa, Chicama, Pacasmayo and Chiclayo. Some of the large estates are owned and worked by British subjects. The industry was nearly ruined by the Chileans in 1880, but its recovery soon followed the termination of the war and the output has been steadily increasing. At the outbreak of the war the production was about 80,000 tons; in 1905 the production of sugar and molasses amounted to 161,851 metric tons, of which 134,348 were exported. In 1906 the total production reached 160,418 metric tons. Next in importance is cotton, which is grown along the greater part of the Peruvian coast, but chiefly in the departments of Piura, Lima and Ica. Four kinds are produced: rough cotton or "vegetable wool" sea island, brown or Mitafis, and smooth or American. Production is steadily increasing, the export having been 8000 metric tons in 1900, 17,386 in 1905 and 20,000 in 1906. Local consumption required about 2500 tons in 1905. Rice is an important crop in the inundated lands of Lambayeque and Libertad. It is a universal article of food in Peru, and the output is consumed in the country. Maize is another important food product which is generally cultivated along the coast and in the lower valleys of the sierra. In some places two or three crops a year are obtained. It is the staple food everywhere, and little is exported. It is largely used in the manufacture of *chicha*, a fermented drink popular among the lower classes. Tobacco is grown in the department of Piura, and in the *montaña* departments of Loreto, Amazonas and Cajamarca. The local consumption is large and the export small. Another *montaña* product is coffee, whose successful development is prevented by difficult transport. A superior quality of bean is produced in the eastern valleys of the Andes, especially in the Chanchamayo valley. Cacao is another *montaña* product, although like coffee it is cultivated in the warm valleys of the sierra, but the export is small. With cheap transport to the coast the production of coffee and cacao must largely increase. Coca (*Erythroxylon coca*) is a peculiar product to the eastern Andean slopes of Bolivia and Peru, where it has long been cultivated for its leaves. These are sun-dried, packed in bales, and distributed throughout the *sierra* region, where coca is used by the natives as a stimulant. The Cholos are never without it, and with it are able to perform incredible tasks with little food. The common manner of using it is to masticate the dried leaves with a little lime. Cocaine is also derived from coca leaves, and a considerable quantity of the drug is exported. The coca shrub is most successfully cultivated at an elevation of 5000 to 6000 ft. Fruits in great variety are grown everywhere in Peru, but beyond local market demands their commercial production is limited to grapes and olives. Grapes are produced in many of the irrigated valleys of the coast, such as Chincha, Lunahuana, Ica, Vitor, Majes, Andaray, Moquegua and Locumba, and the fruit is manufactured into wines and brandies. Excellent clarets and white wines are produced, and the industry is steadily increasing. Olives were introduced early in colonial times and are cultivated in several coast valleys, especially in the provinces of Cananá (Arequipa) and Moquegua. The fruit is commonly used for the manufacture of oil, which is consumed in the country, and only a small part is exported. Were large markets available, other fruits such as oranges, lemons, limes and bananas would undoubtedly be extensively cultivated. In the *sierra* region, wheat, barley, oats, quinoa (*Chenopodium quinoa*),

alfalfa, Indian corn, *oca* (*Oxalis tuberosa*) and potatoes are the principal products. Wheat is widely grown but the output is not large. Barley and oats are grown for forage, but for this purpose alfalfa has become the staple, and without it the mountain pack-trains could not be maintained. Quinoa is an indigenous plant, growing at elevations of 13,500 ft. and more; its grain is an important food among the upland natives. Potatoes are grown everywhere in the sierras, and with quinoa are the only crops that can be raised for human food above 13,000 ft. *Yuca* (*Manihot edulis*), known as *cassava* in the West Indies and *mandiocas* in Brazil, is also widely cultivated for food and for the manufacture of starch.

There are good pastures in the sierras, and cattle have been successfully reared in some of the departments since the early years of Spanish occupation, chiefly in Ancachs, Cajamarca, Junin, Ayacucho, Puno, and some parts of Cuzco. The development of alfalfa cultivation is extending the area of cattle-breeding somewhat and is improving the quality of the beef *livestock* produced. The cattle are commonly small and hardy, and, like the Mexican cattle, are able to bear unfavourable conditions. Sheep are reared over a somewhat wider range, exclusively for their wool. The "natives," or descendants of the early importations, are small, long-legged animals whose wool is scanty and poor. Since the end of the 19th century efforts have been made to improve the stock through the importation of merinos, with good results. Sheep ranges under the care of Scottish shepherds have also been established in the department of Junin, the stock being imported from southern Patagonia, England and Australia. Goats are raised in Piura and Lambayeque for their skins and fat, and swine-breeding for the production of lard has become important in some of the coast valleys immediately north of Lima. Horses are reared only to a limited extent, although there is a demand for them for military purposes. The government is seeking to promote the industry through the importation of breeding mares from Argentina. Mules are bred in Piura and Apurimac, and are highly esteemed for mountain travel. The chief breeding industry is that of the llama, alpaca and vicuña—animals of the *Acridina* family domesticated by the Indians and bred, the first as a pack animal, and the other two for their wool, hides and meat. The llama was the only breed of burden known to the South American natives before the arrival of the Spaniards and is highly serviceable on the difficult trails of the Andes. The alpaca and vicuña are smaller and weaker and have never been used for this service, but their fine, glossy fleeces were used by the Indians in the manufacture of clothing and are still an important commercial asset of the elevated table-lands of Peru and Bolivia. The export of wool in 1905 exceeded 3,300,000 lb. The rearing of these animals requires much patience and skill, in which no one has been able to match the Indian breeders of the Andean plateaus.

The natural products of Peru include rubber, cabinet woods in great variety, cinchona or Peruvian bark and other medicinal products, various fibres, and guano. There are two *Forest* kinds of rubber supplied by the Peruvian *montaña* **Products**. *forests: jebe* (also written *hebe*) or *seringa*, and *caucho*—the former being collected from the *Hecce guayanaensis*, or *H. brasiliensis*, and the latter from the *Castilloa elastica* and some other varieties. The *Hecce* product is obtained annually by tapping the trees and coagulating the sap over a smoky fire, but the *caucho* is procured by felling the tree and collecting the sap in a hollow in the ground where it is coagulated by stirring in a mixture of soap and the juice of a plant called *willita*. As the species from which Ceará rubber is obtained (*Hancornia speciosa*) is found in Bolivia, it is probable that this is also a source of the Peruvian *caucho*. The *Hecce* is found along the water-courses of the lowlands, which includes the large tributaries of the Marañon, while the *caucho* species flourish on higher ground, above 900 ft. elevation. Owing to the export tax on rubber (8 cents per kilogram on *jebe* and 5 cents on *caucho*) it is probable that the official statistics do not cover the total production, which was returned as 2539 metric tons in 1905, valued at \$913,989. The export of cinchona, or Peruvian bark, is not important in itself, being only 64 tons, valued at \$1406 in 1905. The best bark comes from the Carabaya district in south-eastern Peru, but it is found in many localities on the eastern slopes of the Andes. The Peruvian supply is practically exhausted through the destructive methods employed in collecting the bark, and the world now depends chiefly on Bolivia and Ecuador. The forests of eastern Peru are rich in fine cabinet woods, but their inaccessibility renders them of no great value. Among the best known of them are cedar, walnut, ironwood and caoba, a kind of mahogany. Many of the forest trees of the upper Amazon valley of Brazil are likewise found in Peru. The palm family is numerous and includes the species producing vegetable ivory (*Phytelephas*), straw for plaiting: Panama hats (*Carludovica palmata*), and the peach palm (*Guilfordia speciosa*).

From guano an immense revenue was derived during the third quarter of the 19th century and it is still one of the largest exports. The guano beds are found on the barren islands of the **Guano** Pacific coast. They were developed commercially during the administration (1845-1851) of President Ramon Castilla, at the same time that the nitrate deposits of Tarapacá became a

commercial asset of the republic. The large revenues derived from these sources undoubtedly became a cause of weakness and demoralization and eventually resulted in bankruptcy and the loss of Tarapacá. The deposits have been partially exhausted by the large shipments of over a half-century, but the export in 1905 was 73,369 tons, valued at £285,729.

Mining.—Mining was the chief industry of Peru under Spanish rule. The Inca tribes were an agricultural and pastoral people, but the abundance of gold and silver in their possession at the time of the conquest shows that mining must have received considerable attention. They used these precious metals in decorations and as ornaments, but apparently attached no great value to them. The use of bronze also shows that they must have worked, perhaps superficially, some of the great copper deposits. Immediately following the Spanish invasion the Andean region was thoroughly explored, and with the assistance of Indian slaves thousands of mines were opened, many of them failures, some of them becoming famous. There was a decline in mining enterprise after the revolt of the colonists against Spanish rule, owing to the unsettled state of the country, and this decline continued in some measure to the end of the century. The mining laws of the colonial régime and political disorder together raised a barrier to the employment of the large amount of capital needed, while the frequent outbreaks of civil war made it impossible to work any large enterprise because of its interference with labour and the free use of ports and roads. The Peruvians were impoverished, and under such conditions foreign capital could not be secured. In 1876 new mining laws were enacted which gave better titles to mining properties and better regulations for their operation, but the outbreak of the war with Chile at the end of the decade and the succeeding years of disorganization and partisan strife defeated their purpose. Another new mining code was adopted in 1901, and this, with an improvement in political and economic conditions, has led to a renewal of mining enterprise.

Practically the whole Andean region of Peru is mineral-bearing—a region 1500 m. long by 200 to 300 m. wide. Within these limits are to be found most of the minerals known—gold, silver, quicksilver, copper, lead, zinc, iron, manganese, wolfram, bismuth, thorium, vanadium, mica, coal, &c. On or near the coast are coal, salt, sulphur, borax, nitrates and petroleum. Gold is found in lodes and alluvial deposit; the former on the Pacific slope at Salpo, Oruzco, Huaylas, Yungay, Ocos, Chorrillos, Cañete, Ica, Nasca, Andaray and Arequipa, and on the table-lands and Amazon slope at Pataz, Huáuco, Chuquitambo, Huancavelica, Cuzco, Cotabambas, Aymares, Paucartambo, Santo Domingo and Sandia; the latter wholly on the Amazon slope, in the country about the Pongo de Manseriche and at Chuquibambas, both on the upper Marañón, in the districts of Pataz, Huáuco, Aymares and Antabamba (Aurimac), Paucartambo and Quippicacchi (Cuzco), and Sandia and Carabaya (Puno). The last two are most important and, it is believed, were the sources from which the Incas derived the greater part of their store. The alluvial deposits are found both in the beds of the small streams and in the soil of the small plains or *pampas*. The Aporoma deposit, in the district of Sandia, is the best known. Long ditches with stone-paved sluices for washing this mineral-bearing material have long been used by the Indians, who also construct stone bars across the beds of the streams to make riffles and hold the deposited grains of gold. Modern methods of hydraulic mining have been introduced to work the auriferous banks of Poto; elsewhere antiquated methods only are employed. The upper valley of the Marañón has undeveloped gold-bearing lodes. The number of mines worked is small and there is not much foreign capital invested in them. The gold ores of Peru are usually found in ferruginous quartz. The production in 1906 was valued at £170,355.

Peru has been known chiefly for its silver mines, some of which have been marvellously productive. The Cerro de Pasco district, with its 342 mines, is credited with a production, in value, of £40,000,000 between 1784 and 1889, and is still productive; the output for 1906 being valued at £972,958. The principal silver-producing districts, the greater part on the high table-lands and slopes of the Andes, are those of Salpo, Hualgayoc, Huari, Hualanca, Huaylas, Huaraz, Recuay, Cajatambo, Yauli, Cerro de Pasco, Morococha, Huarochiri, Huancavelica, Quesispisaca, Castrovirreyna, Lucanas, Lampa, Caylloma and Puno, but there are hundreds of others outside their limits. Silver is generally found as red oxides (locally called *rosicler*), sulphides and argentiferous galena. Modern machinery is little used and many mines are practically unworkable for want of pumps. In the vicinity of some of the deposits of argentiferous galena are large coal beds, but timber is scarce on the table-lands. The dried dung of the llama (*taquia*) is generally used as fuel, as in pre-Spanish times, for roasting ores, as also a species of grass called *sku* (*Stipa sncana*), and a singular woody fungus, called *yareta* (*Azorella umbellifera*), found growing on the rocks at elevations exceeding 12,000 ft. The methods formerly employed in reducing ores were lixiviation and amalgamation with quicksilver, but modern methods are gradually coming into use. Quicksilver is found at Huancavelica, Chonta (Ancachs), and in the department of Puno. The mine first named has been worked since 1566 and its total production is estimated at 60,000

tons, the annual product being about 670 tons for a long period. The metal generally occurs as sulphide of mercury (cinabar), but the ores vary greatly in richness—from 2½ to 20%. The annual production has fallen to a small fraction of the former output, its value in 1905 being only £340, and in 1906 £495.

The copper deposits of Peru long remained undeveloped through want of cheap transport and failure to appreciate their true value. The principal copper-bearing districts are Chimbote, Cajamarca, Huancayo, Huaraz, Hualanca, Junin, Huancavelica, Ica, Arequipa, Andahuaylas and Cuzco—chiefly situated in the high, bleak regions of the Andes. The Junin district is the best known and includes the Cerro de Pasco, Yauli, Morococha and Hualay groups of mines, all finding an outlet to the coast over the Oroya railway. These mines are of recent development, the Cerro de Pasco mines having been purchased by American capitalists. A smelting plant was erected in the vicinity of Cerro de Pasco designed to treat 1000 tons of ore daily, a railway was built to Oroya to connect with the state line terminating at that point, and a branch line 62 m. long was built to the coal-mines of Goillarisquega. The Cerro de Pasco mines are supposed by some authorities to be the largest copper deposit in the world. In addition to the smelting works at Cerro de Pasco there are other large works at Casapalca, between Oroya and Lima, which belong to a British company, and smaller plants at Hualanca and Huinac. The production of copper is steadily increasing, the returns for 1903 being 9497 tons and for 1906 13,474 tons, valued respectively at £476,824 and £996,055. Of other metals, lead is widely distributed, its chief source being a high grade galena accompanied by silver. Iron ores are found in Piura, the Huaylas valley, Ayacucho and some other places, but the deposits have not been worked through lack of fuel. Sulphur deposits exist in the Sechura desert region, on the coast, and extensive borax deposits have been developed in the department of Arequipa. Coal has been found in extensive beds near Piura, Salaverry, Chimbote, Huarmey and Pisco on the coast, and at Goillarisquega, Huarochiri and other places in the interior. Both anthracite and bituminous deposits have been found. Most of the deposits are isolated and have not been developed for want of transport. Petroleum has been found at several points on the coast in the department of Piura, and near Lake Titicaca in the department of Puno. The most productive of the Piura wells are at Talara and Zorritos, where refineries have been established. The crude oil is used on some of the Peruvian railways.

The number of mining claims (*pertenencias*) registered in 1907 was 12,858, according to official returns, each subject to a tax of 30 soles, or £3, per annum, the payment of which secures complete ownership of the property. The claims measure 100 X 200 metres (about 5 acres) in the case of mineral veins or lodes, and 200 X 200 metres (about 10 acres) for coal, alluvial gold and other deposits. The labourers are commonly obtained from the Cholos, or Indian inhabitants of the sierras, who are accustomed to high altitudes, and are generally efficient and trustworthy.

Manufactures.—The manufacturing industries of Peru are confined chiefly to the treatment of agricultural and mineral products—the manufacture of sugar and rum from sugar cane, textiles from cotton and wool, wine and spirits from grapes, cigars and cigarettes from tobacco, chocolate from cacao, kerosene and benzine from crude petroleum, cocaine from coca, and refined metals from their ores. Many of the manufacturing industries are carried on with difficulty and maintained only by protective duties on competing goods. The Incas had made much progress in weaving, and specimens of their fabrics, both plain and coloured, are to be found in many museums. The Spanish introduced their own methods, and their primitive looms are still to be found among the Indians of the interior who weave the coarse material from which their own garments are made. Modern looms for the manufacture of woollens were introduced in 1861, and of cotton goods in 1874. There are large woollen factories at Cuzco and Lima, the Santa Catalina factory at the latter place turning out cloth and cashmere for the army, blankets, counterpanes and underclothing. There are cotton factories about Lima, at Ica and at Arequipa. Besides the wine industry, an irregular though important industry is the manufacture of artificial or counterfeit spirits and liqueurs in Callao and Lima. There are breweries in Arequipa, Callao, Cuzco and Lima, and the consumption of beer is increasing. There are large cigarette factories in Lima, and others in Arequipa, Callao, Piura and Trujillo. The plaiting of Panama hats from the specially prepared fibre of the "toquilla" palm is a domestic industry among the Indians at Catacoas (Piura) and Eten (Lambayeque). Coarser straw hats are made at other places, as well as hammocks, baskets, &c.

Government.—Peru is a centralized republic, whose supreme law is the constitution of 1860. Like the other states of South America its constitution provides for popular control of legislation and the execution of the laws through free elections and comparatively short terms of office, but in practice these safeguards are often set aside and dictatorial methods supersede all others. Nominally the people are free and exercise

sovereign rights in the choice of their representatives, but the ignorance of the masses, their apathy, poverty and dependence upon the great land proprietors and industrial corporations practically defeat these fundamental constitutional provisions. Citizenship is accorded to all Peruvians over the age of 21 and to all married men under that age, and the right of suffrage to all citizens who can read and write, or possess real estate or workshops, or pay taxes. In all cases the exercise of citizenship is regulated by law.

The government is divided into three independent branches, legislative, executive and judicial, of which through force of circumstances the executive has become the dominating power. The executive branch consists of a president and two vice-presidents elected for terms of four years, a cabinet of six ministers of state appointed by the president, and various subordinate officials who are under the direct orders of the president. The president is chosen by a direct popular election and cannot be re-elected to succeed himself. He must be not less than 35 years of age, a Peruvian by birth, in the enjoyment of all his civil rights, and domiciled in the republic ten years preceding the election. The immediate supervision and despatch of public administrative affairs is in the hands of the cabinet ministers—interior, foreign affairs, war and marine, finance and commerce, justice and public instruction, and public works and promotion (*omento*). The execution of the laws in the departments and provinces, as well as the maintenance of public order, is entrusted to prefects and sub-prefects, who are appointees of the president. A vacancy in the office of president is filled by one of the two vice-presidents elected at the same time and under the same conditions. Inability of the first vice-president to assume the office opens the way for the second vice-president, who becomes acting president until a successor is chosen. The vice-presidents cannot be candidates for the presidency during their occupancy of the supreme executive office, nor can the ministers of state, nor the general-in-chief of the army, while in the exercise of their official duties.

The legislative power is exercised by a national Congress—senate and chamber of deputies—meeting annually on the 28th of July in ordinary session for a period of 90 days. Senators and deputies are inviolable in the exercise of their duties, and cannot be arrested or imprisoned during a session of Congress, including the month preceding and following the session, except in *flagrant delicto*. Members of Congress are forbidden to accept any employment or benefit from the executive. Senators and deputies are elected by direct vote—the former by departments, and the latter in proportion to the population. With both are elected an equal number of substitutes, who assume office in case of vacancy.

Departments with eight and more provinces are entitled to four senators, those of four to seven provinces three senators, those of two to three provinces two senators, and those of one province one senator. The deputies are chosen to represent 15,000 to 30,000 population each, but every province must have at least one deputy. Both senators and deputies are elected for terms of six years, and both must be native-born Peruvian citizens in the full enjoyment of their civil rights. A senator must be 35 years of age, and have a yearly income of \$1000. The age limit of a deputy is 25 years, and his income must be not less than \$300. In both chambers the exercise of some scientific profession is accepted in lieu of the pecuniary income. No member of the executive branch of the government (president, cabinet minister, prefect, sub-prefect, or governor) can be elected to either chamber, nor can any judge or "fiscal" of the supreme court, nor any member of the ecclesiastical hierarchy from his diocese, province or parish, nor any judge or "fiscal" of superior and first-instance courts from their judicial districts, nor any military officer from the district where he holds a military appointment at the time of election. No country is provided with more and better safeguards against electoral and official abuses than is Peru, and yet few countries suffered more from political disorder during the 19th century. The president has no veto power, but has the right to return a law to Congress with comments within a period of ten days. Should the act be again passed without amendments it becomes law; if, however, the suggested amendments are accepted the act must go over to the next session. Congress may also sit as a court of impeachment—the senate hearing and deciding the case, and the chamber acting as prosecutor. The president, ministers of state and judges of the supreme court may be brought before this court.

Justice.—The judiciary is composed of a supreme court, superior courts and courts of first instance, and justices of the peace. The supreme court is established at the national capital and consists of 11 judges and 2 "fiscales" or prosecutors. The judges are selected by Congress from lists of nominees submitted by the executive. The judges of the superior courts are chosen by the president from the list of nominees submitted by the supreme court. Questions of jurisdiction between the superior and supreme courts, as well as questions of like character between the supreme court and the executive, are decided by the senate sitting as a court. The courts of first instance are established in the capitals of provinces and their judges are chosen by the superior courts of the districts in which they are located. The independence of the Peruvian courts has not been scrupulously maintained, and there has been much criticism of their character and decisions.

The national executive appoints and removes the prefects of the departments and the sub-prefects of the provinces, and the prefects appoint the *gobernadores* of the districts. The police officials throughout the republic are also appointees of the president and are under his orders.

Army.—After the Chilean War the disorder fomented by the rival military officers led to a desire to place the administration of public affairs under civilian control. This led to a material reduction in the army, which, as reorganized, consists of 4000 officers and men, divided into seven battalions of infantry of 300 men each, seven squadrons of cavalry of 125 men each, and one regiment of mountain artillery of 500 men, with six batteries of mountain guns. The reorganization of the army was carried out by 10 officers and 4 non-coms. of the French army, known as the French military mission, who are also charged with the direction of the military school at Chorrillos and all branches of military instruction. There are a military high school, preparatory school, and "school of application" in connexion with the training of young officers for the army. The head of the mission is chief of staff. Formerly the Indians were forcibly pressed into the service and the whites filled the positions of officers, in great part untrained. Now military service is obligatory for all Peruvians between the ages of 19 and 50, who are divided into four classes, first and second reserves (19 to 30, and 30 to 35 years), supernumeraries (those who have purchased exemption from service in the regular army), and the national guard (35 to 50 years). The regular force is maintained by annual drawings from the lists of young men 19 years of age in the first reserves, who are required to serve four years. The direction of military affairs is entrusted to a general staff, which was reorganized in 1904 on the lines adopted by the great military powers of Europe. The republic is divided into four military districts with headquarters at Piura, Lima, Arequipa and Iquitos, and these into eleven circumscriptions. The mounted police force of the republic is also organized on a military basis.

Navy.—The Peruvian navy was practically annihilated in the war with Chile, and the poverty of the country prevented for many years the adoption of any measure for its rebuilding. In 1908 it consisted of only five vessels. The naval school at Callao is under the direction of an officer of the French navy. In addition to the foregoing the government has a few small river boats on the Marañon and its tributaries, which are commanded by naval officers and used to maintain the authority of the republic and carry on geographical and hydrographical work.

Finance.—The financial record of Peru, notwithstanding her enormous natural resources, has been one of disaster and discredit. Internal strife at first prevented the development of her resources, and then when the export of guano and nitrates supplied her treasury with an abundance of funds the money was squandered on extravagant enterprises and in corrupt practices. This was followed by the loss of these resources, bankruptcy, and eventually the surrender of her principal assets to her foreign creditors. The government then had to readjust expenditures to largely diminished resources; but the obligation has been met intelligently and courageously, and since 1895 there has been an improvement in the financial state of the country. The public revenues are derived from customs, taxes, various inland and consumption taxes, state monopolies, the government wharves, posts and telegraphs, &c. The customs taxes include import and export duties, surcharges, harbour dues, warehouse charges, &c.; the inland taxes comprise consumption taxes on alcohol, tobacco, sugar and matches, stamps and stamped paper, capital and mining properties, licences, transfers of property, &c.; and the state monopolies cover opium and salt. In 1905 a loan of £600,000 was floated in Germany for additions to the navy. The growth of receipts and expenditures is shown in the following table:—

	1904.	1906.	1908.
Revenue	£1,990,508	£2,527,766	£2,997,433
Expenditure	£1,884,949	£2,178,252	£3,043,032

The revenues of 1896 were only £1,128,714. The foreign debt began with a small loan of £1,200,000 in London in 1822, and another of £1,500,000 in 1825 of which only £716,516 was placed. At the end of the war, these loans, and sums owing to Chile and Colombia, raised the foreign debt to £4,000,000. In

1830 the debt and accumulated interest owing in London amounted to £2,310,767, in addition to which there was a home debt of 17,183,397 dollars. In 1848 the two London loans and accumulated interest were covered by a new loan of £3,736,400, and the home debt was partially liquidated, the sale of guano giving the treasury ample resources. Lavish expenditure followed and the government was soon anticipating its revenues by obtaining advances from guano consignees, usually on unfavourable terms, and then floating loans. There was another conversion loan in 1862 in the sum of £5,500,000 and in 1864 still another loan of this character was issued, nominally for £10,000,000, of which £7,000,000 only were issued. Then followed the ambitious schemes of President Balta, which with the loans of 1870 and 1873 raised the total foreign debt to £49,000,000, on which the annual interest charge was about £2,500,000, a sum wholly beyond the resources of the treasury. In 1876 interest payments on account of this debt were suspended and in 1879-1882 the war with Chile deprived Peru of her principal sources of income—the guano deposits and the Tarapacá nitrates. In 1889 the total foreign debt, including arrears of interest, was £54,000,000, and in the following year a contract was signed with the Peruvian Corporation, a company in which the bondholders became shareholders, for the transfer to it for 66 years of the state railways, the free use of certain ports, the right of navigation on Lake Titicaca, the exploitation of the remaining guano deposits up to 3,000,000 tons, and thirty-three annual subsidies of £80,000 each, in consideration of the cancellation of the debt. Some modifications were later made in the contract, owing to the government's failure to meet the annual subsidies and the corporation's failure to extend the railways agreed upon. This contract relieved Peru of its crushing burden of foreign indebtedness, and turned an apparently heavy loss to the bondholders into a possible profit. In 1910 the foreign debt stood at £3,140,000, composed of (1) Peruvian Corporation £2,160,000; (2) wharves and docks, £80,000; (3) loan of 1905, £500,000; (4) loan of 1906, £400,000.

Currency.—The single gold standard has been in force in Peru since 1897 and 1898 silver and copper being used for subsidiary coinage. The monetary unit is the Peruvian pound (*libra*) which is uniform in weight and fineness with the British pound sterling. Half and fifth pounds are also coined. The silver coinage consists of the *sol* (100 cents), half *sol* (50 cents), and pieces of 20 (*peseta*), 10 and 5 cents; and the copper coinage of 1 and 2 cents. The single standard has worked well, and has contributed much toward the recovery of Peruvian commerce and finance. The change from the double standard was effected without any noticeable disturbance in commercial affairs, but this was in part due to the precaution of making the British pound sterling legal tender in the republic and establishing the legal equivalent between gold and silver at 10 *soles* to the pound. The coinage in 1906-1907 was about £150,000 gold and £65,000 silver, and the total circulation in that year was estimated at £1,400,000 in gold coin and £600,000 in silver coin. Previous to the adoption of the single gold standard in 1897 the monetary history of Peru had been unfortunate. The first national coinage was begun in 1822, and the decimal system was adopted in 1863. Although the double standard was in force, gold was practically demonetized by the monetary reform of 1873 because of the failure to fix a legal ratio between the two metals. Experience with paper currency has been even more disastrous. During the administration (1872-1876) of President Pardo the government borrowed heavily from the banks to avoid the suspension of work on the railways and port improvements. These banks enjoyed the privilege of issuing currency notes to the amount of three times the cash in hand without regard to their commercial liabilities. A large increase in imports, caused by fictitious prosperity and inability to obtain drafts against guano shipments, led to the exportation of coin to meet commercial obligations, and this soon reduced the currency circulation to a paper basis. The government being unable to repay its loans from the banks compelled the latter to suspend the conversion of their notes, which began to depreciate in value. In 1875 the banks were granted a *moratorium*, to enable them to obtain coin, but without result. The government in 1877 contracted a new loan with the banks and assumed responsibility for their outstanding emissions, which are said to have aggregated about 100,000,000 *soles*, and were worth barely 10% of their nominal value. At last their depreciation reached a point where their acceptance was generally refused and silver was imported for commercial needs, when the government suspended their legal tender quality and allowed them to disappear.

Weights and Measures.—The French metric system is the official standard of weights and measures and is in use in the custom-houses of the republic and in foreign trade, but the old units are still commonly used among the people. These are the ounce, 1.104 oz. avoirdupois; the *libra*, 1.014 lb avoirdupois; the *grainal*, 101.44 lb avoirdupois; the *arroba*, 25.36 lb avoirdupois; ditto of wine, 6.70 imperial gallons; the gallon, .74 of an imperial gallon; the *vara*, .927 yard; and the square *vara*, .859 square yard. (A. J. L.)

History.—Cyclopean ruins of vast edifices, apparently never completed, exist at Tiahuanaco near the southern shore of Lake Titicaca. Remains of a similar character are found at Huaraz

in the north of Peru, and at Cuzco, Ollantaytambo and Huilafac between Huaraz and Tiahuanaco. These works appear to have been erected by powerful sovereigns with unlimited command of labour, possibly with the object of giving employment to subjugated people, while feeding the vanity or pleasing the taste of the conqueror. Of their origin nothing is historically known. It is probable, however, that the settlement of the Cuzco valley and district by the Incas or "people of the sun" took place some 300 years before Pizarro landed in Peru. The conquering tribe or tribes had made their way to the *sierra* from the plains, and found themselves a new land abeltered from attack amidst the lofty mountains that hem in the valley of Cuzco and the vast lake basin of Titicaca, situated 12,000 ft. above the sea level. The first historical records show us these people already possessed of a considerable civilization, and speaking two allied languages, Aymara and Quichua. The expansion of the Inca rule and the formation of the Peruvian Empire was of modern growth at the time of the Spanish conquest, and dated from the victories of Pachacutic Inca who lived about a century before Huayna Capac, the Great Inca, whose death took place in 1526, the year before Pizarro first appeared on the coast. His consolidated empire extended from the river Ancasmayu north of Quito to the river Maule in the south of Chile. The Incas had an elaborate system of state-worship, with a ritual, and frequently recurring festivals. History and tradition were preserved by the bards, and dramas were enacted before the sovereign and his court. Roads with post-houses at intervals were made over the wildest mountain-ranges and the bleakest deserts for hundreds of miles. A well-considered system of land-tenure and of colonization provided for the wants of all classes of the people. The administrative details of government were minutely and carefully organized, and accurate statistics were kept by means of the "quipus" or system of knots. The edifices displayed marvellous building skill, and their workmanship is unsurpassed. The work has nothing to show, in the way of stone-cutting and fitting, to equal the skill and accuracy displayed in the Inca structures of Cuzco. As workers in metals and as potters they displayed infinite variety of design, while as cultivators and engineers they excelled their European conquerors. (For illustrations see AMERICA, Plate V.)

The story of the conquest has been told by Prescott and Helps, who give ample references to original authorities; it will be sufficient here to enumerate the dates of the leading events. On the 10th of March 1526 the ^{Conquest by} Pizarro. Pizarro for the conquest of Peru was signed by Francisco Pizarro, Diego de Almagro and Hernando de Luque, Gaspar de Espinosa supplying the funds. In 1527 Pizarro, after enduring fearful hardships, first reached the coast of Peru at Tumbes. In the following year he went to Spain, and on the 26th of July 1529 the capitulation with the Crown for the conquest of Peru was executed. Pizarro sailed from San Lucar with his brothers in January 1530, and landed at Tumbes in 1531. The civil war between Huascar and Atahualpa, the sons of Huayna Capac, had been fought out in the meanwhile, and the victorious Atahualpa was at Cajamarca on his way from Quito to Cuzco. On the 15th of November 1532 Pizarro with his little army, made his way to Cajamarca, where he received a friendly welcome from the Inca, whom he treacherously seized and made prisoner. He had with him only 183 men. In February 1533 his colleague Almagro arrived with reinforcements. The murder of the Inca Atahualpa was perpetrated on the 29th of August 1533, and on the 15th of November Pizarro entered Cuzco. He allowed the rightful heir to the empire, Manco, the legitimate son of Huayna Capac, to be solemnly crowned on the 24th of March 1534. Almagro then undertook an expedition to Chile, and Pizarro founded the city of Lima on the 18th of January 1535. In the following year the Incas made a brave attempt to expel the invaders, and closely besieged the Spaniards in Cuzco during February and March. But Almagro, returning from Chile, raised the siege on the 18th of April 1537. Immediately afterwards a dispute arose between the brothers, Francisco, Juan and Gonzalo Pizarro and Almagro

as to the limits of their respective jurisdictions. An interview took place at Mala, on the sea-coast, on the 13th of November 1537, which led to no result, and Almagro was finally defeated in the battle of Las Salinas near Cuzco on the 26th of April 1538. His execution followed. His adherents recognized his young half-caste son, a gallant and noble youth generally known as Almagro the Lad, as his successor. Bitterly discontented, they conspired at Lima and assassinated Francisco Pizarro on the 26th of June 1541. Meanwhile Vaca de Castro had been sent out as governor of Peru by Charles V., and on hearing of the murder of Pizarro he assumed the government of the country. On the 16th of September 1542 he defeated the army of Almagro the Lad in the battle of Chupas near Guamanga, and the boy was beheaded at Cuzco.

Charles V. enacted the code known as the "New Laws" in 1542. "Encomiendas," or grants of estates on which the inhabitants were bound to pay tribute and give personal service to the grantee, were to pass to the Crown on the death of the actual holder; a fixed sum was to be assessed as tribute; and forced personal service was forbidden. Blasco Nuñez de Vela was sent out, as first viceroy of Peru, to enforce the "New Laws." Their promulgation aroused a storm among the conquerors. Gonzalo Pizarro rose in rebellion, and entered Lima on the 28th of October 1544. The viceroy fled to Quito, but was followed, defeated and killed at the battle of Anauquito on the 18th of January 1546. The "New Laws" were weakly revoked, and Pedro de la Gasca, as first president of the Audiencia (court of justice) of Peru, was sent out to restore order. He arrived in 1547, and on the 8th of April 1548 he routed the followers of Gonzalo Pizarro on the plain of Sacahuaman near Cuzco. Gonzalo was executed on the field. La Gasca made a redistribution of "encomiendas" to the loyal conquerors, which caused great discontent, and left Peru before his scheme was made public in January 1550. On the 23rd of September 1551 Don Antonio de Mendoza arrived as second viceroy, but he died at Lima in the following July. The country was then ruled by the judges of the Audiencia, and a formidable insurrection broke out, headed by Francisco Hernandez Giron, with the object of maintaining the right of the conquerors to exact forced service from the Indians. In May 1554 Giron defeated the army of the judges at Chuquiaguá, but he was hopelessly routed at Pucara on the 11th of October 1554, captured, and on the 7th of December executed at Lima. Don Andres Hurtado de Mendoza, marquis of Cañete, entered Lima as third viceroy of Peru on the 6th of July 1555, and ruled with an iron hand for six years. All the leaders in former disturbances were sent to Spain. Corregidores, or governors of districts, were ordered to try summarily and execute every turbulent person within their jurisdictions. All unemployed persons were sent on distant expeditions, and moderate "encomiendas" were granted to a few deserving officers. At the same time the viceroy wisely came to an agreement with Sayri Tupac, the son and successor of the Inca Manco, and granted him a pension. He took great care to supply the natives with priests of good conduct, and promoted measures for the establishment of schools and the foundation of towns in the different provinces. The cultivation of wheat, vines and olives, and European domestic animals were introduced. The next viceroy was the Conde de Nieva (1561-1564). His successor, the licentiate Lope Garcia de Castro, who only had the title of governor, ruled from 1564 to 1569. From this time there was a succession of viceroys until 1824. The viceroys were chief magistrates, but in legal matters they had to consult the Audiencia of judges, in finance the Tribunal de Cuentas, in other branches of administration the Juntas de Gobierno and de Guerra.

Don Francisco de Toledo, the second son of the count of Oropesa, entered Lima as viceroy on the 26th of November 1569. Fearing that the little court of the Inca Tupac Amaru (who had succeeded his brother Sayri Tupac) might become a focus of rebellion, he seized the young prince, and unjustly beheaded the last of the Incas in the square

of Cuzco in the year 1571. After a minute personal inspection of every province in Peru, he, with the experienced aid of the learned Polo de Ondegardo and the judge of Matienza, established the system under which the native population of Peru was ruled for the two succeeding centuries. His *Libro de Tasas* fixed the tribute to be paid by the Indians, exempting all men under eighteen and over fifty. He found it necessary, in order to secure efficient government, to revert in some measure to the system of the Incas. The people were to be directly governed by their native chiefs, whose duty was to collect the tribute and exercise magisterial functions. The chiefs or "curacas" had subordinate native officials under them called "pichca-pachacas" over 500 men, and "pachacas" over 100 men. The office of curaca or cacique was made hereditary, and its possessor enjoyed several privileges. Many curacas were descended from the imperial family of the Incas, or from great nobles of the Inca court. In addition to the tribute, which was in accordance with native usage, there was the "mita," or forced labour in mines, farms and manufactories. Toledo enacted that one-seventh of the male population of a village should be subject to conscription for this service, but they were to be paid, and were not to be taken beyond a specified distance from their homes.

The Spanish kings and viceroys desired to protect the people from tyranny, but they were unable to prevent the rapacity and lawlessness of distant officials and the country was depopulated by the illegal methods of enforcing the mita. Toledo was succeeded in 1581 by Don Martin Henriquez, who died at Lima two years afterwards. The Spanish colonies suffered from the strict system of monopoly and protection, which was only slightly relaxed by the later Bourbon kings, and from the arbitrary proceedings of the Inquisition. Between 1581 and 1776 as many as fifty-nine heretics were burned at Lima, and there were twenty-nine "autos"; but the Inquisition affected Europeans rather than natives, for the Indians, as catechumens, were exempted from its terrors. The curacas sorrowfully watched the gradual extinction of their people by the operation of the mita, protesting from time to time against the exactions and cruelty of the Spaniards. At length a descendant of the Incas, who assumed the name of Tupac Amaru, rose in rebellion in 1780. The insurrection lasted until July 1783, and cruel executions followed its suppression. This was the last effort of the Indians to throw off the Spanish yoke and the rising was by no means general. The army which overthrew Tupac Amaru consisted chiefly of loyal Indians, and the rebellion was purely anti-Spanish, and had no support from the Spanish population. The movement for independence, which slowly gained force during the opening decade of the 19th century, did not actually become serious until the conquest of Spain by the French in 1807-1808. The Creoles (Criollos) or American-born Spaniards had for long been aggrieved at being shut out from all important official positions, and at the restrictions placed upon their trade, but the bulk of the Creole population was not disloyal.

Peru was the centre of Spanish power, and the viceroy had his military strength concentrated at Lima. Consequently the insurrections in the more distant provinces, such as Chile and Buenos Aires, were the first to declare themselves independent, in 1816 and 1817. But the destruction of the viceroy's power was essential to their continued independent existence. The conquest of the Peruvian coast must always depend on the command of the sea. A fleet of armed ships was fitted out at Valparaiso in Chile, under the command of Lord Cochrane (afterwards earl of Dundonald) and officered by Englishmen. It conveyed an army of Argentine troops, with some Chileans, under the command of the Argentine general, San Martin, which landed on the coast of Peru in September 1820. San Martin was enthusiastically received, and the independence of Peru was proclaimed at Lima after the viceroy had withdrawn (July 28, 1821). On the 20th of September 1822 San Martin resigned the protectorate, with which he had been invested, and on the same day the first

Congress of Peru became the sovereign power of the state. After a short period of government by a committee of three, the congress elected Don José de la Riva Agüero to be first president of Peru on the 28th of February 1823. He displayed great energy in facing the difficulties of a turbulent situation, but was unsuccessful. The aid of the Colombians under Simon Bolívar was sought, and Agüero was deposed.

Bolívar arrived at Lima on the 1st of September 1823, and began to organize an army to attack the Spanish viceroy in the interior. On the 6th of August 1824 the cavalry action of Junin was fought with the Spanish forces under the command of a French adventurer, General Canterac, near the shores of the lake of Chinchay-cocha. It was won by a gallant charge of the Peruvians under Captain Suarez at the critical moment. Soon afterwards Bolívar left the army to proceed to the coast, and the final battle of Ayacucho (Dec. 9, 1824) was fought by his second in command, General Sucre. The viceroy and all his officers were taken prisoners, and the Spanish power in Peru came to an end.

General Bolívar ruled Peru with dictatorial powers for more than a year, and though there were cabals against him there can be little doubt of his popularity. He was summoned back to Colombia when he had been absent for five years and, in spite of protests left the country on the 3rd of September 1826, followed by all the Colombian troops in March 1827.

General José de Lamar, who commanded the Peruvians at Ayacucho, was elected president of Peru on the 24th of August 1827, but was deposed, after waging a brief but disastrous war with Colombia on the 7th of June 1829. General Agustín Gamarra, who had been in the Spanish service, and was chief of the staff in the patriot army at Ayacucho, was elected third president on the 31st of August 1829.

For fifteen years, from 1829 to 1844, Peru was painfully feeling her way to a right use of independence. The officers who fought at Ayacucho, and to whom the country felt natural gratitude, were all-powerful, and they had not learned to settle political differences in any other way than by the sword. Three men, during that period of probation, won a prominent place in their country's history, Generals Agustín Gamarra, Felipe Santiago Salaverry, and Andrés Santa Cruz. Gamarra, born at Cuzco in 1785, never accommodated himself to constitutional usages; but he attached to himself many loyal and devoted friends, and, with all his faults he loved his country and sought its welfare according to his lights. Salaverry was a very different character. Born at Lima in 1806, of pure Basque descent, he joined the patriot army before he was fifteen and displayed his audacious valour in many a hard-fought battle. Feeling strongly the necessity that Peru had for repose, and the guilt of civil dissension, he wrote patriotic poems which became very popular. Yet he too seized the supreme power, and perished by an iniquitous sentence on the 18th of February 1836.¹ Andrés Santa Cruz was an Indian statesman. His mother was a lady of high rank, of the family of the Incas, and he was very proud of his descent. Unsuccessful as a general in the field, he nevertheless possessed remarkable administrative ability and for nearly three years (1836-1839) realized his lifelong dream of a Peru-Bolivian confederation.² But the strong-handed intervention of Chile on the ground of assistance rendered to rebels, but really through jealousy of the confederation, ended in the defeat and overthrow of Santa Cruz, and the separation of Bolivia from Peru. But Peruvian history is not confined to the hostilities of these military rulers. Three constitutions were framed—in 1828, 1833 and 1839. Lawyers and orators are never wanting in Spanish-American states, and revolution succeeded revolution in one continuous struggle for the spoils

¹ The romance of his life has been admirably written by Manuel Bilbao (1st ed., Lima, 1853; 2nd ed., Buenos Aires, 1867).

² The succession of presidents and supreme chiefs of Peru from 1829 to 1844 was as follows: 1829-1833, Agustín Gamarra; 1834-1835, Luis José Orbegoso; 1835-1836, Felipe Santiago Salaverry; 1836-1839, Andrés Santa Cruz; 1839-1841, Agustín Gamarra; 1841-1844, Manuel Menéndez.

of office. An exception must be made of the administration of General Ramon Castilla, who restored peace to Peru, and showed himself to be an honest and very capable ruler. He was elected constitutional president on the 20th of April 1845. Ten years of peace and increasing prosperity followed. In 1849 the regular payment of the interest of the public debt was commenced, steam communication was established along the Pacific coast, and a railroad was made from Lima to Callao. After a regular term of office of six years of peace and moral and material progress Castilla resigned, and General José Echenique was elected president. But the proceedings of Echenique's government in connexion with the consolidation of the internal debt were disapproved by the nation, and, after hostilities which lasted for six months, Castilla returned to power in January 1855. From December 1856 to March 1858 he had to contend with and subdue a local insurrection headed by General Agostino Vivanco, but, with these two exceptions, there was peace in Peru from 1844 to 1879, a period of thirty-five years. Castilla retired at the end of his term of office in 1862, and died in 1868. On the 2nd of August 1868 Colonel Juan Balta was elected president. With the vast sum raised from guano and nitrate deposits President Balta commenced the execution of public works, principally railroads on a gigantic scale. His period of office was signalized by the opening of an international exhibition at Lima. He was succeeded (Aug. 2, 1872) by Don Manuel Pardo (d. 1878), an honest and enlightened statesman, who did all in his power to retrieve the country from the financial difficulty into which it had been brought by the reckless policy of his predecessor, but the conditions were not capable of solution. He regulated the Chinese immigration to the coast-valleys, which from 1860 to 1872 had amounted to 58,606. He promoted education, and encouraged literature. On the 2nd of August 1876 General Mariano-Ignacio Prado was elected. (C. R. M.; X.)

On the 5th of April 1879 the republic of Chile declared war upon Peru, the alleged pretext being that Peru had made an offensive treaty, directed against Chile, with Bolivia, ~~war with~~ a country with which Chile had a dispute; but the ~~Chilean~~ ~~1882~~ publication of the text of this treaty made known

the fact that it was strictly defensive and contained no just cause of war. The true object of Chile was the conquest of the rich Peruvian province of Tarapacá, the appropriation of its valuable guano and nitrate deposits, and the spoliation of the rest of the Peruvian coast. The military events of the war, calamitous for Peru, are dealt with in the article ~~Chile-Peruvian War~~. Suffice it here to note that, after the crushing defeat of the Peruvian forces at Arica (June 7, 1880) Señor Nicolas de Pierola assumed dictatorial powers, with General Andrés Cáceres as commander-in-chief, but the defeats at Chorrillos (Jan. 13, 1881) and Miraflores (Jan. 15) proved the Chilean superiority, and put Lima at their mercy though desultory fighting was maintained by the remnants of the Peruvian army in the interior, under direction of General Cáceres. An attempt was made to constitute a government with Señor Calderon as president of the republic and General Cáceres as first vice-president. The negotiations between this nominal administration and the Chilean authorities for a treaty of peace proved futile, the Chilean occupation of Lima and the Peruvian seaboard continuing uninterruptedly until 1883. In that year Admiral Lynch, who had replaced General Baquedano in command of the Chilean forces after the taking of Lima, sent an expedition against the Peruvians under General Cáceres, and defeated the latter in the month of August. The Chilean authorities now began preparations for the evacuation of Lima, and to enable this measure to be effected a Peruvian administration was organized with the support of the Chileans. General Iglesias was nominated to the office of president of the republic, and in October 1883 a treaty of peace, known as the ~~treaty of~~ ~~Ancon~~, between Peru and Chile was signed. The Chilean army of occupation was withdrawn from Lima on the 22nd of October 1883, but a strong force was maintained at Chorrillos until July 1884, when the terms of the treaty were finally approved. The

principal conditions imposed by Chile were the absolute cession by Peru of the province of Tarapacá, and the occupation for a period of ten years of the territories of Tacna and Arica, the ownership of these districts to be decided by a popular vote of the inhabitants of Tacna and Arica at the expiration of the period named. A further condition was enacted that an indemnity of 10,000,000 soles was to be paid by the country finally remaining in possession—a sum equal to about £1,000,000 to-day. The Peruvians in the interior refused to recognize President Iglesias, and at once began active operations to overthrow his authority on the final departure of the Chilean troops. Affairs continued in this unsettled state until the middle of 1885, Cáceres meanwhile steadily gaining many adherents to his side of the quarrel. In the latter part of 1885 President Iglesias abdicated.

Under the guidance of General Cáceres a junta was then formed to carry on the government until an election for the presidency should be held and the senate and chamber of deputies constituted. In the following year (1886) General Cáceres was elected president of the republic for the usual term of four years. The task assumed by the new president was no sinecure. The country had been thrown into absolute confusion from a political and administrative point of view, but gradually order was restored, and peaceful conditions were reconstituted throughout the republic. The four years of office for which General Cáceres was elected passed in uneventful fashion, and in 1890 Señor Morales Bermudez was nominated to the presidency, with Señor Solar and Señor Borgoño as first and second vice-presidents. Matters continued without alteration from the normal course until 1894, and in that year Bermudez died suddenly a few months before the expiration of the period for which he had been chosen as president. General Cáceres secured the nomination of the vice-president Borgoño as chief of the executive for the unexpired portion of the term of the late president Bermudez. This action was unconstitutional, and was bitterly resented by the vice-president Solar, who by right should have succeeded to the office. Armed resistance to the authority of Borgoño was immediately organized in the south of Peru, the movement being supported by Señores Nicolas de Pierola, Billinghurst, Durand and a number of influential Peruvians. In the month of August 1894 General Cáceres was again elected to fill the office of president, but the revolutionary movement rapidly gained ground. President Cáceres adopted energetic measures to suppress the outbreak: his efforts, however, proved unavailing, the close of 1894 finds the country districts in the power of the rebels and the authority of the legal government confined to Lima and other cities held by strong garrisons. Early in March 1895 the insurgents encamped near the outskirts of Lima, and on the 17th, 18th and 19th of March severe fighting took place, ending in the defeat of the troops under General Cáceres. A suspension of hostilities was then brought about by the efforts of H.B.M. consul. The loss on both sides to the struggle during these two days was 2800 killed and wounded. President Cáceres, finding his cause was lost, left the country, a provisional government under Señor Candamo assuming the direction of public affairs.

On the 8th of September 1895 Señor Pierola was declared president of the republic for the following four years. The Peruvians were now heartily tired of revolutionary disturbances, and an insurrectionary outbreak in the district of Iquitos met with small sympathy, and was speedily crushed. In 1896 a reform of the electoral law was sanctioned. By the provisions of this act an electoral committee was constituted, composed of nine members, two of these nominated by the senate, two by the chamber of deputies, four by the supreme court, and one by the president with the consent of his ministers. To this committee was entrusted the task of the examination of all election returns, and of the proclamation of the names of successful candidates for seats in congress. Another reform brought about by Pierola was a measure introduced and sanctioned in 1897 for a modification of the marriage laws. Under the new act marriages of non-

Catholics solemnized by diplomatic or consular officers or by ministers of dissenting churches, if properly registered, are valid, and those solemnized before the passing of this act were to be valid if registered before the end of 1899. Revolutionary troubles again disturbed the country in 1899, when the presidency of Señor Pierola was drawing to a close. In consequence of dissensions amongst the members of the election committee constituted by the act of 1896, the president ordered the suppression of this body. A group of malcontents under the leadership of one Durand, a man who had been prominent in the revolution against General Cáceres in 1894-95, conspired against the authorities and raised several armed bands, known locally as *montoneras*. Some skirmishes occurred between these insurgents and the government troops, the latter generally obtaining the advantage in these encounters.

In September 1899 President Pierola vacated the presidency in favour of Señor Romaña, who had been elected to the office as a popular candidate and without the exercise of any undue official influence. President Romaña was educated at Stonyhurst in England, and was a civil engineer by profession. The principal political problem before the government of Peru was the ownership of the territories of Tacna and Arica. The period of ten years originally agreed upon for the Chilean occupation of these provinces expired in 1894. At that date the peace of Peru was so seriously disturbed by internal troubles that the government was quite unable to take active steps to bring about any solution of the matter. After 1894 negotiations between the two governments were attempted from time to time, but without any satisfactory results. The question hinged to a great extent on the qualification necessary for the inhabitants to vote, in the event of a plebiscite being called to decide whether Chilean ownership was to be finally established or the provinces were to revert to Peruvian sovereignty. Peru proposed that only Peruvian residents should be entitled to take part in a popular vote; Chile rejected this proposition, on the ground that all residents in the territories in question should have a voice in the final decision. The agreement between Chile and Bolivia, by which the disputed provinces were to be handed over to the latter country if Chilean possession was recognized, was also a stumbling-block, a strong feeling existed among Peruvians against this proceeding. It was not so much the value of Tacna and Arica that put difficulties in the way of a settlement as the fact that the national pride of the Peruvians ill brooked the idea of permanently losing all claim to this section of country. The money, about £1,000,000, could probably have been obtained to indemnify Chile if occasion for it arose.

The question of the delimitation of the frontier between Peru and the neighbouring republics of Ecuador, Colombia, and Brazil also cropped up at intervals. A treaty was signed with Brazil 1876, by which certain physical features were accepted by both countries as the basis for the boundary. In the case of Ecuador and Colombia a dispute arose in 1894 concerning the ownership of large tracts of uninhabited country in the vicinity of the headwaters of the Amazon and its tributaries. An agreement was proposed between Peru and Ecuador in connexion with the limits of the respective republics, but difficulties were created to prevent this proposal from becoming an accomplished fact by the pretensions put forward by Colombia. The latter state claimed sovereignty over the Napo and Marañon rivers on the grounds of the ecclesiastical jurisdiction exercised over this section of territory during the period of Spanish dominion, the government of Colombia asserting that these ecclesiastical rights to which Colombia became entitled after her separation from the Spanish crown carried also the right of absolute ownership. In a treaty signed by the three interested states in 1895 a compromise was effected by which Colombia withdrew a part of the claim advanced, and it was agreed that any further differences arising out of this frontier question should be submitted to the arbitration of the Spanish crown. The later development of the boundary question is dealt with at the outset of this article.

Cáceres in Power.

Romaña President.

Pierola President.

Señor Manuel Candamo succeeded Señor Romana as president in 1903. In the following year he died, and on the 24th of September 1904 Señor José Pardo was installed in the presidential chair. In 1908 there were some insurrectionary movements at Lima and an attempt was made to assassinate President Pardo, but they were, however, suppressed without a serious outbreak. Señor Augusto Leguiva became president on the 24th of September 1908.

(C. E. A.; G. E.)

BIBLIOGRAPHY.—Among the principal publications relating to Peru are: C. E. Akers, *A History of South America* (London, 1904); L. E. Albertini, *Pérou en 1878* (Paris, 1878); C. B. Cisneros and R. E. Garcia, *El Peru en Europa* (Lima, 1900); the same authors, *Geografía comercial de la América del Sud* (3 vols., *ibid.* 1898); E. B. Clark, *Twelve Months in Peru* (London, 1891); Geo. R. Fitzroy Cole, *The Peruvians at Home*, (*ibid.* 1884); A. J. Duffield, *Peru in the Guano Age* (*ibid.* 1877); C. R. Enock, *The Andes and the Amazon* (*ibid.* 1907); *idem*, *Peru: its Former and Present Civilization*, &c. (*ibid.* 1908); P. F. Evans, *From Peru to the Plate* (*ibid.* 1889); M. A. Fuentes, *Lima, or Sketches of the Capital of Peru* (*ibid.* 1866); Calderon F. Garcia, *Le Pérou contemporain* (Paris, 1907); Garcilasso de la Vega, *Royal commentaries of the Incas*, 1609 (Hakluyt Society's Publications); A. Garland, *La Industria azucarera en el Peru, 1550-1805* (Lima, 1895); *idem*, *Peru in 1906* (*ibid.* 1907); E. Grandier, *Voyage dans l'Amérique du Sud, Pérou et Bolivie* (Paris, 1863); T. Haënen, *Description du Peru* (Lima, 1901); E. Higginson, *Mines and Mining in Peru* (*ibid.* 1903); S. S. Hill, *Travels in Peru and Mexico* (2 vols., London, 1860); T. J. Hutchinson, *Two Years in Peru* (2 vols., *ibid.* 1874); R. Laos, *A Handbook of Peru for Investors and Immigrants* (Baltimore, 1903); C. R. Markham, *Cusco and Lima* (London, 1888); *idem*, *Travels in Peru and India* (*ibid.* 1862); *idem*, *The War between Peru and Chile* (*ibid.* 1883); *idem*, *History of Peru* (Chicago, 1892); V. M. Maurtua, *The Question of the Pacific* (Philadelphia, 1901); M. de Mendiburu, *Diccionario histórico-biográfico del Peru* (8 vols., Callao, 1874-1890); E. W. Middendorf, *Peru: Beobachtungen und Studien über das Land und seine Bewohner*, &c. (Berlin, 1893); Federico Moreno, *Petroleum in Peru* (Lima, 1891); Dr M. Neveu-Lemaire, *Les Lacs des hauts plateaux de l'Amérique du Sud* (Paris, 1906); M. F. Paz-Soldan, *Historia del Peru independiente* (3 vols., 1868 et seq.); *idem*, *Diccionario geográfico-estadístico del Peru* (Lima, 1879); A. Plane, *A travers l'Amérique équatoriale* (Paris, 1903); W. H. Prescott, *History of the Conquest of Peru* (3 vols., Philadelphia, 1868); A. Raimondi, *El Peru: Estudios mineralógicos*, &c. (4 vols., Lima, 1890-1902); M. Ch. Renoz, *Le Pérou* (Bruxelles, 1897); G. René-Moreno, *Ultimos dias coloniales en el Alto Peru 1807-1808* (Santiago de Chile, 1896-1898); F. Seebee, *Travelling Impressions in and Notes on Peru* (2nd ed., London, 1905); E. G. Squier, *Peru: Incidents of Travel and Exploration in the Land of the Incas* (*ibid.* 1877); Edmond Temple, *Travels in Various Parts of Peru* (2 vols., *ibid.* 1830); J. J. Von Tschudi, *Reisen durch Südamerika* (5 vols., Leipzig, 1866-1868); *idem*, *Travels in Peru* (London, 1847); Charles Wiener, *Pérou et Bolivie* (Paris, 1880); Frank Vincent, *Around and about South America* (New York, 1890); Marie Robinson Wright, *The Old and New Peru* (Philadelphia, 1909); the Consular and Diplomatic Reports of Great Britain and the United States; Handbook of Peru and Bulletins of the Bureau of American Republics; and the departmental publications of the Peruvian Government.

PERU, a city of La Salle county, Illinois, U.S.A., in the north-central part of the state, on the N. bank of the Illinois River, about 100 m. S.W. of Chicago and 1 m. W. of La Salle, a terminus of the Illinois & Michigan Canal. Pop. (1900), 6863 (2005 foreign-born); (1910), 7984. It is served by the Chicago, Burlington & Quincy and the Chicago, Rock Island & Pacific railways. The city is built on the face and top of a series of river bluffs. It is the seat of St Bede College (Roman Catholic, opened in 1891), conducted by Benedictine fathers. In a large public park there is a bronze monument in memory of the soldiers of Peru who died in the Civil War. There are extensive coal-mines in the vicinity; and the city includes various manufactures. Peru was first settled about 1827, was incorporated in 1845, and re-incorporated in 1890.

PERU, a city and the county-seat of Miami county, Indiana, U.S.A., about 75 m. N. of Indianapolis, on the Wabash River. Pop. (1910 U.S. census), 10,910. Peru is served by the Chicago Cincinnati & Louisville, the Lake Erie & Western and the Wabash railways (each of which maintains shops here), and by electric lines to Indianapolis, Warsaw and other cities. The city has a Carnegie library, a railway Young Men's Christian Association, and a hospital for the employés of the Wabash railroad. There is a city park on the river, and 9 m. east of the city is Boyd park, an amusement resort. Peru is an important grain and produce market, and has various manufactures.

In 1905 the value of the factory products was \$1,703,517 (27.3% more than in 1900). Petroleum is found in the vicinity. Peru was settled in 1834 and was chartered as a city in 1867.

PERUGIA (anc. *Perusia*), a city and archiepiscopal see of Italy, the capital of the province of Perugia (which forms the entire *compartimento* of Umbria) situated 1444 ft. above sea-level. Pop. (1906), 22,321 (town); 65,527 (commune). The town is finely situated upon a group of hills nearly 1000 ft. above the valley of the Tiber. Its outline is very irregular; from the centre of the town, at the junction of several ridges, parts of it extend for a considerable distance along their summits, being divided from one another by deep valleys. This is the extent enclosed by the medieval walls; within them are considerable remains of the lofty terrace walls of the Etruscan period. The so-called Arco di Augusto is a town gate with a Decorated superstructure, perhaps of the Etruscan period, bearing the inscription *Augusta Perusia*; above this again is a Renaissance loggia. The superstructure of a similar gate (Porta Marzia), which was removed in 1540 to make way for the citadel, but is depicted in a fresco by Benedetto Bonfigli (between 1461 and 1477), was re-erected in the substruction walls of the citadel itself. It bears the inscription *Colonia Vibia Augusta Perusia* so that the town must have become a colony in the reign of the emperor C. Vibius Trebonianus Gallus (A.D. 251-253), who was a native of it. Four other gates of the Etruscan period can still be traced (F. Noack in *Römische Mitteilungen*, 1897, 166 sqq.). In the garden of the church of S. Elisabetta was found in 1876 a fine mosaic in black on a white ground representing Orpheus in the midst of the beasts (*Notizie degli scavi*, 1876, 181; 1877, 309).

The citadel was erected by Pope Paul III. in 1540-1546, after the plans of Antonio da Sangallo the younger, and demolished in 1860 (see Bacile di Castiglione in *L'Arte*, 1903, 347). The Piazza del Duomo is at the north of the Corso. On one side stands the cathedral of San Lorenzo, a Gothic structure of the 14th and 15th centuries, in the plan of a Latin cross, with nave and aisles of equal height; on the other the Palazzo del Municipio, presenting two fine Gothic façades, of the 14th century (though the building was not completed till 1443), with the figures of the Perugian griffin and the Guelph lion above the outside stair; and in the centre the marble fountain constructed in 1277-1280 by Arnolfo di Cambio, and adorned with statues and statuettes by Niccolò and Giovanni Pisano. The cathedral contains the burial-place of Urban IV. and Martin IV.—the remains of Innocent III. were removed to Rome in 1892 and placed in the basilica of S. Giovanni in Laterano—and the Virgin's wedding-ring; and at the north-east corner is a sitting statue of Pope Julius III. by Vincenzo Danti, erected in 1555 by the people of Perugia in gratitude for the restoration of their civic privileges. On the decoration of the Sala del Cambio, or old exchange, Perugino put forth the full force of his genius. Most of the movable paintings have since 1863 been collected in the Pinacoteca Vannucci, established in the Palazzo del Municipio; besides a considerable number of pieces by Perugino, there are specimens of Niccolò Alunno, Bonfigli, Pinturicchio, &c. A very interesting and important exhibition of Umbrian art was held here in 1907. The pictures, the needlework with some splendid pieces of embroidery from S. Francesco at Assisi, the vestments of Pope Benedict XI., and the majolica of Perugia and Deruta, a village 10 m. south, were especially noteworthy (see U. Gnoli, *L'Arte umbra alla mostra di Perugia*, Bergamo, 1908). The illuminated MSS. of the communal library, the cathedral and the church of S. Pietro, from the 7th century onwards, were also exhibited.

The formation of the Pinacoteca Vannucci has impaired the interest of several churches but in others it remains undiminished. San Domenico, a Gothic edifice originally designed by Giovanni Pisano but rebuilt in 1614, contains the monument of Pope Benedict XI. (attributed, but probably wrongly, to Giovanni Pisano by Vasari), and in its east end a Gothic window with stained glass by Fra Bartolommeo of Perugia (1441). San Pietro de' Cassinensi (outside the Porta Romana) is a basilica

with nave and aisles, founded in the beginning of the 11th century by San Pietro Vincioli on the site of a building of the 6th century, and remarkable for its conspicuous spire, its ancient granite and marble columns, its walnut stall-work of 1535 by Stefano de' Zambelli da Bergamo, and its numerous pictures (by Perugino, &c.). The oratory of S. Bernardino has an early Renaissance polychrome façade, richly sculptured, of 1457-1461, by Agostino d'Antonio di Duccio of Florence. S. Severo contains Raphael's first independent fresco (1505), much damaged by restoration. The circular church of S. Angelo, with sixteen antique columns in the interior, probably dates from the middle of the 6th century. The university dates from 1507, and has faculties of law, science and medicine; it had 378 students in 1902-1903. It contains an important museum of Etruscan and Roman antiquities. Three miles to the S.S.E. the Etruscan necropolis of the ancient city was discovered in 1870. The large tomb of the Volturni (3rd century B.C.) hewn in the rock, with its carved cinerary urns, is interesting.

The ancient Perugia first appears in history as one of the twelve confederate cities of Etruria. It is first mentioned in the account of the war of 310 or 309 B.C. between the Etruscans and the Romans. It took, however, an important part in the rebellion of 295, and was reduced, with Vulsinii and Arretium, to seek for peace in the following year. In 216 and 205 it assisted Rome in the Hannibalic war, but afterwards it is not mentioned until 41-40 B.C., when L. Antonius took refuge there, and was reduced by Octavian after a long siege. A number of lead bullets used by slingers have been found in and around the city (*Corpus inscr. lat.* xi. 1212). The city was burnt, we are told, with the exception of the temples of Vulcan and Juno—the massive Etruscan terrace-walls, naturally, can hardly have suffered at all—and the town, with the territory for a mile round, was allowed to be occupied by whoever chose. It must have been rebuilt almost at once, for several bases exist, inscribed *Augusto sacrum Perusia restituta*; but, as we have seen, it did not become a colony until A.D. 251-253. It is hardly mentioned except by the geographers until the middle of the 6th century, when it was captured by Totila after a long siege. In the Lombard period it is spoken of as one of the principal cities of Tuscia. In the 9th century, with the consent of Charles the Great and Louis the Pious, it passed under the popes; but for many centuries the city continued to maintain an independent life, warring against many of the neighbouring lands and cities—Foligno, Assisi, Spoleto, Montepulciano, &c. It remained true for the most part to the Guelphs. On various occasions the popes found asylum within its walls, and it was the meeting-place of the conclaves which elected Honorius II. (1124), Honorius IV. (1185), Celestine V. (1294), and Clement V. (1305). But Perugia had no mind simply to subserve the papal interests. At the time of Rienzi's unfortunate enterprise it sent ten ambassadors to pay him honour; and, when papal legates sought to coerce it by foreign soldiers, or to exact contributions, they met with vigorous resistance. In the 15th century power was at last concentrated in the Baglioni family, who, though they had no legal position, defied all other authority. Gian Paolo Baglioni was lured to Rome in 1520 and beheaded by Leo X.; and in 1534 Rodolfo, who had slain a papal legate, was defeated by Pier Luigi Farnese, and the city, captured and plundered by his soldiery, was deprived of its privileges. The citadel was begun six years later "ad coercendam Perusiorum audaciam." In 1797 Perugia was occupied by the French; in 1832, 1838 and 1854 it was visited by earthquakes; in May 1849 it was seized by the Austrians; and, after a futile insurrection in 1859, it was finally united, along with the rest of Umbria, to Piedmont, in 1860.

See G. Conestabile, *I Monumenti di Perugia etrusca e romana* (Perugia, 1855); M. Symonds and L. Duff Gordon, *Perugia* ("Medieval Towns Series"), (1898); R. A. Gallenga Stuart, *Perugia* (Bergamo, 1905); W. Heywood, *Hist. of Perugia* (1910). (T. As.)

PERUGINO, PIETRO (1446-1524), whose correct family name was VANNUCCI, Italian painter, was born in 1446 at Città della Pieve in Umbria, and belongs to the Umbrian school of

painting. The name of Perugino came to him from Perugia, the chief city of the neighbourhood. Pietro was one of several children born to Cristoforo Vannucci, a member of a respectable family settled at Città della Pieve. Though respectable, they seem to have been poor, or else, for some reason or other, to have left Pietro uncared for at the opening of his career. Before he had completed his ninth year the boy was apprenticed to a master, a painter at Perugia. Who this may have been is very uncertain; the painter is spoken of as wholly mediocre, but sympathetic for the great things in his art. Benedetto Bonfigli is generally surmised; if he is rejected as being above mediocrity, either Fiorenzo di Lorenzo or Niccolò da Foligno may possibly have been the man. Pietro painted a little at Arezzo; thence he went to the headquarters of art, Florence, and frequented the famous Brancacci Chapel in the church of the Carmine. It appears to be sufficiently established that he studied in the atelier of Andrea del Verrocchio, where Leonardo da Vinci was also a pupil. He may have learned perspective, in which he particularly excelled for that period of art, from Piero de' Franceschi. The date of this first Florentine sojourn is by no means settled; some authorities incline to make it as early as 1470, while others, with perhaps better reason, postpone it till 1479. Pietro at this time was extremely poor; he had no bed, but slept on a chest for many months, and, bent upon making his way, resolutely denied himself every creature comfort.

Gradually Perugino rose into notice, and became famous not only throughout Italy but even beyond. He was one of the earliest Italian painters to practise oil-painting, in which he evinced a depth and smoothness of tint, which elicited much remark; and in perspective he applied the novel rule of two centres of vision. Some of his early works were extensive frescoes for the Ingesati fathers in their convent, which was destroyed not many years afterwards in the course of the siege of Florence; he produced for them also many cartoons, which they executed with brilliant effect in stained glass. Though greedy for gain, his integrity was proof against temptation; and an amusing anecdote has survived of how the prior of the Ingesati doled out to him the costly colour of ultramarine, and how Perugino, constantly washing his brushes, obtained a surreptitious hoard of the pigment, which he finally restored to the prior to shame his stingy suspiciousness. A good specimen of his early style in tempera is the circular picture in the Louvre of the "Virgin and Child enthroned between Saints."

Perugino returned from Florence to Perugia, and thence, towards 1483, he went to Rome. The painting of that part of the Sixtine Chapel which is now immortalized by Michelangelo's "Last Judgment" was assigned to him by the pope; he covered it with frescoes of the "Assumption," the "Nativity," and "Moses in the Bulrushes." These works were ruthlessly destroyed to make a space for his successor's more colossal genius, but other works by Perugino still remain in the Sixtine Chapel; "Moses and Zipporah" (often attributed to Signorelli), the "Baptism of Christ," and "Christ giving the Keys to Peter." Pinturicchio accompanied the greater Umbrian to Rome, and was made his partner, receiving a third of the profits; he may probably have done some of the Zipporah subject.

Pietro, now aged forty, must have left Rome after the completion of the Sixtine paintings in 1486, and in the autumn of that year he was in Florence. Here he figures by no means advantageously in a criminal court. In July 1487 he and another Perugian painter named Aulista di Angelo were convicted, on their own confession, of having in December waylaid with staves some one (the name does not appear) in the street near S. Pietro Maggiore. Perugino limited himself, in intention, to assault and battery, but Aulista had made up his mind for murder. The minor and more illustrious culprit was fined ten gold florins, and the major one exiled for life.

Between 1486 and 1499 Perugino resided chiefly in Florence, making one journey to Rome and several to Perugia. He was in many other parts of Italy from time to time. He had a regular shop in Florence, received a great number of commissions, and continued developing his practice as an oil-painter, his

system of superposed layers of colour being essentially the same as that of the Van Eycks. One of his most celebrated pictures, the "Pieta" in the Pitti Gallery, belongs to the year 1495. From about 1498 he became increasingly keener after money, frequently repeating his groups from picture to picture, and leaving much of his work to journeymen. In 1499 the guild of the cambio (money-changers or bankers) of Perugia asked him to undertake the decoration of their audience-hall, and he accepted the invitation. This extensive scheme of work, which may have been finished within the year 1500, comprised the painting of the vault with the seven planets and the signs of the zodiac (Perugino doing the designs and his pupils most probably the executive work) and the representation on the walls of two sacred subjects—the "Nativity" and "Transfiguration"—the Eternal Father, the four virtues of Justice, Prudence, Temperance and Fortitude, Cato as the emblem of wisdom, and (in life size) numerous figures of classic worthies, prophets and sibyls. On the mid-plaster of the hall Perugino placed his own portrait in bust-form. It is probable that Raphael, who in boyhood, towards 1496, had been placed by his uncles under the tuition of Perugino, bore a hand in the work of the vaulting. It may have been about this time (though some accounts date the event a few years later) that Vannucci married a young and beautiful wife, the object of his fond affection; he loved to see her handsomely dressed, and would often deck her out with his own hands. He was made one of the priors of Perugia in 1501.

While Perugino, though by no means stationary or unprogressive as an executive artist, was working contentedly upon the old lines and carrying out the ancient conceptions, a mighty wave of new art flooded Florence with its rush and Italy with its rumour. Michelangelo, twenty-five years of age in 1500, following after and distancing Leonardo da Vinci, was opening men's eyes and minds to possibilities of achievement as yet unsuspected. Vannucci in Perugia heard Buonarroti brawled abroad, and was impatient to see with his own eyes what the stir was all about. In 1504 he allowed his apprentices and assistants to disperse, and returned to Florence. Though not openly detracting, he viewed with jealousy and some grudging the advances made by Michelangelo; and Michelangelo on his part repaid, with the intolerance which pertains to superiority, to the faint praise or covert disparage of his senior and junior in the art. On one occasion, in company, he told Perugino to his face that he was "a bungler in art" (*goffo nell' arte*). Vannucci brought, with equal indiscretion and ill success, an action for defamation of character. Put on his mettle by this mortifying transaction, he determined to show what he could do, and he produced the *chef-d'œuvre* of the "Madonna and Saints" for the Certosa of Pavia. The constituent parts of this noble work have now been sundered. The only portion which remains in the Certosa is a figure of God the Father with cherubim. An "Annunciation" has disappeared from cognisance; three compartments—the Virgin adoring the infant Christ, St Michael, and St Raphael with Tobias—are among the choicer treasures of the National Gallery, London. The current story that Raphael bore a hand in the work is not likely to be true. This was succeeded in 1505 by an "Assumption," in the Cappella dei Rabatta, in the church of the Servi in Florence. The painting may have been executed chiefly by a pupil, and was at any rate a failure: it was much decried; Perugino lost his scholars; and towards 1506 he once more and finally abandoned Florence, going to Perugia, and thence in a year or two to Rome.

Pope Julius II. had summoned Perugino to paint the Stanza in the Vatican, now called that of the Incendio del Borgo; but he soon preferred a younger competitor, that very Raphael who had been trained by the aged master of Perugia; and Vannucci, after painting the ceiling with figures of God the Father in different glories, in five medallion-subjects, found his occupation gone; he retired from Rome, and was once more in Perugia from 1512. Among his latest works one of the best is the extensive altar-piece (painted between 1512 and 1517) of S. Agostino in Perugia; the component parts of it are now dispersed in various galleries.

Perugino's last frescoes were painted for the monastery of S. Agnese in Perugia, and in 1522 for the church of Castello di Fortignano hard by. Both series have disappeared from their places, the second being now in the Victoria and Albert Museum. He was still at Fortignano in 1524 when the plague broke out, and he died. He was buried in unconsecrated ground in a field, the precise spot now unknown. The reason for so obscure and unwonted a mode of burial has been discussed, and religious scepticism on the painter's own part has been assigned as the cause; the fact, however, appears to be that, on the sudden and widespread outbreak of the plague, the panic-struck local authorities ordained that all victims of the disorder should be at once interred without any waiting for religious rites. This leads us to speak of Perugino's opinions on religion. Vasari is our chief, but not our sole, authority for saying that Vannucci had very little religion, and was an open and obdurate disbeliever in the immortality of the soul. For a reader of the present day it is easier than it was for Vasari to suppose that Perugino may have been a materialist, and yet just as good and laudable a man as his orthodox Catholic neighbours or brother-artists; still there is a strong discrepancy between the quality of his art, in which all is throughout Christian, Catholic, devotional, and even pietistic, and the character of an anti-Christian contemner of the doctrine of immortality. It is difficult to reconcile this discrepancy, and certainly not a little difficult also to suppose that Vasari was totally mistaken in his assertion; he was born twenty years before Perugino's death, and must have talked with scores of people to whom the Umbrian painter had been well known. We have to remark that Perugino in 1494 painted his own portrait, now in the Uffizi Gallery of Florence, and into this he introduced a scroll lettered "Timete Deum." That an open disbeliever should inscribe himself with "Timete Deum" seems odd. The portrait in question shows a plump face, with small dark eyes, a short but well-cut nose, and sensuous lips; the neck is thick, the hair bushy and frizzled, and the general air imposing. The later portrait in the Cambio di Perugia shows the same face with traces of added years. Perugino died possessed of considerable property, leaving three sons.

Among the very numerous works of Perugino a few not already named require mention. Towards 1496 he painted the "Crucifixion," in S. Maria Maddalena dei Pazzi, Florence. The attribution to him of the picture of the marriage of Joseph and the Virgin Mary (the "Sposallizio") now in the museum of Caen, which served indisputably as the original, to a great extent, of the still more famous "Sposallizio" which was painted by Raphael in 1504, and which forms a leading attraction of the Brera Gallery in Milan, is now questioned, and it is assigned to Lo Spagna. A vastly finer work of Perugino's is the "Ascension of Christ," which, painted a little earlier for S. Pietro of Perugia, has for years past been in the museum of Lyons; the other portions of the same altar-piece are dispersed in other galleries. In the chapel of the Disciplinati di Città della Pieve is an "Adoration of the Magi," a square of 21 ft. containing about thirty life-sized figures; this was executed, with scarcely credible celerity, from the 1st to the 25th of March (or thereabouts) in 1505, and must no doubt be in great part the work of Vannucci's pupils. In 1507, when the master's work had for years been in a course of decline and his performances were generally weak, he produced, nevertheless, one of his best pictures—the "Virgin between St Jerome and St Francis," now in the Palazzo Penna. In S. Onofrio of Florence is a much lauded and much-debated fresco of the "Last Supper," a careful and blandly correct but not inspired work; it has been ascribed to Perugino by some connoisseurs, by others to Raphael; it may more probably be by some different pupil of the Umbrian master.

AUTHORITIES.—In addition to Crowe and Cavalcaselle, see Di Pietro Perugino e degli scolari (1804); Mezzanotte, *Vita, etc.*, di Pietro Vannucci (1836); Mariotti, *Lettere pittoriche Perugine* (1788); Claude Phillips (in *The Portfolio*) (1893); G. C. Williamson, *Perugino* (1900 and 1903). (W. M. R.)

PERUKE, an artificial head of hair, a wig. The word is from Fr. *perruque*, an adaptation of Ital. *perruca* or *parrucca*. This is usually taken to be from Ital. *pelo*, hair; Lat. *pilus*. Span. *peluca*, wig, and Sardinian *pilucca*, lock or tuft of hair, support this view. In the 17th century the English forms which the French word took, such as *perruck* or *perrug*, were corrupted into *peruwike*, and thence into *perewyk*, *perewig*, and lastly "perwig," which again was shortened into "wig," the

common term for all types of artificial heads of hair. Periwig is sometimes confined to the heavy full-bottomed wigs worn from the reign of Charles II. to the introduction of the light, tailed wig of the 18th century.

PERUZZI, BALDASSARE (1481-1536), Italian architect and painter of the Roman school, was born at Ancajano, in the diocese of Volterra, and passed his early life at Siena, where his father resided. While quite young Peruzzi went to Rome, and there studied architecture and painting; in the latter he was at first a follower of Perugino. The choir frescoes in Sant' Onofrio on the Janiculum Hill, usually attributed to Pinturicchio, are by his hand. One of the first works which brought renown to the young architect was the villa on the banks of the Tiber in Rome now known as the Farnesina, originally built for the Siense Agostino Chigi, a wealthy banker. This villa, like all Peruzzi's works, is remarkable for its graceful design and the delicacy of its detail. It is best known for the frescoes painted there by Raphael and his pupils to illustrate the stories of Psyche and Galatea. One of the loggie has frescoes by Peruzzi's own hand—the story of Medusa. On account of his success Peruzzi was appointed by Leo X. in 1520 architect to St Peter's at a salary of 250 scudi; his design for its completion was not, however, carried out. During the sack of Rome in 1527 Peruzzi barely escaped with his life, on condition of his painting the portrait of Constable de Bourbon, who had been killed during the siege (see *VASARI*). From Rome he escaped to Siena, where he was made city architect, and designed fortifications for its defence, a great part of which still exist. Soon afterwards he returned to Rome, where he made designs for a palace for the Orsini family, and built the palaces Massimi and Vidoni, as well as others in the south of Italy. He died in 1536, and was buried by the side of Raphael in the Pantheon.

Peruzzi was an eager student of mathematics and was also a fair classical scholar. Like many of the great artists of his time, he was remarkable for the varied extent of his knowledge and skill. A most able architect, a fair painter, and a scientific engineer, he also practised minor arts, such as stucco-work in relief, sgraffito, and the decorative painted arabesques which the influence of Raphael did so much to bring into use. His best existing works in fresco are in the Castel di Belcaro and the church of Fontegiusta in Siena. For Siena Cathedral he also designed a magnificent wooden organ-case, painted and gilt, rich with carved arabesques in friezes and pilasters; he also designed the high altar and the Cappella del Battista.

His chief pupil was the architect Serlio, who, in his work on architecture, gratefully acknowledges the great debt he owed to Peruzzi's instruction. The English National Gallery possesses an interesting drawing by his hand. The subject is the "Adoration of the Magi," and it is of special value, because the heads of the three kings are portraits of Michelangelo, Raphael, and Titian. The Uffizi and the library at Siena contain a number of Peruzzi's designs and drawings, many of which are now of priceless value, as they show ancient buildings which have been destroyed since the 16th century.

AUTHORITIES.—*Vasari, Vita di Baldassarre Peruzzi* (Milanese's ed., 1882), iv. 489; *Milizia, Memorie degli architetti* (1781), i. 210-215; *Delta Valle, Lettere senesi* (1782-1786); *Gaye, Carteggio inedito d' artisti* (1839-1840); *Lausi, Storia pittrice* (1804); and *Platner, Beschreibung der Stadt Rom* (1830-1842).

PERVIGILIU¹ VENERIS, the Vigil of Venus, a short Latin poem. The author, date, and place of composition are unknown. The poem probably belongs to the 2nd or 3rd century A.D. An article signed L. Raquetina in the *Classical Review* (May 1905) assigns it to Sidonius Apollinaris (5th cent.) It was written professedly in early spring on the eve of a three-nights' festival of Venus (probably April 1-3). It describes in poetical language the annual awakening of the vegetable and animal world through the goddess. It consists of ninety-three verses in trochaic septenarii, and is divided into strophes of unequal length by the refrain:

"Cras amet qui nunquam amavit; quique amavit cras amet."

¹ *Pervigilium* was the term for a nocturnal festival in honour of some divinity, especially *Bona Dea*.

Ediitio princeps (1577); modern editions by F. Bücheler (1859), A. Riese, in *Anthologia latina* (1869), E. Bährens in *Ungedruckte lateinische Gedichte* (1877); S. G. Owen (with Catullus, 1893). There are translations into English verse by Thomas Stanley (1651) and Thomas Farnell, author of *The Hermit*; on the text see J. W. Mackail in *Journal of Philology* (1888), vol. xvii.

PESARO (anc. *Pisaurum*, q.v.), a city and seaport of the Marche, Italy, the capital of the province of Pesaro and Urbino, situated on the coast of the Adriatic 37 m. N.W. of Ancona by rail, on the right bank of the Foglia, the ancient *Pisaurus*. The ground on which it is built is only from 10 to 40 ft. above the sea, but it is surrounded by hills—on the E. by Monte Ardizio, on the W. by Monte Accio or San Bartolo, which derives one of its names from the tradition that the Roman dramatist L. Attius was born and buried on the spot. Upon this hill stands the Villa Imperiale, the foundation stone of which was laid by the emperor Frederick III., built by the Sforza, and decorated with fine stucco ceilings and wall paintings and pavements of majolica plaques. A new palace was begun in 1530 by the Genga for Eleonora Gonzaga, but never finished. The city walls were in 1830 transformed into a public promenade. Besides the ancient cathedral of the Annunciation (restored since 1860) with a 12th-century mosaic pavement, there are a number of smaller churches, several with Gothic portals. One of these, the church of San Francesco, now used as a cathedral, contains the "Coronation of the Virgin" by Giovanni Bellini, the largest and most important of his works outside Venice. The most conspicuous buildings are the prefecture (a palace originally erected in 1455-1465 by the Dalmatian architect Luciano da Laurana for the Sforza, and restored by Francesco Maria della Rovere in the 16th century, the Rossini theatre (opened in 1818), the fortress of Rocca Costanza (built by Costanzo Sforza in 1474, Laurana being the architect), and the large lunatic asylum. The composer Gioacchino Rossini, who was a native of Pesaro, left all his fortune to found a musical lyceum in the city, and his statue by Marochetti (1864) stands near the railway station. The Olivieri library (established by the antiquary of that name, author of *Marmora pisaurensis*, &c.) contains about 14,000 volumes, MSS. of Tasso, &c., inscriptions and various antiquities, and a very fine collection of majolica (one of the best in Italy) from the old Urbino and other manufactories. The Museo Mosca, left by its owner to the town, contains important collections of faience, furniture, &c. Among the industries of Pesaro are the growing, spinning and weaving of silk, tanning, iron-founding, and the manufacture of glass and pottery. It is also the centre of a rich agricultural district. The harbour is of no great importance, but there is a small export trade in wine, olives, silk and glass. Pop. (1901), 14,768 (town); 24,823 (commune).

Destroyed by Vitiges the Goth, the town was restored and strengthened by Belisarius, and afterwards along with Ancona, Fano, Senigallia, and Rimini formed the Pentapolis Maritima. In the course of the 13th century Pesaro was sometimes under the government of the popes, sometimes under that of the emperors; but the Malatesta family, which first took root in the city about 1285, gradually became the real masters of the place. In 1445 they sold their rights to Francesco Sforza; and in 1512, through the influence of Julius II., the Sforza were supplanted by his nephew Francesco Maria, duke of Urbino. Leo X. took the city away from Francesco and gave it to Lorenzo de' Medici; but on Lorenzo's death Francesco was restored and Pesaro became the ordinary residence of the dukes of Urbino till the death of Francesco Maria II. in 1631, when it reverted to the States of the Church. It has formed part of the present kingdom of Italy since 1860. Terenzio Mamiani della Rovere, poet and statesman, was born at Pesaro in 1800.

PESCADORES (i.e. fishers,) a group of islands (called by the Japanese *Hōkō Ō* or *Hōko Guntō*) lying 30 m. west of Formosa, from which they are separated by the Pescadores Channel, about the tropic of Cancer. The islands number 48 (21 inhabited), have a coast-line of 98.67 miles, a total area of 85,509 sq. m., and a population of about 55,000, principally Chinese. Flat and with unproductive soil, they are swept during one

half of the year by violent N.E. winds, and also lie full in the path of the numerous typhoons that rush up the Strait of Formosa. Meteorological observations taken by the Japanese during a period of three years show that the annual average number of stormy days is 237. The anchorage is at Mako (Makyū or Makun) on the principal island of Penghu. The chief industry is fishing (whence the old Spanish name which has come into general use) and dried fish are exported.

PESCARA, FERNANDO FRANCESCO DAVALOS, MARQUIS OF (1480-1525), Italian *condottiere*, was born at Naples, his family being of Spanish origin. Rodrigo (Ruy) Lopez Davalos, his great-grandfather, a noble of Toledo, who had taken an active part in the civil wars of Castile in the reign of John II. (1407-1454), had been driven into exile, and died at Valencia. Ifigo (Ignatius), his son, entered the service of Alphonso of Aragon and Naples, followed his master to Italy, and there, making an advantageous marriage with a lady of the family of Aquino, was created marquis of Pescara. His son Alphonso, who succeeded him in the marquisate, married a lady of the Sicilian branch of the Spanish family of Cardona, and when he was treacherously killed, during a French invasion of Naples, his only son Fernando, or Ferrante, was a child in arms. At the age of six the boy was betrothed to Vittoria Colonna (*q.v.*), daughter of the general Fabrizio Colonna, and the marriage was celebrated in 1509. His position as a noble of the Aragonese party in Naples made it incumbent on him to support Ferdinand the Catholic in his Italian wars. In 1512 he commanded a body of light cavalry at the battle of Ravenna, where he was wounded and taken prisoner by the French. Thanks to the intervention of one of the foremost of the French generals, the Italian J. J. Trivulzio, who was his connexion by marriage, he was allowed to ransom himself for 6000 ducats. He commanded the Spanish infantry at the battle of La Morta, or Vicenza, on the 7th of October 1513. It was on this occasion that he called his men before the charge to take care to step on him before the enemy did if he fell. From the battle of Vicenza in 1513, down to the battle of La Bicocca on the 29th of April 1522, he continued to serve in command of the Spaniards and as the colleague rather than the subordinate of Prosper Colonna. It was only by the accident of his birth at Naples that Pescara was an Italian. He considered himself a Spaniard, spoke Spanish at all times, even to his wife, and was always surrounded by Spanish soldiers and officers. His opinion of the Italians as fighting men was unfavourable and was openly expressed. After the battle of La Bicocca Charles V. appointed Prosper Colonna commander-in-chief. Pescara, who considered himself aggrieved, made a journey to Valladolid in Spain, where the emperor then was, to state his own claims. Charles V., with whom he had long and confidential interviews, persuaded him to submit for the time to the superiority of Colonna. But in these meetings he gained the confidence of Charles V. His Spanish descent and sympathies marked him out as a safer commander of the imperial troops in Italy than an Italian could have been. When Francis I. invaded Italy in 1524 Pescara was appointed as lieutenant of the emperor to repel the invasion. The difficulties of his position were very great, for there was much discontent in the army, which was very ill paid. The tenacity, patience and tact of Pescara triumphed over all obstacles. His influence over the veteran Spanish troops and the German mercenaries kept them loyal during the long siege of Pavia. On the 24th of February 1525 he defeated and took prisoner Francis I. by a brilliant attack. Pescara's plan was remarkable for its audacity and for the skill he showed in destroying the superior French heavy cavalry by assailing them in flank with a mixed force of harquebusiers and light horse. It was believed that he was dissatisfied with the treatment he had received from the emperor; and Girolamo Morone, secretary to the duke of Milan, approached him with a scheme for expelling French, Spaniards and Germans alike from Italy, and for gaining a throne for himself. Pescara may have listened to the tempter, but in act he was loyal. He reported the offer to Charles V. and put Morone into prison. His health however had begun to give

way under the strain of wounds and exposure; and he died at Milan on the 4th of November 1525. Pescara had no children; his title descended to his cousin the marquis del Vasto, also a distinguished imperial general.

AUTHORITIES.—The life of Pescara was written in Latin by Paolo Giovio, and is included in the *Vitae illustrium virorum*, printed at Basel 1578. Giovio's Latin *Life* was translated by L. Domenichi, the translator of his other works, and published at Florence, 1531. The Spanish *Historia del fortissimo y prudentissimo capitán Don Fernando de Avalos*, by El Maestro F. Vallés (Antwerp, 1533), is also a translation of Giovio. See also Mignet, *Résumé de François I^{er} et de Charles Quint* (Paris, 1875), which gives references to all authorities. (D. H.)

PESCARA, a river of Italy, formed by the confluence of the Gizio and Aterno, and flowing into the Adriatic at the small town of Pescara. This town occupies the site of the ancient Aternum, the terminus of the Via Claudia Valeria, and up to 1867 a fortress of some importance. The railway from Sulmona follows the Pescara valley and joins the coast line to Brindisi at Pescara. In this valley, 22 m. from the sea, was the site of the ancient Interpromium, a town belonging probably to the Paeligni; and not far off is the very fine Cistercian abbey church of S. Clemente di Casauria, founded by the emperor Louis II. in 871. The present building belongs to the 12th century. The sculptures of the portals, the pulpit, the Paschal candelabrum, &c., and the bronze doors of this period are important. The chronicle of the abbey, of the end of the 12th century, is in the Bibliothèque nationale at Paris.

See V. Bindi, *Monumenti degli Abruzzi* (Naples, 1889), pp. 405 seq.; P. L. Calore in *Archivio storico dell' arte* (Rome, 1891), iv. 9 seq.

PESCHIERA SUL GARDA, a fortress of Venetia, Italy, in the province of Verona, on an island in the Mincio at its outlet from the lake of Garda, 77 m. by rail E. of Milan. It was one of the famous fortresses of the Quadrilateral, the chief bulwark of the Austrian rule in Italy until 1866 (Mantua, Legnago and Verona being the other three) and has played a prominent part in all the campaigns conducted in north Italy, more especially during the Napoleonic wars. It was taken by the Piedmontese from the Austrians, after a gallant defence by General Rath lasting six weeks, on the 30th of May 1848, and since that date has been in Italian hands.

PESGIA, a town of Tuscany, Italy, in the province of Lucca, from which it is 15 m. E.N.E. by rail, 203 ft. above sea-level. Pop. (1901), 12,400 (town); 18,000 (commune). The cathedral, restored in 1693, contains the fine chapel of the Turini family, built for Baldassare Turini (d. 1540) by Giuliano di Baccio di Florence, with his tomb by Raffaello da Montelupo. The town also has some buildings by Lazzaro Buggiano, the pupil and adoptive son of Brunelleschi. It has silk and paper manufactures.

PESETA, a silver coin and unit of value, the Spanish equivalent of the French, Belgian and Swiss *franc*, the Italian *lira* and the Greek *drachma* in the Latin monetary union. The *peso* (Lat. *pensum*, weight), of which *peseta* is a diminutive, was a Spanish coin of gold, *peso de oro*, or silver, *peso de plata*, once current in Spain and her colonies, and now the name of a silver coin of many South American states. The *peso* is also the name of the Mexican dollar.

PESHAWAR, a city of British India, the capital of the North-West Frontier Province, giving its name to a district. The city is situated near the left bank of the river Bara, 11 m. from Jamrud at the entrance of the Khyber Pass, the railway station being 1588 m. north-west of Calcutta; pop. (1901), 95,147. Two miles west of the native city are the cantonments, forming the principal military station of the North-West Frontier Province. Peshawar lies within a horseshoe ring of hills on the edge of the mountain barrier which separates India from Afghanistan, and through it have passed nearly all the invaders from the north. The native quarter is a huddle of flat-roofed houses within mud walls, crowded along narrow, crooked alleys; there is but one fairly wide street of shops. Here for many centuries the *Peshawars*, or Afghan travelling merchants, have brought their caravans from Kabul, Bokhara and Samarkand every autumn. They

bring horses, wool, woollen stuffs, silks, dyes; gold-thread, fruits, precious stones, carpets and poshtins (sheepskin clothing), fighting and buying their way to the British border where, leaving their arms, they are free to wander at will to Delhi, Agra and Calcutta. The chief speciality of Peshawar consists of bright-coloured scarves called *lanjis*; wax-cloth and ornamental needle-work are also local products, as well as knives and small arms.

The district of PESHAWAR has an area of 2611 sq. m.; pop. (1901), 788,707, showing an increase of 10.8% in the decade. Except on the south-east, where the Indus flows, it is encircled by mountains which are inhabited by the Mohmand, Utman Khel and Afridi tribes. The plain consists of alluvial deposits of silt and gravel. The district is naturally fertile and well watered, and is irrigated by the Swat River Canal. The principal crops are wheat, barley, maize, millets and oil-seeds, with a little cotton and sugar-cane. Peshawar also produces a fine variety of rice, known as "Bara rice," after the river which irrigates it. The North-Western railway crosses the district from Attock, and has been extended from Peshawar city to Jamrud for military purposes. The district is chiefly inhabited by Pathans; there are some Hindus engaged in trade as bankers, merchants and shop-keepers.

In early times the district of Peshawar seems to have had an essentially Indian population, for it was not till the 15th century that its present Pathan inhabitants occupied it. Under the name of Gandhara it was a centre of Buddhism, and especially Graeco-Buddhism. Rock-edicts of Asoka still exist at two places; and a *stupa* excavated in 1909 was found to contain an inscription of Kanishka, as well as relics believed to be those of Buddha himself. The last of the Indian Buddhist kings was conquered by Mahmud of Ghazni in 1009. The Mogul emperors always found difficulty in maintaining their authority over the Afghan border tribes, who finally established their independence during the reign of Aurangzeb. Peshawar was a favourite residence of the Afghan dynasty founded by Ahmed Shah Durrani, and here Mountstuart Elphinstone came as ambassador to Shah Shujah in 1809. A few years later Ranjit Singh crossed the Indus, and after much hard fighting Sikh authority was firmly established under General Avitabile in 1834. In 1848 the whole of the Punjab passed to the British. During the Mutiny, after the sepoy regiments had been disarmed, Peshawar was a source of strength rather than of danger, though Sir John Lawrence did at one time contemplate the necessity of surrendering it to the Afghans, in order to preserve the rest of Northern India.

PESHIN, or PISHIN, a district of Baluchistan. Area 2717 sq. m. Pop. (1901), 50,200. It consists of a large plain surrounded on three sides by hills, which formerly belonged to Afghanistan but was ceded to the British by the treaty of Gandamak in 1879. This plain is of considerable strategic importance, as it forms the focus of a great number of routes leading from Sind and the Punjab frontier districts to Kandahar, and is intersected by the Sind-Peshin railway. The agricultural wealth of Peshin, and consequently its revenues, have increased greatly under British administration.

PESHITTO, or PESHIRO (i.e. "simple"), the standard version of the Bible in the Syriac language. It was long supposed to be the original Syriac version, but is now generally recognized as representing a revision made by Rabbula, bishop of Edessa, early in the 5th century, an attempt at standardizing the Syriac text such as Jerome had made for the Latin in his Vulgate. (See **BIBLE**.)

PESHWA (Persian for "leader," "guide"), the title of the head of the Mahratta confederacy in India. Originally the peshwa was only prime minister, but afterwards he supplanted his master and became chief of the state, founding an hereditary dynasty, with the capital at Poona. The last peshwa, Bajji Rao, came into collision with the British, and was dethroned in 1818. His adopted son, Nana Sahib, took a leading part in the Mutiny of 1857, in revenge for being deprived of what he considered his rights.

PESSIMISM (from Lat. *pessimus*, worst), a word of modern coinage, denoting an attitude of hopelessness towards life, a vague general opinion that pain and evil predominate in human affairs. It is the antithesis of "optimism," which denotes the view that on the whole there is a balance of good and pleasure, or at least that in the long run good will triumph. Between optimism and pessimism is the theory of "meliorism," according to which the world on the whole makes progress in goodness. The average man is pessimist or optimist not on theoretical grounds, but owing to the circumstances of his life, his material prosperity, his bodily health, his general temperament. Perhaps the most characteristic example of unsystematic pessimism is the language of Ecclesiastes, who concludes that "all is vanity."

Pessimism and optimism have, however, been expressed in systematic philosophical forms, a brief summary only of which need here be given. Such systems have been elaborated chiefly by modern thinkers, but the germs of the ideas are found widely spread in the older Oriental philosophies and in pre-Christian European thought. Generally speaking, pessimism may be found in all pantheistic and materialistic systems. It is important, however, to point out an essential distinction. The thinker who sees man confronted by the infinite non-moral forces presumed by natural pantheism inevitably predominating over the finite powers of men may appear to the modern Christian theologian or to the evolutionist as a hopeless pessimist, and yet may himself have concluded that, though the future holds out no prospect save that of annihilation, man may yet by prudence and care enjoy a considerable measure of happiness. Pessimism, therefore, depends upon the individual point of view, and the term is frequently used merely in a condemnatory sense by hostile critics. The attitude of a man who denies the doctrine of immortality and rejoices in the denial is not strictly pessimistic. A Christian again may be pessimistic about the present; he must logically be optimistic about the future—a teleological view of the universe implies optimism on the whole; the agnostic may be indifferent to, or pessimistic, regarding the future, while exceedingly satisfied with life as he finds it.

This complex view of life is exemplified by Plato, whose general theory of idealism is entirely optimistic. In analysing the world of phenomena he necessarily takes a pessimistic view because phenomena are merely imitations more or less removed from reality, i.e. from the good. Yet the idealistic postulate of a *summum bonum* is in result optimistic, and this view predominated among the Stoics and the Neoplatonists. The Epicureans, on the other hand, were empirical pessimists. Man is able to derive a measure of enjoyment from life in spite of the non-existence of the orthodox gods; yet this enjoyment is on the whole negative, the avoidance of pain. A similar view is that of the ancient sceptics.

Oriental pessimism, at least as understood by Europeans, is best exemplified in Buddhism, which finds in human life sorrow and pain. But all pain and sorrow are incidental to the human being in his individual capacity. He who will cast aside the "Bonds," the "Intoxications," the "Hindrances," and tread the Noble Eightfold Path (see **BUDHISM**) which leads to Nirvana, will attain the ideal, the "Fruit of Arahatahip," which is described in terms of glowing praise in the Pali hymns. This, the original doctrine of the Buddha, though not adopted in the full sense by all his followers, is in fact at least as optimistic as any optimism of the West. To call it "pessimism" is merely to apply to it a characteristically Western principle according to which happiness is impossible without personality. The true Buddhist on the contrary looks forward with enthusiasm to this absorption into eternal bliss.

In Europe on the whole the so-called pessimistic attitude was commoner in the Teutonic north than in the Mediterranean basin. But even here the hopefulness as regards a future life, in which the inequalities of the present would be rectified, compensated for the gloomy fatalism with which the present was

¹ The earliest example given in the *New English Dictionary* is in S. T. Coleridge's *Letters* (1794).

regarded. The advent of Christianity, with its categorical assertion of future happiness for the good, to a large extent did away with pessimism in the true sense. In Leibnitz we find a philosophic or religious optimism, which saw in the universe the perfect work of a God who from all possibilities selected the best. Kant, though pessimistic as regards the actual man, is optimistic regarding his moral capacity. To Hegel similarly the world, though evil at any moment, progresses by conflict and suffering towards the good.

Passing over the Italian Leopardi we may notice two leading modern pessimists, Schopenhauer and von Hartmann. Schopenhauer emphasizes the pessimistic side of Hegel's thought. The universe is merely blind Will, not thought; this Will is irrational, purposeless and therefore unhappy. The world being a picture of the Will is therefore similarly unhappy. Desire is a state of unhappiness, and the satisfaction of desire is therefore merely the removal of pain. Von Hartmann's doctrine of the Unconscious is in many respects similar to Schopenhauer's doctrine of the Will. The Unconscious which combines Will and Reason is, however, primarily Will. The workings of this Will are irrational primarily, but, as in its evolution it becomes more rationalized and understands the whole meaning of the *Welschmerz*, it ultimately reaches the point at which the desire for existence is gone. This choice of final nothingness differs from that of Schopenhauer in being collective and not individual. The pessimism of Schopenhauer and Hartmann does not, however, exclude a certain ultimate mysticism, which bears some analogy to that of Buddhism.

Pessimism is naturally connected with materialist, optimism with idealist, views of life. The theories of the modern evolutionist school, however, have introduced into materialistic theory a new optimistic note in doctrines such as that of the survival of the fittest. Such doctrines regard the progress of humanity as on the whole tending to the greater perfection, and are markedly optimistic in contrast with earlier theories that progressive differentiation is synonymous with progressive decay. Similarly the cynical contempt which Nietzsche shows for morality and the conventional virtues is counterbalanced by the theory of the *Übermensch*, the highest type of manhood which by struggle has escaped from the ordinary weaknesses of normal humanity.

See James Sully, *Pessimism: A History and a Criticism* (1877); Caro, *Le Pessimisme au XIX^e siècle* (1878); Salus, *The Anatomy of Negation* (1886); Tulloch, *Modern Theories on Philosophy and Religion* (1884); William James, *The Will to Believe*; Dühring, *Der Werth des Lebens* (1865); Meyer, *Weltend und Welschmerz* (1872); E. Plücker, *Der moderne Pessimismus* (1875); Agnes Taubert (Hartmann), *Der Pessimismus und seine Gegner* (1873); Gass, *Optimismus und Pessimismus* (1876); Rehmke, *Die Philos. des Welschmerzes* (1876); Huber, *Der Pessimismus* (1876); von Golther, *Der moderne P.* (1878); Paulsen, *Schopenhauer, Hamlet, Mephistopheles* (1900); Kowalewski, *Studien zur Psychologie des P.* (1904).

PESSINUS (Πεσίνους, Πεσινός), an ancient city of Galatia in Asia Minor, situated on the lowest southern slope of Mt Dindymus, on the left bank of the river Sangarius, not far from its source. The ruins, discovered by Texier, lie round the village of Bala-Hissar, 8 or 9 m. S.E. of Sivri-Hissar. They include a theatre in partial preservation, but they have been mostly carried off to Sivri-Hissar, which is largely built out of them. Originally a Phrygian city, probably on the Persian "Royal Road," it became the capital of the Gallic tribe Tolistobogii and the chief commercial city of the district. It contained the most famous sanctuary of the mother of the gods (Cybele), who here went by the name of Agdistis, and was associated with the god Attis, as elsewhere with Sabazius, &c. Her priests were also princes, who bore rule not only in the city (the coinage of which, beginning about 100 B.C., was for long issued by them) but also in the country round, deriving a large revenue from the temple estates; but in the time of Strabo (A.D. 19-20) their privileges were much diminished. The high-priest always bore the god's name Attis. In the crisis of the second Punic War (205 B.C.), when the Romans lost faith in the efficacy of their own religion to save the state, the Senate, in compliance with an oracle in the Sibylline books to the effect that the foreign

foe could be driven from Italy if the Idaean Mother (Cybele) were brought from Pessinus to Rome, sent ambassadors to the town, who obtained the sacred stone which was the symbol of the goddess and brought it to Rome, where the worship of Cybele was established. But the goddess continued to be worshipped in her old home; her priests, the Galli, went out to welcome Manlius on his march in 189 B.C., which shows that the town was not yet in the hands of the Tolistobogii. Soon after this a splendid new temple of the goddess was built by the Pergamian kings. Some time before 164 B.C. Pessinus fell into the power of the Gauls, and the membership of the priestly college was then equally divided between the Gauls and the old priestly families. Like Ancyra and Taviium, Pessinus was Romanized first and Hellenized afterwards. Only about A.D. 165 did Hellenic ways and modes of thought begin to be assumed; before that we find a deep substratum of Celtic feeling and ways, on which Roman elements had been superimposed without filtering through a Hellenic medium. Christianity was introduced late; it cannot be traced before the 4th century. When Galatia was divided into two provinces (A.D. 386-395) Pessinus was made the capital of Galatia Secunda or Salutaris, and it became a metropolitan bishopric. After the 16th century it disappears from history, being supplanted, from the beginning of the period of Saracen invasion, by the impregnable fortress Justinianopolis (Sivri-Hissar), which became the capital and the residence of the bishop, thenceforward called "archbishop of Pessinus or of Justinianopolis." (J. G. C. A.)

PESTALOZZI, JOHANN HEINRICH (1746-1827), Swiss educational reformer, was born at Zürich on the 12th of January 1746. His father died when he was young, and he was brought up by his mother. At the university of Zürich he was associated with Lavater and the party of reform. His earliest years were spent in schemes for improving the condition of the people. The death of his friend Bluntschli turned him however from politics, and induced him to devote himself to education. He married at twenty-three and bought a piece of waste land at Neuhof in Aargau, where he attempted the cultivation of madder. Pestalozzi knew nothing of business, and the plan failed. Before this he had opened his farm-house as a school; but in 1780 he had to give this up also. His first book published at this time was *The Evening Hours of a Hermit* (1780), a series of aphorisms and reflections. This was followed by his masterpiece, *Leonard and Gertrude* (1781), an account of the gradual reformation, first of a household, and then of a whole village, by the efforts of a good and devoted woman. It was read with avidity in Germany, and the name of Pestalozzi was rescued from obscurity. The French invasion of Switzerland in 1798 brought into relief his truly heroic character. A number of children were left in Canton Unterwalden on the shores of the Lake of Lucerne, without parents, home, food or shelter. Pestalozzi collected a number of them into a deserted convent, and spent his energies in reclaiming them. During the winter he personally tended them with the utmost devotion, but in June 1799 the building was required by the French for a hospital, and his charges were dispersed. In 1801 Pestalozzi gave an exposition of his ideas on education in the book *How Gertrude teaches her Children*. His method is to proceed from the easier to the more difficult. To begin with observation, to pass from observation to consciousness, from consciousness to speech. Then come measuring, drawing, writing, numbers, and so reckoning. In 1799 he had been enabled to establish a school at Burgdorf, where he remained till 1804. In 1802, he went as deputy to Paris, and did his best to interest Napoleon in a scheme of national education; but the great conqueror said that he could not trouble himself about the alphabet. In 1805 he removed to Yverdon on the Lake of Neuchâtel, and for twenty years worked steadily at his task. He was visited by all who took interest in education—Talleyrand, Capo d'Istria, and Mme de Staël. He was praised by Wilhelm von Humboldt and by Fichte. His pupils included Ramsauer, Delbrück, Blochmann, Carl Ritter, Fröbel and Zeller. About 1815 dissections broke out among the teachers of the school, and Pestalozzi's last ten years were

chequered by weariness and sorrow. In 1825 he retired to Neubof, the home of his youth; and after writing the adventures of his life, and his last work, the *Swan's Song*, he died at Brugg on the 17th of February 1827. As he said himself, the real work of his life did not lie in Burgdorf or in Yverdon. It lay in the principles of education which he practised, the development of his observation, the training of the whole man, the sympathetic application of the teacher to the taught, of which he left an example in his six months' labours at Stanz. He had the deepest effect on all branches of education, and his influence is far from being exhausted.

Pestalozzi's complete works were published at Stuttgart in 1810-1826, and an edition by Seyffarth appeared at Berlin in 1881. Volumes on his life and teaching have been written by De Guimps (1839), Barnard (1862), Krüsi (1875) and Finloche (1901).

PETALITE, a mineral species consisting of lithium aluminium silicate, LiAl(SiO₃). The monoclinic crystals approach spodumene (q.v.) in form, which is also a lithium aluminium silicate with the formula LiAl(SiO₃). There is a perfect cleavage parallel to the basal plane, and the mineral usually occurs in platy cleavage masses; on this account it was named, from Gr. πέταλον (a leaf). The hardness is 6½ and the specific gravity 2.4 (that of spodumene being 3.16). The mineral is colourless or occasionally reddish, varies from transparent to translucent, and has a vitreous lustre. It was discovered in 1800 as cleavage masses in an iron mine on the island of Uûd in the Stockholm archipelago, where it is associated with lepidolite, tourmaline (rubellite and indicolite) and spodumene. A variety known as "castor" is found as transparent glassy crystals associated with pollux (q.v.) in cavities in the granite of Elba. (L. J. S.)

PETARD (Fr. *pétard*, *péter*, to make a slight explosion), a device formerly used by military engineers for blowing in a gate or other barrier. It consisted of a small metal or wooden case, usually of sugar-loaf shape, containing a charge of powder and fired by a fuse.

PETAU, DENYS (1583-1652), Jesuit scholar, better known as **DIONYSIUS PETAUVIUS**, was born at Orleans on the 21st of August 1582. Educated at Paris University, he came under the influence of Isaac Scaliger, who directed his attention towards the obscure fathers of the Church. In 1603 he was appointed to a lectureship at the university of Bourges, but resigned his place two years later, in order to enter the Society of Jesus. For many years he was professor of divinity at the Collège de Clermont, the chief Jesuit establishment in Paris; there he died on the 11th of December 1652. He was one of the most brilliant scholars in a learned age. Carrying on and improving the chronological labours of Scaliger, he published in 1627 an *Opus de doctrina temporum*, which has been often reprinted. An abridgment of this work, *Rationarium temporum*, was translated into French and English, and has been brought down in a modern reprint to the year 1849. But Petau's eminence chiefly rests on his vast, but unfinished, *De theologicis dogmatibus*, the first systematic attempt ever made to treat the development of Christian doctrine from the historical point of view.

PETCHENEGS, or **PATZINAKS**, a barbarous people, probably of Turkish race, who at the end of the 9th century were driven into Europe from the lower Ural, and for about 300 years wandered about the northern frontier of the East Roman Empire. (See **TURKS**).

PETER (Lat. *Petrus* from Gr. *πέτρος*, a rock, Ital. *Pietro*, *Piero*, *Pier*, Fr. *Pierre*, Span. *Pedro*, Ger. *Peter*, Russ. *Petr*), a masculine name, derived from the famous surname bestowed by Christ upon his apostle Simon ("Thou art Peter and upon this rock will I build my church," Matt. xiv. 17-19). The name has consequently been very popular in Christian countries. It is noteworthy, however, that, out of deference to the "prince of the apostles" and first bishop of Rome, the name has never been assumed by a pope. The biographies which follow are arranged in the order: (1) the apostle; (2) kings; (3) other eminent men.

PETER, ST, the chief of the Twelve Apostles. He is known also by other names: (a) "Simon" (Σίμων) in Mark four times and Luke seven times. This use is only found in narrative

before the story of the mission of the apostles: it is also found in speeches; Matthew once, Mark once and Luke twice. (b) "Simon who is called Peter" is found in Matthew twice and Acts four times. (c) "Simon Peter" is found in Matthew once, Luke once, John seventeen times (and perhaps also in 2 Peter i. 1, where the text varies between Simon and Symeon. (d) "Peter" is found in Matthew nineteen times, Mark eighteen times, Luke sixteen times, Acts fifty-one times, John fifteen times, Galatians twice, 1 Peter once. (e) "Cephas" is found in John once, Galatians four times, 1 Corinthians four times. (f) Symeon (Συμῶν) is found in Acts once. It appears that the apostle had two names, each existing in a double form—Greek and Hebrew, Symeon (שמעון) which was Graecized according to the sound into Simon, and Cephas (קפא) which was Graecized according to the meaning into Peter (Πέτρος). Symeon and Simon are both well-known names in Aramaic and Greek respectively, but Cephas and Peter are previously unknown. Symeon was no doubt his original Aramaic name, and the earliest gospel, Mark, which has some claim specially to reproduce Petrine tradition, is careful to employ Simon until after the name Peter had been given, and not then to use it again. The Gospels agree in regarding Cephas or Peter as an additional name, which was given by Christ. But they differ as to the occasion. According to Mark iii. 13 sqq. it was given on the occasion of the mission of the Twelve. According to John i. 42 it was given at his first call. According to Matt. xvi. 13 sqq. it was given after the recognition of Jesus as Messiah at Caesarea Philippi. This last account is the only one which describes any circumstances (for a further discussion see § 3 (2) below).

According to the Gospels Peter was the son of John (Ἰωάννης, John i. 42, xxi. 15 sqq.) or Jonas (Ἰωνᾶς, Matt. xvi. 17). According to Mark i. 29 he was a fisherman of Capernaum, but John i. 44 describes him and his brother Andrew as of Bethsaida. From Mark i. 30 he is seen to have been married, and 1 Cor. ix. 5 suggests (but another interpretation is possible) that his wife went with him on his missionary journeys. In 1 Pet. v. 13 Mark is referred to as his son, but this is usually interpreted of spiritual kinship. According to legend (*Acta Nerei et Achillei*, and *Acta Philippi*) he had a daughter Petronilla, but there is no reason for thinking that this is historical.

The Gospel narratives are unanimous in describing Peter as one of the first disciples of Christ, and from the time of his call he seems to have been present at most of the chief incidents in the narrative. He formed together with the sons of Zebedee to some extent an inner circle within the Twelve, and this favoured group is specially mentioned as present on three occasions—
—the raising of the daughter of Jairus (Mark v. 22-43; Matt. ix. 18-36; Luke viii. 41-56), the transfiguration (Mark ix. 2 sqq.; Matt. xvii. 1 sqq.; Luke ix. 28 sqq.) and the scene in the Garden at Gethsemane (Mark xiv. 32 sqq.; Matt. xxvi. 36 sqq.). He is also specially mentioned in connexion with his call (Mark i. 16-20; Matt. iv. 18 sqq.; Luke v. 1 sqq.; John i. 40 sqq.); the healing of his wife's mother (Mark i. 21 sqq.; Matt. viii. 14 sqq.; Luke iv. 38 sqq.); the mission of the Twelve Apostles (Mark iii. 13 sqq.; Matt. x. 1 sqq.; Luke vi. 12 sqq.); the storm on the Lake of Galilee (Mark vi. 45 sqq.; Matt. xiv. 22 sqq.; John vi. 16 sqq.); the Messianic recognition at Caesarea Philippi (Mark vii. 27 sqq.; Matt. xvi. 16 sqq.; Luke ix. 18 sqq.); the incident of the payment of tribute by the coin found in the fish caught by Peter (Matt. xvii. 25 sqq.) and with various questions leading to parables or their explanations (Mark xiii. 36 sqq.; Luke xii. 41; Matt. xviii. 21 sqq.; Mark x. 28; Matt. xix. 27; Luke xviii. 28). In the week of the Passion he appears in connexion with the incident of the withered fig-tree (Mark xi. 21; Matt. xxi. 20); as introducing the eschatological discourse (Mark xiii. 3 sqq.); and as prominent during the Last Supper (Luke xxii. 8 sqq.; John xiii. 4 sqq.; Mark xiv. 27 sqq.; Matt. xxvi. 31 sqq.). He

was present in Gethsemane, and tried to offer some resistance to the arrest of Jesus (Mark xiv. 47; Matt. xxvi. 51; Luke xiii. 50; John xviii. 10). After the arrest he followed the Lord to the scene of the trial, but denied him and fled. The message of the young man at the tomb (Mark xvi. 4) was especially addressed to Peter and it is clear that the genuine conclusion of Mark must have contained an account of an appearance of the risen Lord to him.

Out of this mass of incidents the following are central and call for closer critical consideration.

1. *The Call of St Peter.*—(Mark i. 16-20; Matt. iv. 18-22; Luke v. 1-11; John i. 40-42). The account in Matthew is practically identical with that in Mark and is no doubt taken from the Marcan source, but Luke and John have different traditions. The main points are as follows: according to Mark, at the beginning of the Galilean ministry Jesus saw Peter and Andrew fishing. He called them, and they joined him. After this he went with them to Capernaum, preached in the synagogue, and healed Peter's wife's mother. Luke, who certainly used Mark, has partly rearranged this narrative and partly rejected it in favour of a different version. According to him the visit to Capernaum and the healing of the wife's mother preceded the call of Peter, and this was associated with a tradition of a miraculous draught of fishes. The advantage of the Lucan reconstruction, so far as the first part is concerned, is that it supplies a reason for Peter's ready obedience, which is somewhat difficult to understand if he had never seen Jesus before. But it seems probable that this is the motive which led to the redactorial change in Luke, and that the Marcan account, which is traditionally connected with Peter, ought to be followed. With regard to the narrative of the miraculous draught of fishes, the matter is more complicated. Luke obviously preferred this narrative to the Marcan account, but the fact that the same story comes in John xxi. suggests that there was an early tradition of some such incident of which the actual occasion and circumstances were undetermined. Luke preferred to connect it with the call of Peter, the writer of John xxi. with his restitution: probably both are of the nature of redactorial guesses, and the Marcan account must be regarded as preferable to either. The Johannine account of the call of Peter is quite different. According to this it took place immediately after the baptism of Jesus, in Judaea not in Galilee. It is connected with the giving of the name Peter, which in Mark was not given until much later.

2. *The Confession of Peter at Caesarea Philippi.*—(Mark viii. 27-33; Matt. xvi. 13-23; Luke ix. 18-22). According to Mark, Peter, in answer to the question of Jesus, recognized that He was the Messiah, but protested against the prophecy of suffering which Jesus then added. This narrative is followed, with the exception of the last part, by Luke, who as usual is inclined to omit anything which could be regarded as derogatory to the Apostles. Matthew also uses the Marcan narrative, but adds to it a new section from some other source which suggests that the name of Peter was conferred on this occasion—not, as Mark says, at the first mission of the Twelve—and confers on him the keys of the kingdom of heaven and the right of binding and loosing. This must be probably¹ interpreted as a reference to the prophecy concerning Eliakim in Isa. xlii. 22, and to technical use of the words "binding" and "loosing" by the scribes in authoritative decisions as to the obligations of the law. It thus confers on Peter a position of quite unique authority. It must, however, be noted that the power of binding and loosing is given in Matt. xviii. 18 to the whole body of disciples. This seems to be an alternative version, also found only in Matthew. The question of the historical character of the Matthean addition to the Marcan narrative is exceedingly difficult; but it

¹ See, however, A. Sulzbach's article in the *Zeitschr. f. N.T. Wiss.* (1903), p. 190. He thinks there is an allusion to a room in the Temple where the great key was kept; this room was called Kephas, because the key was placed in a recess closed by a stone. There is also a valuable article by W. Köhler in the *Archiv für Religionswiss.* treating the question of the keys from the point of view of comparative religion.

is hard to think that if it were really authentic it would have been omitted from all the other gospels, and it perhaps belongs to the little group of passages in Matthew which seem to represent early efforts towards church legislation, rather than a strictly historical narrative. Besides it is noticeable that in one other point Matthew has slightly remodelled the Marcan narrative. According to the latter Jesus asked, "Whom say men that I am?" and Peter replied "the Messiah," without qualification. But in Matthew the question is changed into "Whom say men that the Son of Man is?" and, whatever may be the original meaning of the phrase "the son of man" it cannot be doubted that in the gospels it means Messiah. Thus the simple answer of Peter in Mark would be meaningless, and it is replaced by "The Messiah, the son of the living God," which is no longer a recognition of the Messiahship of Jesus (this is treated in Matthew as an already recognized fact, cf. x. 23, xii. 40, &c.), but is a definition and an exaltation of the nature of the Messiah.

3. *The Conduct of Peter after the Betrayal.*—The consideration of this point brings one into touch with the two rival traditions as to the conduct of the disciples after the betrayal and crucifixion of the Lord—the Galilean and the Jerusalem narratives. There is one incident which must in any case be accepted as it is found in both narratives. This is the denial of Peter. It appears that Peter did not stay with the disciples and neither returned home immediately to Galilee (according to the Galilean tradition) nor sought hiding in Jerusalem (according to the Jerusalem tradition), but followed the Lord at a distance and was a witness of at least part of the trial before the Sanhedrim. He was detected and accused of being a disciple, which he denied, and so fulfilled the prophecy of Jesus that he would deny Him before the cock crowed.

But putting this incident aside, the Galilean and Jerusalem traditions do not admit of reconciliation with one another. The former is represented by Mark. According to it the disciples all fled after the betrayal (though Peter waited until after the denial), and afterwards saw the risen Lord in Galilee. The details of this narrative are unfortunately lost, as the genuine conclusion of Mark is not extant. But Mark xiv. 28 and xvi. 7 clearly imply a narrative which described how the disciples returned to Galilee, there saw the risen Lord, and perhaps even how they then returned to Jerusalem in the strength of their newly recovered faith, and so brought into existence the church of Jerusalem as we find it in the Acts. It is also clear from Mark xvi. 7 that Peter was in some special way connected with this appearance of the risen Lord, and this tradition is confirmed by 1 Cor. xv. 5, and perhaps by Luke xxiv. 34.

The Jerusalem narrative is represented especially by Luke and John (excluding John xxi. as an appendix). According to this the disciples, though they fled at the betrayal, did not return to their homes, but remained in Jerusalem, saw the risen Lord in that city, and stayed there until after the day of Pentecost. Attempts to reconcile these two narratives seem to be found in Matthew and in John xxi.

Obviously the choice which has to be made between these traditions cannot be adequately discussed here: it must suffice to say that intrinsic and traditional probability seem to favour the Galilean narrative. If so, one must say that after the denial Peter returned to Galilee—probably to resume his trade of fishing—and he there saw the risen Lord. This appearance is referred to in 1 Cor. xv. 5, and was certainly described in the lost conclusion of Mark. An account of it is preserved in John xxi., but it is here connected—probably wrongly—with a miraculous draught of fishes, just as the account of his call is in Luke.

Immediately after the resurrection there is a missing link in the history of Peter. We know that he saw the risen Lord, and, according to the most probable view, that this was in Galilee; but the circumstances are unknown, and we have no account of his return to Jerusalem, as at the beginning of the Acts the disciples are all in Jerusalem, and the writer, in contradiction to the Marcan or Galilean narrative, assumes that they had never left it. The first part of the Acts is largely concerned with

History after the Resurrection according to the Acts and Epistles.

the work of Peter. He appears as the recognized leader of the Apostles in their choice of a new member of the Twelve to take the place of Judas Iscariot (Acts i. 15 sqq.); on the day of Pentecost he seems to have played a prominent part in explaining the meaning of the scene to the people (Acts ii. 14 sqq.); and soon afterwards was arrested by the Jews on the charge of being a ring-leader in the disorders caused by the healing of the lame man at the "Beautiful" gate of the temple, but was released. After this he appears as the leader of the apostles in the story of Ananias and Sapphira, who perished at his rebuke for their duplicity (Acts v. 1-11). The last episode of this period is another arrest by the priests, which ended in his being scourged and released (Acts v. 17 sqq.).

After this Peter's attention was directed to the growth of Christianity in Samaria, and he and John made a journey of inspection through that district, laying hands on those who had been baptized in order that they might receive the Holy Spirit. Here Simon Magus (*g.s.*) was encountered. He was a magician who had been converted by Philip and baptized; he desired to obtain the power of conferring the Spirit, and offered Peter money for this purpose, but was indignantly repulsed. After this Peter and John returned to Jerusalem.

During the following stay in Jerusalem, the duration of which is not defined, Peter was visited by Paul (Acts ix. 26-29, Gal. i. 18), and a comparison of the chronological date afforded by Gal. i. and ii. points to a year not earlier than 33 (Harnack) or later than 38 (C. H. Turner) for this meeting. According to Galatians, Paul saw none of the apostles on this occasion except Peter and James: it is therefore probable that none of the others were then in Jerusalem.

After this Peter made another journey, visiting especially Lydda, Joppa and Caesarea. His stay at Lydda was marked by the healing of Aeneas (Acts ix. 32-4) and at Joppa by the resuscitation of Tabitha or Dorcas. While at Joppa he stayed with Simon the tanner, and thence was summoned to Caesarea to Cornelius the centurion. He hesitated whether to go, but was persuaded by a vision and the injunction to call nothing unclean which God had cleansed. Cornelius was accordingly baptized. This is an important incident, as being the first admission of a Gentile into the church: but he was already "God-fearing," *φοβούμενος τὸν θεόν* (Acts x. 1), which probably denotes some sort of connexion with the Jewish synagogue, though it is difficult to say exactly what it was. After this incident Peter returned to Jerusalem. The members of the Church were somewhat shocked at the reception of a Gentile: their view apparently was that the only road to Christianity was through Judaism. They were, however, persuaded by Peter's speech (Acts xi. 4-17); but it is uncertain how far their concession went, and in the light of subsequent events it is probable that they still regarded circumcision as a necessary rite for all Christians.

After the return of Peter to Jerusalem the most important events were the famine at Jerusalem, and the persecution of the Church by Herod. During the latter Peter was put in prison (Acts xii. 3 sqq.), but was released by an angel; he first went to the house of Mary, the mother of John Mark, and afterwards went to "another place." This expression has been interpreted to mean another town, and even to be an implied reference to Rome. This last suggestion, improbable though it be, is historically important. The persecution of Herod seems to have been in his last year, which was probably A.D. 43-44. There was a marked tendency to make the duration of Peter's episcopate at Rome twenty-five years: and a combination of this tendency with the explanation that the *ἔτερος τόπος* was Rome probably is the origin of the traditional dating of the martyrdom of Peter in A.D. 67-68. There is, however, no justification for this view, and *ἔτερος τόπος* need not mean more than another house in Jerusalem.

The famine referred to in Acts xi. 27 sqq. probably began before the death of Herod, but it continued after his death, and the relief sent by the church at Antioch to Jerusalem through Paul and Barnabas probably arrived about the year 45. It is not stated in the Acts that Peter was present, and it is therefore

usually assumed that he was absent, but Sir W. M. Ramsay has argued in his *St Paul the Traveller* that the visit of Paul to Jerusalem with the famine relief is the meeting between Paul and Peter referred to in Gal. ii. as the occasion of an agreement between them as to the preaching of the gospel to Jews and Gentiles. This view is not generally accepted, but it has the great advantage of avoiding the difficulty that otherwise Paul in Gal. ii. 1 sqq. must describe as his second visit to Jerusalem what was really his third. According to Ramsay, then, Peter was present during the famine, and made a private agreement with Paul that the latter should preach to the Gentiles, and so far Gentile Christianity was recognized, but the conditions of the intercourse between Gentile and Jewish Christians were not defined, and the question of circumcision was perhaps not finally settled. According to the more popular view the description in Gal. ii. applies to Acts xv. the so-called council of Jerusalem. This council met after the first missionary journey (*c.* A.D. 49) of Paul to discuss the question of the Gentiles. Peter, who was present, adopted the view that Gentile Christians were free from the obligation of the law, and this view was put into the form of the so-called Apostolic decrees by James (Acts xv. 23 sqq.).

The next information which we have about Peter is given in Gal. ii. 11 sqq. According to this he went to Antioch and at first accepted the Gentile Christians, but afterwards drew back and was rebuked by Paul. On the ordinary interpretation this must have taken place after the council, and it is exceedingly difficult to reconcile it with the attitude of Peter described in Acts xv., so that Mr C. H. Turner thinks that in this respect the account in Gal. ii. is not chronological, and places the visit of Peter to Antioch before the council. If, however, we take the theory of Sir W. M. Ramsay the matter is simpler. We thus get the compact between Paul and Peter during the famine, then a visit of Peter to Antioch, during which Peter first adopted and afterwards drew back from the position which he had agreed to privately.

This vacillation may then have been one of the causes which led up to the council, which may have been held before, not, as is usually thought, after the sending of the Epistle ^{History} after the Council of Jerusalem. There are, however, various traditions of importance. The following points are noteworthy. 1 Cor. i. 12 suggests the possibility that Peter went to Corinth, as there was a party there which used his name. It is, however, possible that this party had merely adopted the principles which, as they had been told, perhaps falsely, were supported by the leader of the Twelve. Dionysius of Corinth (*c.* 170) states that Peter was in Corinth. This may represent local tradition or may be an inference from 1 Cor. i. 12. 1 Peter suggests a ministry in the provinces of Asia Minor. There is, of course, nothing improbable in this, and even if 1 Peter be not authentic, it is early evidence for such a tradition, but it is also possible that Peter wrote to converts whom he had not personally made. This tradition is found in Origen (*Eus. H.E.* iii. 1), Epiphanius (*Haer.* xxvii., vi.), Jerome (*De Vir. ill.* 1) and other later writers; but it is possible that it is merely an inference from the epistle. Early tradition connects Peter with Antioch, of which he is said to have been the first bishop. The first writer to mention it is Origen (*Hom. vi. in Lucam*), but it is also found in the Clementine *Homilies and Recognitions* (*Hom.* 20, 23; *Recog.* 10, 68) and probably goes back to the lists of bishops which were drawn up in the 2nd century. Other important references to this tradition are found in *Eus. H.E.* iii. 26, 2; *Apost. Const.* vii. 46; Jerome, *De Vir. ill.* 1; *Chronicon paschale*; and *Liber pontificalis*. The tradition of work in Antioch may well be historical. Otherwise it is a rather wild elaboration of Gal. ii. 11. The most important and widespread tradition is that Peter came to Rome; and though this tradition has often been bitterly attacked, it seems to be probable that it is at least in outline quite historical. The evidence for it is earlier and better than that for any other tradition, though it is not quite convincing.

The earliest witness to a residence of Peter in Rome is probably

1 Peter, for (see *PETER, EPISTLES OF*) it is probable that the reference to Babylon ought to be interpreted as meaning Rome. If so, and if the epistle be genuine, this is conclusive evidence that Peter was in Rome. Even if the epistle be not genuine it is evidence of the same tradition. Nor is corroboration lacking: Clement (c. A.D. 97) refers to Peter and Paul as martyrs (1 *Clem.* 5-6) and says that "To these men . . . there was gathered a great company of the elect who . . . became an example to us." This points in two ways to a martyrdom of Peter in Rome, (1) because Peter and Paul are co-ordinated, and it is generally admitted that the latter suffered in Rome, (2) because they seem to be joined to the great company of martyrs who are to be an example to the Church in Rome. Similarly Ignatius (c. A.D. 115) says to the Romans (*Rom. iv.*), "I do not command you as Peter and Paul." The suggestion obviously is that the Romans had been instructed by these Apostles. By the end of the 2nd century the tradition is generally known: Irenaeus (3, 1, 1), Clement of Alexandria (comment. on 1 Peter), Origen (*Hom. vi. in Lucam*), Tertullian (*Scorp.* 15, and several passages) are explicit on the point, and from this time onwards the tradition is met with everywhere. There is also a tradition, found in Irenaeus (3, 1, 1) and in many later writers, and supported by 1 Pet. v. 13, and by the statements of Papias (*Eus. H. E.* 3, 39, 15) that Mark acted as Peter's assistant in Rome and that his gospel is based on recollections of Peter's teaching.

This evidence is probably sufficient to establish the fact that Peter, like Paul, had a wide missionary career ending in a violent death at Rome, though the details are not recoverable. The chronological question is more difficult both as regards the beginning and the end of this period of activity.

The Acts, in describing the visits of Peter to Samaria, Joppa, Lydda and Caesarea, justify the view that his missionary activity began quite early. Gal. ii. 11 and 1 Cor. ix. 5 show that Acts minimizes rather than exaggerates this activity; the Antiochian tradition probably represents a period of missionary activity with a centre at Antioch; similarly the tradition of work in Asia is possibly correct as almost certainly is that of the visit to Rome. But we have absolutely no evidence justifying a chronological arrangement of these periods. Even the silence of Paul in the epistles of the captivity proves nothing except that Peter was not then present; the same is true of 2 Tim. even if its authenticity be undoubted.

The evidence as to the date of his death is a little fuller, but not quite satisfactory. The earliest direct witness is Tertullian, who definitely states that Peter suffered under Nero by crucifixion. Origen also relates the latter detail and adds that at his own request Peter was crucified head downwards. Probably John xxi. 18 seq. is a still earlier reference to his crucifixion. Fuller evidence is not found until Eusebius, who dates the arrival of Peter at Rome in 43 and his martyrdom twenty-five years later. But the whole question of the Eusebian chronology is very confused and difficult, and the text of the *Chronicon* is not certain. The main objection to this date is based partly on general probability, partly on the language of Clement of Rome. It is more probable on general grounds that the martyrdom of Peter took place during the persecution of Christians in 64, and it is urged that Clement's language refers to this period. It is quite possible that an error of a few years has crept into the Eusebian chronology, which is probably largely based on early episcopal lists, and therefore many scholars are inclined to think that 64 is a more probable date than 67. As a rule the discussion has mainly been between these two dates, but Sir W. M. Ramsay, in his *Church in the Roman Empire*, has adopted a different line of argument. He thinks that 1 Peter was written c. A.D. 80, but that it may nevertheless be Petrine; therefore he lays stress on the fact that whereas the tradition that Peter was in Rome is early and probably correct, the tradition that he was martyred under Nero is not found until much later. Thus he thinks it possible that Peter survived until c. 80, and was martyred under the Flavian emperors. The weak point of this theory is that Clement and Ignatius bring Peter and Paul

together in a way which seems to suggest that they perished, if not together, at least at about the same time. If this view be rejected and it is necessary to fall back on the choice between 64 and 67, the problem is perhaps insoluble, but 64 has somewhat more intrinsic probability, and 67 can be explained as due to an artificial system of chronology which postulated for Peter an episcopate of Rome of twenty-five years—a number which comes so often in the early episcopal lists that it seems to mean little more than "a long time," just as "forty years" does in the Old Testament. On the whole 64 is the most probable date, but it is very far from certain: the evidence is insufficient to justify any assurance.

For further information and discussion see especially Harnack's *Chronologie*, and Bishop Chase's article in *Hastings's Dictionary of the Bible*. The latter is in many ways the most complete statement of the facts at present published.

Caius, who lived in the beginning of the 3rd century (see *Eus. H. E.* 2, 25), stated that the *τφορα* (i.e. probably the burial place, not that of execution) of Peter and Paul were on the Vatican. This is also found in the *Acta Petri, The Grave of Peter.* 84 (in the *Lit. Pont.*, ed. Duchesne, p. 52 seq., 118 sqq.). From this place it appears that the relics (whether genuine or not) were moved to the catacombs in A.D. 258 (cf. the *Depositio martyrum*, and see Lightfoot's *Clement*, i. 249); hence arose the tradition of an original burial in the catacombs, found in the Hieronymian Martyrology.

For further information and investigations see Duchesne, *Liber pontificalis*; Lipsius, *Die Apokr. Apostelgesch.*; and Erbes "Die Todestage der Apostel Paulus u. Petrus," in *Texte und Untersuchungen*, N.F., iv. 1. (K. L.)

PETER I., called "the Great" (1672-1725), emperor of Russia, son of the tsar Alexius Mikhailovich and Natalia Nariakhina, was born at Moscow on the 30th of May 1672. His earliest teacher (omitting the legendary Scotchman Menzies) was the *dyak*, or clerk of the council, Nikita Zotov, subsequently the court fool, who taught his pupil to spell out the liturgical and devotional books on which the children of the tsar were generally brought up. After Zotov's departure on a diplomatic mission, in 1680, the lad had no regular tutor. From his third to his tenth year Peter shared the miseries and perils of his family. His very election (1682) was the signal for a rebellion. He saw one of his uncles dragged from the palace and butchered by a savage mob. He saw his mother's beloved mentor, and his own best friend, Artamon Matvyev, torn, bruised and bleeding, from his retaining grasp and hacked to pieces. The haunting memories of these horrors played havoc with the nerves of a supersensitive child. The convulsions from which he suffered so much in later years must be partly attributed to this violent shock. During the regency of his half-sister Sophia (1682-1689) he occupied the subordinate position of junior tsar, and after the revolution of 1689 Peter was still left pretty much to himself. So long as he could indulge freely in his favourite pastimes—ship-building, ship-sailing, drilling and sham fights—he was quite content that others should rule in his name. He now found a new friend in the Swiss adventurer, François Lefort, a shrewd and jovial rascal, who not only initiated him into all the mysteries of profligacy (at the large house built at Peter's expense in the German settlement), but taught him his true business as a ruler. His mother's attempt to wear her prodigal son from his dangerous and mostly disreputable pastimes, by forcing him to marry the beautiful but stupid Eudoxia Lopukhina (Jan. 27, 1689), was a disastrous failure. The young couple were totally unsuited to each other. Peter practically deserted his unfortunate consort a little more than a year after their union.

The death of his mother (Jan. 25, 1694) left the young tsar absolutely free to follow his natural inclinations. Tiring of the great lake at Pereyaslavl, he had already seen the sea for the first time at Archangel in July 1683, and on the 1st of May 1694 returned thither to launch a ship built by himself the year before. Shortly afterwards he nearly perished during a storm in an adventurous voyage to the Solovetsky Islands in

the White Sea. His natural bent was now patent. From the first the lad had taken an extraordinary interest in the technical and mechanical arts, and their application to military and naval science. He was taught the use of the astrolabe (which Prince Yakov Dolgoruki, with intent to please, had brought him from Paris) by a Dutchman, Franz Timmerman, who also instructed him in the rudiments of geometry and fortifications. He had begun to build his own boats at a very early age, and the ultimate result of these pastimes was the creation of the Russian navy. He had already surrounded himself with that characteristically Petrine institution "the jolly company," or "the company," as it was generally called, consisting of all his numerous personal friends and casual acquaintances. "The company" was graduated into a sort of mock hierarchy, political and ecclesiastical, and shared not only the orgies but also the labours of the tsar. Merit was the sole qualification for promotion, and Peter himself set the example to the other learners by gradually rising from the ranks. In 1695 he had only advanced to the post of "skipper" in his own navy and of "bombardier" in his own army. It was, however, the disreputable Lefort who, for the sake of his own interests, diverted the young tsar from mere pleasure to serious enterprises, by persuading him first to undertake the Azov expedition, and then to go abroad to complete his education.

By this time the White Sea had become too narrow for Peter, and he was looking about him for more hospitable waters. The Baltic was a closed door to Muscovy, and the key to it was held by Sweden. The Caspian remained; and it had for long been a common saying with foreign merchants that the best way of tapping the riches of the Orient was to secure possession of this vast inland lake. But so long as the Turks and Tatars made the surrounding steppes uninhabitable the Caspian was a possession of but doubtful value. The first step making for security was to build a fleet strong enough to provide against the anarchical condition of those parts; but this implied a direct attack not only upon the Crimean khan, who was mainly responsible for the conduct of the Volgan hordes, but upon the khan's suzerain, the Turkish sultan. Nevertheless Peter did not hesitate. War against Turkey was resolved upon, and Azov, the chief Turkish fortress in those regions, which could be approached by water from Moscow, became the Russian objective. From the 8th of July to the 22nd of September 1695 the Muscovites attempted in vain to capture Azov. On the 22nd of November Peter re-entered Moscow. His first military expedition had ended in unmitigated disaster, yet from this disaster is to be dated the reign of Peter the Great.

Immediately after his return he sent to Austria and Prussia for as many sappers, miners, engineers and carpenters as money could procure. He meant to build a fleet strong enough to prevent the Turkish fleet from relieving Azov. The guards and all the workmen procurable were driven, forthwith, in bands, to all the places among the forests of the Don to fell timber and work day and night, turning out scores of vessels of all kinds. Peter himself lived among his workmen, himself the most strenuous of them all, in a small two-roomed wooden hut at Voronezh. By the middle of April two warships, twenty-three galleys, four fireships and numerous smaller craft were safely launched. On the 3rd of May "the sea caravan" sailed from Voronezh, "Captain Peter Aleksyevich" commanding the galley-botilla from the galley "Principium," built by his own hand. The new Russian fleet did all that was required of it by preventing the Turks from relieving Azov by water, and on the 18th of July the fortress surrendered. Peter now felt able to advance along the path of progress with a quicker and a firmer step. It was resolved to consolidate the victory by establishing a new naval station at the head of the Sea of Azov, to which the name of Taganrog was given. But it was necessary to guarantee the future as well as provide for the present. Turkey was too formidable to be fought single-handed, and it was therefore determined to send a grand embassy to the principal western powers to solicit their co-operation against the Porte. On the 10th of March 1697 this embassy, under the

leadership of Lefort, set out on its travels. Peter attached himself to it as a volunteer sailorman, "Peter Mikhailov," so as to have greater facility for learning ship-building and other technical sciences. As a political mission it failed utterly, the great powers being at that period far more interested in western than in eastern affairs. But personally Peter learnt nearly all that he wanted to know—gunnery at Königsberg, ship-building at Saardam and Deptford, anatomy at Leiden, engraving at Amsterdam—and was proceeding to Venice to complete his knowledge of navigation when the revolt of the *stryeltsy*, or musketeers (June 1698), recalled him to Moscow. This revolt has been greatly exaggerated. It was suppressed in an hour's time by the tsar's troops, of whom only one man was mortally wounded, and the horrible vengeance (September-October 1698) which Peter on his return to Russia wreaked upon the captive musketeers was due not to any actual fear of these antiquated warriors, but to his consciousness that behind them stood the reactionary majority of the nation who secretly sympathized with, though they durst not assist, the rebels.

Peter's foreign tour had more than ever convinced him of the inherent superiority of the foreigner. Imitation had necessarily to begin with externals, and Peter at once fell foul of the long beards and Oriental costumes which symbolized the arch-conservatism of old Russia. On the 26th of April 1698 the chief men of the tsardom were assembled round his wooden hut at Preobrazhenskoye, and Peter with his own hand deliberately clipped off the beards and moustaches of his chief boyars. The *skas* of the 1st of September 1698 allowed as a compromise that beards should be worn, but a graduated tax was imposed upon their wearers. The wearing of the ancient costumes was forbidden by the *skas* of the 4th of January 1700; thenceforth Saxon or Magyar jackets and French or German hose were prescribed. That the people themselves did not regard the reform as a trifle is plain from the numerous rebellions against it. By the *skas* of the 20th of December 1699 it was next commanded that henceforth the new year should not be reckoned, as heretofore, from the 1st of September, supposed to be the date of the creation, but from the first day of January, *anno domini*.

The year 1700 is memorable in Russian history as the starting-point of Peter's long and desperate struggle for the hegemony of the north. He had concluded peace with the Porte (June 13, 1700) on very advantageous terms, in order to devote himself wholly to a war with Sweden to the end that Russia might gain her proper place on the Baltic. The possession of an ice-free seaboard was essential to her natural development; the creation of a fleet would follow inevitably upon the acquisition of such a seaboard; and she could not hope to obtain her due share of the trade and commerce of the world till she possessed both. All the conjunctures seemed favourable to Peter. The Swedish government was in the hands of an untried lad of sixteen; and the fine fleets of Denmark, and the veteran soldiers of Saxony, were on the same side as the myriads of Muscovy. It seemed an easy task for such a coalition to wrest the coveted spoil from the young Charles XII.; yet Peter was the only one of the three conspirators who survived the Twenty-one Years' War in which they so confidently embarked during the summer of 1701. He was also the only one of them who got anything by it. Charles's "immersion in the Polish bog" (1702-1707), as Peter phrased it, enabled the tsar, not without considerable expense and trouble, to conquer Ingria and lay the foundations of St Petersburg. In these early days Peter would very willingly have made peace with his formidable rival if he had been allowed to retain these comparatively modest conquests. From 1707 to 1709 the war on his part was purely defensive; Charles would not hear of peace till full restitution had been made and a war indemnity paid, while Peter was fully resolved to perish rather than surrender his "paradise," Petersburg. After Pultava (June 26, 1709), Peter, hitherto commendably cautious even to cowardice, but now puffed up with pride, rashly plunged into as foolhardy an enterprise as ever his rival engaged in. The campaign of the Pruth (March to July 1711) must have been fatal to the

tsar but for the incalculable behaviour of the omnipotent grand vizier, who let the Russian army go at the very instant when it lay helpless in the hollow of his hand. Even so, Peter, by the peace of the Pruth, had to sacrifice all that he had gained by the Azov expedition fifteen years previously. On receiving the tidings of the conclusion of the peace of Nystad (August 30, 1721), Peter declared, with perfect justice, that it was the most profitable peace Russia had ever concluded. The gain to Russia was, indeed, much more than territorial. In surrendering the pick of her Baltic provinces, Sweden had surrendered along with them the hegemony of the north, and all her pretensions to be considered a great power.

The Great Northern War was primarily a training school for a backward young nation, and in the second place a means of multiplying the material resources of a nation as poor as she was backward. During the whole course of it the process of internal domestic reformation had been slowly but unceasingly proceeding. Brand-new institutions on Western models were gradually growing up among the cumbrous, antiquated, worn-out machinery of old Muscovy; and new men, like Menshikov, Goloykin, Apraksin, Osterman, Kurakin, Tolstoy, Shafirov, Prokopovich, Yaguzhinsky, Yavorsky, all capable, audacious, and brimful of new ideas, were being trained under the eye of the great regenerator to help him to carry on his herculean task. At first the external form of the administration remained much the same as before. The old dignities disappeared of their own accord with the deaths of their holders, for the new men, those nearest to Peter, did not require them. "The Administrative Senate" was not introduced till 1711, and only then because the interminable war, which required Peter's prolonged absence from Russia, made it impossible for him to attend to the details of the domestic administration. Still later came the "Spiritual Department," or "Holy Synod" (January 1721), which superseded the ancient patriarchate. It was established, we are told, "because simple folks cannot distinguish the spiritual power from the sovereign power, and suppose that a supreme spiritual pastor is a second sovereign, the spiritual authority being regarded as higher and better than the temporal." From the first the regenerator in his *ukazes* was careful to make everything quite plain. He was always explaining why he did this or that, why the new was better than the old, and so on; and we must recollect that these were the first lessons of the kind the nation had ever received. The whole system of Peter was deliberately directed against the chief evils from which old Muscovy had always suffered, such as dissipation of energy, dislike of co-operation, absence of responsibility, lack of initiative, the tyranny of the family, the insignificance of the individual. The low social morality of all classes, even when morality was present at all, necessitated the regeneration of the nation against its will, and the process could therefore only be a violent one. Yet the most enlightened of Peter's contemporaries approved of and applauded his violence, some of them firmly believed that his most energetic measures were not violent enough. Thus Ivan Poroshkov, Peter's contemporary, the father of Russian political economy, writes as follows: "If any land be over-much encumbered with weeds, corn cannot be sown thereon unless the weeds first be burned with fire. In the same way, our ancient inveterate evils should also be burnt with fire." Peter himself carried this principle to its ultimate limits in dealing with his unfortunate son the Tsarevich Alexius (q.v.). From an ethical and religious point of view the deliberate removal of Alexius was an abominable, an inhuman crime: Peter justified it as necessary for the welfare of the new Russia which he had called into existence.

The official birthday of the Russian empire was the 22nd of October 1721, when, after a solemn thanksgiving service in the Troitsa Cathedral for the peace of Nystad, the tsar proceeded to the senate and was there acclaimed: "Father of the Fatherland, Peter the Great, and Emperor of All Russia." Some Russians would have preferred to proclaim Peter as emperor of the East; but Peter himself adopted the more patriotic title.

Towards the end of the reign the question of the succession to the throne caused the emperor some anxiety. The rightful heir, in the natural order of primogeniture, was the little grand duke Peter, son of the Tsarevich Alexius, a child of six; but Peter decided to pass him over in favour of his own beloved consort Catherine. The *ustav*, or ordinance of 1722, heralded this unheard-of innovation. Time-honoured custom had hitherto reckoned primogeniture in the male line as the best title to the Russian crown, in the *ustav* of 1722 Peter denounced primogeniture in general as a stupid, dangerous, and even unscriptural practice of dubious origin. The *ustav* was but a preliminary step to a still more sensational novelty. Peter had resolved to crown his consort empress, and on the 15th of November 1723 he issued a second manifesto explaining at some length why he was taking such an unusual step. That he should have considered any explanation necessary demonstrates that he felt himself to be treading on dangerous ground. The whole nation listened aghast to the manifesto. The coronation of a woman was in the eyes of the Russian people a scandalous innovation in any case, and the proposed coronation was doubly scandalous in view of the base and disreputable origin of Catherine herself (see CATHERINE I.). But Peter had his way, and the ceremony took place at Moscow with extraordinary pomp and splendour on the 7th of May 1724.

During the last four years of his reign Peter's policy was predominantly Oriental. He had got all he wanted in Europe, but the anarchical state of Persia at the beginning of 1722 opened up fresh vistas of conquest. The war which lasted from May 1722 to September 1723 was altogether successful, resulting in the acquisition of the towns of Baku and Derbent and the Caspian provinces of Gilan, Mazandaran and Astarabad. The Persian campaigns wore out the feeble health of Peter, who had been ailing for some time. A long and fatiguing tour of inspection over the latest of his great public works, the Ladoga Canal, during the autumn of 1724, brought back another attack of his paroxysms, and he reached Petersburg too ill to rally again, though he showed himself in public as late as the 16th of January 1725. He expired in the arms of his consort, after terrible suffering, on the 28th of January 1725.

Peter's claim to greatness rests mainly on the fact that from first to last he clearly recognized the requirements of the Russian nation and his own obligations as its ruler. It would have materially lightened his task had he placed intelligent foreigners at the head of every department of state, allowing them gradually to train up a native bureaucracy. But for the sake of the independence of the Russian nation he resisted the temptation of taking this inviting but perilous short-cut to greatness. He was determined that, at whatever cost, hardship and inconvenience, Russia should be ruled by Russians, not by foreigners; and before his death he had the satisfaction of seeing every important place in his empire in the hands of capable natives of his own training. But even in his most sweeping reforms he never lost sight of the idiosyncrasies of the people. He never destroyed anything which he was not able to replace by something better. He possessed, too, something of the heroic nature of the old Russian *bogatuirs*, or demigods, as we see them in the *skazki* and the *bylini*. His expansive nature loved width and space. No doubt this last of the *bogatuirs* possessed the violent passions as well as the wide views of his prototypes. All his qualities, indeed, were on a colossal scale. His rage was cyclonic: his hatred rarely stopped short of extermination. His banquets were orgies, his pastimes convulsions. He lived and he loved like one of the giants of old. There are deeds of his which make humanity shudder, and no man equally great has ever descended to such depths of cruelty and treachery. Yet it may generally be allowed that a strain of nobility, of which we occasionally catch illuminating glimpses, extorts from time to time an all-forgiving admiration. Strange, too, as it may sound, Peter the Great was at heart profoundly religious. Few men have ever had a more intimate persuasion that they were but instruments for good in the hands of God.

BIBLIOGRAPHY.—*Letters and Papers of Peter the Great* (Rus.) (St Petersburg, 1887, &c.). S. M. Solovov, *History of Russia* (Rus.), vols. xiv.-xviii (St Petersburg, 1895, &c.). A. Bruckner, *Die Europäisierung Russlands* (Gotha, 1888). R. Nisbet Bain, *The Pupils of Peter the Great*, chs. i.-iv. (London, 1897), and *The First Romanovs*, chs. vii.-xiv. (London, 1905). E. Schuyler, *Life of Peter the Great* (London, 1884); K. Waliszewski, *Pierre le Grand* (Paris, 1897); V. N. Aleksandrenko, *Russian Diplomatic Agents in London in the 18th Century* (Rus.) (Warsaw, 1897-1898; German ed., Guben, 1898); S. A. Chistyakov, *History of Peter the Great* (Rus.) (St Petersburg, 1903); S. M. Solovov, *Public Readings on Peter the Great* (Rus.) (St Petersburg, 1903); *Documents relating to the Great Northern War* (Rus.) (St Petersburg, 1892, &c.). (R. N. B.)

PETER II. (1715-1730), emperor of Russia, only son of the Tsarevich Alexis, was born on the 18th of October 1715. From his childhood the orphan grand duke was kept in the strictest seclusion. His grandfather, Peter the Great, systematically ignored him. His earliest governesses were the wives of a tailor and a vintner from the Dutch settlement; a sailor called Norman taught him the rudiments of navigation; and, when he grew older, he was placed under the care of a Hungarian refugee, Janos Zeikin, who seems to have been a conscientious teacher. During the reign of Catherine I. Peter was quite ignored; but just before her death it became clear to those in power that the grandson of Peter the Great could not be kept out of his inheritance much longer. The majority of the nation and three-quarters of the nobility were on his side, while his uncle, the emperor Charles VI., through the imperial ambassador at St Petersburg, Rabutin, persistently urged his claims. The matter was arranged between Menshikov, Osterman and Rabutin, and on the 18th of May 1727 Peter II., according to the terms of the supposed last will of Catherine I., was proclaimed sovereign autocrat. The senate, the privy council and the guards took the oath of allegiance forthwith. The education of the young prince was wisely entrusted to the vice-chancellor Osterman. Menshikov, who took possession of Peter II. and lodged him in his own palace on the Vasily island, had intended to marry Peter to his daughter Maria; the scheme was frustrated by his fall (Sept. 21, 1727); but Peter only fell into the hands of the equally unscrupulous Dolgoruki, who carried him away from Petersburg to Moscow. Peter's coronation was celebrated at that city on the 25th of February 1728. He was betrothed to Catherine, second daughter of Alexis Dolgoruki, and the wedding was actually fixed for the 30th of January 1730; but on that very day the emperor died of small-pox.

PETER III. (1728-1762), emperor of Russia, only son of Charles Frederick, duke of Holstein-Gottorp, and of Anae, eldest surviving daughter of Peter the Great, was born at Kiel on the 21st of February 1728. In December 1741 he was adopted by his aunt, Elizabeth Petrovna, as soon as she was safely established on the Russian throne, and on the 18th of November 1742 was received into the Orthodox Church, exchanging his original name of Karl Peter Ulrich for that of Peter Fedorovich. On the 21st of August 1745, by the command of his aunt, he married the princess Sophia Augusta Frederica of Anhalt-Zerbst, who exchanged her name for that of Catherine Aleksyevna. The union between a prince who physically was something less than a man and mentally little more than a child, and a princess of prodigious intellect and an insatiable love of enjoyment, was bound to end in a catastrophe. But there is no foundation for the stories of Peter's neglect and brutality. It took the spouses five years to discover that their tastes were divergent and their tempers incompatible. Even when Peter III. succeeded his aunt on the 5th of January 1762, he paid off all the debts that Catherine had contracted without inquiring what they were for. On her birthday, in April, he made her a present of domains worth £10,000 per annum, though he had already readjusted her establishment on a truly imperial scale. A great deal has been made of Peter's infidelity towards his consort; but the only one who really suffered from his *liaison* with the ugly, stupid and vixenish countess Elizabeth Vorontsova was the unfortunate emperor. So far from being scandalized by the juxtaposition of "Das Fräulein" in the Winter Palace,

Catherine accepted it as a matter of course, provided that her own relations with the handsome young guardsman, Gregory Orlov, were undisturbed. Nor was Peter's behaviour to his consort in public of the outrageous character we have been led to suppose. Peter, in fact, was too good-natured and inconsequent to pursue, or even premeditate, any deliberate course of ill treatment. No personal wrongs, but the deliberate determination of a strong-minded, capable woman to snatch the reins of government from the hands of a semi-imbecile, was the cause of Peter's overthrow, and his stupendous blunders supplied Catherine with her opportunity. Peter's foreign policy was the absolute reversal of the policy of his predecessor. He had not been on the throne for two months when he made pacific overtures to the wellnigh vanquished king of Prussia, whom he habitually alluded to as "the king my master." Peter's enthusiastic worship of Frederick resulted in a peace (May 5) and then (June 19) in an offensive and defensive alliance between Russia and Prussia, whereby Peter restored to Prussia all the territory won from her by Russia during the last five years at such an enormous expense of men and money, and engaged to defend Frederick against all his enemies. This was followed up by a whole series of menacing rescripts addressed by Peter to the court of Vienna, in which war was threatened unless Austria instantly complied with all the demands of the king of Prussia. Finally he picked a quarrel with Denmark for not accepting as an ultimatum the terms to be submitted by Russia to a peace conference to meet at Berlin for the purpose of adjusting the differences between the two powers. On the 6th of July the Russian army received orders to invade Denmark by way of Mecklenburg. This advance was only arrested, when the opposing forces were almost within touch of each other, by the tidings that a revolution had taken place at St Petersburg, and that Peter III. was already a prisoner in the hands of his consort. The *coup d'état* of the 9th of July 1762 properly belongs to the history of Catherine II. (*q.v.*). Here only a few words must be said as to the mysterious death of Peter at the castle of Ropska, to which he was removed immediately after his surrender. Here he remained from the evening of the 9th to the afternoon of the 18th of July. At first Catherine and her counsellors could not make up their minds what to do with "the former emperor." Imprisonment in Schlüsselburg for life, or repatriation to Holstein, were proposed only to be rejected as dangerous. The Orlovs had even stronger motives than Catherine for suppressing the ex-emperor, for Gregory Orlov aspired to win the hand as well as the heart of his imperial mistress, and so long as Catherine's lawful husband lived, even in a prison, such a union would be impossible. The available evidence points to the irresistible conclusion that on the afternoon of the 18th of July 1762, Peter III., with his consort's connivance, was brutally murdered at Ropska by Alexis Orlov, Theodore Baryatinski, and several other persons still unknown.

See R. N. Bain, *Peter III., Emperor of Russia* (London, 1902); V. A. Bilbasov, *History of Catherine II.* (Rus.), vol. i. (Berlin, 1900). (R. N. B.)

PETER (PEDRO), the name of several Spanish kings.

PETER I., king of Aragon (d. 1104), son of Sancho Ramirez, the third in order of the historic kings of Aragon, belonged to times anterior to the authentic written history of his kingdom; and little is known of him save that he recovered Huesca from the Mahomedans in 1096.

PETER II., king of Aragon (1174-1213), son of Alphonso II. and his wife Sancia, daughter of Alphonso VIII. of Castile, was born in 1174. He had a very marked and curious personal character. As sovereign of lands on both sides of the Pyrenees, he was affected by very different influences. In his character of Spanish prince he was a crusader, and he took a distinguished part in the great victory over the Almohades at the Navas de Tolosa in 1212. But his lands to the north of the Pyrenees brought him into close relations with the Albigenses. He was a favourite of the troubadours, and in his ways of life he indulged in the laxity of Provençal morals to the fullest extent. We are told in the chronicle written by Desclot soon after his time

that Peter was only trapped into cohabiting with his wife by the device which is familiar to readers of *Measure for Measure*. In the year after the battle of the Navas de Tolosa he took up arms against the crusaders of Simon of Montfort, moved not by sympathy with the Albigenes, but by the natural political hostility of the southern princes to the conquering intervention of the north under pretence of religious zeal. His son records the way in which he spent the night before the battle of Muret with a crudity of language which defies translation, and tells us that his father was too exhausted in the morning to stand at Mass, and had to be lifted into the saddle by his squires. Peter none the less showed the greatest personal valour, and his body, recognizable by his lofty stature and personal beauty, was found on the field after the rout (Sept. 12, 1213).

See *Chronicle of James I. of Aragon*, translated by J. Forster (London, 1883), and *Life and Times of James the First the Conqueror*, by F. Darwin Swift (Oxford, 1894).

PETER III., king of Aragon (1236-1286), son of James the Conqueror, and his wife Yolande, daughter of Andrew II. of Hungary, was born in 1236. Having married Constance, daughter of Manfred of Beneventum, he came forward as the representative of the claims of the Hohenstaufen in Naples and Sicily against Charles, duke of Anjou. Peter began the long strife of the Angevine and Aragonese parties in southern Italy. His success in conquering Sicily earned him the surname of "the Great." He repelled an invasion of Catalonia undertaken by the king of France in support of Charles of Anjou, and died on the 8th of November 1286.

For the personal character of Peter III., the best witness is the *Chronicle of Ramon de Montaner*—reprinted in the original Catalan by R. Lanz, *Literarischer Verein in Stuttgart*, vol. vii. (1844), and in French by Buchon, *Coll. des chroniques nationales* (Paris, 1824-1828). See also O. Cartellieri, *Peter von Aragon und die Sizilianische Vesper* (Heidelberg, 1904).

PETER IV., king of Aragon (d. 1387), son of Alphonso IV. and his wife Teresa d'Enteca, is known as "The Ceremonious" and also as "he of the dagger." He acquired the first title by the rigid etiquette he enforced, as one means of checking the excessive freedom of his nobles. The second name was given him because he wounded himself with his dagger in the act of cutting to pieces the so-called "charter of the Union," which authorised the rebellions of his nobles, and which he forced them to give up, after he had routed them at the battle of Epila in 1348. Of no man of the 14th century can it be more truly said that his life was a warfare on earth. He had first to subdue his nobles, and to reannex the Balearic Islands to the crown of Aragon. When he had made himself master at home, he had to carry on a long and fierce contest with his namesake Peter the Cruel of Castile, which only terminated when Henry of Trastamara succeeded, largely with Aragonese help, in making himself king of Castile in 1369. Peter succeeded in making himself master of Sicily in 1377, but ceded the actual possession of the island to his son Martin. He was three times married to Mary, daughter of Philip of Evreux, king of Navarre, to Eleanor, daughter of Alphonso IV. of Portugal, and to Eleanor, daughter of Peter II. of Sicily, his cousin. The marriage of his daughter by his third marriage, Eleanor, with John I. of Castile, carried the crown of Aragon to the Castilian line when his male representatives became extinct on the death of his son Martin in 1410.

See Zurita, *Anales de Aragon* (Saragossa, 1610).

PETER, "the Cruel," king of Castile (1333-1369), son of Alphonso XI. and Maria, daughter of Alphonso IV. of Portugal, was born in 1333. He earned for himself the reputation of monstrous cruelty which is indicated by the accepted title. In later ages, when the royal authority was thoroughly established, there was a reaction in Peter's favour, and an alternative name was found for him. It became a fashion to speak of him as *El Justiciero*, the executor of justice. Apologists were found to say that he had only killed men who themselves would not submit to the law or respect the rights of others. There is this amount of foundation for the plea, that the chronicler Lopez de Ayala, who fought against him, has confessed that the

king's fall was regretted by the merchants and traders, who enjoyed security under his rule. Peter began to reign at the age of sixteen, and found himself subjected to the control of his mother and her favourites. He was immoral, and unfaithful to his wife, as his father had been. But Alphonso XI. did not imprison his wife, or cause her to be murdered. Peter certainly did the first, and there can be little doubt that he did the second. He had not even the excuse that he was passionately in love with his mistress, Maria de Padilla; for, at a time when he asserted that he was married to her, and when he was undoubtedly married to Blanche of Bourbon, he went through the form of marriage with a lady of the family of Castro, who bore him a son, and then deserted her. Maria de Padilla was only the one lady of his harem of whom he never became quite tired. At first he was controlled by his mother, but emancipated himself with the encouragement of the minister Albuquerque and became attached to Maria de Padilla. Maria turned him against Albuquerque. In 1354 the king was practically coerced by his mother and the nobles into marrying Blanche of Bourbon, but deserted her at once. A period of turmoil followed in which the king was for a time overpowered and in effect imprisoned. The dissensions of the party which was striving to coerce him enabled him to escape from Toro, where he was under observation to Segovia. From 1356 to 1366 he was master, and was engaged in continual wars with Aragon, in which he showed neither ability nor daring. It was during this period that he perpetrated the series of murders which made him odious. He confided in nobody save the Jews, who were his tax-gatherers, or the Mohammedan guard he had about him. The profound hatred of the Christians for the Jews and *Mudejares*, or Mohammedans settled among them, dates from the years in which they were the agents of his unbridled tyranny. In 1366 he was assailed by his bastard brother Henry of Trastamara at the head of a host of soldiers of fortune, and fled the kingdom without daring to give battle. Almost his last act in Spain was to murder Suero, the archbishop of Santiago, and the dean, Perarvarez. Peter now took refuge with the Black Prince, by whom he was restored in the following year. But he disgusted his ally by his faithlessness and ferocity. The health of the Black Prince broke down, and he left Spain. When thrown on his own resources, Peter was soon overthrown by his brother Henry, with the aid of Bertrand du Guesclin and a body of French free companions. He was murdered by Henry in du Guesclin's tent on the 23rd of March 1369. His daughters by Maria de Padilla, Constance and Isabella, were respectively married to John of Gaunt, and Edmund, duke of York, sons of Edward III., king of England.

The great original but hostile authority for the life of Peter the Cruel is the *Chronicle of the Chancellor Pero Lopez de Ayala* (Madrid 1779-1780). A brilliantly written Life is that by Prosper Mérimée, *Hist. de Don Pedro I., roi de Castille* (Paris, 1848). (D. H.)

PETER DES ROCHES (d. 1238), bishop of Winchester under John and Henry III., and conspicuous among the foreign favourites to whom these sovereigns owed much of their unpopularity, was a Poitevin by extraction. He received the office of chamberlain towards the close of Richard's reign, and under Richard's successor became an influential counsellor. In 1205, doubtless through John's influence, he was elected to the see of Winchester. His election was disputed but, on appeal, confirmed by Pope Innocent III., who honoured Peter by consecrating him in person. None the less, the new bishop stood by his royal patron during the whole period of the interdict. In 1213 he was made justiciar in succession to Geoffrey Fitz Peter. This promotion was justified by the fidelity with which Peter supported the king through the barons' war. At the battle of Lincoln (1217) Peter led a division of the royal army and earned some distinction by his valour; but he played a secondary part in the government so long as William Marshal held the regency. After Marshal's death (1219) Peter led the baronial opposition to Hubert de Burgh, with varying success. At first the justiciar was successful. In 1221 Peter meditated going on crusade; 1223-1224 saw his party broken up by Hubert's energetic measures; in 1227 was himself dismissed from his office and

turned his back on England to join the crusade of the emperor Frederick II. He was absent from England until 1231; but in the meantime enhanced his reputation both as a soldier and diplomatist. After the fall of De Burgh he kept in the background, but offices and honours were heaped on his dependants, especially on his nephew, Peter des Rievaulx, and other Boitevins. This foreign party triumphed over the revolt which was headed by Richard Marshal in 1233. But the primate, Edmund Rich, voiced the general feeling when he denounced Peter as a mischief maker, and demanded that he should be dismissed from court. The king complied, and threatened the bishop with charges of malversation. Peter was however permitted to leave the country with a pardon (1235); he conciliated Gregory IX. by rendering efficient aid in a war with the citizens of Rome (1235); and in the next year returned without molestation to his see. He was invited to go as the king's envoy to the court of Frederick II., but refused apparently on the score of ill health. His public reconciliation with De Burgh (1236), effected through the mediation of the papal legate, provided a dramatic close to their long rivalry, but had no political significance, since both were now living in retirement. Peter died in 1238, and was buried at Winchester. He was undoubtedly a man of a winning personality, a good diplomat and financier, a statesman whose unpopularity was due in some measure to his freedom from the insularity of the Englishmen, against whom he matched himself. But his name is associated with a worthless clique of favourites, and with the first steps which were taken by Henry III. to establish a feeble and corrupt autocracy.

See C. Petit Dutaillis, *Vie et règne de Louis VIII.* (Paris, 1894); Lecoindre Dupont, *Pierre des Roches* (Poitiers, 1868); Stubbs's *Constitutional History of England*, vol. ii.; H. W. C. Davis, *England under the Normans and Angevins* (1905); T. F. Tout in the *Political History of England*, vol. iii. (1905). (H. W. C. D.)

PETER LOMBARD (c. 1100-c. 1160), bishop of Paris, better known as *Magister sententiarum*, the son of obscure parents, was born about the beginning of the 12th century, at Novara (then reckoned as belonging to Lombardy). After receiving his education at Bologna, he removed to France, bearing a recommendation to Bernard of Clairvaux, who first placed him under Lotolf at Reims, and afterwards sent him to Paris with letters to Gilduin, the abbot of St Victor. He soon became known as a teacher, and obtained a theological chair in the cathedral school. His famous textbook, the *Sententiae*, was written between 1145 and 1150. On the 29th of June 1159 he became bishop of Paris. The accounts of his bishopric are satisfactory. There is a charge that he was guilty of simony, having received his office through the favour of Philip, brother of Louis VII., his former pupil. The date of his death is uncertain. According to one account he died on the 20th of July 1160, and as Maurice de Sully became bishop that year the statement seems probable. Yet there is evidence for a later date, and he may have been set aside for simony.

His famous theological handbook, *Sententiarum libri quatuor*, is, as the title implies, primarily a collection of opinions of the fathers, "sententiae patrum." These are arranged, professedly on the basis of the aphorism of Augustine, Lombard's favourite authority, that "omnis doctrina vel rerum est vel signorum," into four books, of which the first treats of God, the second of the creature, the third of the incarnation, the work of redemption, and the virtues, and the fourth of the seven sacraments and eschatology. The *Sententiae* show the influence of Abelard, both in method and arrangement, but lack entirely the daring of *Sic et Non*. Compared with that book they are tame. Gratian's *Concordia discordantium canonum*, as he called his Decretum, was another strong influence, Lombard doing in a sense for theology what Gratian did for the canon law. The influence of Hugh of St Victor is also marked. The relation to the "sentences" of a Gundulph of Bologna (still unpublished) has not been established. The most important thing in the book was its crystallization of the doctrine concerning the sacramental system, by the definite assertion of the doctrine of the seven sacraments, and the acceptance of a definition of sacrament, not merely as "a sign of a sacred thing," but as itself "capable of conveying the grace of which it is the sign." The sentences soon attained immense popularity, ultimately becoming the text-book in almost every theological school, and giving rise to endless commentaries, over 180 of these being written in England. In 1300 the theological professors

of Paris agreed in the rejection of sixteen propositions taken from Lombard, but their decision was far from obtaining universal currency.

Besides the *Sententiae*, Lombard wrote numerous commentaries (e.g. on the Psalms, Canticles, Job, the Gospel Harmony, and the Pauline Epistles), sermons and letters, which still exist in MS. The *Glossae seu commentarius in psalmos Davidis*, were first published at Paris in 1533.

Lombard's collected works have been published in J. P. Migne's *Patrologiae Latinae*, Tome 191 and 192. See also Denifle and Chatelein, *Chartularium universitatis parisiensis*, Tome i. (Paris, 1889); Protois, *Pierre Lombard, son époque, sa vie, ses écrits, son influence* (Paris, 1881); Kugel, *Petrus Lombard in seiner Stellung zur Philosophie des Mittelalters* (Leipzig, 1897); A. Harnack, *Dogmengeschichte*, Bd. iii. (1890; Eng. trans. 1894-1899); and the article in Herzog-Hauck's *Realencyclopädie*, Bd. xi. (Leipzig, 1902).

PETER OF AIGUEBLANCHE (d. 1268), bishop of Hereford, belonged to a noble family of Savoy and came to England in 1236 with his master, William of Savoy, bishop of Valence, being in attendance on Eleanor of Provence, the bride of Henry III. A year or two later he is found residing permanently in England as a member of the king's court; before 1239 he was archdeacon of Salop, and in 1240 he was chosen bishop of Hereford. In 1255 Peter acted as Henry's principal agent in the matter of accepting the kingdom of Sicily from Pope Alexander IV. for his son Edmund, and his rapacious and dishonest methods of raising money for this foolish enterprise added not a little to the unpopularity which surrounded the king and his foreign favourites. When civil war broke out between Henry and his barons the bishop remained loyal to his master, and whilst residing, almost for the first time, at Hereford he was taken prisoner in May 1263. He was, however, released when the king and his enemies came to terms, and after a stay in France he retired to Savoy, where he died on the 27th of November 1268.

See F. Magnier, *Les Savoyards en Angleterre au XIII^e siècle et Pierre d'Aigueblanche* (Chambéry, 1890).

PETER OF BLOIS [Petrus Blesensis] (c. 1135-c. 1205), French writer, the son of noble Breton parents, was born at Blois. He studied jurisprudence at Bologna and theology in Paris, and in 1167 he went to Sicily, where he became tutor to the young king William II., and keeper of the royal seal (*sigillarius*). But he made many enemies and soon asked permission to leave the country; his request was granted and about 1170 he returned to France. After spending some time teaching in Paris and serving Rotrou de Perche, archbishop of Rouen, as secretary, Peter entered the employ of Henry II. of England about 1173. He quickly became archdeacon of Bath and soon afterwards chancellor, or secretary, to Richard, archbishop of Canterbury, and to Richard's successor, Baldwin, being sent on two occasions to Italy to plead the cause of these prelates before the pope. After the death of Henry II. in 1189, he was for a time secretary to his widow, Eleanor, in Normandy; he obtained the posts of dean of Wolverhampton and archdeacon of London, but he appears to have been very discontented in his later years. He died some time after March 1204.

Peter's writings fall into four classes, letters, treatises, sermons and poems. His *Epistolae*, which were collected at the request of Henry II., are an important source for the history of the time; they are addressed to Henry II. and to various prelates and scholars, including Thomas Becket and John of Salisbury. His treatises include *De Ierosolymitana peregrinatione acceleranda*, an exhortation to take part in the third crusade, and *Dialogus inter regem Henricum II. et abbatem Bonaventuram*; his extant sermons number 65 and his poems are unimportant. Peter's works have been printed in several collections, including the *Patrologia* of J. P. Migne and the *Historiae francorum scriptores* of A. Duchesne. Of separate editions the best are those by Pierre de Goussainville (Paris, 1667) and J. A. Giles (Oxford, 1846-1847).

See the *Histoire littéraire de la France*, Tome xv.; W. Stubbs, *Lectures on Medieval and Modern History* (Oxford, 1886); Sir T. D. Hardy, *Descriptive Catalogue of Materials relating to the History of Great Britain* (1862-1867), and C. L. Kingsford in vol. xiv. of the *Dictionary of National Biography* (1896).

PETER OF COURTENAY (d. 1219), emperor of Romania (or Constantinople), was a son of Peter of Courtenay (d. 1183), and a grandson of the French king, Louis VI. Having, by a first marriage, obtained the counties of Nevers and Auxerre, he took

for his second wife, Yolande (d. 1219), a sister of Baldwin and Henry of Flanders, who were afterwards the first and second emperors of the Latin Empire of Constantinople. Peter accompanied his cousin, King Philip Augustus, on the crusade of 1190, fought against the Albigenses, and was present at the battle of Bouvines in 1214. When his brother-in-law, the emperor Henry, died without sons in 1216, Peter was chosen as his successor, and with a small army set out from France to take possession of his throne. Consecrated emperor at Rome, in a church outside the walls, by Pope Honorius III. on the 9th of April 1217, he borrowed some ships from the Venetians, promising in return to conquer Durazzo for them; but he failed in this enterprise, and sought to make his way to Constantinople by land. On the journey he was seized by the despot of Epirus, Theodore Angelus, and, after an imprisonment of two years, died, probably by foul means. Peter thus never governed his empire, which, however, was ruled for a time by his wife, Yolande, who had succeeded in reaching Constantinople. Two of his sons, Robert and Baldwin, became in turn emperors of Constantinople.

PETER OF DUISBURG (d. c. 1326), German chronicler, was born at Duisburg, and became a priest-brother of the Teutonic Order. He wrote the *Chronicon terrae Prussiae*, dedicated to the grand-master, Werner of Orseln, which is one of the chief authorities for the history of the order in Prussia. There is a rhyming translation in German by Nicholas of Jeroschin, which, together with the original, is published in Bd. I. of the *Scriptores rerum prussicarum* (Leipzig, 1861).

See M. Töppen, *Geschichte der preussischen Historiographie* (Berlin, 1853); and W. Fuchs, *Peter von Duisburg und das Chronicon olivense* (Königsberg, 1884).

PETER OF MARICOURT (13th century), a French savant, to whom his disciple, Roger Bacon, pays the highest tribute in his *opus tertium* and other works. According to Bacon he was a recluse who devoted himself to the study of nature, was able to work metals, invented armour and assisted St Louis in one of his expeditions more than his whole army. According to Émile Charles (*Roger Bacon sa vie, ses ouvrages, ses doctrines*, 1861), Peter of Maricourt is the Pierre Pérégrin (or Pélerin) de Maricourt (Méharicourt in Picardy), known also as Petrus Peregrinus of Picardy, one of those letters, *De magne*, is partly reproduced in Libri's *Hist. des sciences mathématiques en Italie* (1838), ii. 70-71, 487-505.

PETER OF SAVOY (c. 1203-1268), earl of Richmond, younger son of Thomas I. (Tommaso), count of Savoy, was born at Susa. After spending some years as an ecclesiastic he resigned his preferments, and in 1234 married his cousin Agnes, daughter and heiress of Aymon II., lord of Faucigny. Accepting an invitation from the English king, Henry III., who had married his niece, Eleanor of Provence, Peter came to England in 1240, and was created earl of Richmond, receiving also large estates and being appointed to several important offices. During several visits to the continent of Europe Peter had largely increased his possessions in Vaud and the neighbourhood, and returning to England in 1252 he became associated with Simon de Montfort, retaining at the same time the king's friendship. Having been employed by Henry to negotiate with the pope and with Louis IX. of France, he supported Earl Simon in his efforts to impose restrictions upon the royal power; but, more moderate than many members of the baronial party, went over to Henry's side in 1260, and was consequently removed from the council. In 1263 he left England, and when his nephew, Boniface, count of Savoy, died in the same year he assumed the title of count of Savoy. This was also claimed by another nephew, Thomas; but Peter compelled the inhabitants of Turin to submit to him and secured possession of the county. He died on the 16th or 17th of May 1268, leaving an only child, Beatrice (d. 1310). Peter gave to the castle of Chillon its present form, and his name to the Savoy palace in London. He has been called *le petit Charlemagne*, and was greatly praised for his valour and his wisdom.

See J. Wurstemberger, *Peter der Zweite, Graf von Savoyen* (Zürich,

1858); F. Mugnier, *Les Savoysards en Angleterre* (Chambéry, 1890); and C. Bémont, *Simon de Montfort* (Paris, 1884).

PETER THE HERMIT, a priest of Amiens, who, say, as Anna Comnena says, have attempted to go on a pilgrimage to Jerusalem before 1096, and have been prevented by the Turks from reaching his destination. It is uncertain whether he was present at Urban's great sermon at Clermont in 1095; but it is certain that he was one of the preachers of the crusade in France after that sermon, and his own experience may have helped to give fire to his eloquence. He soon leapt into fame as an emotional revivalist preacher: his very ass became an object of popular adoration; and thousands of peasants eagerly took the cross at his bidding. The crusade of the *pauperes*, which forms the first act in the first crusade, was his work; and he himself led one of the five sections of the *pauperes* to Constantinople, starting from Cologne in April, and arriving at Constantinople at the end of July 1096. Here he joined the only other section which had succeeded in reaching Constantinople—that of Walter the Penniless; and with the joint forces, which had made themselves a nuisance by pillaging, he crossed to the Asiatic shore in the beginning of August. In spite of his warnings, the *pauperes* began hostilities against the Turks; and Peter returned to Constantinople, either in despair at their recklessness, or in the hope of procuring supplies. In his absence the army was cut to pieces by the Turks; and he was left in Constantinople without any followers, during the winter of 1096-1097, to wait for the coming of the princes. He joined himself to their ranks in May 1097, with a little following which he seems to have collected, and marched with them through Asia Minor to Jerusalem. But he played a very subordinate part in the history of the first crusade. He appears, in the beginning of 1098, as attempting to escape from the privations of the siege of Antioch—showing himself, as Guibert of Nogent says, a "fallen star." In the middle of the year he was sent by the princes to invite Kerbogha to settle all differences by a duel; and in 1099 he appears as treasurer of the alms at the siege of Arca (March), and as leader of the supplicatory processions in Jerusalem which preceded the battle of Ascalon (August). At the end of the year he went to Laodicea, and sailed thence for the West. From this time he disappears; but Albert of Aix records that he died in 1151, as prior of a church of the Holy Sepulchre which he had founded in France.

Legend has made Peter the Hermit the author and originator of the first crusade. It has told how, in an early visit to Jerusalem, before 1096, Christ appeared to him in the Church of the Sepulchre, and bade him preach the crusade. The legend is without any basis in fact, though it appears in the pages of William of Tyre. Its origin is, however, a matter of some interest. Von Sybel, in his *Geschichte des ersten Kreuzzuges*, suggests that in the camp of the *pauperes* (which existed side by side with that of the knights, and grew increasingly large as the crusade told more and more heavily in its progress on the purses of the crusaders) some idolization of Peter the Hermit had already begun, during the first crusade, parallel to the similar glorification of Godfrey by the Lorrainers. In this idolization Peter naturally became the instigator of the crusade, just as Godfrey became the founder of the kingdom of Jerusalem and the legislator of the assizes. This version of Peter's career seems as old as the *Chanson des chrétiens*, a poem which Raymond of Antioch caused to be composed in honour of the Hermit and his followers, soon after 1130. It also appears in the pages of Albert of Aix, who wrote somewhere about 1130; and from Albert it was borrowed by William of Tyre. The whole legend of Peter is an excellent instance of the legendary amplification of the first crusade—an amplification which, beginning during the crusade itself, in the "idolizations" of the different camps (*idola castrorum*, if one may pervert Bacon), soon developed into a regular saga. This saga found its most piquant beginning in the Hermit's vision at Jerusalem, and there it accordingly began—like in Albert, followed by William of Tyre and in the *Chanson des chrétiens*, followed by the later *Chanson d'Antioche*.

The original authorities for the story of Peter the Hermit are: for the authentic Peter, Anna Comnena and the *Gesta Francorum*;

for the legendary Peter, Albert of Aix. The whole career of the Hermit has been thoroughly and excellently discussed by H. Hagenmeyer, *Peter der Heremite* (Leipzig, 1879). (E. Br.)

PETER THE WILD BOY (fl. 1725-1785), a Hanoverian imbecile of unknown parentage, who, having been found living wild in the woods near Hanover in 1725, was brought to England by order of George I, whose interest had been aroused in the unfortunate youth. An extraordinary amount of curiosity and speculation concerning Peter was excited in London, and the craze was the subject of a biting satire by Swift, and of another entitled *The Most Wonderful Wonder that ever appeared to the Wonder of the British Nation*, which has been attributed to Swift and Arbuthnot; Defoe also wrote on the subject, and Lord Monbodo in his *Origin and Progress of Language* presents the idiot Peter as an illustration of his theory of the evolution of the human species. He lived to an advanced age, was seen by Lord Monbodo in 1782, and died in 1785.

See Henry Wilson, *The Book of Wonderful Characters* (London, 1869).

PETER, EPISTLES OF, the two books of the New Testament traditionally ascribed to the apostle Peter.

I PETER

This epistle is addressed to "the elect who are sojourners of the Dispersion [Diaspora] in Pontus, Galatia, Cappadocia, Asia and Bithynia." The "Diaspora" was the name generally given to the Jews who were "scattered abroad." This suggests that the letter was intended for Jewish Christians in the provinces mentioned. But i. 14, 18; ii. 9, 10; iv. 3 point rather to Gentile Christians, and it is better to take this view, and interpret the "Diaspora" metaphorically as referring to the isolated position of Christians among the heathen. The general impression made by the epistle is that the central idea was to strengthen the courage of the recipients, who were likely to undergo persecution, and to enjoin on them conduct which would remove all reasonable excuse for thinking that Christianity ought to be regarded as a crime.

Ch. i. 3-12 is an introduction of praise to God that he had caused the recipients of the epistle to be born again to the living hope in a glorious salvation. The rest of the epistle may be divided into three parts: (a) i. 13-ii. 10, mainly hortatory injunctions to live holy lives in accordance with this new birth, and to grow up as God's people in communion with Christ; (b) ii. 11-iv. 6, particular directions as to the line of conduct to be pursued towards the Gentiles and towards those in authority, with special reference to the relations of slaves to masters, of wives and husbands to each other, and of Christians to one another; to the first of these a passage is appended dealing with the sufferings of Christ as an example (ii. 21-25), and the whole is completed by an exhortation to meekness and patience in suffering, in the light of the sufferings of Christ and the blessings given by them both to the living and to the dead; (c) iv. 7-v. 11, has less cohesion. It begins with exhortations not to forget prayer and love, then the believers are warned to be careful to suffer only as Christians, not as breakers of the laws. The elders and the younger men are reminded of their duties to the community and to one another. The whole is brought to a close with an exhortation to all to fight manfully against the devil and to trust in God.

Date and Authorship.—These two questions are so closely connected that they cannot be considered separately. The external evidence of tradition is that the epistle was written by St Peter. This can be traced back to Irenaeus (iv. 9, 2) and Clement of Alexandria (*Strom.* iii. 18, 110), and it is thought by many writers that 2 Peter iii. 1, even if it be not itself Petrine, is good evidence that the writer regarded 1 Peter as apostolic. Evidence for its use, without mention of its name, may be found in Polycarp, but probably not in the other apostolic fathers (cf. *The N. T. in the Apostolic Fathers*, Oxford, 1905, p. 137). It is, however, possible that Papias made use of it. It is doubtful whether Justin Martyr used it, but probable that it was known to Theophilus of Antioch. It is not mentioned in the canon of Muratori. Thus external evidence, though unanimous in favour of the Petrine authorship, is not sufficient to settle the question. The internal evidence consists of (a) evidence bearing on the date in connexion with the persecution of Christians, (b) evidence establishing the relation of the epistle to other

documents in early Christian history, and (c) evidence concerning St Peter personally.

(a) It is clear from 1 Peter i. 6, ii. 12, iv. 12-19, v. 9, that the epistle was written during a time of persecution. The question which is doubtful is to which persecution the description best applies. The traditional opinion was that the persecution referred to was that under Nero. But it has been argued that the Neroine persecution according to Tacitus (*Ann.* xv. 44) was not a persecution of Christians as such, but was rather the result of false accusation. Moreover there is no proof that there was any persecution of Christians at this time outside Rome, and 1 Peter alludes to persecution in the provinces of Asia Minor. Therefore many critics have felt obliged to bring the epistle into connexion with the epistle of Pliny to Trajan, written c. 112, and asking for advice as to the procedure to be followed in trials of Christians. This is the earliest evidence which implies organized persecution in the provinces in question, and therefore Holtzmann, Weissäcker and others regard this as fixing the date of the epistle in the beginning of the 2nd century, and excluding the Petrine authorship. Against this view it may be argued that the epistle describes the beginning of persecution. The writer still hopes that Christians will not be obliged to suffer "for the name" and is clearly aware of false accusations of crime. On the other hand Pliny's letter implies a time when Christianity was in itself a crime and was recognized as such. Thus it is urged, probably correctly, that the epistle belongs to the beginning of a period of which Pliny's letter marks a later development, and we can only say that c. 112 is the *terminus ad quem*. The *terminus a quo* is more difficult to find. We do not know with certainty when Christianity became a recognized offence, and scholars have supported various hypotheses. T. Mommsen, Hardy and Sanday think that even under Nero it was criminal to be a Christian; Neumann thinks that this was first the case under Domitian; Sir W. M. Ramsay believes that this attitude was one of the results of the Jewish War of 70, and ascribes it to Vespasian. If the Domitianic date be adopted the Petrine authorship is almost excluded, and it is difficult to reconcile the traditional date of St Peter's martyrdom with Ramsay's theory.

(b) The relations of 1 Peter to other books in early Christian literature is shown in the following table:—

1 Pet.	Rom.	1 Pet.	Eph.	1 Pet.	Jas.	1 Pet.	Polycarp.
i. 14	— xii. 2	i. 1 seq.	— i. 3 seq.	i. 1	— i. 1	i. 8	— i. 3
ii. 5	— xii. 1	i. 14	— ii. 3	i. 6 seq.	— i. 2 seq.	i. 13	— ii. 1
ii. 6-10	— ix. 32	ii. 18	— vi. 5	i. 24	— i. 10	i. 21	— ii. 1
ii. 13	— xii. 1	iii. 1	— v. 22	i. 23	— i. 18	ii. 11	— v. 3
iii. 9	— xii. 17	iii. 22	— i. 20	iv. 8	— v. 20	ii. 12	— x. 2
iii. 22	— viii. 34	v. 5	— v. 21	v. 5 seq.	— iv. 6, 10	ii. 21	— viii. 1, 2
iv. 3	— xiii. 11					iii. 9	— ii. 2
iv. 7	— xiii. 12					iv. 7	— vii. 2
iv. 9	— xiii. 13					iv. 16	— viii. 2
iv. 10	— xii. 6						

From this table it is sufficiently plain that 1 Peter is closely connected with Romans, Ephesians, James and Polycarp. The majority of scholars are agreed that in the case of Romans the dependence is on the side of 1 Peter, and in the case of Polycarp on the side of Polycarp. There is less agreement as to Ephesians and James, though in the former case the general opinion favours the dependence of 1 Peter, in the latter case its priority. In England, however, the priority of James has been supported by Mayor and Hort. In the light of the established use of Romans it is possible that 1 Peter also used other Pauline epistles and some scholars have seen special traces of the influence of 1 Cor. and Gal. (for a list of these cf. Holtzmann, *Einführung in das N. T.*, 3, p. 314). It has been argued that the use of the Pauline epistles is improbable for Peter, but this is a subjective argument which is not decisive.

(c) According to tradition Peter was martyred in Rome, and it is probable that this was in the Neroine persecution. If this be so, the year 64 is the *terminus ad quem* of the letter, if it be authentic. Ramsay, however, thinks that Peter may have survived this persecution and suffered at the beginning of the persecutions which, he thinks, were initiated by the Flavian emperors (see PETER, ST: § 5, 4 and 6).

The whole question of authorship and date is thus a complex of smaller problems, many of which do not seem to admit of any definite answer. If St Paul's epistle to the Ephesians be genuine, and it were really known to the writer of 1 Peter, and if Peter were martyred in 64, the theory of Petrine authorship demands that it was written by Peter between 50 and 64. On the Petrine hypothesis this is the most probable view. The weak point is that it assumes a great spread of Christianity in the provinces of Asia Minor outside the activity of Paul, and that the official persecution of Christians as such began throughout the Roman Empire under Nero, for neither of which is there

corroborative evidence. On the non-Petrine hypothesis a date is demanded some time before the letter of Pliny; this suits the internal evidence better than any possible on the Petrine hypothesis, but it fails to explain the really considerable and early evidence for the Petrine authorship, and necessitates some purely hypothetical suggestion, such as Harnack's view that the epistle was originally anonymous, and that the opening and closing sentences (i. 1 sqq., v. 12 sqq.) were added between A.D. 150 and 175, perhaps by the writer of 2 Peter.

The Provenance of the Epistle.—This is defined in 1 Peter v. 13 as Babylon. It has sometimes been argued that this is Babylon in Mesopotamia, in which there were, until the time of the emperor Caius, many Jews; but no good tradition connects St Peter with the evangelization of Mesopotamia, and this district would have had little in common with the Græco-Roman world of Asia Minor. Another suggestion is that the Egyptian Babylon is meant (Old Cairo); but in the 1st century this was probably merely a fortress. Thus there is an overwhelming weight of opinion in favour of the view that Rome, the Babylon of Apocalyptic literature, is intended. This also agrees with the tradition in 2 Tim. iv. 11, which (cf. 1 Pet. v. 13) suggests that St Mark was in Rome.

Reception in the Canon.—1 Peter seems to have been the earliest of the Catholic epistles to obtain recognition. By the year 200 it was accepted everywhere except in two places—the church of Edessa, which did not receive the Catholic epistles until the 5th century, and, if the canon of Muratori is to be trusted, the church of Rome. It should, however, be noted that Zahn emends the text of the Muratorianum (rather violently) so as to include the epistle (see also BIBLE: *New Testament Canon*).

The Theology of 1 Peter.—The simplicity of the theology is marked, and affords an argument for an early date. Jesus is the Messiah of whom the prophets had spoken, and the "Spirit of Christ" is identified with the spirit which was in them. His suffering for sin had rescued the elect, and was also an example for Christians to follow. After his death he preached to the "spirits in prison." The source of Christian life is on the one hand belief in God who raised the Messiah from the dead, and on the other hand baptism which "saves . . . through the resurrection of Jesus Christ." The members of the community are "a royal priesthood, a holy nation" —i.e. inherit the promises made to the Jews, but this inheritance is bound up with the strongly eschatological doctrine that Christians are strangers in the world, the end of which is at hand.

The Church Organisation of 1 Peter.—This is also very simple and primitive, and closely based on the Jewish model. The leaders are called presbyters or elders, and their duty is to act as shepherds to the flock. Beyond this there is no sign of a developed organization: each is to act in accordance with the gift (*χάρισμα*) which he has received. There is no trace of a specially set apart ministry either for the service of the community or for teaching, as to which the only limitation given is "If any man speak let him speak as the oracles of God," i.e. probably, in accordance with the Old Testament.

2 PETER

This epistle may be divided into five parts. (1) The writer who describes himself as "Simon (var. lect. Symeon) Peter, a servant and apostle of Jesus Christ," exhorts his readers to become perfect in knowledge and virtue, so as to enter the kingdom of Christ (i. 3-11). (2) He then explains his desire once more to testify to the power of Jesus, and bases his testimony partly on his own experience in the Holy Mount (apparently a reference to the Transfiguration), and partly on the "word of prophecy" (i. 12-21). (3) The mention of prophecy leads him to deal with the question of false prophets, who are accused of false doctrine and immoral practices. In this section is incorporated almost the whole of the epistle of Jude (ii. 1-22). (4) He then discusses a special feature of the false teaching, viz. doubts thrown on the *Parousia*, the certainty of which for the future he defends (iii. 1-13). Finally he warns his hearers that they must be found spotless at the *Parousia*, and emphasizes the agreement of his teaching with St Paul's (iii. 14-18).

The main object of the epistle is to be seen in the attack made on the false teachers, and in the defence of the certainty of the *Parousia* of the Lord.

Authorship.—The traditional view is that it was written by St Peter from Rome after 1 Peter. This view is however untenable for the following reasons. (1) The epistle is not quoted by any writer of the 2nd century, and Origen, who is the first to mention it as Petrine, admits that its authorship was disputed. (2) The style and language differ greatly from that of 1 Peter: this argument may however fairly be met by the suggestion that it is improbable that he wrote Greek with ease, and that he may have used a variety of amanuenses. (3) The growth of immorality and false teaching to which it witnesses seems irreconcilable with a very primitive period of church life. (4) It has incorporated the greater part of Jude in a wholesale manner difficult to reconcile with apostolical authorship. (5) It seems to attribute a position of scriptural authority to the Pauline epistles, and this is improbable either in the mouth of Peter, or during the 1st century.

Any one of these arguments would be weighty by itself; in combination they form an irresistible cumulative argument against the Petrine authorship of 2 Peter.

Date.—If the Petrine authorship be abandoned, the *terminus ad quem* of the epistle is its use by Origen (or, just possibly, by Clement of Alexandria), and the *terminus a quo* is fixed by the following considerations: (1) the activity of an immoderate Gnosticism; (2) the attainment by the Pauline epistles of great authority, and their perversion by heretics; (3) the use made of the epistle of Jude.

It is difficult to define the exact date to which these indications point, but there is a general agreement that it must be sought in the 2nd century, and perhaps the decades immediately before and after the year A.D. 150 are the most probable.

Place of Origin.—There is hardly any evidence on this point: but the most probable place seems to be Egypt, as the letter has points of connexion with Philo, Clement of Alexandria and the Apocalypse of Peter, and seems first to have been used in the church of Alexandria. It should however be noted that Deissmann argues on lexical grounds in favour of Asia Minor (*Bib. Stud.* pp. 277-284).

Relation to other Early Christian Documents.—The documents with which 2 Peter has the greatest affinities are the epistle of Jude, and the Apocalypse of Peter, of which a fragment was found in Akhmim in 1892 by M. Bouriant. In each case the affinity is very close, and is capable of more than one explanation. Roughly speaking 2 Peter ii. reproduces Jude: it is possible therefore either that Jude is an epitome of 2 Peter or that the writer of 2 Peter used Jude. The former hypothesis has a few supporters, notably T. Zahn and Spitta, but most writers are emphatic in thinking that 2 Peter has incorporated Jude, and this view is almost certainly correct (see JUDÉ, EPISTLE OF). The connexion with the Apocalypse of Peter is more complicated: the evidence of a comparison between the two documents (which is made in full in F. H. Chase's article in Hastings's *Dictionary of the Bible*) is to show that either one document is dependent on the other, or both were written by the same person, or both come from the same circle. Of these theories there is least to be said for the dependence of the Apocalypse on 2 Peter, and perhaps most for the dependence of 2 Peter on the Apocalypse.

Reception in the Canon.—2 Peter was the last of the Catholic epistles to be accepted as canonical. It was first regarded as such in Alexandria, perhaps originally in connexion with the Apocalypse of Peter rather than with 1 Peter. Thence it passed into the canon used by the church of Constantinople, in the 4th century made its way into the Roman canon, and in the 6th was accepted last of all by the Syria church (see also BIBLE: *New Testament Canon*).

The Theology of 2 Peter.—The theology of the epistle is specially marked by two characteristics—its high Christology and its eschatological character. Christ is referred to as "our God and Saviour," and the fatherhood of God is apparently only regarded as referring to the Divine Son. The work of Christ was the redemption of the elect, and this redemption awaits its consummation in the *Parousia*. This is the central point of the teaching of the epistle and is obviously directed against that of the false prophets. The writer looks forward to the destruction of the present world by fire.

when the wicked, whether angels or men, who have been reserved for judgment will be finally condemned, and a new era of happiness for the elect will begin.

Church Organization.—There is very little in 2 Peter which throws light on church organization. From his silence it would appear that the monarchical episcopacy did not yet exist in the church to which the writer belonged, and perhaps the prophets were still the chief guides, but the argument from silence cannot be pressed. In any case the growth of false and immoral prophets, which ultimately led to the obsolence and suppression of this order, was far advanced and was one of the reasons which led to the writing of the epistle.

AUTHORITIES.—Besides the books and articles already mentioned the following are important: F. H. Chase, "Peter" and "Epistles of Peter" in *Hastings's Dict. Bible*; P. W. Schmiedel, "Simon Peter" in the *Ency. Bib.*; Lightfoot, *S. Clement of Rome*, i, 201-315 and ii, 481-502; Harnack, *Altchr. Litt. and Chronologie* i (the relevant sections). The relevant sections in the Introductions of Holtzmann, T. Zahn, Jülicher, Salmon, Weiss and Moffat. The commentaries of Bigg, Mayor, F. Spitta, Köhl (in Meyer's *Commentary*), von Soden (in Holtzmann's *Commentary*), and Weiss.

(K. L.)

PETERBOROUGH, a town and port of entry of Ontario, Canada, and capital of Peterborough county, situated 70 m. N.E. of Toronto, on the Otonabee river and the Grand Trunk and Canadian Pacific railways. Pop. (1901), 11,259. The five falls of the Otonabee at this point, with a total descent of 50 ft., furnish power for a large and increasing number of manufacturing establishments, whilst its canalization as part of the Trent canal gives communication with Lake Ontario and Georgian Bay. Peterborough has an electric railway, and contains important manufactories of electrical machinery and supplies, iron and steel bridges, agricultural implements and cordage, saw, flour and woollen mills.

PETERBOROUGH, a city and municipal and parliamentary borough of Northamptonshire, England, 76 m. N. from London by the Great Northern railway; served also by the London & North Western, Great Eastern and Midland railways. Pop. (1891), 25,171; (1901), 30,872. It is built chiefly along the river Nene, on the north side, and on the western border of the Fen country.

The cathedral of St Peter is the third church that has occupied the site; the first, founded under Penda, king of the Mercians, about 656, was entirely destroyed by the Danes in 870, and the second, founded in King Edgar's reign, was accidentally burnt in 1116. The present building, founded in the following year, was, inclusive of the west front, 120 years in building, being consecrated on the 4th of October 1237. It embraces in all, however, eight periods of construction, and in no other building can the transition be better studied through the various grades of Norman to Early English, while the later addition is an admirable example of Perpendicular.

The erection proceeded as usual from east to west, and, while an increase in elegance and elaboration is observable in the later parts, the character of the earlier buildings was so carefully kept in mind that no sense of incongruity is produced. A series of uniform Decorated windows were added throughout the church in the 14th century, and their effect is rather to enhance than detract from the unity of design. The choir, early Norman, terminating in an apse, was founded in 1117 or 1118 by John de Sais or Sez, and dedicated in 1140 or 1143; the aisles of both transepts and the whole of the south transept were built by Martin of Bec, 1149-1155; the remaining portions of the transepts and the central tower, of three stories, were completed by William de Waterville, 1155-1175; the nave, late Norman, was completed by Abbot Benedict, 1177-1193, who added a beautiful painted roof of wood; the western transepts, transitional Norman, were the work of Abbot Andrew, 1193-1200; the western front, actually a vast portico of three arches, the unique feature of the building, and one of the finest specimens of Early English extant, must have been built between 1200 and 1250, during which period there were several abbots; but there exists no record of its reconstruction. The lady chapel, built parallel with the choir by William Parya, prior, was consecrated in 1290; the bell-tower was erected by Abbot Richard between 1260 and 1274; the south-west spire, the pinnacles of the flanking tower of the west portal, and the enlargement of the windows of the nave and aisles were the work of Henry de Morcott in the beginning of the 14th century; the "new building" or eastern chapel in the Perpendicular style, begun in 1436, was not completed till 1528. In 1541 the church was converted into a cathedral, the abbot being made the first bishop. The extreme length of the building is 471 ft., and of the nave 211 ft.; the breadth of the west front being 150; the height of the central tower, as reconstructed in the 14th century, was 150, that of the

spire and tower of the west front is 196 ft. In 1643 the building was defaced by the soldiers of Cromwell, who destroyed nearly all the brasses and monuments, burnt the ancient records, levelled the altar and screen, defaced the windows, and demolished the cloisters. To obtain materials for repairs the lady chapel was taken down. In the latter part of the 18th century the church was repaired. In 1831 a throne, stalls and choir-screen were erected and other restorations completed. On account of the insecure state of the central tower in 1883 it was taken down; and its reconstruction, exactly as it stood with the exception of the four corner turrets added early in the 19th century, was completed in 1886. The choir was reopened in 1889 after being closed, for thorough restoration, for six years.

In 1895 the restoration of the west front and other parts was begun in the face of considerable adverse criticism; but the work was carried on with the utmost care. During the carrying out of this work many interesting discoveries were made, the most important being the site of the cruciform Saxon church, enclosed within a crypt under the south transept. Catherine of Aragon was interred in the cathedral in 1536, and Mary Queen of Scots in 1587, but the body of the Scottish queen was removed to Westminster Abbey in 1612. Both interments were superintended by Robert Scarlett the sexton, commonly known as "Old Scarlett," whose portrait, a copy of the original, hangs in the west transept. He died in 1594 at the age of 98. Of the monastic buildings there are some interesting remains. The cathedral is approached by a Norman gateway, above which is the chapel of St Nicholas, built by Abbot Benedict, and now used as the music school, and on the left the chapel of St Thomas à Becket, built by Abbot Ashton in the 13th century as it stands, but originally Norman. The gateway to the bishop's palace, formerly the abbot's house, was built by Abbot Godfrey de Croyland in 1319, and the deanery gate by Abbot Kirton about 1520. One of the canonry houses is formed partly from a hall of the 13th century.

Peterborough is included for civil purposes in the parish of St John the Baptist, but for ecclesiastical purposes it is divided into four, the additional parishes being St Mary's Boongate (1857), St Mark's (1858) and St Paul's (1869). The old parish church of St John originally stood to the east of the cathedral, but was rebuilt on its present site in the centre of the city (1401-1407) in Perpendicular style. The educational establishments include the Henry VIII. grammar or chapter school, which used the chapel of St Thomas à Becket until 1885; the St Peter's training college for schoolmasters for the dioceses of Peterborough, Ely and Lincoln, erected from designs of Sir Gilbert Scott (1864); and Deacon's and Ireland's charity school, established in 1721 for the clothing and educating of twenty poor boys. The principal public building is the market house (1671), used as a town-hall. The modern prosperity and rapid growth of the town are chiefly due to the trade caused by the junction of so many railway lines. Adjoining the town are extensive works and sheds connected with the Great Northern and Midland railways. The principal manufacture is that of agricultural implements. The parliamentary borough returns one member (since 1885). The municipal borough, incorporated in 1874, is under a mayor, 6 aldermen and 18 councillors. Area, 1878 acres. The soke or liberty of Peterborough, with a population of 41,122, constitutes a separate administrative county (1888). The diocese of Peterborough includes the whole of Rutland, nearly all Leicestershire and Northamptonshire, and small portions of Derbyshire and Huntingdonshire.

Peterborough (*Burgh, Burgus sancti Petri*) is proved by its original name Medehamstede to have been a Saxon village before 655 when Saxulf, a monk, founded the monastery on land granted to him for that purpose by Penda, king of Mercia. Its name was altered to Burgh between 992 and 1005 after Abbot Kenulf had made a wall round the minister, but the town does not appear to have been a borough until the 12th century. The burgesses received their first charter from "Abbot Robert," probably Robert of Sutton (1262-1273). Until the 19th century the dean and chapter, who succeeded the abbot as lords of the manor, appointed a high bailiff, and the constables and other borough officers were elected at their court leet, but the borough was incorporated in 1874 under the government of a mayor, 6 aldermen and 18 councillors. Among the privileges claimed by the abbot as early as the 13th century was that of having a prison for felons taken in the soke and borough. In 1576 Bishop Scamble sold the lordship of the hundred of Nassalburgh, which is coextensive with the soke, to Queen Elizabeth, who

gave it to Lord Burghley, and from that time until the 19th century he and his descendants, marquesses of Exeter, had a separate gaol in Peterborough for prisoners arrested in the soke. The trades of weaving and woolcombing were carried on in Peterborough in the 14th century. The abbot formerly held four fairs, of which two, one called St Peter's fair, granted in 1189 and now held on the second Tuesday and Wednesday in July, and the other called the Bridge fair, granted in 1439 and held on the first Tuesday, Wednesday and Thursday in October, still survive and were purchased by the corporation from the ecclesiastical commissioners in 1876. Peterborough sent two members to parliament for the first time in 1547.

PETERBOROUGH AND MONMOUTH, CHARLES MORDAUNT, EARL OF (c. 1658-1735), English soldier and statesman, was born about 1658. His father, John Mordaunt, was created Viscount Mordaunt of Avalon and Baron Mordaunt of Reigate, Surrey, in 1659;¹ his mother was Elizabeth, the daughter and sole heiress of Thomas Carey, the second son of Robert Carey, 1st earl of Monmouth.² He matriculated at Christ Church, Oxford, on the 11th of April 1674. When about sixteen years of age he joined Sir John Narborough's fleet in the Mediterranean, and won his first distinction in arms in the destruction of the dey's fleet under the very guns of Tripoli. His father died on the 5th of June 1675, and Charles Mordaunt succeeded to the peerage as Viscount Mordaunt. On his return from the second expedition to Tangier he plunged into active political life as a zealous Whig and an unsparing opponent of the duke of York. But his continued hostility to James II. forced him to repair to Holland in 1686, when he proposed to William of Orange to invade England. The disposition of the cold and cautious William had little in common with the fierce and turbulent Mordaunt. His plan was rejected, though the prudent prince of Orange deemed it judicious to retain his services. When William sailed to Torbay his friend accompanied him, and when the Dutch prince was safely established on the throne of England honours without stint were showered upon Lord Mordaunt. He was sworn of the privy council on the 14th of February 1689, on the 8th of April of the same year appointed first lord of the treasury, and a day later advanced in the peerage by creation as earl of Monmouth.

In less than a year he was out of the treasury, but he still remained by the person of his monarch and was with him in his dangerous passage to Holland in January 1691. He was one of the eighteen peers who signed the protest against the rejection, on the 7th of December 1692, of the motion for the appointment of a committee to inquire into the conduct of the war, and although William had refused his consent to a bill for triennial parliaments in the previous session, Lord Monmouth did not shrink from reintroducing it in December 1693. This led to a disagreement with the court, though the final breach did not take place until January 1697, when Monmouth was accused of complicity in Sir John Fenwick's conspiracy and of the use of "undutiful words" towards the king. He was committed to the Tower, staying in confinement until the 30th of March 1697, and deprived of his employments. Some consolation for these troubles came to him on the 19th of June of the same year, when he succeeded to the earldom of Peterborough, by the death of his uncle Henry Mordaunt, 2nd earl.

The four years after his release from the Tower were mainly passed in retirement, but on the accession of Anne he plunged into political life again with avidity. His first act was to draw down on himself in February 1702 the censure of the House of Commons for the part which he took in the attempt to secure the return of his nominee for the borough of Malmesbury. Through the fear of the ministry that his restless spirit would drive him into opposition to its measures if he stayed at home, he was appointed early in 1705 to command an expedition of

¹ A barony of Mordaunt by writ had existed in the family since 1529, and the viscount was the second son of the fifth of these barons, who in 1628 was created earl of Peterborough, the elder son Henry being second earl.

² Cr. 1628. This peerage became extinct in 1661 on the death of the 2nd earl.

English and Dutch troops in Spain. He was created the sole commander of the land forces in April 1705 and joint-commander with Sir Cloudesley Shovel of the fleet on the 1st of May, after he had been reinstated a member of the privy council on the 29th of March. He arrived at Lisbon on the 20th of June 1705, sailed for Barcelona (Aug. 1705) on an expedition for the conquest of Catalonia, and began to besiege that town. For some weeks the operations were not prosecuted with vigour and Peterborough urged that the fleet should transport the troops to Italy, but the energetic counsels of the Archduke Charles at last prevailed and by the 14th of October the city fell into his hands. On the 24th of January 1706 he entered Valencia in triumph, but these movements had weakened the garrison at Barcelona, which was now besieged by a superior French force under Tessé. The garrison, commanded by the archduke, defended their positions with great bravery, but would have been obliged to surrender had not the fleet of Sir John Leake, answering the appeals of Charles but contrary to the original orders of Peterborough, come to their assistance on the 8th of May, whereupon the French raised the siege on the 11th of May. It is difficult to understand the action of Peterborough during this campaign, unless on the supposition that he was out of sympathy with the movement for placing an Austrian prince on the throne of Spain. When Charles determined upon uniting with Lord Galway's troops and marching to Madrid, the advice of Peterborough again hindered his progress. At first he urged an advance by Valencia as supplies had there been collected, then he withdrew this statement; afterwards he delayed for some weeks to join Galway, who was in need of succour, but ultimately reached the camp on the 6th of August. The leaders of the army differed in their views, and Lord Peterborough was recalled to England to explain his conduct (March 1707).

On his return to England in August he allied himself with the Tories, and received his reward in being contrasted, much to his advantage, with the Whig victor of Blenheim and Malplaquet. The differences between the three peers, Peterborough, Galway and Tyrwaley, who had served in Spain, formed the subject of angry debates in the Lords, when the majority declared for Peterborough; after some fiery speeches the resolution that he had performed many great and eminent services was carried, and votes of thanks were passed to him without any division (January and February 1708). His new friends were not desirous of detaining him long on English soil, and they sent him on a mission to Vienna, where he characteristically engaged the ministry in pledges of which they disapproved. His resentment at this disagreement was softened by the command of a cavalry regiment, and by his appointment as a Knight of the Garter (Aug. 3 and 4, 1713). With the accession of George I. Lord Peterborough's influence was gone. Worn out with suffering, he died at Lisbon on the 25th of October 1735. His remains were brought to England, and buried at Turvey in Bedfordshire on the 21st of November.

Lord Peterborough was short in stature and spare in habit of body. His activity knew no bounds. He was said to have seen more kings and positions than any man in Europe, and the whole point of Swift's lines on "Mordant" consisted in a description of the speed with which he hastened from capital to capital. He was eloquent in debate and intrepid in war, but his influence in the senate was ruined through his inconsistency, and his vigour in the field was wasted through his want of union with his colleagues. His first wife, Carey, daughter of Sir Alexander Fraser of Dores, Kincardineshire, died on the 13th of May 1709, and was buried at Turvey. Some years later (1722) he secretly married Anastasia Robinson (c. 1695-1755), a famous dramatic singer (from 1714) of great beauty and sweetness of disposition, daughter of Thomas Robinson (d. 1722), a portrait painter; but she was at first unrecognized as his wife, and lived apart from him (regarded merely as his mistress) with her two sisters at Parson's Green. She remained on the operatic stage, till 1724. It was only a few months before his death that (after a second marriage ceremony) she

was introduced to society as the countess of Peterborough. He had a son John (1681-1710) who predeceased him, and was therefore succeeded in the title by his grandson Charles (1710-1779), whose son Charles Henry (1758-1814), 5th earl, died unmarried, the honours becoming extinct, except for the barony of Mordaunt which passed to a collateral branch and fell into abeyance in 1836.

BIBLIOGRAPHY.—The best accounts of the career of Peterborough are in the life by William Stebbing (1890), and the *War of the Succession in Spain*, by Colonel the Hon. Arthur Parnell (1905). The earlier lives are founded on the memoir of Captain George Carleton (1728), which was analyzed by Colonel Parnell, and dismissed as a fictitious narrative inspired by Swift, in the *Eng. Hist. Rev.* (1891), vi. 97-151. (W. P. C.)

PETERHEAD, a municipal and police burgh, and seaport of Aberdeenshire, the most easterly town in Scotland. Pop. (1901), 11,794. It is situated about 33 m. by road E.N.E. of Aberdeen and 44½ m. by rail, via Maud Junction, on the Great North of Scotland railway, from which there is a branch line. The town is built of the red granite for which it is famous, and the quarrying of which for home and foreign use constitutes an important industry. Among the principal buildings are the town-house (1788), with a spire 125 ft. high, and the Arbuthnot museum and art gallery. In front of the town-hall is a statue to Field Marshal Keith (born at Inverurie Castle, 2 m. north-west, in 1696), which was presented to the burgh in 1868 by William I. of Prussia, afterwards German emperor. Peterhead is one of the Elgin district group of parliamentary burghs, with Banff, Cullen, Elgin, Inverurie and Kintore. It formerly had an extensive trade with the ports of the Baltic, the Levant and America, and was once a sub-port to Aberdeen, but was made independent in 1832. It was also for a long period the chief seat of the Greenland trade, but the Arctic seal and whale fishery is now extinct. The north and south harbours lie between the town and Keith Inch—a suburb at the extremity of the peninsula on part of which the town is built—and the isthmus dividing them is pierced by a canal crossed by an iron swing-bridge. In the north harbour are two graving docks. A third harbour has been built, the area of the three basins amounting to 21 acres. In addition to the granite quarrying and polishing, the leading industries are ship- and boat-building, agricultural implement works and woollen manufactures. The herring fleet possesses more than 600 boats and the annual catch averages nearly £200,000. About a mile to the south is the convict prison for Scotland. Since 1886 the prisoners have been employed upon the construction of a vast harbour of refuge, for which the breakwater extends from Boddam Point northwards across the bay. This great undertaking (intended to be completed in 1921) was designed by Sir John Coode (d. 1892). Peterhead is the terminus of a cable to Norway. About 6 m. south of Peterhead are the famous Bùllers, or Roarers, of Buchan, an enormous rocky cauldron into which the waves pour through a natural arch of granite, with incredible violence, in a storm.

The town and lands belonged of old to the Abbey of Deer, built in the 13th century by William Comyn, earl of Buchan; but when the abbey was erected into a temporal lordship in the family of Keith the superiority of the town passed to the earl marischal, with whom it continued till the forfeiture of the earldom in 1716. The town and lands were purchased in 1720 by a fishing company in England and, on their failure, by the Merchant Maidens' Hospital of Edinburgh for £3000, who are still the overlords. Peterhead, made a burgh of barony in 1593 by George Keith, fifth earl marischal, was the scene of the landing of the Pretender on Christmas Day 1715.

PETERHOF, a town of Russia, in the government of St Petersburg, 18 m. W. of the capital, on the south coast of the Gulf of Finland. It was founded in 1711 and has grown up round the palace built by Peter the Great in 1720; pop., 11,300. Peterhof is almost exclusively a residential town, but gem-cutting and the manufacture of agricultural implements are carried on. The palace has undergone alterations and additions, e.g. by Catherine II., but retains a distinct Petrine stamp. It is built

on a height 50 ft. above the sea, and contains portraits of the Russian imperial family and other pictures. A statue of Peter the Great was set up near the palace in 1883, and one of Francis I. of France in 1896, a gift from the town of Havre to Nicholas II. Peterhof is connected with Oranienbaum on the west and with Stryelna on the east by series of gardens and villas.

PETERMANN, AUGUST HEINRICH (1822-1878), German cartographer, was born at Bleicherode, near Nordhausen, on the 18th of April 1822. At the age of seventeen he entered the Geographical School of Art in Potsdam, and in 1845 proceeded to Edinburgh to assist Dr Keith Johnston in the production of an English edition of the *Physical Atlas* of Berghaus. In 1847 he came to London, and published among other works, an account of Barth's expedition to Central Africa (1855). In 1854 he became director of the geographical institute of Justus Perthes in Gotha, and editor of the well-known *Petermanns Mitteilungen*. His work did much towards elucidating the geography of the interior of Africa and of the North Polar regions. Queen Victoria, at the suggestion of Bunsen, appointed him physical geographer-royal. Petermann died by his own hand at Gotha on the 25th of September 1878.

PETERS (or **PETREX**), **HUGH** (1598-1660), English Independent divine, son of Thomas Dyckwoode, alias Peters, descended from a family which had quitted the Netherlands to escape religious persecution, and of Martha, daughter of John Treffry of Treffry in Cornwall, was baptized on the 29th of June 1598, and was educated at Trinity College, Cambridge. Having experienced conversion, he preached in Essex; returning to London he took Anglican orders and was appointed lecturer at St Sepulchre's. He entertained, however, unorthodox opinions, and eventually left England for Holland. He visited Gustavus Adolphus in Germany about 1632, and afterwards became the minister of the English church at Rotterdam. Here his unorthodox leanings again attracted attention, and Peters made a further move to New England. He was connected with John Winthrop through his wife, and had already formed several friendships with the American colonists. He arrived at Boston in October 1635 and was given charge of the church at Salem. He took a leading part in the affairs of the colony, and interested himself in the founding of the new colony in Connecticut. In 1641 he returned to England as agent of the colony, but soon became involved in the political troubles which now began. He became chaplain to the forces of the adventurers in Ireland, and served in 1642 in Lord Forbes's expedition, of which he wrote an account. On his return he took a violent part in the campaign against Laud, and defended the doctrines of the Independents in a preface to a tract by Richard Mather entitled "Church Government and Church Covenant discussed . . ." (1643). He gained great reputation as a preacher by his discourses and exhortations at public executions, and as army chaplain. In the latter capacity he accompanied Lord Warwick's naval expedition to Lyme in 1644 and Fairfax's campaigns of 1645 and 1646, when his eloquence is said to have had a marvellous effect in inspiring the soldiers and winning over the people. At the conclusion of the war, Peters, though greatly disliked by the Presbyterians and the Scots, had attained great influence as leader of the Independents. In his pamphlet "Last Report of the English Wars" (1646) he urged religious toleration, an alliance with foreign Protestants, and an active propagation of the gospel. In the dispute between the army and the parliament he naturally took the side of the former, and after the seizure of the king by the army in June 1647 had interviews with Charles at Newmarket and Windsor, in which he favourably impressed the latter, and gave advice upon the best course to pursue. He performed useful services in the second Civil War, procured guns for the besiegers at Pembroke, raised troops in the midlands, and arranged the surrender of the duke of Hamilton at Uttoxeter. Though at the Restoration he denied any complicity in the king's death, it is certain that in his sermons he justified and supported the trial and sentence. In August he accompanied Cromwell to Ireland, and was present at the fall of Wexford.

while later he assisted the campaign by superintending from England the despatch to Cromwell of supplies and reinforcements, and was himself destined by Cromwell for a regiment of foot. In 1650 he was in South Wales, endeavouring to bring over the people to the cause, and subsequently was present at the battle of Worcester. At the conclusion of the war Peters was appointed one of the preachers at Whitehall and became a person of influence. Parliament had already voted him an annuity of £200, and Laud's library or a portion of it had been handed over to him in 1644. He was one of the committee of twenty-one appointed to suggest legal reforms, and he published his ideas on this subject, which included a register of wills and land titles and the destruction afterwards of the ancient records, in his tract, "Good Work for a Good Magistrate" (in 1651), answered by R. Vaughan and Prynne. He strongly disapproved of the war with Holland, and his interference brought upon him some sharp reprimands. In July 1658 he was sent to Dunkirk to provide apparently for the spiritual wants of the garrison. He preached the funeral sermon on Cromwell, and after the latter's death took little part in political events, though strongly disapproving of the removal of Richard. He met Monk at St Albans on the latter's march to London, but met with no favour from the new powers, being expelled from his lodgings at Whitehall in January 1660. On the 11th of May his arrest was ordered. On the 18th of June he was exempted from the Act of Indemnity and apprehended on the 2nd of September at Southwark. He sent in a defence of himself to the Lords, denying any share in the king's death. He was, however, tried on the 13th of October and found guilty of high treason. His execution took place at Charing Cross on the 16th of October, when he behaved with great fortitude, and was undismayed by the mangling of the body of John Cook, his fellow sufferer, upon which he was forced to look. Before his death he wrote "A Dying Father's Last Legacy" to his only child, Elizabeth, in which he gave a narrative of his career.

His death was viewed with greater rejoicings than perhaps attended that of any of the regicides, which is the more surprising as Peters possessed many amiable qualities, and several acts of kindness performed by him on behalf of individual Royalists are recorded. But he had incurred great unpopularity by his unrestrained speech and extreme activity in the cause. He was a man, however, of a rough, coarse nature, without tact or refinement, of strong animal spirits, undeterred by difficulties which beset men of higher mental capacity, whose energies often outran his discretion, intent upon the realities of life and the practical side of religion. His conception of religious controversy, that all differences could be avoided if ministers could only pray together and live together, is highly characteristic, and shows the largeness of his personal sympathies and at the same time the limits of his intellectual imagination. Peters married (1) Elizabeth, daughter of Thomas Cooke of Pebarah in Essex and widow of Edmund Read, and (2) Deliverance Sheffield, by whom he had one daughter, Elizabeth.

PETERS, KARL (1856—), German traveller in Africa, one of the founders of German East Africa, was born at Neubaus on the Elbe on the 27th of September 1856, the son of a Lutheran clergyman. He studied at Göttingen, Tübingen and Berlin, and in 1879 was awarded a gold medal by the Berlin University for his *Frieden zu Venedig*. After visiting London to study English principles of colonization, he returned to Berlin and promoted the German Colonization Society (*Deutsche Kolonialverein*). In the autumn of 1884 he proceeded with two companions to East Africa, and concluded in the name of his society treaties with the chiefs of Useghu, Nguru, Usagara and Ukami. Returning to Europe early in 1885, he formed the German East Africa Company, which speedily obtained an imperial charter. The story of this enterprise, the first step in the formation of a German colony in East Africa, is told under AFRICA, § 5. In 1888 Peters undertook an expedition from the east coast of Africa, avowedly for the relief of Emin Pasha. This expedition was not sanctioned by the German government and was regarded

by the British authorities as a filibustering exploit. One of its objects was to extend the sphere of German influence, and, reaching Uganda early in 1890, Peters concluded a treaty with the king of that country in favour of Germany. He left Uganda hastily on the approach of a representative of the British East Africa Company, and on reaching Zanzibar learned that his treaty was useless, as an agreement had been come to between Germany and Great Britain whereby Uganda was left in the British sphere. On his return to Germany Peters was received with great honours, and in 1891 published an account of his expedition entitled *Die deutsche Emin Pasha Expedition*, which was translated into English. In 1891 he went out again to East Africa as imperial high commissioner for the Kilimanjaro district, and in 1892 was one of the commissioners for delimiting the Anglo-German boundary in that region. In June 1892 accusations were brought against him of excesses in his treatment of the natives, and after three investigations had been held he was, in 1897, deprived of his commission for "misuse of official power." (He was regranted his title of imperial commissioner in 1906.) During 1893-1895 Peters was employed in the colonial office at Berlin. In 1896 he removed to London, where he occupied himself in schemes for exploiting parts of Rhodesia and Portuguese East Africa. In the interests of a company he formed, Peters explored the Fura district and Macombe's country on the Zambesi, where in 1899 he discovered ruins of ancient cities and deserted gold mines. He returned in 1902 and gave an account of his explorations in *The Eldorado of the Ancients* (1902). In 1905 he again visited the region between the Zambesi and Sabi rivers.

Besides the books already mentioned and some smaller treatises Peters published a philosophic work entitled *Willenswelt und Weltwille* (1883), and a disquisition on early gold production entitled *Das goldene Ophir Salomos* (1895), translated into English in 1898.

PETERSBURG, a city and port of entry of Virginia, U.S.A., on the Appomattox river, at the head of navigation, about 11 m. from its mouth, and 22 m. S. of Richmond. Pop. (1890), 22,680; (1900), 21,810, (10,751 negroes); (1910), 24,127. It is served by the Atlantic Coast Line, the Seaboard Air Line and the Norfolk & Western railways. The river, which is here spanned by two steel bridges and one frame bridge, is navigable to this point for vessels of 8 ft. draught at mean high water, and has been greatly improved by the Federal government, which in 1909 was engaged in deepening the whole channel to 12 ft. at mean high water and in excavating at Petersburg a new channel into which to deflect the river. In and about the city there is much of historic and scenic interest. At Blandford, a suburban hamlet, is the picturesque old Blandford church, erected about 1734. Petersburg has two public parks, and among its institutions are a home for the sick (1886), an orphanage for girls and another for negroes, the state central hospital for the insane (negroes), the southern female college (non-sectarian, 1863), the university school for boys, the Bishop Payne divinity school (Protestant Episcopal) for negroes, and the Virginia normal and industrial institute (opened in 1883), also for negroes. There are two national cemeteries near Petersburg—Poplar Grove (about 4 m. south), containing about 6200 graves, and City Point (about 9 m. east), containing about 5700 graves; and in Blandford cemetery there are about 30,000 graves of Confederate dead. In this cemetery General William Phillips is buried, and there is a monument to Captain McRae, commander of the "Petersburg Volunteers," whose bravery in 1812-1813 prompted President Madison to call Petersburg the "Cockade City." The falls above the city furnish abundant water-power, and the city has various manufactures. The factory product was valued at \$5,890,574 in 1905, 11.3% more than in 1900; in both 1900 and 1905 Petersburg ranked fourth among the cities of the state in the value of factory products. From Petersburg are shipped quantities of trunks and bags, peanuts, tobacco and cotton. In 1909 the foreign trade, wholly imports, was valued at \$360,774. The city was formerly in Chesterfield, Dinwiddie and Prince George counties, but is now independent of county government.

An Indian village formerly stood on or near the site of the present city, and Fort Henry was built here by the whites in 1645. Petersburg was founded in 1733 by Colonel William Byrd (1674-1744) and Peter Jones, and was named (first Peter's Point, and then Petersburg) in honour of the latter; in 1748 it was incorporated as a town. On the 25th of April 1781 a skirmish was fought in front of Petersburg between a British force of about 3000 under General William Phillips (1731?-1781) and about one-third of that number of American militia under Baron Friedrich Wilhelm von Steuben; the Americans were defeated, and the British occupied the town. In the following month the British again entered Petersburg (General Phillips dying here on the 13th), but they were soon dislodged by Lafayette who shelled the town. General Winfield Scott was born near Petersburg, and practised law here for two years before he entered the army. Petersburg was chartered as a city in 1850.

PETERSBURG CAMPAIGN (1864-65). The name of Petersburg is associated with operations in the American Civil War, which formed the sequel of the Wilderness Campaign (q.v.) and the last act in the struggle between the armies of Grant and Lee for supremacy. Petersburg (see above) and Richmond, Virginia, connected by rail and covered north, east and south by forty miles of entrenchments, formed the salients of a vast fortress, into which reinforcements and supplies could be poured from the rear by means of the James Canal, the Virginia Central, the Lynchburg, the Danville and the Weldon railroads—the latter bringing up to Petersburg from Wilmington (225 m. distant) the cargoes of blockade runners. Petersburg became a strategic point as soon as Grant determined to carry the army of the Potomac—defeated at Cold Harbor on the Chickahominy (see WILDERNESS CAMPAIGN)—south of Richmond, and, being joined by Butler's Army of the James (momentarily checked in the Bermuda Hundred Peninsula by a small army under Beauregard), to operate from the east, depending on the James river, as his line of supply, while the policy of the Confederate president was to employ Robert E. Lee's army to protect his capital. Petersburg was nearer than Richmond to the navigable part of the James River—City Point is only 10 m. distant—and the capture of Petersburg would involve the fall of Richmond and the capitulation or flight of Lee's army.

As early as the 9th of June 1864, while the main armies were still north of the James and Petersburg was garrisoned by a brigade under General Wise, a Federal expedition from the Army of the James approached the city. General Gillmore on the City Point road discovered strong earthworks, and General Kautz attacking on the Jerusalem Plank road experienced a repulse: the total force of the Federals was 4500, and Wise's brigade (2400) had been quickly reinforced from Beauregard's central position at Bermuda Hundred. A week later a more serious attempt was made to break through the defences, while General Lee's main army was detained north of Richmond. Grant detached the II. and XVIII. corps under Generals Smith and Hancock, who were to unite and operate along the City Point railroad and capture the outer line of works about 2 m. from Petersburg while a demonstration was made along the Norfolk railroad by cavalry under Kautz. On the 15th of June Smith attacked and captured five redans before Hancock came up, and when next day Burnside's corps (IX.) arrived and General Meade assumed control of the three corps, he attacked again at 6 p.m. On the 17th of June Warren's (V.) corps arrived, and Meade made a third assault with two corps (V., IX.). On the 18th of June the attack was renewed with three corps (II., V., IX.) late in the afternoon, and the results of the four days' fighting were so far satisfactory that ground was won which could be entrenched and held against any sortie of the Petersburg garrison. Probably on the 18th of June the town of Petersburg might have been captured by Meade, for at this crisis General Lee was in temporary eclipse. For four days Lee had refused to credit any report to the effect that Grant was crossing the James: his cavalry could not ascertain that the enemy in his

front at Malvern Hill (VI. corps and Wilson's cavalry division), despite its menacing attitude towards Richmond, was only a flank guard for a movement to the south.

It was late on the 17th of June when General Beauregard, who had for three days valiantly held his main lines south of Richmond with some 14,000 infantry against three Federal corps, succeeded in convincing General Lee that the main army was again (as in 1862 on the Chickahominy) in the wrong place at the wrong time. But when at last the Confederate leader was aroused to a sense of his danger he soon filled every road with divisions marching to save Petersburg: they marched all night; they slept in the trenches on arrival, and on the 19th of June these reinforcements convinced General Meade that his main attack between the Appomattox river and the Jerusalem Plank road was delivered a day too late. At a cost of 10,000 casualties Meade had gained half a mile of ground, but the Confederates in falling back had concentrated, and now that the new plan of operations was exposed and the main bodies were again face to face the power of defensive tactics reasserted itself.

Yet June was not to close without adding some 8000 men to the Federal casualties, for in addition to daily losses by sharp-shooting along the front, over 5000 men fell or were captured in operations directed against the southern railroads. Grant had resolved to deprive his enemy of these lines of supply: his plan was to prolong his line of investment westward and construct redoubts (such as Fort Davis, Fort Steadman and Fort Sedgwick) as a continual menace to the Confederate garrison and a defence against sorties, while his cavalry and portions of five corps (II., V., VI., IX. and XVIII.) engaged in enterprises which it was hoped would tempt General Lee to fight outside his works. A decisive victory in the field, a successful assault on the defences between Richmond and Petersburg, or the complete destruction of the railroads, would precipitate disaster to the South, and of these three methods the last would be the surest in its effects. But such a method was necessarily slow. General Wilson's cavalry (5500) destroyed 30 m. of the Lynchburg or South Side railroad, and 30 m. of the Danville railroad, together with Burkesville Junction and Ream's Station on the Weldon railroad; but Wilson was caught by the Confederate cavalry 100 m. from Petersburg and escaped only by destroying his wagons and limbers and abandoning twelve guns. Even the Virginia Central railroad could not be held by the Federals after Sheridan with the main body of the cavalry had been called back to White House on the Pamunkey to escort a great convoy.

By the end of June the whole of the rival forces were concentrated about the Richmond-Petersburg defences, and General A. F. Hill had already sallied out on the 21st of June to drive the II. corps from the Weldon railroad. Federal policy and Federal strategy, surmounting the crisis of Cold Harbor, were, however, at last in unison. Grant had a free hand in respect both of his dispositions and his resources in men and money, and had resolved to use unsparingly the resources placed at his disposal. Early in July Grant, however, found himself compelled to detach a corps (VI.) to strengthen the garrison at Washington, for General Early had frustrated Hunter's attempt against Lynchburg (see SHENANDOAH VALLEY), driving Hunter into West Virginia, and then, pushing down the Shenandoah and across the Potomac, had arrived within a day's march of the Federal capital. This operation checked Grant's enterprises about Petersburg and restricted the Federal front to the ground east of the Weldon railroad.

On the 25th of July Grant resolved to weaken the enemy on his front by a demonstration north of the James, and accordingly moved a corps (II.) and two cavalry divisions across the river to Malvern Hill under cover of Foster's corps (X.). But Lee possessed the inner line, and the Federal detachment found two cavalry divisions in its front, and the Richmond defences had been strengthened by three divisions of infantry. The expedition then returned to take part in a fresh enterprise, which ended disastrously to the Federals. A Confederate redan faced Burnside's IX. corps 100 yds. distant, and this strong work was

to be destroyed by mining operations. The mine was fired and produced a crater 150 ft. long, 60 ft. wide and 25 ft. deep, into which the Federals poured (see FORTIFICATION and SIEGE-CRAFT). But the troops could be got no farther before the Confederate counter-attack was upon them, and Burnside's corps lost 4300 men.

In August Sheridan was detached to operate against General Early in the Shenandoah Valley, and in order to prevent Lee reinforcing Early another demonstration against Richmond was planned. But Lee again strengthened his left and the result of the fighting was a loss to the Federals of nearly 3000 men. Meanwhile another attack on the Weldon railroad by Warren's corps was met by General A. P. Hill on the 20th of August, and the possession of the railroad cost the Federals 3000 men. A further attempt on this railroad by Hancock's II. corps and Gregg's cavalry division at a point 3 m. south of Ream's Station was foiled by A. P. Hill, now aided by Hampton's two cavalry divisions, and the Federals here lost 2372 men and nine guns. The Confederates therefore still retained possession of the railroad to a point within one day's hauling by wagon to Petersburg. During September another Federal enterprise north of the James with two corps (X. and XVIII.) resulted in the capture of Fort Harrison near Chaffin's Bluff, and when General Lee reinforced his left and counter-attacked his troops were repulsed with heavy loss. The Federals lost over 2000 men and failed in the attempt to take Fort Gilmer. Confederate gunboats below Richmond aided in the defence. While this operation was in progress on the Confederate left under General Grant's personal supervision General Lee was apprised of attacks on his extreme right at Peebles Farm by four divisions, which captured a Confederate redoubt covering the junction of two routes to the south-west. General A. P. Hill prevented a further advance of the enemy by a vigorous counter-attack which caused Warren and Parke (IX.) a loss of 2000 men, of whom nearly three fourths allowed themselves to be captured; for the ranks, since the losses of the May battles, had been swamped with drafted and substitute recruits of poor quality and almost insignificant training. The Federals had, however, by these operations pushed their entrenchments beyond the Weldon railroad westward and established new works within a mile of the Confederate right. A minor engagement north of the James on the 7th of October between the Confederates and troops of the Army of the James was without result. At the end of the month, however, General Grant resolved to make a serious effort to bring the South Side railroad within his lines and deprive the enemy of this important line of supply. Parke (IX.), Warren (V.) and Hancock (II.) took each some 11,000 infantry with four days' rations on pack animals, Gregg's cavalry (3000) were attached for the operation, and both Grant and Meade accompanied the troops. General A. P. Hill encountered this force with three divisions (14,000) and Hampton's cavalry (5500), and he contrived to hold two corps with one division and attack Hancock (II.) with his main body. The Federals were stopped when 6 m. from the railway, and Hancock lost 1500 men at Hatcher's Run on the 27th of October.

General Lee meanwhile had been called to Chaffin's Bluff, where again Butler was demonstrating with the Army of the James (X. and XVIII.) on the approaches to Richmond. But General Longstreet signaled his return to duty with the Army of Northern Virginia by driving Butler off with a loss of over 1000 men (action of Fair Oaks, Oct. 27). General Warren in December contrived to evade A. P. Hill and destroy the Weldon railroad at a point on the Meherrin river 40 m. from Petersburg.

There seemed now little to tie Lee to the lines he had so painfully constructed, for his army was without coffee, tea or sugar, and though of foreign meat they had 3½ million rations and of bread 2½ million rations in reserve, the troops lived chiefly on corn-bread. A. P. Hill on the right held on from Hatcher's Run to Fort Gregg, whence Gordon and Anderson prolonged to the left as far as the Appomattox River, and Longstreet continued the line northwards along the Bermuda front across the James as far as White Oak Swamp (37 m. in all). The winter was very severe, and the continual

trench-work and outpost duty overtaxed the patriotism of Lee's 50,000 infantry and stimulated desertion. Supplies were brought in by wagons, as the rolling stock on the railways was worn, and on the 5th of February 1865 General Gregg moved out to the Boydton Plank road to intercept the Confederate convoys. He was supported by Warren, while Humphreys's (II.) corps connected the detachment with the left of the Federal entrenchments. Gregg failed to locate the wagons, and General Lee, hearing of the expedition, sent out A. P. Hill and Gordon, who drove him back with a loss of 1500 men. Sheridan, after driving Early from the Valley in October, destroyed the railways about Staunton, Charlottesville, Gordonsville and Lynchburg, and even rendered the James Canal useless as a line of supply.

Grant recalled Sheridan to the main army in March, and at the end of the month prepared for a turning movement westward with the object of drawing Lee out of his lines. General Lee had anticipated such an attempt, and had resolved to abandon his lines and unite with Johnston in North Carolina, but the roads were not

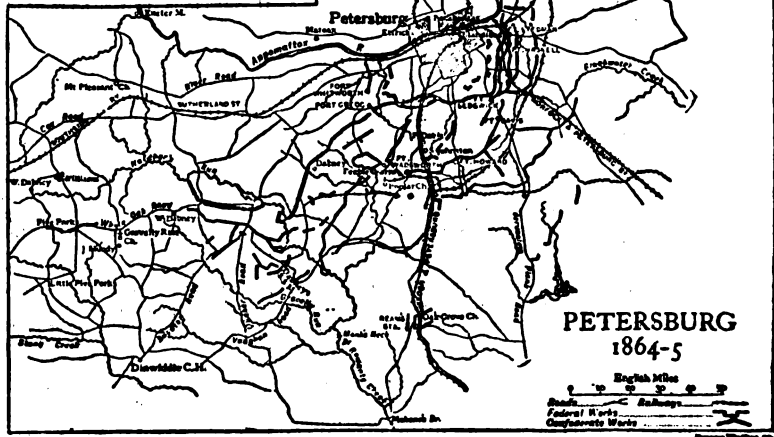
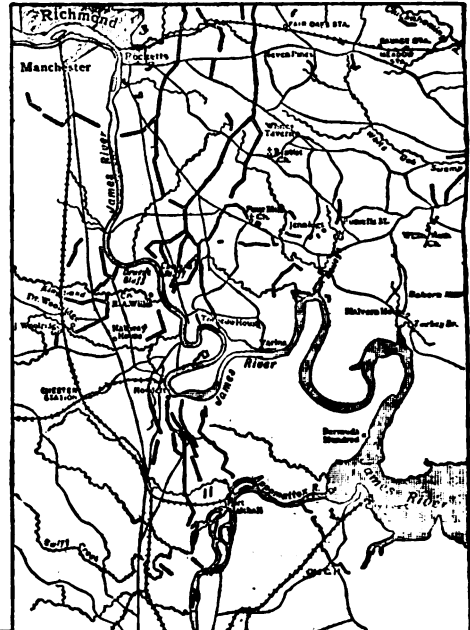

yet in a state for the movement of artillery and wagons, and it was to gain time that he now ventured upon a bold offensive stroke—a night attack upon a strong point in the Federal right called Fort Stedman—the success of which might cause Grant to call in the detachments on his left and so facilitate the proposed movement of the Confederates towards Danville. General Gordon was selected to conduct the operation and his corps was strongly reinforced for the occasion. The opposing lines east of Petersburg were only 150 yds., and the sentries of each side 50 yds. apart. Gordon's men dashed across the intervening space at 4.30 a. m. on the 25th March, surprised the garrison and occupied Fort Stedman, but when daylight broke and the Federal guns could be brought to bear the fort was found to be untenable. Parke's corps (IX.) recaptured the work at a cost of 1000 men, and Gordon fell back, leaving nearly 2000 men in the hands of the Federals. The encounter would have proved a more desperate one if reinforcements on both sides had arrived in time, but Gordon had cut the telegraph which connected Fort Stedman with Grant's headquarters at City Point, and the Confederate train service broke down and delayed the arrival from Richmond of reinforcements for Gordon. Meanwhile, 6 m. westward, Humphreys' corps (II.) attacked A. P. Hill's defences and gained some local success, seizing the Confederate picket line between the Weldon railroad and the Boydton Plank road, which was at once occupied and strengthened by the Federals. The Federals

had resolved to attempt. Grant meanwhile had ordered Warren to support Sheridan in an attack on Pickett at daybreak. Sheridan advanced on the 1st of April and at 3 p.m. issued his orders for attack, explaining verbally a diagram he had prepared for the use of divisional commanders. Pickett held a front of 2 m. with a division of cavalry on either flank and Rosser's cavalry guarding the baggage behind Hatcher's Run, and when attacked at 4 p.m. he was with Rosser 1 1/2 m. in rear. Before Pickett was made aware of a battle being in progress his left was destroyed. General Lee seems to have made no arrangements to support Pickett in this direction. Pickett's right was defended by W. H. F. Lee against the attack of Custer's cavalry division. The position was finally carried by Sheridan's cavalry under Devin dismounting and storming the entrenchments frontally, taking three guns and 100 prisoners. Warren's corps claimed to have captured a battery and 3244 prisoners. Yet Sheridan was dissatisfied with Warren's conduct of the battle and deprived him of his command. Pickett's routed brigades were rallied at the South Side railroad and incorporated with General Anderson's command. But the Confederates had lost White Oak road, and unless General Lee was capable of a vigorous counterstroke on his extreme right it was evident he must also lose the South Side railroad. Grant, fearing such an enterprise, at once reinforced Sheridan and ordered Humphreys' corps (II.) to attack in his front if necessary to prevent Lee moving troops

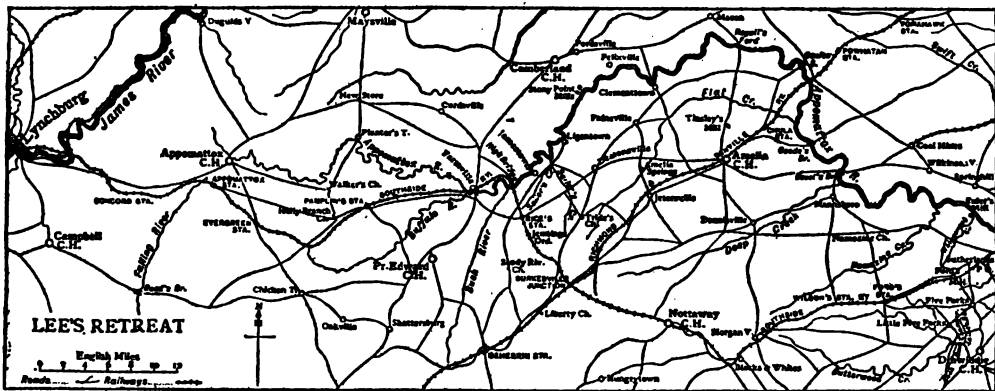

lost 2000 men and the Confederates perhaps twice as many on the 25th of March.

At this time Sherman visited Grant at City Point and proposed to move at the end of ten days on Burkesville Junction and so cut off Lee from Danville and Lynchburg; it was while Sherman was preparing for this operation that Grant finished the campaign. Secure behind his formidable entrenchments, Grant had no fear for his base on the James river, and transferred large bodies of troops to his left without Lee's knowledge. Sheridan was instructed on the 29th of March to gain the enemy's right and rear, moving by Dinwiddie Court-House and across Hatcher's Run. But the Confederates were on the alert; A. P. Hill extended his right, and Fitzhugh Lee's cavalry was brought to Sutherland Station. Sheridan had already encountered the cavalry divisions of W. H. F. Lee and Rosser on the south side of Stony Creek. Warren's corps, moving up the Quaker road, met a force under R. H. Anderson and drove it back to its works on White Oak road. Sheridan got into a flat country of dense forest, tangled undergrowth, streams and swamps, and the soil of clay and sand was impassable for wagons and guns until he had corduroyed the route. On the 29th of March General Lee perceived that the object of Grant was to seize the routes south of the Appomattox river, by which a movement south-west could be made to unite with Johnston's army, and he endeavoured to cover these roads, including the South Side railway, without losing his hold upon his works about Richmond and Petersburg, but in such a contest it was evident that numbers must prevail.

Sheridan's cavalry had reached Five Forks on the White Oak road on the 31st of March, and on his right Humphreys and Warren (II. and V.) held the Confederates to their works along Hatcher's Run astride the Boydton Plank road; yet General Lee was able to concentrate his three cavalry divisions, and supported them by Pickett's five infantry brigades. Sheridan was attacked and driven south as far as Dinwiddie Court-House; but Humphreys and Warren held their ground (action of White Oak Ridge) at a cost of 2000 men. Pickett and the cavalry fell back to Five Forks during the night and hastily entrenched, for he had been ordered by General Lee to defend this position; since the Boydton Plank road could no longer be held, the possession of White Oak road and the South Side railway became necessary for the flank movement which Lee

westward, but Lee made no effort, and so Sheridan was free to operate farther in the direction of the enemy's right and rear, while Humphreys held the enemy in his front. Sheridan remained inactive for a few days, and Lee hoped still to gain time for the roads to dry before evacuating his lines and removing his stores and ammunition by wagons towards Lynchburg.

But a crisis was approaching. Sheridan's success at Five Forks induced Grant to deliver a general assault on the 2nd of April. The Confederate lines were bombarded all night, and on the 2nd of April with Wright's corps (VI.), Grant attacked the weakest part of Lee's line and broke through, losing 1100 men in fifteen minutes. A. P. Hill was killed and his corps broke and was cut off from Petersburg. At the same time Parke's corps (IX.), on the right of the VI., attacked the eastern front near Fort Stedman but was repulsed by General Gordon; then Humphreys' corps (II.) on the left attacked a Confederate division under General Cook and forced it to retreat to the South Side railroad, where at Sutherland Station a final attack dispersed it. Wright, supported by General Ord (commanding the army of the James), afterwards won the strong redoubts called Fort Whitworth and Fort Gregg, and thus in a day the Confederate right had been destroyed from Five Forks to a point some two or three miles west of the Weldon railroad; 10 m. of works had been abandoned, and if Grant had been able to press his advantage at once the campaign must have ended. But Grant was not aware of the enemy's plight, and so resolved to wait until the morrow before completing his victory.

Meanwhile Lee perceived that the hour had come as last when Richmond must fall, and at 3 p.m. he issued orders for the march of the remains of his army to Lynchburg via Amelia Court-House, a march which evidently must partake of the character of a forlorn hope, hastily planned, ill prepared and undertaken by troops whom the disasters and hardships of the past six months had weakened physically and morally. Yet if General Lee had negotiated a peace on the 2nd of April military history would have lost one of the finest examples of the strategic pursuit. Lee's proposed movement involved the transfer of the army and its baggage 100 m. on bad roads across the front of an enemy, and nothing but mischance could prevent the Federals intercepting Lee's columns by a shorter route and seizing the South Side railroad, on which supplies

were to be forwarded from Lynchburg to meet the retreating army at Appomattox Station, Pamplin's Station or Farmville Station. The Appomattox River must be crossed two or three times at its bends. Various creeks and swamps must be bridged, and the bridges destroyed after crossing. The wagons must move on separate roads so as to be covered by the columns during marches and combats and the infantry were to follow the artillery on the roads. Longstreet, Gordon and Mahone's division from Richmond all crossed the Appomattox at Goode's Bridge. Ewell from Richmond crossed the Appomattox by the Danville railroad bridge north of Goode's Bridge. Anderson commanded the flank guard which moved south of the Appomattox with Fitzhugh Lee's cavalry. Lee gained a day's start by moving at 8 p.m., for Grant was making preparations to attack the entrenchments next day (April 3), but the start was lost in waiting for President Davis and the government to escape from Richmond. Sheridan's cavalry got in touch with Lee's flank-guard early on the 3rd of April near Nemozine Creek, and at nightfall the Federal advance-guard was at Deep Creek. On the 4th of April Sheridan reached the Danville railroad at Jetersville, and on the 5th of April, when Lee had halted at Amelia Court-House on the railroad to get supplies, the Federals had three corps (II., V., VI.) in support of Sheridan 8 m. nearer than Lee to Sailor's Creek, the point where he must again cross the Appomattox.

Interception was now a *fait accompli*, though neither side suspected it. Lee was unaware of the enemy's proximity, and Grant believed that Lee would remain at Amelia Court-House, but Lee moved west, crossing Flat Creek at sunset on the 5th of April, to the Lynchburg railroad (Longstreet, marching all night, reached Rice's Station at sunrise on the 6th of April) while the Federals moved northwards on the same day to attack Lee at Amelia Court-House, and on discovering Lee's evasion the three Federal corps effected a wheel to the left and advanced on Deatonville after bridging Flat Creek. Meanwhile the Federal cavalry under H. E. Davies had located a convoy at Painesville, dispersed its escort (Gary's cavalry) and burned the wagons, but had in turn been attacked by Fitzhugh Lee's cavalry at Amelia Springs and driven back on the main body at Flat Creek. Fitzhugh Lee had then marched to join Longstreet at Rice's Station. The rearguard of Lee's army was Gordon's command, which was at Amelia Springs after Ewell's command had passed through at 8 a.m. on the 6th of April. Lee's army stretched out for 15 m., and when its advance-guard was at Rice's Station its rearguard was still at Amelia Court-House. Rice's Station is 62 m. from Lynchburg. Here Longstreet waited all day for Anderson, Ewell and Gordon to close up, and then at night he moved 8 m. to Farmville Station (68 m. south-west of Richmond), where 80,000 rations had been railed from Lynchburg; then Longstreet crossed the Appomattox, and on the 7th of April moved forward towards Lynchburg, covered by Fitzhugh Lee's cavalry. Meanwhile the remainder of Lee's army had been practically destroyed within a few miles of the point where Longstreet had halted. Sheridan's cavalry and two corps (II., VI.) had caught the commands of Anderson, Ewell and Gordon entangled with the trains of the army attempting the passage of Sailor's Creek; and General Ord would even have attacked Longstreet (whom he had located late at night) had his march been delayed.

Complete disorganization and demoralization seem to have taken hold of the Confederates on this fatal day, and General Lee was once more in eclipse. The Federal cavalry headed the column, the infantry attacked it; and Ewell became the victim of tactical envelopment after Anderson had been defeated and Gordon had failed to save the trains of the army. Surrender or massacre being the alternatives, Ewell surrendered, and here in fact the career of the army of Northern Virginia ended, as Grant plainly saw, for at 5.30 p.m. he addressed a demand to Lee for his capitulation. But Lee clung to his diminished forces for another 48 hours. Longstreet in crossing at Farmville had burnt the bridges and thus delayed Ord in pursuit; but Gordon and Mahone, who had crossed at High Bridge (the railroad bridge), failed to check Humphreys' corps (II.), and so were compelled to take up a position of defence on the north bank until darkness enabled them to slip away. General Lee was with this remnant of the army. Meanwhile Sheridan with the cavalry and two corps (V., XXIV.) had hastened along the South Side railroad, seizing the supplies waiting for Lee at Pamplin's Station, and then moving on another 12 m. to Appomattox Station. At nightfall he found that he was astride the enemy's line of operation, which was also his line of supply, and so General Lee would be compelled to give battle or capitulate on the morrow.

General Lee, quitting Farmville heights on the night of the 7th of April changed the order of march during the next day, so that Gordon (8000) was in the van and Longstreet (15,000) furnished the rearguard. Ewell's corps was now represented by 300 effectives. The cavalry still numbered some 1600 sabres. Lee's column was pursued along the Lynchburg Road by two Federal Corps (II., VI.), which marched 26 m. in 18½ hours, and at midnight halted within 3 m. of Longstreet, who had entrenched near Appomattox Court-House, facing east and covering the road on which Gordon's corps and the cavalry was to press forward to Lynchburg at daylight. But Gordon on the morning of the 9th of April found Sheridan's cavalry in his front, and in accordance with plans made overnight he commenced an attack, driving the Federals back until he encountered

at 10 a.m. two corps of infantry (V., XXIV.) under General Ord, who had marched 29 m. in order to support Sheridan at the crisis; and when at the same moment Longstreet was threatened by Humphreys and Wright (II., VI.) the situation had arisen which General Lee considered would justify surrender, an event which had been anticipated on both sides as the result of the fighting about Farmville on the 6th and 7th of April.

The closing operations from the 29th of March to the 9th of April were all in favour of the Federals, but, nevertheless, the historians counts their losses during this period as nearly 10,000 in the five corps and cavalry which constituted General Grant's field army. On the 9th of April, at the Appomattox Court-House, the two leaders exchanged formal documents by which 2862 officers and 25,494 enlisted men were paroled, all that remained in the field of some 55,000 Confederates who were drawing rations on the 30th of February as the army of Northern Virginia. (G. W. R.)

PETERSFIELD, a market town in the Petersfield parliamentary division of Hampshire, England, 55 m. S.W. from London by the London & South Western railway. Pop. of urban district (1901), 3265. The church of St Peter retains some ornate Norman work. The picturesque market-place contains an equestrian statue of William III.

Ecclesiastically a chapelry of Buriton, Petersfield (Peterfelde) owes its origin as a borough to the charter granted by William, earl of Gloucester, in the reign of Henry II. and confirmed later by his widow, Hawise. Petersfield is not mentioned in Domesday, but it was probably then included in the manor of Mapledurham. It was a mesne borough possessing by its first charter the liberties and customs of Winchester together with a merchant gild. These grants were confirmed by John in 1198 and in 1215 Henry V. in addition freed the burghesses from all tolls. No charter of incorporation has been found. Gradually privileges and rights other than those of a mesne borough were usurped by the mayor and burghesses, but were recovered by a suit brought against them by Thomas Hanbury, owner of the borough, in 1611. A mayor continued to be elected until 1885. Petersfield was represented in parliament in 1307. No return was then made until 1552-1553, from which date two members were regularly returned. In 1832 the number was reduced to one, and in 1885 the representation was merged in that of the county. Three-day fairs at the feasts of St Peter and St Andrew were granted in 1255. In 1892 the summer fair then held on the 10th of July was abolished. The autumn fair now held on the 6th of October is for both business and pleasure. The market, which dates from before 1373, formerly held on Saturday, is now held on alternate Wednesdays. In the 16th century Petersfield had important cloth and leather manufactures.

PETER'S PENCE, **ROME SCOT**, or **ROM-YEON**, a tax of a penny on every hearth, formerly paid annually to the popes; now represented by a voluntary contribution made by the devout in Roman Catholic churches. Its date of origin is doubtful. The first written evidence of it is contained in a letter of Canute (1037) sent from Rome to the English clergy. At this time it appears to have been levied on all families possessed of land worth thirty pence yearly rental, out of which they paid one penny. Matthew Paris says the tax was instituted by Offa, king of Mercia (757-796) for the upkeep of the English school and hostel at Rome. Layamon, however, declares that Ina, king of Wessex (688-725), was the originator of the idea. At the Norman Conquest it appears to have fallen into arrears for a time, for William the Conqueror promised the pope in 1096 that it should be regularly paid. By a bull of Pope Adrian IV. the tax was extended to Ireland. In 1213 Innocent III. complained that the bishops kept 1000 marks of it, only forwarding 300 to Rome. In 1306 Clement V. exacted a penny from each household instead of the 500, 000, at which the tax appears to have been then fixed. The threat of withholding Peter's pence proved more than once a useful weapon against recalcitrant popes in the hands of English kings. Thus in 1366 and for some years after it was refused on the ground of the pope's obstinacy in withholding his consent to the statute of *præmunire*. During the 10th century the custom of Peter's pence was introduced into Poland, Prussia and Scandinavia, and in the 11th century Gregory VII. attempted to exact it from France and

Spain. The tax was fairly regularly paid by the English until 1534, when it was abolished by Henry VIII.

PETERWARDEIN (Hung. *Peterwarad*, Serv. *Petrovaradin*), a royal free town and fortress of Hungary in the county of Syrmia, Croatia-Slavonia; situated on a promontory formed by a loop of the Danube, 62 m. N.W. of Belgrade by rail. Pop. (1900), 5019. It is connected with Neusatz on the opposite bank by a bridge of boats, a railway bridge and a steam ferry. The fortifications consist of the upper fortress, on a lofty serpentine rock rising abruptly from the plain on three sides, and of the lower fortress at the northern base of the rock. The two fortresses can accommodate a garrison of 10,000 men. In the lower fortress is the town, with a military hospital, and an arsenal containing trophies captured from the Turks. Peterwardein, the "Gibraltar of Hungary," is believed to represent the Roman *Acuminum*, and received its present name from Peter the Hermit, who here in 1096 marshalled the levies of the first crusade. It was captured by the Turks in 1526 and retained by them for 160 years. In 1716 it witnessed a signal defeat inflicted on the Turks by Prince Eugène. During the revolutionary struggles of 1848-49 the fortress was held by the insurgents for a short time.

PETHERICK, JOHN (1815-1882), Welsh traveller in East Central Africa, was born in Glamorganshire, and adopted the profession of mining engineer. In 1845 he entered the service of Mehemet Ali, and was employed in examining Upper Egypt, Nubia, the Red Sea coast and Kordofan in an unsuccessful search for coal. In 1848 Petherick left the Egyptian service and established himself at El Obedi, the capital of Kordofan, as a trader, dealing largely in gum arabic. He was at the same time made British consular agent for the Sudan. In 1853 he removed to Khartoum and became an ivory trader. He travelled extensively in the Bahr-el-Ghazal region, then almost unknown, exploring the Jur, Yalo and other affluents of the Ghazal. In 1858 he penetrated to the Niam-Niam country. His additions to the knowledge of natural history were considerable, among his discoveries being the *Cobus maria* (Mrs Gray's waterbuck) and the *Balaeniceps rex* (white-headed stork). Petherick returned to England in 1859 where he made the acquaintance of J. H. Speke, then arranging for his expedition to discover the source of the Nile. While in England Petherick married, and published an account of his travels. He returned to the Sudan in 1861, accompanied by his wife and with the rank of consul. He was entrusted with a mission by the Royal Geographical Society to convey to Gondokoro relief stores for Captains Speke and Grant. Petherick got boats to Gondokoro in 1862, but Speke and Grant had not arrived. Having arranged for a native force to proceed south to get in touch with the absentees, a task successfully accomplished, Mr and Mrs Petherick undertook another journey in the Bahr-el-Ghazal, making important collections of plants and fishes. They regained Gondokoro (where one of their boats with stores was already stationed) in February 1863, four days after the arrival of Speke and Grant, who had meantime accepted the hospitality of Mr (afterwards Sir) Samuel Baker. The charge that Petherick failed to meet his engagement to those travellers is unsubstantiated. A further charge that Petherick had countenanced and even taken part in the slave trade was subsequently shown to have no foundation (Petherick in fact had endeavoured to stop the traffic), but it led Earl Russell, then secretary for foreign affairs, to abolish the British consulate at Khartoum (1864). In 1865 the Pethericks returned to England, and in 1869 published *Travels in Central Africa and Explorations of the Western Nile Tributaries*, in which book are set out the details of the Speke controversy. Petherick died in London, on the 15th of July 1882.

PÉTION DE VILLENEUVE, JÉRÔME (1756-1794), French writer and politician, was the son of a *procureur* at Chartres. He became an avocat in 1778, and at once began to try to make a name in literature. His first printed work was an essay, *Sur les moyens de prévenir l'infanticide*, which failed to gain the prize for which it was composed, but pleased Brissot so much that he printed it in vol. vii. of his *Bibliothèque philosophique*

des législateurs. Péton's next works, *Les Lois civiles*, and *Essai sur le mariage*, in which he advocated the marriage of priests, confirmed his position as a bold reformer, and when the elections to the States-General took place in 1789 he was elected a deputy to the Tiers État for Chartres. Both in the assembly of the Tiers État and in the Constituent Assembly Péton showed himself a radical leader. He supported Mirabeau on the 23rd of June, attacked the queen on the 5th of October, and was elected president on the 4th of December 1790. On the 15th of June 1791 he was elected president of the criminal tribunal of Paris. On the 21st of June 1791 he was chosen one of three commissioners appointed to bring back the king from Varennes, and he has left a famous account of the journey. After the last meeting of the assembly on the 30th of September 1791 Robespierre and Péton were made the popular heroes and were crowned by the populace with civic crowns. Péton received a still further proof of the affection of the Parisians for himself on the 16th of November 1791, when he was elected second mayor of Paris in succession to Bailly. In his mayoralty he exhibited clearly his republican tendency and his hatred of the old monarchy, especially on the 20th of June 1792, when he allowed the mob to overrun the Tuileries and insult the royal family. For neglecting to protect the Tuileries he was suspended from his functions by the Directory of the department of the Seine, but the leaders of the Legislative Assembly felt that Péton's cause was theirs, and rescinded the suspension on the 13th of July. On the 3rd of August, at the head of the municipality of Paris, Péton demanded the dethronement of the king. He was elected to the Convention for Eure-et-Loir and became its first president. L. F. Manuel had the folly to propose that the president of the Assembly should have the same authority as the president of the United States; his proposition was at once rejected, but Péton got the nickname of "Roi Péton," which contributed to his fall. His jealousy of Robespierre allied him to the Girondin party, with which he voted for the king's death and for the appeal to the people. He was elected in March 1793 to the first Committee of Public Safety; and he attacked Robespierre, who had accused him of having known and having kept secret Dumouriez's project of treason. His popularity however had waned, and his name was among those of the twenty-two Girondin deputies proscribed on the 2nd of June. Péton was one of those who escaped to Caen and raised the standard of provincial insurrection against the Convention; and, when the Norman rising failed, he fled with M. F. Guadet, F. A. Buzot, C. J. M. Barbaroux, J. B. Salle and Louvet de Couvrai to the Gironde, where they were sheltered by a wig-maker of Saint Émilion. At last, a month before Robespierre's fall in June 1794, the escaped deputies felt themselves no longer safe, and deserted their asylum; Louvet found his way to Paris, Salle and Guadet to Bordeaux, where they were soon taken; Barbaroux committed suicide; and the bodies of Péton and Buzot, who also killed themselves, were found in a field, half-eaten by wolves.

See *Mémoires inédits de Péton et mémoires de Buzot et de Barbaroux, accompagnés de notes inédites de Buzot et de nombreux documents inédits sur Barbaroux, Buzot, Brissot, &c., précédés d'une introduction par C. A. Dauban* (Paris, 1866); *Œuvres de Péton* (3 vols., 1792); F. A. Aulard, *Les Orateurs de la Constituante* (Paris, 1882).

PÉTIS DE LA CROIX, FRANÇOIS (1653-1713); French Orientalist, was born in Paris in 1653. He was son of the Arabic interpreter of the French court, and inherited this office at his father's death in 1695, afterwards transmitting it to his own son, Alexandre Louis Marie, who also distinguished himself in Oriental studies. At an early age he was sent by Colbert to the East; during the ten years he spent in Syria, Persia and Turkey he mastered Arabic, Persian and Turkish, and also collected rich materials for future writings. He served a short time as secretary to the French ambassador in Morocco, and accompanied as interpreter the French forces sent against Algiers, contributing to the satisfactory settlement of the treaty of peace, which was drawn up by himself in Turkish and ratified in 1684. He conducted the negotiations with Tunis and Tripoli

in 1685, and those with Morocco in 1687; and the zeal, tact and linguistic knowledge he manifested in these and other transactions with Eastern courts were at last rewarded in 1692 by his appointment to the Arabic chair in the Collège Royal de France, which he filled until his death in 1713.

He published *Contes turcs* (Paris, 1707), and *Les Mille et un jours* (3 vols., Paris, 1710-1712); an *Armenian Dictionary* and an *Account of Ethiopia*. But the lasting monument of his literary fame is his excellent French version of Shahrâ'uddîn 'Alî Yazdî's *Zafarnâma* or *History of Timûr* (completed 828 A.H.; A.D. 1425), which was given to the world nine years after his death (4 vols., Paris, 1722; Eng. trans. by J. Darby, London, 1723). This work, one of the rare specimens of a fairly critical history Persia can boast of, was compiled under the auspices of Mirzâ Ibrâhîm Sultân, the son of Shâh Rukh and grandson of the great Timûr. The only error committed by Pétis de la Croix in his otherwise very correct translation is that he erroneously ascribed the important share which Ibrâhîm Sultân had in the *Zafarnâma* to Timûr himself.

PETIT, SIR DINSHAW MANECKJI, BART. (1823-1901), Parsee philanthropist, was born on the 30th of June 1823. As broker to European firms he amassed a large fortune during the period of speculation in Bombay at the time of the American Civil War. In 1886 he became a member of the governor-general's legislative council. He devoted his wealth to philanthropic objects, among the public and private charities which he endowed being the Towers of Silence and fire temples of the Parsees, a hospital for animals, a college for women, and the Petit hospital. He was knighted in 1887, created a baronet in 1890, and died in February 1901.

PETIT DE JULLEVILLE, LOUIS (1841-1900), French scholar, was born in Paris on the 18th of July 1841. Educated at the Ecole Normale Supérieure, and at the French school at Athens, he received his doctorate in literature in 1868. After holding various posts as a teacher he became professor of French mediæval literature and of the history of the French language in the university of Paris in 1886. He died on the 28th of August 1900.

His most important works are: *Histoire du théâtre en France*, including *Les Mystères* (2 vols., 1880); *Les Comédiens en France au moyen âge* (1885); *La Comédie et les mœurs en France au moyen âge* (1886); *Répertoire du théâtre comique en France au moyen âge* (1886); and *Le Théâtre en France, histoire de la littérature dramatique depuis ses origines jusqu'à nos jours* (1889). Petit de Julleville was also the general editor of the *Histoire de la langue et de la littérature française* (3 vols., 1896-1900), to which he himself contributed some valuable chapters.

PETITION (Lat. for "seeking" or "praying"), a term meaning generally a prayerful request, and in its more important constitutional aspect an application for redress by a person aggrieved to an authority capable of relieving him. It may be made in the United Kingdom to the Crown or its officers, or to either house of parliament, or in certain cases to courts of justice.

Petitions to the Crown.—The right of petitioning the Crown was recognized indirectly as early as Magna Carta in the famous clause, *Nulli vendemus, nulli negabimus aut differemus, rectum vel justitiam* (25 Edw. I. c. 29), and directly at various periods later, e.g. in the articles of the Commons assented to by Henry IV., by which the king was to assign two days in the week for petitions (*Rot. Parl.* 8 Hen. IV., p. 585). The case of the seven bishops in 1688 confirmed the right, and finally the Bill of Rights in 1689 declared "that it is the right of the subjects to petition the king, and all commitments and prosecutions for such petitioning are illegal." Petitions to the Crown appear to have been at first for the redress of private and local grievances, or for remedies which the courts of law could not grant (*May, Parl. Pr.*, 11th ed., 522). As equity grew into a system, petitions of this kind not seeking legislative remedies tended to become superseded by bills in chancery. Statutes were originally drawn up by the judges at the close of the session of parliament from the petitions of the Commons and the answers of the Crown. Under this system of drafting it was found that the tenor of the petition and answer were not always stated correctly. To obviate this inconvenience demands for legislation came in the reign of Henry VI. to be drawn up in the form of bills which the Crown could accept or reject, but could not alter (see Anson, *Law and Custom of the*

Constitution, 3rd. ed., vol. i. p. 241). In the same reign the words "by authority of parliament" were added to the words of enactment, and from the time of Henry VII public legislation has been by bill and not by petition. A relic of the old form of statute founded upon petition still remains however in the preamble of Appropriation Acts and other statutes creating a charge upon the public revenue. It runs thus: "We, your majesty's most dutiful and loyal subjects, the Commons of the United Kingdom . . . do most humbly beseech your majesty that it may be enacted; and be it enacted," &c., from this point following the enacting words common to all statutes. The Crown may refer petitions presented to it to be adjudicated upon by a delegated authority. This course is pursued in the case of claims to peerages and offices of honour, which are referred to the House of Lords, and by that house to its committee for privileges, and in the case of petitions to the Crown in council, which are usually referred to the judicial committee. The Crown may delegate the power of receiving petitions in the first instance.

Petitions to Parliament.—Petitions to either house of the legislature seem to have been later in origin than petitions to the Crown. They are not referred to in the Bill of Rights, but the right of petition is a convention of the constitution. Petitions to the Lords or the whole parliament can be traced back to Henry III. No petition to the Commons has been found earlier than Richard II.; but from the time of Henry IV. petitions to the Commons have been freely made. The political importance of petitioning dates from about the reign of Charles I. The development of the practice of petitioning had proceeded so far in the reign of Charles II. as to lead to the passing in 1662 of an act (13 Car. II. c. 5) against "tumultuous petitioning," which is still on the statute book. It provides that no petition or address shall be presented to the king or either house of parliament by more than ten persons; nor shall any one procure above twenty persons to consent or set their hands to any petition for alteration of matters established by law in church or state, unless with the previous order of three justices of the county, or the major part of the grand jury. And in 1817 (57 Geo. III. c. 19, s. 23) meetings within a mile from Westminster Hall for the purpose of considering a petition to both houses or either house of parliament while either house is sitting were declared to be unlawful assemblies. Up to 1688 petitions to either house usually dealt only with some specific grievance. From that time dates the present practice of petitioning with regard to general measures of public policy. Petitions to the Houses of Lords or Commons must be framed in the form prescribed by the standing orders, must be properly superscribed, and must conclude with a prayer (*May, Parl. Pr.*, 11th ed., 524, 525). They may be sent free by post to members of either house if they fulfil certain conditions as to weight, &c., (*loc. cit.* p. 531).

Petitions to the Commons must be in writing, must contain none but genuine signatures, and must be free from disrespectful language or imputations upon any tribunal or constituted authority. They must be presented by a member of the house, except petitions to the House of Commons from the corporation of London, which may be presented at the bar by the sheriffs, and from the corporation of Dublin, which may be presented by the lord mayor. There is no means of compelling a member to present a petition. The rules as to petitions to the House of Lords are similar. The lord who presents a petition is required to read it to see whether in form and contents it is fit for presentation. In the Lords receivers and triers of petitions from Great Britain and Ireland and from Gascony and the lands and countries beyond the sea were appointed until 1886, though their functions had long been obsolete. Applications for leave to bring before either house bills for private or local and personal matters must under the standing orders of both houses be made by petition; and the same rule obtains as to applications for leave to be heard in opposition to such bills.

See Clifford, *History of Private Bill Legislation* (1887); *May, Parl. Pr.*, (11th ed.), c. xxv.

Petitions to Courts of Justice.—Strictly speaking, these are an indirect mode of petitioning the Crown, for in the theory of English law the Crown is the fountain of justice. But it is more convenient to treat them separately, as they now form a part of the practice of the courts. Appeals to the House of Lords and the privy council are prosecuted by petition of appeal. The

original jurisdiction of the privy council to deal with petitions is confined to proceedings under certain statutes, such as the Endowed Schools Acts, the Public Schools Acts, the Universities Acts and the Patents Acts. In most cases the petitions are referred to the judicial committee of the council. Petitions may be addressed to the lord chancellor in a few instances, e.g. for the removal of coroners or county court judges. The House of Lords at one time claimed original jurisdiction in civil and criminal matters. As to civil matters the claim is abandoned; as to criminal matters it is now limited to impeachment for crime, by the Commons on the trial for treason or felony of persons having privilege of peerage.

The most important use of petitions in England is in the High Court of Justice. In the chancery division petitions are presented either as interlocutory proceedings in the course of an action, or as original proceedings where no litigation exists—as being a more speedy form of remedy than an action. The cases in which a petition is admissible and the procedure therein, are in the main regulated by orders 52 and 55 of the rules of the supreme court. Evidence in support of petitions is usually by affidavit. Petitions in the course of an action are presented to the court in which the action is brought. Examples of original petitions are those under the Lands Clauses Acts, the Trustee Acts and the Companies Acts. For many proceedings under these acts a simpler and cheaper form of proceeding by summons has been substituted for that by petition. The matters above-mentioned are usually dealt with by the chancery division as successor of the court of chancery. Petitions are also in use in other courts having equitable jurisdiction, e.g. the chancery courts of the counties palatine of Lancaster and Durham and the county courts as to cases falling within § 67 of the County Courts Act 1888, and as to cases within county court jurisdiction under the Settled Land Acts or the Guardianship of Infants Act 1886 (County Court Rules, O. 38). In a few cases petitions may be brought by way of appeal, e.g. under the Charitable Trusts Act 1860. In the king's bench division the only use of petitions appears to be to initiate proceedings in bankruptcy. Leave to *sum in forma pauperis* used to be given on petition but is now usually dealt with summarily. In the probate, &c., division proceedings in matrimonial causes, &c., are begun by petition, but the course of the proceedings closely resembles those of an ordinary action.

Scotland.—In Scotland petitions in the Court of Session are either original or in a pending action. Original petitions are presented to one of the divisions of the inner house, unless they relate to matters mentioned in 20 & 21 Vict. c. 56, s. 4, when they are brought before the junior lord ordinary, or unless, by special statutory provision, they may be brought before any lord ordinary, as in the case of petitions under the "Conjugal Rights (Scotland) Amendment Act 1861," or the Trusts (Scotland) Act 1867. A petition and complaint is a process of a quasi-criminal nature by which certain matters of summary and extraordinary jurisdiction are brought under the notice of the Court of Session. It lies against magistrates and officers of the law for breach of duty against parties guilty of contempt of court, &c. The concurrence of the lord advocate is necessary to a petition and complaint (see Mackay, *Court of Session Practice*, ii. 439).

Ireland.—The law of Ireland as to petitions is in substance the same as that of England with certain differences of detail as to the cases in which petitions may be made to courts of justice.

United States.—In the United States before the Civil War questions arose as to the right of petitioning Congress, particularly with reference to petitions for the restriction of slavery which at that time was contended to be a matter of state and not of federal concern (see Cooley, *Constitutional Limitations*, 6th ed., 1860, 426). The right of petitioning the United States government is now secured by the first amendment to the United States constitution (ratified in 1789-1791), which provides that "Congress shall make no law . . . abridging . . . the right of the people peaceably to assemble and to petition the government for a redress of grievances." In the view of the Supreme Court this amendment "assumes the existence of the right of the people to assemble for lawful purposes and protects it against encroachment by Congress. The right was not created by the amendment; neither was its continuance guaranteed except as against congressional interference. For their protection in its enjoyment, therefore, the people must look to the states. The power for that purpose was originally placed there, and has never been surrendered. The right of the people peaceably to assemble for the purpose of petitioning Congress for a redress of grievances, or for anything else connected with the powers or duties of the national government is an attribute of national citizenship, and as such under the protection of and guaranteed by the United States. The very idea of a government republican in form implies a right on the part of its citizens to meet peaceably for consultation in respect to public affairs and to petition for a redress of grievances" (*U.S. v. Cruikshank*, 1875; 92 U.S. 542, 552).

A Bill of Rights is incorporated in the constitutions of many states of the Union, and is made part of the supreme law of

the states (see Hough, *American Constitutions*, ii. 571). Petitions can be presented to the federal or state courts of justice under much the same circumstances as in England. "It is a general rule in such cases that an affidavit should be made that the facts therein contained are true as far as known to the petitioner, and that those facts which he states as knowing from others he believes to be true" (*Bouvier, Law Dict.*).

British Possessions.—There is a right of petition to the king for the review of decisions (in matters criminal or civil) of courts of justice in the Channel Islands or Isle of Man, and in all other parts of the empire outside the British Islands and of British courts in foreign countries. This right is cut down by imperial or colonial legislation in the case of Canada and Australia, see Tarring, *Law Relating to Colonies* (3rd ed., 1906) c. v.

The term *Petition of Right*, in English law, is used in two senses. (1) It denotes the statute of 1625 (3 Car. I. c. 1), a parliamentary declaration of the liberties of the people. (2) It also and more usually is employed to describe a mode of prosecuting a claim by a subject against the Crown, said to owe its origin to Edward I. Petition of right in this sense lies (a) to obtain restitution of real or personal property of the subject which has found its way into the hands of the Crown, or compensation if restitution cannot be made; (b) to recover damages for breach of a contract made on behalf of the Crown, whether the breach is due to the acts or the omissions of servants of the Crown. Where the Crown is in possession of property of the suppliant, and the title of the Crown appears by record, as by inquest of office, the remedy is somewhat different and is called *monstrans de droit*. Petition of right does not lie in respect of engagements in the naval, military or civil service of the Crown, which are as a general rule made "during pleasure," nor for breach of public duty, e.g. failure to perform treaty obligations, nor for trespass or negligence or other torts by Crown servants. Where such acts are wrongful the remedy is by action against the official as an individual and not in his official capacity (*Raleigh v. Goschen*, 1898, L.R. 1 ch. 73).

The procedure on a petition of right is either at common law or by statute. At common law the petition went through its earliest stages in the chancery. It suggests such a right as controverts the title of the Crown, and the Crown endorses upon the petition *Solli droit fait al partie*. Thereupon a commission is issued to inquire into the truth of the suggestion. After the return to the commission, the attorney-general pleads or demurs, and the merits are then determined as in actions between subject and subject. If the right be determined against the Crown, judgment of *amoveas manus* is given in favour of the suppliant. The Petition of Right Act 1860 (23 & 24 Vict. c. 34, extended to Ireland in 1873, 36 & 37 Vict. c. 69) preserves to the suppliant his right to proceed at common law, but gives an alternative remedy. The procedure is regulated by the act of 1860, and as to England also by rules made under that act on the 1st of February 1862. The petition is left with the secretary of state for the home department for the consideration of his majesty, who if he thinks fit grants his *fiat* that right be done. The *fiat* is sealed in the home office and issued to the suppliant who files it in the central office of the High Court of Justice, and a sealed copy is served upon the solicitor to the treasury, with a demand for a plea or answer on behalf of the Crown. The subsequent proceedings including those as to disclosing relevant documents are assimilated as far as possible to those in an ordinary action. A judgment in favour of the suppliant is equivalent to a judgment of *amoveas manus oyster le main*. Costs are payable to and by the Crown. A petition of right is usually tried in the chancery or king's bench divisions; but where the subject-matter of the petition arises out of the exercise of belligerent rights on behalf of the Crown, or would be cognizable in a prize court if the matter were in dispute between private persons, the suppliant may at his option intitle his petition in the admiralty division, and the lord chancellor may direct the prosecution in that division of petitions of right under the act of 1860 even when they are not so intitled (27 & 28 Vict. c. 25, s. 52).

The law as to petition of right applies to Ireland but not to Scotland, and a right to present such a petition appears to exist in colonies whose law is based on the common law of England. But in many colonies legislation has been passed with respect to suits against government which makes it unnecessary to resort to a petition of right.

PETITIO PRINCIPII, OR BEGGIN' THE QUESTION (Gr. τὸ ἐν ἀρχῇ λαμβάνειν, τὸ ἐξ ἀρχῆς αἰτεῖσθαι), in logic, the fourth of Aristotle's fallacies *ἕξω τῆς λέξεως* or *extra dictionem*. Strictly this fallacy belongs to the language of disputation, when the questioner seeks (*pelú*) to get his adversary to admit the very matter in question. Hence the word *principium* gives a wrong impression, for the fallacy consists not in seeking for the

admission of a *principle* which will confute the particular proposition—a perfectly legitimate form of refutation—but in luring the adversary into confessing the contradictory. In the ordinary use, however, "begging the question" consists in assuming in the premises the conclusion which it is desired to prove.

PETITOT, JEAN (1608-1691), French-Swiss enamel painter, was born at Geneva, a member of a Burgundian family which had fled from France on account of religious difficulties. His father, Faulle, was a wood carver; his mother's name was Étienneette Roysaume. Jean was the fourth son, and was apprenticed to a jeweller goldsmith named Pierre Bordier, with whom he struck up a close friendship. The two friends, dissatisfied with the progress they made in Geneva, went into France, and after working for a while with Toutin came to England with letters of introduction to Turquet de Mayern, physician to Charles I., who presented them to the king, for whom they made a St George for the badge of the order and carried out many commissions for portraits, amongst others preparing two large ones representing Rachel de Ruvigny, countess of Southampton, now at Chatsworth, and Mary Villiers, duchess of Richmond and Lennox, dated 1643, at one time in the possession of the Crown and now in the Pierpont Morgan collection. On the execution of the king, Petitot left England for Paris with the royal household, Bordier remaining in England and carrying out certain important commissions for Cromwell and the parliament. On reaching Paris, Petitot entered into partnership with a goldsmith, Jacques Bordier, a cousin of Pierre, and it seems probable from recent research in contemporary documents that the enamel portraits attributed to Petitot were really the work of the two partners collaborating, the actual drawing being the work of Petitot, while for the enamel process Bordier was mainly responsible. The two painters were given apartments in the Louvre, received numerous commissions from Louis XIV., and painted portraits of almost every person of importance in his brilliant court. The friendship between the two lasted for thirty-five years, and was only put an end to by Bordier's death. The enamellers rendered special political services in France for the republic of Geneva, and were practically regarded as the official representatives of the republic, receiving warm thanks from the Syndics for their diplomatic work. On the revocation of the Edict of Nantes, 1685, pressure was brought to bear upon Petitot that he should change his religion. The king protected him as long as possible, and when he was arrested, with his niece, Anne Bordier, sent Bossuet, bishop of Meaux, to convince the old man of the error of his ways. Eventually, in poor health and great despair, Petitot placed his signature to an act of abjuration, and Louis XIV., unwilling to acknowledge the true reason for the imprisonment of Petitot and for his liberation, informed one of his sons, who came to thank him for the pardon given to his father, that he was willing to fall in for once with "the whim of an old man who desired to be buried with his ancestors." In 1687 therefore Petitot left Paris to return to Geneva, and, after a long and tedious inquiry, was absolved by the consistory of the church of Geneva from the crime of which they considered he had been guilty, and received back to the Huguenot communion in the church of St Gervais. In Geneva he received a very important commission from John Sobieski, king of Poland, who required portraits of himself and his queen. This was followed by numberless other commissions which the painter carried out. He died of paralysis on the 3rd of April 1691, while in the very act of painting on the enamel a portrait of his faithful wife.

Petitot married in 1651 Marguerite Cuper, and Jacques Bordier married in the same year her younger sister Anne Madeleine. He had seventeen children, and for their benefit wrote out a little octavo volume containing some genealogical information, two delightful portraits, one of himself and one of his wife, and many pages occupied with prayers, meditations and religious advice. He also prepared a second manuscript volume of prayers and meditations for the use of his family, and from these two books and the records of the Huguenot societies of France and England information has been obtained respecting the painter and his family.

Of the works of Petitot the most important collection is in the Jones Bequest at the Victoria and Albert Museum. There are many in the Louvre, sixteen at Chantilly, seventeen at Windsor, and others in the collections of Earl Beauchamp, the duke of Rutland, the duke of Richmond, the earl of Dartrey, Mr Alfred de Rothschild and the late Baroness Burdett-Coutts. Amongst Lord Dartrey's examples are portraits of Petitot and of his son, and two of the wife of Jean Petitot the younger. A second portrait of the artist belongs to the queen of Holland, and another is in the collection of the late Mr Strohlin of Geneva. In Mr Pierpont Morgan's collection there are many exceedingly fine examples, but especially three drawings on paper, the only three which appear to have survived, and the large signed miniature of the duchess of Richmond already mentioned, the largest work Petitot ever executed save the one at Chatsworth.

See *Petitot & Bordier*, by Ernest Strohlin (Geneva, 1905); "Some New Information respecting Jean Petitot," by G. C. Williamson, *Nineteenth Century and After* (January 1908), pp. 98-110; the privately printed *Catalogue of the Collection of Mr J. Pierpont Morgan*, vol. iii.; *The History of Portrait Miniatures*, by G. C. Williamson, vol. ii. (London, 1904). (G. C. W.)

PETITOT, JEAN LOUIS (1652-c. 1730), French enamel painter, was the eldest son of Jean Petitot (*q.v.*), and was instructed in enamelling by his father. Some of his works so closely resemble those of the elder Petitot that it is difficult to distinguish between them, and he was really the only serious rival his father ever had. He settled for a while in London, where he remained till 1682, and painted many enamel portraits of Charles II. In 1682 he removed to Paris, but in 1695 was back again in London, where he remained until the time of his death.

His portrait by Mignard is in the museum at Geneva, and another in enamel by himself in the collection of the earl of Dartrey, who also owns two of his wife, Madeleine Bordier, whom he married in 1683. Another portrait believed to represent him is in the collection of Mr Pierpont Morgan. (G. C. W.)

PETITS-CHEVAUX (Fr for "little horses"), a gambling game played with a mechanical device consisting of a board perforated with a number of concentric circular slits, in which revolve, each independently on its own axis, figures of jockeys on horseback, distinguished by numbers or colours. The bystanders having staked their money according to their choice on a board marked in divisions for this purpose, the horses are started revolving rapidly together by means of mechanism attached to the board, and the horse which stops nearest a marked goal wins, every player who has staked on that horse receiving so many times his stake. Figures of railway trains and other objects sometimes take the place of horses. In recent years there has been a tendency to supplant the *petits chevaux* at French resorts by the *boule* or ball game, on the same principle of gambling; in this a ball is rolled on a basin-shaped table so that it may eventually settle in one of a number of shallow cups, each marked with a figure.

PETO, SIR SAMUEL MORTON, BART. (1809-1880), English contractor, was born at Woking, Surrey, on the 4th of August 1800, and was at an early age apprenticed to his uncle, a London builder, who on his death in 1830 bequeathed the business to Peto and another nephew, Thomas Grissell. The partnership between Peto and Grissell lasted till 1846, amongst the many London buildings erected by the firm being the Reform Club, the Lyceum and St James's theatres, and the Nelson column. Peto afterwards entered into partnership with Edward Ladd Betts (1815-1872), and between 1846 and 1872 Messrs Peto & Betts carried out many large railway contracts at home and abroad, notably the more important portions of the South-Eastern and of the London Chatham & Dover lines, and, in conjunction with Thomas Brassey, the Grand Trunk railway of Canada, and the London Tilbury & Southend railway. In 1854-1855 Peto and Brassey constructed a railway in the Crimea between Balaklava and the British entrenchments before Sebastopol, charging the British government only the actual out-of-pocket expenses, and for his services in this matter Peto was in 1855 made a baronet. Peto entered parliament as a Liberal in 1847, and, with a few years' interval, continued there till 1868, when, his firm having been compelled to suspend payment in the financial crisis of 1866, he was forced to resign his seat, though both Mr Disraeli and Mr Gladstone publicly eulogised his personal character. He died on the 13th of November 1880.

PETŐFI, ALEXANDER (1823-1849), Hungarian lyric poet, was born at Kis-Körös, Pest county, on New Year's Day, 1823. The family received its diploma of nobility from the emperor Leopold in 1688, but the ultra-patriotic Alexander early changed the old family name, Petrovics, which pointed to a Croatian origin, into the purely Magyar form of Petőfi. The lad's early days were spent at Félégyház and Szabadzsállás, the most Hungarian parts of Hungary, where he got most of his early education, including a good grounding in Latin. German he learnt subsequently at Pesth, and French he taught himself. He began writing verses in his twelfth year, while a student at the Aszód gymnasium, where he also displayed a strong predilection for the stage, to the disgust of his rigorous father, who formally disowned his son, early in 1839, for some trifling peccadillo, and whose tyrannical temper became downright ferocious when a series of misfortunes ruined him utterly in 1840. For the next three years Petőfi led the wretched life of a strolling player, except for a brief interval when, to escape starvation, he enlisted as a common soldier in an infantry regiment. During the greater part of 1842 we find him a student at the Calvinist College at Pápa, where he made the acquaintance of young Jókai, and wrote the poem "Borozó," which the great critic Bajza at once inserted in the leading literary review, the *Athenaeum* (May 22, 1842). In November of the same year the restless poet quitted Pápa to join another travelling troupe, playing on one occasion the Fool in *King Lear*, and after wandering all over Hungary and suffering incredible hardships, finally settled down at Pesth (1844), where for a time he supported himself by all sorts of literary hack-work. Nevertheless, in the midst of his worst privations he had read voraciously, and was at this time profoundly influenced by the dominant Romanticism of the day; while, through Tieck, he learnt to know and value the works of Shakespeare. His first volume of original poems was published in 1844 by the Society Nemzeti Kör, through the influence of the poet Vörösmarty, when every publisher had refused his MS., and the seventy-five florins which he got for it had become a matter of life or death to him. He now became a regular contributor to the leading papers of Pesth, and was reconciled to his parents, whom he practically supported for the rest of their lives out of his literary earnings. His position, if not exactly brilliant, was now at least secure. The little volume published by the Nemzeti Kör was followed by the parody, *A Helység Kalapácsa* (1844); the romantic epic *János Vitéz* (1844); *Cipriuslombok Elaké Sírjéről*, a collection of passionate elegies over his lost love, *Ételké Csapó* (1845); *Úti Jegyzék*, an imitation of Heine's *Reisebilder* (1845); *Szerelm Gyöngyei* (1845); *Felhők* (1846); *Szerelme és hőasszága* (1846), and many other volumes. The first edition of his collected poems appeared in 1847. Petőfi was not yet twenty-five, and, despite the protests of the classicists, who regarded him with cold dislike, the best heads in Hungary, poets like Vörösmarty and critics like Szemere, already paid him the homage due to the prince of Magyar lyrical poets. The great public was enthusiastic on the same side, and posterity, too, has placed him among the immortals. Petőfi is as simple and genuine a poet of nature as Wordsworth or Christian Winther, and his erotics, inspired throughout by a noble idealism, have all Byron's force and fervour, though it is perhaps in his martial songs that Petőfi's essentially passionate and defiant genius asserts itself most triumphantly. On the 8th of September 1847 Petőfi married Julia Szendrey, who bore him a son. When the revolutionary war broke out, he espoused the tenets of the extreme democratic faction with a heat and recklessness which estranged many of his friends. He took an active part in the Transylvanian campaigns of the heroic Bem; rose by sheer valour to the rank of major; was slain at the battle of Segesvár (July 31, 1849), and his body, which was never recovered, is supposed to have been buried in the common grave of the fallen hoviends in the churchyard of Fehéregyház. The first complete edition of Petőfi's poems appeared in 1874. The best critical edition is that of Haras, 1894. There are numerous indifferent German translations.

See Ferenczi, *Petőfi Életrajza*; Fischer, *Petőfi's Leben und Werke*. (R. N. B.)

PETOSKEY, a city and the county-seat of Emmet county, Michigan, U.S.A., on Little Traverse Bay, an arm of Lake Michigan, at the mouth of Bear Creek, in the north-west part of the lower peninsula. Pop. (1890), 2872; (1900), 5285, of whom 856 were foreign-born; (1904), 5186; (1910), 4778. It is served by the Père Marquette and the Grand Rapids & Indiana railways and by steamboat lines to Chicago, Detroit, Buffalo and other lake ports. Bear Creek furnishes considerable water-power, and among the manufactures are lumber, paper, leather and foundry and machine-shop products. Petoskey was settled about 1874, was incorporated as a village in 1879, was chartered as a city in 1895, and in 1902 replaced Harbor Springs as county-seat. It was named after an Ojibwa Indian chief.

PETRA (ἡ Πίτρα = the rock), a ruined site, 30° 19' N. and 35° 31' E., lying in a basin among the mountains which form the eastern flank of Wadi el-'Arāba, the great valley running from the Dead Sea to the Gulf of 'Akāba. The descriptions of Strabo (xvi. p. 779), Pliny (*N.H.* vi. 32) and other writers leave no doubt as to the identity of this site with the famous capital of the Nabataeans (*q.v.*) and the centre of their caravan trade. Walled in by towering rocks and watered by a perennial stream, Petra not only possessed the advantages of a fortress but controlled the main commercial routes which passed through it to Gaza in the west, to Bosra and Damascus in the north, to Elath and Leucē Comē on the Red Sea, and across the desert to the Persian Gulf.

From the 'Arāba travellers approach by a track which leads round Jebel Hārūn (Mt Hor) and enters the plain of Petra from the south; it is just possible to find a way in from the high plateau on the north; but the most impressive entrance is from the east, down a dark and narrow gorge, in places only 10 or 12 ft. wide, called the Sīk, *i.e.* the shaft, a split in the huge sandstone rocks which serves as the waterway of the Wadi Mūsā. Near the end of the defile stands the most elaborate of the ruins, el-'Hāzne or "the Treasury of Pharaoh," not built but hewn out of the cliff; a little farther on, at the foot of the mountain called en-Nefr, comes the theatre, so placed as to bring the greatest number of tombs within view; and at the point where the valley opens out into the plain the site of the city is revealed with striking effect. Almost enclosing it on three sides are rose-coloured mountain walls, divided into groups by deep fissures, and lined with rock-cut tombs in the form of towers. The stream of Wadi Mūsā crosses the plain and disappears among the mountains opposite; on either bank, where the ground is fairly level, the city was built, covering a space of about 1½ sq. m. Among the ruins on the south bank stand the fragments of a temple called Kaṣr Fir'aun of late Roman date; just beyond this rises a rocky height which is usually regarded as the acropolis.

A position of such natural strength must have been occupied early, but we have no means of telling exactly when the history of Petra began; the evidence seems to show that the city was of relatively late foundation, though a sanctuary (see below) may have existed there from very ancient times. This part of the country was assigned by tradition to the Horites, *i.e.* probably "cave-dwellers," the predecessors of the Edomites (Gen. xiv. 6, xxxvi. 30-30; Deut. ii. 12); the habits of the original natives may have influenced the Nabataean custom of burying the dead and offering worship in half-excavated caves.¹ But that Petra itself is mentioned in the Old Testament cannot be affirmed with certainty; for though Petra is usually identified with Sela² which also means "a rock," the reference in Judges i. 36; Isa. xvi. 1, xlii. 11; Obad. 3, is far from clear. ³ Kings xv. 7 seems to be more explicit; in the parallel passage, however, Sela¹ is understood to mean simply "the rock" (² Chr. xxv. 12, see LXX). Hence many authorities doubt whether any town named Sela¹ is mentioned in the Old Testament.³ What, then, did the Semitic

¹ Buhl, *Gesch. der Edomiter* (1893), p. 52.
² *E.g.* by Driver, *Deut.* p. 38; Nöldeke, *Encyc. Bibl.* col. 1185; Ed. Meyer, *Die Israeliten u. ihre Nachbarstämme*, p. 357.
³ Buhl, p. 35 seq.; G. F. Moore, *Judaea*, p. 85 seq.; *Oxford Heb. Lex.* s. v. 77; T. K. Cheyne, *Encyc. Bibl.* s. v. Sela; A. Jeremias, *Das A. T. im Lichte d. allen Orients*, p. 457.

inhabitants call their city? Eusebius and Jerome (*Onom. sacr.* 286, 71. 145, 9; 228, 55. 287, 94), apparently on the authority of Josephus (*Ant. iv. 7, 1; 4, 7*), assert that Rekem was the native name. But in the Aramaic versions Rekem is the name of Kadesh; Josephus may have confused the two places. Sometimes the Aramaic versions give the form Rekem-Geya, which recalls the name of the village El-ji, south-east of Petra; the capital, however, would hardly be the name of a neighbouring village. The Semitic name of the city, if it was not Sela', must remain unknown.¹ The passage in Diodorus Siculus (xix. 94-97) which describes the expeditions which Antigonos sent against the Nabataeans in 312 B.C. is generally understood to throw some light upon the history of Petra, though it must be admitted that the *petra* referred to as a natural fortress and place of refuge cannot be a proper name, and the description at any rate implies that the town was not yet in existence. Brunnow thinks that "the rock" in question was the sacred mountain en-Nejr (above); but Buhl suggests a conspicuous height about 16 m. north of Petra, Shobak, the *Mont-royal* of the Crusaders.² More satisfactory evidence of the date at which the earliest Nabataean settlement began is to be obtained from an examination of the tombs. Two types may be distinguished broadly, the Nabataean and the Graeco-Roman. The Nabataean type starts from the simple pylon-tomb with a door set in a tower crowned by a parapet ornament, in imitation of the front of a dwelling-house; then, after passing through various stages, the full Nabataean type is reached, retaining all the native features and at the same time exhibiting characteristics which are partly Egyptian and partly Greek. Of this type there exist close parallels in the tomb-towers at el-Hejr in north Arabia, which bear long Nabataean inscriptions,³ and so supply a date for the corresponding monuments at Petra. Then comes a series of tomb-fronts which terminate in a semicircular arch, a feature derived from north Syria, and finally the elaborate façades, from which all trace of native style has vanished, copied from the front of a Roman temple. The exact dates of the stages in this development cannot be fixed, for strangely enough few inscriptions of any length have been found at Petra,⁴ perhaps because they have perished with the stucco or cement which was used upon many of the buildings. We have, then, as evidence for the earliest period, the simple pylon-tombs, which belong to the pre-Hellenic age; how far back in this stage the Nabataean settlement goes we do not know, but not farther than the 6th century B.C. A period follows in which the dominant civilization combines Greek, Egyptian and Syrian elements, clearly pointing to the age of the Ptolemies. Towards the close of the 2nd century B.C., when the Ptolemaic and Seleucid kingdoms were equally depressed, the Nabataean kingdom came to the front; under Aretas III. Philhellene, c. 85-60 B.C., the royal coins begin; at this time probably the theatre was excavated, and Petra must have assumed the aspect of a Hellenistic city. In the long and prosperous reign of Aretas IV. Philopatris, 9 B.C.-A.D. 40, the fine tombs of the el-Hejr type may be dated, perhaps also the great High-place. Then the city became more and more Romanized. In A.D. 100, when Cornelius Palma was governor of Syria, "Arabia belonging to Petra,"⁵ was absorbed into the Roman Empire, and the native dynasty came to an end. But the city continued to flourish. It was visited in A.D. 131 by Hadrian, and stamped *Adriane Petra* on its coins in gratitude for the emperor's benefactions; the superb Hazne, probably a temple for the worship of Isis, and the Dér, which resembles the Hazne in design, belong to this period. A century later, in the time of Alexander

¹ Yakut gives the name Sal' to a fortress in Wadi Mûsâ, Nôrdelce, *ZDMG.* xiv. 289 seq. (1871).

² Brunnow, *Die Prov. Arabia*, i. 100; Buhl, *op. cit.* p. 34.

³ *CIS.* ii. 197-226; Cooke, *North-Semitic Inscriptions*, 78-91, &c.

⁴ Four important Nabat. inscrs. have been found, of which three are dated, viz. *NSI.* p. 250, s. *CIS.* ii. 749, 16th year of Aretas III., i.e. B.C. 76, so also *CIS.* ii. 442; *NSI.* 94 and 95 = *CIS.* ii. 350 and 354, the latter dated the 20th year of Aretas IV., i.e. A.D. 20. The other Nabat. inscrs. are mostly graffiti, scratched on the rocks by visitors or worshippers at the holy places; *CIS.* ii. 355-441, 444-464.

⁵ This is the meaning of Arabia Petraea. Dio Cass. lxxviii. 14.

Severus (A.D. 222-235), when the city was at the height of its splendour, the issue of coinage comes to an end, and there is no more building of sumptuous tombs, owing apparently to some sudden catastrophe, such as an invasion by the neo-Persian power under the Sassanid dynasty. Meanwhile as Palmyra (*s.* A.D. 130-270) grew in importance and attracted the Arabian trade away from Petra, the latter declined; it seems, however, to have lingered on as a religious centre; for we are told by Epiphanius (c. A.D. 315-402) that in his time a feast was held there on the 25th of December in honour of the virgin Chaabou and her offspring Dusares (*Haer.* 51).

The chief god of Petra was Dhû-sharâ (*Δουσάρης*), i.e. the lord or owner of Sharâ;⁶ he was worshipped under the form of a black rectangular stone, a sort of Petraean Ka'aba (*Suidas Lex. s.v. Θέος Ἄρης*, and cf. Epiph. above). Associated with Dhû-sharâ was Allât, the chief goddess of the ancient Arabs. Sanctuary chambers may be seen at various points in the site of Petra, and many places of sacrifice open to the sky are met with among the tombs, marked by remains of altars. But most eminent of all was the great High-place which has recently been discovered on en-Nejr (or Zibb 'atîf). It consists of a rock-hewn altar of burnt-offering with a place for killing the victims beside it and a shallow court, perhaps intended to hold water, in front; the most complete specimen of an ancient Semitic sanctuary that is known.⁷ Not far off are two obelisks cut out of the solid rock which has been removed to the level of their bases; these were either idols of Dhû-sharâ and Allât, or more probably were designed to mark the limits of the *haram* of the sanctuary. West of the obelisks are three other places of sacrifice; and on the rocks below worshippers have carved their names (*CIS.* ii. 390-404). En-Nejr, with the theatre at its foot, must have been the sacred mountain, the original sanctuary of Petra, perhaps "the very high mountain of Arabia called Dusarê alter the god Dusares" referred to by Steph. Byz. (*s.v. Δουσάρης*). Christianity found its way into Petra in early times; Athanasius mentions a bishop of Petra (*Περσῶν ἐπί Ἀραβίας, ad Antioch.* 10) named Asterius; at least one of the tombs (the "tomb with the urn") was used as a church; an inscription in red paint records its consecration "in the time of the most holy bishop Jason" (A.D. 447). The Christianity of Petra, as of north Arabia, was swept away by the Mahomedan conquest in A.D. 629-632. Under the Latin kingdom Petra was occupied by Baldwin I. and formed the second fief of the barony of Krak with the title Château de la Vallée de Moÿse or Sela; it remained in the hands of the Franks till 1189; fragments of the Crusaders' citadel are still standing near the High-place on en-Nejr.

The ruins of Petra were an object of curiosity in the middle ages and were visited by the Sultan Bibars of Egypt towards the close of the 13th century. The first European to describe them was Burckhardt (1812). All former descriptions are now superseded by the magnificent work of Brunnow and Domaszewski, *Die Provincia Arabia* (1904), who have minutely surveyed the whole site, classified the tombs, and compiled the accounts of earlier investigations; and by the independent researches of Dalman, *Petra und seine Felsheiligtümer* (1908), and of Musil, *Arabia Petraea* (1907-1908). The *Corpus Inscr. Sem.* ii. 305 seq. should be consulted, and the descriptions in *Baedeker-Socin's Palestine* (7th edition), and *Revue biblique* for 1897, 1898, 1903. (G. A. C.)

PETRARCH (1304-1374). Francesco Petrarca, the great Italian poet and first true reviver of learning in medieval Europe, was born at Arezzo on the 20th of July 1304. His father Petracco held a post of notary in the Florentine Rolls Court of the Riformagioni; but, having espoused the same cause as Dante during the quarrels of the Blacks and Whites, Petracco was expelled from Florence by that decree of the 27th of January 1302 which condemned Dante to lifelong exile. With his wife he

⁶ The whole range in which Petra lies is called Jebel esh-Sharâ, but it is doubtful whether the name of the god was derived from that of the mountain, see Ed. Meyer, *loc. cit.* p. 268 and Cooke, *NSI.* p. 218.

⁷ First mentioned by E. L. Wilson (1891); rediscovered by G. L. Robinson (1900), described by S. I. Curtis, *P. E. F. Q. S.* 1900, and Savignac, *Rev. bibl.* (1903); with full plan and photographs.

took refuge in the Ghibelline township of Arezzo; and it was here, on the very night when his father, in company with other members of the White party, made an unsuccessful attempt to enter Florence by force, the Francesco first saw the light. He did not remain long in his birthplace. His mother, having obtained permission to return from banishment, settled at Incisa, a little village on the Arno above Florence, in February 1305. Here Petrarch spent seven years of boyhood, acquiring that pure Tuscan idiom which afterwards he used with such consummate mastery in ode and sonnet. Here too, in 1307, his brother Gherardo was born. In 1312 Petrarch set up a house for his family at Pisa; but soon afterwards, finding no scope there for the exercise of his profession as jurist, he removed them all in 1313 to Avignon. This was a step of no small importance for the future poet-scholar. Avignon at that period still belonged to Provence, and owed King Robert of Naples as sovereign. But the popes had made it their residence after the insults offered to Boniface VIII. at Anagni in 1303. Avignon was therefore the centre of that varied society which the high pontiffs of Christendom have ever gathered round them. Nowhere else could the youth of genius who was destined to impress a cosmopolitan stamp on medieval culture and to begin the modern era have grown up under conditions more favourable to his task. At Incisa and at Pisa he had learned his mother-tongue. At Carpentras, under the direction of Convenevole of Prato, he studied the humanities between the years 1315 and 1319. Avignon, at a distance from the party strife and somewhat parochial politics of the Italian commonwealths, impressed his mind with an ideal of civility raised far above provincial prejudices.

Petrarch's real name according to Tuscan usage was Francesco di Petracco. But he altered this patronymic, for the sake of euphony, to Petrarca, proving by this slight change his emancipation from usages which, had he dwelt at Florence, would most probably have been imposed on him. Petracco, who was very anxious that his eldest son should become an eminent jurist, sent him at the age of fifteen to study law at Montpellier. Like Ovid and many other poets, Petrarch felt no inclination for his father's profession. His intellect, indeed, was not incapable of understanding and admiring the majestic edifice of Roman law; but he shrank with disgust from the illiberal technicalities of practice. There is an authentic story of Petracco's flinging the young student's books of poetry and rhetoric upon the fire, but saving Virgil and Cicero half-burned from the flames at his son's passionate entreaties. Notwithstanding Petrarch's firm determination to make himself a scholar and a man of letters rather than a lawyer, he so far submitted to his father's wishes as to remove about the year 1323 to Bologna, which was then the headquarters of juristic learning. There he stayed with his brother Gherardo until 1326, when his father died, and he returned to Avignon. Banishment and change of place had already diminished Petracco's fortune, which was never large, and a fraudulent administration of his estate after his death left the two heirs in almost complete destitution. The most precious remnant of Petrarch's inheritance was a MS. of Cicero. There remained no course open for him but to take orders. This he did at once on his arrival in Provence; and we have good reason to believe that he advanced in due time to the rank of priest. A great Roman noble and ecclesiastic, Giacomo Colonna, afterwards bishop of Lombez, now befriended him, and Petrarch lived for some years in partial dependence on this patron.

On the 6th of April 1327 happened the most famous event of Petrarch's history. He saw Laura for the first time in the church of St. Clara at Avignon. Who Laura was remains uncertain still. That she was the daughter of Audibert de Noves and the wife of Hugh de Sade rests partly on tradition and partly on documents which the abbé de Sade professed to have copied from originals in the 18th century. Nothing is now extant to prove that, if this lady really existed, she was the Laura of the *Canzoniere*, while there are reasons for suspecting that the abbé was either the fabricator of a romance flattering to his own family, or the duped of some previous impostor. We may, however, reject the sceptical hypothesis that Laura was a mere figment of Petrarch's

fancy; and, if we accept her personal reality, the poems of her lover demonstrate that she was a married woman with whom he enjoyed a respectful and not very intimate friendship.

Petrarch's inner life after this date is mainly occupied with the passion which he celebrated in his Italian poems, and with the friendships which his Latin epistles dimly reveal to us. Besides the bishop of Lombez he was now on terms of intimacy with another member of the great Colonna family, the cardinal Giovanni. A German, Ludwig, whom he called Socrates, and a Roman, Lello, who received from him the classic name of Laellius, were among his best-loved associates. Avignon was the chief seat of his residence up to the year of 1333, when he became restless and undertook his first long journey. On this occasion he visited Paris, Ghent, Liège, Cologne, making the acquaintance of learned men and copying the manuscripts of classical authors. On his return to Avignon he engaged in public affairs, pleaded the cause of the Scaligers in their lawsuit with the Rossi for the lordship of Parma, and addressed two poetical epistles to Pope Benedict XII. upon the restoration of the papal see to Rome. His eloquence on behalf of the tyrants of Verona was successful. It won him the friendship of their ambassador, Azzo di Correggio—a fact which subsequently influenced his life in no small measure. Not very long after these events Petrarch made his first journey to Rome, a journey memorable from the account which he has left us of the impression he received from its ruins.

It was some time in the year 1337 that he established himself at Vaucluse and began that life of solitary study, heightened by communion with nature in her loneliest and wildest moods, which distinguished him in so remarkable a degree from the common herd of medieval scholars. Here he spent his time partly among books, meditating on Roman history, and preparing himself for the Latin epic of *Africa*. In his hours of recreation he climbed the hills or traced the Sorgues from its fountain under those tall limestone cliffs, while odes and sonnets to Madonna Laura were committed from his memory to paper. We may also refer many of his most important treatises in prose, as well as a large portion of his Latin correspondence, to the leisure he enjoyed in this retreat. Some woman, unknown to us by name, made him the father of a son, Giovanni, in the year 1337; and she was probably the same who brought him a daughter, Francesca, in 1343. Both children were afterwards legitimized by papal bulls. Meanwhile his fame as a poet in the Latin and the vulgar tongues steadily increased, until, when the first draughts of the *Africa* began to circulate about the year 1339, it became manifest that no one had a better right to the laurel crown than Petrarch. A desire for glory was one of the most deeply-rooted passions of his nature, and one of the points in which he most strikingly anticipated the humanistic scholars who succeeded him. It is not, therefore, surprising to find that he exerted his influence in several quarters with the view to obtaining the honours of a public coronation. The result of his intrigues was that on a single day in 1340, the 1st of September, he received two invitations, from the university of Paris and from King Robert of Naples respectively. He chose to accept the latter, journeyed in February 1341 to Naples, was honourably entertained by the king, and, after some formal disputations on matters touching the poet's art, was sent with magnificent credentials to Rome. There, in the month of April, Petrarch assumed the poet's crown upon the Capitol from the hand of the Roman senator amid the plaudits of the people and the patricians. The oration which he delivered on this occasion was composed upon these words of Virgil:—

" Sed me Parnassus deserta per ardua dulcis
Raptat amor."

The ancient and the modern eras met together on the Capitol at Petrarch's coronation, and a new stadium for the human spirit, that which we are wont to style Renaissance, was opened.

With the coronation in Rome a fresh chapter in the biography of Petrarch may be said to have begun. Henceforth he ranked as a rhetorician and a poet of European celebrity, the guest of princes, and the ambassador to royal courts. During the spring months of 1341 his friend Azzo di Correggio had succeeded in freeing Parma from subjugation to the Scaligers, and was laying

the foundations of his own tyranny in that city. He invited Petrarch to attend him when he made his triumphal entry at the end of May; and from this time forward for a considerable period Parma and Vaucluse were the two headquarters of the poet. The one he called his Transalpine, the other his Cisalpine Parnassus. The events of the next six years of his life, from May 1341 to May 1347, may be briefly recapitulated. He lost his old friend the bishop of Lombez by death and his brother Gherardo by the entrance of the latter into a Carthusian monastery; various small benefices were conferred upon him; and repeated offers of a papal secretaryship, which would have raised him to the highest dignities, were made and rejected. Petrarch remained true to the instinct of his own vocation, and had no intention of sacrificing his studies and his glory to ecclesiastical ambition. In January 1343 his old friend and patron Robert, king of Naples, died, and Petrarch was sent on an embassy from the papal court to his successor Joan. The notices which he has left us of Neapolitan society at this epoch are interesting, and, it was now, perhaps, that he met Boccaccio for the first time. The beginning of the year 1345 was marked by an event more interesting in the scholar's eyes than any change in dynasties. This was no less than a discovery at Verona of Cicero's *Familiar Letters*. It is much to be regretted that Petrarch found the precious MS. so late in life, when the style of his own epistles had been already modelled upon that of Seneca and St Augustine.

In the month of May 1347 Cola di Rienzi accomplished that extraordinary revolution which for a short space revived the republic in Rome, and raised this enthusiast to titular equality with kings. Petrarch, who in politics was no less visionary than Rienzi, hailed the advent of a founder and deliverer in the self-styled tribune. Without considering the impossibility of restoring the majesty of ancient Rome, or the absurdity of dignifying the medieval Roman rabble by the name of *Populus Romanus*, he threw himself with passion into the republican movement, and sacrificed his old friends of the Colonna family to what he judged a patriotic duty.

Petrarch built himself a house at Parma in the autumn of 1347. Here he hoped to pursue the tranquil avocations of a poet honoured by men of the world and men of letters throughout Europe, and of an idealistic politician, whose effusions on the questions of the day were read with pleasure for their style. But in the course of the next two years this agreeable prospect was overclouded by a series of calamities. Laura died of the plague on the 6th of April 1348. Francesco degli Albizzi, Mainardo Accursio, Roberto de' Bardi, Sennuccio del Bene, Luchino Visconti, the cardinal Giovanni Colonna and several other friends followed to the grave in rapid succession. All of these had been intimate acquaintances and correspondents of the poet. Friendship with him was a passion; or, what is more true perhaps, he needed friends for the maintenance of his intellectual activity at the highest point of its effectiveness. Therefore he felt the loss of these men acutely. We may say with certainty that Laura's death, accompanied by that of so many distinguished associates, was the turning-point in Petrarch's inner life. He began to think of quitting the world, and pondered a plan for establishing a kind of humanistic convent, where he might dedicate himself, in the company of kindred spirits, to still severer studies and a closer communion with God. Though nothing came of this scheme, a marked change was henceforth perceptible in Petrarch's literary compositions. The poems written *In Mortis di Madonna Laura* are graver and of more religious tone. The prose works touch on retrospective topics or deal with subjects of deep meditation. At the same time his renown, continually spreading, opened to him ever fresh relations with Italian despots. The noble houses of Gonzaga at Mantua, at Carrara at Padua, of Este at Ferrara, of Malatesta at Rimini, of Visconti at Milan, vied with Azzo di Correggio in entertaining the illustrious man of letters. It was in vain that his correspondents pointed out the discrepancy between his professed zeal for Italian liberties, his recent enthusiasm for the Roman republic, and this alliance with tyrants who were destroying the freedom of the Lombard cities. Petrarch remained an incurable rhetori-

cian; and, while he stigmatised the despots in his ode to Italy and in his epistles to the emperor he accepted their hospitality. They, on their part, seem to have understood his temperament, and to have agreed to recognize his political theories as of no practical importance. The tendency to honour men of letters and to patronize the arts which distinguished Italian princes throughout the Renaissance period first manifested itself in the attitude assumed by Visconti and Carraresi to Petrarch.

When the jubilee of 1350 was proclaimed, Petrarch made a pilgrimage to Rome, passing and returning through Florence, where he established a firm friendship with Boccaccio. It has been well remarked that, while all his other friendships are shadowy and dim, this one alone stands out with clearness. Each of the two friends had a distinguished personality. Each played a foremost part in the revival of learning. Boccaccio carried his admiration for Petrarch to the point of worship. Petrarch repaid him with sympathy, counsel in literary studies, and moral support which helped to elevate and purify the younger poet's over-sensuous nature. It was Boccaccio who in the spring of 1351 brought to Petrarch, then resident with the Carrara family at Padua, an invitation from the signory of Florence to accept the rectorship of their recently founded university. This was accompanied by a diploma of restoration to his rights as citizen and restitution of his patrimony. But, flattering as was the offer, Petrarch declined it. He preferred his literary leisure at Vaucluse, at Parma, in the courts of princes, to a post which would have brought him into contact with jealous priors and have reduced him to the position of the servant of a commonwealth. Accordingly, we find him journeying again in 1351 to Vaucluse, again refusing the office of papal secretary, again planning visionary reforms for the Roman people, and beginning that curious fragment of an autobiography which is known as the *Epistle to Posterity*. Early in 1353 he left Avignon for the last time, and entered Lombardy by the pass of Mont Genève, making his way immediately to Milan. The archbishop Giovanni Visconti was at this period virtually despot of Milan. He induced Petrarch, who had long been a friend of the Visconti family, to establish himself at his court, where he found employment for him as ambassador and orator. The most memorable of his diplomatic missions was to Venice in the autumn of 1353. Towards the close of the long struggle between Genoa and the republic of St Mark the Genoese entreated Giovanni Visconti to mediate on their behalf with the Venetians. Petrarch was entrusted with the office; and on the 8th of November he delivered a studied oration before the doge Andrea Dandolo and the great council. His eloquence had no effect; but the orator entered into relations with the Venetian aristocracy which were afterwards extended and confirmed. Meanwhile, Milan continued to be his place of residence. After Giovanni's death he remained in the court of Bernabò and Galeazzo Visconti, closing his eyes to their cruelties and exactions, serving them as a diplomatist, making speeches for them on ceremonial occasions, and partaking of the splendid hospitality they offered to emperors and princes. It was in this capacity of an independent man of letters, highly placed and favoured at one of the most wealthy courts of Europe, that he addressed epistles to the emperor Charles IV. upon the distracted state of Italy, and entreated him to resume the old Ghibelline policy of imperial interference. Charles IV. passed through Mantua in the autumn of 1354. There Petrarch made his acquaintance, and, finding him a man unfit for any noble enterprise, declined attending him to Rome. When Charles returned to Germany, after assuming the crowns in Rome and Milan, Petrarch addressed a letter of vehement invective and reproach to the emperor who was so negligent of the duties imposed on him by his high office. This did not prevent the Visconti sending him on an embassy to Charles in 1356. Petrarch found him at Prague, and, after pleading the cause of his masters, was despatched with honour and the diploma of count palatine. His student's life at Milan was again interrupted in 1360 by a mission on which Galeazzo Visconti sent him to King John of France. The tyrants of Milan were aspiring to royal alliances; Gian Galeazzo Visconti had been married to Isabella of France;

Violante Visconti, a few years later, was wedded to the English duke of Clarence. Petrarch was now commissioned to congratulate King John upon his liberation from captivity to England. This duty performed, he returned to Milan, where in 1361 he received news of the deaths of his son Giovanni and his old friend Socrates. Both had been carried off by plague.

The remaining years of Petrarch's life, important as they were for the furtherance of humanistic studies, may be briefly condensed. On the 11th of May 1362 he settled at Padua, from the neighbourhood of which he never moved again to any great distance. The same year saw him at Venice, making a donation of his library to the republic of St Mark. Here his friend Boccaccio introduced to him the Greek teacher Leontius Pilatus. Petrarch, who possessed a MS. of Homer and a portion of Plato, never acquired the Greek language, although he attempted to gain some little knowledge of it in his later years. Homer, he said, was dumb to him, while he was deaf to Homer; and he could only approach the *Iliad* in Boccaccio's rude Latin version. About this period he saw his daughter Francesca happily married, and undertook the education of a young scholar from Ravenna, whose sudden disappearance from his household caused him the deepest grief. This youth has been identified, but on insufficient grounds, with that Giovanni Malpaghini of Ravenna who was destined to form a most important link between Petrarch and the humanists of the next age of culture. Gradually his oldest friends dropped off. Azzo di Correggio died in 1362, and Laelius, Simonides, Barbato, in the following year. His own death was reported in 1365; but he survived another decade. Much of this last stage of his life was occupied at Padua in a controversy with the Averroists, whom he regarded as dangerous antagonists both to sound religion and to sound culture. A curious treatise, which grew in part out of this dispute and out of a previous duel with physicians, was the book *Upon his own Ignorance and that of many others*. At last, in 1369, tired with the bustle of a town so big as Padua, he retired to Arquà, a village in Euganean hills, where he continued his usual train of literary occupations, employing several secretaries, and studying unremittingly. All through these declining years his friendship with Boccaccio was maintained and strengthened. It rested on a solid basis of mutual affection and of common studies, the different temperaments of the two scholars securing them against the disagreements of rivalry or jealousy. One of Petrarch's last compositions was a Latin version of Boccaccio's story of Griselda. On the 18th of July 1374 his people found the old poet and scholar dead among his books in the library of that little house which looks across the hills and lowlands towards the Adriatic.

When we attempt to estimate Petrarch's position in the history of modern culture, the first thing which strikes us is that he was even less eminent as an Italian poet than as the founder of Humanism, the inaugurator of the Renaissance in Italy. What he achieved for the modern world was not merely to bequeath to his Italian imitators masterpieces of lyrical art unrivalled for perfection of workmanship, but also, and far more, to open out for Europe a new sphere of mental activity. Standing within the threshold of the middle ages, he surveyed the kingdom of the modern spirit, and, by his own inexhaustible industry in the field of scholarship and study, he determined what we call the revival of learning. By bringing the men of his own generation into sympathetic contact with antiquity, he gave a decisive impulse to that European movement which restored freedom, self-consciousness, and the faculty of progress to the human intellect. He was the first man to collect libraries, to accumulate coins, to advocate the preservation of MSS. For him the authors of the Greek and Latin world were living men—more real, in fact, than those with whom he corresponded; and the rhetorical epistles he addressed to Cicero, Seneca and Varro prove that he dwelt with them on terms of sympathetic intimacy. So far-reaching were the interests controlled by him in this capacity of humanist that his achievement as an Italian lyricist seems by comparison insignificant.

Petrarch's ideal of humanism was essentially a noble one. He regarded the orator and the poet as teachers, bound to

complete themselves by education, and to exhibit to the world an image of perfected personality in prose and verse of studied beauty. Self-culture and self-effectuation seemed to him the highest aims of man. Everything which contributed to the formation of a free, impassioned, liberal individuality he regarded as praiseworthy. Everything which retarded the attainment of that end was contemptible in his eyes. The authors of antiquity, the Holy Scriptures and the fathers of the Church were valued by him as one common source of intellectual enlightenment. Eminently religious, and orthodox in his convictions, he did not seek to substitute a pagan for the Christian ideal. This was left for the scholars of the 15th and 16th centuries in Italy. At the same time, the Latin orators, historians and poets were venerated by him as depositories of a tradition only second in importance to revelation. For him there was no schism between Rome and Galilee, between classical genius and sacred inspiration. Though the latter took the first rank in relation to man's eternal welfare, the former was necessary for the perfection of his intellect and the civilization of his manners. With this double ideal in view, Petrarch poured scorn upon the French physicians and the Italian Averroists for their illiberal philistinism, no less than for their materialistic impiety. True to his conception of independent intellectual activity, he abstained from a legal career, refused important ecclesiastical office, and contented himself with paltry benefices which implied no spiritual or administrative duties, because he was resolved to follow the one purpose of his life—self-culture. Whatever in literature revealed the hearts of men was infinitely precious to him; and for this reason he professed almost a cult for St Augustine. It was to Augustine, as to a friend or a confessor, that he poured forth the secrets of his own soul in the book *De contemptu mundi*.

In this effort to realize his truest self Petrarch was eminently successful. Much as he effected by restoring to the world a sound conception of learning, and by rousing that genuine love and curiosity which led to the revival, he did even more by impressing on the age his own full-formed and striking personality. In all things he was original. Whether we regard him as a priest who published poem after poem in praise of an adored mistress, as a plebeian man of letters who conversed on equal terms with kings and princes, as a solitary dedicated to the love of nature, as an amateur diplomatist treating affairs of state with pompous eloquence in missives sent to popes and emperors, or again as a traveller eager for change of scene, ready to climb mountains for the enjoyment of broad prospects over spreading champaigns; in all these divers manifestations of his peculiar genius we trace some contrast with the manners of the 14th century, some emphatic anticipation of the 16th. The defects of Petrarch's character were no less striking than its qualities, and were indeed their complement and counterpart. That vivid conception of intellectual and moral self-culture which determined his ideal took the form in actual life of all-absorbing egotism. He was not content with knowing himself to be the leader of the age. He claimed autocracy, suffered no rival near his throne, brooked no contradiction, demanded unconditional submission to his will and judgment. Petrarch was made up of contradictions. Praising solitude, playing the hermit at Vaucluse, he only loved seclusion as a contrast to the society of courts. While he penned dissertations on the fatality of fame and the burden of celebrity he was trimming his sails to catch the breeze of popular applause. No one professed a more austere morality, and few medieval writers indulged in cruder satire on the female sex; yet he passed some years in the society of a concubine, and his living masterpiece of art is the apotheosis of chivalrous passion for a woman. These discordances of an undecided nature displayed themselves in his political theories and in his philosophy of conduct. In one mood he was fain to ape the antique patriot; in another he affected the monastic saint. He was clamorous for the freedom of the Roman people; yet at one time he called upon the popes to re-establish themselves in the Eternal City; at another he besought the emperor to make it his headquarters; at a third he hailed in Rienzi the founder of a new republic. He did not perceive that all these plans were

Incompatible. His relations to the Lombard nobles were equally at variance with his professed patriotism; and, while still a housemate of Visconti and Correggi, he kept on issuing invectives against the tyrants who divided Italy. It would not be difficult to multiply these antitheses in the character and the opinions of this singular man. But it is more to the purpose to remark that they were harmonized in a personality of potent and enduring force.

The point to notice in this complex personality is that Petrarch's ideal remained always literary. As philosopher, politician, historian, essayist, orator, he aimed at lucid and harmonious expression—not, indeed, neglecting the importance of the material he undertook to treat, but approaching his task in the spirit of an artist rather than a thinker or a man of action. This accounts for his bewildering versatility, and for his apparent want of grasp on conditions of fact. Viewed in this light Petrarch anticipated the Italian Renaissance in its weakness—that philosophical superficiality, that tendency to ornate rhetoric, that preoccupation with stylistic trifles, that want of profound conviction and stern sincerity, which stamp its minor literary products with the note of mediocrity. Had Petrarch been possessed with a passion for some commanding principle in politics, morality or science, instead of with the thirst for self-glorification and the ideal of artistic culture, it is not wholly impossible that Italian humanism might have assumed a manlier and more conscientious tone. But this is not a question which admits of discussion; for the conditions which made Petrarch what he was were already potent in Italian society. He did but express the spirit of the period he opened; and it may also be added that his own ideal was higher and severer than that of the illustrious humanists who followed him.

As an author Petrarch must be considered from two points of view—first as a writer of Latin verse and prose, secondly as an Italian lyricist. In the former capacity he was speedily outstripped by more fortunate scholars. His eclogues and epistles and the epic of *Africa*, on which he set such store, exhibit a comparatively limited command of Latin metre. His treatises, orations, and familiar letters, though remarkable for a prose style which is eminently characteristic of the man, are not distinguished by purity of diction. Much as he admired Cicero, it is clear that he had not freed himself from current medieval Latinity. Seneca and Augustine had been too much used by him as models of composition. At the same time it will be conceded that he possessed a copious vocabulary, a fine ear for cadence, and the faculty of expressing every shade of thought or feeling. What he lacked was that insight into the best classical masterpieces, that command of the best classical diction, which is the product of successive generations of scholarship. To attain to this, Giovanni da Ravenna, Coluccio Salutato, Poggio and Filelfo had to labour, before a Poliziano and a Bembo finally prepared the path for an Erasmus. Had Petrarch been born at the close of the 15th instead of at the opening of the 14th century there is no doubt that his Latinity would have been as pure, as versatile, and as pointed as that of the witty stylist of Rotterdam.

With regard to his Italian poetry Petrarch occupies a very different position. The *Rime in Vita e Morte di Madonna Laura* cannot become obsolete, for perfect metrical form has here been married to language of the choicest and the purest. It is true that even in the *Canzoniere*, as Italians prefer to call that collection of lyrics, Petrarch is not devoid of faults belonging to his age, and affectations which have imposed themselves with disastrous effect through his authority upon the literature of Europe. He appealed in his odes and sonnets to a restricted audience already educated by the chivalrous love-poetry of Provence and by Italian imitations of that style. He was not careful to exclude the commonplace of the school, nor anxious to finish a work of art wholly free from fashionable graces and from contemporary conceits. There is therefore a certain element of artificiality in his treatment; and this, since it is easier to copy defects than excellencies, has been perpetuated with wearisome monotony by versifiers who chose him for their model. But, after making due allowance for peculiarities, the abuse of which has brought

the name of Petrarchist into contempt, we can agree with Shelley that the lyrics of the *Canzoniere* "are as spells which unseal the inmost enchanted fountains of the delight which is the grief of love." Much might be written about the peculiar position held by Petrarch between the metaphysical lyricists of Tuscany and the more realistic amorists of succeeding generations. True in this respect also to his anticipation of the coming age, he was the first Italian poet of love to free himself from allegory and mysticism. Yet he was far from approaching the analysis of emotion with the directness of a Heine or De Musset. Though we believe in the reality of Laura, we derive no clear conception either of her person or her character. She is not so much a woman as woman in the abstract, and perhaps on this very account the poems written for her by her lover have been taken to the heart by countless lovers who came after him. The method of his art is so generalizing, while his feeling is so natural, that every man can see himself reflected in the singer and his mistress shadowed forth in Laura. The same criticism might be passed on Petrarch's descriptions of nature. That he felt the beauties of nature keenly is certain, and he frequently touches them with obvious appreciation. Yet he has written nothing so characteristic of Vacluse as to be inapplicable to any solitude where there are woods and water. The *Canzoniere* is therefore one long melodious monody poured from the poet's soul, with the indefinite form of a beautiful woman seated in a lovely landscape, a perpetual object of delightful contemplation. This disengagement from local circumstance without the sacrifice of emotional sincerity is a merit in Petrarch, but it became a fault in his imitators. Lacking his intensity of passion and his admirable faculty for seizing the most evanescent shades of difference in feeling, they degenerated into colourless and lifeless insipidities made insupportable by the frigid repetition of tropes and conceits which we are fain to pardon in the master.

Petrarch did not distinguish himself by love-poetry alone in the Italian language. His odes to Giacomo Colonna, to Cola di Rienzi and to the princes of Italy display him in another light. They exhibit the oratorical fervour, the pleader's eloquence in its most perfect lustre, which Petrarch possessed in no less measure than subjective passion. Modern literature has nothing nobler, nothing more harmonious in the declamatory style than these three patriotic effusions. Their spirit itself is epoch-making in the history of Europe. Up to this point Italy had scarcely begun to exist. There were Florentines and Lombards, Guelfs and Ghibellines; but even Dante had scarcely conceived of Italy as a nation, independent of the empire, inclusive of her several component commonwealths. To the high conception of Italian nationality, to the belief in that spiritual unity which underlay her many discords and divisions, Petrarch attained partly through his disengagement from civic and local partisanship, partly through his large and liberal ideal of culture.

The materials for a life of Petrarch are afforded in abundance by his letters, collected and prepared for publication under his own eyes. These are divided into *Familiar Correspondence*, *Correspondence in Old Age*, *Divers Letters* and *Letters without a Title*; to which may be added the curious autobiographical fragment entitled the *Epistle to Posterity*. Next in importance rank the epistles and eclogues in Latin verse, the Italian poems and the rhetorical addresses to popes, emperors, Cola di Rienzi and some great men of antiquity. For the comprehension of his character the treatise *De contemptu mundi*, addressed to St Augustine and styled his Secret, is invaluable. Without attempting a complete list of Petrarch's works, it may be well to illustrate the extent of his erudition and his activity as a writer by a brief enumeration of the most important. In the section belonging to moral philosophy, we find *De remediis utriusque fortunæ*, a treatise on human happiness and unhappiness; *De vita solitaria*, a panegyric of solitude; *De vita religiosorum*, a similar essay on monastic life, inspired by a visit to his brother Gherardo in his convent near Marcella. On historical subjects the most considerable are *Rerum memorandarum libri*, a miscellany from a student's commonplace-book, and *De viris illustribus*, an epitome of the biographies of Roman worthies. Three polemical works require mention: *Contra cyjusdam anonymi Galli calumnias apologetica*, *Contra medicum quendam invectionum libri*, and *De sui ipsius et multorum ignorantia*—controversial and sarcastic compositions, which grew out of Petrarch's quarrels with the physicians of Avignon and the Averroists of Padua. In this connexion it might also be well to mention the remarkable

pires on the papal court, included in the *Epistolae sine titulo*. Five public orations have been preserved, the most worthy of which, in explanation of Petrarck's conception of literature, is the speech delivered on the Capitol upon the occasion of his coronation. Among his Latin poems *Africa*, an epic on Scipio Africanus, takes the first place. Twelve *Elegies* and three books of *Epistles* in verse close the list. In Italian we possess the *Canzoniere*, which includes odes and sonnets written for Laura during her lifetime, those written for her after her death; and a miscellaneous section containing the three patriotic odes and three famous poetical invectives against the papal court. Besides these lyrical compositions are the semi-epical or allegorical *Triumphs*—Triumphs of Love, Chastity, Death, Fame, Time and Divinity, written in terza rima of smooth and limpid quality. Though these *Triumphs*, as a whole, are deficient in poetic inspiration, the second canto of the *Triumpho della morte*, in which Petrarck describes a vision of his dead love Laura, is justly famous for reserved passion and pathos tempered to a tranquil harmony.

The complete bibliography of Petrarck forms a considerable volume. Such a work was attempted by Domenico Rossetti (Trieste, 1828). It will be enough here to mention the Basel edition of 1581, in folio, as the basis for all subsequent editions of his collected works. Among editions of the *Canzoniere* special mention may be made of those of Marsand (Padua, 1820), Leopardi in Le Monnier's collection, Messia (1895), and Casdani (1899). Nor must Fracassetti's Italian version of the *Letters* (published in 5 vols. by Le Monnier) be neglected. De Sade's *Life of the poet* (Amsterdam, 1764-1767) marks an epoch in the history of his numerous biographies; but this is in many important points untrustworthy, and it has been superseded by Gustav Koerting's exhaustive volume on *Petrarck's Leben und Werke* (Leipzig, 1878). Georg Voigt's *Wiederbelebung des klassischen Alterthums* (Berlin, 1859) contains a well-digested estimate of Petrarck's relation to the revival of learning. Mezzière's *Petrarque* (1868) is a monograph of merit. English readers may be referred to a little book on Petrarck by Henry Reeve, and to vols. ii. and iv. of Symonds's *Renaissance in Italy*. See also Maud F. Jerrold, *Francesco Petrarca, poet and humanist* (1909).

PETRE, SIR EDWARD (1631-1699), Jesuit confessor of King James II. of England, was born in Paris. He was the son of Sir Francis Petre, Bart., of Cranham, head of a junior branch of the family of the Barons Petre, and his wife Elizabeth Gage, daughter of Sir John Gage, both strong Roman Catholics. In 1649 he was sent for his education to the Jesuit College at St Omer, and he entered the order under the name of Spencer in 1652, but did not receive the full orders till 1671. In 1679 he succeeded his elder brother in the title and family estates. On the accession of James II. in 1685 he was chosen as confessor by the king, who looked upon him as "a resolute and undertaking man." During the whole of the king's reign Petre was one of his advisers who did the most to encourage him in the policy which ended by producing the revolution of 1688. The king contemplated making him archbishop of York, as the see was then vacant, but the pope, Innocent XI., who was not friendly to the order, would not grant a dispensation to hold it, and even directed Petre's superiors to rebuke him for his excessive ambition. In 1687 he was made privy councillor. When the revolution broke out Petre was compelled to flee disguised as a woman. After his flight he had no further relations with James II. After a visit to Rome, he became head of the Jesuit College at St Omer in 1693, from whence he was transferred to Walten in Flanders in 1697. He died on the 15th of May 1699. A younger brother Charles (1644-1712) was also a member of the order.

PETRE, SIR WILLIAM (c. 1505-1572), English politician, was a son of John Petre, a Devon man, and was educated at Exeter College, Oxford, afterwards becoming a fellow of All Souls' College. He entered the public service in early life, owing his introduction therein doubtless to the fact that at Oxford he had been tutor to Anne Boleyn's brother, George Boleyn, Viscount Rochford, and began his official career by serving the English government abroad. In 1536 he was made deputy, or proctor, for the vicar-general, Thomas Cromwell, and as such he presided over the convocation which met in June of this year. In 1543 Petre was knighted and was appointed a secretary of state; in 1545 he was sent as ambassador to the emperor Charles V. A very politic man, he retained his position under Edward VI. and also under Mary, forsaking the protector Somerset at the right moment and winning Mary's goodwill by

favouring her marriage with Philip II. of Spain. He resigned his secretaryship in 1557, but took some part in public business under Elizabeth until his death at his residence, Ingatestone, Essex, on the 13th of January 1572.

His son John Petre (1549-1613) was created Baron Petre of Writtle in 1603. The third baron was his son William (1578-1637), whose grandson was William, the 4th baron (c. 1626-1684). Denounced by Titus Oates as a papist, the last named was arrested with other Roman Catholic noblemen in 1678 and remained without trial in the Tower of London until his death. His brother John (1639-1684) was the 5th lord, and the latter's nephew, Robert (1680-1713), was the 7th lord. It was Robert's action in cutting a lock of hair from a lady's head which led Pope to write his poem "The Rape of the Lock." The Petres have been consistently attached to the Roman Catholic faith, William Joseph, the 13th baron (1847-1893), being a priest of the Roman church, and the barony is still (1911) in existence. One of the 1st baron's grandsons was William Petre (1602-1677), who translated the *Flos sanctorum* of Pedro de Ribadeneira as *Lives of the Saints* (St Omer, 1699, London, 1730).

See *Genealogical Collections illustrating the History of Roman Catholic Families of England*, vol. I., edited by J. J. Howard and H. F. Burke.

PETREL, the general name of a group of birds (of which more than 100 species are recognized), derived from the habit which some of them possess of apparently walking on the surface of the water as the apostle St Peter (of whose name the word is a diminutive form) is recorded (Matt. xiv. 29) to have done. The petrels, all of which are placed in the family *Procellariidae*, were formerly associated with the *Laridae* (see GULL), but they are now placed as the sole members of the suborder *Tubinares* (the name denoting the characteristic tubular structure of their nostrils) and of the order *Procellariiformes* (see BIRD). They are subdivided into four groups or subfamilies: (1) *Pelecanoidinae* (or *Halodromiinae*), containing some three or four species known as diving-petrels, with habits very different from others of the family, and almost peculiar to high southern latitudes from Cape Horn to New Zealand; (2) *Procellariinae*, or petrels proper (and shearwaters); (3) *Diomedinae*, or albatrosses (see MALLEWUCK); and (4) *Oceanitinae*, containing small sooty-black birds of the genera *Cymodroma*, *Pealea*, *Pelagodroma*, *Garradus* and *Oceanites*, the distinctive nature of which was first recognized by Coues in 1864.

Petrels are archaic oceanic forms, with great powers of flight, dispersed throughout all the seas and oceans of the world, and some species apparently never resort to land except for the purpose of nidification, though nearly all are liable at times to be driven ashore, and often very far inland, by gales of wind.¹ It would also seem that during the breeding-season many of them are wholly nocturnal in their habits, passing the day in holes of the ground, or in clefts of the rocks, in which they generally nestle, the hen of each pair laying a single white egg, sparsely speckled in a few species with fine reddish dots. Of those species that frequent the North Atlantic, the common Storm-Petrel, *Procellaria pelagica*, a little bird which has to the ordinary eye rather the look of a Swift or Swallow, is the "Mother Carty's chicken" of sailors, and is widely believed to be the harbinger of bad weather, but seamen hardly discriminate between this and other nearly resembling it in appearance, such as Leach's or the Fork-tailed Petrel, *Cymochorea leucorhoa*, a rather larger but less common bird, and Wilson's Petrel, *Oceanites oceanicus*, the type of the Family *Oceanitidae* mentioned above, which is more common on the American side. But it is in the Southern Ocean that Petrels most abound, both as species and as individuals. The Cape-Pigeon or Pintado Petrel, *Daption capensis*, is one that has long been well known to mariners and other wayfarers on the great waters, while those who voyage to or from Australia, whatever be the route they take, are

¹ Thus *Oestrata hastilata*, the Capped Petrel, a species whose proper home seems to be Guadeloupe and some of the neighbouring West-Indian Islands, has occurred in the State of New York, near Boulogne, in Norfolk, and in Hungary (*Ibis*, 1884, p. 302).

certain to meet with many more species, some, as *Oxyfraga gigantea*, as large as Albatrosses, and several of them called by sailors by a variety of choice names, generally having reference to the strong smell of musk emitted by the birds, among which that of "Stink-pot" is not the most opprobrious. None of the Petrels are endowed with any brilliant colouring—sooty-black, grey of various tints (one of which is often called "blue"), and white being the only hues the plumage exhibits.

The distribution of the several species of Petrels in the Southern Ocean has been treated by A. Milne-Edwards in the *Annales des sciences naturelles* for 1882 (6th series *Zoologie*, vol. xiii. art. 4, pp. 1-22).

PETRIE, GEORGE (1790-1866), Irish antiquary, was the son of James Petrie, a native of Aberdeen, who had settled in Dublin as a portrait and miniature painter. He was born in Dublin in January 1790, and was educated as an artist. Besides attaining considerable reputation as a painter of Irish landscape, he devoted much time to the illustration of the antiquities of the country. In 1828 he was appointed to conduct the antiquarian and historical section of the Ordnance Survey of Ireland. In 1832 he became editor of the *Dublin Penny Journal*, a periodical designed to disseminate information among the masses, to which he contributed numerous articles on the history of the fine arts in Ireland. Petrie may be regarded as the first scientific investigator of Irish archaeology, his contributions to which are also in themselves of much importance. His *Essay on Round Towers*, for which in 1830 he received the prize of the Irish Academy, still ranks as a standard work. Among his other contributions to Irish archaeology are his *Essay on the Military Architecture of Ireland* and his *History and Antiquities of Tara Hill*. He died on the 17th of January 1866.

See the *Life and Labours in Art and Archaeology of George Petrie*, by William Stokes (1868).

PETRIE, WILLIAM MATTHEW FLINDERS (1853-), English Egyptologist, was born at Charlton on the 3rd of June 1853, being the son of William Petrie, C.E. His mother was the daughter of Captain Matthew Flinders, the Australian explorer. He took an early interest in archaeological research, and between 1875 and 1880 was busily engaged in studying ancient British remains at Stonehenge and elsewhere; in 1880 he published his book on Stonehenge, with an account of his theories on this subject. He was also much interested in ancient weights and measures, and in 1875 published a work on *Inductive Metrology*. In 1881 he began a long series of important surveys and excavations in Egypt, beginning with the pyramids at Giza, and following up his work there by excavations at the great temple at Tanis (1884), and discovering and exploring the long-lost Greek city of Naukratis in the Delta (1885), and the towns of Am and Daphnae (1886), where he found important remains of the time when they were inhabited by the Pharaohs. Between 1888 and 1890 he was at work in the Fayum, opening up Hawara, Kahun and Lachish; and in 1891 he discovered the ancient temple at Medum. Much of this work was done in connexion with the Palestine Exploration Fund. By this time his reputation was established. He published in 1893 his *Ten Years' Diggings in Egypt*, was given the honorary degree of D.C.L. by Oxford, and was appointed Edwards Professor of Egyptology at University College, London. In 1894 he founded the Egyptian Research Account, which in 1905 was reconstituted as the British School of Archaeology in Egypt (not to be confused with the Egypt Exploration Fund, founded 1892). Perhaps the most important work which the School has accomplished has been the investigation of the site of Memphis (q.v.).

The extent as well as the chronological order of Professor Petrie's excavations may best be shown by a list of his works.

WORKS.—His chief general works on Egyptian subjects are, *Ten Years' Diggings in Egypt* (1893); *History of Egypt* (1894-1905); *Egyptian Tales* (1895); *Religion and Conscience in Ancient Egypt* (1898); *Syria and Egypt* (1898); *Royal Tombs of the First Dynasty* (1900); *Royal Tombs of the Earliest Dynasties* (1901); *Egyptus and Israelite Cities* (1906); *Religion of Ancient Egypt* (1906); *Personal Religion in Egypt* (1908). On particular sites, *Pyramids and Temples of Giza* (1883); *Tanis I.* (1885); *Naukratis I.* (1886); *Hawara* (1889); *Kahun* (1890); *Illahun* (1891); *Medum* (1892);

Tell el Amarna (1893); *Koptos* (1896); *Negada* (1896); *Six Temples at Thebes* (1897); *Dashashah* (1897); *Deir el Bahari* (1900); *Diospolis* (1901); *Abydos I.* (1902); *Abydos II.* (1903); *Ehnasya* (1904); *Egyptians in Sinai and Researches in Sinai* (1906); *Gash and Rifah* (1907); *Althribis* (1908); *Memphis and Qurna* (1909).

PETRIOU (also called *Chang-sao*), a town and port of Siam, in the division of Pachin, about 45 m. E. of Bangkok. It is the centre of that part of southern Siam which is watered by the Bang Pakong River. It is built on low-lying, swampy ground, about 10 m. from the mouth of the above river. The population is about 10,000, mixed Siamese and Chinese, the latter slightly predominating. Rice-mills give employment to a large number of indentured Chinese coolies, but the inhabitants are chiefly engaged in agriculture. A railway connecting with Bangkok was opened in the spring of 1908.

PETROLEA, a town and port of entry in Lambton county, Ontario, Canada, situated 42 m. W. of London on Bear Creek, an affluent of Sydenham River, and on the Grand Trunk and Michigan Central railways. Pop. (1901), 4135. It is in the midst of the oil region of Canada, and numerous wells in the vicinity have an aggregate output of about 30,000,000 gallons of crude oil per annum, much of which is refined in the town.

PETROLEUM (Lat. *petra*, rock, and *oleum*, oil), a term which, in its widest sense, embraces the whole of the hydrocarbons, gaseous, liquid and solid, occurring in nature (see BITUMEN). Here the application of the term is limited to the liquid which is so important an article of commerce, though references will also be made to natural gas which accompanies petroleum. Descriptions of the solid forms will be found in the articles on asphalt or asphaltum, albertite, elaterite, gilsonite, hatchettite and ozokerite. Particulars of the shales which yield oil on destructive distillation are given in the article on paraffin.

Ancient History.—Petroleum was collected for use in the most remote ages of which we have any records. Herodotus describes the oil pits near Ardericca (near Babylon), and the pitch spring of Zacynthus (Zante), whilst Strabo, Dioscorides and Pliny mention the use of the oil of Agrigentum, in Sicily, for illumination, and Plutarch refers to the petroleum found near Ecbatana (Kerkuk). The ancient records of China and Japan are said to contain many allusions to the use of natural gas for lighting and heating. Petroleum ("burning water") was known in Japan in the 7th century, whilst in Europe the gas springs of the north of Italy led to the adoption in 1226 by the municipality of Salsomaggiore of a salamander surrounded by flames as its emblem. Marco Polo refers to the oil springs of Baku towards the end of the 13th century; the medicinal properties of the oil of Tegerasse in Bavaria gave it the name of "St Quirinus's Oil" in 1436; the oil of Pechelbronn, Elsass, was discovered in 1498, and the "earthbalsam" of Galicia was known in 1506. The earliest mention of American petroleum occurs in Sir Walter Raleigh's account of the Trinidad pitch-lake in 1595; whilst thirty-seven years later, the account of a visit of a Franciscan, Joseph de la Roche d'Allion, to the oil springs of New York was published in Sagard's *Histoire du Canada*. In the 17th century, Thomas Shirley brought the natural gas of Wigan, in Shropshire, to the notice of the Royal Society. In 1724 Hermann Boernaave referred to the oleum terrae of Burma, and "Barbados tar" was then well known as a medicinal agent. A Russian traveller, Peter Kalm, in his work on America, published in 1748, showed on a map the oil springs of Pennsylvania, and about the same time Raicevich referred to the "liquid bitumen" of Rumania.

Modern Development and Industrial Progress.—The first commercial exploitation of importance appears to have been the distillation of the oil at Alfreton in Derbyshire by James Young, who patented his process for the manufacture of paraffin in 1850. In 1853 and 1854 patents for the preparation of this substance from petroleum were obtained by Warren de la Rue, and the process was applied to the "Rangoon oil" brought to Great Britain from Yenangaung in Upper Burma. The active growth of the petroleum industry of the United States began in 1859, though in the early part of the century the petroleum of Lake Seneca, N.Y., was used as an embrocation under the

name of "Seneca oil," and the "American Medicinal Oil" of Kentucky was largely sold after its discovery in 1829. The Pennsylvania Rock Oil Company was formed in 1854, but its operations were unsuccessful, and in 1858 certain of the members founded the Seneca Oil Company, under whose direction E. L. Drake started a well on Oil Creek, Pennsylvania. After drilling had been carried to a depth of 69 feet, on the 28th of August 1859, the tools suddenly dropped into a crevice, and on the following day the well was found to have "struck oil." This well yielded 25 barrels a day for some time, but at the end of the year the output was at the rate of 15 barrels. The production of crude petroleum in the United States was officially reported to have been 2000 barrels in 1859, 4,215,000 barrels in 1869, 19,914,146 barrels in 1879, 35,163,513 barrels in 1889, 57,084,428 barrels in 1899, and 126,493,936 barrels in 1906. From Oil Creek, development spread first over the eastern United States and then became general, subsequently embracing Canada (1862), recently discovered fields being those of Illinois, Alberta and California (44,854,737 barrels in 1908).

For about 70 years Pennsylvania was the one great oil producer of the world, but since 1870 the industry has spread all over the globe. From the time of the completion on the Baku field of the first flowing well (which was unmanageable and resulted in the loss of the greater part of the oil), Russia has ranked second in the list of producing countries, whilst Galicia and Rumania became prominent in 1878 and 1880 respectively. Sumatra, Java and Borneo, where active development began in 1883, 1886 and 1896, bid fair to rank before long among the chief sources of the oil supplies of the world. Similarly, Burma, where the Burmah Oil Company have, since 1890, rapidly extended their operations, is rising to a position of importance. Oil fields are being continually opened up in other parts of the world, and whilst America still maintains her position as the largest petroleum producer, the world's supplies are now being derived from a steadily increasing number of centres.

Physical and Chemical Properties.—Although our information respecting the chemical composition of petroleum has been almost entirely gained since the middle of the 18th century, a considerable amount of empirical knowledge of the substance was possessed by chemists at an earlier date, and there was much speculation as to its origin. In his *Sylva sylvarum* (1627), Francis Bacon states that "the original concretion of bitumen is a mixture of a fiery and watery substance," and observes that flame "attracts" the naphtha of Babylon "afar off." P. J. Macquer (1764), T. O. Bergman (1784) Charles Hatchett (1798) and others also expressed views with regard to the constitution and origin of bitumens. Of these early writers, Hatchett is the most explicit, the various bituminous substances being by him classified and defined. Jacob Joseph Winterl, in 1788, appears to have been the first to examine petroleum chemically, but the earliest systematic investigation was that carried out by Professor B. Silliman, Jun., in 1855, who then reported upon the results which he had obtained with the "rock oil or petroleum" of Venango county, Pennsylvania. This report has become a classic in the literature of petroleum.

The physical properties of petroleum vary greatly. The colour ranges from pale yellow through red and brown to black or greenish, while by reflected light it is, in the majority of cases, of a green hue. The specific gravity of crude petroleum appears to range from .771 to 1.06, and the flash point from below 0° to 370°F. Viscosity increases with density, but oils of the same density often vary greatly; the coefficient of expansion, on the other hand, varies inversely with the density, but bears no simple relation to the change of fluidity of the oil under the influence of heat, this being most marked in oils of paraffin base. The calorific power of Baku oil appears to be highest, while this oil is poorest in solid hydrocarbons, of which the American petroleum contains moderate quantities, and the Upper Burma oils the largest amount. The boiling point, being determined by the character of the constituents of the oil, necessarily varies greatly in different oils, as do the amounts of distillate obtained from them at specified temperatures.

Even prior to the discovery of petroleum in commercial quantities, a number of chemists had made determinations of the chemical composition of several different varieties, and these investigations, supplemented by those of a later date, show that petroleum consists of about 84% by weight of carbon with 12% of hydrogen, and varying proportions of sulphur, nitrogen and oxygen. The principal elements are found in various combinations, the hydrocarbons of the Pennsylvania oils being mainly paraffins (*q.v.*), while those of Caucasian petroleum belong for the most part to the naphthenes, isomeric with the olefines (*q.v.*). Paraffins are found in all crude oils, and olefines in varying proportions in the majority, while acetylene has been found in Baku oil; members of the benzene group and its derivatives, notably benzene and toluene, occur in all petroleum. Naphthenes are the chief components of some oils, as already indicated, and occur in varying quantities in many others. Certain crude oils have also been found to contain camphenes, naphthalene and other aromatic hydrocarbons. It is found that transparent oils under the influence of light absorb oxygen, becoming deeper in colour and opalescent, while strong acidity and a penetrating odour are developed, these changes being due to the formation of various acid and phenylated compounds, which are also occasionally found in fresh oils. The residues from petroleum distillation have been shown to contain very dense solids and liquids of high specific gravity, having a large proportion of carbon and possessed of remarkable fluorescent properties.

Natural gas is found to consist mainly of the lower paraffins, with varying quantities of carbon dioxide, carbon monoxide, hydrogen, nitrogen and oxygen, in some cases also sulphuretted hydrogen and possibly ammonia. This mixture dissolves in petroleum, escaping when the oil is stored, and conversely it invariably carries a certain amount of water and oil, which is deposited on compression.

Occurrence.—Bitumen is, in its various forms, one of the most widely-distributed of substances, occurring in strata of every geological age, from the lowest Archean rocks to those now in process of deposition, and in greater or less quantity throughout both hemispheres, from Spitzbergen to New Zealand, and from California to Japan. The occurrence of commercially valuable petroleum is, however, comparatively limited, hitherto exploited deposits being confined to rocks younger than the Cambrian and older than the Quaternary, while the majority of developed oil-fields have been discovered north of the equator.

The main requisites for a productive oil or gas field are a porous reservoir and an impervious cover. Thus, while the mineral may be formed in a stratum other than that in which it is found, though in many cases it is indigenous to it, for the formation of a natural reservoir of the fluid (whether liquid or gas) it is necessary that there should be a suitable porous rock to contain it. Such a rock is typically exemplified by a coarse-grained sandstone or conglomerate, while a limestone may be naturally porous, or, like the Trenton limestone of Ohio and Indiana, rendered so by its conversion into dolomite and the consequent production of cavities due to shrinkage—a change occurring only in the purer limestones. Similarly it is necessary, in view of the hydrostatical relations of water and mineral oils, and the volatile character of the latter, that the porous stratum should be protected from water and air by an overlying shale or other impervious deposit. Water, often saline or sulphurous, is also found in these porous rocks and replaces the oil as the latter is withdrawn.

In addition to these two necessary factors, structural conditions play an important part in determining the accumulation of oil and gas. The main supplies have been obtained from strata unbroken and comparatively undisturbed, but the occurrence of anticlinal or terrace structure, however slightly marked or limited in extent, exerts a powerful influence on the creation of reservoirs of petroleum. These tectonic arches often extend for long distances with great regularity, but are frequently crossed by subsidiary anticlines, which themselves play a not unimportant part in the aggregation of the oil. Owing to difference of density the oil and water in the anticlines separate into two layers, the upper consisting of oil which fills the anticlines, while the water remains in the synclines. Any gas which may be present rises to the summits of the anticlines. When the slow folding of the strata is accompanied by a gradual local descent, a modified or "arrested" anticlinal structure, known as a "terrace" is produced, the upheaving action at that part being sufficient only to arrest the descent which would otherwise occur. The terraces may thus be regarded as flat and extended anticlines. They need not be horizontal, and sometimes have a dip of a few feet per mile, as in the case of the Ohio and Indiana oil fields, where the amount varies from

one to ten feet. These slight differences in level, however, are found to have a most powerful effect in the direction already mentioned.

It is evident that accurate knowledge of the character and structure of the rock-formations in petroliferous territories is of the greatest importance in enabling the expert to select favourable sites for drilling operations; hence on well-conducted petroleum-properties it is now customary to note the character and thickness of the strata perforated by the drill, so that a complete section may be prepared from the recorded data. In some cases the depths are stated with reference to sea-level, instead of being taken from the surface, thus greatly facilitating the utilization of the records.

Oil and gas are often met with in drilled wells under great pressure, which is highest as a rule in the deepest wells. The closed pressure in the Trenton limestone in Ohio and Indiana is about 200-300 lb. per sq. in., although a much higher pressure has been registered in many wells. The gas wells of Pennsylvania indicate about double the pressure of those drilled in the Trenton limestone, 600-800 lb. not being unusual, and even 1000 lb having been recorded. The extremely high pressure under which oil is met with in wells drilled in some parts of the Russian oil fields is a matter of common knowledge, and a fountain or spouting well resulting therefrom is one of the "sights" of the country. A famous fountain in the Grozny oil field in the northern Caucasus, which began to flow in August 1895, was estimated to have thrown up during the first three days 1,200,000 poods (over 4,500,000 gallons, or about 18,500 tons) of oil a day. It flowed continuously, though in gradually diminishing quantity, for fifteen months; afterwards the flow became intermittent. In April 1897 there was still an occasional outburst of oil and gas.

Three theories have been propounded to account for this pressure—

1. That it results from the weight of the overlying strata.
2. That it is due to water-pressure, as in artesian wells ("hydrostatic" or "artesian" theory).
3. That it is caused by the compressed condition of the gradually accumulating gas.

Of these the first has been proved untenable, and while in some instances (e.g. certain wells in Ohio), the second has held good, the third appears to be the most widely applicable.

The conditions of formation and accumulation of petroleum point to the fact that the principal oil fields of the world are merely reservoirs, which will become exhausted in the course of years, as in the case of the decreasing yield of certain of the American fields. But new deposits are continually being exploited, and there may be others as yet unknown, which would entirely alter any view that might be expressed at the present time in regard to the probable duration of the world's supply of oil and gas.

As already stated, every one of the great geological systems appears to have produced some form of bitumen, and in the following table an attempt has been made to classify on this basis the various localities in which petroleum or natural gas has been found in large or small quantities:—

Recent.—Lancashire (Down Holland Moss), Holland, Sweden, Sardinia, Kaluga (Russia), Red Sea, Mediterranean.

Pleistocene.—Schleswig-Holstein, Minnesota, Illinois, Louisiana.

Pliocene.—Spain, Italy, Albania, Croatia, Hungary, Hesse, Hanover, Transcaasia, Algeria, Florida, Alabama, California, Mexico, Peru, Victoria, New Zealand.

Miocene.—France, Switzerland, Spain, Italy, Sicily, Greece, Rumania, Turkey-in-Europe, Styria, Slavonia, Hungary, Transylvania, Galicia, Lower Austria, Württemberg, Brandenburg, West Prussia, Crimea, Kuban, Kutais, Tiflis, Elizabetpol, Siberia, Transcaasia, Mesopotamia, Persia, Assam, Burma, Anam, Japan, Philippine Islands, Borneo, Sumatra, Java, Algeria, Egypt, British Columbia, Alaska, Washington, California, Colorado, Texas, Louisiana, Barbados, Trinidad, Venezuela, Peru, South Australia, Victoria, New Zealand.

Oligocene.—France, Spain, Greece, Rumania, Hungary, Transylvania, Galicia, Bavaria, Elsass, Rhenish Bavaria, Hesse, Saxony, Crimea, Daghestan, Tiflis, Baku, Alaska, California, Florida.

Eocene.—Devonshire (retinasphalt), France, Spain, Italy, Asia Minor, Montenegro, Bosnia and Herzegovina, Rumania, Dalmatia, Istria, Hungary, Transylvania, Galicia, Moravia, Bavaria, Elsass, Kutais, Armenia, Persia, Baluchistan, Afghanistan, Punjab, Assam, Sumatra, Algeria, Egypt, Maryland, Colorado, Utah, Nevada, California, Louisiana, Texas, Cuba, Colombia, Brazil.

Cretaceous.—Holland, France, Switzerland, Spain, Italy, Sicily, Greece, Hungary, Silesia, Moravia, Westphalia, Brunswick, Hanover, Schleswig-Holstein, (German) Silesia, Poland, Kutais, Uralsk, Turkestan, Armenia, Syria, Arabia, Persia, Tunis, Egypt, West Africa, British Columbia, Alberta, Assiniboia, Athabasca, Manitoba, New Jersey, South Dakota, Washington, Montana, Oklahoma, Utah, Wyoming, Colorado, California, New Mexico, Arkansas, Texas, Louisiana, Mexico, Hayti, Trinidad, Colombia, Argentina [?], New Zealand.

Neocomian.—Sussex, France, Switzerland, Spain, Hungary, Transylvania, Bukowina, Galicia, Hesse, Baden, Hanover, Brunswick, California, Texas, Mexico, Bolivia, Argentina.

Jurassic.—Yorkshire, Somerset, Buckingham, France, Switzer-

land, Spain, Italy, Lower Austria, Baden, Elsass, Hesse, Hanover, Brunswick, Sizaran, Tiflis, Siberia, Persia, Madagascar, Alaska, Wyoming, Colorado, Mexico, Argentina.

Triassic.—Yorkshire, Staffordshire, France, Portugal, Spain, Italy, Montenegro, Upper Austria, Tyrol, Bavaria, Württemberg, Baden, Elsass, Lothringen, Rhenish Bavaria, Rhenish Prussia, Hanover, Brunswick, Sweden, Spitzbergen, Punjab, China, Transvaal, Cape Colony, Connecticut, New Jersey, Virginia, North Carolina, Wyoming, Argentina, New South Wales, Queensland.

Permian.—Yorkshire, Denbigh, Moravia, Bohemia, Baden, Saxony, Volodga, Ala, Kazan, Simbirsk, Samara, Kansas, Wyoming, Oklahoma, Texas (Permo-Carboniferous).

Carboniferous.—Scotland, North of England, and Midlands, Wales, France, Belgium, Carniola, Moravia, Elsass, Saxony, Perm, Sizaran, China, Cape Colony, Nova Scotia, Newfoundland, Pennsylvania, West Virginia, Ohio, Michigan, Indiana, Illinois, Iowa, Missouri, Tennessee, Kentucky, Alabama, Kansas, Arkansas, Colorado, Oklahoma, Tasmania, Victoria (Permo-Carboniferous), West Australia (Permo-Carboniferous).

Devonian.—Scotland, Devonshire, Spain, Hanover, Archangel, Vitebsk, Athabasca, Mackenzie, Ontario, Quebec, New Brunswick, Newfoundland, New York, Pennsylvania, West Virginia, Ohio, Michigan, Wisconsin, Kentucky.

Silurian.—Shropshire, Wales, Bohemia, Sweden, Estonia, Manitoba, Ontario, Quebec, Newfoundland, New York, Pennsylvania [?], Ohio, Michigan, Indiana, Illinois, Minnesota, Tennessee, Kentucky, Georgia, Alabama, Oklahoma, New Mexico, New Caledonia.

Cambrian.—Shropshire, New York.

Archean.—France, Norway, Sweden, Ontario.

In this list, while certain occurrences in rocks of undetermined age in little-known regions have been omitted, many of those included are of merely academic interest, and a still larger number indicate fields supplying at present only local needs. All have been arranged in geographical order without reference to productive capacity or importance. It should be pointed out that the deposits which have been hitherto of chief commercial importance occur in the old rocks (Carboniferous to Silurian) on the one hand, and in the comparatively new Tertiary formations on the other, the intermediate periods yielding but little or at any rate far less abundantly.

Origin.—The question of the origin of petroleum (and natural gas), though for the first half of the 19th century of little more than academic interest, has engaged the attention of naturalists and others for over a hundred years. As early as 1804, Humboldt expressed the opinion that petroleum was produced by distillation from deep-seated strata, and Karl Reichenbach in 1834, suggested that it was derived from the action of heat on the turpentine of pine-trees, whilst Brunet, in 1838, adumbrated a similar theory of origin on the ground of certain laboratory experiments. The theories propounded may be divided into two groups, namely, those ascribing to petroleum an inorganic origin, and those which regard it as the result of the decomposition of organic matter.

M. P. E. Berthelot was the first to suggest, in 1866, after conducting a series of experiments, that mineral oil was produced by purely chemical action, similar to that employed in the manufacture of acetylene. Other theories of a like nature were brought forward by various chemists, Mendelëff, for example, ascribing the formation of petroleum to the action of water at high temperatures on iron carbide in the interior of the earth.

On the other hand, an overwhelming and increasing majority of those who have studied the natural conditions under which petroleum occurs are of opinion that it is of organic origin. The earlier supporters of the organic theory held that it was a product of the natural distillation of coal or carbonaceous matter; but though in a few instances volcanic intrusions appear to have converted coal or allied substances into oil, it seems that terrestrial vegetation does not generally give rise to petroleum. Among those who have considered that it is derived from the decomposition of both animal and vegetable marine organisms may be mentioned J. P. Lesley, E. Orton and S. F. Peckham, but others have held that it is of exclusively animal origin, a view supported by such occurrences as those in the orthoceratites of the Trenton limestone, and by the experiments of C. Engler, who obtained a liquid like crude petroleum by the distillation of menhaden (fish) oil. Similarly there is a difference of opinion as to the conditions under which the organisms have been mineralized, some holding that the process has taken place at a high temperature and under great pressure; but the lack of practical evidence in nature in support of these views has led many to conclude that petroleum, like coal, has been formed at moderate temperatures, and under pressures varying with the depth of the containing rocks. This view is supported by the fact that petroleum is found on the Sardinian and Swedish coasts as a product of the decomposition of seaweed, heated only by the sun, and under atmospheric pressure.

Consideration of the evidence leads us to the conclusion that, at least in commercially valuable deposits, mineral oil has generally been formed by the decomposition of marine organisms, in some cases animal, in others vegetable, in others both, under practically normal conditions of temperature and pressure.

Extraction (Technically termed Production).—The earliest system adopted for the collection of petroleum appears to have consisted in skimming the oil from the surface of the water upon which it had accumulated, and Professor Lealey states that at Paint Creek, in Johnson county, Kentucky, a Mr George and others were in the habit of collecting oil from the sands, "by making shallow canals 100 or 200 ft. long, with an upright board and a reservoir at one end, from which they obtained as much as 200 barrels per year by stirring the sands with a pole." It is said that at Echigo in Japan, old wells, supposed to have been dug several hundred years ago, are existent, and that a Japanese history—called *Kokushiryaku*, states that "burning water" was obtained in Echigo about A.D. 615.

The petroleum industry in the United States may be considered to date from the year 1859, when the first well avowedly drilled to date for the production of oil was completed by E. L. Drake.

The present method of drilling has been evolved from the artesian well system previously adopted for obtaining brine and water. The drilling of petroleum wells is carried on by individuals or companies, either on lands owned by them, or on properties whose owners grant leases, usually on condition that a certain number of wells shall be sunk within a stated period, and that a portion of the oil obtained (usually from one-tenth to one-fourth) shall be appropriated as royalty to the lessor. Such leases are often transferred at a larger royalty, especially after the territory has been proved productive. The "wild-cat" wells, sunk by speculators on untested territory or on lands which had not previously proved productive, played an important part in the earlier mapping out of the petroleum fields. To discourage the sinking of wells on land immediately adjoining productive territory, it has been usual to drill along the borders of the land as far as practicable, in order to first obtain the oil which might otherwise be raised by others; and on account of the small area often controlled by the operator, the number of wells drilled has frequently been far in excess of the number which might reasonably be sunk. Experience has proved that in some of the oil fields of the United States one well to five acres is as close as they should be drilled.

After the selection of the site, the first operation consists in the erection of the rig. The chief portion of this rig is the derrick,

which consists of four strong uprights or legs held in position by ties and braces, and resting on strong wooden sills, which are preferred, as a foundation, to masonry. For drilling the deeper wells, the derrick, on account of the length of the "string" of drilling tools, is usually at least 70 ft. high, about 20 ft. wide at the base, and 4 ft. wide at the summit. The whole derrick is set up by leys, or mortices or tensions being used, and thus the complete rig may be readily taken down and set up on a new site. The mason-post, which supports the walking-beam, and the jack-posts, are dove-tailed and keyed into the sills. The mason-post is placed flush with one side of the main sill, the band-wheel jack-post being flush with the other side, so that the walking-beam, which imparts motion to the string of tools, works parallel with the main sill.

The boiler generally used is of the locomotive type and is usually stationary, though sometimes a portable form is preferred. It is either set in the first instance at some distance from the engine and well, or is subsequently removed sufficiently far away before the drill enters the oil-bearing formation, and until the oil and gas are under control, in order to minimize the risk of fire. A large boiler frequently supplies the engines of several wells. The engine, which is provided with reversing gear, is of 12 or 15 horse-power and motion is communicated through a belt to the band-wheel, which operates the walking-beam by means of a crank. The throttle-valve is opened or closed by turning a grooved vertical pulley by means of an endless cord, called the telegraph, passing round another pulley fixed upon the "headache-post," and is thus under the control of the driller working in the derrick. The headache-post is a vertical wooden beam placed on the main sill directly below the walking-beam, to receive the weight of the latter in case of breakage of connexions. The position of the reversing link is altered by means of a cord, passing over two pulleys, fixed respectively in the engine-house and on the derrick. At one end of the band-wheel shaft is the bull-rope pulley, and upon the other end is a crank having six holes to receive a movable wrist-pin, the length of stroke of the walking-beam being thus adjusted. The revolution of the bull-wheels is checked by the use of a powerful hand-brake.

The band-wheel communicates motion to the walking-beam, while drilling is in progress, through the crank and a connecting-rod known as the pitman; to the bull-wheels, while the tools are being raised, by the bull-rope; and to the sand-pump reel, by a friction pulley, while the sand-pump is being used. It is therefore necessary that the machinery should be so arranged that the connexions may be rapidly made and broken. The sand-pump reel is set in motion by pressing a lever, the reel being then brought into contact with the face of the band-wheel. The sand-pump descends by gravitation, and its fall is checked by pressing back the lever, so as to throw the reel against a post which serves as a brake.

The drilling tools are suspended by an untarred manila rope, 2 in. in diameter, passing from the bull-wheel shaft over a grooved wheel known as the crown-pulley, at the summit of the derrick. The string of drilling tools consists of two parts separated by an appliance known as the jars.

This piece of apparatus was introduced by William Morris in 1831, and consists of a long double link with closely-fitting jaws which, however, slide freely up and down. It may be compared to a couple of elongated and flattened links of chain. The links are about 30 in. long and are interposed between the heavy iron auger-stem carrying the bit and the upper rod, known as the sinker-bar. Their principal use is to give a sharp jar to the drill on the up-stroke so that the bit is dislodged if it has become jammed in the rock. In addition to the appliances mentioned the tools comprise reamers to enlarge the bore of the well, the winged-substitute which is fitted above the bit to prevent it from glancing off, and above the round reamer to keep it in place, a temper-screw with clamps and wrenches. Sand-pumps and bailers are also required to remove detritus, water and oil from the bore-hole.

The action of the jars and temper-screw has been described by John F. Carl as follows: "Suppose the tools to have been just run to the bottom of the well, the jars closed and the cable slack. The men now take hold of the bull-wheels and draw up the slack until the sinker-bar rises, the 'play' of the jars allowing it to come up 13 in. without disturbing the auger-stem. When the jars come together they slack back about 4 in., and the cable is in position to be clamped in the temper-screw. If now the vertical movement of the walking-beam be 24 in., when it starts on the up-stroke the sinker-bar rises 4 in., and the cross-heads come together with a smart blow, then the auger-stem is picked up and lifted 20 in. On the down-stroke, the auger-stem falls 20 in., while the sinker-bar goes down 24 in. to telescope the jars for the next blow coming up. A skilful driller never allows his jars to strike on the down-stroke, they are only used to jar down when the tools stick on some obstruction in the well before reaching the bottom, and in fishing operations. An unskilful workman sometimes 'loses the jar' and works for hours without accomplishing anything. The tools may be standing at the bottom while he is playing with the slack of the cable or they may be swinging all the time several feet from the bottom. As the jar works off, or grows more feeble, by reason of the downward advance of the drill, it is 'tempered' to the proper strength by letting down the temper-screw to give the jars more play. The temper-screw forms the connecting link between the walking-beam and cable, and it is 'let out' gradually to regulate the play of the jars as fast as the drill penetrates. When its whole length is run down, the rope clamps play very near the well-mouth. The tools are then withdrawn, the well is sand-pumped, and preparations are made for the next 'run.'"

The ordinary sand-pump or bailer, consists of a plain cylinder of light galvanized iron with a bail at the top and a stem-valve at the bottom. It is usually about 6 ft. in length but is sometimes as much as 15 or 20 ft., and as its valve-stem projects downwards beyond the bottom, it empties itself when rested upon the bottom of the waste-trough.

The operation of drilling is frequently interrupted by the occurrence of an accident, which necessitates the use of fishing tools. If the fishing operation is unsuccessful the well has to be abandoned, often after months of labour, unless it is found possible to drill past the tools which have been lost. In readiness for a fracture of the drilling tools or of the cable, special appliances known as fishing tools are provided. These are so numerous and varied in form that a description would be impossible within the scope of this article. The fishing tools are generally attached to the cable, and are used with portions of the ordinary string of tools, but some are fitted to pump-rods or tubing, and others to special rods.

The drilling of a well is commonly carried out under contract, the producer erecting the derrick and providing the engine and boiler while the drilling contractor finds the tools, and is responsible for accidents or failure to complete the well. The drilling "crew" consists of two drillers and two tool-dressers, working in pairs in two "tours" (noon to midnight and midnight to noon).

The earlier wells in Pennsylvania consisted of three sections, the first formed of surface clays and gravels, the second of stratified rocks containing water, and the third of stratified rocks, including the oil-sands, usually free from water. The conductor, which was a wooden casing of somewhat greater internal diameter than the maximum bore of the well, passed through the first of these divisions, and casing was used in the second to prevent percolation of water into the oil-bearing portion. In later wells the conductor has been replaced with an 8-in. wrought-iron drive-pipe, terminating in a steel shoe, which is driven to the bed-rock, and a 7½-in. hole is drilled below it to the base of the lowest water-bearing stratum. The bore is then reduced to 5½ in., and a bevelled shoulder being made in the rock, a 5½ in. casing, having a collar to fit water-tight on the bevel shoulder, is inserted. The well is then completed with a 5½ in. bit. As the water is shut off before the portion of the well below the water-bearing strata is bored the remainder of the drilling is conducted with only sufficient water in the well to

admit of sand-pumping. The drill is thus allowed to fall freely, instead of being partly upheld by the buoyancy of the water, as in earlier wells.

Wells in Pennsylvania now range in depth from 300 ft. to 3700 ft. Four strings of iron casing are usually employed, having the following diameters: 10 in., 8½ in., 6½ in. and 5 in., the lengths of tube forming the casing being screwed together. Contractors will often undertake to drill wells of moderate depth at 90 cents to \$1 per foot, but the cost of a deep well may amount to as much as \$7000.

The rotary system of drilling which is in general use in the oil-fields of the coastal plain of Texas is a modification of that invented by Fauvelle in 1845, and used in the early years of the industry in some of the oil-producing countries of Europe. It is one of the most rapid and economical which can be employed in soft formations, but where hard rock is encountered it is almost useless. The principle of this system consists essentially in the use of rotating hollow drilling rods or casing, to which is attached the drilling-bit and through which a continuous stream of water, under a pressure of 40 to 100 lb. per sq. in., is forced.

The yield of petroleum wells varies within very wide limits, and the relative importance of the different producing districts is also constantly changing. I. C. White, state geologist of West Virginia, estimates that in fairly good producing sand a cubic foot of rock contains from 6 to 12 pints of oil. He assumes that in what is considered a good producing district the amount of petroleum which can be obtained from a cubic foot of rock would not be more than a gallon, and that the average thickness of the oil-bearing rock would not exceed 5 ft. Taking these figures as a basis, the total yield of oil from an acre of petroliferous territory would be a little over 5000-barrels of 42 U.S. gallons.

A flow of oil may often be induced in a well which would otherwise require to be pumped, by preventing the escape of gas which issues with the oil, and causing its pressure to raise the oil. The device employed for this purpose is known as the water-packer, and consists in its simplest form of an india-rubber ring, which is applied between the tubing and the well-casing, so that upon compression it makes a tight joint. The gas thus confined in the oil-chamber forces the oil up the tubing.

For pumping a well a valved working-barrel with valved sucker is attached to the lower end of the tubing, a perforated "anchor" being placed below. The sucker carries a series of three or four leather cups, which are pressed against the inner surface of the working barrel by the weight of the column of oil. The sucker is connected by a string of sucker-rods with the walking-beam. There is usually fixed above the sucker a short iron valve-rod, with a device known as a rivet-catcher to prevent damage to the pump by the dropping of rivets from the pump-rods.

On the completion of drilling, or when the production is found to decrease, it is usual to torpedo the well to increase the flow.

The explosive employed is generally nitroglycerin. The amount used has been increased from the original 4 to 6 quarts to 60, 80, 100 and even 200 quarts. It is placed in tin canisters of about 3½ to 5 in. in diameter and about 10 ft. in length. The canisters have conical bottoms and fit one in the other. They are consecutively filled with nitroglycerin, and are lowered to the bottom of the well, one after the other, by a cord wound upon a reel, until the required number have been inserted. Formerly the upper end of the highest canister was fitted with a "firing-head," consisting of a circular plate of iron, slightly smaller than the bore of the well, and having attached to its underside a vertical rod or pin carrying a percussion cap. The cap rested on the bottom of a small iron cylinder containing nitroglycerin. To explode the charge an iron weight, known as a go-devil, was dropped into the well, and striking the disk exploded the cap and fired the torpedo. Now, however, a miniature torpedo known as a go-devil squib, holding about a quart of nitroglycerin, and having a firing-head similar to that already described, is almost invariably employed. The disk is dispensed with, and the percussion cap is exploded by the impact of a leaden weight running on a cord. The squib is lowered after the torpedo, and, when exploded by the descent of the weight, fires the charge. It must be borne in mind that although the explosion may increase the production for a time, it is by no means certain that the actual output of a well is increased in all such cases, though from some wells there would be no production without the use of the torpedo.

The petroleum industry in Canada is mainly concentrated in the district of Petrolia, Ontario. On account of the small depth of the wells, and the tenacious nature of the principal strata bored through, the Canadian method of drilling differs from the Pennsylvanian or American system in the following particulars:—

1. The use of slender wooden boring-rods instead of a cable.
2. The employment of a simple auger instead of a spudding-bit.
3. The adoption of a different arrangement for transmitting motion.
4. The use of a lighter set of drilling tools.

Although petroleum wells in Russia have not the depth of many

of those in the United States, the disturbed character of the strata, with consequent liability to caving, and the occurrence of hard concretions, render drilling a lengthy and expensive operation. It is usual to begin by making an excavation 8 ft. in diameter and 24 ft. in depth, and lining the sides of this with wood or brick. The initial diameter of the well drilled from the bottom of this pit is in some instances as much as 36 in., bore-holes of the larger size being preferred, as they are less liable to become choked, and admit of the use of larger bailers for raising the oil.

The drilling of wells of large size requires the use of heavy tools and of very strong appliances generally. The system usually adopted is a modification of the Canadian system already described, the boring rods being, however, of iron instead of wood, but the cable system has also to some extent been used. For the ordinary 2-in. plain-laid manila cable a wire rope has in some cases been successfully substituted.

Riveted iron casing, made of ¾-in. plate, is employed, and is constantly lowered, as to follow the drill closely, in order to prevent caving. Within recent years, owing to the initiative of Colonel English, a method of raising oil by the agency of compressed air has been introduced into the Baku oil-fields.

In Galicia the Canadian system is nearly exclusively adopted. In some instances under-reaming is found necessary. This consists in the use of an expanding reamer by means of which the well may be drilled to a diameter admitting of the casing descending freely, which obviously could not be accomplished with an ordinary bit introduced through the casing. Of late years the under-reamer has been largely superseded by the eccentric bit.

The Davis calyx drill has also been employed for petroleum drilling. This apparatus may be described as a steel-pointed conical shell, the lower end of which is made, by a process of gulleting, into a series of sharp teeth, which are set in and out alternately. The outward set of teeth drill the hole large enough to permit the drilling apparatus to descend freely, and the teeth set inwardly pare down the core to such a diameter as will admit of the body of the cutter passing over it without seizing. The calyx is a long tube, or a series of connected tubes, situated above the core barrel, to which it is equal in diameter.

In conclusion it may be stated that the two systems of drilling for petroleum with which by far the largest amount of work has been, and is being done, are the American or rope system, and the Canadian or rod system. The former is not only employed in the United States, but is also used in Upper Burma, Java, Rumania and elsewhere. The latter was introduced by Canadians into Galicia and, with certain modifications, has hitherto been found to be the best for that country. A form of the rod system is used in the Russian oil-fields, but owing to the large diameter of the wells the appliances differ from those employed elsewhere.

The wells from which the supplies of natural gas are obtained in the United States are drilled and cased in the same manner as the oil wells.

Transport and Storage.—In the early days of the petroleum industry the oil was transported in the most primitive manner. Thus, in Upper Burma, it was conveyed in earthenware vessels from the wells to the river bank, where it was poured into the holds of boats. It is interesting to find that a rude pipe-line formerly existed in this field for conveying the crude oil from the wells to the river; this was made of bamboos, but it is said that the loss by leakage was so great as to lead to its immediate abandonment on completion. In Russia, until 1875, the crude oil was carried in barrels on Persian carts known as "arbas." These have two wheels of 8½ to 9 ft. in diameter, the body carrying one barrel, while another is slung beneath the axle. In America, crude petroleum was at first transported in iron-hooped barrels, holding from 40 to 42 American gallons, which were carried by teamsters to Oil Creek and the Allegheny River, where they were loaded on boats, these being floated down stream whenever sufficient water was present—a method leading to much loss by collision and grounding. Bulk barges were soon introduced on the larger rivers, but the use of these was partially rendered unnecessary by the introduction of railways, when the oil was at first transported in barrels on freight cars, but later in tank-cars. These at first consisted of an ordinary truck on which were placed two wooden tub-like tanks, each holding about 2000 gallons; they were replaced in 1871 by the modern type of tank-car, constructed with a horizontal cylindrical tank of boiler plate.

The means of transporting petroleum in bulk commonly used at the present day is the pipe-line system, the history of which dates from 1860. In that year S. D. Karns suggested laying a 6-in. pipe from Burning Springs to Parkersburg, West Virginia, a distance of 36 m.; but his proposal was never carried into effect. Two years later, however, L. Hutchinson of New York, laid a short line from the Tarr Farm wells to the refinery, which passed over a hill, the oil being moved on the syphon principle, and a year later constructed another three miles long to the railway. These attempts were, however, unsuccessful, on account of the excessive leakage

at the joints of the pipes. With the adoption of carefully fitted screw-joints in 1865 the pipe line gradually came into general use, until in 1891 the lines owned by the various transit companies of Pennsylvania amounted in length to 25,000 m.

The pumps employed to force the oil through the pipes were at first of the single-cylinder or "donkey" type, but these were found to cause excessive wear—a defect remedied by the use of the Worthington pump now generally adopted. The engines used on the main 6-in. lines are of 600 to 800 h.p., while those on the small-diameter local lines range from 25 to 30 h.p.

Tanks of various types are employed in storing the oil, those at the wells being circular and usually made of wood, with a content of 250 barrels and upwards. Large tanks of boiler-plate are used to receive the oil as it comes through the pipe-lines. Those adopted by the National Transit Company are 90 ft. in diameter and 30 ft. high, with slightly conical wooden roofs covered with sheet iron; their capacity is 35,000 barrels, and they are placed upon the carefully levelled ground without any foundation.

Kerosene is transported in bulk by various means; specially constructed steel tank barges are used on the waterways of the United States, tank-cars on the railroads, and tank-wagons on the roads. The barrels employed in the transport of petroleum products are made of well-seasoned white-oak staves bound by six or eight iron hoops. They are coated internally with glue, and painted in the well-known colours, blue staves and white heads. The tins largely used for kerosene are made by machinery and contain 5 American gallons. They are hermetically sealed for transport.

In Canada, means of transport similar to those already described are employed, but the reservoirs for storage often consist of excavations in the soft Eria clay of the oil district, the sides of which are supported by planks.

The primitive methods originally in use in the Russian oil-fields have already been described; but these were long ago superseded by pipe-lines, while a great deal of oil is carried by tank steamers on the Caspian to the mouth of the Volga where it is transferred to barges and thence at Tzaritsin to railway tank-cars. The American type of storage-tank is generally employed, in conjunction with clay-lined reservoirs.

Natural gas is largely used in the United States, and for some time, owing to defective methods of storage, delivery and consumption, great waste occurred. The improvements introduced in 1890 and 1891, whereby this state of affairs was put an end to, consisted in the introduction of the principle of supply by meter, and the adoption of a comprehensive system of reducing the initial pressure of the gas, so as to diminish loss by leakage. For the latter purpose, Westinghouse gas-regulators are employed, the positions of the regulators being so chosen as to equalize the pressure throughout the service. The gas is distributed to the consumer from the wells in wrought-iron pipes, ranging in diameter from 20 in. down to 2 in. Riveted wrought-iron pipes 3 ft. in diameter are also used. The initial pressure is sometimes as high as 400 lb to the sq. in., but usually ranges from 200 to 300 lb. The most common method of distribution in cities and towns is by a series of pipes from 12 in. down to 2 in. in diameter, usually carrying a pressure of about 4 oz. to the sq. in. To these pipes the service-pipes leading into the houses of the consumers are connected.

Refining of Petroleum.—The distillation of petroleum, especially of such as was intended for medicinal use, was regularly carried on in the 18th century, and earlier. V. I. Ragozin states in his work on the petroleum industry that Johann Leche, who visited the Caspian district in 1735, found that the crude Caucasian oil required to be distilled to render it satisfactorily combustible, and that, when distilled, it yielded a bright yellow oil resembling a spirit, which readily ignited. As early as 1823 the brothers Dubinin erected a refinery in the village of Mosdok, and in 1846 applied to Prince Woronzoff for a subsidy for extending the use of petroleum-distillates in the Caucasus. In their application, which was unsuccessful, they stated that they had taught the Don Cossacks to "change black naphtha into white," and showed by a drawing, preserved in the archives of the Caucasian government, how this was achieved. They used an iron still, set in brickwork, and from a working charge of forty "buckets" of crude petroleum obtained a yield of sixteen buckets of "white naphtha." The top of the still had a removable head, connected with a condenser consisting of a copper worm in a barrel of water. The "white naphtha" was sold at Nijni Novgorod without further treatment.

Some of the more viscous crude oils obtained in the United States are employed as lubricants under the name of "natural oils," either without any treatment or after clarification by subsidence and filtration through animal charcoal. Others are deprived of a part of their more volatile constituents by spontaneous evaporation, or by distillation, *in vacuo* or otherwise, at the lowest possible temperature. Such are known as "reduced oils."

In most petroleum-producing countries, however, and particularly where the product is abundant, the crude oil is fractionally distilled, so as to separate it into petroleum spirit of various grades, burning oils, gas oils, lubricating oils, and (if the crude oil yields that product) paraffin. The distillates obtained are usually purified by treatment, successively, with sulphuric acid and solution of caustic soda, followed by washing with water.

Crude petroleum was experimentally distilled in the United States in 1833 by Prof. Silliman (d. 1864), and the refining of petroleum in that country may be said to date from about the year 1853, when Samuel M. Kier fitted up a small refinery with a five-barrel still, for the treatment of the oil obtained from his father's salt-wells. At this period the supply of the raw material was insufficient to admit of any important development in the industry, and before the drilling of artesian wells for petroleum was initiated by Drake the "coal-oil" or shale-oil industry had assumed considerable proportions in the United States. Two large refineries, one on Newtown Creek, Long Island, and another in South Brooklyn, also on Long Island, were in successful operation when the abundant production of petroleum, which immediately followed the completion of the Drake well, placed at the disposal of the refiner a material which could be worked more profitably than bituminous shale. The existing refineries were accordingly altered so as to adapt them for the refining of petroleum; but in the manufacture of burning oil from petroleum the small stills which had been in use in the distillation of shale-oil were at first employed.

In the earlier refineries the stills, the capacity of which varied from 25 to 80 barrels, usually consisted of a vertical cylinder, constructed of cast- or wrought-iron, with a boiler-plate bottom and a cast-iron dome, on which the "goose-neck" was bolted. The charge was distilled almost to dryness, though the operation was not carried far enough to cause the residue to "cok." The operation was, however, completely revolutionized in the United States by the introduction of the "cracking process," and by the division of the distillation into two parts, one consisting in the removal of the more volatile constituents of the oil, and the other in the distillation (which is usually conducted in separate stills) of the residues from the first distillation, for the production of lubricating oils and paraffin.

Various arrangements have been proposed and patented for the continuous distillation of petroleum, in which crude oil is supplied to a range of stills as fast as the distillates pass off. The system is largely employed in Russia, and its use has been frequently attempted in the United States, but the results have not been satisfactory, on account, it is said, of the much greater quantity of dissolved gas contained in the American oil, the larger proportion of kerosene which such oil yields, and the less fluid character of the residue.

In the United States a horizontal cylindrical still is usually employed in the distillation of the spirit and kerosene, but what is known as the "cheese-box" still has also been largely used. American stills of the former type are constructed of wrought-iron or steel, and are about 30 ft. in length by 12 ft. 6 in. in diameter, with a dome about 3 ft. in diameter, furnished with a vapour-pipe 25 in. in diameter. The charge for such a still is about 600 barrels. The stills were formerly completely bricked in, so that the vapours should be kept fully heated until they escaped to the condenser, but since the introduction of the "cracking process" the upper part has usually been left exposed to the air. The cheese-box still has a vertical cylindrical body, which may be as much as 30 ft. in diameter and 9 ft. in depth, connected by means of three vertical pipes with a vapour-chest furnished with a large number, frequently as many as forty, of 3-in. discharge-pipes arranged in parallel lines.

The stills employed in Russia and Galicia are usually smaller than those already described.

The "cracking" process, whereby a considerable quantity of the oil which is intermediate between kerosene and lubricating oil is converted into hydrocarbons of lower specific gravity and boiling-point suitable for illuminating purposes, is one of great scientific and technical interest. It is generally understood that the products of fractional distillation, even in the laboratory, are not identical with the hydrocarbons present in the crude oil, but are in part produced by the action of heat upon them. This was plainly stated by Professor Silliman in the earliest stages of development of the American petroleum industry. An important paper bearing on the subject was published in 1871, by T. E. Thorpe and J. Young, as a preliminary note on their experiments on the action of heat under pressure on solid paraffin. They found that the paraffin was thus converted, with the evolution of but little gas, into hydrocarbons which were liquid at ordinary temperatures.

In an experiment on 3500 grams of paraffin produced from shale (melting point 44.5° C.) they obtained nearly 4 litres of liquid hydrocarbons, which they subjected to fractional distillation, and on examining the fraction distilling below 100° C. they found it to consist mainly of olefines. The hydrocarbon C₁₀H₁₈, for example, might be resolved into C₄H₁₀+C₆H₈, or C₅H₁₂+C₅H₆, or C₂H₄+C₈H₁₄, &c., the general equation of the decomposition being—



The product actually obtained is a mixture of several paraffins and several olefines.

The cracking process practically consists in distilling the oil at a temperature higher than the normal boiling point of the constituents which it is desired to decompose. This may be brought about by a distillation under pressure, or by allowing the condensed distillate to fall into the highly heated residue in the still. The result of this treatment is that the comparatively heavy oils

undergo dissociation, as shown by the experiments of Thorpe and Young, into specifically lighter hydrocarbons of lower boiling points, and the yield of kerosene from ordinary crude petroleum may thus be greatly increased. A large number of arrangements for carrying out the cracking process have been proposed and patented, probably the earliest directly bearing on the subject being that of James Young, who in 1865 patented his "Improvements in treating hydrocarbon oils." In this patent, the distillation is described as being conducted in a vessel having a loaded valve or a partially closed stop-cock, through which the confined vapour escapes under any desired pressure. Under such conditions, distillation takes place at higher temperatures than the normal boiling-points of the constituent hydrocarbons of the oil, and a partial cracking results. The process patented by Dewar and Redwood in 1889 consists in the use of a suitable still and condenser in free communication with each other—*i.e.* without any valve between them—the space in the still and condenser not occupied by liquid being charged with air, carbon dioxide or other gas, under the required pressure, and the condenser being provided with a regulated outlet for condensed liquid. An objectionable feature of the system of allowing the vapour to escape from the still to the condenser through a loaded valve, *viz.*: the irregularity of the distillation, is thus removed, and the benefits of regular vaporization and condensation under high pressure are obtained. "In the American petroleum refineries it is found that sufficient cracking can be produced by slow distillation in stills of which the upper part is sufficiently cool to allow of the condensation of the vapours of the less volatile hydrocarbons, the condensed liquid thus falling back into the heated body of oil.

In the earlier stages of the development of the manufacture of mineral lubricating oils, the residues were distilled in cast-iron stills, and the lubricating properties of the products thus obtained were injured by overheating. The modern practice is to employ horizontal cylindrical wrought-iron or steel stills, and to introduce steam into the oil. The steam is superheated and may thus be heated to any desired temperature without increase of pressure, which would be liable to damage the still. The steam operates by carrying the vapours away to the condenser as fast as they are generated, the injury to the products resulting from their remaining in contact with the highly-heated surface of the still being thus prevented.

In order to separate the distillate into various fractions, and to remove as much of it as possible free from condensed steam, it is now usual to employ condensing appliances of special form with outlets for running off the different fractions.

The process of distillation of lubricating oils under reduced atmospheric pressure is now in very general use, especially for obtaining the heavier products. The vapours from the still pass through a condenser into a receiver, which is in communication with the exhauster.

The products obtained by the distillation of petroleum are not in a marketable condition, but require chemical treatment to remove acid and other bodies which impart a dark colour as well as an unpleasant odour to the liquid, and in the case of lamp-oils, reduce the power of rising in the wick by capillary attraction.

At the inception of the industry kerosene came into the market as a dark yellow or reddish-coloured liquid, and in the first instance, the removal of colour was attempted by treatment with soda lye and lime solution. It was, however, found that after the oil so purified had been burned in a lamp, for a short time, the wick became encrusted, and the oil failed to rise properly. Eichler, of Baku, is stated to have been the first to introduce, in Russia, the use of sulphuric acid, followed by that of soda lye, and his process is in universal use at the present time. The rationale of this treatment is not fully understood, but the action appears to consist in the separation or decomposition of the aromatic hydrocarbons, fatty and other acids, phenols, tarry bodies, &c., which lower the quality of the oil, the sulphuric acid removing some, while the caustic soda takes out the remainder, and neutralizes the acid which has been left in the oil. This treatment with acid and alkali is usually effected by agitation with compressed air. Oils which contain sulphur-compounds are subjected to a special process of refining in which cupric oxide or litharge is employed as a desulphurizing agent.

Testing.—A large number of physical and chemical tests are applied both to crude petroleum and to the products manufactured therefrom. The industry is conducted upon a basis of recognized standards of quality, and testing is necessary in the interests of both refiner and consumer, as well as compulsory in connexion with the various statutory and municipal regulations.

In the routine examination of crude petroleum it is customary to determine the *specific gravity*, and the amount of water and earthy matter in suspension; the oil is also frequently subjected to a process of fractional distillation in order to ascertain whether there has been any addition of distilled products or residue. Petroleum spirit is tested for specific gravity, range of boiling-points, and results of fractional distillation. To illuminating oil or kerosene a series of tests is applied in order that the colour, odour, specific gravity and *flash-point* or *fire-test* may be recorded. In the testing of mineral lubricating oils the *viscosity*, *flash-point*,

"*cold-test*," and specific gravity are the characters of chief importance. Fuel oil is submitted to certain of the foregoing tests and in addition the *calorimetric value* is determined. Paraffin wax is tested for *melting-point* (or setting-point), and the semi-refined product is further examined to ascertain the percentage of oil, water and dirt present.

In civilized countries provision is made by law for the testing of the *flash-point* or *fire-test* of lamp-oil (illuminating oil or kerosene), the method of testing and the minimum limit of *flash-point* or *fire-test* being prescribed (see below, *Legislation*).

The earliest form of testing instrument employed for this purpose was that of Giuseppe Tagliabue of New York, which consists of a glass cup placed in a copper water bath heated by a spirit lamp. The cup is filled with the oil to be tested, a thermometer placed in it and heat applied, the temperatures being noted at which, on passing a lighted splinter of wood over the surface of the oil, a flash occurs, and after further heating, the oil ignites. The first temperature is known as the *flash-point*, the second as the "*fire-test*." Such an apparatus, in which the oil-cup is uncovered, is known as an open-test instrument. In Saybolt's Electric Tester (1879) ignition is effected by a spark from an induction-coil passing between platinum points placed at a fixed distance above the oil.

Before long, however, it was found that the open-cup tests (though they are employed in the United States and elsewhere at the present time) were often very untrustworthy. Accordingly Keates proposed the substitution of a closed cup in 1871, but his suggestions were not adopted. In 1873 Sir Frederick Abel, at the request of the British Government, began to investigate the matter, and in August 1879 the "*Abel test*" was legalized. This apparatus has an oil-cup consisting of a cylindrical brass or gunmetal vessel, the cover of which is provided with three rectangular holes which may be closed and opened by means of a perforated slide moving in grooves; the movement of the slide causes a small oscillating colza- or rape-oil lamp to be tilted so that the flame (of specified size) is brought just below the surface of the lid. The oil-cup is supported in a bath or heating-vessel, consisting of two flat-bottomed copper cylinders, to contain water, heated by a spirit lamp, and provided with an air-space between the water-vessel and the oil-cup. Thermometers are placed in both oil-cup and water-bath, the temperature of the latter being raised to 130° at the commencement of the test, while the oil is put in at about 60° F. Testing is begun when the temperature reaches 66° by slowly drawing the slide open and reclosing it, the speed being regulated by the swing of a pendulum supplied with the instrument. It has been found that variations in barometric pressure affect the *flash-point* and accordingly corrections have to be made in obtaining strictly comparative results at different pressures. The *Abel-Pensky* instrument, used in India and in Germany, differs only in being provided with a clockwork arrangement for moving the slide. Numerous other forms of open-test and close-test instruments have from time to time been devised, some of which are in use in the United States and in other countries.

It is still customary to determine the open *flash-point* and *fire-test* of lubricating oils, but the close *flash-point* is also usually ascertained, a modification of the *Abel* or *Abel-Pensky* apparatus, known as the *Pensky-Martens*, having been devised for the purpose. This instrument is so constructed that the higher temperature needed can be readily applied, and it is fitted with a stirrer to equalize the heating of the contents of the oil-cup.

For the testing of the viscosity of lubricating oils the *Boverton* Redwood standardised viscometer is generally employed in Great Britain. By means of this instrument the time occupied in the flow of a measured quantity of the oil through a small orifice at a given temperature is measured.

Uses.—Petroleum has very long been known as a source of light and heat, while the use of crude oil for the treatment of wounds and cutaneous affections, and as a lubricant, was even more general and led to the raw material being an article of commerce at a still earlier date. For pharmaceutical purposes crude petroleum is no longer generally used by civilized races, though the product *vaseline* is largely employed in this way, and emulsions of petroleum have been administered internally in various pectoral complaints; while the volatile product termed *rhigolene* has been largely used as a local anaesthetic.

For illuminating purposes, the most extensively-used product is kerosene, but both the more and the less volatile portions of petroleum are employed in suitable lamps. Petroleum products are also largely utilized in gas manufacture for, (1) the production of "*air-gas*," (2) the manufacture of *oil-gas*, and (3) the enrichment of *coal-gas*. For heating purposes, the stoves employed are practically kerosene lamps of suitable construction, though gasoline is used as a domestic fuel in the United States. The use of petroleum as liquid fuel is dealt with under **FUEL**, as is the employment of its products in motors, which has greatly

increased the demand for petroleum spirit. Petroleum has largely superseded other oils, and is still gaining ground, as a lubricant for machinery and railway rolling-stock, either alone or in admixture with fixed oils. The more viscous descriptions of mineral oils have also been found suitable for use in the Elmore process of ore-concentration by oil.

Legislation.—Since the inception of the petroleum industry, most civilized countries have prescribed by law a test of flash-point or inflammability, designed in most cases primarily to afford a definition of oils for lighting purposes which may be safely stored without the adoption of special precautions. In the United Kingdom the limit has, for the purpose in question, been fixed by the legislature at 73° F., by the "Abel-test" which is the equivalent of the former standard of 100° F. by the "open-test." While the subject of the testing of petroleum for legislative purposes has been investigated in Great Britain by committees of both branches of the legislature, with a view to change in the law, the standard has never been raised, since such a course would tend to reduce the available supply and thus lead to increase in price or deterioration in quality. Moreover the chief object of the Petroleum Acts passed in the United Kingdom has hitherto been to regulate storage, and it has always been possible to obtain oils either of higher or lower flash-point, when such are preferred, irrespective of the legal standard, in addition to which it may be asserted that in a properly constructed lamp used with reasonable care the ordinary oil of commerce is a safe illuminant. The more recent legislation with regard to "petroleum spirit" relates mainly to the quantity which may be stored for use on "light locomotives."

The more important local authorities throughout the country have made regulations under the powers conferred upon them by the Petroleum Acts, with the object of regulating the "keeping, sale, conveyance and hawking" of petroleum products having a flash-point below 73° F., and the Port of London authority, together with other water-way and harbour authorities in the United Kingdom, have their own by-laws relating to the navigation of vessels carrying such petroleum.

In other countries the flash-point standards differ considerably, as do the storage regulations. In France, the standard is 35° C. (Grauer tester, equivalent to 95° F.), and according to their flash-point, liquid hydrocarbons are divided into two classes (below and above 35° C.), considered differently in regard to quantities storable and other regulations. In Germany, the law prescribes a close-test of 21° C., equal to about 70° F., whilst in Russia the standard is 28° C., equal to 84.4° F., by the close-test; in both these countries the weights of petroleum which may be stored in specified buildings are determined by law. In the United States, various methods of testing and various minimum standards have been adopted. In Pennsylvania, the prescribed limit is a "fire-test" of 110° F., equivalent to about 70° F., close-test, while in the State of New York it is 100° F., close-test.

See Sir Boverton Redwood's *Petroleum and its Products* (2nd ed., London, 1906); A. Beby Thompson, *Petroleum Mining* (1910); L. C. Tassart, *Exploitation du Pétrole* (1908); C. Engler and H. Höfer, *Das Erdöl*, 5 vols. (1909 seq.); A. B. Thompson, *The Oil Fields of Russia* (1908); and J. D. Henry, *Oil Fields of the Empire* (1910). (B. R.)

PETROLOGY, the science of rocks (Gr. *πέτρος*), the branch of geology which is concerned with the investigation of the composition, structure and history of the rock masses which make up the accessible portions of the earth's crust. Rocks have been defined as "aggregates of minerals." They are the units with which the geologist deals in investigating the structure of a district. Some varieties cover enormous areas and are among the commonest and most familiar objects of nature. Granite, sandstone, clay, limestone, slate often form whole provinces and build up lofty mountains. Such unconsolidated materials as sand, gravel, clay, soil are justly included among rocks as being mineral masses which play an important rôle in field geology. Other rock species are of rare occurrence and may be known in only one or two localities in distant parts of the earth's surface. Nearly all rocks consist of minerals, whether in a crystalline or non-crystalline state, but the insoluble and imperishable parts of the skeletons of animals and plants may constitute a considerable portion of rocks, as for example, coral limestone, lignite beds and chalk.

Treatment of the Subject.—In this paragraph the subject matter of the science of petrology is briefly surveyed; the object is to point out the headings under which particular subjects are treated (there is a separate article on the terms printed in italics). General questions as to the nature, origin and classification of rocks and the methods of examination are discussed in the present article. *mineralogy* comprises similar matter respecting the component minerals; *metamorphism*, *metasomatism*, *pneumatolysis* and the

formation of *concretions* are agencies which affect rocks and modify them. Three classes of rocks are recognized: the igneous, sedimentary and metamorphic. The plutonic, or deep-seated rocks, which cooled far below the surface, and occur as *batholiths*, *bosses*, *laccolites*, and *veins*, include the great classes *granite*, *syenite*, *diorite*, *gabbro* and *peridotite*; related to the granites are *apatite*, *greisen*, *pegmatite*, *schorl* rock and *micropegmatite*; to the syenites, *borolanite*, *monzonite*, *nepheline-syenite* and *tsjolite*; to the diorites, *aphanite*, *napolamite* and *lonalite*; to the gabbros, *pyroxenite* and *hercynite*, and to peridotites, *pierite* and *serpentinite*. The hypabyssal intrusive rocks, occurring as *sills*, *veins*, *dykes*, *necks*, &c., are represented by *porphyry* and *porphyry* (including *basaltite*, *felsite* and *quartz-porphry*), *diabase* and *lamprophyre*; some *pitchstones* belong to this group and contain *crystallites* and *spherulites*. The volcanic rocks, found typically as *lava flows*, include *rhyolite* and *obsidians* (with sometimes *perline*), *trachyte* and *phonolite* (and *leucitophyre* which is treated under *basalt*), *andesite* and *dacite*, *basalt* (with the related *dolerite*, *variolite* and *tachylyte*), *nephelinite* and *lephrite*. Among sedimentary rocks we recognize a volcanic group (including *tuff*, *agglomerate* and some kinds of *pumice*); an arenaceous series such as *sand* (some with *glauconite*), *sandstone*, *gneissite*, *greywacke* and *gravel*; an argillaceous group including *clay*, *firebrick*, *phyllite*, *laterite*, *shale* and *slate*; a calcareous series with *chalk*, *limestone* (often forming *stalactites* and *stalagmites*), *dolomite* and *marls* or argillaceous limestone (*flint* occurs as nodules in chalk); the natural *phosphates* may be mentioned here. The metamorphic rocks are commonly *gneisses* and *schists* (including *mica-schist*); other types are *amphibolite*, *charnockite*, *eclogite*, *epidiorite*, *epidosite*, *granulite*, *ilacolumite*, *hornfels*, *mylonite* and the *scapolite* rocks.

Composition.—Only the commonest minerals are of importance as rock formers. Their number is small, not exceeding a hundred in all, and much less than this if we do not reckon the subdivisions into which the commoner species are broken up. The vast majority of the rocks which we see around us every day consist of quartz, feldspar, mica, chlorite, kaolin, calcite, epidote, olivine, augite, hornblende, magnetite, haematite, limonite and a few other minerals. Each of these has a recognized position in the economy of nature. A main determining factor is the chemical composition of the mass, for a certain mineral can be formed only when the necessary elements are present in the rock. Calcite is commonest in limestones, as these consist essentially of carbonate of lime; quartz in sandstones and in certain igneous rocks which contain a high percentage of silica. Other factors are of equal importance in determining the natural association or paragenesis of rock-making minerals, principally the mode of origin of the rock and the stages through which it has passed in attaining its present condition. Two rock masses may have very much the same bulk composition and yet consist of entirely different assemblages of minerals. The tendency is always for those compounds to be formed which are stable under the conditions under which the rock mass originated. A granite arises by the consolidation of a molten magma (a fused rock mass; Gr. *μάγμα*, from *μάσσω*, to knead) at high temperatures and great pressures and its component minerals are such as are formed in such circumstances. Exposed to moisture, carbonic acid and other subaerial agents at the ordinary temperatures of the earth's surface, some of these original minerals, such as quartz and white mica are permanent and remain unaffected; others "weather" or decay and are replaced by new combinations. The feldspar passes into kaolin, muscovite and quartz, and if any black mica (biotite) has been present it yields chlorite, epidote, rutile and other substances. These changes are accompanied by disintegration, and the rock falls into a loose, incoherent, earthy mass which may be regarded as a sand or soil. The materials thus formed may be washed away and deposited as a sandstone or grit. The structure of the original rock is now replaced by a new one; the mineralogical constitution is profoundly altered; but the bulk chemical composition may not be very different. The sedimentary rock may again undergo a metamorphosis. If penetrated by igneous rocks it may be recrystallized or, if subjected to enormous pressures with heat and movement, such as attend the building of folded mountain chains, it may be converted into a gneiss not very different in mineralogical composition though radically different in structure to the granite which was its original state.

Structure.—The two factors above enumerated, namely the chemical and mineral composition of rocks, are scarcely of greater

importance than their structure, or the relations of the parts of which they consist to one another. Regarded from this standpoint rocks may be divided into the crystalline and the fragmental. Inorganic matter, if free to take that physical

state in which it is most stable, always tends to crystallize. Crystalline rock masses have consolidated from solution or from fusion. The vast majority of igneous rocks belong to this group and the degree of perfection in which they have attained the crystalline state depends primarily on the conditions under which they solidified. Such rocks as granite, which have cooled very slowly and under great pressures, have completely crystallized, but many lavas were poured out at the surface and cooled very rapidly; in this latter group a small amount of non-crystalline or glassy matter is frequent. Other crystalline rocks such as rock-salt, gypsum and anhydrite have been deposited from solution in water, mostly owing to evaporation on exposure to the air. Still another group, which includes the marbles, mica-schists and quartzites, are recrystallized, that is to say, they were at first fragmental rocks, like limestone, clay and sandstone and have never been in a molten condition nor entirely in solution. Certain agencies however, acting on them, have effaced their primitive structures, and induced crystallization. This is a kind of metamorphism.

The fragmental structure needs little explanation; wherever rocks disintegrate fragments are produced which are suitable for the formation of new rocks of this group. The original materials may be organic (shells, corals, plants) or vitreous (volcanic glasses) or crystalline (granite, marble, &c.); the pulverizing agent may be frost, rain, running water, or the steam explosions which shatter the lava within a volcanic crater and produce the fragmental rocks known as volcanic ash, tuffs and agglomerates. The materials may be loose and incoherent (sand, clay, gravel) or compacted by pressure and the deposit of cementing substances by percolating water (sandstone, shale, conglomerate). The grains of which fragmental rocks are composed may be coarse or fine, fresh or decayed, uniform, or diverse in their composition; the one feature which gives unity to the class is the fact that they are all derived from pre-existing rocks or organisms. Because they are made up of broken pieces these rocks are often said to be "clastic."

Fragmental Rocks. *Origin of Rocks.*—The study of the structure of rocks evidently leads us to another method of regarding them, which is more fundamental than those enumerated above, as the structure depends on the mode of origin. Rocks are divided into three great classes, the Igneous, the Sedimentary and the Metamorphic. The igneous (Lat. *ignis*, fire) rocks have all consolidated from a state of fusion. Some of them are crystalline or "massive"; others are fragmental. The massive igneous rocks include a few which are nearly completely vitreous, and still more which contain a small amount of amorphous matter, but the majority are completely crystallized. Among the best known examples are obsidian, pumice, basalt, trachyte, granite, diorite. The fragmental igneous rocks consist of volcanic ashes more or less firmly compacted.

Igneous Rocks. The sedimentary rocks form a second group; they have all been laid down as deposits on the earth's surface subject to the conditions of temperature, moisture and pressure which obtain there. They include fragmental and crystalline varieties. The former consist of the debris of pre-existing rocks, accumulated in seas, lakes or dry land and more or less indurated by pressure and cementing substances. Gravel, sand and clay, conglomerate, sandstone, shale are well-known examples. Many of them are fossiliferous as they contain fragments of organisms. Some are very largely made up of remains of animals or plants, more or less altered by mineralization. These are sometimes placed into a special group as rocks of organic origin, limestone, peat and coal are typical of this class. The crystalline sediments are such as rock-salt and gypsum, deposits of saline lakes or isolated portions of the sea. They were formed under conditions

unfavourable to life and hence rarely contain fossils. The metamorphic rocks are known to be almost entirely altered igneous or sedimentary masses. Metamorphism consists in the destruction of the original structures and the development of new minerals. The chemical composition of the rocks however suffers little change. The rock becomes as a rule more crystalline; but all stages in the process may be found and in a metamorphosed sediment, e.g. a sandstone, remains of the original sand grains and primary fragmental structure may be observed, although extensive recrystallization has taken place. The agencies which produce metamorphism are high temperatures, pressure, interstitial moisture and in many cases movement. The effects of high temperatures are seen best in the rocks surrounding great outcrops of intrusive granite, for they have been baked and crystallized by the heat of the igneous rock (thermo-metamorphism). In folded mountain chains where the strata have been greatly compressed and their particles have been forced to move over one another a different type of metamorphism prevails (regional or dynamic metamorphism).

Methods of Investigation.—The macroscopic (Gr. *μακρος*, large) characters of rocks, those visible in hand-specimens without the aid of the microscope, are very varied and difficult to describe accurately and fully. The geologist in the field depends principally on them and on a few rough chemical and physical tests; and to the practical engineer, architect and quarry-master they are all-important. Although frequently insufficient in themselves to determine the true nature of a rock, they usually serve for a preliminary classification and often give all the information which is really needed. With a small bottle of acid to test for carbonate of lime, a knife to ascertain the hardness of rocks and minerals, and a pocket lens to magnify their structure, the field geologist is rarely at a loss to what group a rock belongs. The fine grained species are often indeterminate in this way, and the minute mineral components of all rocks can usually be ascertained only by microscopic examination. But it is easy to see that a sandstone or grit consists of more or less rounded, waterworn sand-grains and if it contains dull, weathered particles of felspar, shining scales of mica or small crystals of calcite these also rarely escape observation. Shales and clay rocks generally are soft, fine grained, often laminated and not infrequently contain minute organisms or fragments of plants. Limestones are easily marked with a knife-blade, effervesce readily with weak cold acid and often contain entire or broken shells or other fossils. The crystalline nature of a granite or basalt is obvious at a glance, and while the former contains white or pink felspar, clear vitreous quartz and glancing flakes of mica, the other will show yellow-green olivine, black augite and grey striated plagioclase.

But when dealing with unfamiliar types or with rocks so fine grained that their component minerals cannot be determined with the aid of a lens, the geologist is obliged to have recourse to more delicate and searching methods of investigation. With the aid of the blowpipe (to test the fusibility of detached crystals), the goniometer, the magnet, the magnifying glass and the specific gravity balance, the earlier travellers attained surprisingly accurate results. Examples of these may be found in the works of von Buch, Scrope, Darwin and many others. About the end of the 18th century, Dolomieu examined crushed rock powders under the microscope and Cordier in 1815 crushed, levigated and investigated the finer ground-mass of igneous rocks. His researches are models of scrupulous accuracy, and he was able to announce that they consisted essentially of such minerals as felspar, augite, iron ores and volcanic glass, and did not differ in nature from the coarser grained rocks. Nicol, whose name is associated with the discovery of the Nicol's prism, seems to have been the first to prepare thin slices of mineral substances, and his methods were applied by Witham (1831) to the study of plant petrifications. This method, of such far-reaching importance in petrology, was not at once made use of for the systematic

Metamorphic Rocks. *Macroscopic Characters.*

Microscopic Characters.

Microscopic Characters.

Microscopic Characters.

investigation of rocks, and it was not till 1858 that Sorby pointed out its value. Meanwhile the optical study of sections of crystals had been advanced by Sir David Brewster and other physicists and mineralogists and it only remained to apply their methods to the minerals visible in rock sections. Very rapid progress was made and the names of Zirkel, Allport, Vogelsang, Schuster, Rosenbusch, Bertrand, Fouqué and Lévy are among those of the most active pioneers in the new field of research. To such importance have microscopical methods attained that textbooks of petrology at the present time are very largely devoted to a description of the appearances presented by the minerals of rocks as studied in transparent micro-sections.

A good rock-section should be about one-thousandth of an inch in thickness, and is by no means very difficult to make. A thin section, a splinter of the rock, about as large as a halpenny may be taken; it should be as fresh as possible and free from obvious cracks. By grinding on a plate of planed steel or cast iron with a little fine carborundum it is soon rendered flat on one side and is then transferred to a sheet of plate glass and smoothed with the very finest emery till all minute pits and roughnesses are removed and the surface is a uniform plane. The rock-chip is then washed, and placed on a copper or iron plate which is heated by a spirit or gas lamp. A microscopic glass slip is also warmed on this plate with a drop of viscous natural Canada balsam on its surface. The more volatile ingredients of the balsam are dispelled by the heat, and when that is accomplished the smooth, dry, warm rock is pressed firmly into contact with the glass plate so that the film of balsam intervening may be as thin as possible and free from air-bubbles. The preparation is allowed to cool and then the rock chip is again ground down as before, first with carborundum and, when it becomes transparent, with fine emery till the desired thickness is obtained. It is then cleaned, again heated with a little more balsam, and covered with a cover glass. The labour of grinding the first surface may be avoided by cutting off a smooth slice with an iron disk armed with crushed diamond powder. A second application of the slitter after the first face is smoothed and cemented to the glass will in expert hands leave a rock-section so thin as to be already transparent. In this way the preparation of a section may require only twenty minutes.

The microscope employed is usually one which is provided with a rotating stage beneath which there is a polarizer, while above the objective or the eyepiece an analyser is mounted; alternatively the stage may be fixed and the polarizing and analysing prisms may be capable of simultaneous rotation by means of toothed wheels and a connecting-rod. If ordinary light and not polarized light is desired, both prisms may be withdrawn from the axis of the instrument; if the polarizer only is inserted the light transmitted is plane polarized; with both prisms in position the slide is viewed between "crossed nicols." A microscopic rock-section in ordinary light if a suitable magnification (say 30) be employed is seen to consist of grains or crystals varying in colour, size and shape. Some minerals are colourless and transparent (quartz, calcite, feldspar, muscovite, &c.), others are yellow or brown (rutile, tourmaline, biotite), green (diopside, hornblende, chlorite), blue (glaucochane), pink (garnet), &c. The same mineral may present a variety of colours, in the same or different rocks, and these colours may be arranged in zones parallel to the surfaces of the crystals. Thus tourmaline may be brown, yellow, pink, blue, green, violet, grey or colourless, but every mineral has one or more characteristic, because most common tints. The shapes of the crystals determine in a general way the outlines of the sections of them presented on the slides. If the mineral has one or more good cleavages they will be indicated by systems of cracks (see Pl. III.). The refractive index is also clearly shown by the appearance of the sections, which are rough, with well-defined borders if they have a much stronger refraction than the medium in which they are mounted. Some minerals decompose readily and become turbid and semi-transparent (e.g. feldspar); others remain always perfectly fresh and clear (e.g. quartz), others yield characteristic secondary products (such as green chlorite after biotite). The inclusions in the crystals are of great interest; one mineral may enclose another, or may contain spaces occupied by glass, by fluids or by gases.

Lastly the structure of the rock, that is to say, the relation of its components to one another, is usually clearly indicated, whether it be fragmental or massive; the presence of glassy matter in contradistinction to a completely crystalline or "holo-crystalline" condition; the nature and origin of organic fragments; banding, foliation or lamination; the pumiceous or porous structure of many lavas; these and many other characters, though often not visible in the hand specimens of a rock, are rendered obvious by the examination of a microscopic section. Many refined methods of observation may be introduced, such as the measurement of the size of the elements of the rock by the help of micrometers; their relative proportions by means of a glass plate ruled in small squares; the angles between cleavages or faces seen in section by the use of the rotating graduated stage, and the estimation of the

refractive index of the mineral by comparison with those of different mounting media.

Further information is obtained by inserting the polarizer and rotating the section. The light vibrates now only in one plane, and in passing through doubly refracting crystals in the slide is, speaking generally, broken up into two rays, ^{Pleochroism.} which vibrate at right angles to one another. In many coloured minerals such as biotite, hornblende, tourmaline, chlorite, these two rays have different colours, and when a section containing any of these minerals is rotated the change of colour is often very striking. This property, known as "pleochroism" (Gr. ^{Yellow, more; xplōs, colour,} is of great value in the determination of rock-making minerals. It is often especially intense in small spots which surround minute enclosures of other minerals, such as zircon and epidote; these are known as "pleochroic halos."

If the analyser be now inserted in such a position that it is crossed relatively to the polarizer the field of view will be dark where there are no minerals, or where the light passes through isotropic substances such as glass, liquids and cubic crystals. ^{Double Refraction.} All other crystalline bodies, being doubly refracting, will appear bright in some position as the stage is rotated. The only exception to this rule is provided by sections which are perpendicular to the optic axes of birefringent crystals; these remain dark or nearly dark during a whole rotation and as will be seen later, their investigation is of special importance. The doubly refracting mineral sections, however, will in all cases appear black in certain positions as the stage is ^{Extinction.} rotated. They are said to be "extinguished" when this takes place. If we note these positions we may measure the angle between them and any cleavages, faces or other structures of the crystal by means of the rotating stage. These angles are characteristic of the system to which the mineral belongs and often of the mineral species itself (see CRYSTALLOGRAPHY). To facilitate measurement of extinction angles various kinds of eyepieces have been devised, some having a stauroscopic calcite plate, others with two or four plates of quartz cemented together; these are often found to give more exact results than are obtained by observing merely the position in which the mineral section is most completely dark between crossed nicols.

The mineral sections when not extinguished are not only bright but are coloured and the colours they show depend on several factors, the most important of which is the strength of the double refraction. If all the sections are of the same thickness as is nearly true of well-made slides, the minerals with strongest double refraction yield the highest polarization colours. The order in which the colours are arranged is that known as Newton's scale, the lowest being dark grey, then grey, white, yellow, orange, red, purple, blue and so on. The difference between the refractive indexes of the ordinary and the extraordinary ray in quartz is .009, and in a rock-section about $\frac{1}{15}$ of an inch thick this mineral gives grey and white polarization tints; nepheline with weaker double refraction gives dark grey; augite on the other hand will give red and blue, while calcite with still stronger double refraction will appear pinkish or greenish white. All sections of the same mineral, however, will not have the same colour; it was stated above that sections perpendicular to an optic axis will be nearly black, and, in general, the more nearly any section approaches this direction the lower its polarization colours will be. By taking the average, or the highest colour given by any mineral, the relative value of its double refraction can be estimated; or if the thickness of the section be precisely known the difference between the two refractive indexes can be ascertained. If the slides be thick the colours will be on the whole higher than in thin slides.

It is often important to find out whether of the two axes of elasticity (or vibration traces) in the section is that of greater elasticity (or lesser refractive index). The quartz wedge or selenite plate enables us to do this. Suppose a doubly refracting mineral section so placed that it is "extinguished"; if now it is rotated through 45° it will be brightly illuminated. If the quartz wedge be passed across it so that the long axis of the wedge is parallel to the axis of elasticity in the section the polarization colours will rise or fall. If they rise the axes of greater elasticity in the two minerals are parallel; if they sink the axis of greater elasticity in the one is parallel to that of lesser elasticity in the other. In the latter case by pushing the wedge sufficiently far complete darkness or compensation will result. Selenite wedges, selenite plates, mica wedges and mica plates are also used for this purpose. A quartz wedge also may be calibrated by determining the amount of double refraction in all parts of its length. If now it be used to produce compensation or complete extinction in any doubly refracting mineral section, we can ascertain what is the strength of the double refraction of the section because it is obviously equal and opposite to that of a known part of the quartz wedge.

A further refinement of microscopic methods consists of the use of strongly convergent polarized light (konoscopic methods). This is obtained by a wide angled achromatic condenser above the polarizer, and a high power microscopic objective. Those sections are most useful which are perpendicular to an optic axis, and consequently remain dark on rotation. If they belong to uniaxial crystals they show a dark cross or convergent light between crossed nicols,

Characters of Minerals.

Micro-Structure.

the bars of which remain parallel to the wires in the field of the eye-piece. Sections perpendicular to an optic axis of a biaxial mineral under the same conditions show a dark bar which on rotation becomes curved to a hyperbolic shape. If the section is perpendicular to a "bisectrix" (see CRYSTALLOGRAPHY) a black cross is seen which on rotation opens out to form two hyperbolas, the apices of which are turned towards one another. The optic axes emerge at the apices of the hyperbolas and may be surrounded by coloured rings, though owing to the thinness of minerals in rock sections these are only seen when the double refraction of the mineral is strong. The distance between the axes as seen in the field of the microscope depends partly on the axial angle of the crystal and partly on the numerical aperture of the objective. If it is measured by means of an eye-piece micrometer, the optic axial angle of the mineral can be found by a simple calculation. The quartz wedge, quarter mica plate or selenite plate permit the determination of the positive or negative character of the crystal by the changes in the colour or shape of the figures observed in the field. These operations are precisely similar to those employed by the mineralogist in the examination of plates cut from crystals. It is sufficient to point out that the petrological microscope in its modern development is an optical instrument of great precision, enabling us to determine physical constants of crystallized substances as well as serving to produce magnified images like the ordinary microscope. A great variety of accessory apparatus has been devised to fit it for these special uses.

The separation of the ingredients of a crushed rock powder from one to another in order to obtain pure samples suitable for analysis is also extensively practised. It may be effected by means of a powerful electro-magnet the strength of which can be regulated as desired. A weak magnetic field will attract magnetite, then haematite and other ores of iron. Silicates containing iron will follow in definite order and biotite, enstatite, augite, hornblende, garnet and similar ferro-magnesian minerals may be successively abstracted, at last only the colourless, non-magnetic compounds, such as muscovite, calcite, quartz and feldspar, will remain. Chemical methods also are useful. A weak acid will dissolve calcite from a crushed limestone, leaving only dolomite, silicates or quartz. Hydrofluoric acid will attack feldspar before quartz, and if employed with great caution will dissolve these and any glassy material in a rock powder before dissolving augite or hypersthene. Methods of separation by specific gravity have a still wider application. The simplest of these is levigation (Lat. *levigare*, to make smooth, *levis*) or treatment by a current of water, it is extensively employed in the mechanical analysis of soils and in the treatment of ores, but is not so successful with rocks, as their components do not as a rule differ very greatly in specific gravity.

Fluids are used which do not attack the majority of the rock-making minerals and at the same time have a high specific gravity. Solutions of potassium mercuric iodide (sp. gr. 3.196), cadmium borotungstate (sp. gr. 3.30), methylene iodide (sp. gr. 3.32), bromoform (sp. gr. 2.86), or acetylene bromide (sp. gr. 3.00) are the principal media employed. They may be diluted (with water, benzene, &c.) to any desired extent and again concentrated by evaporation. If the rock be a granite consisting of biotite (sp. gr. 3.1), muscovite (sp. gr. 2.85), quartz (sp. gr. 2.65), oligoclase (sp. gr. 2.61) and orthoclase (sp. gr. 2.56) the crushed minerals will all float in methylene iodide; on gradual dilution with benzene they will be precipitated in the order given above. Although simple in theory these methods are tedious in practice, especially as it is common for one rock-making mineral to enclose another. But expert handling of fresh and suitable rocks yields excellent results and much purer powders may be obtained by this means than by any other.

Although rocks are now studied principally in microscopic sections the investigation of fine crushed rock powders, which **Examination** was the first branch of microscopic petrology to receive attention, is by no means discontinued. **Powders.** The modern optical methods are perfectly applicable to transparent mineral fragments of any kind. Minerals are almost as easily determined in powder as in section, but it is otherwise with rocks, as the structure or relation of the components to one another, which is an element of great importance in the study of the history and classification of rocks, is almost completely destroyed by grinding them to powder.

In addition to naked-eye and microscopic investigations chemical methods of research are of the greatest practical utility to the petrographer. The crushed and separated powders, obtained by the processes described above, may be

analysed and thus the chemical composition of the minerals in the rock determined qualitatively or quantitatively. The chemical testing of microscopic sections and minute grains by the help of the microscope is a very elegant and valuable means of discriminating between the mineral components of fine-grained rocks. Thus the presence of apatite in rock-sections is established by covering a bare rock-section with solution of ammonium molybdate; a turbid yellow precipitate forms over the crystals of the mineral in question (indicating the presence of phosphates). Many silicates are insoluble in acids and cannot be tested in this way, but others are partly dissolved, leaving a film of gelatinous silica which can be stained with colouring matters such as the aniline dyes (nepheline, analcite, zeolites, &c.).

Complete chemical analyses of rocks are also widely made use of and are of the first importance, especially when new species are under description. Rock analysis has of late years (largely under the influence of the chemical laboratory of the United States Geological Survey) reached a high pitch of refinement and complexity. As many as twenty or twenty-five components may be determined, but for practical purposes a knowledge of the relative proportions of silica, alumina, ferrous and ferric oxides, magnesia, lime, potash, soda and water will carry us a long way in determining the position to which a rock is to be assigned in any of the conventional classifications. A chemical analysis is in itself usually sufficient to indicate whether a rock is igneous or sedimentary and in either case to show with considerable accuracy to what subdivision of these classes it belongs. In the case of metamorphic rocks it often establishes whether the original mass was a sediment or of volcanic origin. The specific gravity of rocks is determined in the usual way by means of the balance and the pycnometer. It is greatest in those rocks which contain most magnesia, iron and heavy metals, least in rocks rich in alkalis, silica and water. It diminishes with weathering, and generally those rocks which are highly crystalline have higher specific gravities than those which are wholly or partly vitreous when both have the same chemical composition. The specific gravity of the commoner rocks ranges from about 2.5 to 3.2.

The above methods of investigation, naked eye, physical, microscopical, chemical, may be grouped together as analytical in contradistinction to the synthetic investigation of rocks, which proceeds by experimental work to reproduce different rock types and in this way to elucidate their origin and explain their structures. In many cases no experiment is necessary. Every stage in the origin of clays, sands and gravels can be seen in process around us, but where these have been converted into coherent slates, sandstones and conglomerates, and still more where they have experienced some degree of metamorphism, there are many obscure points about their history upon which experiment may yet throw light. Up to the present time these investigations have been almost entirely confined to the attempt to reproduce igneous rocks by fusion of mixtures of crushed minerals or of chemicals in specially contrived furnaces. The earliest researches of this sort are of those of Faujas St Fond and of de Saussure, but Sir James Hall really laid the foundations of this branch of petrology. He showed (1798) that the whinstones (diabases) of Edinburgh were fusible and if rapidly cooled yielded black vitreous masses closely resembling natural pitchstones and obsidians; if cooled more slowly they consolidated as crystalline rocks not unlike the whinstones themselves and containing olivine, augite and feldspar (the essential minerals of these rocks). Many years later Daubrée, Delesse and others carried on similar experiments, but the first notable advance was made in 1878, when Fouqué and Lévy began their researches.

They succeeded in producing such rocks as porphyrite, leucite-tephrite, basalt and dolerite, and obtained also various structural modifications well known in igneous rocks, e.g. the porphyritic and the ophiitic (Gr. *ophis*, serpent). Incidentally they showed that while many basic rocks (basalts, &c.) could be perfectly imitated in the laboratory, the acid rocks could not, and advanced the explanation that for the crystallization of the latter the gases never absent in natural rock magmas were indispensable mineralizing agents. It has subsequently been proved that steam, or such volatile substances as certain borates, molybdates, chlorides, fluorides, assist in the formation of orthoclase, quartz and mica (the minerals of granite). Sir James Hall also made the first contribution to the experimental study of metamorphic rocks by converting chalk

into marble by heating it in a closed gun-barrel, which prevented the escape of the carbonic acid at high temperatures. Adams and Nicholson have carried this a stage farther by subjecting marble to great pressure in hydraulic presses and have shown how the foliated structures, frequent in natural marbles, may be produced artificially.

Rock Classification.—The three great classes of rocks above enumerated—the igneous, the sedimentary and the metamorphic—are subdivided into many groups which to a small extent resemble the genera and species under which the naturalist classifies the members of the animal kingdom. There are, however, no hard and fast boundaries between allied rocks. By increase or diminution in the proportions of their constituent minerals they pass by every gradation into one another; the distinctive structures also of one kind of rock may often be traced gradually merging into those of another. Hence the definitions adopted in establishing rock nomenclature merely correspond to selected points (more or less arbitrary) in a continuously graduated series. This is frequently urged as a reason for reducing rock classification to its simplest possible terms, and using only a few generalized rock designations. But it is clear that many apparently trivial differences tend regularly to recur, and have a real significance, and so long as any variation can be shown to be of this nature it deserves recognition.

The *igneous rocks* (crystalline and fragmental) form a well-defined group, differing in origin from all others. The crystalline or massive

Igneous Rocks. varieties may occur in two different ways; the lavas have been poured out at the surface and have consolidated after ejection, under conditions which are fairly well understood, seeing that they may be examined at active volcanoes in many parts of the world; the intrusive rocks, on the other hand, have been injected from below into cracks and fissures in the strata and have cooled there beneath masses which conceal them from view till exposed by denudation at a subsequent period. The members of these two groups differ in many respects from one another, so that it is often possible to assign a rock to one or other of them on mere superficial inspection. The lavas (or effusive rocks), having cooled rapidly in contact with the air, are mostly finely crystalline or have at least fine-grained ground-mass representing that part of the viscous semi-crystalline lava flow which was still liquid at the moment of eruption. At this

Lavas or Effusive Types. time they were exposed only to atmospheric pressure, and the steam and other gases, which they contained in great quantity, were free to escape; many important modifications arise from this, the most striking being the frequent presence of numerous steam cavities (vesicular structure) often drawn out to elongated shapes subsequently filled up with minerals by infiltration (amygdaloidal structure). As crystallization was going on while the mass was still creeping forward over the surface of the earth, the latest formed minerals (in the ground-mass) are commonly arranged in subparallel winding lines following the direction of movement (fluxion or fluidal structure) (see Pl. I. figs. 2 and 9, Pl. II. fig. 2), and the larger early minerals which had previously crystallized may show the same arrangement. Most lavas have fallen considerably below their original temperatures before they are emitted. In their behaviour they present a close analogy to hot solutions of salts in water, which, when they approach the saturation temperature, first deposit a crop of large, well-formed crystals (labile stage) and subsequently precipitate clouds of smaller less perfect crystalline particles (metastable stage). In igneous rocks the first generation of crystals generally forms before the lava has emerged to the surface, that is to say, during the ascent from the subterranean depths to the crater of the volcano. It has frequently been verified by observation that freshly emitted lavas contain large crystals borne along in a molten, liquid mass. The large, well-formed, early crystals are said to be porphyritic (Pl. III. figs. 1, 2, 3); the smaller crystals of the surrounding matrix or ground-mass belong to the post-effusion stage. More rarely lavas are completely fused at the moment of ejection; they may then cool to form a non-porphyrific, finely crystalline rock, or if more rapidly chilled may in large part be non-crystalline or glassy (vitreous rocks such as obsidian, tachylite, pitchstone (Pl. I. figs. 1, 4, 5). A common feature of glassy rocks is the presence of rounded bodies (spherulites: Gr. σφαιρα, ball), consisting of fine divergent fibres radiating from a centre (Pl. I. figs. 7, 8); they consist of imperfect crystals of felspar, mixed with quartz or tridymite; similar bodies are often produced artificially in glasses which are allowed to cool slowly. Rarely these spherulites are hollow or consist of concentric shells with spaces between (lithophysae: Gr. λίθος, stone; γόλις, bellows). Perlitic structure, also common in glasses, consists in the presence of concentric rounded cracks owing to contraction on cooling (see PERLITE).

The phenocrysts (Gr. φαινός, to show; κρυσταλλος, crystal) or porphyritic minerals are not only larger than those of the ground-mass. As the matrix was still liquid when they formed they were free to take perfect crystalline shapes, not being interfered with by

the pressure of adjacent crystals. They seem to have grown rapidly, as they are often filled with enclosures of glassy or finely crystalline material like that of the ground-mass (Pl. II. fig. 1). Microscopic examination of the phenocrysts often reveals that they have had a complex history. Very frequently they show successive layers of different composition, indicated by variations in colour or other optical properties; thus augite may be green at the centre and various shades of brown outside this; or may be pale green centrally and darker green with strong pleochroism (aegirine) at the periphery. In the felspars the centre is usually more basic and richer in lime than the surrounding faces, and successive zones may often be noted, each less basic than those which lie within it. Phenocrysts of quartz (and of other minerals), instead of sharp, perfect crystalline faces, may show rounded corroded surfaces (Pl. I. fig. 9), with the points blunted and irregular tongue-like projections of the matrix into the substance of the crystal. It is clear that after the mineral had crystallized it was partly again dissolved or corroded at some period before the matrix solidified. Corroded phenocrysts of biotite and hornblende are very common in some lavas; they are surrounded by black rims of magnetite mixed with pale green augite. The hornblende or biotite substance has proved unstable at a certain stage of consolidation and has been replaced by a paramorph of augite and magnetite which may be partially or completely substituted for the original crystal but still retains its characteristic outlines.

Let us now consider the characteristics of a typical deep-seated rock like granite or diorite (Pl. II. figs. 4, 5, 9). That these are igneous is proved by the manner in which they have burst through the superincumbent strata, filling the cracks with ramifying veins; that they were at a very high temperature is equally clear from the changes which they have induced in the rocks in contact with them. But as their heat could dissipate only very slowly, because of the masses which covered them, complete crystallization has taken place and no vitreous rapidly chilled matter is present. As they have had time to come to rest before crystallizing they are not fluidal. Their contained gases have not been able to escape through the thick layer of strata beneath which they were injected, and may often be observed occupying cavities in the minerals, or have occasioned many important modifications in the crystallization of the rock. Because their crystals are of approximately equal size these rocks are said to be granular; there is typically no distinction between a first generation of large well-shaped crystals and a fine-grained ground-mass. Their minerals have formed, however, in a definite order, and each has had a period of crystallization which may be very distinct or may have coincided with or overlapped the period of formation of some of the other ingredients. The earlier have originated at a time when most of the rock was still liquid and are more or less perfect; the later are less regular in shape because they were compelled to occupy the interspaces left between the already formed crystals (Pl. II. figs. 5, 9). The former are said to be idiomorphic (or automorphic), the latter are said to be anidiomorphic (allotriomorphic, xenomorphic). There are also many other characteristics which serve to distinguish the members of these two groups. Orthoclase, for example, is the typical felspar of granite, while its modification sanidine occurs in lavas of similar composition. The same distinction holds between elaeolite and nepheline. Leucite is common in lavas, very rare in plutonic rocks. Muscovite is confined to the intrusives. These differences show the influence of the physical conditions under which consolidation takes place.

There is a certain class of intrusive rocks which have risen upwards towards the surface, but have failed to reach it, and have solidified in fissures as dikes and intrusive sills at no great depth. To this type the name *intrusive* (or *hyp-* *intrusive* or *abyssal*) is often given in distinction to the *plutonic* (or *hyp-* *plutonic*) which formed at greater depths. As might be expected, they show structures intermediate between those of the effusive and the plutonic rocks. They are very commonly porphyritic, not rarely vitreous, and sometimes even vesicular. In fact many of them are indistinguishable petrologically from lavas of similar composition.

The attempt to form a special group of hypabyssal (intrusive and dike) rocks has met with much criticism and opposition. Such a group certainly cannot rank as equally important and equally well characterized with the plutonic and the effusive. But there are many kinds of rock which are not found to occur normally in any other manner. As examples we may cite the lamprophyres, the apaites and the porphyrites. These never occur as lava flows or as great plutonic bosses; if magmas of the same composition as these rocks occur in either of these ways they consolidate with different assemblages of minerals and different structures.

In subdividing the plutonic, the hypabyssal and the effusive rocks, the principle is followed of grouping those together which resemble one another in mineral constitution and in chemical composition. In a broad sense these two properties are interdependent.

¹ Idiomorphic, having its own characteristic form. Gr. ἴδιος, belonging to one's self, (ἰδίως, ἰδίως) (form); allotriomorphic, from Gr. ἄλλοτριος, belonging to another (ἄλλος), a stranger (ἴσως).

The commoner rock constituents are nearly all oxides; chlorine, sulphur and fluorine are the only important exceptions to this and their total amount in any rock is usually much less than 1%. F. W. Clarke has calculated that a little more than 47% of the earth's crust consists of oxygen. It occurs principally in combination as oxides, of which the chief are silica, alumina, iron oxides, lime, magnesia, potash and soda. The silica functions principally as an acid, forming silicates, and all the commonest minerals of igneous rocks are of this nature. From a computation based on 1672 analyses of all kinds of rocks Clarke arrived at the following as the average percentage composition: $SiO_2 = 59.71$, $Al_2O_3 = 15.41$, $Fe_2O_3 = 2.63$, $FeO = 3.52$, $MgO = 4.36$, $CaO = 4.90$, $Na_2O = 3.55$, $K_2O = 2.80$, $H_2O = 1.52$, $TrO_2 = 0.60$, $P_2O_5 = 0.22$, total 99.22%. All the other constituents occur only in very small quantities, usually much less than 1%.

These oxides do not combine in a haphazard way. The potash and soda, for example, with a sufficient amount of alumina and silica, combine to produce feldspars. In some cases they may take other forms, such as nepheline, leucite and muscovite, but in the great majority of instances they are found as feldspar. The phosphoric acid with lime forms apatite. The titanium dioxide with ferrous oxide gives rise to ilmenite. Part of the lime forms lime feldspar. Magnesia and iron oxides with silica crystallize as olivine or enstatite, or with alumina and lime form the complex ferro-magnesian silicates of which the pyroxenes, amphiboles and biotites are the chief. Any excess of silica above what is required to neutralize the bases will separate out as quartz; excess of alumina crystallizes as corundum. These must be regarded only as general tendencies, which are modified by physical conditions in a manner not as yet understood. It is possible by inspection of a rock analysis to say approximately what minerals the rock will contain, but there are numerous exceptions to any rule which can be laid down.

Hence we may say that except in acid or siliceous rocks containing 66% of silica and over, quartz will not be abundant. In basic rocks (containing 60% silica or less) it is rare and accidental. If magnesia and iron be above the average while silica is low olivine may be expected; where silica is present in greater quantity other ferro-magnesian minerals, such as augite, hornblende, enstatite or biotite, occur rather than olivine. Unless potash is high and silica relatively low leucite will not be present, for leucite does not occur with free quartz. Nepheline, likewise, is usually found in rocks with much soda and comparatively little silica. With high alkalia soda-bearing pyroxenes and amphiboles may be present. The lower the percentage of silica and the alkalis the greater is the prevalence of lime feldspar as contrasted with soda or potash feldspar. Clarke has calculated the relative abundance of the principal rock-forming minerals with the following results: Apatite = 0.6, titanium minerals = 1.5, quartz = 12.0, feldspars = 59.5, biotite = 3.8, hornblende and pyroxene = 16.8, total = 94.2%. This, however, can only be a rough approximation. The other determining factor, namely the physical conditions attending consolidation, plays on the whole a smaller part, yet is by no means negligible, as a few instances will prove. There are certain minerals which are practically confined to deep-seated intrusive rocks, e.g. microcline, muscovite, diaspore. Leucite is very rare in plutonic masses; many minerals have special peculiarities in microscopic character according to whether they crystallized in depth or near the surface, e.g. hypersthene, orthoclase, quartz. There are some curious instances of rocks having the same chemical composition but consisting of entirely different minerals, e.g. the hornblende of Gran, in Norway, containing only hornblende, has the same composition as some of the camptonites of the same locality which contain feldspar and hornblende of a different variety. In this connexion we may repeat what has been said above about the corrosion of porphyritic minerals in igneous rocks. In rhyolites and trachytes early crystals of hornblende and biotite may be found in great numbers partially converted into augite and magnetite. The hornblende and biotite were stable under the pressures and other conditions which obtained below the surface, but unstable at higher levels. In the ground-mass of these rocks augite is almost universally present. But the plutonic representatives of the same magma, granite and syenite contain biotite and hornblende far more commonly than augite.

Those rocks which contain most silica and on crystallizing yield free quartz are erected into a group generally designated the "acid" rocks. Those again which contain least silica and most magnesia and iron, so that quartz is absent while olivine is usually abundant, form the "basic" group. The "intermediate" rocks include those which are characterized by the general absence of both quartz and olivine.

An important subdivision of these contains a very high percentage of alkalis, especially soda, and consequently has minerals such as nepheline and leucite not common in other rocks. It is often separated from the others as the "alkali" or "soda" rocks,

and there is a corresponding series of basic rocks. Lastly a small sub-group rich in olivine and without feldspar has been called the "ultrabasic" rocks. They have very low percentages of silica but much iron and magnesia.

Except these last practically all rocks contain feldspars or feldspathoid minerals. In the acid rocks the common feldspars are orthoclase, with perthite, microcline, oligoclase, all having much silica and alkalis. In the basic rocks Labradorite, anorthite and bytownite prevail, being rich in lime and poor in silica, potash and soda. Augite is the commonest ferro-magnesian of the basic rocks, but biotite and hornblende are on the whole more frequent in the acid.

The rocks which contain leucite or nepheline, either partly or wholly replacing feldspar are not included in this table. They are essentially of intermediate or of basic character. We might in consequence regard them as varieties of syenite, diorite, gabbro, &c.,

Commonest Minerals.	Acid.	Intermediate		Basic.	Ultrabasic.
	Quartz Orthoclase (and Oligoclase), Mica, Hornblende, Augite.	Little or no Quartz.		No Quartz Plagioclase Augite, Olivine.	No Feldspar Augite, Hornblende, Olivine.
		Orthoclase Hornblende, Augite, Biotite.	Plagioclase Hornblende, Augite, Biotite.		
Plutonic or Abyssal type.	Granite.	Syenite.	Diorite.	Gabbro.	Peridotite.
	Intrusive or Hypabyssal type.	Quartz-porphphyry.	Orthoclase-porphphyry.	Porphyryite.	Dolerite.
Lavas or Effusive type.	Rhyolite, Obsidian.	Trachyte.	Andesite.	Basalt.	Limburgite.

in which feldspathoid minerals occur, and indeed there are many transitions between syenites of ordinary type and nepheline—or leucite—syenite, and between gabbro or dolerite and theralite or essexite. But as many minerals develop in these "alkali" rocks which are uncommon elsewhere, it is convenient in a purely formal classification like that which is outlined here to treat the whole assemblage as a distinct series.

Nepheline and Leucite-bearing Rocks.

Commonest Minerals.	Alkali Feldspar, Nepheline or Leucite, Augite, Hornblende, Biotite.	Soda Lime Feldspar Nepheline or Leucite, Augite, Hornblende (Olivine).	Nepheline or Leucite, Augite, Hornblende, Olivine.	
Plutonic type.	Nepheline-syenite. Leucite-syenite. Nepheline-porphphyry.	Essexite and Theralite.	Ijolite and Missouriite.	
Intrusive type.			Tephrite and Basanite.	Nepheline-basalt. Leucite-basalt.
Effusive type or Lavas.				

This classification is based essentially on the mineralogical constitution of the igneous rocks. Any chemical distinctions between the different groups, though implied, are relegated to a subordinate position. It is admittedly artificial but it has grown up with the growth of the science and is still adopted as the basis on which more minute subdivisions are erected. The subdivisions are by no means of equal value. The syenites, for example, and the peridotites, are far less important than the granites, diorites and gabbros. Moreover, the effusive andesites do not always correspond to the plutonic diorites but partly also to the gabbros. As the different kinds of rock, regarded as aggregates of minerals, pass gradually into one another, transitional types are very common and are often so important as to receive special names. The quartz-syenites and nordmarkites may be interposed between granite and syenite, the tonalites and adamellites between granite and diorite, the monzonites between syenite and diorite, norites and hyperites between diorite and gabbro, and so on.

There is of course a large number of recognized rock species not included in the tables given. These are of two kinds, either belonging to groups which are subdivisions of those enumerated (bearing the same relation to them that species do to genera) or rare and exceptional rocks that do not fall within any of the main subdivisions proposed. The question may be asked—When is a rock entitled to be recognized as belonging to a distinct species or variety and deserving a name for itself? It must, first of all, be proved to occur in considerable quantity at some locality, or better still at a series of localities or to have been produced from different magmas at more than one period of the earth's history. In other words, it must not be a mere anomaly. Moreover, it should have a distinctive mineral constitution, differing from other rocks, or something individual in the characters of its minerals or of its structures. It is often surprising how peculiar types of rock, believed at first

PETROLOGY

PLATE I.

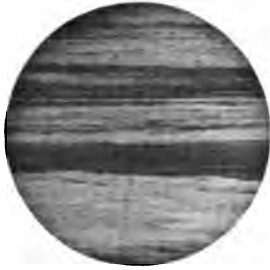

Fig. 1.—Banded Obsidian, Kirghiz.
The rock consists of alternate bands of brown and colourless glass which have been arranged in stripes by the fluxion movement of the viscous mass before solidification. The glass is rendered granular by very minute crystals.



Fig. 2.—Fluidal Rhyolite, Hungary.
In the centre are crystals of felspar, rather turbid through weathering. The matrix is partly glassy, partly felsitic, and shows the effects of streaming movements with eddies behind the felspar crystals.

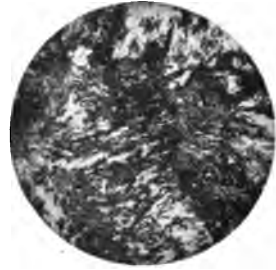

Fig. 3.—Obsidian, Mexico.
This rock has a damascened pattern owing to the irregular mingling of streams of brown and of colourless glass. It is nearly quite free from minute crystals.



Fig. 4.—Perlitic Obsidian, Tokai, Hungary.
The clear glassy rock is traversed by a large number of cracks, some long and straight, while others are nearly circular. These are rendered more distinct by the deposit of thin films of secondary limonite in them. The cracks are due to contraction on cooling.



Fig. 5.—Perlitic Pitchstone, Meissen, Germany.
The perlitic, rounded cracks are very clearly seen, because the rock is decomposing and becoming slightly opaque along them. At the top there is a corroded crystal of felspar, showing cleavage, with large circular enclosures of brownish glass.

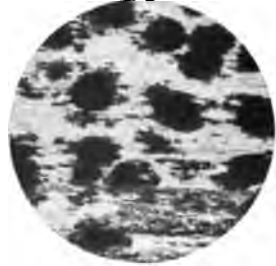

Fig. 6.—Obsidian, Iceland.
In the clear glassy base there are rounded yellow spots (spherulites) arranged in fluxion streams.

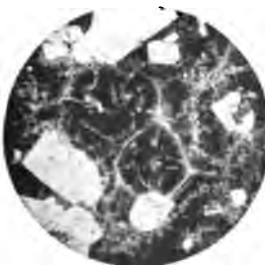

Fig. 7.—Spherulitic Rhyolite, Hlinik, Hungary.
The white, angular patches are crystals of quartz and of sanidine felspar. Between them there is a yellowish glass showing circular areas with a well-defined radiate fibrous structure (spherulites).



Fig. 8.—Spherulitic Felsite, Arran, Scotland.
The round spherulites of this rock are large and sometimes composite; their radiate structure is obvious. This is a devitrified pitchstone, no longer glassy but finely crystalline, and at the centres of the spherulites there are spaces occupied by a secondary deposit of quartz.



Fig. 9.—Porphyritic and Fluidal Rhyolite, Hungary.
The ground mass is partly glassy, partly felsitic, and shows fluxion-banding. The large quartz is a double hexagonal pyramid, but its edges and corners are rounded by corrosion and large irregular areas of glass penetrate to its centre.

The commoner rock constituents are nearly all oxides; chlorine, sulphur and fluorine are the only important exceptions to this and their total amount in any rock is usually much less than 1%. F. W. Clarke has calculated that a little more than 47% of the earth's crust consists of oxygen. It occurs principally in combination as oxides, of which the chief are silica, alumina, iron oxides, lime, magnesia, potash and soda. The silica functions principally as an acid, forming silicates, and all the commonest minerals of igneous rocks are of this nature. From a computation based on 1672 analyses of all kinds of rocks Clarke arrived at the following as the average percentage composition: $\text{SiO}_2 = 59.71$, $\text{Al}_2\text{O}_3 = 15.41$, $\text{Fe}_2\text{O}_3 = 2.63$, $\text{FeO} = 3.52$, $\text{MgO} = 4.36$, $\text{CaO} = 4.90$, $\text{Na}_2\text{O} = 3.55$, $\text{K}_2\text{O} = 2.80$, $\text{H}_2\text{O} = 1.52$, $\text{TiO}_2 = 0.60$, $\text{P}_2\text{O}_5 = 0.22$, total 99.22%. All the other constituents occur only in very small quantities, usually much less than 1%.

These oxides do not combine in a haphazard way. The potash and soda, for example, with a sufficient amount of alumina and silica, combine to produce feldspars. In some cases they may take other forms, such as nepheline, leucite and muscovite, but in the great majority of instances they are found as feldspar. The phosphoric acid with lime forms apatite. The titanium dioxide with ferrous oxide gives rise to ilmenite. Part of the lime forms lime feldspar. Magnesia and iron oxides with silica crystallize as olivine or enstatite, or with alumina and lime form the complex ferro-magnesian silicates of which the pyroxenes, amphiboles and biotites are the chief. Any excess of silica above what is required to neutralize the bases will separate out as quartz; excess of alumina crystallizes as corundum. These must be regarded only as general tendencies, which are modified by physical conditions in a manner not as yet understood. It is possible by inspection of a rock analysis to say approximately what minerals the rock will contain, but there are numerous exceptions to any rule which can be laid down.

Hence we may say that except in acid or siliceous rocks containing 66% of silica and over, quartz will not be abundant. In basic rocks (containing 60% silica or less) it is rare and accidental. If magnesia and iron be above the average while silica is low olivine may be expected; where silica is present in greater quantity other ferro-magnesian minerals, such as augite, hornblende, enstatite or biotite, occur rather than olivine. Unless potash is high and silica relatively low leucite will not be present, for leucite does not occur with free quartz. Nepheline, likewise, is usually found in rocks with much soda and comparatively little silica. With high alkalis soda-bearing pyroxenes and amphiboles may be present. The lower the percentage of silica and the alkalis the greater is the prevalence of lime feldspar as contrasted with soda or potash feldspar. Clarke has calculated the relative abundance of the principal rock-forming minerals with the following results: Apatite = 0.6, titanium minerals = 1.5, quartz = 12.0, feldspars = 59.5, biotite = 3.8, hornblende and pyroxene = 16.8, total = 94.2%. This, however, can only be a rough approximation. The other determining factor, namely the physical conditions attending consolidation, plays on the whole a smaller part, yet is by no means negligible, as a few instances will prove. There are certain minerals which are practically confined to deep-seated intrusive rocks, e.g. microcline, muscovite, diallage. Leucite is very rare in plutonic masses; many minerals have special peculiarities in microscopic character according to whether they crystallized in depth or near the surface, e.g. hypersthene, orthoclase, quartz. There are some curious instances of rocks having the same chemical composition but consisting of entirely different minerals, e.g. the hornblende of Gran, in Norway, containing only hornblende, has the same composition as some of the camptonites of the same locality which contain feldspar and hornblende of a different variety. In this connexion we may repeat what has been said above about the corrosion of porphyritic minerals in igneous rocks. In rhyolites and trachytes early crystals of hornblende and biotite may be found in great numbers partially converted into augite and magnetite. The hornblende and biotite were stable under the pressures and other conditions which obtained below the surface, but unstable at higher levels. In the ground-mass of these rocks augite is almost universally present. But the plutonic representatives of the same magma, granite and syenite contain biotite and hornblende far more commonly than augite.

Those rocks which contain most silica and on crystallizing yield free quartz are erected into a group generally designated the "acid" rocks. Those again which contain least silica and most magnesia and iron, so that quartz is absent while olivine is usually abundant, form the "basic" group. The "intermediate" rocks include those which are characterized by the general absence of both quartz and olivine.

An important subdivision of these contains a very high percentage of alkalis, especially soda, and consequently has minerals such as nepheline and leucite not common in other rocks. It is often separated from the others as the "alkali" or "soda" rocks,

and there is a corresponding series of basic rocks. Lastly a small sub-group rich in olivine and without feldspar has been called the "ultrabasic" rocks. They have very low percentages of silica but much iron and magnesia.

Except these last practically all rocks contain feldspars or feldspathoid minerals. In the acid rocks the common feldspars are orthoclase, with perthite, microcline, oligoclase, all having much silica and alkalis. In the basic rocks labradorite, anorthite and bytownite prevail, being rich in lime and poor in silica, potash and soda. Augite is the commonest ferro-magnesian of the basic rocks, but biotite and hornblende are on the whole more frequent in the acid.

The rocks which contain leucite or nepheline, either partly or wholly replacing feldspar are not included in this table. They are essentially of intermediate or of basic character. We might in consequence regard them as varieties of syenite, diorite, gabbro, &c.,

Commonest Minerals.	Acid.	Intermediate		Basic.	Ultrabasic.
	Quartz Orthoclase (and Oligoclase), Mica, Hornblende, Augite.	Little or no Quartz.		No Quartz Plagioclase Augite, Olivine.	No Feldspar Augite, Hornblende, Olivine.
Plutonic or Abyssal type. Intrusive or Hypabyssal type. Lavas or Effusive type.	Granite.	Syenite.	Diorite.	Gabbro.	Peridotite.
	Quartz-porphphyry.	Orthoclase-porphphyry.	Porphyrite.	Dolerite.	Picrite.
	Rhyolite, Obsidian.	Trachyte.	Andesite.	Basalt.	Limburgite.

in which feldspathoid minerals occur, and indeed there are many transitions between syenites of ordinary type and nepheline or leucite—syenite, and between gabbro or dolerite and theralite or essexite. But as many minerals develop in these "alkali" rocks which are uncommon elsewhere, it is convenient in a purely formal classification like that which is outlined here to treat the whole assemblage as a distinct series.

Nepheline and Leucite-bearing Rocks.

Commonest Minerals.	Alkali Feldspar, Nepheline or Leucite, Augite, Hornblende, Biotite.	Soda Lime Feldspar Nepheline or Leucite, Augite, Hornblende, (Olivine).	Nepheline or Leucite, Augite, Hornblende, Olivine.
Plutonic type.	Nepheline-syenite.	Essexite and Theralite.	Ijolite and Missouriite.
Intrusive type.	Leucite-syenite.		
Effusive type or Lavas.	Nepheline-porphphyry. Phonolite, Leucitophyre.	Tephrite and Basanite.	Nepheline-basalt. Leucite-basalt

This classification is based essentially on the mineralogical constitution of the igneous rocks. Any chemical distinctions between the different groups, though implied, are relegated to a subordinate position. It is admittedly artificial but it has grown up with the growth of the science and is still adopted as the basis on which more minute subdivisions are erected. The subdivisions are by no means of equal value. The syenites, for example, and the peridotites, are far less important than the granites, diorites and gabbros. Moreover, the effusive andesites do not always correspond to the plutonic diorites but partly also to the gabbros. As the different kinds of rock, regarded as aggregates of minerals, pass gradually into one another, transitional types are very common and are often so important as to receive special names. The quartz-syenites and nordmarkites may be interposed between granite and syenite, the tonalites and adamellites between granite and diorite, the monzonites between syenite and diorite, norites and hyperites between diorite and gabbro, and so on.

There is of course a large number of recognized rock species not included in the tables given. These are of two kinds, either belonging to groups which are subdivisions of those enumerated (bearing the same relation to them that species do to genera) or rare and exceptional rocks that do not fall within any of the main subdivisions proposed. The question may be asked—When is a rock entitled to be recognized as belonging to a distinct species or variety and deserving a name for itself? It must, first of all, be proved to occur in considerable quantity at some locality, or better still at a series of localities or to have been produced from different magmas at more than one period of the earth's history. In other words, it must not be a mere anomaly. Moreover, it should have a distinctive mineral constitution, differing from other rocks, or something individual in the characters of its minerals or of its structures. It is often surprising how peculiar types of rock, believed at first

PETROLOGY

PLATE I.



Fig. 1.—Banded Obsidian, Kirghiz.
The rock consists of alternate bands of brown and colourless glass which have been arranged in stripes by the fluxion movement of the viscous mass before solidification. The glass is rendered granular by very minute crystals.



Fig. 2.—Fluidal Rhyolite, Hungary.
In the centre are crystals of feldspar, rather turbid through weathering. The matrix is partly glassy, partly felsitic, and shows the effects of streaming movements with eddies behind the feldspar crystals.

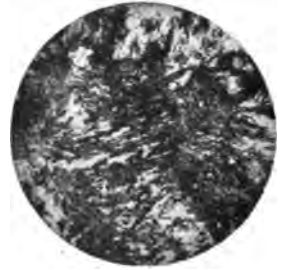

Fig. 3.—Obsidian, Mexico.
This rock has a damascened pattern owing to the irregular mingling of streams of brown and of colourless glass. It is nearly quite free from minute crystals.

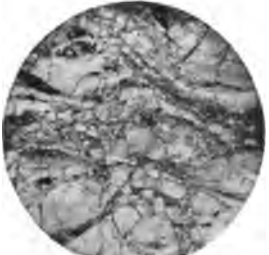

Fig. 4.—Perlitic Obsidian, Tokai, Hungary.
The clear glassy rock is traversed by a large number of cracks, some long and straight, while others are nearly circular. These are rendered more distinct by the deposit of thin films of secondary limonite in them. The cracks are due to contraction on cooling.

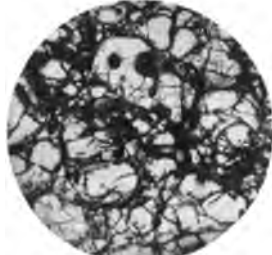

Fig. 5.—Perlitic Pitchstone, Meissen, Germany.
The perlitic, rounded cracks are very clearly seen, because the rock is decomposing and becoming slightly opaque along them. At the top there is a corroded crystal of feldspar, showing cleavage, with large circular enclosures of brownish glass.



Fig. 6.—Obsidian, Iceland.
In the clear glassy base there are rounded, yellow spots (spherulites) arranged in fluxion streams.

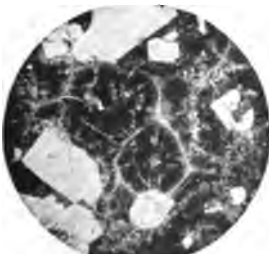

Fig. 7.—Spherulitic Rhyolite, Hlinik, Hungary.
The white, angular patches are crystals of quartz and of sanidine feldspar. Between them there is a yellowish glass showing circular areas with a well-defined radiate fibrous structure (spherulites).



Fig. 8.—Spherulitic Felsite, Arran, Scotland.
The round spherulites of this rock are large and sometimes composite; their radiate structure is obvious. This is a devitrified pitchstone, no longer glassy but finely crystalline, and at the centres of the spherulites there are spaces occupied by a secondary deposit of quartz.



Fig. 9.—Porphyritic and Fluidal Rhyolite, Hungary.
The ground mass is partly glassy, partly felsitic, and shows fluxion-banding. The large quartz is a double hexagonal pyramid, but its edges and corners are rounded by corrosion and large irregular areas of glass penetrate to its centre.

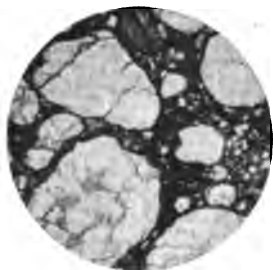

Fig. 1.—Pebble Grit, Banff, Scotland.
The white pebbles are quartz with irregular cracks and streaks of fluid inclusions. The matrix is a dark, semi-opaque mixture of clay and small sand-grains.

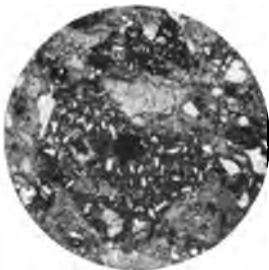

Fig. 2.—Volcanic Tuff, Arthur's Seat, Edinburgh.
A fragmental volcanic rock with small lapilli of basalt; these are vesicular and contain little felspar crystals. Broken felspars also lie scattered through the rock.

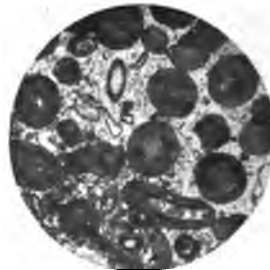

Fig. 3.—Crinoidal Limestone (Carboniferous), Clifton, near Bath, England.
The oolitic grains are round or oval, with concentric zoning; in their interior there is sometimes a shell fragment or other nucleus. The interstitial matrix is clear, granular, crystalline calcite. The rock contains fragments of echinoderms, brachiopods, and other fossils.



Fig. 4.—Marble, Carrara, Italy
A section of well-known statuary marble which consists entirely of calcite in small irregular crystals closely fitted together.



Fig. 5.—Oolitic Chert (Cambrian), Sutherlandshire, Scotland.
This has been once an oolitic limestone, but the calcite has been entirely replaced by silica with perfect preservation of the oolitic structure.



Fig. 6.—Mylonite Durness, Sutherlandshire.
This well-banded rock was once a crystalline gneiss which has been greatly crushed by earth-movements, and has been ground down into a fine aggregate of quartz, felspar, and mica. The banding is due to internal flow under great pressure.

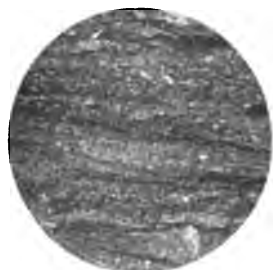

Fig. 7.—Slate, Wadebridge, Cornwall.
A fine-grained clay rock with small clear spots of quartz and minute scales of mica, chlorite, &c. The parallel arrangement of the latter is the cause of cleavage. Obscure dark lines cut across the rock and indicate the development of a secondary cross-cleavage or slip-cleavage.



Fig. 8.—Mica-Schist, Blair-Atholl, Perthshire, Scotland.
A clay rock like the preceding one, but more metamorphic and coarsely crystalline. The clear spots are quartz and the bladed mineral between them is brown and white mica (biotite and muscovite).



Fig. 9.—Chistolite-Slate, Skiddaw, Cumberland.
A clay rock affected by contact metamorphism attended by the production of needles of chistolite, which have in transverse section a diamond-shape with dark enclosures at their centres and a dark cross radiating to their corners.

to be unique, turn up with identical features in widely scattered regions, *abundant*, for example, occurs in Norway, Scotland, Montreal, British Columbia, New York and Brazil, *tinguaita* in Scotland, Norway, Brazil, Montana, Portugal, &c. This indicates that underlying all the variations in mineralogical, structural and chemical properties there are definite relationships which tend to repeat themselves, producing the same types whenever the same conditions are present.

Although in former years the view was widely current, especially in Germany, that igneous rocks belonging to different geological epochs should receive different names, it is now admitted on all sides that this cannot be upheld.

In 1902 a group of American petrographers brought forward a proposal to discard all existing classifications of igneous rocks and to substitute for them a "quantitative" classification based on chemical analysis. They showed how vague and often unscientific was much of the existing terminology and argued that as the chemical composition of an igneous rock was its most fundamental characteristic it should be elevated to prime position. Geological occurrence, structure, mineralogical constitution, the hitherto accepted criteria for the discrimination of rock species were relegated to the background. The completed rock analysis is first to be interpreted in terms of the rock-forming minerals which might be expected to be formed when the magma crystallizes, e.g. quartz feldspars of various kinds, olivine, akermannite, feldspaths, magnetite, corundum and so on, and the rocks are divided into groups strictly according to the relative proportion of these minerals to one another. There is no need here to describe the minutia of the process adopted as the authors have stated them very clearly in their treatise (*Quantitative Classification of Igneous Rocks*, Chicago, 1902), and there is no indication that even in the United States it will ever displace the older classifications.

We can often observe in a series of eruptions belonging to one period and a restricted area certain features which distinguish them as a whole more or less completely from other similar assemblages. Such groups are often said to be "consanguineous," and to characterize a definite "petrological province." Excellent examples of this are furnished by the Devonian igneous rocks of southern Norway as described by Brøgger, the Tertiary rocks of the Hebrides (Harker), the Italian lavas studied by H. S. Washington. On a larger scale the volcanoes which girdle the Pacific (Andes, Cordillera, Japan, &c.), and those which occur on the volcanic islands of the Atlantic, show the same phenomena. Each of these groups has been formed presumably from a single deep-seated magma or source of supply and during a period which while necessarily prolonged was not of vast duration in a geological sense.

On the other hand, each of the great suites of eruptive rocks which constitute such a petrological province embraces a great *Differentiation* range of types. Prolonged eruptions have in a few cases a somewhat monotonous character, owing to the predominance of one kind of rock. Thus the lavas of the Hawaiian Islands are mostly basaltic, as are those of Oregon, Washington and the Decan, all of which form geological masses of enormous magnitude. But it is more usual to find basalts, andesites, trachytes, dacites and many other rocks occurring in a single eruptive complex. The process by which a magma splits up into a variety of partial products is known as "differentiation." Its importance from the standpoint of theoretical petrology is very great, but as yet no adequate explanation of it has been offered. Differentiation may show itself in two ways. In the first type the successive emissions from a volcanic focus may differ considerably from one another. Thus in the Pentland Hills, near Edinburgh, the lavas which are of lower Devonian age, were first basaltic, then andesitic, trachytic and dacitic, and finally rhyolitic, and this succession was repeated a second time. Yet they all must have come from the same focus, or at any rate from a group of foci very closely connected with one another. Occasionally it is found that the earlier lavas are of intermediate character and that basic alternate with acid during the later stages of the volcanic history.

Not less interesting are those cases in which a single body of rock has in consolidation yielded a variety of petrographical types often widely divergent. This is best shown by great plutonic bosses which may be regarded as having once been vast subterranean spaces filled with a nearly homogeneous liquid magma. Cooling took place gradually from the outer surfaces where the igneous rock was in contact with the surrounding strata. The resultant laccolites (Gr. *laxos*, pit, crater, *lithos*, stone), stock or boss, may be a few hundred yards or many miles in diameter and often contains a great diversity of crystalline rocks. Thus peridotite, gabbro, diorite, tonalite and granite, are often associated, usually in such a way that the more basic are the first-formed and lie nearest the external surfaces of the mass. The reverse sequence occurs occasionally, the edges being highly acid while the central parts consist of more basic rocks. Sometimes the later phases penetrate into and vein the earlier; evidently there has been some movement due to temporary increase of pressure when part of the laccolite was solid and part still in a liquid state. This links these phenomena with those above described where successive emissions of different character have proceeded outwards from the focus.

According to modern views two explanations of these facts are possible. Some geologists hold that the different rock facies found in association are often due to local absorption of surrounding rocks by the molten magma ("assimilation"). Effects of this kind are to be expected, and have been clearly proved in many places. There is, however, a general reluctance to admit that they are of great importance. The nature and succession of the rock species do not as a rule show any relation to the sedimentary or other materials which may be supposed to have been dissolved; and where solution is known to have gone on the products are usually of abnormal character and easily distinguishable from the common rock types.

Hence it is generally supposed that differentiation is to be ascribed to some physical or chemical processes which lead to the splitting up of a magma into dissimilar portions, each of which consolidates as a distinct kind of rock. Two factors can be selected as probably most potent. One important factor is cooling and another is crystallization. According to physico-chemical law the least soluble substances will tend to diffuse towards the cooling surfaces (Ludwig-Soret's principle). This is in accordance with the majority of the observed facts and is probably a *vera causa* of differentiation, though what its potency may be is uncertain. As a rock solidifies the minerals which crystallize follow one another in a more or less well-defined order, the most basic (according to Rosenbusch's law) being first to separate out. That in a general way the peripheral portions of a laccolite consist mainly of those early basic minerals suggests that the sequence of crystallization helps largely in determining the succession (and consequently the distribution of rock species in a plutonic complex). Gravity also may play a part, for it is proved that in a solution at rest the heaviest components will be concentrated towards the base. This must, however, be of secondary importance as in laccolites the top portions often consist of more basic and heavier varieties of rock than the centres. It has also been argued that the earliest minerals being heaviest and in any case denser than the fused magma around them, will tend to sink by their own weight and to be congregated near the bottom of the mass. Electric currents, magnetic attraction and convection currents have also been called in to account for the phenomena observed. Magmas have also been compared to liquids which, when they cool, split up into portions no longer completely soluble in one another (liquidus hypothesis). Each of these partial magmas may dissolve a portion of the others and as the temperature falls and the conditions change a range of liquids differing in composition may be supposed to arise.

All igneous magmas contain dissolved gases (steam, carbonic acid, sulphuretted hydrogen, chlorine, fluorine, boric acid, &c.). Of these water is the principal, and was formerly believed to have percolated downwards from the earth's surface to the heated rocks below, but is now generally admitted to be an integral part of the magma. Many peculiarities of the structure of the plutonic rocks as contrasted with the lavas may reasonably be accounted for by the operation of these gases, which were unable to escape as the deep-seated masses slowly cooled, while they were promptly given up by the superficial effusions. The acid plutonic or intrusive rocks have never been reproduced by laboratory experiments, and the only successful attempts to obtain their minerals artificially have been those in which special provision was made for the retention of the "mineralizing" gases in the crucibles or sealed tubes employed. These gases often do not enter into the composition of the rock-forming minerals, for most of these are free from water, carbonic acid, &c. Hence as crystallization goes on the residual liquor must contain an ever-increasing proportion of volatile constituents. It is conceivable that in the final stages the still uncrystallized part of the magma has more resemblance to a solution of mineral matter in superheated steam than to a dry igneous fusion. Quartz, for example, is the last mineral to form in a granite. It bears much of the stamp of the quartz which we know has been deposited from aqueous solution in veins, &c. It is at the same time the most infusible of all the common minerals of rocks. Its late formation shows that in this case it arose at comparatively low temperatures and points clearly to the special importance of the gases of the magma as determining the sequence of crystallization.

When solidification is nearly complete the gases can no longer be retained in the rock and make their escape through fissures towards the surface. They are powerful agents in attacking the minerals of the rocks which they traverse, and instances of their operation are found in the laccolization of grafsites, tourmalinization and formation of greisen, deposit of quartz veins, stanniferous and auriferous veins, apatite veins, and the group of changes known as propylitization.¹ These "pneumatolytic" (Gr. *pneuma*, spirit, vapour, *lysis*, to loose, dissolve) processes are of the first importance in the genesis of many ore deposits. They are a real part of the history of the magma itself and constitute the terminal phases of the volcanic sequence.

The complicated succession from basic (or ultrabasic) to acid types exemplified in the history of many magmas is reflected with

¹ The term "propylite" (Gr. *propylion*, a gateway) was given by Richthofen to a volcanic rock which is supposed to have marked a new epoch in volcanic geology (see ANDREWS).

astonishing completeness in the history of individual products. In each class of rock crystallization follows a definite course. The

first minerals to separate belong to a group known as the minor accessories; this includes zircon, apatite, sphene iron oxides; then follow in order olivine, augite, hornblende, biotite, plagioclase, feldspar (beginning with the varieties most rich in lime and ending with those which contain most soda), orthoclase, microcline and quartz (with micropegmatite). Many exceptions to this rule are known; the same mineral may crystallize at two different periods; two or more minerals may crystallize simultaneously or the stages in which they form may overlap. But the succession above given holds in the vast majority of cases. Expressed in this way: the more basic minerals precede the less basic; it is known as Rosenbusch's law.

Types of Structure.—In some rocks there seems to be little tendency for the minerals to envelop one another. This is true of many gabbros, apfites and granites (Pl. III, fig. 7). The grains then lie side by side, with the faces of the latter moulded on or adapted to the more perfect crystalline outlines of the earlier. More commonly some closer relationship exists between them. When the smaller idiomorphic crystals of the first-formed are scattered irregularly through the larger and less perfect crystals of later origin, the structure is said to be poikilitic (Gr. *poikilos*, many-coloured, mottled). A variety of this, known as ophitic (Pl. III, fig. 6), is very characteristic of many dolerites and diabases, in which large plates of augite enclose many small laths of plagioclase feldspar. Biotite and hornblende frequently enclose feldspar optically; less commonly iron oxides and sphene do so. In peridotites the "lustre-mottled" structure arises from pyroxene or hornblende enveloping olivine in the same manner (Pl. III, fig. 8). In these cases no crystallographic relation exists between the two minerals (enclosing and enclosed).

But often the surrounding mineral has been laid down on the surface of the other in such a way that they have certain crystalline faces or axes parallel to one another. This is known as "parallel growth." It is best seen in zoned crystals of plagioclase feldspar, which may range in composition from anorthite to oligoclase, the more acid layers being deposited regularly on the surfaces of the more basic. Biotite and muscovite, hornblende and augite, enstatite and diaspore, epidote and orthite, very frequently are associated in this way.

When two minerals crystallize simultaneously they may be intergrown in "graphic" fashion. The best example is quartz and orthoclase occurring together as micropegmatite (Pl. II, figs. 6 and 8). The quartz forms angular patches in the feldspar, which though separated have the same crystalline orientation and one position of extinction, while the feldspar on its part behaves in the same way. Two porous crystals thus interpenetrate but the scattered parts of each mineral maintain their connexion with the others. There may be also a definite relation between the crystalline axes of the two crystals, though this is not known in all cases. Augite also occurs in graphic intergrowth with hornblende, olivine and feldspar; and hornblende, cordierite, epidote and biotite in graphic intergrowth with quartz.

Physical Chemistry of Igneous Rocks.—The great advances that have been made in recent years in our knowledge of physical chemistry have very important bearings on petrological investigations. Especially in the study of the genesis of igneous rocks we anticipate that by this means much light will be thrown on problems which are now very obscure and a complete revolution in our ideas of the conditions which affect crystallization may yet be the consequence. Already many important results have been gleaned. As yet little work of an exact and quantitative nature has been done on actual rocks or on mixtures resembling them in composition, but at the Carnegie Institution in Washington, an elaborate series of experiments in the synthesis of minerals and the properties of mixtures of these is being carried on, with all the refinements which modern science can suggest. The work of Doelter and of Vogt may also be mentioned in this connection. At the same time the mathematical theory of the physical processes involved has received much attention, and serves both to direct and to elucidate the experimental work.

A fused mixture of two minerals may be regarded as a solution of one on the other. If such a solution be cooled down, crystallization will generally set in and if the two components be independent (or do not form mixed crystals) one of them may be expected to start crystallizing. On further cooling, more of this mineral will separate out till at last a residue is left which contains the two components in definite proportions. This mixture, which is known as the eutectic mixture, has the lowest melting-point of any which can be formed from these minerals. If heat be still abstracted the eutectic will consolidate as a whole; its two mineral components will crystallize simultaneously. At any given pressure the composition of the eutectic mixture in such a case is always the same.

Similarly, if there be three independent components (none of which forms mixed crystals with the others), according to their relative amounts and to the composition of the eutectic mixture one will begin to crystallize; then another will make its appearance

in solid form, and when the excess of these has been removed, the ternary eutectic (that mixture of the three which has the lowest melting-point) will be produced and crystallization of all three components will go on simultaneously.

These processes have without doubt a very close analogy to the formation of igneous rocks. Thus in certain felsites or porphyries which may be considered as being essentially mixtures of quartz and feldspar, a certain amount of quartz has crystallized out at an early period in the form of well-shaped porphyritic crystals, and thereafter the remainder of the rock has solidified as a very fine-grained, crypto-crystalline or sometimes micrographic ground-mass which consists of quartz and feldspar in intimate intermixture. The latter closely resembles a eutectic, and chemical studies have proved that within somewhat narrow limits the composition of these felsitic ground-masses is constant.

But the comparison must not be pushed too far, as there are always other components than quartz and feldspar (apatite, zircon, biotite and iron oxides being the most common), and in rocks of this type the gases dissolved in the magma play a very important part. As crystallization goes on, these gases are set free and their pressure must increase to some extent. Moreover, the feldspar is not one mineral but two or perhaps three, there being always soda feldspar and potash feldspar and usually also a small amount of lime feldspar in these porphyries.

In a typical basic rock the conditions are even more complex. A dolerite, for example, usually contains, as its last products of crystallization, pyroxene and feldspar. Of these the latter consists of three distinct species, the former of an unknown number; and in each case they can form mixed crystals, to a greater or less extent with one another. From these considerations it will be clear that the properties of solutions of two or three independent components, do not necessarily explain the process of crystallization in any igneous rock.

Very frequently in porphyries not only quartz but feldspar also is present in large well-formed early crystals. Similarly in basalts, augite and feldspar may appear both as phenocrysts and as components of the ground-mass. As an explanation of this it has been suggested that supersaturation has taken place. We may suppose that the augite which was in excess of the proportion necessary to form the feldspar-augite, eutectic mixture, first separated out. When the remaining solution reached the eutectic composition the feldspar did not at once start crystallizing, perhaps because nuclei are necessary to initiate crystal-growth and these were not at hand; augite went on crystallizing while feldspar lagged behind. Then feldspar began and as the mixture was now supersaturated with that mineral a considerable amount of it was rapidly thrown out of the solution. At the same time there would be a tendency for part of the augite, already crystallized, to be dissolved and its crystals would be corroded, losing their sharp and perfect edges, as is often observed in rocks of this group. When the necessary adjustments had been made the eutectic mixture would be established and thereafter the two minerals would consolidate simultaneously (or nearly so) till crystallization was complete.

There is a good deal of evidence to show that supersaturation is not unimportant in igneous magmas. The frequency with which they form glasses proves that under certain conditions the molten rocks are highly viscous. Much will depend also on the presence, accidental or otherwise, of nuclei on which a mineral substance can be deposited. It is known that minerals differ in their tendency to crystallize, some doing so very readily while others are slow and backward. The rate at which crystallization goes on depends on many factors, and there are remarkable differences in this respect between minerals.

On the other hand, there is plenty of evidence to show that supersaturation, though probably one of the causes, is not the principal cause of the appearance of more than one mineral in two generations of crystals. In some of the quartz-porphyrines, for example, there are phenocrysts not only of quartz and feldspar but also of micropegmatite. These prove that quartz and feldspar were not crystallizing successively or alternately but simultaneously.

The great majority of the minerals found in igneous rocks are not of simple composition, but are mixtures of various elementary minerals in very different proportions. This enormously complicates the theoretical problems of consolidation. It has been found, for example, that in the case of three minerals—one of which is independent, while the two others can form mixed crystals—there is a large number of possible sequences; and, what is very important, one mineral may separate out entirely at an early stage, or its crystallization may be interrupted and not continuous. The ternary eutectic, which is produced by a mixture of three independent minerals, may not in such a case be the last substance to crystallize, and may not be present at all. This is very much in accordance with the observed facts of petrology; for usually in a rock there is one mineral which indubitably was the last of all to finish crystallizing and contained no appreciable quantity of the others.

As yet we know little about such important questions as the composition of the eutectic mixtures of rock-minerals, their latest heat of fusion, specific heats, mutual solubilities, inversion temperatures, &c. Until we are in possession of a large body of accurate information on such points as these the theoretical treatment of

the processes involved in the formation of igneous rocks cannot be successfully handled. But every day sees an increase in the amount of data available, and encourages us to believe that sooner or later some of the simpler igneous rocks at any rate will be completely explicable on physico-chemical principles.

Rock masses of igneous origin have no sooner consolidated than they begin to change. The gases with which the magma is charged are slowly dissipated, lava-flows often remain hot and steaming for many years. These gases attack the components of the rock and deposit new minerals in cavities and fissures. The beautiful zeolites, so well known to collectors of minerals, are largely of this origin. Even before these "post-volcanic" processes have ceased atmospheric decomposition begins. Rain, frost, carbonic acid, oxygen and other agents operate continuously, and do not cease till the whole mass has crumbled down and most of its ingredients have been resolved into new products. In the classification of rocks these secondary changes are generally considered unessential; rocks are classified and described as if they were ideally fresh, though this is rarely the case in nature.

Epigenetic change (secondary processes) may be arranged under a number of headings, each of which is typical of a group of rocks or rock-forming minerals, though usually more than one of these alterations will be found in progress in the same rock. Silicification, the replacement of the minerals by crystalline or crypto-crystalline silica, is most common in acid rocks, such as rhyolite, but is also found in serpentine, &c. Kaolinization is the decomposition of the felspars, which are the commonest minerals of igneous rocks, into kaolin (along with quartz, muscovite, &c.); it is best shown by granites and syenites. Serpentinization is the alteration of olivine to serpentine (with magnetite); it is typical of peridotites, but occurs in most of the basic rocks. In uranization secondary hornblende replaces augite; this occurs very generally in diabases; chloritization is the alteration of augite (biotite or hornblende) to chlorite, and is seen in many diabases, diorites and gneissstones. Epidotization occurs also in rocks of this group, and consists in the development of epidote from biotite, hornblende, augite or plagioclase felspar.

The sedimentary rocks, which constitute the second great group, have many points in common that distinguish them from the igneous and the metamorphic. They have all originated on the surface of the earth, and at the period of their formation were exposed only to the temperature of the air and to atmospheric pressure (or the pressures which exist at the bottoms of seas and lakes). Their minerals are in most cases not susceptible to change when exposed to moist air or sea, and many of them are hydrated (chlorite, micas, &c.), or oxidized (iron ores), or contain carbonic acid (calcite, dolomite). The extent, however, to which this is the case depends largely on the rapidity with which they have accumulated; coarse rocks quickly piled up often consist of materials only partly weathered. When crystalline, the sedimentary rocks are usually soluble at low temperatures. The members of this group occur in beds or strata, hence they are often known as the stratified rocks; the upper beds are always of later formation than those which underlie them, except (as may happen when great disturbance has taken place) the whole series is inverted or overturned. Many of the stratified rocks have been formed by the agency of moving water (rivers, currents, &c.) and are grouped together as "aqueous" rocks; others have been deposited by the wind in deserts, on sandy beaches, &c. (these are "aeolian"). Others are the remains of animals or of plants, modified by the action of time, pressure and percolating water. Lastly, we find beds of crystalline nature, such as rock-salt and gypsum, which have been formed by the desiccation of saline waters; other crystalline stratified rocks, such as dolomite and many bedded iron-stones, are replacement products due to the introduction of mineral matter in solution, which replaced the original rock mass partially or wholly.

When the rocks exposed at the earth's surface give way before the attack of the agencies of denudation, they crumble down and are resolved into two parts. One of these consists of solid material (sand, clay and angular debris) insoluble in carbonated waters; the other part is dissolved and washed away. The undissolved residues, when they finally come to rest, form clastic sedimentary rocks (sandstone, conglomerate, shale, &c.). The dissolved portions are partly transferred to the sea, where they help to increase its store of salts, and may again be precipitated as crystalline sedimentary rocks; but they are also made use of by plants and by animals to form their skeletal and vital tissues. From this latter portion the rocks of organic origin are built up. These

may also contain certain ingredients derived from the atmosphere (nitrogen, carbon in coals, &c.).

We have thus three types of sediments of distinct origin, which may be named the clastic (or fragmental), the crystalline and the organic.

The clastic materials may accumulate *in situ*, and then differ chiefly in their disintegrated and weathered state from the parent rock masses on which they rest. The best example of these are the soils, but in elevated regions angular broken rock often covers large areas. More usually they are transported by wind or water, and become sorted out according to their size and density. The coarsest debris comes first to rest and is least worn and weathered; it includes scree, gravels, coarse sands, &c., and consolidates as conglomerates, breccias and pebbly grits. The bedding of these rocks is rudimentary and imperfect, and as each bed is traced along its outcrop it frequently changes its character with the strata on which it rests. The most finely divided sediment travels farthest, and is laid down in thin uniform sheets of wide extent. It is known as mud and clay; around the shores of our continents, at distances of a hundred miles and more from land, great sheets of mud are spread over the ocean floor. This mud contains minute particles of quartz and of felspar, but consists essentially of finely divided scaly minerals, which by their small size and flat shape tend to remain suspended in water for a very long time. Chlorite, white micas and kaolin are the best examples of this class of substances. Wind action is even more effective than water in separating and removing these fine particles. They to a very large extent escape mechanical attrition, because they are transported in suspension and are not swept along the ground or the bottom of the sea; hence they are mostly angular. Fragments of intermediate magnitudes (from $\frac{1}{16}$ of an inch to $\frac{1}{2}$ of an inch) are classed as sands. They consist largely of quartz, because it does not weather into scaly minerals like felspar, and having but a poor cleavage does not split up into flakes like mica or chlorite. These quartz grains have been rolled along and are usually rounded and worn (Pl. IV., fig. 1). More or less of garnet felspar, tourmaline, zircon, rutile, &c., are mixed with the quartz, because these are hard minerals not readily decomposed.

The mechanical sorting by the transporting agencies is usually somewhat incomplete, and mixed types of sediment result, such as gravels containing sand, or clays with coarser arenaceous particles. Moreover, successive layers of deposit may not always be entirely similar, and alternations of varying composition may follow one another in thin laminae: e.g. laminae of arenaceous material in beds of clay and shale. Organic matter is frequently mingled with the finer-grained sediments.

These three types have been named the psæphitic (or pebbly; Gr. ψῆφος, pebble), psammitic (or sandy, Gr. ψάσσω, sand), and pelitic (or muddy; Gr. πῆλος, mud).

Two groups of clastic sediments deserve special treatment. The pyroclastic (Gr. πῦρ, fire, and κλάσσειν, broken) rocks of volcanic origin, consist mostly of broken pieces of lava (bombs, ash, &c.) (Pl. IV., fig. 2), and only accidentally contain other rocks or fossils. They are stratified, and may be coarse or fine, but are usually much less perfectly sorted out, according to their fineness, than ordinary aqueous or aeolian deposits. The glacial clays (boulder clays), representing the ground moraines of ancient glaciers and ice sheets, are characterized by the very variable size of their ingredients and the striated, blunted sub-angular form of the larger rock fragments. In them stratification is exceptional and fossils are very rare.

The crystalline sedimentary rocks have been deposited from solution in water. The commonest types, such as rock-salt, gypsum, anhydrite, carnallite, are known to have arisen by the evaporation of enclosed saline lakes exposed to a dry atmosphere. They occur usually in beds with layers of red clay and marl; some limestones have been formed by calcareous waters containing carbonate of lime dissolved in an excess of carbonic acid; with the escape of the volatile gas the mineral matter is precipitated (sinters, *Sprudelstein*, &c.). Heated waters on cooling may yield up part of their dissolved mineral substances; thus silicious sinters are produced around geysers and hot springs in many parts of the world. There seems no reason to separate from these the veinstones which fill the fissures by which these waters rise to the surface. They differ from those above enumerated in being more perfectly crystallized and in having no definite stratification, but only a banding parallel to the more or less vertical walls of the fissure. Another subdivision of this class of rocks is due to recrystallization or crystalline replacement of pre-existing sediments. Thus limestones are dolomitized or converted into ironstones, flints and cherts, by percolating waters which remove the lime salts and substitute for them compounds of iron, magnesia, silica, and so on. This may be considered a kind of metamorphism; it is generally known as metasomatism (q.v.).

The rocks of organic origin may be due to animals or plants. They are of great importance, as limestones and coals belong to this group. They are the most fossiliferous of all rocks; but clastic sediments are often rich in fossils though crystalline sediments rarely are. They may be subdivided, according to their dominant components, into calcareous,

carbonaceous, siliceous, ferruginous, and so on. The calcareous organic rocks may consist principally of foraminifera, crinoids, corals, brachiopoda, mollusca, polyzoa, &c. Most of them, however, contain a mixture of organisms. By crystallization and metasomatic changes they often lose their organic structures; metamorphism of any kind has the same effect. The carbonaceous rocks are essentially plant deposits; they include peat, lignite and coal. The siliceous organic rocks include radiolarian and diatom oozes; in the older formations they occur as radiolarian cherts. Flint nodules owe their silica to disseminated fossils of this nature which have been dissolved and redeposited by concretionary action. Some kinds of siliceous sinter may be produced by organisms inhabiting hot silicified waters. Calcareous oolites in the same way may have arisen through the agency of minute plants. Bog iron ores also may be of organic rather than of merely chemical origin. The phosphatic rocks so extensively sought after as sources of fertilizing agents for use in agriculture are for the most part of organic origin, since they owe their substance to the remains of certain varieties of animals which secrete a phosphatic skeleton; but most of them no longer show organic structures but have been converted into nodular or concretionary forms.

All sediments are at first in an incoherent condition (e.g. sands, clays and gravels, beds of shells, &c.), and in this state they may remain for an indefinite period. Millions of years have elapsed since some of the early Tertiary strata gathered on the ocean floor, yet they are quite friable (e.g. the London Clay) and differ little from many recent accumulations. There are few exceptions, however, to the rule that with increasing age sedimentary rocks become more and more indurated, and the older they are the more likely it is that they will have the firm consistency generally implied in the term "rock." The pressure of newer sediments on underlying masses is apparently one cause of this change, though not in itself a very powerful one. More efficiency is generally ascribed to the action of percolating water, which takes up certain soluble materials and redeposits them in pores and cavities. This operation is probably accelerated by the increased pressure produced by superincumbent masses, and to some extent also by the rise of temperature which inevitably takes place in rocks buried to some depth beneath the surface. The rise of temperature, however, is never very great; we know more than one instance of sedimentary deposits which have been buried beneath four or five miles of similar strata (e.g. parts of the Old Red Sandstone), yet no perceptible difference in condition can be made out between beds of similar composition at the top of the series and near its base. The redeposited cementing material is most commonly calcareous or siliceous. Limestones, which were originally a loose accumulation of shells, corals, &c., become compacted into firm rock in this manner; and the process often takes place with surprising ease, as for example in the deeper parts of coral reefs, or even in wind-blown masses of shelly sand exposed merely to the action of rain. The cementing substance may be regularly deposited in crystalline continuity on the original grains, where these were crystalline; and even in sandstones (such as Kentish Rag) a crystalline matrix of calcite often envelops the sand grains. The change of aragonite to calcite and of calcite to dolomite, by forming new crystalline masses in the interior of the rock, usually also accelerates consolidation. Silica is less easily soluble in ordinary waters, but even this ingredient of rocks is dissolved and redeposited with great frequency. Many sandstones are held together by an infinitesimal amount of colloid or cryptocrystalline silica; when freshly dug from the quarry they are soft and easily trimmed, but after exposure to the air for some time they become much harder, as their siliceous cement sets and passes into a rigid condition. Others contain fine scales of kaolin or mica. Argillaceous materials may be compacted by mere pressure, like graphite and other scaly minerals. Oxides and carbonates of iron play a large part in many sedimentary rocks and are especially important as colouring matters. The red sands and limestones, for example, which are so abundant, contain small amounts of ferric oxide (haematite), which in a finely divided state gives a red hue of all rocks in which it is present. Limonite, on the other hand, makes rocks yellow or brown; oxides of manganese, asphalt and other carbonaceous substances are the cause of the black colour of many sediments. Bluish tints result sometimes from the presence of phosphates or fluorspar; while green is most frequently seen in rocks which contain glauconite or chlorite.

Metamorphic Rocks.—The metamorphic rocks, which form the third great subdivision, are even more varied than the igneous and the sedimentary. They include representatives of nearly all kinds of the other two classes, their common characteristic being that they have all undergone considerable alterations in structure or in mineral composition. The agencies of metamorphism (q.v.) are of two kinds—thermal and regional. In the former case contact with intrusive igneous masses, such as granite, laccolites or dikes, have indurated and recrystallized the original rock. In the second case the actions are more

complex and less clearly understood; it is evident that pressure and interstitial movement have had a powerful influence, possibly assisted by rise of temperature. In thermal or contact alteration the rocks are baked, indurated, and often in large measure recrystallized. In regional metamorphism recrystallization also goes on, but the final products are usually schists and gneisses. It is as a rule not difficult to distinguish the two classes of metamorphic rocks at a glance, and they may conveniently be considered separately.

When a rock is contact altered by an igneous intrusion it very frequently becomes harder, more crystalline and more lustrous, owing to the development of many small crystals in its mass. Many altered rocks of this type were formerly called hornstones, and the term *hornfels* (Ger. *Hornfels*) is often used by geologists to signify those fine grained, compact, crystalline products of thermal metamorphism. A shale becomes a dark argillaceous hornfels, full of tiny plates of brownish biotite; a marl or impure limestone changes to a grey, yellow or greenish lime-silicate-hornfels, tough and splintery, with abundance of augite, garnet, wollastonite and other minerals in which lime is an important component. A diabase or andesite becomes a diabase hornfels or andesite hornfels with a large development of new hornblende and biotite and a partial recrystallization of the original feldspar. A chert or flint becomes a finely crystalline quartz rock; sandstones lose their clastic structure and are converted into a mosaic of small close-fitting grains of quartz.

If the rock was originally banded or foliated (as, for example, a laminated sandstone or a foliated calc-schist) this character may not be obliterated, and a banded hornfels is the product; fossils even may have their shapes preserved, though entirely recrystallized, and in many contact altered lavas the steam cavities are still visible, though their contents have usually entered into new combinations to form minerals which were not originally present. The minute structures, however, disappear, often completely, if the thermal alteration is very profound; thus small grains of quartz in a shale are lost or blend with the surrounding particles of clay, and the fine ground-mass of lavas is entirely reconstructed.

By recrystallization in this manner peculiar rocks of very distinct types are often produced. Thus shales may pass into cordierite rocks, or may show large crystals of andalusite (and kyanite, Pl. IV, fig. 9), staurolite, garnet, kyanite and sillimanite. A considerable amount of mica (both muscovite and biotite) is simultaneously formed, and the resulting product has a close resemblance to many kinds of schist. Limestones, if pure, are often turned into coarsely crystalline marbles (Pl. IV, fig. 4); but if there was an admixture of clay or sand in the original rock such minerals as garnet, epidote, idocrase, wollastonite, will be present. Sandstones when greatly heated may change into coarse quartzites composed of large clear grains of quartz. These more intense stages of alteration are not so commonly seen in igneous rocks, possibly because their minerals, being formed at high temperatures, are not so easily transformed or recrystallized.

In a few cases rocks are fused and in the dark glassy product minute crystals of spinel, sillimanite and cordierite may separate out. Shales are occasionally thus altered by basalt dikes, and felspathic sandstones may be completely vitrified. Similar changes may be induced in shales by the burning of coal seams or even by an ordinary furnace.

There is also a tendency for interfusion of the igneous with the sedimentary rock. Granites may absorb fragments of shale or pieces of basalt. In that case hybrid rocks arise which have not the characters of normal igneous or sedimentary rocks. Such effects are scarce and are usually easily recognized. Sometimes an invading granite magma permeates the rocks around, filling their joints and planes of bedding, &c., with threads of quartz and feldspar. This is very exceptional, but instances of it are known and it may take place on a large scale.

The other type of metamorphism is often said to be regional; sometimes it is called dynamic, but these terms have not strictly the same connotation. It may be said as a rule to make the rock more crystalline and at the same time to give it a foliated, schistose or gneissic structure. This latter consists in a definite arrangement of the minerals, so that such as are platy or prismatic (e.g. mica and hornblende, which are very common in these rocks) have their longest axes arranged parallel to one another. For that reason many of these rocks split readily in one direction (schists). The minerals also tend to aggregate in bands; thus there are seams of quartz and of mica in a mica schist, very thin, but consisting essentially of one mineral. These seams are called folia (leaflets), and though never very pure or very persistent they give the rock a streaked or banded character when they are seen edgewise (Pl. IV, figs. 6, 7, 8). Along the folia composed of the soft or fissile minerals the rocks will sever most readily, and the freshly split specimen will appear to be faced or coated with this mineral; for example, a piece of mica schist looked at face wise might be supposed to consist entirely of shining scales of mica. On the edge of the specimen, however, the white folia of granular quartz

*Thermal
Metamorphism.*

*Regional
Metamorphism.*

will be visible. In gneisses these alternating folia are thicker and less regular than in schists; they are often lenticular, dying out rapidly. Gneisses also, as a rule, contain more felspar than schists do, and they are tougher and less fissile. Contortion or crumpling (Pl. IV. fig. 6) of the foliation is by no means uncommon, and then the splitting faces are undulose or puckered. The origin of schistosity or foliation is not perfectly understood, but it is clear that in many cases it is due to pressure, acting in a direction perpendicular to the banding, and to interstitial movement or internal flow arranging the mineral particles while they are crystallizing.

Rocks which were originally sedimentary and rocks which were undoubtedly igneous are converted into schists and gneisses, and if originally of similar composition they may be very difficult to distinguish from one another if the metamorphism has been great. A quartz-porphry, for example, and a fine felspathic sandstone, may both be converted into a grey or pink mica-schist. Usually, however, we may distinguish between sedimentary and igneous schists and gneisses. Often the metamorphism is progressive, and if the whole district occupied by these rocks be searched traces of bedding, of elastic structure, unconformability or other evidence may be obtained showing that we are dealing with a group of altered sediments. In other cases intrusive junctions, chilled edges, contact alteration or porphyritic structure may prove that in its original condition a metamorphic gneiss was an igneous rock. The last appeal is often to the chemist, for there are certain rock types which occur only as sediments, while others are found only among igneous masses, and, however advanced the metamorphism may be, it rarely modifies the chemical composition of the mass very greatly. Such rocks, for example, as limestones, calc-schists, dolomites, quartzites and aluminous shales have very definite chemical characters which distinguish them even when completely recrystallized.

The schists and gneisses are classified according to the minerals they consist of, and this depends principally on their chemical composition. We have, for example, a group of metamorphic limestones, marbles, calc-schists and cipolins, with crystalline dolomites; many of these contain silicates such as mica, tremolite, diopside, scapolite, quartz and felspar. They are derived from calcareous sediments of different degrees of purity. Another group is rich in quartz (quartzites, quartz schists and quartzose gneisses), with variable amounts of white and black mica, garnet, felspar, zoisite and hornblende. These were once sandstones and arenaceous rocks. The graphitic schists may readily be believed to represent sediments once containing coaly matter or plant remains; there are also schistose ironstones (haematite-schists), but metamorphic beds of salt or gypsum are exceedingly uncommon. Among schists of igneous origin we may mention the silky calc-schists, the foliated serpentines (once ultrabasic masses rich in olivine), and the white mica-schists, porphyroids and banded hallesintas, which have been derived from rhyolites, quartz-porphyrates and acid tufts. The majority of mica-schists, however, are altered clays and shales, and pass into the normal sedimentary rocks through various types of phyllite and mica-slates. They are among the most common metamorphic rocks; some of them are graphitic and others calcareous. The diversity in appearance and composition is very great, but they form a well-defined group not difficult to recognize, from the abundance of black and white mica and their thin, foliated, schistose character. As a special subgroup we have the andalusite-, staurolite-, kyanite- and sillimanite-schists, together with the cordierite-gneisses, which usually make their appearance in the vicinity of gneissose granites, and have presumably been affected by contact alteration. The more coarsely foliated gneisses are almost as frequent as the mica-schists, and present a great variety of types differing in composition and in appearance. They contain quartz, one or more varieties of felspar, and usually mica hornblende or augite, often garnet, iron oxides, &c. Hence in composition they resemble granite, differing principally in their foliated structure. Many of them have "augen" or large elliptical crystals, mostly felspar but sometimes quartz, which are the crushed remains of porphyritic minerals; the foliation of the matrix winds around these augen, closing in on each side. Most of these augen gneisses are metamorphic granites, but sometimes a conglomerate bed simulates a gneiss of this kind rather closely. There are other gneisses, which were derived from felspathic sandstones, grits, arkoses and sediments of that order; they mostly contain biotite and muscovite, but the hornblende and pyroxene gneisses are usually igneous rocks allied in composition to the hornblende-granites and quartz-diorites. The metamorphic forms of dolerite, basalt and the basic igneous rocks generally have a distinctive facies as their pyroxene and olivine are replaced by dark green hornblende, with often epidote, garnet and biotite. These rocks have a well developed foliation, as the prismatic hornblendes lie side by side in parallel arrangement. The majority of amphibolites, hornblende-schists, foliated epidiorites and green schists belong to this group. Where they are least altered they pass through chloritic schists into sheared diabases, felsez gabbros and other rocks in which remains of the original igneous minerals and structures occur in greater or less profusion.

BIBLIOGRAPHY.—Most text-books of geology treat of petrology in more or less detail (see GEOLOGY: § *Bibliography*). Elementary books on petrology include F. H. Hatch, *Petrology* (5th ed., London, 1909); L. V. Pirsson, *Rocks and Rock-minerals* (New York, 1908);

J. D. Dana, *Handbook of Mineralogy and Petrography* (12th ed., New York, 1908); A. Harker, *Petrology for Students* (4th ed., Cambridge, 1908); G. A. J. Cole, *Aids to Practical Geology* (6th ed., London, 1909). For rock minerals consult J. P. Iddings, *Rock Minerals* (New York, 1906); A. Johannsen, *Determination of Rock-forming Minerals* (New York, 1908); E. Hussak and E. G. Smith, *Determination of Rock-forming Minerals* (2nd ed., New York, 1893); N. H. and A. N. Winchell, *Optical Mineralogy* (New York, 1909). On the classification and origin of rocks see A. Harker, *Natural History of Igneous Rocks* (London, 1909); J. P. Iddings, *Igneous Rocks*, (New York, 1909); Cross, Iddings, Washington and Pirsson, *Quantitative Classification of Igneous Rocks* (Chicago, 1902); C. Van Hise, *Metamorphism* (Washington, 1904); A. P. Merrill, *Rocks, Rock-weathering and Soils* (London, 1897); C. Doelter, *Petrogenesis* (Brunswick, 1906); J. H. L. Vogt, *Silikatschmelzungen* (Christiania, 1903); F. Fouqué and A. Michel Lévy, *Synthese des minéraux et des roches* (Paris, 1882). The principal authorities on the analysis and chemical composition of rocks are J. Roth, *Beiträge zur Petrographie* (Berlin, 1873-1884); A. Osann, *Beiträge zur chemischen Petrographie* (Stuttgart, 1903); H. S. Washington, *Manual of the Chemical Analysis of Rocks* (New York, 1904) and *Chemical Analyses of Igneous Rocks* (Washington, 1904); F. W. Clarke, *Analyses of Rocks* (Washington, 1904); Max Dittrich, *Anleitung zur Gesteinsanalyse* (Leipzig, 1905); W. F. Hillsbrand, *Analysis of Silicate and Carbonate Rocks* (Washington, 1907). The great systematic treatises on Petrology are F. Zirkel, *Lehrbuch der Petrographie* (2nd ed., Leipzig, 1894, 3 vols.); H. Rosenbusch, *Mikroskopische Physiologie* (4th ed., Stuttgart, 1909, 2 vols.)

Useful German handbooks include: E. Weinschenk, *Polarisationsmikroskop, Gesteinsbildende Mineralien und Gesteinskunde* (2nd ed., Freiburg, 1907, &c.); R. Rosenbusch, *Petrographisches Praktikum* (2nd ed., Berlin, 1907); H. Theinisch, *Elemente der Gesteinslehre* (3rd ed., Stuttgart, 1909); A. Grubenmann, *Die kristallinen Schiefer* (Berlin, 1907); F. Loewisson Lessing, *Petrographisches Lexikon* (1893 and 1898, also a Fr. ed., 1901); F. Rinne, *Praktische Gesteinskunde* (2nd ed., Hanover, 1905).

The principal French works are E. Jannettaz, *Les Roches* (3rd ed., Paris, 1900); F. Fouqué and A. Michel Lévy, *Minéralogie micrographique* (Paris, 1879); A. Michel Lévy and A. Lacroix, *Les Minéraux des roches* (Paris, 1888); A. Lacroix, *Minéralogie de la France* (I., II., Paris, 1893); and *Les Enclaves des roches éruptives* (Macon, 1893).

British petrography is the subject of a special work by J. J. H. Teall (London, 1888). Much information about rocks is contained in the memoirs of the various geological surveys, and in *Quart. Journ. of the Geol. Soc. of London*, *Mineralogical Magazine*, *Geological Magazine*, *Tschermak's Mineralogische Mittheilungen* (Vienna), *Neues Jahrbuch für Mineralogie* (Stuttgart), *Journal of Geology* (Chicago), &c. (J. S. F.)

PETRONEL, a 16th or 17th century fire-arm, defined by R. Barret (*Theorie and Practike of Modern Warres*, 1598) as a "horseman's peccet." It was the fire-arm which developed on the one hand into the pistol and on the other into the carbine. The name (Fr. *petrinel* for *poitrinal*) was given to the weapon either because it was fired with the butt resting against the chest (*poitrine*, Lat. *pectus*) or because it was carried slung from a belt across the chest.

PETRONIUS (G. ?) Petronius Arbitrator, Roman writer of the Neronian age. His own work, the *Satirae*, tells us nothing directly of his fortunes, position, or even country. Some lines of Sidonius Apollinaris refer to him and are often taken to imply that he lived and wrote at Marseilles. If, however, we accept the identification of this author with the Petronius of Tacitus, Nero's courtier, we must suppose either that Marseilles was his birthplace or, as is more likely, that Sidonius refers to the novel itself and that its scene was partly laid at Marseilles. The chief personages of the story are evidently strangers in the towns of southern Italy where we find them. Their Greek-sounding names (Encolpius, Ascyltus, Giton, &c.) and literary training accord with the characteristics of the old Greek colony in the 1st century A.D. The high position among Latin writers ascribed by Sidonius to Petronius, and the mention of him beside Menander by Macrobius, when compared with the absolute silence of Quintilian, Juvenal and Martial, seem adverse to the opinion that the *Satirae* was a work of the age of Nero. But Quintilian was concerned with writers who could be turned to use in the

¹ The MSS. of the *Satirae* give no praenomen. Tacitus's Petronius is Gaius, though the elder Pliny and Plutarch call him Titus. The name Arbitrator, given him by later writers, is not an ordinary cognomen; it may have been bestowed on him by contemporaries from the fact that his judgment was regarded as the criterion of good taste.

education of an orator. The silence of Juvenal and Martial may be accidental or it is possible that a work so abnormal in form and substance was more highly prized by later generations than by the author's contemporaries.

A comparison of the impression the book gives us of the character and genius of its author with the elaborate picture of the courtier in Tacitus certainly suggests the identity of the two. Tacitus, it is true, mentions no important work as the composition of his C. Petronius; such a work as the *Satirae* he may have regarded as beneath that dignity of history which he so proudly realized. The care he gives to Petronius's portrait perhaps shows that the man enjoyed greater notoriety than was due merely to the part he played in history. "He spent his days in sleep, his nights in attending to his official duties or in amusement, by his dissolute life he had become as famous as other men by a life of energy, and he was regarded as no ordinary profligate, but as an accomplished voluptuary. His reckless freedom of speech, being regarded as frankness, procured him popularity. Yet during his provincial governorship, and later when he held the office of consul, he had shown vigour and capacity for affairs. Afterwards returning to his life of vicious indulgence, he became one of the chosen circle of Nero's intimates, and was looked upon as an absolute authority on questions of taste (*arbiter elegantiae*) in connexion with the science of luxurious living."¹ Tacitus goes on to say that this excited the jealousy of Tigellinus, an accusation followed, and Petronius committed suicide in a way that was in keeping with his life and character. He selected the slow process of opening veins and having them bound up again, whilst he conversed on light and trifling topics with his friends. He then dined luxuriously, slept for some time, and, so far from adopting the common practice of flattering Nero or Tigellinus in his will, wrote and sent under seal to Nero a document which professed to give, with the names of his partners, a detailed account of the abominations which that emperor had practised.

A fact confirmatory of the general truth of this graphic portrait is added by the elder Pliny, who mentions that just before his death he destroyed a valuable murrhine vase to prevent its falling into the imperial hands. Do the traits of this picture agree with that impression of himself which the author of the *Satirae* has left upon his work? That we possess therein part of the document sent to Nero is an impossible theory. Our fragments profess to be extracts from the fifteenth and sixteenth books of the *Satirae*: Petronius could not have composed one-tenth even of what we have in the time in which he is said to have composed his memorial to Nero. We may be sure too that the latter was very frank in its language, and treated Nero with far greater severity than the *Banquet* treats Trimalchio. On the other hand, it is clear that the creator of Trimalchio, Encolpius and Giton had the experience, the inclinations and the literary gifts which would enable him to describe with forcible mockery the debaucheries of Nero. And the impression of his personality does in another respect correspond closely with the Petronius of the *Annals*—in the union of immoral sensualism with a rich vein of cynical humour and admirable taste.

The style of the work, where it does not purposely reproduce the solecisms and colloquialisms of the vulgar rich, is of the purest Latin of the Silver age.² Nor would there be any point in the verses on the capture of Troy and the Civil War at any

¹ *Ann.* xvi. 18.

² The false taste in literature and expression fostered by the *declamations* is condemned by both Persius and Petronius on the same grounds. Cf. too Pers. l. 121, *hoc ego apertum, hoc ridere meum, iam mihi, nulla tibi uento Iliade* with *Sat.* 52, *meum intellegere nulla pecunia uendo*; Pers. ii. 9, *O si ebulliat patrum, praetorum fauus, et e si sub rasro crepat argenti mihi seris* with *Sat.* 88, *Alius domum promittit, si propinquum digne extulerit, alius si thesaurum effoderit* and 42, *honor ebulliam ebullit*; Pers. iv. 26, *ardet quantum non minus oberrat* with *Sat.* 37, *fundus habet quae mihi uolant*. Both use the rare word *hara*. A *numquam ebullire* occurs in Seneca's *Apocolocyntosis*, and the verbal resemblances illustrate perhaps rather the common use by both writers of the vulgar style. Cf. for resemblances to the style of the younger Seneca and the date of the work in general, Seuder, *Rh. Mus.* (1843).

other era than that in which Nero's *Troica* and Lucan's *Pharsalia* were fashionable poems. The reciting poet indeed is a feature of a later age also, as we learn from Martial and Juvenal. But we know from Tacitus that the luxury of the table, so conspicuous in Trimalchio's *Banquet*, fell out of fashion after Nero (*Ann.* 3. 55).

Of the work itself there have been preserved 141 sections of a narrative, in the main consecutive, although interrupted by frequent gaps. The name *Satirae*, given in the best MSS., implies that it belongs to the type to which Varro, imitating the Greek Menippus, had given the character of a medley of prose and verse composition. But the string of fictitious narrative by which the medley is held together is something quite new in Roman literature. This careless prodigal was so happily inspired in his devices for amusing himself as to introduce to Rome and thereby transmit to modern times the novel based on the ordinary experience of contemporary life³—the precursor of such novels as *Gil Blas* and *Roderick Random*. There is no evidence of the existence of a regular plot in the fragments, but we find one central figure, Encolpius, who professes to narrate his adventures and describe all that he saw and heard, whilst allowing various other personages to exhibit their peculiarities and express their opinions dramatically.

The fragment opens with the appearance of the hero, Encolpius, who seems to be an itinerant lecturer travelling with a companion named Ascyllus and a boy Giton, in a portico of a Greek town, in Campania. An admirable lecture on the false taste in literature, resulting from the prevailing system of education, is replied to by a rival declaimer, Agamemmo, who shifts the blame from the teachers to the parents. The central personages of the story next go through a series of questionable adventures, in the course of which they are involved in a charge of robbery. A day or two after they are present at a dinner given by a freedman of enormous wealth, Trimalchio, who entertained with ostentations and grotesque extravagance a number of men of his own rank but less prosperous. We listen to the ordinary talk of the guests about their neighbours, about the weather, about the hard times, about the public games, about the education of their children. We recognize in an extravagant form the same kind of vulgarity and pretension which the satirist of all times delights to expose in the illiterate and ostentatious millionaires of the age. Next day Encolpius separates from his companions in a fit of jealousy, and, after two or three days' sulking and brooding on his revenge, enters a picture gallery, where he meets with an old poet, who, after talking sensibly on the decay of art and the inferiority of the painters of the age to the old masters, proceeds to illustrate a picture of the capture of Troy by some verses on that theme. This ends in those who are walking in the adjoining colonnade driving him out with stones. The scene is next on board ship, where Encolpius finds he has fallen into the hands of some old enemies. They are shipwrecked, and Encolpius, Giton and the old poet get to shore in the neighbourhood of Crotona, where, as the inhabitants are notorious fortune-hunters, the adventurers set up as men of fortune. The fragment ends with a new set of questionable adventures, in which prominent parts are played by a beautiful enchantress named Circe, a priestess of Priapus, and a certain matron who leaves them her heirs, but attaches a condition to the inheritance which even Encolpius might have shrunk from fulfilling.⁴ If we can suppose the author of this work to have been animated by any other motive than the desire to amuse himself, it might be that of convincing himself that the world in general was as bad as he was himself. Juvenal and Swift are justly regarded as among the very greatest of satirists, and their estimate of human nature is perhaps nearly as unfavourable as that of Petronius; but their attitude towards human degradation is not one of complacent amusement; their realism is the realism of disgust, not, like that of Petronius, a realism of sympathy. Martial does not gloat over the vices of which he writes with cynical frankness. He is perfectly aware that they are vices, and that the reproach of them is the worst that can be cast on any one. And, further, Martial, with all his faults, is, in his affections, his tastes, his relations to others, essentially human, friendly, generous, true. There is perhaps not a single sentence in Petronius which implies any knowledge of or sympathy with the existence of affection, conscience or honour, or even the most elementary goodness of heart.

³ For the whole question of possible predecessors and Petronius's relation to the extant Greek romances see W. Schmid, "Der griechische Roman" in *Jahrbücher für das klass. Altertum*, &c. (1904). One would certainly have expected the realistic tendency which appears in the New Comedy, the *Characters* of Theophrastus and the Mimes, to have borne this fruit before the first century of our era.—(W. C. Su.)

⁴ Omnes qui in testamento meo legata habent praeter libertos meos, hac conditione percipient quae dedi, si corpus meum in partes conciderint et astante populo comederint (141).

The work has reached us in so fragmentary and mutilated a shape that we may of course altogether have missed the key to it; it may have been intended by its author to be a sustained satire, written in a vein of reserved and powerful irony, of the type realized in our modern *Jonathan Wild* or *Barry Lyndon*. Otherwise we must admit that, in the entire divorce of intellectual power and insight from any element of right human feeling, the work is an exceptional phenomenon in literature. For, as a work of original power, of humorous representation, of literary invention and art, the fragment deserves all the admiration which it has received. We recognize the *arbitrio elegantias* in the admirable sense of the remarks scattered through it on education, on art, on poetry and on eloquence. There is a true feeling of nature in the description of a grove of plane-trees, cypresses and pines:

"Has inter ludebat aquis errantibus amnis,
Spumeus et querulo vexabat rore lapillos."

And some of the shorter pieces anticipate the terseness and elegance of Martial. The long fragment on the Civil War does not seem to be written so much with the view of parodying as of entering into rivalry with the poem of Lucan. In the epigram extemporized by Trimalchio late on in the banquet:

"Quod non expectes, ex transverso fit—
Et supra nos Fortuna negotia curat,
Quare da nobis vina Falerna, purat."

we have probably a more deliberate parody of the style of verses produced by the illiterate aspirants to be in the fashion of the day. We might conjecture that the chief gift to which Petronius owed his social and his literary success was that of humorous mimicry. In Trimalchio and his various guests, in the old poet, in the cultivated, depraved and moody Encolpius, in the Chrysis, Quartilla, Polyænæ, &c., we recognize in living examples the play of those various appetites, passions and tendencies which satirists deal with as abstract qualities. Another gift he possesses in a high degree, which must have availed him in society as well as in literature—the gift of story-telling; and some of the stories which first appear in the *Satiræ*—e.g. that of the Matron of Ephesus—have enjoyed a great reputation in later times. His style, too, is that of an excellent talker, who could have discussed questions of taste and literature with the most cultivated men of any time as well as amused the most dissolute society of any time in their most reckless revels. One phrase of his is often quoted by many who have never come upon it in its original context, "Horatii curiosa felicitas."

AUTHORITIES.—Until about 1650 only part of the Banquet of Trimalchio, with the other fragments of the work, was known. The best MS. of this type is a Leiden MS., a copy by Scaliger of one which seems to have belonged to Cujacius. Marinus Stautilius (see, however, Ellis, *Journal of Philology*, 12, p. 266) discovered at Trau in Dalmatia a MS. containing the whole Banquet, which was first published at Padua in 1664.

The important editions are (1) with explanatory notes: Burmann (Amsterdam, 1743, with Heinsius's notes), and of the *Cena* only, Friedländer (Leipzig, 2nd ed., 1906) and Lowe (Cambridge, 1904); (2) with critical notes: Bücheler (Berlin, 1862, 4th ed., 1904). Translations into German in Friedländer's edition (*Cena* only), into French by de Guerle (complete, in Garnier's *Bibliothèque*), into English in Lowe's edition (*Cena* only) and Bohn's series (complete). Lexicon to Petronius by Segebade and Lommatsch (Leipzig, 1898). Criticism, &c., in Haley, "Quæst. Petron." (*Harvard Studies*, 1891); Collignon, *Étude sur Pétrone* (Paris, 1892); Emile Thomas, *L'Envers de la société romaine d'après Pétrone* (Paris, 1892); Hirzel, *Der Dialog*, ii. (Leipzig, 1895); Tyrrell, *Latin Poetry* (London, 1895); Norden, *Antike Kunstprosa* i. (Leipzig, 1898); Henderson, *Life and Principate of the Emperor Nero* (London, 1903); Dill, *Roman Society from Nero to Marcus Aurelius* (London, 1905); and the various histories of Roman literature (especially Schanz, §§ 395-399). (W. Y. S.; W. C. Su.).

PETROPAVLOVSK, a town of West Siberia, in the government of Akmolinsk, on the right bank of the Ishim river, and on the great Siberian highway, 170 m. by rail W. of Omsk. The population, 7850 in 1865, was 21,796 in 1900, of whom one-third were Mahomedan Kirghiz. The town carries on an active trade in cattle, furs, tea, wool, skins, cottons, woollen stuffs, corn, metals, metallic wares and spirits. The small fort of Petropavlovsk was founded in 1752, and was the military centre of the Ishim line of fortifications.

PETROPAVLOVSK is also the name of a Russian seaport in Kamchatka, on the eastern shore of the Bay of Avacha, in 53° N. and 158° 44' E. Its harbour, one of the best on the Pacific, is little used, and the town consists merely of a few huts with some 400 inhabitants. Its naval institutions were transferred to Nikolayevsk after the attack of the Anglo-French fleet in 1854.

PETROPOLIS, a city of the state of Rio de Janeiro, Brazil, in an elevated valley of the Serra de Estrella, 2634 ft. above sea-level and 27 m. N. of the city of Rio de Janeiro, with which it is connected by a combined railway and steamship line, and

also by a longer railway line. Pop. of the municipality (1900), 20,331, a large percentage being summer residents, as the census was taken late in December; (1902, municipal census), 18,373. Petropolis is served by the Príncipe do Grão Pará railway, now a part of the Leopoldina system, which connects with Rio de Janeiro and Nictheroy on the coast, and with the station of Entre Rios on the Central of Brazil railway. Its altitude gives the city a cool invigorating climate, making it a favourite summer residence for the well-to-do classes of Rio. The rainfall is abundant, and especially so in summer (December to March) when the humidity is extreme. Vegetation is luxuriant and comprises a great variety of tropical and sub-tropical species. The city is built in a large, irregularly shaped basin formed by streams which converge to form the Piabanha river, a tributary of the Parahyba do Sul. Among the public buildings are the old imperial palace, a modern summer residence of the national executive and a municipal hall. Although Petropolis is not a commercial centre, its water-power and cool climate are making it an important manufacturing town. Among the products are cotton fabrics and garments, beer, and Camembert and Brie cheeses.

Petropolis was founded in 1845 by Julius Frederick Köler under the auspices of the emperor of Brazil, Dom Pedro II., on lands purchased by his father, Dom Pedro I., in 1822. The place was previously known as Corrego Secco, which Dr George Gardner described in 1837 as "a small, miserable village." The first emperor planned to establish there a German colony, but the plan was not realized until 1845, when about 2700 colonists from Germany were located there. Its growth was slow, but the choice of the place by the emperor as a summer residence drew thither many of the wealthy residents of the capital. The Mauá railway was opened to the foot of the *serra* (Rais da Serra) in 1854, and the macadamized road up the *serra* to the town in 1856. The mountain section of the railway, on the Riggenbach system, was completed in 1883. Petropolis has since become the summer residence of the diplomatic corps and of the higher officials of the Federal government, and was the capital of the state of Rio de Janeiro from 1893 to 1903.

PETROVSK, a seaport of Russia in Transcaucasia, on the Caspian Sea, in the province of Daghestan, 180 m. by rail E. of Vladikavkaz, and 235 m. N.W. from Baku. Pop. 9806. The town has become the port of embarkation for Krasnovodsk, the Transcaspien territory, and the Central Asian khanates. There are naphtha wells; and the hot sulphur baths at Ak-gol and Talga, close by, attract many visitors in summer.

PETROVSK, a town of eastern Russia, in the government of Saratov, on the Medveditsa, a tributary of the Don, 60 m. N.W. of the town of Saratov. Pop. (1864), 10,128; (1897), 13,212. It was founded by Peter the Great in 1708 as a defence against the Kuban Tatars. Its industrial establishments include distilleries, tanneries, tallow and brickworks.

PETROZAVODSK, a town and episcopal see of Russia, capital of the government of Olonets, on the west shore of Lake Onega, 190 m. N.E. of St Petersburg. Pop. (1865), 11,027; (1897), 12,521. Two cathedrals, built towards the end of the 18th century, a mining school, an ecclesiastical seminary and a government cannon-foundry are the chief public buildings and institutions. Peter the Great founded ironworks here in 1703, but they continued in operation only twenty-four years. The cannon-foundry was instituted in 1774. Petrozavodsk became the capital of the government of Olonets in 1802.

PETRUCCI, PANDOLFO (d. 1512), tyrant of Siena, spent the greater part of his youth in exile, on account of the civil strife by which his native town of Siena was torn; but on the triumph of the party of the *Noveschi* (those who supported the Council of Nine) in 1487 he was able to return home. On the death of his brother Giacomo, one of the most powerful men in the city, Pandolfo succeeded to all the latter's offices and emoluments (1497), thus becoming in fact if not in name master of Siena. By his marriage with Aurelia, daughter of Nicola Borghese, another very influential citizen, he still further strengthened his authority. But he soon began to abuse his power by selling public offices to

the highest bidders, or conferring them on his followers. A plot was made to murder him, but he discovered the conspiracy in time, and his own father-in-law, who had been leader of the movement, was put to death. In 1498 he prevented the outbreak of war with Florence over the possession of Montepulciano, which had been a bone of contention between the two cities for over a hundred years. His attitude towards Cesare Borgia was exceedingly astute; at first he assisted him, and obtained from him with the favour of the French king the cession of Piombino; but having subsequently aroused the suspicions of Borgia, the latter attempted to suppress Petrucci by inviting him to the fatal meeting of Senigallia. The Senese tyrant, however, did not fall into the trap, and although Borgia in 1502 obliged him to quit Siena, he returned two months later, more powerful than before. Petrucci supported Pisa in the war against Florence, but eventually, through the intervention of the pope and of the king of Spain, he made peace with the latter city, to which he gave back Montepulciano in 1512. As a reward for this action Pope Julius II. created his nephew cardinal. During his last days Petrucci abdicated his authority in favour of his son Borghese. He died at San Quirico di Osenna on the 21st of May 1512.

See Pecci, *Memorie storico-critiche di Siena* (Siena, 1755); U. G. Mondolfo, *P. Petrucci signore di Siena* (Siena, 1899).

PETRUS AUREOLUS (ORIO), scholastic philosopher and monk of the Franciscan order, lived in the latter half of the 13th century, and died in Paris in 1321 just after his appointment as archbishop of Aix. He was one of the first to attack the realist doctrines of Duns Scotus, and is interesting mainly as the precursor of William of Occam in his revival of Nominalism. His ability earned for him the titles of *Doctor Facundus* and *Doctor Abundans*.

PETTENKOFEN, AUGUST VON (1821-1889), Austrian painter, born in Vienna, was brought up on his father's estate in Galicia. Having decided to give up the military career on which he had started, he devoted himself to painting, taking for his subjects the simple scenes of the life on the dreary Puszta. His paintings are treasured for their fine qualities of colour, and for the sincerity with which the artist sets before us the uneventful melancholy life of Hungarian peasants and gipsies—without any theatrical pathos or forced humour. He was the inventor of the Pettenkofen box, an appliance for dissolving and redistributing cracked or discoloured varnish without friction or the dangerous use of chemicals. He died in Vienna in 1889.

PETTENKOFER, MAX JOSEPH VON (1818-1901), Bavarian chemist and hygienist, was born on the 3rd of December 1818 at Lichtenheim, near Neuburg. He was a nephew of Franz Xaver Pettenkofer (1783-1850), who from 1823 was surgeon and apothecary to the Bavarian court and was the author of some chemical investigations on the vegetable alkaloids. He studied pharmacy and medicine at Munich, where he graduated M.D. in 1843, and after working under Liebig at Giessen was appointed chemist to the Munich mint in 1845. Two years later he was chosen extraordinary professor of chemistry in the medical faculty, in 1853 he received the ordinary professorship, and in 1865 he became also professor of hygiene. In 1894 he retired from active work, and on the 10th of February 1901 he shot himself in a fit of depression at his home on the Starnberger See, near Munich. In his earlier years he devoted himself to chemistry, both theoretical and applied, publishing papers on the preparation of gold and platinum, numerical relations between the atomic weights of analogous elements, the formation of aventurin glass, the manufacture of illuminating gas from wood, the preservation of oil-paintings, &c. The reaction known by his name for the detection of bile acids was published in 1844. In his widely used method for the quantitative determination of carbonic acid the gaseous mixture is shaken up with baryta or lime water of known strength and the change in alkalinity ascertained by means of oxalic acid. But his name is most familiar in connexion with his work in practical hygiene, as an apostle of good water, fresh air and proper sewage disposal. His attention was drawn to this subject about 1850 by the unhealthy condition of Munich.

Pettenkofer gave vigorous expression to his views on hygiene and disease in numerous books and papers; he was an editor of the *Zeitschrift für Biologie* from 1865 to 1882, and of the *Archiv für Hygiene* from 1883 to 1894.

PETTICOAT, an underskirt, as part of a woman's dress. The petticoat, *i.e.* "petty-coat" or small coat, was originally a short garment for the upper part of the body worn under an outer dress; in the *Promptorium parvulorum* the Latin equivalent is *tunicula*. It was both a man's and a woman's garment, and was in the first case worn as a small coat under the doublet, and by women apparently as a kind of chemise. It was, however, early applied to the skirt worn by women hanging from the waist, whether as the principal lower garment or as an underskirt. In the middle of the 17th century the wide breeches with heavy lace or embroidered ends worn by men were known as "petticoat breeches," a term also applied to the loose canvas or oilskin overalls worn by fishermen.

PETTIE, JOHN (1839-1893), Scottish painter, was born in Edinburgh on the 17th of March 1839, the son of Alexander and Alison Pettie. In 1852 the family removed to East Linton, Haddingtonshire, and a portrait by the lad of the village carrier and his donkey overcame his father's objections to art as a career for his son. When sixteen he entered the Trustees' Academy in Edinburgh, working under Robert Scott Lauder with W. Q. Orchardson, J. MacWhirter, W. M'Taggart, Peter Graham, Tom Graham and G. P. Chalmers. His first exhibits at the Royal Scottish Academy were "A Scene from the Fortunes of Nigel"—one of the many subjects for which he sought inspiration in the novels of Sir Walter Scott—and two portraits in 1858, followed in 1859 by "The Prison Pet." To the Royal Academy in 1866 he sent "The Armourers"; and the success of this work and of "What d'ye Lack, Madam?" in the following year, encouraged him to settle in London (1862), where he joined Orchardson. In 1866 he was elected an Associate of the Royal Academy, and in 1874 received full academical honours in succession to Sir Edwin Landseer. His diploma picture was "Jacobites, 1745." Pettie was a hard and rapid worker, and, in his best days, a colourist of a high order and a brilliant executant. In his early days he produced a certain amount of book illustration. His connexion with *Good Words* began in 1861, and was continued till 1864. With J. MacWhirter he illustrated *The Postman's Bag* (Strahan, 1862), and Wordsworth's *Poetry for the Young* (Strahan, 1863). His principal paintings, in addition to those already mentioned, are "Cromwell's Saints" (1862); "The Trio" (1863); "George Fox refusing to take the Oath" (1864); "A Drumhead Court-martial" (1865); "The Arrest for Witchcraft" (1866); "Treason" (1867, now in the Mappin Art Gallery, Sheffield); "Tussle with a Highland Smuggler" (1868); "The Sally" (1870); "Terms to the Besieged" (1872); "The Flag of Truce" (1873); "Ho! Ho! Old Noll" and "A State Secret" (1874); "A Sword and Dagger Fight" (1877); "The Death Warrant" (1879); "Monmouth and James II." (1882); "The Vigil" (1884, in the Chantry Collection, National Gallery of British Art); "Challenged" (1885); "The Chieftain's Candlesticks" (1886); "Two Strings to Her Bow" (1887); "The Traitor" and "Sir Charles Wyndham as David Garrick" (1888); and "The Ultimatum" and "Bonnie Prince Charlie" (1892). Pettie died at Hastings on the 21st of February 1893. In 1894 a selection of his work was included in the Winter Exhibition of the Royal Academy. His portrait by himself is in the Tate Gallery.

John Pettie, R.A. (London, 1908), by his nephew Martin Hardie, gives the story of his life, a catalogue of his pictures, and fifty reproductions in colours.

PETTY, SIR WILLIAM (1623-1687), English statistician and political economist, born on the 26th of May 1623, was the son of a clothier at Romsey in Hampshire, and received his early education at the grammar school there. About the age of fifteen he went to Caen (Normandy), taking with him a little stock of merchandise, on which he traded, and so maintained himself whilst learning French, improving himself in Latin and Greek, and studying mathematics and other sciences. On his return to England he seems to have had for a short time a place

in the royal navy. He went abroad again in 1643, and remained for three years in France and the Netherlands, pursuing his studies. In Paris he read Vesalius with Hobbes, who was then preparing his *Treatatus opticus*, and it is said that Petty drew the diagrams for him. In 1647 Petty obtained a patent for the invention of double writing, *i.e.* a copying machine. In politics he espoused the side of the parliament. His first publication was a letter to Samuel Hartlib in 1648, entitled *Advice for the Advancement of some Particular Parts of Learning*, the object of which was to recommend such a change in education as would give it a more practical character. In the same year he took up his residence at Oxford, where he was made deputy professor of anatomy, and where he gave instruction in that science and in chemistry. In 1649 he obtained the degree of doctor of physic, and was soon after elected a fellow of Brasenose College. He gained some notoriety in 1650 by restoring to life a woman who had been hanged for infanticide. In 1651 he was made professor of anatomy at Oxford, and also became professor of music at Gresham College. In 1652 he went to Ireland, having been appointed physician to the army in that country. In 1654, observing that the admeasurements and division of the lands forfeited in 1641 and granted to the soldiers had been "most inefficiently and absurdly managed," he entered into a contract to execute a fresh survey, which he completed in thirteen months. By this he gained £9000, and part of the money he invested profitably in the purchase of soldiers' debentures. He thus became possessor of so large a domain in the county of Kerry that, according to John Aubrey, he could behold from Mt Mangerton 50,000 acres of his own land. He set up iron-works in that neighbourhood, opened lead-mines and marble-quarries, established a pilchard fishery, and commenced a trade in timber. Besides the office of commissioner of distribution of the lands he had surveyed, he held that of secretary to the lord-lieutenant, Henry Cromwell, and was also during two years clerk of the council. In January 1658 he was elected to Richard Cromwell's parliament as member for West Looe in Cornwall. After the Restoration he returned to England and was favourably received and knighted by Charles II., who was "much pleased with his ingenious discourses," and who, it is said, intended to create him earl of Kilmore. He obtained from the king a new patent constituting him surveyor-general of Ireland. In 1663 he attracted much notice by the success of his invention of a double-bottomed ship, which twice made the passage between Dublin and Holyhead, but was afterwards lost in a violent storm. He was one of the first members of the Royal Society, and sat on its council. He died in London on the 16th of December 1687, and was buried in the church of his native place. His will, a curious and characteristic document, is printed in Chalmers's *Biographical Dictionary*.

His widow, Elizabeth (d. 1708), daughter of Sir Hardress Waller (1604-1666), the Irish Cromwellian soldier and regicide, was created Baroness Shelburne by James II. in 1688; and her two sons were successively created earls of Shelburne, but on their death without issue the Petty estates passed to their sister, Anne, and after her marriage to the 1st earl of Kerry the Shelburne title was revived in her son's favour (see under LANSDOWNE, 1st MARQUESS).

Petty's Irish survey was based on a collection of social data which entitles him to be considered a real pioneer in the science of comparative statistics. He was also one of the first in whom we find a tendency to a view of industrial phenomena which was at variance with the then dominant mercantilist ideas, and he exhibits a statesmanlike sense of the elements in which the strength of a nation really consists. Roscher names him as having, along with Locke and Dudley North, raised the English school to the highest point it attained before the time of Hume.

The survey executed by Petty was, somewhat whimsically, called the "Down Survey" because the results were set down in maps; it is called by that name in Petty's will. He left in MS. a full account of the proceedings in connexion with it, which was edited by Sir Thomas A. Larcom for the Irish Archaeological Society in 1851. The maps, some of which were injured by a fire in 1711, are preserved in the Public Record Office, Dublin.

XL1. 6*

His *Treatise of Taxes and Contributions* contains a clear statement of the doctrine that price depends on the labour necessary for production. Petty is much concerned to discover a fixed unit of value, and he thinks he has found it in the necessary sustenance of a man for a day. He understands the cheapening effect of the division of labour. He states correctly the notion of "natural and true" rent as the remainder of the produce of land after payment of the cost of production; but he seems to have no idea of the "law of diminishing returns." He has much that is just on the subject of money: he sees that there may be an excess of it as well as a deficiency, and regards the prohibition of its exportation as contrary to sound policy. But he errs in attributing the fall of the rate of interest which takes place in the progress of industry to the increase in the quantity of money. He protested against the fetters imposed on the trade of Ireland, and advocated a union of that country with Great Britain. Whilst the general tendency in his day was to represent England as in a state of progressive decline—an opinion put forward particularly in the tract entitled *Britannia languens*—Petty declared her resources and prospects to be not inferior to those of France.

A complete list of his works is given in the *Athenae oxonienses*. The most important are: the *Treatise of Taxes and Contributions* (1662, 1667 and 1685); *Political Arithmetic*, presented in MS. to Charles II., but, because it contained matter likely to be offensive to France, kept unpublished till 1691, when it was edited by Petty's son Charles; *Quantulumcunque, or a Tract concerning Money* (1682); *Observations upon the Dublin Bills of Mortality in 1681 and the State of that City* (1683); *Essay concerning the Multiplication of Mankind* (1686); *Political Anatomy of Ireland* (1691). Several papers appeared in the *Philosophical Transactions*. See *Economic Writings of Sir William Petty*, ed. C. H. Hull (2 vols., 1899).

PETTY-OFFICER, the title in the navy of a large number of minor (Fr. *peuil*, small) officers, of less than commissioned or warrant rank—such as the master-at-arms, sailmaker, caulker, armourer, cook, &c. They were originally named, and removable, by the captain.

PETUNIA, in botany, a genus of plants belonging to the natural order Solanaceae and containing about 16 species, chiefly South American (southern Brazil and Argentina). The garden forms are derived from the white-flowered *P. nyclaginiiflora* and the violet- or purple-flowered *P. violacea*. The varieties of petunia, especially the double forms, make admirable specimens for pot culture.

Named or specially fine varieties are propagated by cuttings taken from stock plants kept through the winter on a dry warm shelf, and moved into a brisk moist heat in early spring; the young shoots are planted in pans or pots filled with sandy soil, and, aided by a brisk bottom heat, strike root in a few days. They are then potted singly into thumb-pots, and when once established are gradually hardened off, and afterwards repotted as required. The shoots should be topped to make bushy plants, and their tops may be utilized as cuttings. The single varieties are raised from seeds sown in light sandy soil in heat, in the early spring, and very slightly covered. The plants need to be pricked out or potted off as soon as large enough to handle. Good strains of seeds supply plants suitable for bedding; but, as they do not reproduce themselves exactly, any sorts particularly required must be propagated, like the double ones, from cuttings.

PETWORTH, a market town in the Horsham parliamentary division of Sussex, England, 55 m. S.S.W. from London by the London, Brighton & South Coast railway. Pop. (1901), 2503. The church of St Mary is Perpendicular, and contains numerous memorials of members of the Percy family and others. Petworth House, situated in a beautiful park, dates from the 18th century, and contains a magnificent collection of pictures. At Bignor in the neighbourhood are remains of an important and splendidly adorned Roman villa.

The first mention of Petworth (Peartingawyrth, Peteorde, Puetewird, Pedewurde, Puteeworth, Pytteworth, Petteworth) occurs in a grant by Eardwulf, king of Northumbria, to St Peter's Church, about 701. In the time of Edward the Confessor Petworth was an allodial manor held by his queen Edith, and in 1086 Robert Fitz-Tetbald held it of Roger Montgomery, earl of Shrewsbury. It then included a church and a mill, and was rated at nine hides. Through Queen Adella, Petworth came first into the hands of

her steward, Reginald de Wyndsor, and was afterwards given to her brother Josceline, who held it of the honour of Arundel. Josceline married Agnes de Percy and assumed the surname of Percy. The honour and manor of Petworth followed the descent of this family until 1708. In 1377 Henry Percy was created earl of Northumberland. The only daughter of the last earl married Charles, duke of Somerset, in 1682, and Petworth descended through their daughter Catherine to the earls of Egremont. The adopted son of the third earl was created Baron Leonfield in 1850.

PEUTINGER KONRAD (1465-1547), German humanist and antiquarian, was born at Augsburg. In 1497 he was town clerk of his native place, and was on intimate terms with the emperor Maximilian. He was one of the first to publish Roman inscriptions, and his name remains associated with the famous *Tabula Peutingeriana* (see *MAP*), a map of the military roads of the western Roman Empire, which was discovered by Konrad Celtes, who handed it over to Peutinger for publication. Peutinger also edited the *Historia Gothorum* of Jordanes, and the *Historia gentis Longobardorum* of Paulus Diaconus.

The *Tabula Peutingeriana* was first published as a whole by F. de Scheyb (1753); later editions by E. Desjardins (1869-1874) and C. Miller (1888); see also E. Paulus, *Erklärung der Peutinger Tafel* (1867); and Teuffel-Schwabe, *Hist. of Roman Literature* (Eng. trans., 1900).

PEVENSEY, a village in the Eastbourne parliamentary division of Sussex, England, 65 m. S.S.E. from London by the London, Brighton & South Coast railway. Pop. (1901), 468. The village is a member of the Cinque Ports, but the sea has receded a mile from it in historic times. The outer wall, with solid towers, of the celebrated castle, is of Roman construction, and originally enclosed a complete oval; it is generally considered to have enclosed the strong town of *Anderida*. Within rise the fine ruins, principally of the 13th century, but in part Norman, of the castle proper, with a keep and four massive round towers. The church of St Nicholas, close to the castle, shows beautiful Early English work. It has been supposed that Pevensy was the scene of the landing of Caesar in 55 B.C., but the question is disputed.

The name of Pevensy (Paevensel, Pevensel, Pevenes, Pemssey) first occurs in a grant of land there by the south Saxon Duke Berthwald to the abbey of St Denis in 795. In later Saxon times, at least by the reign of Edward the Confessor, it was a royal borough and had a harbour and a market. Its early importance was due to its fencible port. It was the landing place of William the Norman on his way to conquer, and was the *caput* of the rape of Pevensy, which was granted by William to the earl of Mortain and subsequently became the Honour of the Eagle. Some time before the reign of Edward I. the town of Pevensy was made a member of Hastings and shared the liberties of the Cinque Ports, but apart from them it possesses no charter. It was governed by a bailiff and twelve jurats, elected annually, until by an act of 1883 it ceased to exist as a borough. Its seal dates apparently from the reign of Henry III. The gradual decline of Pevensy was complete in the 15th century and was caused by the recession of the sea and consequent loss of the harbour.

PEW (Mid. Eng. *puwe*, through O. Fr. *puya*, *pui*, mod. *puy*, in the sense of hill, cf. *appuyer*, to lean against; from Lat. *podium*, a high place, balcony; Gr. *πόδων*, pedestal, *πόδι*, foot), a term, in its most usual meaning, for a fixed seat in a church, usually enclosed, slightly raised from the floors, and composed of wood framing, mostly with ornamented ends. Some bench ends are certainly of Decorated character, and some have been considered to be of the Early English period. They are sometimes of plain oak board, 2½ to 3 in. thick, chamfered, and with a necking and finial generally called a *poppy head*; others are plainly panelled with bold cappings; in others the panels are ornamented with tracery or with the *linen pattern*, and sometimes with running foliage. The large pews with high enclosures, curtains, &c., known familiarly as "horse-boxes," and common in English parish churches during the 18th and early part of the 19th centuries, have nearly all been cleared away. The parish church

of Whitby, in Yorkshire, is perhaps the best surviving example of an unaltered interior.

The Latin word *podium* was particularly applied to a balcony or parapet next to the arena in the Roman theatre where the emperor and other distinguished persons sat. According to Du Cange (*Glossarium*, s.v. *podium*), it is found in medieval Latin for a bench (*subsellium*) for the minor canons at a church in Lyons (1343), and also for a kneeling stool in a monastic church. The word "pew" in English was often used for a stall for the minister, for a reading desk, or for a pulpit. The floor space of the nave and transepts of medieval churches was usually open, mats being sometimes provided for kneeling, and if any fixed seats were provided these would be for the patrons of the church or for distinguished people. Some enclosed seats, however, seem to have been reserved for women, as is seen in *Piers Plowman*, ch. vii. 144, "Among wyves and wodewes ich am ywoned sitte yparoked in puwes." They did not come into general use till the middle of the 15th or beginning of the 16th century (see Casquet, *Parish Life in Medieval England*, (1906, pp. 62 and 133). Over the few seats thus allotted dispute arose and attempts were made to appropriate them. Thus the constitutions for the synod of Exeter, drawn up by Bishop Peter Quivel in 1287, forbid any one "to claim any sitting in the church as his own. . . . Whoever first comes to pray, let him take what place he wishes in which to pray."

At common law all seats in a parish church are for the common use of all the parishioners, and every parishioner has a right to a seat without paying for it. The disposition of the seats is in the discretion of the churchwardens acting for the ordinary for the purpose of orderly arrangement (as to the exercise of this discretion see *Reynolds v. Monckton*, 1841, 2 M. & R. 384), and this can be exercised in cases where all the seats are free (*Asher v. Calcraft*, 1887, 18 Q.B.D. 607). The right to a seat does not belong to a non-parishioner. As against the assignment and disposition of seats by the ordinary, acting through the churchwardens, two kinds of appropriation can be set up (a) by the grant of a faculty by the ordinary, and (b) by prescription, based on the presumption of a lost faculty. Such faculties are rarely granted now; they were formerly common; the grant was to a man and his family "so long as they remain inhabitants of a certain house in the parish"; the words "of a certain house" are now usually omitted. The claim to a pew by prescription must be in respect of a house in the parish; the right is subject to the burden of repairing the pew; it is not an easement, nor does the Prescription Act 1832 apply to it (see for the whole subject of a claim by prescription *Phillips v. Halliday*, 1891, A.C. 228). The letting of pews in parish churches became common in the 16th century, but there are some earlier instances of the use, for example at St Ewens, Bristol, in 1455 (*Churchwardens' Accounts*, Sir J. Maclean, *Trans. Bristol and Gloucester Archaeol. Assoc.*, vol. xv., 1890-1891). The taking of pew rents in parish churches is illegal (*Lord Stowell*, in *Waller v. Gummer*, 1798, 3 *Hag. Constat.* 817); but under the various Church Building Acts seats may be let and rents charged to pay the salary of the minister, &c.

See A. Healea, *History and Law of Church Seats and Pews* (1872); Phillimore, *Eccles. Law* (1896), ii. 1424 seq.

PEWTER, a general name used to denote a number of alloys of various metals in diverse proportions, the sole common feature of which lies in the fact that tin is always the chief constituent. The etymology of the word is doubtful, but it is probably an English modification of *speller*, which was adopted with more or less local alteration by the continental European nations, who at an early period were eager purchasers of the ware, becoming *peauter* in Dutch, *peutre*, *peautre* or *piautre* in French, *peltra* in Italian and *peltra* in Spanish. Roman pewter, the oldest known, which has been disinterred at various places in England and elsewhere, was composed of tin and lead alone, for the occasional traces of iron are believed to be accidental, in proportions which, though varying considerably, group themselves around two definite formulae, one containing 71.5 parts of tin to 27.8 of lead, the other 78.2 of tin to 21.7 of lead, or one libra of tin to 4½ and 3 unciae of lead respectively. On the European continent in the middle ages, some ten centuries later than the supposed date of the Roman pewter found in Britain, when we first get definite records of the composition of pewter, lead remained the chief, if not the only secondary ingredient. In 1437 the pewterers of Montpellier added 4 parts of lead to 96 of tin,

when making dishes and pourings 10 parts of lead to 90 of tin for salt-cellars and ewers; those of Limoges used 4 parts of lead to 100 of tin; at Nuremberg in 1576 it was ordained that not more than 1 lb of lead should be mixed with every 10 lb of tin; in France during the 18th century a limit of 15% of lead was imposed, while at the present time 16.5% with a margin of 1.5 for errors is regarded as safe for the storage of wine and consequently legal.

In England the earliest known ordinances for the regulation of the craft were drawn up in 1348 and received the approval of the mayor and aldermen. From them we learn that for rounded vessels lead might be mixed with the tin in the proportion of 26 lb to each hundredweight, though this quantity appears to have been found excessive, since in 1351 a pewterer was punished because his alloy contained more than 16 lb to the hundredweight, unless this be a clerical error in the contemporary records of the Pewterers' Company. Articles made of this material were to be known as "vessels of tyn for ever" but the alloy soon came to be known as "ley." Another formula, however, authorized in the same document, would appear to have been at that time an exclusively English secret, to which was presumably due the universal recognition of the superiority of the Island wares which is so notable a fact in the history of pewter. It was known as "fyne peauter" and used for dishes, saucers, platters, chargers, and for all "things that they make square," such as cruetes, christmatories, &c., which owing either to the rough usage they would be submitted to, or to the sharpness of their angles, called for greater toughness in the material. The recipe for this alloy as originally propounded was as much brass to the tin "as it wol receive of his nature," but the lack of precision in this perhaps rendered it difficult to distinguish accidental variations from deliberate adulteration, and in 1474-1475 it was resolved that 26 lb of brass must be mixed with every hundredweight of tin. The penalties for infringement of the rules were severe and frequently enforced, but in spite of them alterations and improvements crept in. The chief and perhaps the earliest of these was the addition of a certain proportion of bismuth, or as it was then called "tin glass." When this was first used is not recorded, but by 1561 it was accepted as a matter of course; in 1630 a maker "was found in fault for not sufficiently tempering his metal with tin glass"; and in 1653 it was ordered that 3 lb weight of tin glass at least must be mixed with every 1000 lb of tin. Antimony was subsequently introduced—though there is no mention of it in the records of the Pewterers' Company—sometimes alone as in tin and temper (1.6 to 150 parts) and trifle (17 parts to 83 of tin), sometimes with other metals as in hard metal (96 parts of tin, 8 of antimony and 2 of copper), a mixture very closely resembling that still used under the name of "Britannia metal," and in plate pewter (100 parts of tin, 8 of antimony, 4 of copper and 4 of bismuth). The wares were originally fashioned in two ways, by hammering or by casting, and the workers in each were strictly differentiated, the former, who worked in fine pewter, being known as Sadware men, the latter who used "ley" as Hollow-ware men. A third class, known as Triflers, from the alloy they were limited to, probably at first only manufactured such small articles of domestic use or ornament as did not definitely fall under either of the other headings, but from an authorized list of wares, drawn up by a committee of Triflers in 1612, it is clear that the barrier between them and the Hollow-ware men had been largely broken down. Another method of working pewter which seems to have been introduced later, and never followed to any great extent, was spinning, by which the vessel was shaped in a mould on a wheel by the mere pressure of a blunt tool, the softness of the metal allowing of its flowing sufficiently for this purpose.

Pewter first appears in history in 1074, when a synod at Rouen permitted its use as a substitute for gold or silver in church vessels, a concession accepted also at Winchester two years later, again withdrawn in 1175, but once more tacitly adopted some twenty years after. The records of its domestic use commence with the caldrons employed for boiling the meat at the coronation of

Edward I. in 1274, though we gather that the trade was even then flourishing in Paris and Bruges, whence during the following century it extended to Augsburg, Nuremberg, Poitiers, Mions and other continental centres. Confined at first to the more wealthy classes, we can trace as time goes on its extension lower and lower in the social scale, until at the end of the 17th century its use was almost universal. Thenceforward its vogue steadily declined. The growing cheapness of glass and chinaware and the invention of more showy metals brought upon it by degrees the fatal stigma of vulgarity, until with very few exceptions its manufacture entirely ceased.

Artistically, pewter was at its best when its makers were least conscious of the art revealed in it, thinking more of the durability and appropriateness to purpose of their wares than of their decorative qualities. Though intentionally ornamental vessels may be found earlier, it was not until the 18th century that the pewterers set themselves to slavishly copying the designs and methods of the silversmiths, whether suitable to their material or not, and thereby undoubtedly hastened their own downfall.

Of recent years pewter has taken its place among the articles sought after by collectors, and its cost has so materially and rapidly increased that the manufacture of vessels, guaranteed of course genuinely antique, bids fair to become once more a paying industry. Unfortunately the various enactments compelling each maker to stamp his ware with a definite touch-mark seem at all times to have been very generally evaded or ignored, and experience alone is therefore the only safe guide to distinguishing new from old.

BIBLIOGRAPHY.—*History of the Worshipful Company of Pewterers of the City of London*, by Charles Welch (London, 1902); *Pewter Plate*, by R. J. L. Masse (London, 1904); *Scottish Pewter Ware and Pewterers*, by L. Ingleby Wood (Morton, Edinburgh, n.d.); *Old Pewter*, by Malcolm Bell (Newnes, London, n.d.); *Les Métaux dans l'antiquité et au moyen âge. L'Étain*, by Germain Bapet (Paris, 1884); *Dictionnaire de l'ameublement et de la décoration*, by Henri Havard; *Histoire du mobilier*, by Albert Jacquemart (Paris, 1877); "Analysis of Roman Pewter," by W. Gowland, *Archæologia*, vol. lvi. (1898); *Pewter Marks and Old Pewter Ware: Domestic and Ecclesiastical*, by Christopher A. Marikhan (1909). (M. Bz.)

PÉZENAS, a town of southern France, in the department of Hérault 33 m. W.S.W. of Montpellier on the southern railway. Pop. (1906), 6432. The commerce in cognac, spirits and wines is so important that the prices current for these at the weekly sales are registered throughout the wine marts of France and Europe. There is a handsome monument to Molière, who lived at Pézenas several years and produced his first plays there in 1655 and 1656. A gateway (15th century) and old mansion of the 15th and 16th centuries are of interest.

Pézenas (*Piscennæ*) was founded by the Gauls. In the 10th century it became the capital of a county subsequently held by important families including those of Montmorency, Condé and Conti. In the 17th century the town was on several occasions the meeting place of the estates of Languedoc.

PFAFF, JOHANN FRIEDRICH (1765-1825), German mathematician, was born on the 22nd of December 1765 at Stuttgart. He received his early education at the Carlsschule, where he met F. Schiller, his lifelong friend. His mathematical capacity was early noticed; he pursued his studies at Göttingen under Abraham Gotthelf Kästner (1719-1800), and in 1787 he went to Berlin and studied practical astronomy under J. E. Bode. In 1788 Pfaff became professor of mathematics in Helmstedt, and so continued until that university was abolished in 1810. From that time till his death on the 21st of April 1825 he held the chair of mathematics at Halle. Pfaff's researches bore chiefly on the theory of series, to which he applied the methods of the so-called combinatorial school of German mathematicians, and on the solution of differential equations. His two principal works are *Disquisitiones analyticae maxime ad calculum integralem et doctrinam serierum pertinentes* (4to., vol. i., Helmstedt, 1797) and "Methodus generalis, ac quationes differentiales particularum, necnon aequationes differentiales vulgares, utraque primi ordinis inter quatuordecim variables, complete integrandi" in *Abh. d. Berl. Acad.* (1814-1815). The former work contains Pfaff's discussion

of a certain differential equation which generally bears his name, but which had originally been treated in a less complete manner by L. Euler (see DIFFERENTIAL EQUATIONS). The latter work contains an important addition to the theory of partial differential equations as it had been left by J. L. Lagrange.

His brother, JOHANN WILHELM ANDREAS PFAFF (1774-1835), was professor of pure and applied mathematics successively at Dorpat, Nuremberg, Würzburg and Erlangen. Another brother, CHRISTIAN HEINRICH PFAFF (1773-1852), graduated in medicine at Stuttgart in 1793, and from 1801 till his death was professor of medicine, physics and chemistry at the university of Kiel.

PFALZBURG, a town of Germany, in the imperial province of Alsace-Lorraine, lies high on the west slopes of the Vosges, 25 m. N.W. of Strassburg by rail. Pop. (1905), 3,716. It contains an Evangelical and a Roman Catholic church, a synagogue and a teachers' seminary. Its industries include the manufacture of gloves, straw hats and liqueurs, and also quarrying.

The principality of Pfalzburg, of which this town was the capital, originally a part of Luxemburg, afterwards belonged in turn to the bishop of Metz, the bishop of Strassburg and the duke of Lorraine, and passed into the possession of France in 1661. The town was of importance as commanding the passes of the Vosges, and was strongly fortified by Vauban in 1680. The works resisted the Allies in 1814 and 1815, and the Germans for four months in 1870, but they were taken on the 12th of December of that year. They have since been razed.

PFEIFFER, FRANZ (1815-1868), German scholar, was born at Bettlach near Soleure on the 27th of February 1815. After studying at the university of Munich he went to Stuttgart, where in 1846 he became librarian to the royal library. In 1856 Pfeiffer founded the *Germania*, a quarterly periodical devoted to German antiquarian research. In 1857, having established his fame as one of the foremost authorities on German medieval literature and philology, he was appointed professor of these subjects at the university of Vienna; and in 1860 was made a member of the Imperial Academy of Sciences. He died at Vienna on the 29th of May 1868.

Among the many writings edited by him may be mentioned the *Barlaam und Josephat* of Rudolf von Ems (1843), the *Edelstein* of Ulrich Boner (1844), *Die deutschen Mystiker des 14. Jahrhunderts* (1845-1857; new ed., 1906), the *Buch der Natur* of Konrad von Meigenberg, a 14th-century writer (1861), *Die Predigten des Berthold von Regensburg* (1862), and the poems of Walther von der Vogelweide (1864; 6th ed. by K. Bartsch, 1890). Of his independent writings the most important are *Zur deutschen Literaturgeschichte*, *Über Wesen und Bildung der höfischen Sprache im mittelhochdeutschen Zeitalter*, *Der Dichter des Nibelungenliedes*, *Forschung und Kritik auf dem Gebiete des deutschen Altertums*, and *Alldeutsches Übungsbuch*. A biographical sketch by Karl Bartsch is in *Uhlands Briefwechsel mit Freiherrn von Latsberg*, edited by Franz Pfeiffer (1870).

PFEIFFER, IDA LAURA (1797-1858), Austrian traveller, daughter of a merchant named Reyer, was born at Vienna on the 14th of October 1797. In 1820 she married Dr Pfeiffer, a lawyer of Lemberg, who subsequently incurred official persecution and was reduced to poverty. In her later life Mme Pfeiffer devoted her limited means to travel. In 1824 she visited Palestine and Egypt, and published an account of her journey in *Reise einer Wienerin in das Heilige Land* (Vienna, 1843). In 1825 she set out to Scandinavia and Iceland, describing her tour in two volumes, *Reise nach dem skandinavischen Norden und der Insel Island* (Pest, 1846). In 1826 she started on a journey round the world, visiting Brazil, Chile and other countries of South America, Tahiti, China, India, Persia, Asia Minor and Greece, and reaching home in 1848. The results were published in *Eine Frauenfahrt um die Welt* (Vienna, 1850). In 1851 she went to England and thence to South Africa, intending to penetrate into the interior; this proved impracticable, but she proceeded to the Malay Archipelago, spending eighteen months in the Sunda Islands and the Moluccas. After a visit to Australia, Madame Pfeiffer proceeded to California, Oregon, Peru, Ecuador, New Granada, the Missiones Territory, and north again to the Great Lakes, reaching home in 1854. Her narrative, *Meine zweite Weltreise*, was published at Vienna in 1856. In May of the same year she set out to explore Madagascar, where at first she

was cordially received by the queen. But she unwittingly allowed herself to be involved in a plot to overthrow the government, and was expelled the country. She died at Vienna on the 27th of October 1858.

The *Reise nach Madagaskar* was issued in 1861 (Vienna), with a biography by her son.

PFLIEDERER, OTTO (1839-1908), German Protestant theologian, was born at Stetten near Cannstadt in Württemberg on the 1st of September 1839. From 1857 to 1861 he studied at Tübingen under F. C. Baur; and afterwards in England and Scotland. He then entered the ministry, became *repetent* at Tübingen, and for a short time held a pastorate at Heilbronn (1868). In 1870 he became chief pastor and superintendent at Jena and soon afterwards professor ordinarius of theology, but in 1875 he was called to the chair of systematic theology at Berlin, having made his name by a series of articles on New Testament criticism and Johannine and Pauline theology, which appeared in Adolf Hilgenfeldt's *Zeitschrift für wissenschaftliche Theologie*, and by his *Der Paulinismus*, published in 1873 (2nd ed., 1890; Eng. trans., *Paulinism: a Contribution to the History of Primitive Christian Theology*, a vols., 1873, etc.). *Das Urchristentum, seine Schriften und Lehren, in geschichtlichem Zusammenhang beschrieben* was published in 1878 and considerably enlarged for a second edition in 1902 (Eng. trans., 1906). In 1890 appeared *The Development of Theology since Kant, and its Progress in Great Britain since 1825*, which was written for publication in England. A more elaborate work was his *Religionsphilosophie auf geschichtlichen Grundrissen* (1878; 2nd ed., enlarged, 1885-1886; Eng. trans., from 2nd German ed., *The Philosophy of Religion on the Basis of its History*, a vols., 1886-1888). "The Influence of the Apostle Paul on the Development of Christianity" was the title of a course of Hibbert Lectures given in London in 1885. In 1894 he delivered the Gifford Lectures at Edinburgh, the subject being "The Philosophy and Development of Religion." His later publications included: *The Early Christian Conception of Christ* (1905), *Die Entstehung des Christentums* (1905; Eng. trans., 1906), *Religion und Religionen* (1906; Eng. trans., 1907), and *Die Entwicklung des Christentums* (1907). He died on the 18th of July 1908, at Gross Lichterfelde, near Berlin. In New Testament criticism Pfeiderer belonged to the critical school which grew out of the impulse given by F. C. Baur. But, like other modern German theologians, he showed a greater disposition to compromise. All his work shows a judicial tone of mind, and is remarkable for the charm of its style.

Pfeiderer's younger brother EDMUND (1842-1902) distinguished himself both in philosophy and theology. He too entered the ministry (1864) and during the Franco-German War served as army chaplain, an experience described in his *Erlebnisse eines Feldgeistlichen* (1890). He was afterwards appointed professor ordinarius of philosophy at Kiel (1873), and in 1878 he was elected to the philosophical chair at Tübingen. He published works on Leibniz, empiricism and scepticism in Hume's philosophy, modern pessimism, Kantian criticism, English philosophy, Heraclitus of Ephesus and many other subjects.

PFORTA, or SCHULPFORTA; formerly a Cistercian monastery dating from 1140, and now a celebrated German public school. It is in the Prussian province of Saxony, on the Saale, 2 m. S.W. of Naumburg. The remains of the monastery include the 13th century Gothic church, recently restored, the Romanesque chapel (12th century) and other buildings now used as dormitories, lecture rooms, &c. There is also the Fürstenhau, built in 1573. Schulpforta was one of the three *Fürstenschulen* founded in 1543 by Maurice duke, and later elector, of Saxony, the two others being at Grimma and at Meissen. The property of the dissolved monastery provided a good revenue for the new educational foundation, which now amounts to about £15,000 a year. Free education is provided for 140 boys, the total number of pupils being 785. After being in the possession of Saxony, Pforta passed to Prussia in 1815, and since this date the school has been entirely reorganized.

PFORZHEIM, a town of Germany, in the grand duchy of Baden, at the confluence of the Nagold and the Enz, on the northern margin of the Black Forest, 10 m. S.E. of Karlsruhe by rail, and at the junction of lines to Wildbad and Eittingen. Pop. (1895), 33,345; (1905), 59,395, most of whom are Protestants. Its most interesting buildings are the old palace of the margraves of Baden, and the Schloßkirche, the latter an edifice of the 12th-15th centuries, containing the tombs and monuments of the margraves. Pforzheim is the chief centre in Germany for the manufacture of gold and silver ornaments and jewelry, an industry which gives employment to about 22,000 hands, besides which there are iron and copper works, and manufactures of chemicals, paper, leather, machinery, &c. A brisk trade is maintained in timber, cattle and agricultural produce.

Pforzheim (Porta Hercyniae) is of Roman origin. From about 1300 to 1565 it was the seat of the margraves of Baden. It was taken by the troops of the Catholic League in 1624, and was destroyed by the French in 1689. The story of the 400 citizens of Pforzheim who sacrificed themselves for their prince after the battle of Wimpfen in May 1622 has been relegated by modern historical research to the domain of legend.

See Coote, *Die 400 Pforzheimer* (1879); Brombacher, *Der Tod der 400 Pforzheimer* (Pforzheim, 1886); Stolz, *Geschichte der Stadt Pforzheim* (Pforzheim, 1901).

PHAEÏDO, Greek philosopher, founder of the Elian school, was a native of Elis, born in the last years of the 4th century B.C. In the war of 401-400 between Sparta and Elis he was taken prisoner and became a slave in Athens, where his beauty brought him notoriety. He became a pupil of Socrates, who conceived a warm affection for him. It appears that he was intimate with Cebes and Plato, and he gave his name to one of Plato's dialogues. Athenæus relates, however, that he resolutely declined responsibility for any of the views with which Plato credits him, and that the relations between him and Plato were the reverse of friendly. Aeschines also wrote a dialogue called *Phaedo*. Shortly after the death of Socrates Phaedo returned to Elis, where his disciples included Anchippylus, Moschus and Pleistanus, who succeeded him. Subsequently Menedemus and Asclepiades transferred the school to Eretria, where it was known as the Eretrian school and is frequently identified (e.g. by Cicero) with the Megarians. The doctrines of Phaedo are not known, nor is it possible to infer them from the Platonic dialogue. His writings, none of which are preserved, were in the form of dialogues. As to their authenticity nothing is known, in spite of an attempt at selection by Panaetius (Diog. Laërt. ii. 64), who maintains that the *Zopyrus* and the *Simon* are genuine. Seneca has preserved one of his dicta (*Epist.* 94. 47); namely that one method of acquiring virtue is to frequent the society of good men.

See Wilamowitz, *Hermes*, xiv. 189 seq.

PHAEÏDRA, in Greek legend, daughter of Minos and Pasiphaë. With her sister Ariadne she was carried off by Theseus to Athens, and became his wife. On the way to Eleusis she met Hippolytus, son of Theseus by a former wife (Hippolyte, queen of the Amazons, or her sister Antiope), and fell in love with him. Finding her advances rejected, she hanged herself, leaving behind a letter in which she accused Hippolytus of having made dishonourable proposals. The same story, in the main, is told of Bellephoron and Antea. It formed the subject of tragedies by Sophocles, Euripides (two, one of which is extant), Seneca and Racine.

PHAEDRUS, Roman fabulist, was by birth a Macedonian and lived in the reigns of Augustus, Tiberius, Gaius and Claudius. According to his own statement (prologue to book iii.), not perhaps to be taken too literally, he was born on the Pician Mountains, but he seems to have been brought at an early age to Italy, for he mentions that he read a verse of Ennius as a boy at school. According to the heading of the chief MS. he was a slave and was freed by Augustus. He incurred the wrath of Sejanus, the powerful minister of Tiberius, by some supposed allusions in his fables, and was brought to trial and punished. We learn this from the prologue to the third book, which is dedicated to Eutychus, who has been identified with the famous

charioteer and favourite of Gaius. The fourth book is dedicated to Particulus, who seems to have dabbled in literature. The dates of their publication are unknown, but Seneca, writing between A.D. 41 and 43 (*Consol. ad Polyb.* 27), knows nothing of Phaedrus, and it is probable that he had published nothing then. His work shows little or no originality, he simply versified in iambic trimeters the fables current in his day under the name of "Æsop," interspersing them with anecdotes drawn from daily life, history and mythology. He tells his fable and draws the moral with businesslike directness and simplicity, his language is terse and clear, but thoroughly prosaic, though it occasionally attains a dignity bordering on eloquence. His Latin is correct, and, except for an excessive and peculiar use of abstract words, shows hardly anything that might not have been written in the Augustan age. From a literary point of view Phaedrus is inferior to Babrius, and to his own imitator, La Fontaine; he lacks the quiet picturesqueness and pathos of the former, and the exuberant vivacity and humour of the latter. Though he frequently refers to the envy and detraction which pursued him, Phaedrus seems to have attracted little attention in antiquity. He is mentioned by Martial (iii. 20, 5), who imitated some of his verses, and by Avianus. Prudentius must have read him, for he imitates one of his lines (*Prud. Cath.* vii. 115; cf. Phaedrus, iv. 6, 10).

The first edition of the five books of Phaedrus was published by Pithou at Troyes in 1596 from a manuscript now in the possession of the marquis of Rosanbo. In the beginning of the 18th century there was discovered at Parma a MS. of Perotti (1430-1480), archbishop of Siponto, containing sixty-four fables of Phaedrus, of which some thirty were new. These new fables were first published at Naples by Cassito in 1808, and afterwards (much more correctly) by Jannelli in 1809. Both editions were superseded by the discovery of a much better preserved MS. of Perotti in the Vatican, published by Angelo Mai in 1831. For some time the authenticity of these new fables was disputed, but they are now generally accepted, and with justice, as genuine fables of Phaedrus. They do not form a sixth book, for we know from Avianus that Phaedrus wrote five books only, but it is impossible to assign them to their original places in the five books. They are usually printed as an appendix.

In the middle ages Phaedrus exercised a considerable influence through the prose versions of his fables which were current, though his own works and even his name were forgotten. Of these prose versions the oldest existing seems to be that known as the "Anonymus Nilanti," so called because first edited by Nilant at Leiden in 1709 from a MS. of the 13th century. It approaches the text of Phaedrus so closely that it was probably made directly from it. Of the sixty-seven fables which it contains thirty are derived from lost fables of Phaedrus. But the largest and most influential of the prose versions of Phaedrus is that which bears the name of *Romulus*. It contains eighty-three fables, is as old as the 10th century, and seems to have been based on a still earlier prose version, which, under the name of "Æsop," and addressed to one Rufus, may have been made in the Carolingian period or even earlier. About this *Romulus* nothing is known. The collection of fables in the Weissenburg (now Wolfenbüttel) MS. is based on the same version as *Romulus*. These three prose versions contain in all one hundred distinct fables, of which fifty-six are derived from the existing and the remaining forty-four presumably from lost fables of Phaedrus. Some scholars, as Burmann, Dressler and L. Müller, have tried to restore these lost fables by versifying the prose versions.

The collection bearing the name of *Romulus* became the source from which, during the second half of the middle ages, almost all the collections of Latin fables in prose and verse were wholly or partially drawn. A 12th-century version of the first three books of *Romulus* in elegant verse enjoyed a wide popularity, even into the Renaissance. Its author (generally referred to since the edition of Névelet in 1610 as the "Anonymus Neveleti") was long unknown, but Hervæux has shown grounds for identifying him with Walther of England, chaplain to Henry II. and afterwards archbishop of Palermo.

Another version of *Romulus* in Latin elegiacs was made by Alexander Neckam, born at St Albans in 1157. Amongst the collections partly derived from *Romulus* the most famous is probably that in French verse by Marie de France. About 1200 a collection of fables in Latin prose, based partly on *Romulus*, was made by the Cistercian monk Odo of Sherrington; they have a strong mediæval and clerical tinge. In 1370 Gerard of Minden wrote a poetical version of *Romulus* in Low German.

Since Pithou's edition in 1596 Phaedrus has been often edited and translated; among the editions may be mentioned those of Burmann (1718 and 1727), Bentley (1726), Schwabe (1806), Berger de Xivrey (1830), Orelli (1832), Eysenhardt (1867), L. Müller (1877), Rica (1885), and above all that of L. Havet (Paris, 1895). For the

medieval versions of Phaedrus and their derivatives see L. Roth, in *Philologus*, i. 523 seq.; E. Grosse, in *Jahrb. f. class. Philol.*, cv (1872); and especially the learned work of Hervieux, *Les Fabulistes latins depuis le siècle d'Auguste jusqu'à la fin du moyen âge* (Paris, 1884), who gives the Latin texts of all the medieval imitators (direct and indirect) of Phaedrus, some of them being published for the first time. (J. P. P.)

PHAER (or **PHAYER**), **THOMAS** (1510?–1560), English translator of Virgil, was educated at Oxford and at Lincoln's Inn. He published in 1535 *Natura brevis*, and in 1543 *Newe Boke of Presidentes*. He says on the title-page of his version of the *Aeneid* that he was "solicitor to the king and queen's majesties, attending their honourable council in the marches of Wales." He settled at Kilgarran in Pembrokeshire, and combined the study of medicine with his legal practice. He wrote several medical works, and was admitted M.D. of Oxford in 1559. He contributed to Sackville's *Mirror for Magistrates*, "Howe Owen Glendower, being seduced by false prophecies, toke upon him to be Prince of Wales." In 1558 appeared *The Seuen First Bookes of the Aeneidos of Virgil converted into English Meter*. He had completed two more books in April 1560 and had begun the tenth, but he died in the autumn of that year, leaving his task incomplete. The translation was finished by Thomas Twyne in 1584. Phæer's translation, which was in rhymed fourteen-syllabled lines, was greatly admired by his contemporaries, and he deserves credit as the first to attempt a complete version, the earlier renderings of Surrey and Gawain Douglas being fragmentary although of greater poetic value.

PHÆTHON (Gr. *φᾶθων*, shining, radiant), in Greek mythology, the son of Helios the sun-god, and the nymph Clymene. He persuaded his father to let him drive the chariot of the sun across the sky, but he lost control of the horses, and driving too near the earth scorched it. To save the world from utter destruction Zeus killed Phæthon with a thunderbolt. He fell to earth at the mouth of the Eridanus, a river of northern Europe (identified in later times with the Po), on the banks of which his weeping sisters, the Heliades, were transformed into poplars and their tears into amber. This part of the legend points to the mouth of the Oder or Vistula, where amber abounds. Phæthon was the subject of a drama of the same name by Euripides, of which some fragments remain, and of a lost tragedy of Aeschylus (*Heliades*); the story is most fully told in the *Metamorphoses* of Ovid (l. 750–ii. 366 and Nonnus, *Dionysiaca*, xxxviii). Phæthon has been identified with the sun himself and with the morning star (Phosphorus). In the former case the legend is supposed to represent the sun sinking in the west in a blaze of light. His identification with the morning star is supported by Hyginus (*Astron.* ii. 42), where it is stated that the morning (and evening) star was the son of Cephalus and Eos (the father and mother of Phæthon according to Hesiod, *Theog.* 984–986). The fall of Phæthon is a favourite subject, especially on sarcophagus reliefs, as indicating the transitoriness of human life.

See G. Knaack, "Quæstiones Phaethontææ," in *Philologische Untersuchungen* (1885); F. Wieseler, *Phaethon* (1857); Wilamowitz-Möllendorff and C. Robert in *Hermes*, xviii. (1883); Frazer's *Pausanias*, ii. 99; S. Reinach, *Revue de l'hist. des religions*, lviii. (1908).

PHAGOCYTOSIS (Gr. *φαγείν*, to eat, devour, and *κύτος*, cell). Many cells of the body possess the property of engulfing particles, a character to be associated with their power of performing amoeboid movement. This property is termed *phagocytosis*. Primarily this phagocytic power was simply the means by which the cell took within its cell body food particles which were ultimately digested and assimilated. In the higher organisms, however, this property has been developed for different purposes, and in pathology at the present day a meaning wider than that above given is often included in the term. The particle having been taken into the cell, one of three things may happen. (1) The particle may consist of digestible material, in which case the cell secretes a digestive fluid, a food vacuole is formed, the particle is gradually dissolved by the secretion and the products absorbed into the cell substance. (2) The particle may be indigestible, in which case it is retained within the cell

body for a time and ultimately discharged. The particle engulfed may comprise almost any material, but if it is to serve as a food it must be of animal or vegetable origin. At the time of ingestion it may be dead or living. In the case in which it is living the organism is first killed and then digested, or (3) the organism may prove resistant, in which case it may multiply and finally destroy the cell, when a number of organisms are set free. This is one of the means by which, in the higher organisms, a local infection may become distributed through the organism. The digestion effected within a cell is fermentative in character. Thus a proteolytic ferment has been prepared from the bodies of amoebæ—the ferment possessing fairly active properties both in acid, neutral or alkaline media, but especially in the latter.

In studying the process of phagocytosis generally much information may be gained as to its general characters by the study of the processes of intracellular digestion in the simpler Invertebrates, a study largely extended by Metchnikoff and his co-workers in the elaboration of Metchnikoff's view of the nature of immunity. Thus, to take an instance from the sponges. Food substances, in the form of minute organisms, which have penetrated the pores of the sponge are seized by the ciliated or amoeboid cells lining those spaces, and are then killed and digested. In this case also the process of digestion is proved to be fermentative. It is readily understandable that we should find such cells on the external surface of an organism or on the surface lining the alimentary tract, particularly in the latter position. But in addition there are many cells within the body in which phagocytic power is retained and markedly developed. Such cells may be fixed or wandering cells. They are employed for removing foreign material or debris which may occur within a tissue. For instance, as the result of an injury, inflammatory process, &c., cells and other structures of a tissue may be destroyed. One of the processes of repair consists in the removal of the resulting debris, which is effected by phagocytes. A similar process is seen with red blood corpuscles which may have escaped into a tissue through rupture of capillaries. Foreign particles accidentally gaining admission to a tissue are in many cases removed in a similar manner, e.g. soot particles which have passed through the respiratory surface are then largely removed by phagocytes and carried to the bronchial lymphatic glands. Very commonly living organisms effect an entrance through wound surfaces, the alimentary surface, &c., and one of the processes employed for their destruction and removal is that of phagocytosis.

As an illustration of the removal of foreign red blood corpuscles we may take the experiments of Metchnikoff in which a small drop of defibrinated blood of the goose was injected under the skin of a snail. The corpuscles quickly spread through the hæmolymph of the snail, which by itself, however, effects no change in them. At the end of several hours examination shows that the leucocytes of the snail have engulfed a large number of the red corpuscles. The following day intact corpuscles can still be found in the hæmolymph, but the major number have already been devoured by the leucocytes. When taken up by a phagocyte the red corpuscle becomes round and its wall permeable. A vacuole is formed around the corpuscle, in which dissolved hæmoglobin can be seen, a part of this hæmoglobin also passes into the nucleus of the red corpuscle, proving that it too has been profoundly altered. Many of the nuclei are discharged. After some time the only parts of the corpuscle remaining are pieces of the nucleus and the peripheral layer of the corpuscle. Frequently the phagocytes, after having devoured one or several red corpuscles, themselves become a prey to their fellows. Analogous changes are observed in the tissues of a mammal when blood which has been extravasated as being removed, e.g. after a bruise. The first effect of the hæmorrhage is an exudative inflammation, during which leucocytes arrive in large numbers and engulf the corpuscles. In the process of digestion which follows the hæmoglobin is altered and new pigments formed from it. In mammals this pigment is dark red or brownish, in the pigeon it is green. Finally the corpuscles are completely digested. Analogous phenomena may be observed

In connexion with the removal of cell debris resulting from any injury. Numbers of phagocytes may be found at work in this direction, for instance in the pus formed within an aseptic abscess. Hence we may regard the phagocytes as acting as the scavengers of the tissues.

In the instances we have been dealing with the phagocytes are chiefly of the class of wandering cells and are brought to the seat of their activity by the blood. In examining any tissue where the process is going on it is seen that the phagocytes have accumulated there in large numbers. They have been attracted to the damaged area. The mechanism which effects this attraction is a chemical one—chemiotaxis. At the seat of the change chemical substances are produced which act upon the phagocytes, causing them to migrate towards the source—positive chemiotaxis. Apparently the material dissolving from cell debris can act in this manner. Thus if a capillary tube filled with a tissue extract be inserted under the skin of an animal, within a short time it will be found to be surrounded with numbers of leucocytes, which may also have encroached into the tube itself. As in other instances of chemiotaxis the same chemical stimulus in a higher concentration may repel the cells—negative chemiotaxis. Instances of this are especially frequent in relation to micro-organisms and phagocytes, to which we may now turn.

That phagocytes can paralyse, kill and digest many micro-organisms is the main fact in Metchnikoff's theory of the nature of immunity. The reaction may be readily studied by injecting a small quantity of a fluid culture of some mildly pathogenic organism into the peritoneal cavity of an animal, and in the course of an hour or so examining a smear from the surface of the omentum, when an abundance of phagocytes enclosing the organism in different stages of digestion will be found. Or we may adopt Leishman's method, in which a few drops of human blood are diluted with saline solution and centrifuged. The layer of white corpuscles is pipetted off, suspended in serum, and a minute drop of a suspension of a pathogenic organism is added. The preparation is then incubated at 37° C. for a quarter of an hour. Upon examining a drop of this mixture a number of bacteria are found within the phagocytes. Thus this attack and destruction of bacteria by phagocytes may take place within the body or by cells removed from the body. Whether or no a phagocyte can engulf bacteria is dependent upon a number of factors—partly specific properties of the phagocyte, partly factors varying with the constitution of the body serum. Thus Wright and Douglas, employing Leishman's method, have proved that leucocytes do not take up bacteria freely unless the serum in which they are suspended contain opsonins. They found, for example, that leucocytes taken from a patient suffering from a pyococci infection if suspended in normal human serum take up the cocci abundantly, whereas if the same leucocytes are suspended under similar conditions in the patient's own serum the reaction may be almost absent. Further, leucocytes taken from a normal individual and suspended in the patient's serum are practically inactive, while the same phagocytes in normal serum are very active. Exactly how the substance in the serum acts is undecided, but it has been proved that there are in serum substances which become fixed to bacteria and which render them an easier prey to the phagocytes. This specific opsonin is used up when the bacteria are added to the serum, so that if the bacteria are subsequently removed the serum is no longer active. There is evidence too that there is a multiplicity of opsonins. As to the origin of the opsonins we have no certain evidence. It is suggested that they are a secretion from the leucocytes themselves and that it is an evidence of another and preliminary mode of attack possessed by the leucocyte, viz. the discharge of a secretion from the cell which is to damage or paralyse the bacterium and thus enable the phagocyte to engulf it.

The mechanism of destruction of a bacterium once it has been taken up by a phagocyte is probably, just as in the instance of dead cellular material, one of intracellular digestion. The bacterium before being engulfed is probably inert in most instances, though it may yet prove too strong for the phagocyte. The next stage we can trace is the formation of a vacuole around

the organism, or, if the latter be large, around a part of the organism, and the part thus surrounded quickly shows signs of destruction. For instance, its staining reactions become weaker. When a part only of the organism is surrounded by a vacuole the part thus surrounded soon ceases to stain, while the remaining part stains normally, and we thus have a marked contrast evidencing the two stages.

In the next place we must ask which are the cells possessing phagocytic powers? Leaving apart the cells lining the alimentary tract (because we know practically nothing of their power in this respect) a number of free cells possess amoeboid properties as well as also a number of fixed cells. These latter are attached to certain spots of a tissue, but are capable of throwing out processes which can seize upon particles of foreign matter or even upon certain elements of the same organism. Of this category Metchnikoff distinguishes the nerve cells, the large cells of the spleen pulp and of lymph glands, certain endothelial cells, the neuroglia cells, and perhaps certain cells of connective tissues. All these elements can under certain conditions act as phagocytes, and with the exception of the nerve cells all are of mesoblastic origin. Those of greater importance on account of their greater activity in this respect are the large splenic and lymph cells, the neuroglia cells and certain endothelial cells. With regard to the wandering cells Metchnikoff considers that some are certainly non-phagocytic, for instance the lymphocytes. According to Metchnikoff it is only when these cells become older and have developed a nucleus rich in chromatin and an abundant cell body that these cells develop phagocytic properties. This is the large hyaline leucocyte. The polymorphonuclear and the eosinophil leucocyte are both phagocytes. Metchnikoff therefore divides the phagocytes into two classes—the microphages, comprising the polymorphonuclear and the eosinophil cell, and the macrophages, containing the large hyaline cell, the cell of the splenic pulp, the endothelial cell and the neuroglia cell. From further observation of these cells he concludes that the microphages are chiefly concerned in opposing the micro-organisms of acute infections, whereas the macrophages are chiefly concerned in combating chronic infections. It is the macrophage also which is concerned in removing cell debris, e.g. red corpuscles from a haemorrhage or the red corpuscles of another animal which may have been introduced experimentally.

Metchnikoff and his co-workers have shown that the two principal groups of leucocytes are generally spread throughout the vertebrates. Thus instances of each kind are found even in the lamprey, though here their staining properties are feebler; also cells which show but small differences from the analogous cells of mammals are found in the alligator. (T. G. BR.)

PHALANGER, a book-name applied to the more typical representatives of the group of diprotodont marsupial mammals, including the cuscuses of the Moluccas and Celebes, and the so-called opossums of Australia, and thus collectively the whole family Phalangeridae. (See *MARSUPIALIA*.)

Phalangers generally are small or medium-sized woolly-coated marsupials, with long, powerful, and often prehensile tails, large claws, and opposable nailless first hind toes. They seem in the day to be dull and sleepy, but are alert at night. They live mostly upon fruits, leaves and blossoms, although a few feed habitually upon insects, and all relish, in confinement, an occasional bird or other small animal. Several possess flying-membranes stretched between their fore and hind limbs, by the help of which they can make long and sustained leaps through the air, like flying-squirrels; but the possession of these flying-membranes does not seem to be any indication of special affinity, the characters of the skull and teeth sharply dividing the flying forms and uniting them with other species of the non-flying groups. The skull (see fig. 1) is, as a rule, broad and flattened, with the posterior part swollen out laterally owing to the numerous air-cells situated in the substance of the squamosal bones. The dental formula is very variable, especially as regards the premolars, of which some at least in each genus are reduced to functionless rudiments, and may even vary in number on the two sides of the jaw of the same individual. The incisors are

always $\frac{1}{2}$, the lower one very large and inclined forwards, and the canines normally $\frac{1}{2}$, of which the inferior is always minute, and in one genus generally absent. The molars number either $\frac{3}{2}$ or $\frac{3}{4}$. All the species here discussed are included in the sub-family Phalangerinae, of which the distinctive features, as well as those of the family Phalangeridae, are referred to under MARSUPIALIA.

The most generalized representatives of the group appear to be the ring-tailed phalangers, constituting the genus *Pseudochirus*, which is common to Australia, Tasmania and New Guinea, and

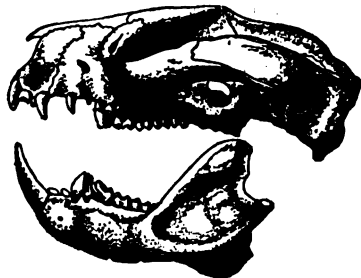

FIG. 1.—Skull of Grey Cuscus (*Phalanger orientalis*).

includes at least half a score of species. The dentition is generally $\frac{1}{2}$, $\frac{1}{2}$, $\frac{1}{2}$, $\frac{1}{2}$, $\frac{1}{2}$, $\frac{1}{2}$, $\frac{1}{2}$, $\frac{1}{2}$, but one upper incisor and the canine may be wanting. The crowns of the molars show a crescentic-structure, but they are said to retain the three primitive cusps, which are fused in the other genera. The prehensile tail has its tip naked for a short distance, and the whole of the terminal third and the under surface of the remainder short-haired, the tip being generally white. The hair is thick and woolly, and generally yellowish-olive in colour. These phalangers are the ring-tailed opossums of the Australians. From this genus is apparently derived the taguan flying-squirrel, or flying-phalanger (*Petaurides solans*), which ranges from Queensland to Victoria, and is the largest of the flying group. Its dentition is essentially similar to that of *Pseudochirus*, although there is one pair less of cheek-teeth, and the bushy tail is naked and prehensile at the tip. Reverting to the non-flying species, we have *Gymnobelides leadbeateri*, a small animal from Victoria representing a genus by itself, with the same dental formula as *Pseudochirus*, but cheek-teeth of a different type, the ears naked (instead of hairy) behind, glands on the chest and between the ears, and the tail long and evenly bushy to the tip. From this are evidently derived the flying-phalangers—flying-squirrels—of the genus *Petaurus*, which differ merely in the possession of a parachute, and are represented by several species, ranging from Australia (exclusive of Tasmania) to the Aru Islands, New Guinea, and New Ireland. Of the yellow-bellied species, *P. australis*, the habits are described by J. Gould as follows: "This animal is common in all the brushlands of New South Wales, particularly those which stretch along the coast from Port Philip to Moreton Bay. In these vast forests trees of one kind or another are perpetually flowering, and thus offer a never-failing supply of the blossoms upon which it feeds; the flowers of the various kinds of gums, some of which are of great magnitude, are the principal favourites. Like the rest of the genus, it is nocturnal in its habits, dwelling in holes and in the spouts of the larger branches during the day, and displaying the greatest activity at night while running over the small leafy branches, frequently even to their very extremities, in search of insects and the honey of the newly opened blossoms. Its structure being ill adapted for terrestrial habits, it seldom descends to the ground except for the purpose of passing to a tree too distant to be attained by springing from the one it wishes to leave. The tops of the trees are traversed by this animal with as much ease as the most level ground is by such as are destined for terra firma. If chased or forced to flight it ascends to the highest branch and performs the most enormous leaps, sweeping from tree to tree with wonderful address; a slight elevation gives its body an impetus which with the expansion of its membrane enables it to pass to a considerable distance, always ascending a little at the extremity of the leap; by this ascent the animal is prevented from receiving the shock which it would otherwise sustain."

A second species, *P. sciurus*, in some ways one of the most beautiful of all mammals, is shown in fig. 2.

A precisely similar relationship exists between the tiny feather-tailed phalanger, *Distochirus pennatus*, of New Guinea, and the equally minute pigmy flying-phalanger or flying-mouse, *Acrobates pygmaeus*, of Queensland, New South Wales and Victoria; both being characterized by the hairs of the tail forming a vane on each side, as well as by tufts of long hairs at the base of the thin-

haired ears. There are six pairs of cheek-teeth, of which the last three are small and rounded, with blunted cusps, while the anterior teeth are sharp and of insectivorous type. The pigmy flying-phalanger feeds on honey from flowers and insects.

To some extent intermediate in structure between *Acrobates* and *Petaurus*, although without a parachute, are the beautiful little dormouse-phalangers, as typified by *Dromicia nasa*, which range from Western Australia and Tasmania to New Guinea. They appear to be a generalized type, which has died out where they have come into competition with the more specialized forms. Although unable to fly they are exceedingly active, and take long leaps from bough to bough; externally they are characterized by their dormouse-

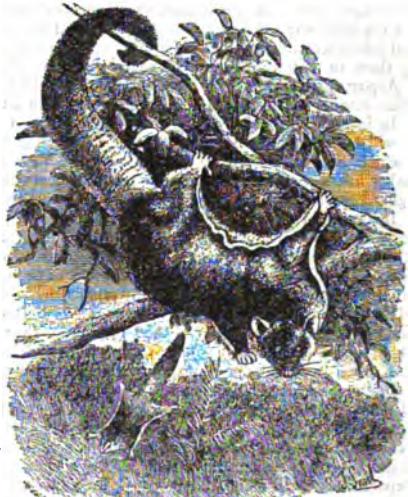

FIG. 2.—Squirrel Flying-Phalanger (*Petaurus sciurus*).

like form, large, thin, and nearly naked ears, without tufts inside or at the base, sharp and rudimentary front claws and long sharp hind ones, and mouse-like tail, which is furry at the base, then scaly, and naked and prehensile at the tip. There may be either six or seven pairs of cheek-teeth, of which the hinder carry four small smooth cusps, and the first upper incisor is much longer than the other two. The striped phalangers (*Dactylopsila*) are larger animals, of the approximate size of a squirrel, easily recognized by the longitudinal yellow and black striping of the fur, and the slender and elongated fourth front toe. The typical *D. trivirgata* is common to north Australia and New Guinea, but *D. fulvipes*, which has the fourth toe still more elongated, is exclusively Papuan. They have seven pairs of cheek-teeth, of which the four last are oblong and four-cusped, and the first lower incisor is longer than in any other phalanger. They apparently feed on both leaves and grubs, probably extracting the latter from cranicles with the elongated toe. The tail is more or less bare on the under side of the tip.

The last group of the sub-family is represented firstly by the cuscuses, or cuscuses (*Phalanger*), which are arboreal animals of the approximate size of cats, and range from the Solomon Islands through New Guinea and the Moluccas to Celebes, being, in fact, the only Old World marsupials found westwards of New Guinea. Externally they are characterized by their thick woolly fur, short or medium ears, which are hairy outside, and sometimes inside as well, by the naked and striated soles of the feet, and the long and markedly prehensile tail, of which the basal half is furred like the body, and the terminal half entirely naked. The number of cheek-teeth varies, owing to the frequent absence of some of the front ones, but there are generally seven pairs, of which the last four carry crescents internally and cusps externally. About ten species are known, of which the grey cuscus (*P. orientalis*) of Amboyna and Timor was discovered about 300 years ago, and was thus the first known Old World marsupial. In the spotted cuscus (*P. maculatus*) the males are marked with orange and white, while the females are uniformly greyish. Cuscuses are sleepy animals, feeding mainly on leaves, but also devouring birds and small mammals.

Nearly allied to the cuscuses are the typical Australian phalangers, or opossums, forming the genus *Trichosurus*. They differ from the cuscuses, among other features, by the thick and non-tapering tail being covered with bushy hair up to the extreme tip, which is naked, as is a narrow line along the middle of the terminal third

(or rather more) of the lower surface, by the presence of a gland on the chest, and by the soles of the hind feet being hairy. In the skull the upper canine is separated from the outermost incisor, instead of close to it as in the cuscuses (fig. 1). The best-known species is the brush-tailed phalanger, or brush-tailed opossum (*T. vulpecula*), of Australia, an animal of the size of a small fox, represented in Tasmania by the brown phalanger (*T. vulpecula fuliginosus*). The short-eared phalanger (*T. cassina*) represents the group in Southern Queensland and New South Wales. The dental formula in both is $\sigma, c. \frac{1}{1}, p. \frac{1}{1}, m. \frac{1}{1}$. These animals are wholly arboreal and mainly nocturnal in their habits; and it is these which form the chief game in "opossum-shooting" among the gum-trees by moonlight.

The long-snouted phalanger is referred to under **MARSUPIALIA**.

(R. L.)*

PHALANX (Gr. *φάλαγξ*, of unknown origin), the name, in Greek history of the arrangement of heavy-armed infantry in a single close mass of spearmen (see **ARMY: History**). In anatomy, the Latin plural *phalanges* is the term applied to the bones of the finger and toe, and in botany to a group of united stamen clusters. The term "phalanx" was adopted by F. C. M. Fourier (*q.v.*) as the name of the socialistic community living in a "phalanstery."

PHALARIS, tyrant of Agragas (Agrigentum) in Sicily, *c.* 570-554 B.C. He was entrusted with the building of the temple of Zeus Atabyrius in the citadel, and took advantage of his position to make himself despot (Aristotle, *Politics*, v. 10). Under his rule Agrigentum seems to have attained considerable prosperity. He supplied the city with water, adorned it with fine buildings, and strengthened it with walls. On the northern coast of the island the people of Himera elected him general with absolute power, in spite of the warnings of the poet Steachorus (Aristotle, *Rhetoric*, ii. 20). According to Suidas he succeeded in making himself master of the whole of the island. He was at last overthrown in a general rising headed by Telemachus, the ancestor of Theron (tyrant *c.* 488-472), and burned in his brazen bull.

After ages have held up Phalaris to infamy for his excessive cruelty. In his brazen bull, invented, it is said, by Perillus of Athens, the tyrant's victims were shut up and, a fire being kindled beneath, were roasted alive, while their shrieks represented the bellowing of the bull. Perillus himself is said to have been the first victim. There is hardly room to doubt that we have here a tradition of human sacrifice in connexion with the worship of the Phoenician Baal (Zeus Atabyrius) such as prevailed at Rhodes; when misfortune threatened Rhodes the brazen bulls in his temple bellowed. The Rhodians brought this worship to Cela, which they founded conjointly with the Cretans, and from Cela it passed to Agrigentum. Human sacrifices to Baal were common, and, though in Phoenicia proper there is no proof that the victims were burned alive, the Carthaginians had a brazen image of Baal, from whose down-turned hands the children slid into a pit of fire; and the story that Minos had a brazen man who pressed people to his glowing breast points to similar rites in Crete, where the child-devouring Minotaur must certainly be connected with Baal and the favourite sacrifice to him of children.

The story of the bull cannot be dismissed as pure invention. Fœder (*Polihid*, i. 183), who lived less than a century afterwards, expressly associates this instrument of torture with the name of the tyrant. There was certainly a brazen bull at Agrigentum, which was carried off by the Carthaginians to Carthage, whence it was again taken by Scipio and restored to Agrigentum. In later times the tradition prevailed that Phalaris was a naturally humane man and a patron of philosophy and literature. He is so described in the declamations ascribed to Lucian, and in the letters which bear his own name. Plutarch, too, though he takes the unfavourable view, mentions that the Sicilians gave to the severity of Phalaris the name of justice and a hatred of crime. Phalaris may thus have been one of those men who combine justice and even humanity with religious fanaticism (Suidas, *s.v.*: Diod. Sic. ix. 20, xiii. 90, xxiii. 25; Polybius vii. 7, xii, 25; Cicero, *De Officiis*, ii. 7, liii. 6).

The letters bearing the name of Phalaris (148 in number) are now chiefly remembered for the crushing exposure they received at the hands of Richard Bentley in his controversy with the Hon. Charles Boyle, who had published an edition of them in 1695. The first edition of Bentley's *Dissertation on Phalaris* appeared in 1697, and the second edition, replying to the answer which Boyle published in 1698, came out in 1699. From the mention in the letters of towns (Phintia, Albesa and Tauromenium) which did not exist in the time of Phalaris, from the imitations of authors (Herodotus, Democritus, Euripides, Callimachus) who wrote long after he was dead, from the reference to tragedies, though tragedy was not yet invented in the lifetime of Phalaris, from the dialect, which is not

Dorian but Attic, nay, New or Late Attic, as well as from absurdities in the matter, and the entire absence of any reference to them by any writer before Stobæus (*c.* A.D. 500), Bentley sufficiently proved that the letters were written by a sophist or rhetorician (possibly Adrianus of Tyre, died *c.* A.D. 192) hundreds of years after the death of Phalaris: Suidas admired the letters, which he thought genuine, and in modern times, before their exposure by Bentley, they were thought highly of by some (*e.g.* Sir William Temple in his *Essay on Ancient and Modern Learning*), though others, as Politianus and Erasmus, perceived that they were not by Phalaris. The latest edition of the *Epistles* is by R. Hercher, in *Epistolographi graeci* (1873), and of Bentley's Dissertation by W. Wagner (with introduction and notes, 1883); see especially R. C. Jebb, *Life of Bentley* (1882).

PHALLICISM, or **PHALLISM** (from Gr. *φάλλος*), an anthropological term applied to that form of nature worship in which adoration is paid to the generative function symbolized by the phallus, the male organ. It is common among primitive peoples, especially in the East, and had been prominent also among more advanced peoples, *e.g.* the Phoenicians and the Greeks. In its most elementary form it is associated with frankly orgiastic rites. This aspect remains in more advanced forms, but gradually it tends to give place to the joyous recognition of the principle of natural reproduction. In Greece for example, where phallicism was the essence of the Dionysiac worship and a phallic revel was the origin of comedy (see also **HERMES**), the purely material and the symbolical aspects no doubt existed side by side; the Orphic mysteries had to the intellectual Greeks a significance wholly different from that which they had to the common people. Phallic worship is specially interesting as a form of sympathetic magic: observing the fertilizing effect of sun and rain, the savage sought to promote the growth of vegetation in the spring by means of symbolic sexual indulgence. Such were the rites which shocked Jewish writers in connexion with the worship of Baal and Astartê (see **BAAL**, and cf. **ATARGATIS**, **ISHTAR**). The same principle is at the root of the widespread nature worship of Asia Minor, whose chief deity, the Great Mother of the Gods (*q.v.*), is the personification of the earth's fertility: similarly in India worship is paid to divine mothers. Generally it should be observed that phallic worship is not specially or perhaps primarily paid to male deities, though commonly the more important deity is accompanied by a companion of the other sex, or is itself androgynous, the two symbols being found together.

In the Dionysiac rites the emblem was carried at the head of the processions and was immediately followed by a body of men dressed as women (the *ilthyphalli*). In Rome the phallus was the most common amulet worn by children to avert the evil eye: the Latin word was *fascinum* (cf. Pliny, *Nat. Hist.* xix. 50, *satyrica signa*; Varro, *Ling. Lat.* vii. 97, ed. Müller). Pollux says that such emblems were placed by smiths before their forges. Before the temple of Aphrodite at Hierapolis (*q.v.*) were two huge phalli (180 ft. high), and other similar objects existed in all parts of the ancient world both in statuary and in painting. Among the Hindus (see **HINDUISM**) the phallus is called *linga* or *lingam*, with the female counterpart called *yoni*; the *linga* symbolizes the generative power of Siva, and is a charm against sterility. The rites classed together as *Sakti puja* represent the adoration of the female principle. In Mexico, Central America, Peru and other parts of America phallic emblems are found. The tendency, however, to identify all obelisk-like stones and tree-trunks, together with rites like circumcision, as remains of phallic worship, has met with much criticism (*e.g.* Robertson Smith, *Religion of the Semites*, 2nd ed., pp. 456 sqq.).

For authorities see works quoted under **RELIGION: §§ A and B ad fin.**

PHALTAN, a native state of India, in the central division of Bombay, ranking as one of the Satara jagirs. Area, 397 sq. m.; pop. (1901), 45,739, showing a decrease of 31% in the decade. The estimated revenue is £13,000, and the tribute £640. The chief, whose title is nimbalkar, is a Mahratta, tracing his descent to a grantee from a Delhi emperor in the 14th century. The town of Phaltan is 37 m. north-east of Satara; pop. (1901), 9512.

PHANARIOTES, a name derived from Phanar, the chief Greek quarter at Stamboul, where the oecumenical patriarchate is situated, and applied to those members of families resident in the Phanar quarter who between the years 1711 and 1821 were appointed hospodars of the Danubian principalities; that period of Moldo-Wallachian history is also usually termed the Phanariote epoch. It is not to be understood as marking the introduction into the principalities of the Greek element, which had already established itself firmly in both provinces, to both of which Greek princes had been appointed before the 18th century. But whereas the Greek families of earlier introduction gradually became merged in their country of adoption, the later immigrants retained their separate nationality and grew to be powerful agents for furthering the spread of Graecism in the principalities. The person raised to the princely dignity was usually the chief dragoman of the Sublime Porte, and was consequently well versed in contemporary politics and the statecraft of the Ottoman government. The new prince, who was compelled to purchase his elevation with a heavy bribe, proceeded to the country which he was selected to govern, and of the language of which he was in nearly every case totally ignorant, accompanied by a horde of needy hangers-on; he and his acolytes counted on recouping themselves in as short a time as possible for their initial outlay and in laying by a sufficiency to live on after the termination of the prince's brief authority. It was the interest of the Porte to change the princes as often as possible, as the accession donation thus became due more frequently. When, owing to the numerous cases of treachery among the princes, the choice became limited to a few families the plan was hit upon of frequently shifting the prince from one province to the other: the prince of Wallachia, the richer of the two principalities, was always ready to pay a handsome *donceur* to avert his transfer to Yassy; the prince of Moldavia was equally ready to bribe his supporters at Constantinople to secure his appointment to Wallachia. To raise funds to satisfy the rapacity of the Porte the princes became past masters in the art of spoliation, and the inhabitants, liable to every species of tax which the ingenuity of their Greek rulers could devise, were reduced to the last stage of destitution. The active part taken by the Greek princes in the revolt of 1820-21 induced the Porte to revert to the appointment of native princes.

PHANIAS, of Eretria in Lesbos, Greek philosopher, important as an immediate follower of and commentator on Aristotle, came to Athens about 332 B.C., and joined his compatriot, Theophrastus, in the Peripatetic school. He wrote works entitled *Analytica*, *Categoriae* and *De interpretatione*, which were either paraphrases or critical commentaries, and seem to have added little to Aristotle's own writings. Alexander of Aphrodisias refers to a work *ὑπὸς Διδώκωρον*, and Athenaeus quotes from another treatise, *Against the Sophists*. Outside philosophy, he and Theophrastus carried on the physical investigations of Aristotle; Athenaeus frequently quotes from a work on botany which manifests great care in definitions and accuracy of observation. From Plutarch (*Life of Themistocles*) we learn that he was regarded as an historian of importance. The chief of his historical works is the *Prytanis Eresii*, which was either a history of his native place or a general history of Greece arranged according to the period of the Eresian magistracy. He wrote also works on the *Tyrants of Sicily* and on tyranny in general. The value of these books is attested by the frequency with which they are quoted on questions of chronology (e.g. by Plutarch, Suidas, Athenaeus). To the history of Greek literature he contributed works on the poets and on the Socratics; both of which are quoted.

He must be distinguished from another Phanius, a Stoic philosopher, disciple of Posidonius. Diogenes Laertius mentions a work of his wherein he compares Posidonius with Panaetius in arguing from physical principles.

PHANOCLES, Greek elegiac poet, probably flourished about the time of Alexander the Great. His extant fragments show resemblances in style and language to Philetas, Callimachus and Hermesianax. He was the author of a poem on paederasty. A lengthy fragment in Stobaeus (*Florilegium*, 64) describes



the love of Orpheus for the youthful Calais, son of Boreas, and his subsequent death at the hands of the Thracian women. It is one of the best extant specimens of Greek elegiac poetry.

See N. Bach, *Philetas, Hermesianactis, et Phanoclis reliquiae* (1829); L. Preller, *Ausgewählte Aufsätze aus dem Gebiete der classischen Alterthumswissenschaft* (1864).



PHANTASMAGORIA, a name invented by a certain Philopast in 1802 (from Gr. *phantasma*, phantasm, apparition; and *ἀγορά*, assembly) for a show or exhibition of optical illusions produced by means of the projecting lantern (*q.v.*). The word has since been applied to any rapidly or strikingly changing scene, and especially to a disordered or fantastic scene or picture of the imagination.

PHARAOH (Par'oh), the Hebrew title of the king of Egypt (*q.v.*), in Egyptian Per'-o; Pheron in Herodotus represents the same. Its combination with the name of the king, as in Pharaoh-Necho, Pharaoh-Hophra, is in accordance with contemporary native usage: the name of the earlier Pharaoh Shishak (Sheshonk) is rightly given without the title. In hieroglyphic a king bears several names preceded by distinctive titles. In the IVth Dynasty there might be four of the latter: (1)  identifying

him with the royal god Horus; the name is commonly written in a frame  representing the façade of a building, perhaps a palace or tomb, on which the falcon stands. (2)

 connecting him with the vulture and uraeus goddesses, Nekhabet and Buto of the south and north. (3) 

a hawk a symbol of gold, signifying the victorious Horus.

(4)  the old titles of the rulers of the separate kingdoms of Upper and Lower Egypt, to be read *stni*, "butcher(?)" and *hyti*, "beekeeper(?)". The personal name of the king followed (4), and was enclosed in a cartouche  apparently symbolizing the circuit of the sun which alone bounded the king's rule. Before the IVth Dynasty the cartouche is seldom found: the usual title is (1), and (3) does not occur. In the Vth Dynasty the custom began of giving the king at his accession a special name connecting him with the sun: this was placed in the cartouche after (4), and a fifth title was added: (5)  Si-ré, "son of the Sun-god," to precede

a cartouche containing the personal name. The king was briefly spoken of by his title *stni* (see 4), or *hnm-f*, "his service," or *Ity*, "liege-lord." These titles were preserved in the sacred writing down to the latest age. An old term for the royal palace establishment and estate was Per'-o, "the Great House," and this gradually became the personal designation of Pharaoh (cf. the Grand Porte), displacing all others in the popular language. (F. L. G.)

PHARI, a town of Tibet. It is supposed to be the highest and coldest town in the world, being 15,000 ft. above the sea. As it commands the road between the Chumbi Valley and Lhasa and also one of the chief passes into Bhutan, Phari is of considerable military importance, and is defended by a large fort or Jang, which was occupied by the British expedition of 1904. Phari Jang is supposed to have been built about 1500 A.D., and was enlarged or rebuilt in 1792, under Chinese advice, as a defence against the British. It has the appearance of a medieval castle, and seems to have been built in imitation of the European style.

PHARISEES, a sect of the Jews first mentioned by Josephus, in his account (*Ant.* xiii. 5, 9) of the reign of Jonathan, the brother and successor of Judas Maccabaeus. The name, which may be translated "Separatists," indicates their devotion to the ideal, enforced by Ezra and Nehemiah upon the reluctant Jews, of a nation separate from all other nations in virtue of its

peculiar relation to Yahweh (Neh. ix.). This ideal nation consisted of all who were prepared to obey the Law of Moses, irrespective of their natural descent. Consequently the Pharisees, who seem to have been an order of religious teachers, were concerned to make converts (proselytes), and some of their greatest teachers were of non-Jewish parentage. They were also concerned to insist upon the strict observance of the Law, so far as it was compatible with the exigencies of ordinary life, and to train disciples who should set a proper example to the mass of the people.

The ideal of separation descended from the Great Synagogue (Assembly) of the time of Ezra to the Synagogue of the Hasidæans (Assidæans), who allied themselves with Judas Macca-bæus when his followers decided to suspend the law of the Sabbath, in order that the true Jews might preserve themselves from annihilation and survive to keep the Law as a whole. This action of the Hasidæans is clearly the practical outcome of the principle which Josephus describes in the language of philosophy as the characteristic of the Pharisees—"some things and not all are the work of Fate" (*Ant.* xiii. 5, 9). Fate is the Stoic term for God; and these forerunners of the Pharisees judged that the time had come for them to take action rather than to wait passively on God. But then and always the prime concern of the Pharisees was the extension of God's sovereignty (the Kingdom of God) throughout the world. God's will, which all men should obey, was revealed in the Law, and though He might appoint governors over them, He remained their King, and no governor who was not a prophet—God's mere mouthpiece—could command their unquestioning obedience. When Judas reconquered Jerusalem and re-dedicated the desecrated Temple, his work, from the Pharisees' point of view, was done. The Temple-ship was part and parcel of the Divine plan, and a legitimate High Priest was necessary. Alanus was, therefore, welcomed by the Hasidæans, and only his treacherous murder of sixty of their number taught them that any Syrian nominee was their enemy. Later they acquiesced in the election of Simon to the high-priesthood with the condition "until there should arise a faithful prophet"; but some of them remonstrated against the combination of the sacred office with the position of political ruler in the person of John Hyrcanus as contrary to the precedent set by Moses at his death. When Alexandra came to the throne the Pharisees were the real rulers and imposed upon the people the deductions from the written Law which formed the growing body of their oral tradition. Their reign was long enough to establish this tradition in respect of ritual, and even when this golden age—as it seemed to later Scribes—was over they exercised a paramount influence upon the common people. They had learned to read God's will in the events of history, and deduced (for example) the doctrine of the resurrection of the dead from the death of the martyrs under Antiochus Epiphanes and Alcimus. And what they learned from current history and from the ancient history of the nation recorded in Scripture they taught in the synagogues, which corresponded not merely to the parish churches but also to the schools—day schools and Sunday schools—of to-day. Apart from their control of public education, their power was enhanced by their efforts to better the position of women, and by their notorious leniency in the matter of punishments. Everything—the repeated statements of Josephus and the facts of Jewish history after A.D. 70—goes to show that the Pharisees moulded the religion of the people. Attempts have been made in modern times to represent the Apocalypists as opposed to the Pharisees and as occupying the position in popular estimation which Josephus ascribes to the Pharisees. But for such representations there is no solid ground. Superficially the language of apocalypses differs from that of rabbinic decisions, and where the seer takes a comprehensive view of the ages the rabbi legislates for particular cases. But even in the Talmud the reign of Alexandra is described in apocalyptic language such as is commonly applied to the future age, and if allowance be made for the symbolism proper to revelations it is clear that essentially the scribe and the seer have the same purpose and even the same doctrines. The Pharisees were occupied with the

piecemeal realization of the dreams of their supposed opponents; which gain a vague glory from their being far off.

The gospels generally have left upon the minds of men an impression unfavourable to the Pharisees. They contain denunciations attributed to our Lord and assigned—with obvious injustice in some cases—to the scribes of this sect. It is to be remembered that the Pharisees were the only sect of the Jews who survived in Christian times and that the Pharisees were never a homogeneous body possessed of a definite policy or body of doctrine. Moreover it is clear that our Lord denounced not all the Pharisees but the hypocrites only, as did the rabbis whose sayings are reported in the Talmud and other Jewish books. Again the third gospel in particular betrays relations between the Pharisees and Jesus very different from those of the common Christian view, which conjures up an impossible picture of an absolute breach between the Prophet of Nazareth and the whole corporation of the Pharisees as a result of a quarrel with certain members of that dissident sect of independent thinkers. Gamaliel and his pupil St Paul are better representatives of the non-hypocritical Pharisee; and the Pauline Epistles or the writings of Philo are the best extant examples of the manner and matter of their teaching. As for the denunciations, apart from the charge of insincerity, it appears that the scribes in question are pilloried for the defects—or the excesses—of their qualities. Indeed they are corroborative evidence for the reverence with which the Pharisees were regarded by the people generally, and for the zeal with which they strove to fulfil God's will as contained in the Law and elucidated by the Tradition. (J. H. A. H.)

PHARMACOLOGY. Systematic writers on the subject differ considerably in the exact meaning which they attach to the term pharmacology (*φάρμακον*, a drug; *λόγος*, a discourse), some making it much more comprehensive than others. Binz, for instance, defines it as treating of the origin, nature, chemical and physical qualities, physiological actions, and therapeutical uses of drugs; in France and in Italy it is restricted to the mere description of medicines and their preparations, the action and uses of which as remedies are included in the term therapeutics. In English-speaking countries, and by the majority of German writers, the meaning is now restricted to the study of the action of chemical substances (as apart from foods) on all kinds of animals, from bacteria up to man; it is, in fact, a comparative study of the action of chemical bodies on invertebrate and vertebrate animals. One of its practical aims is to obtain a wide and accurate knowledge of remedial substances in relation to their application in the treatment of disease, while another is to discover new or improved remedies. This meaning of the word has now become fixed in the English language by use and wont. The term pharmacodynamics (*φάρμακον*, *δυναμικόν*, power), which is etymologically more correct, is often used as its equivalent, but it has never become widely adopted. The study of pharmacological actions was at first almost entirely confined to those of remedial agents, and especially to the remedies in the different national pharmacopœias, but in many cases it has now been extended to substances which are not used for curative purposes. The introduction into practical use of many medicines, such as paraldehyde, phenazone and strophanthus, has followed the study of their actions on animals, and this tends to be more and more the case. Pharmacology is a branch of biology; it is also closely connected with pathology and bacteriology, for certain drugs produce structural as well as functional changes in the tissues, and in germ diseases the peculiar symptoms are caused by foreign substances (toxins) formed by the infective organisms present in the body. The effects of many of these toxins bear a close resemblance to the action of certain well-known drugs, as in the case of tetanus toxin and strychnine, and are studied by the same methods of observation and research. It is impossible also to dissociate pharmacology from clinical therapeutics; the former investigates the agents which are used in the treatment of disease, the latter is concerned with their remedial powers and the conditions under which they are to be used. Hence the word "pharmaco-therapy" has come into

use, and most of the newer standard textbooks combine together the consideration of pharmacology and therapeutics. Pharmacology is also related to toxicology, as many remedial and other agents are more or less poisonous when given in large doses, but it does not include the detection, tests, and the other strictly medico-legal aspects of poisoning.

Pharmacology proper began as the result of the application of strictly experimental methods to physiology. The discovery (early in the 10th century) that plants owe their remedial and poisonous qualities to small quantities of definite active principles, such as alkaloids and neutral bodies, which can be extracted in a chemically pure condition, had also a very important effect on its development. We meet first with experiments made by investigators who perceived that observations on man and animals might lead to a better understanding of the action of drugs. In 1676 Wepfer and Conrad Brunner demonstrated on dogs the tetanizing action of nuxvomica, and similar rough experiments were repeated from time to time with other substances by later investigators. In 1755 Menghini published an elaborate study of the action of camphor on a great variety of different kinds of animals. Albert von Haller (b. 1708) sought to elucidate the action of remedies by observations on healthy men, and in 1767 William Alexander made experiments on himself with drugs, which were, however, brought to an abrupt termination by his nearly killing himself. In 1776 Daries, by observations on himself and on cats, established the mydriatic action of belladonna and other atropaceous plants. Hitherto no attempt had been made to determine what particular parts of the body were especially affected by drugs, but Fontana showed, in his great work (Florence, 1765) on the venom of the viper and on other poisons, that the general symptoms were brought about by an action on particular organs. He performed more than six thousand experiments, more than four thousand of which were on animals, and he determined the effects on the heart and other important structures. These analytical methods of research were well known to the second Monro in Edinburgh, and to his pupils, one of whom, William Alexander, wrote a thesis in 1790 entitled "De partibus corporis animalis quae viribus opii parent." His methods were doubtless known also to the French physiologist Magendie, who improved upon them, and who in 1809 published a research on the Upas Tieuté and other strychnine-containing plants, in which he showed that their effects were due to an action on the spinal cord. The researches of his pupil, Claude Bernard, on curare, were equally exact and logical, and have served as the model for many subsequent investigations. In consequence, from the time of Magendie pharmacology may be said to have been put on a more exact basis. By the middle of the 19th century there were many workers on the subject, and the actions of such drugs as digitalis, morphine, alcohol, and many others had been frequently and minutely investigated. About this time Buchheim, professor of materia medica in Dorpat from 1846 to 1879, founded the first pharmacological laboratory on modern lines in Europe, and he introduced a more rational classification of drugs than had hitherto been in use, arranging them in groups according to their pharmacological actions. In the herbals and older treatises on materia medica and therapeutics no explanation is usually offered of the action of medicines, and in such works as that of Cullen (1789) only a few of the more obvious actions are occasionally explained according to the current theories of physiology and pathology. In works such as Pereira's *Elements of Materia Medica and Therapeutics* (1842), the physiological effects of medicines are usually described, but very briefly as compared with the materia medica. At the present day most textbooks dealing with medicinal agents and treatment devote a large part of their space to pharmacology, and a corresponding change has taken place in the teaching of the subject in universities and medical schools. Since Magendie's time numerous papers dealing with pharmacological subjects have appeared in the *Journal of Anatomy and Physiology*, the *Journal of Physiology*, Virchow's *Archiv*, and the principal medical periodicals of all countries. In 1873 the *Archiv für experimentelle Pathologie und Pharmakologie* first appeared,

in 1895 the *Archives Internationales de Pharmacodynamie*, and in 1909 *The Journal of Pharmacology and Therapeutics* (published at Baltimore, U.S.A.), all of which are chiefly or entirely devoted to pharmacology.

The methods of research are essentially those employed by physiologists, the action of substances being studied in the usual way on bacteria, leucocytes, frogs, rabbits and other animals. Not only are the general symptoms investigated, but it is necessary to carry out experiments on the nerves, muscles, circulation, secretions, &c., so as to get a more exact knowledge of the reasons of the general action. It is true that many of these animals react somewhat differently to drugs, both as regards each other and as regards man, but for the most part the differences are quantitative rather than qualitative. After carrying out a series of observations on animals, the drug can be assigned to its special group, and a good idea can be obtained of its possible practical value or the reverse; hence there is a saving of time and an avoidance of the necessity of testing its effects on man. The action of a drug may be called direct when it acts on any part to which it is immediately applied, or which it may reach through the blood; and indirect when one organ is affected secondarily to another, as, for instance, in strychnine poisoning when the muscles are violently contracted as the result of the action of the alkaloid upon the spinal cord. In a few cases the action is merely physical, but most frequently it is chemical in its nature, and is exerted on the living cell, the activity of which is either stimulated or depressed. In some cases the substances actually enter into a chemical combination with the protoplasm, which may be temporary or (much less frequently) permanent; in other cases they seem simply to modify or disturb the usual chemical activity of the cells. Prolonged or excessive stimulation invariably leads to depression or paralysis, the tissues becoming fatigued, and from this condition they may recover or they may not. When we come to consider more in detail the results of these actions we find that the various secretions of the body, such as the sweat, gastric juice, bile, milk, urine, &c., may be increased or diminished; that the heart may have its muscular or nervous apparatus stimulated or depressed; that the nerve-centres in the brain, medulla and spinal cord may be rendered more sensitive or the reverse; and that the general metabolism of the body may be altered in various ways. In addition, the fluid constituents, such as the lymph and blood, may have their composition and bulk considerably altered, while the special senses, the temperature, and, in short, every function and tissue, may be more or less affected.

Some drugs given in excess are poisons to all forms of protoplasm, but when given in doses much short of the lethal they usually exhibit a distinct tendency to affect specially, and at an early period, certain organs or tissues, and hence result differences in action; others may act only on certain organs, leaving the others practically untouched. It is often possible by appropriate dosage to contrive that these special parts or organs may be affected and the rest of the body left practically intact, and it is by taking advantage of these selective actions that remedial or therapeutical effects are usually obtained. Some substances have a very wide range of action, and involve a great variety of structures, while others, such as purgatives, have a very limited sphere. The action of drugs is often modified by circumstances peculiar to the individuals or animals to whom they are administered. In man the most important of these circumstances is age, but speaking broadly this is really a question of bulk, the child being affected like the adult, but by smaller doses. There are exceptions to this, however, as children are more affected in proportion by opium and some other substances, and less by mercury and arsenic. In old age also the nervous system and the tissues generally do not react so readily as in youth. Habit, race, personal temperament, emotional conditions, disease, the time and circumstances of administration, and other accidental causes may also modify the action in man. Some species of animals are much more susceptible to the action of certain drugs than others, a condition which depends on obvious

Action of
Drugs.

or unknown structural or metabolic differences. In the same way some individuals show a special tendency to poisoning by doses of certain drugs which are harmless to the great majority of mankind, and hence we get unexpected or unusual results, these arising from special susceptibility on the part of certain organs. These idiosyncrasies are not confined to drugs, but are seen with a few articles of food, such as eggs and shellfish. It is well known that the habitual consumption of certain drugs, such as tobacco, Indian hemp, opium, arsenic, alcohol and many others, gradually induces a condition of tolerance to their effects, so that large doses can be taken without causing symptoms of poisoning. In all cases, however, there is a limit, and after it is reached the ordinary effects of these substances are seen. Some individuals, however, never become tolerant, and show poisonous effects on each repetition of the dose. The degree of tolerance often differs in individuals at different times and in different circumstances, and may become lost by breaking off the habit for a short time. The explanation generally given is that the nerve and other cells become accustomed to the drug, so that they cease to react, or that an antitoxin is formed which antagonizes the poison, or that the poison is rapidly destroyed in the body. Recent researches on arsenic and atropine, however, point to the leucocytes as playing an important part in the production of tolerance, as these gradually become capable of ingesting large amounts of the foreign substances, and thus render them more or less harmless to the tissues, until they are gradually excreted from the body. When the amount is too large to be dealt with by the leucocytes, poisoning seems to occur even in the most habituated. Tolerance is therefore analogous to, but not identical with, the immunity which takes place with the toxins of infectious diseases and snake poison. Certain substances, notably digitalis, lead, mercury and strychnine, exhibit what is called a cumulative action—that is to say, when small quantities have been taken over a period of time, poisoning or an excessive action suddenly ensues. The explanation in these cases is that the drug is absorbed more rapidly than it is excreted, hence there is a tendency to accumulation in the body until a point is reached when the amount becomes poisonous.

Bodies which have a close resemblance in their chemical constitution exhibit a similar resemblance in their pharmacological action, and as the constitution of the substance becomes modified chemically so does its action pharmacologically. Numerous researches have demonstrated these points with regard to individual groups of substances, but hitherto it has not been possible to formulate any fixed laws regarding the relationship between chemical constitution and physiological action.

When drugs are swallowed no absorption may take place from the alimentary canal; but, as a rule, they pass from there into the blood. Absorption may also take place from the skin, from the rectum, from the respiratory passages, or from wounds, and from direct injection into the subcutaneous tissue or into a blood vessel. Very rarely, as in the case of silver salts, excretion does not take place; but usually the drug is got rid of by the ordinary channels of elimination. Just as drugs act upon the tissues, so they themselves are in many cases reacted upon, and broken up or altered. While in the alimentary canal they are subjected to the action of the digestive fluids and the varied contents of the stomach and intestines, and after absorption they come under the influence of the constituents of the blood and lymph, and of the chemical action of the tissue cells. Inorganic bodies, such as metals, may enter into albuminous combinations which may greatly modify their effects, and organic substances may be split up into simpler compounds by oxidation or reduction, or may be rendered more complex by synthesis.

The antagonism between certain drugs has been much studied in relation to their use as antidotes in poisoning, the aim being to counteract the effects rather than to obtain a direct physiological antagonistic action. Substances which directly antagonize each other by acting on the same tissue are few in

number, but there are numerous instances in which the effects or symptoms may be obviated by acting on another tissue. Thus curare may stop strychnine convulsions by paralyzing the terminations of motor nerves, and chloroform may exercise the same effect by abolishing the irritability of the spinal cord. If two poisons act on the same tissue, one stimulating and the other paralyzing it, the paralyzing substance removes the action of the stimulant substance, not by bringing the tissue back to its normal state, but by abolishing its excitability; hence, although life may be saved by such an action, yet it can only be so within certain limits of dosage, because the antagonism is never complete at every point.

Speaking in the widest sense, every substance has an action on living protoplasm, but for convenience pharmacological substances have come to be limited to those which are used as drugs, or which have a distinct action upon the animal organism. Such substances are derived from (1) the chemical elements and their compounds; (2) plants; and (3) animals. The first class includes such substances as iodine, mercury, iron, carbon, and their various compounds, and such bodies as alcohol, chloroform and chloral, all of which are found in nature or can be prepared by ordinary chemical processes of manufacture. From plants many substances are obtained which at the present time we are unable to make in the chemical laboratory, and of the constitution or composition of which we are in many cases ignorant. Some of these, such as resins, gums, essential oils and fats, are readily obtained as natural exudations or by very simple manipulations, while others, such as the alkaloids, glucosides and vegetable acids, often require to be extracted by very complex processes. Substances obtained from animals include gland secretions, pepsin and other ferments, musk, cod-liver oil, &c., and to these may be added various antitoxins. The classification of substances having pharmacological actions presents so many difficulties that no satisfactory or universally adopted method has yet been proposed. Our knowledge presents so many gaps, and the mode of action of many remedies is so obscure and imperfectly understood, that any arrangement adopted must be more or less tentative in character. The close alliance between pharmacology, therapeutics and clinical medicine has induced many authors to treat the subject from a clinical point of view, while its relationships to chemistry and physiology have been utilized to elaborate a chemical and physiological classification respectively as the basis for systematic description. Certain writers in despair have adopted an alphabetical arrangement of the subject, while others have divided it up into inorganic, vegetable and animal substances. These last-mentioned methods are far behind our present state of knowledge, and need not be discussed here. The objection to a strictly chemical classification is, that while many substances closely allied chemically have a somewhat similar action in certain respects, yet in others they differ very widely—a striking example of which is given in the case of sodium and potassium. A physiological classification according to an action on the brain, heart, kidney or other important organ becomes still more bewildering, as many substances produce the same effects by different agencies, as, for instance, the kidneys may be acted upon directly or through the circulation, while the heart may be affected either through its muscular substance or its nervous apparatus. A clinical or therapeutical classification into such divisions as anaesthetics, expectorants, bitters, and so on, according to their practical applications, also leads to difficulties, as many drugs are employed for numerous purposes. The ideal method of grouping pharmacological substances would be in reference to their chemical action on living protoplasm, but as yet our knowledge is too scanty for this. At the present time the method adopted by Buchheim, or some modification of it, is the most scientific. As the result of painstaking investigations he grouped together all those substances having similar actions, giving to each group the name of its best-known or most thoroughly investigated member. Once the groups were more or less fixed any new substance could, when

Classification.

use, and most of the newer standard textbooks combine together the consideration of pharmacology and therapeutics. Pharmacology is also related to toxicology, as many remedial and other agents are more or less poisonous when given in large doses, but it does not include the detection, tests, and the other strictly medico-legal aspects of poisoning.

Pharmacology proper began as the result of the application of strictly experimental methods to physiology. The discovery

(early in the 10th century) that plants owe their remedial and poisonous qualities to small quantities of definite active principles, such as alkaloids and neutral bodies, which can be extracted in a chemically pure condition, had also a very important effect on its development. We meet first with experiments made by investigators who perceived that observations on man and animals might lead to a better understanding of the action of drugs. In 1676 Wepfer and Conrad Brunner demonstrated on dogs the tetanizing action of nuxvomica, and similar rough experiments were repeated from time to time with other substances by later investigators. In 1755 Menghini published an elaborate study of the action of camphor on a great variety of different kinds of animals. Albert von Haller (b. 1708) sought to elucidate the action of remedies by observations on healthy men, and in 1767 William Alexander made experiments on himself with drugs, which were, however, brought to an abrupt termination by his nearly killing himself. In 1776 Daries, by observations on himself and on cats, established the mydriatic action of belladonna and other atropaceous plants. Hitherto no attempt had been made to determine what particular parts of the body were especially affected by drugs, but Fontana showed, in his great work (Florence, 1765) on the venom of the viper and on other poisons, that the general symptoms were brought about by an action on particular organs. He performed more than six thousand experiments, more than four thousand of which were on animals, and he determined the effects on the heart and other important structures. These analytical methods of research were well known to the second Monro in Edinburgh, and to his pupils, one of whom, William Alexander, wrote a thesis in 1790 entitled "De partibus corporis animalis quae viribus opii parent." His methods were doubtless known also to the French physiologist Magendie, who improved upon them, and who in 1809 published a research on the Upas Tieut and other strychnine-containing plants, in which he showed that their effects were due to an action on the spinal cord. The researches of his pupil, Claude Bernard, on curare, were equally exact and logical, and have served as the model for many subsequent investigations. In consequence, from the time of Magendie pharmacology may be said to have been put on a more exact basis. By the middle of the 19th century there were many workers on the subject, and the actions of such drugs as digitalis, morphine, alcohol, and many others had been frequently and minutely investigated. About this time Buchheim, professor of materia medica in Dorpat from 1846 to 1879, founded the first pharmacological laboratory on modern lines in Europe, and he introduced a more rational classification of drugs than had hitherto been in use, arranging them in groups according to their pharmacological actions. In the herbals and older treatises on materia medica and therapeutics no explanation is usually offered of the action of medicines, and in such works as that of Cullen (1789) only a few of the more obvious actions are occasionally explained according to the current theories of physiology and pathology. In works such as Parcival's *Elements of Materia Medica and Therapeutics* (1842), the physiological effects of medicines are usually described, but very briefly as compared with the materia medica. At the present day most textbooks dealing with medicinal agents and treatment devote a large part of their space to pharmacology, and a corresponding change has taken place in the teaching of the subject in universities and medical schools. Since Magendie's time numerous papers dealing with pharmacological subjects have appeared in the *Journal of Anatomy and Physiology*, the *Journal of Physiology*, Virchow's *Archiv*, and the principal medical periodicals of all countries. In 1873 the *Archiv für experimentelle Pathologie und Pharmakologie* first appeared,

in 1895 the *Archives Internationales de Pharmacodynamie*, and in 1909 *The Journal of Pharmacology and Therapeutics* (published at Baltimore, U.S.A.), all of which are chiefly or entirely devoted to pharmacology.

The methods of research are essentially those employed by physiologists, the action of substances being studied in the usual way on bacteria, leucocytes, frogs, rabbits and other animals. Not only are the general symptoms investigated, but it is necessary to carry out experiments on the nerves, muscles, circulation, secretions, &c., so as to get a more exact knowledge of the reasons of the general action. It is true that many of these animals react somewhat differently to drugs, both as regards each other and as regards man, but for the most part the differences are quantitative rather than qualitative. After carrying out a series of observations on animals, the drug can be assigned to its special group, and a good idea can be obtained of its possible practical value or the reverse; hence there is a saving of time and an avoidance of the necessity of testing its effects on man. The action of a drug may be called direct when it acts on any part to which it is immediately applied, or which it may reach through the blood; and indirect when one organ is affected secondarily to another, as, for instance, in strychnine poisoning when the muscles are violently contracted as the result of the action of the alkaloid upon the spinal cord. In a few cases the action is merely physical, but most frequently it is chemical in its nature, and is exerted on the living cell, the activity of which is either stimulated or depressed. In some cases the substances actually enter into a chemical combination with the protoplasm, which may be temporary or (much less frequently) permanent; in other cases they seem simply to modify or disturb the usual chemical activity of the cells. Prolonged or excessive stimulation invariably leads to depression or paralysis, the tissues becoming fatigued, and from this condition they may recover or they may not. When we come to consider more in detail the results of these actions we find that the various secretions of the body, such as the sweat, gastric juice, bile, milk, urine, &c., may be increased or diminished; that the heart may have its muscular or nervous apparatus stimulated or depressed; that the nerve-centres in the brain, medulla and spinal cord may be rendered more sensitive or the reverse; and that the general metabolism of the body may be altered in various ways. In addition, the fluid constituents, such as the lymph and blood, may have their composition and bulk considerably altered, while the special senses, the temperature, and, in short, every function and tissue, may be more or less affected.

Some drugs given in excess are poisons to all forms of protoplasm, but when given in doses much short of the lethal they usually exhibit a distinct tendency to affect specially, and at an early period, certain organs or tissues, and hence result differences in action; others may act only on certain organs, leaving the others practically untouched. It is often possible by appropriate dosage to contrive that these special parts or organs may be affected and the rest of the body left practically intact, and it is by taking advantage of these selective actions that remedial or therapeutical effects are usually obtained. Some substances have a very wide range of action, and involve a great variety of structures, while others, such as purgatives, have a very limited sphere. The action of drugs is often modified by circumstances peculiar to the individuals or animals to whom they are administered. In man the most important of these circumstances is age, but speaking broadly this is really a question of bulk, the child being affected like the adult, but by smaller doses. There are exceptions to this, however, as children are more affected in proportion by opium and some other substances, and less by mercury and arsenic. In old age also the nervous system and the tissues generally do not react so readily as in youth. Habit, race, personal temperament, emotional conditions, disease, the time and circumstances of administration, and other accidental causes may also modify the action in man. Some species of animals are much more susceptible to the action of certain drugs than others, a condition which depends on obvious

Action of Drugs.

or unknown structural or metabolic differences. In the same way some individuals show a special tendency to poisoning by doses of certain drugs which are harmless to the great majority of mankind, and hence we get unexpected or unusual results, these arising from special susceptibility on the part of certain organs. These idiosyncrasies are not confined to drugs, but are seen with a few articles of food, such as eggs and shellfish. It is well known that the habitual consumption of certain drugs, such as tobacco, Indian hemp, opium, arsenic, alcohol and many others, gradually induces a condition of tolerance to their effects, so that large doses can be taken without causing symptoms of poisoning. In all cases, however, there is a limit, and after it is reached the ordinary effects of these substances are seen. Some individuals, however, never become tolerant, and show poisonous effects on each repetition of the dose. The degree of tolerance often differs in individuals at different times and in different circumstances, and may become lost by breaking off the habit for a short time. The explanation generally given is that the nerve and other cells become accustomed to the drug, so that they cease to react, or that an antitoxin is formed which antagonizes the poison, or that the poison is rapidly destroyed in the body. Recent researches on arsenic and atropine, however, point to the leucocytes as playing an important part in the production of tolerance, as these gradually become capable of ingesting large amounts of the foreign substances, and thus render them more or less harmless to the tissues, until they are gradually excreted from the body. When the amount is too large to be dealt with by the leucocytes, poisoning seems to occur even in the most habituated. Tolerance is therefore analogous to, but not identical with, the immunity which takes place with the toxins of infectious diseases and snake poison. Certain substances, notably digitalis, lead, mercury and strychnine, exhibit what is called a cumulative action—that is to say, when small quantities have been taken over a period of time, poisoning or an excessive action suddenly ensues. The explanation in these cases is that the drug is absorbed more rapidly than it is excreted, hence there is a tendency to accumulation in the body until a point is reached when the amount becomes poisonous.

Bodies which have a close resemblance in their chemical constitution exhibit a similar resemblance in their pharmacological action, and as the constitution of the substance becomes modified chemically so does its action pharmacologically. Numerous researches have demonstrated these points with regard to individual groups of substances, but hitherto it has not been possible to formulate any fixed laws regarding the relationship between chemical constitution and physiological action.

When drugs are swallowed no absorption may take place from the alimentary canal; but, as a rule, they pass from there into the blood. Absorption may also take place from the skin, from the rectum, from the respiratory passages, or from wounds, and from direct injection into the subcutaneous tissue or into a blood vessel. Very rarely, as in the case of silver salts, excretion does not take place; but usually the drug is got rid of by the ordinary channels of elimination. Just as drugs act upon the tissues, so they themselves are in many cases reacted upon, and broken up or altered. While in the alimentary canal they are subjected to the action of the digestive fluids and the varied contents of the stomach and intestines, and after absorption they come under the influence of the constituents of the blood and lymph, and of the chemical action of the tissue cells. Inorganic bodies, such as metals, may enter into albuminous combinations which may greatly modify their effects, and organic substances may be split up into simpler compounds by oxidation or reduction, or may be rendered more complex by synthesis.

The antagonism between certain drugs has been much studied in relation to their use as antidotes in poisoning, the aim being to counteract the effects rather than to obtain a direct physiological antagonistic action. Substances which directly antagonize each other by acting on the same tissue are few in

number, but there are numerous instances in which the effects or symptoms may be obviated by acting on another tissue. Thus curare may stop strychnine convulsions by paralyzing the terminations of motor nerves, and chloroform may exercise the same effect by abolishing the irritability of the spinal cord. If two poisons act on the same tissue, one stimulating and the other paralyzing it, the paralyzing substance removes the action of the stimulant substance, not by bringing the tissue back to its normal state, but by abolishing its excitability; hence, although life may be saved by such an action, yet it can only be so within certain limits of dosage, because the antagonism is never complete at every point.

Speaking in the widest sense, every substance has an action on living protoplasm, but for convenience pharmacological substances have come to be limited to those which are used as drugs, or which have a distinct action upon the animal organism. Such substances are derived from (1) the chemical elements and their compounds; (2) plants; and (3) animals. The first class includes such substances as iodine, mercury, iron, carbon, and their various compounds, and such bodies as alcohol, chloroform and chloral, all of which are found in nature or can be prepared by ordinary chemical processes of manufacture. From plants many substances are obtained which at the present time we are unable to make in the chemical laboratory, and of the constitution or composition of which we are in many cases ignorant. Some of these, such as resins, gums, essential oils and fats, are readily obtained as natural exudations or by very simple manipulations, while others, such as the alkaloids, glucosides and vegetable acids, often require to be extracted by very complex processes. Substances obtained from animals include gland secretions, pepsin and other ferments, musk, cod-liver oil, &c., and to these may be added various antitoxins. The classification of substances having pharmacological actions presents so many difficulties that no satisfactory or universally adopted

Classification.

method has yet been proposed. Our knowledge presents so many gaps, and the mode of action of many remedies is so obscure and imperfectly understood, that any arrangement adopted must be more or less tentative in character. The close alliance between pharmacology, therapeutics and clinical medicine has induced many authors to treat the subject from a clinical point of view, while its relationships to chemistry and physiology have been utilized to elaborate a chemical and physiological classification respectively as the basis for systematic description. Certain writers in despair have adopted an alphabetical arrangement of the subject, while others have divided it up into inorganic, vegetable and animal substances. These last-mentioned methods are far behind our present state of knowledge, and need not be discussed here. The objection to a strictly chemical classification is, that while many substances closely allied chemically have a somewhat similar action in certain respects, yet in others they differ very widely—a striking example of which is given in the case of sodium and potassium. A physiological classification according to an action on the brain, heart, kidney or other important organ becomes still more bewildering, as many substances produce the same effects by different agencies, as, for instance, the kidneys may be acted upon directly or through the circulation, while the heart may be affected either through its muscular substance or its nervous apparatus. A clinical or therapeutical classification into such divisions as anaesthetics, expectorants, bitters, and so on, according to their practical applications, also leads to difficulties, as many drugs are employed for numerous purposes. The ideal method of grouping pharmacological substances would be in reference to their chemical action on living protoplasm, but as yet our knowledge is too scanty for this. At the present time the method adopted by Buchheim, or some modification of it, is the most scientific. As the result of painstaking investigations he grouped together all those substances having similar actions, giving to each group the name of its best-known or most thoroughly investigated member. Once the groups were more or less fixed any new substance could, when

use, and most of the newer standard textbooks combine together the consideration of pharmacology and therapeutics. Pharmacology is also related to toxicology, as many remedial and other agents are more or less poisonous when given in large doses, but it does not include the detection, tests, and the other strictly medico-legal aspects of poisoning.

Pharmacology proper began as the result of the application of strictly experimental methods to physiology. The discovery (early in the 19th century) that plants owe their remedial and poisonous qualities to small quantities of definite active principles, such as alkaloids and neutral bodies, which can be extracted in a chemically pure condition, had also a very important effect on its development. We meet first with experiments made by investigators who perceived that observations on man and animals might lead to a better understanding of the action of drugs. In 1676 Wepfer and Conrad Brunner demonstrated on dogs the tetanizing action of nuxvomica, and similar rough experiments were repeated from time to time with other substances by later investigators. In 1755 Menghini published an elaborate study of the action of camphor on a great variety of different kinds of animals. Albert von Haller (b. 1708) sought to elucidate the action of remedies by observations on healthy men, and in 1767 William Alexander made experiments on himself with drugs, which were, however, brought to an abrupt termination by his nearly killing himself. In 1776 Daries, by observations on himself and on cats, established the mydriatic action of belladonna and other atropaceous plants. Hitherto no attempt had been made to determine what particular parts of the body were especially affected by drugs, but Fontana showed, in his great work (Florence, 1765) on the venom of the viper and on other poisons, that the general symptoms were brought about by an action on particular organs. He performed more than six thousand experiments, more than four thousand of which were on animals, and he determined the effects on the heart and other important structures. These analytical methods of research were well known to the second Monro in Edinburgh, and to his pupils, one of whom, William Alexander, wrote a thesis in 1790 entitled "De partibus corporis animalis quae viribus opii parent." His methods were doubtless known also to the French physiologist Magendie, who improved upon them, and who in 1809 published a research on the *Upas Ticuté* and other strychnine-containing plants, in which he showed that their effects were due to an action on the spinal cord. The researches of his pupil, Claude Bernard, on curare, were equally exact and logical, and have served as the model for many subsequent investigations. In consequence, from the time of Magendie pharmacology may be said to have been put on a more exact basis. By the middle of the 19th century there were many workers on the subject, and the actions of such drugs as digitalis, morphine, alcohol, and many others had been frequently and minutely investigated. About this time Buchheim, professor of materia medica in Dorpat from 1846 to 1879, founded the first pharmacological laboratory on modern lines in Europe, and he introduced a more rational classification of drugs than had hitherto been in use, arranging them in groups according to their pharmacological actions. In the herbals and older treatises on materia medica and therapeutics no explanation is usually offered of the action of medicines, and in such works as that of Cullen (1789) only a few of the more obvious actions are occasionally explained according to the current theories of physiology and pathology. In works such as Parcira's *Elements of Materia Medica and Therapeutics* (1842), the physiological effects of medicines are usually described, but very briefly as compared with the materia medica. At the present day most textbooks dealing with medicinal agents and treatment devote a large part of their space to pharmacology, and a corresponding change has taken place in the teaching of the subject in universities and medical schools. Since Magendie's time numerous papers dealing with pharmacological subjects have appeared in the *Journal of Anatomy and Physiology*, the *Journal of Physiology*, Virchow's *Archiv*, and the principal medical periodicals of all countries. In 1873 the *Archiv für experimentelle Pathologie und Pharmakologie* first appeared,

in 1895 the *Archives Internationales de Pharmacodynamie*, and in 1909 *The Journal of Pharmacology and Therapeutics* (published at Baltimore, U.S.A.), all of which are chiefly or entirely devoted to pharmacology.

The methods of research are essentially those employed by physiologists, the action of substances being studied in the usual way on bacteria, leucocytes, frogs, rabbits and other animals. Not only are the general symptoms investigated, but it is necessary to carry out experiments on the nerves, muscles, circulation, secretions, &c., so as to get a more exact knowledge of the reasons of the general action. It is true that many of these animals react somewhat differently to drugs, both as regards each other and as regards man, but for the most part the differences are quantitative rather than qualitative. After carrying out a series of observations on animals, the drug can be assigned to its special group, and a good idea can be obtained of its possible practical value or the reverse; hence there is a saving of time and an avoidance of the necessity of testing its effects on man. The action of a drug may be called direct when it acts on any part to which it is immediately applied, or which it may reach through the blood; and indirect when one organ is affected secondarily to another, as, for instance, in strychnine poisoning when the muscles are violently contracted as the result of the action of the alkaloid upon the spinal cord. In a few cases the action is merely physical, but most frequently it is chemical in its nature, and is exerted on the living cell, the activity of which is either stimulated or depressed. In some cases the substances actually enter into a chemical combination with the protoplasm, which may be temporary or (much less frequently) permanent; in other cases they seem simply to modify or disturb the usual chemical activity of the cells. Prolonged or excessive stimulation invariably leads to depression or paralysis, the tissues becoming fatigued, and from this condition they may recover or they may not. When we come to consider more in detail the results of these actions we find that the various secretions of the body, such as the sweat, gastric juice, bile, milk, urine, &c., may be increased or diminished; that the heart may have its muscular or nervous apparatus stimulated or depressed; that the nerve-centres in the brain, medulla and spinal cord may be rendered more sensitive or the reverse; and that the general metabolism of the body may be altered in various ways. In addition, the fluid constituents, such as the lymph and blood, may have their composition and bulk considerably altered, while the special senses, the temperature, and, in short, every function and tissue, may be more or less affected.

Some drugs given in excess are poisons to all forms of protoplasm, but when given in doses much short of the lethal they usually exhibit a distinct tendency to affect specially, and at an early period, certain organs or tissues, and hence result differences in action; others may act only on certain organs, leaving the others practically untouched. It is often possible by appropriate dosage to contrive that these special parts or organs may be affected and the rest of the body left practically intact, and it is by taking advantage of these selective actions that remedial or therapeutical effects are usually obtained. Some substances have a very wide range of action, and involve a great variety of structures, while others, such as purgatives, have a very limited sphere. The action of drugs is often modified by circumstances peculiar to the individuals or animals to whom they are administered. In man the most important of these circumstances is age, but speaking broadly this is really a question of bulk, the child being affected like the adult, but by smaller doses. There are exceptions to this, however, as children are more affected in proportion by opium and some other substances, and less by mercury and arsenic. In old age also the nervous system and the tissues generally do not react so readily as in youth. Habit, race, personal temperament, emotional conditions, disease, the time and circumstances of administration, and other accidental causes may also modify the action in man. Some species of animals are much more susceptible to the action of certain drugs than others, a condition which depends on obvious

or unknown structural or metabolic differences. In the same way some individuals show a special tendency to poisoning by doses of certain drugs which are harmless to the great majority of mankind, and hence we get unexpected or unusual results, these arising from special susceptibility on the part of certain organs. These idiosyncrasies are not confined to drugs, but are seen with a few articles of food, such as eggs and shellfish. It is well known that the habitual consumption of certain drugs, such as tobacco, Indian hemp, opium, arsenic, alcohol and many others, gradually induces a condition of tolerance to their effects, so that large doses can be taken without causing symptoms of poisoning. In all cases, however, there is a limit, and after it is reached the ordinary effects of these substances are seen. Some individuals, however, never become tolerant, and show poisonous effects on each repetition of the dose. The degree of tolerance often differs in individuals at different times and in different circumstances, and may become lost by breaking off the habit for a short time. The explanation generally given is that the nerve and other cells become accustomed to the drug, so that they cease to react, or that an antitoxin is formed which antagonizes the poison, or that the poison is rapidly destroyed in the body. Recent researches on arsenic and atropine, however, point to the leucocytes as playing an important part in the production of tolerance, as these gradually become capable of ingesting large amounts of the foreign substances, and thus render them more or less harmless to the tissues, until they are gradually excreted from the body. When the amount is too large to be dealt with by the leucocytes, poisoning seems to occur even in the most habituated. Tolerance is therefore analogous to, but not identical with, the immunity which takes place with the toxins of infectious diseases and snake poison. Certain substances, notably digitalis, lead, mercury and strychnine, exhibit what is called a cumulative action—that is to say, when small quantities have been taken over a period of time, poisoning or an excessive action suddenly ensues. The explanation in these cases is that the drug is absorbed more rapidly than it is excreted, hence there is a tendency to accumulation in the body until a point is reached when the amount becomes poisonous.

Bodies which have a close resemblance in their chemical constitution exhibit a similar resemblance in their pharmacological action, and as the constitution of the substance becomes modified chemically so does its action pharmacologically. Numerous researches have demonstrated these points with regard to individual groups of substances, but hitherto it has not been possible to formulate any fixed laws regarding the relationship between chemical constitution and physiological action.

When drugs are swallowed no absorption may take place from the alimentary canal; but, as a rule, they pass from there into the blood. Absorption may also take place from the skin, from the rectum, from the respiratory passages, or from wounds, and from direct injection into the subcutaneous tissue or into a blood vessel. Very rarely, as in the case of silver salts, excretion does not take place; but usually the drug is got rid of by the ordinary channels of elimination. Just as drugs act upon the tissues, so they themselves are in many cases acted upon, and broken up or altered. While in the alimentary canal they are subjected to the action of the digestive fluids and the varied contents of the stomach and intestines, and after absorption they come under the influence of the constituents of the blood and lymph, and of the chemical action of the tissue cells. Inorganic bodies, such as metals, may enter into albuminous combinations which may greatly modify their effects, and organic substances may be split up into simpler compounds by oxidation or reduction, or may be rendered more complex by synthesis.

The antagonism between certain drugs has been much studied in relation to their use as antidotes in poisoning, the aim being to counteract the effects rather than to obtain a direct physiological antagonistic action. Substances which directly antagonize each other by acting on the same tissue are few in

number, but there are numerous instances in which the effects or symptoms may be obviated by acting on another tissue. Thus curare may stop strychnine convulsions by paralyzing the terminations of motor nerves, and chloroform may exercise the same effect by abolishing the irritability of the spinal cord. If two poisons act on the same tissue, one stimulating and the other paralyzing it, the paralyzing substance removes the action of the stimulant substance, not by bringing the tissue back to its normal state, but by abolishing its excitability; hence, although life may be saved by such an action, yet it can only be so within certain limits of dosage, because the antagonism is never complete at every point.

Speaking in the widest sense, every substance has an action on living protoplasm, but for convenience pharmacological substances have come to be limited to those which are used as drugs, or which have a distinct action upon the animal organism. Such substances are derived from (1) the chemical elements and their compounds; (2) plants; and (3) animals. The first class includes such substances as iodine, mercury, iron, carbon, and their various compounds, and such bodies as alcohol, chloroform and chloral, all of which are found in nature or can be prepared by ordinary chemical processes of manufacture. From plants many substances are obtained which at the present time we are unable to make in the chemical laboratory, and of the constitution or composition of which we are in many cases ignorant. Some of these, such as resins, gums, essential oils and fats, are readily obtained as natural exudations or by very simple manipulations, while others, such as the alkaloids, glucosides and vegetable acids, often require to be extracted by very complex processes. Substances obtained from animals include gland secretions, pepsin and other ferments, musk, cod-liver oil, &c., and to these may be added various antitoxins. The classification of substances having pharmacological actions presents so many difficulties that no satisfactory or universally adopted method has yet been proposed. Our knowledge presents so many gaps, and the mode of action of many remedies is so obscure and imperfectly understood, that any arrangement adopted must be more or less tentative in character. The close alliance between pharmacology, therapeutics and clinical medicine has induced many authors to treat the subject from a clinical point of view, while its relationships to chemistry and physiology have been utilized to elaborate a chemical and physiological classification respectively as the basis for systematic description. Certain writers in despair have adopted an alphabetical arrangement of the subject, while others have divided it up into inorganic, vegetable and animal substances. These last-mentioned methods are far behind our present state of knowledge, and need not be discussed here.

The objection to a strictly chemical classification is, that while many substances closely allied chemically have a somewhat similar action in certain respects, yet in others they differ very widely—a striking example of which is given in the case of sodium and potassium. A physiological classification according to an action on the brain, heart, kidney or other important organ becomes still more bewildering, as many substances produce the same effects by different agencies, as, for instance, the kidneys may be acted upon directly or through the circulation, while the heart may be affected either through its muscular substance or its nervous apparatus. A clinical or therapeutical classification into such divisions as anaesthetics, expectorants, bitters, and so on, according to their practical applications, also leads to difficulties, as many drugs are employed for numerous purposes. The ideal method of grouping pharmacological substances would be in reference to their chemical action on living protoplasm, but as yet our knowledge is too scanty for this. At the present time the method adopted by Buchheim, or some modification of it, is the most scientific. As the result of painstaking investigations he grouped together all those substances having similar actions, giving to each group the name of its best-known or most thoroughly investigated member. Once the groups were more or less fixed any new substance could, when

Classification.

its action was determined, be referred to its own group, and thus be placed or classified. As few substances are absolutely identical in action, but only broadly similar, it is often difficult to divide sharply one group from another. In a *résumé* it is manifestly impossible to pass in review every pharmacological substance, and we shall therefore confine ourselves to those groups which are of practical importance. Many individual drugs are described under their own headings.

GROUP I. Acids.—This includes sulphuric, hydrochloric, nitric, phosphoric, tartaric, citric, acetic and lactic acids, all of which owe their action to their acidity. Many of the other acids, such as carbonic and salicylic, have specific effects which have no relationship to their acid reaction. The concentrated acids have an intense local action, varying from complete destruction of the tissues to more or less irritation. When considerably diluted they are only slightly irritating; externally applied and in the stomach they have an antiseptic action; they increase the secretion of saliva, and thus assuage thirst. In the intestine they combine with ammonia and other alkalis present, and are absorbed into the blood as neutral salts, being excreted chiefly in the urine. In small doses they somewhat increase general metabolism. Boric acid only belongs partially to this group, as it and its compound borax have certain specific actions in addition.

GROUP II. Alkalis.—This includes caustic potash, caustic soda, solution of ammonia, their carbonates and bicarbonates, borax, soaps, lithium carbonate and citrate, quicklime, slaked lime, chalk, magnesia and magnesium carbonate. All these substances, apart from any other actions, exert a similar effect upon the body in virtue of their alkalinity. When they are taken internally in small amounts they neutralize the acids in the stomach and other parts of the alimentary canal, and at the same time they increase the normal acid secretion of the stomach. After absorption into the blood, which they make somewhat more alkaline, they are excreted chiefly in the urine, to which they impart an alkaline reaction if given in sufficient quantity. Some of them by stimulating the kidney cells act as diuretics, but others apparently lack this action. Caustic potash and caustic soda are locally very irritating, and destroy the tissues, but lose this quality when combined with acids as in the case of their carbonates, bicarbonates and borax. Quicklime is also caustic, but magnesia is bland and unirritating. Weak solutions applied locally saponify fats, soften the epidermis, and thus act as slight stimulants and cleansers of the skin. Calcium salts form insoluble soaps with fats, and combine with albumen in a manner which makes them soothing and astringent rather than irritating. Apart from alkaline effects, these metals differ considerably pharmacologically. Potassium and lithium have a depressing action upon the nervous system, ammonium salts have a stimulating action, while sodium practically speaking is indifferent. Calcium and magnesium have actions somewhat similar to that of potassium. Most of these substances are normal constituents of the body, and indispensable for healthy existence. They are contained in sufficient amount in our ordinary dietary to supply the needs of the organism.

GROUP III. Easily absorbed Salts.—Sodium chloride may be taken as the type of those salts which diffuse readily, and are therefore easily absorbed. Sodium nitrate, potassium nitrate, potassium chloride, ammonium chloride, the alkaline iodides and bromides, also belong partly to this group, although most of them have also specific actions. Locally they cause considerable irritation, and when swallowed in concentrated solution may cause vomiting. From the stomach and intestines they are rapidly absorbed, and rapidly excreted from the blood, increasing all secretions and the general metabolism. These effects are apparently due to their irritating action upon individual cells.

GROUP IV. Salts absorbed with difficulty.—This group includes the sulphates of sodium, potassium and magnesium, the acetate and tartrate of potash, citrate of magnesium, sodium phosphate, sodium tartrate and similar salts. Locally their action is slight, but when taken internally, dissolved in water, they are not absorbed from the alimentary canal except in very limited amount. They therefore remain for the most part in the intestine, and as they attract and retain large quantities of water, and at the same time slightly stimulate the mucous membrane, they come to have a purgative action and form the well-known group of saline cathartics. The small portion which is absorbed exerts a diuretic action.

GROUP V. Heavy Metals.—These include iron, manganese, aluminium, chromium, zinc, copper, silver, gold, platinum, lead, mercury, and probably antimony, arsenic and bismuth. Although some of these differ very greatly in their actions after absorption, still locally they have certain effects in common due chiefly to their chemical action on albumen. Their soluble salts combine with albumen and preserve it, strong solutions being extremely irritant or caustic, while weaker ones are astringent simply, or even soothing. They are all antiseptics. Their insoluble compounds are much less active locally than the soluble, and in many cases are only effective to the extent to which they are dissolved by the secretions. Some metals are only absorbed from the alimentary canal to such

a very limited amount that they exert no general action, while others readily pass into the blood and give rise to more or less marked effects. All of them injected into the blood in large doses act as muscle and nerve poisons, and during their excretion by the kidney usually irritate it severely, but only a few are absorbed in sufficient amount to produce similar effects when given by the mouth. When iron is injected directly into a vein it depresses the heart's action, the blood pressure and the nervous system, and during its excretion greatly irritates the bowel and the kidneys. When taken by the mouth, however, no such actions are seen, owing to the fact that very minute quantities are absorbed and that these become stored in the liver, where they are converted into organic compounds and ultimately go to form hæmoglobin. Soluble salts of manganese, aluminium, zinc, copper, gold, platinum and bismuth have, when given by the mouth, little action beyond their local astringent or irritating effects; but when injected into a blood vessel they all exert much the same depressing effect upon the heart and nervous system. Silver resembles them closely, but differs by the circumstance that it is deposited permanently in minute granules in the tissues, and, without affecting the general health, stains the skin of a bluish colour (argyria). Mercury and lead are absorbed from the bowel in considerable quantities, and are capable of inducing acute irritant poisoning as well as chronic poisoning. Lead poisons the muscular and nervous systems, and gives rise to paralysis, wasting, colic and other symptoms, while in the case of mercury, tremors, salivation, anaemia and very marked cachexia are induced. Arsenic and antimony do not form combinations with albumen, but they both greatly depress the central nervous system and circulation; and, if their action be long continued in large doses, they cause fatty degeneration of the viscera and disappearance of glycogen from the liver. Locally they are both very irritating, and antimony has a special tendency to cause vomiting.

GROUP VI. Halogens.—This group includes iodine, bromine and chlorine, in their free state or as compounds. Locally they are all three strongly irritant or caustic, owing to their chemical action on albumen. They are in addition powerful germicides, and by splitting up water may act as oxidizing agents. Owing to their strong affinity for the hydrogen of organic compounds they often act as bleachers and deodorizers. Iodine has a special interest, as it is a necessary constituent of food, and is present in the secretion of the thyroid gland. Apart from certain conditions of ill health, the iodides, as such, have no very marked influence on the healthy body beyond their saline action. Alkaline bromides, in addition to their saline action, have in sufficient doses a depressing effect upon the central nervous system, and less markedly upon the heart. Chlorine compounds are not known to exercise any action of a similar kind.

GROUP VII. Sulphur.—Sulphur itself has no action, but when brought into contact with the secretions it forms sulphides, sulphites and sulphuretted hydrogen, and thereby becomes more or less irritant and antiseptic. In the bowel its conversion into sulphides causes it to act as a mild laxative. Baths containing sulphuretted hydrogen or alkaline sulphides have a slightly irritating effect upon the skin, and stimulate the general metabolism.

GROUP VIII. Phosphorus.—This includes phosphides, and, according to some authorities, hypophosphites. Phosphorus is present in all cells, in considerable quantity in the nervous tissue, and in the bones as phosphates. It is therefore, in some form or other, a necessary part of dietary. When taken by the mouth phosphorus is an irritant poison in large doses; in small doses the only effects noticeable consist in an increased formation of bony and connective tissue, although it is also supposed to exert a gently stimulating effect upon the nervous system.

GROUP IX. Oxygen.—When pure oxygen is inhaled the only effect is a slight increase of the amount of the gas in the blood, but this has no particular physiological effect. The pharmacological action of hydrogen peroxide (H₂O₂), potassium permanganate, powdered charcoal and some other oxidizing agents depends on the readiness with which they give up oxygen.

GROUP X. Carbonic Acid.—Carbonic acid gas, carbonic oxide (CO) and some other irrespirable gases produce their effects practically by asphyxiation. When dissolved in water, however, carbonic acid gas is a gentle stimulant to the mouth, stomach and bowel, the mixture being absorbed more rapidly than plain water; hence its greater value in assuaging thirst. Nitrous oxide (laughing gas) was at one time believed to act simply by cutting off the supply of oxygen to the tissues, but it also has a specific effect in producing paralysis of certain parts of the central nervous system, and hence its value as an anaesthetic; when given in small amounts mixed with air it produces a condition of exhilaration.

GROUP XI. Water.—Water acts directly as a diluent and solvent. It therefore increases all the secretions, especially those of the skin and kidneys, while it also stimulates the general metabolism of the body and the excretion of nitrogenous products. Mineral waters act in the same way, but their effects are very much modified by, and depend largely upon, other constituents, such as alkaline salts, iron, arsenic, sulphides, carbonic acid, &c.

GROUP XII. Tannic Acid.—Tannic acid is present in small quantities in the great majority of plants, but in notable quantity in gall-nuts, oak bark, bearberry leaves, rhatany root, catechu, kino,

red gum, baef fruit, logwood and witch hazel, all of which are largely used as medicines. In these the variety of tannic acid is not exactly the same, but although there are slight chemical differences, they all possess the power of tanning raw hides and of preserving albuminous tissues. The action of tannic acid is strictly local, and depends upon its power of precipitating albumen and of destroying germs. It thus acts as an astringent on all mucous membranes. After absorption into the blood it loses this effect, as it is partly broken up into gallic acid and partly combined with albumin, both of which changes nullify its action upon albumen.

GROUP XIII. Local Irritants.—Although some of the drugs already considered have a local irritant action, they produce other more important effects, but the substances here ranged under this heading depend entirely for their action on their local irritant effects.

a. Those which act upon the alimentary canal: Simple bitters such as quassia wood, columbo root, taraxacum, gentian, chiretta, and many others, irritate gently the mucous membrane of the stomach and bowels, and by increasing the secretions improve the appetite and digestion. The aromatic bitters such as chamomile flowers, cascarrilla bark, hops, orange peel and others contain in addition small quantities of essential oils which increase their local action. The active principles in some of these bitters have been isolated pure, and have been found to be alkaloids or neutral compounds. Substances like pepper, cayenne pepper, mustard, horse-radish and ginger irritate the stomach and bowel much in the same way, but are more pungent, and are consequently used as condiments. Some of these have a similar but less marked effect upon the skin. The large number of vegetable substances used as purgatives owe their action to an irritating effect upon the mucous membrane and the neuro-muscular apparatus of the bowel, whereby the secretions and peristalsis are more or less increased, as the result of which diarrhoea ensues. Some of them cause so much irritation that the discharge is very watery (hydragogue cathartics), while others, for example aloes, by acting gently on the lower part of the bowel and on its muscular coat, produce simply a laxative effect. A few of them, such as aloin and colocynthin, are also purgative when injected subcutaneously or into the blood, probably owing to their being excreted into the intestinal canal.

b. Those which act on the skin: The best known of these is cantharides (Spanish fly), the active principle of which is a colourless crystalline body—cantharidin—which is extremely irritating. On a mucous membrane or a delicate skin it exerts an irritating action, which occurs more quickly than on a thickened epidermis, such as the scalp, and according to the strength and period of application there may result redness, a blister, or an ulcer. Many other substances, such as chrysarobin, mustard, pepper, &c., are also capable of irritating the skin, the effect produced varying from mere dilatation of the cutaneous vessels to destruction of tissue.

GROUP XIV. Male-fem.—This includes the male-fem, santonin, cuseo, pomegranate bark, pumpkin seeds and many other substances containing active principles which have a specific poisonous action on intestinal parasitic worms. Apart from this their actions vary considerably, but are of little practical importance.

GROUP XV. Essential Oils.—This includes a very large number of substances which owe their action to the fact that they contain ethereal or essential oils. The best known of these are cloves, pimento (allspice), myrtle, eucalyptus, caraway, fennel, dill, cinnamon, rosemary, lavender, peppermint, spearmint, nutmeg, cinamon, sandal-wood, turpentine, juniper berries, valerian and cubul. In this group may be included the oleo-resins, such as copaiba, cubebs and Canada balsam; the gum-resins, such as asafetida, myrrh, ammoniacum and galbanum; and the true balsams, such as benzoin, storax, balsam of Tolu and balsam of Peru. The resins when taken internally have much the same action as essential oils, which are closely allied chemically, while the benzoic and cinnamic acids in the balsams modify their actions very slightly. Although individual essential oils may differ somewhat in action, chemically and pharmacologically they are fundamentally similar. They all have a poisonous action on protoplasm, which makes them useful in medicine as antiseptics, disinfectants, germicides, anti-fermentatives and parasiticides; when locally applied they are more or less irritating, and, when very dilute, astringent. When swallowed in small doses they slightly irritate the mouth and gastric mucous membrane, increasing the secretions and producing a feeling of warmth. At the same time they increase the movements of the stomach, and also in this way hasten digestion, an action which extends to the upper part of the bowel. They are readily absorbed into the blood, and they are excreted chiefly by the kidneys in a more or less altered form, and probably also by the different mucous membranes, and even by the skin. After absorption their action, speaking generally, is exerted on the brain and spinal cord, and is at first slightly stimulant and afterwards depressing, even to the causing of sleepiness and stupor. Locally applied they depress the terminations of sensory nerves, and may thereby lessen pain. On the heart and circulation the effects are stimulant unless large doses are given, when the pulse becomes slow and blood-pressure much lessened. During excretion they irritate the kidneys and the sweat-glands, and thereby increase the excretion of urine and of sweat. They also increase the number of leucocytes in the blood,

and the more irritating of them increase the flow of blood to the pelvic organs, and may thus stimulate the uterus, or in large doses cause abortion. The various camphors, such as laurel camphor, Borneo camphor, menthol and cumarin, are oxidized derivatives of essential oils, and differ only superficially from them in their action.

GROUP XVI. Phenol.—This includes a very large number of bodies chemically allied to benzol, such as carbolic acid, sulpho-carbolates, creosote, wood tar, coal tar, oil of cade, thymol, salicylic acid, benzoic acid, naphthol, hydroquinon, creol, guaiaecol, ichthyol, saccharin and many others. These all resemble carbolic acid more or less closely, and may be described as general protoplasm poisons. Locally their destructive and irritating effects vary a good deal, but even when very dilute they all have a marked poisonous action on bacteria, white blood corpuscles, yeast and similar organisms. After absorption most of them exercise a depressing effect upon the nervous system, and are capable of reducing high temperature. They are mostly excreted in the urine.

GROUP XVII. Alcohol.—This group also includes a very large number of chemical bodies, only a few of which are mentioned here. Ethyl alcohol is taken as a type of the action of methyl alcohol, amyl alcohol, propyl alcohol, ether, acetic ether, methylaldehyde, sulphonal, chloroform, methyl chloride, ethyl chloride, chloral hydrate, butylchloral hydrate, and almost any number of derivatives from these. Some of them are so volatile that they produce their effects when inhaled, others when sprayed upon the skin cause intense cold and then anaesthesia; but taken in the broadest sense the action of all of them after absorption into the blood is very similar, and is exerted upon the central nervous system, more especially the cerebrum. In all cases there is a longer or shorter period of excitement, followed by intoxication or narcosis, and with large doses this passes into paralysis and death from depression of the respiratory centre or of the heart. Small doses of any of them dilate the blood vessels from an action on the vaso-motor centre in the medulla oblongata, as a result of which the heart beats more rapidly and the blood circulates more freely; but larger doses have a general depressing effect upon the circulatory system. Under their action more heat is lost from the body, the general metabolism is diminished and the temperature falls. With some of them, such as chloral and chloroform, the stimulation period is short compared with the narcotic period, while with others, such as ether, the reverse is the case.

GROUP XVIII. Nitrites.—This group contains amyl nitrite, ethyl nitrite, methyl nitrite, nitroglycerin, sodium and potassium nitrites, erythrol-tetranitrate, and many other compounds containing nitrous or nitric acid. The latter becomes reduced to nitrous in the body, and thereby exercises its characteristic effects. These consist chiefly in an action upon non-stripped muscle, vaso-motor centres, blood vessels and the blood. When they are given by inhalation or by the mouth their first effect is to produce marked dilatation of the small arteries, with a fall of blood-pressure and a greatly increased rapidity of the heart's action. At the same time the non-stripped muscles slightly lose their tonicity, and when very large doses are given the haemoglobin of the blood becomes converted into the chocolate-coloured methaemoglobin. The volatile members of the group act much more rapidly and more transiently than the others.

GROUP XIX. Alkaloids.—This embraces a very large number of important pharmacological substances, which differ a good deal in the details of their action, but they all act upon muscle and nerve tissue. Some of them affect only certain portions of the nervous system, others have a much wider range of action; they may act in either case as stimulants or as depressants, and hence the symptoms produced by them vary very greatly.

1. Morphine and the other opium alkaloids (codeine, narcotine, laudanine, &c.) have two prominent actions—a narcotic followed by a tetanic action. In morphine, on the higher animals at least, the narcotic action is very marked, the tetanizing action slightly so; while in thebaine there is little narcotic effect, but a tetanizing action like that of strychnine. Morphine exercises its effects chiefly upon the cerebrum and the medulla oblongata in man. It has in addition a markedly depressing action upon the respiratory centre, it lessens all the secretions except the sweat, and diminishes bowel peristalsis and the size of the pupil. Men are much more affected by it than birds, rabbits, dogs and most other animals. Cats, however, show marked symptoms of cerebral excitement and increase of the reflexes. Compared with morphine, codeine and the other alkaloids are only slightly narcotizing.

2. Strychnine and brucine very closely resemble each other in action, and under this heading curarine may also be included. These bodies stimulate the grey matter in the spinal cord and cause tetanic convulsions. In the case of curare these are masked almost at once by paralysis of the terminations of the motor nerves.

3. Caffeine is the active principle in tea, coffee, kola, maté and guarana; while theobromine, a body closely allied to it, is found in cocoa and chocolate. They both stimulate the grey nerve-cells in the brain and cord, this being the foundation of their dietetic value and their use as nerve stimulants. They also markedly increase the secretion of urine by stimulating the secreting cells of the kidneys.

4. Cocaine is the active principle of the coca leaf, which is chewed

as a stimulant-narcotic in Peru and Bolivia. Small doses excite the nervous system, while large doses are depressing. The chief action of cocaine from a practical point of view is its power of paralysing the terminations of sensory nerves.

5. Atropine, hyoscyamine, homatropine, duboisine, daturine and some other bodies have a paralyzing action upon the ends of the motor and secretory nerves. They therefore lessen all the secretions, and among other actions dilate the pupil and increase the rapidity of the heart by paralyzing the vagus. In addition they have a stimulating action on the central nervous system.

6. Nicotine, piturine and lobeline are the active principles of tobacco and other substances which are smoked as stimulant narcotics. In large doses they are powerful nerve poisons, but as usually taken they exercise a gently stimulant effect upon the nervous system. Pilocarpine has an action closely allied to that of nicotine, but as it is much less poisonous (the effects produced by small doses being chiefly excessive sweating and salivation), it is capable of being utilized in medicine. Muscarine has a very close resemblance in action to pilocarpine.

7. Physostigmine, the active principle of the Calabar bean, acts chiefly as a stimulant to voluntary and involuntary muscles, and at the same time exercises a depressing effect upon the spinal cord. It contracts the pupil.

8. Conine, gelseminine and sparteine all exert a paralyzing effect on the terminations of the motor nerves, to the implication of which the weakened gait and other symptoms are due.

9. Aconitine, delphinine and many of their derivatives have a very widespread depressing action on muscle and nerve.

10. Apomorphine is essentially a muscle poison, but owing to the fact that minute doses stimulate the vomiting centre and cause emesis before any other symptoms are observable, its emetic action is the most prominent effect in man.

11. Emetine acts as a gradual depressant to the nervous system in animals. In man its chief effect is its emetic action, which seems to be due entirely to local irritation of the stomach.

12. Quinine. Several of the other alkaloids found in cinchona bark act very much like quinine. They all depress the conducting power and the grey matter of the spinal cord, and to a much less extent that of the brain. They lessen the general metabolism and lower febrile temperature. The cinchona alkaloids have a specifically poisonous effect on the parasites of malaria when present in human blood, and are poisonous to all low organisms.

13. Phenacetin, acetanilide, phenazone and many similar bodies act as antipyretics in virtue of an action on the heat-regulating centres in the cerebrum.

GROUP XX. *Diploids*.—This group-name has been given to a large number of substances which have an action similar to that of the fonglove leaves, including the active principles of strophanthus, squill, *Urticaria suberecta*, *Convolvulus majoris*, *Nerium Oleander*, *Helleborus niger*, *Antiaris toxicaria* (the upua tree), and several others. The active principles of these vary a good deal in chemical composition, but they are all non-nitrogenous neutral bodies. Their action is exerted upon muscle, and chiefly upon the muscle of the heart and blood vessels. The individual muscle-fibres contract and expand more perfectly, and thus the diastole and systole of the heart are rendered more complete, the pulse is slowed, and the blood-pressure is raised. The slowing of the heart is partly brought about by an action on the vagus centre.

GROUP XXI. *Picrotoxins*.—In large doses the action of picrotoxin is exerted chiefly on the medullary nerve centres, whereby irregular tonic-clonic convulsions are produced; in minute doses it stops the secretion of sweat.

GROUP XXII. *Saponin*.—Saponin and many allied bodies form an abundant soapy-looking froth when shaken up with water, and they are contained in a very large number of plants, the chief of which are the *Quillaja saponaria*, *Polygala senega*, sarsaparilla, and others, known collectively as soaps. They all act as local irritants in the alimentary canal, and after absorption are more or less depressing to the muscular and nervous systems. They produce slight nausea and increased secretion of mucus.

GROUP XXIII. *Cyanogen*.—This includes compounds of cyanogen such as hydrocyanic (prussic) acid, cyanides of potassium, sodium, &c., cherry-laurel water, amygdalin, bitter almonds and other chemical and vegetable substances which readily yield hydrocyanic acid. Hydrocyanic acid is a general protoplasmic poison, all the lower organisms being very susceptible to its action, while in the higher animals it speedily depresses or paralyzes all forms of nerve tissue. It enters into combination with hæmoglobin, forming a bright scarlet compound and interfering with respiration. It kills by its paralyzing effect on the motor ganglia of the heart and on the respiratory centre.

GROUP XXIV. *Ferments*.—These include such bodies as pepsin, diastase, the pancreatic ferments, papain, the pine-apple ferment, taka-diastase and others, and serve to convert starch into saccharine substances, or albumen into peptone and albumoses.

GROUP XXV. *Animal Glands and Secretions*.—Of these the thyroid gland, the suprarenal bodies, the spleen, the bile, the bone marrow, the ovaries and some others have been investigated fully. Speaking generally, when given in small doses their action on the

healthy organism is slight or nil, but in disease some of them are capable of acting as substitutes for deficient secretions.

GROUP XXVI. *Antitoxins*.—These are substances which antagonize the toxins formed in the body by pathogenic organisms, the toxins of snake venom and other animal poisons, and vegetable toxins such as abrin, ricin, &c. A healthy person can be rendered unsusceptible by gradually accustoming him to increasing doses of these poisons, and this immunity is due to antitoxins which are found in the blood-serum and which are products of the blood cells. The nature of these antitoxic substances is not definitely known, but they combine with and destroy the poisons. In specific germ diseases a similar antitoxin forms, and in cases which recover it counteracts the toxin, while the germs are destroyed by the tissues. Antitoxins can be prepared by immunizing a large animal, such as a horse, by injecting gradually increasing doses of specific toxins into its subcutaneous tissue. In due time the horse is bled, the serum is filtered free of blood corpuscles, and then constitutes the antitoxic serum, which can be standardized to a certain potency. Such serums are injected subcutaneously in diphtheria, tetanus, streptococic infections, plague, snake-poisoning, cholera and other similar diseases. They do not as a rule harm healthy men even in large quantities, but when repeated they often cause serious symptoms due to the body becoming more sensitive to the action of the horse-serum in which they are contained.

GROUP XXVII. *Neutral Fats*.—This includes cod-liver oil, almond oil, olive oil, lard, &c., all of which act as foods when taken internally, and have a merely physical emollient action when applied externally. Lanolin, linned oil, wax, spermaceti, &c., also belong to this group. The paraffins, glycerin and vaseline, although not fats, have much the same effect when applied externally, but they are not nutritive.

GROUP XXVIII. *Sugars, Starches, Gums, Gelatin, &c.*—Although these and allied bodies are used in various ways as remedies, their action is for the most part purely mechanical or dietetic.

AUTHORITIES.—T. Lauder Brunton, *Pharmacology, Therapeutics and Materia Medica* (3rd ed., London, 1891); *The Action of Medicines* (London, 1897); H. C. Wood, *Therapeutics: its Principles and Practice* (10th ed., London, 1905); A. Cushny, *A Textbook of Pharmacology and Therapeutics* (1906); C. D. F. Phillips, *Materia Medica, Pharmacology, and Therapeutics (Inorganic Substances)* (London, 1894); Bina, *Lectures on Pharmacology* (Trans., New Sydenham Society, London, 1895); Schmiedeberg, *Grundriss der Arzneimittellehre* (3rd ed., Leipzig, 1895; Eng. trans. by Theo. Dixon, Edinburgh, 1887); Stolvis, *Leçons de pharmacothérapie* (Harcourt and Paris, 1898); Rabuteau, *Traité de thérapeutique et de pharmacologie* (Paris, 1884); Vulpian, *Les Substances toxiques et médicamenteuses* (Paris, 1882); J. Harley, *The Old Vegetable Neurotics* (London, 1869); J. Mitchell Bruce, *Materia Medica and Therapeutics*; W. Hale White, *Materia Medica, Pharmacology and Therapeutics* (London, 1906); Walter E. Dixon, *A Manual of Pharmacology* (London, 1906). (R. S. *)

Terminology in Therapeutics.

It may be useful to give here a general explanation of the common names used in the therapeutic classification of drugs. It is convenient to divide drugs and other substances used in medicine into groups according to the part of the system on which they chiefly act, though, as stated above, many drugs act in more than one manner and could come under several groups.

1. Drugs acting on the blood vessels, which either dilate the vessels when taken internally or applied locally, or contract the superficial arteries. *Irritants* (Lat. *irritare*, to excite) include: *Rubefacients* (Lat. *rubefacere*, to make red), which cause the skin to become red from dilatation of the blood vessels; *Vasodilators* (Lat. *vasa*, a bladder), which irritate sufficiently to cause the blood-serum to exude and form vesicles or blisters, e.g. cantharides; *Pustulants* (Lat. *pustula*, a blister), still more powerful in their effects, causing the blisters to become filled with pus, e.g. croton oil. *Escharotics* (Gr. *εσχάρω*, hearth, brazier; hence mark of a burn, "scar") or *Caustics* (Gr. *καίω*, to burn), cause the death of the part, e.g. silver nitrate and nitric acid. The term *counter-irritant* is used when an irritant is applied to the skin for the purpose of relieving pain or congestion by dilating the superficial vessels. Drugs which contract the vessels and diminish exudation comprise *Astringents* (Lat. *astringere*, to draw close), while *Styptics* (*ερίψω*, to contract) or *Hæmostatics* (Gr. *αἷμα*, blood, *στυπνός*, causing to stand) are substances applied either locally or internally in order to arrest bleeding; cold, adrenalin, ergot and the per-salts of iron may be taken as examples.

II. Drugs acting on the digestive tract. *Sialogogues* (Gr. *σάλω*, spittle, *γωγός*, leading) increase the flow of saliva, e.g. mercury; *Antisialogogues* decrease the flow, e.g. belladonna. *Aromatics* (Gr. *ἀρωμα*, spice) or *Bitters* increase the flow of the gastric juice. *Stomachics* (Gr. *στυμαχικός*) have the same effect. The term *Carminals* (Lat. *carmisare*, to card wool), adopted from the old medical theory of humours, is generally applied to pungent substances which help to expel gas from the stomach by stimulating the movement

of its contents. *Emetics* (Gr. *ἔμεσις*, vomiting) are substances given for the purpose of causing vomiting, e.g. ipecacuanha or apomorphine. *Anti-emetics* or *Sedatives* (Lat. *sedare*, to compose) arrest vomiting either by their central or local action, e.g. opium, cocaine or cerium oxalate. *Purgatives* (Lat. *purigare*, to cleanse) aid the onward passage of the contents of the intestinal canal, either by increasing the contractions of its muscular coat as *laxatives* (Lat. *lassare*, to loosen), e.g. as magnesia, or by increasing the flow of fluid. Some are termed *drastics* (Gr. *δραστικὸν*, active) or *cathartics* (Gr. *καθαρτικόν*, cleansing), which produce watery evacuations. *Cholagogues* (Gr. *χολὰγ*, bile, *ἀγωγός*, leading) are purgatives which act by increasing the flow of bile, either by causing an increased secretion (e.g. podophyllum) or by sweeping it onwards by stimulating the intestinal contractions (e.g. calomel).

III. Drugs acting on parasites. *Anthelmintics* (Gr. *ἀντὶ*, against, *ἕλμινος*, a worm) are drugs which kill parasites inhabiting the intestine. The term *vermicide* (Lat. *vermis*, worm, *caedere*, to kill) is applied to drugs which directly kill the entozoa, while *vermifuge* (Lat. *vermis*, worm, *fugare*, to put to flight) is applied to the purgative usually given after the vermicide for the purpose of expelling the worm. *Parasiticides* or *anti-parasitics* destroy parasites; the terms are usually restricted to those acting on skin-parasites as contrasted with intestinal ones.

IV. Drugs acting on the urinary system. *Diuretics* (Gr. *διὰ*, through, *ἕρως*, the urine) increase the flow of urine, while *lithontriptics* (Gr. *λίθος*, stone, *ρῥῆσις*, to rub, grind down) are drugs given to prevent the formation of urinary calculi.

V. Drugs acting on the generative system. *Aphrodisiacs* (Gr. *Ἀφροδίτη*, the goddess of love) increase the action of the generative centre in the spinal cord; *Anaphrodisiacs* decrease its action. *Ecbolics* (Gr. *ἐκβάλλω*, to throw out) or *oxytocics* (Gr. *ὄξις*, sharp, quick, *ῥῆσις*, parturition) stimulate uterine action. *Emmenagogues* (Gr. *ἐμμηνα*, menses, *ἀγωγός*, leading) are substances which increase the menstrual flow. *Galactagogues* (Gr. *γάλα*, milk) increase the secretion of milk, while *anti-galactagogues* (e.g. belladonna) have the opposite effect.

VI. Drugs acting on the respiratory system. *Expectorants* increase the bronchial secretions; *antispassmics* relax the spasm of the muscular coat of the bronchial tubes, e.g. stramonium. This latter term is also used for drugs which act as general depressants.

VII. Drugs or substances acting on the bodily heat. *Antipyretics* (Gr. *ἀντὶ*, against, *πυρετός*, fever) either increase the heat loss or diminish its production; e.g. naphthaen, cold water, &c.

VIII. Drugs or substances acting on the skin. *Diaphoretics* (Gr. *διαφωρίζω*, to carry through) increase the amount of sweat, either by acting directly on the sweat centres or on the nerve terminals. The word *Sudorific* (Lat. *sudor*, sweat) is applied to them when they act very powerfully. *Anhidrotics* or *Antihidrotics* (Gr. *ἄψις*, sweat) diminish the secretion of sweat. *Emollients* (Lat. *molliis*, soft) are substances which soften and protect the parts. *Demulcents* (Lat. *demulcere*, soften), soothe the skin or mucous membrane.

IX. Drugs acting on metabolism. *Alteratives* are drugs which alter the course of a disease, the mode of action being unknown. *Tonics* are drugs which increase the muscular tone of the body by acting either on the stomach, heart, spinal cord, &c.

X. Drugs acting on the blood. *Antitoxins* are organic products designed to neutralize the formation of the toxins of certain diseases in the blood. *Toxins* are also injected in order to stimulate the blood plasma to form antitoxins (see BACTERIOLOGY). *Antiperiodics* inhibit a disease having periodic recurrences; e.g. quinine in malaria. *Hæmatics* are drugs which increase the amount of hæmoglobin in the blood.

XI. Drugs acting on the nervous system. *Anæsthetics* (q.v.) diminish sensibility, either central or peripheral; *Anodynes* (Gr. *ἀν*, priv., *ἄλγος*, pain) relieve pain only, but, as in *Analgesics* (Gr. *ἀλγῆσις*, sense of pain), sensibility is unaltered. *Stimulants* are those which lead to excitation of the mental faculties and in quantity may lead to delirium and incoherence. *Hypnotics* (Gr. *ἕπνος*, sleep) or *Soporifics* (Lat. *sopor*, a deep sleep) are drugs which produce sleep without causing cerebral excitement. *Narcotics* (Gr. *νάρκη*, numbness) are those which besides producing sleep may in large doses depress the functions of respiration and circulation.

XII. Drugs which arrest the progress of putrefaction. This is either by inhibiting the growth of micro-organisms (*Antiseptics*) or by destroying them when present (*Disinfectants*). (H. L. H.)

PHARMACOPOEIA (lit. the art of the *φάρμακον*, or drug-compounder), in its modern technical sense, a book containing directions for the identification of simples and the preparation of compound medicines, and published by the authority of a government or of a medical or pharmaceutical society. The name has also been applied to similar compendiums issued by private individuals. The first work of the kind published under government authority appears to have been that of Nuremberg in 1542; a passing student named Valerius Cordus showed

a collection of medical receipts, which he had selected from the writings of the most eminent medical authorities, to the physicians of the town, who urged him to print it for the benefit of the apothecaries, and obtained for his work the sanction of the senatus. An earlier work, known as the *Antidotarium florentinum*, had been published under the authority of the college of medicine of Florence. The term "pharmacopœia" first appears as a distinct title in a work published at Basel in 1561 by Dr A. Foes, but does not appear to have come into general use until the beginning of the 17th century. Before 1542 the works principally used by apothecaries were the treatises on simples by Avicenna and Serapion; the *De synonymiis* and *Quid pro quo* of Simon Januensis; the *Liber servitoris* of Bulchasim Ben Aberaserim, which described the preparations made from plants, animals and minerals, and was the type of the chemical portion of modern pharmacopœias; and the *Antidotarium* of Nicolaus de Salerno, containing Galenical compounds arranged alphabetically. Of this last work there were two editions in use—Nicolaus magnus and Nicolaus parvus; in the latter several of the compounds described in the larger edition were omitted and the formulæ given on a smaller scale.

Until 1617 such drugs and medicines as were in common use were sold in England by the apothecaries and grocers. In that year the apothecaries obtained a separate charter, and it was enacted that no grocer should keep an apothecary's shop. The preparation of physicians' prescriptions was thus confined to the apothecaries, upon whom pressure was brought to bear to make them dispense accurately, by the issue of a pharmacopœia in May 1618 by the College of Physicians, and by the powers which the wardens of the apothecaries received in common with the censors of the College of Physicians of examining the shops of apothecaries within 7 m. of London and destroying all the compounds which they found unfaithfully prepared. This, the first authorized *London Pharmacopœia*, was selected chiefly from the works of Mezeus and Nicolaus de Salerno, but it was found to be so full of errors that the whole edition was cancelled, and a fresh edition was published in the following December. At this period the compounds employed in medicine were often heterogeneous mixtures, some of which contained from 20 to 70, or more, ingredients, while a large number of simples were used in consequence of the same substance being supposed to possess different qualities according to the source from which it was derived. Thus crabs' eyes, pearls, oyster-shells and coral were supposed to have different properties. Among other ingredients entering into some of these formulæ were the excrements of human beings, dogs, mice, geese and other animals, calculi, human skull and moss growing on it, blind puppies, earthworms, &c. Although other editions of the *London Pharmacopœia* were issued in 1621, 1632, 1639 and 1677, it was not until the edition of 1721, published under the auspices of Sir Hans Sloane, that any important alterations were made. In this issue many of the ridiculous remedies previously in use were omitted, although a good number were still retained, such as dogs' excrement, earthworms, and moss from the human skull; the botanical names of herbal remedies were for the first time added to the official ones; the simple distilled waters were ordered of a uniform strength; sweetened spirits, cordials and ratifias were omitted as well as several compounds no longer used in London, although still in vogue elsewhere. A great improvement was effected in the edition published in 1746, in which only those preparations were retained which had received the approval of the majority of the pharmacopœia committee; to these was added a list of those drugs only which were supposed to be the most efficacious. An attempt was made to simplify further the older formulæ by the rejection of superfluous ingredients. In the edition published in 1788 the tendency to simplify was carried out to a much greater extent, and the extremely compound medicines which had formed the principal remedies of physicians for 2000 years were discarded, while a few powerful drugs which had been considered too dangerous to be included in the *Pharmacopœia* of 1765 were restored to their previous position. In 1809 the French chemical nomenclature

was adopted, and in 1815 a corrected impression of the same was issued. Subsequent editions were published in 1824, 1836 and 1851.

The first *Edinburgh Pharmacopoeia* was published in 1699 and the last in 1841; the first *Dublin Pharmacopoeia* in 1807 and the last in 1850.

The preparations contained in these three pharmacopoeias were not all uniform in strength, a source of much inconvenience and danger to the public, when powerful preparations such as dilute hydrocyanic acid were ordered in the one country and dispensed according to the national pharmacopoeia in another. In consequence of this inconvenience the Medical Act of 1858 ordained that the General Medical Council should cause to be published a book containing a list of medicines and compounds, to be called the *British Pharmacopoeia*, which should be a substitute throughout Great Britain and Ireland for the separate pharmacopoeias. Hitherto these had been published in Latin. The first *British Pharmacopoeia* was published in the English language in 1864, but gave such general dissatisfaction both to the medical profession and to chemists and druggists that the General Medical Council brought out a new and amended edition in 1867. This dissatisfaction was probably owing partly to the fact that the majority of the compilers of the work were not engaged in the practice of pharmacy, and therefore competent rather to decide upon the kind of preparations required than upon the method of their manufacture. The necessity for this element in the construction of a pharmacopoeia is now fully recognized in other countries, in most of which pharmaceutical chemists are represented on the committee for the preparation of the legally recognized manuals.

National pharmacopoeias now exist in the following countries: Austria, Belgium, Chile, Denmark, France, Germany, Great Britain, Greece, Holland, Hungary, India, Japan, Mexico, Norway, Portugal, Russia, Spain, Sweden, Italy, Switzerland, the United States of America and Venezuela. All the above-mentioned were issued under the authority of government, and their instructions have the force of law in their respective countries, except that of the United States, which was prepared by commissioners appointed by medical and pharmaceutical societies, and has no other authority, although generally accepted as the national textbook.

The French *Codex* has probably a more extended use than any other pharmacopoeia outside its own country, being, in connexion with *Dorvault's L'Officine*, the standard for druggists in a large portion of Central and South America; it is also official in Turkey. The sum-total of the drugs and preparations it contains is about 1250, or double the average of other modern pharmacopoeias. The progress of medical knowledge has led to a gradual but very perceptible alteration in the contents of the pharmacopoeias. The original very complex formulæ have been simplified until only the most active ingredients have been retained, and in many cases the active principles have to a large extent replaced the crude drugs from which they were derived. From time to time such secret remedies of druggists or physicians as have met with popular or professional approval have been represented by simpler official preparations.

The rapid increase in medical and pharmaceutical knowledge renders necessary frequent new editions of the national pharmacopoeias, the office of which is to furnish definite formulæ for preparations that have already come into extensive use in medical practice, so as to ensure uniformity of strength and to give the characters and tests by which their purity and potency may be determined. But each new edition requires several years to carry out numerous experiments for devising suitable formulæ, so that the current Pharmacopoeia can never be quite up to date. This difficulty has hitherto been met by the publication of such non-official formulæ as Squire's *Companion to the Pharmacopoeia* and Martindale's *Extra Pharmacopoeia*, in which all new remedies and their preparations, uses and doses are recorded, and in the former the varying strengths of the same preparations in the different pharmacopoeias are also compared. The need of such works to supplement the Pharmacopoeia is shown by the fact that they are even more largely used than the Pharmacopoeia itself, the first having been issued in 18 and the second in 13 editions at comparatively short intervals. In England the task of elaborating a new Pharmacopoeia is entrusted to a body of a purely medical character, and legally the pharmacist has not, as in other countries, a voice in the matter, notwithstanding the fact that, although the medical practitioner is naturally the best judge of the drug or preparations that will afford the best therapeutic results, he is not so competent as the pharmacist to say how that preparation can be produced in the most effective and satisfactory manner, nor how the purity of drugs can be tested. In the preparation of the fourth edition of

the *British Pharmacopoeia* in 1898 some new departures were made. A committee of the Pharmaceutical Society of Great Britain was appointed at the request of the General Medical Council to advise on pharmaceutical matters and the valuable assistance rendered by it is acknowledged in the preface of that work. A census of prescriptions was taken to ascertain the relative frequency with which different preparations and drugs were used in prescriptions, and suggestions and criticisms were sought from various medical and pharmaceutical bodies at home and in the colonies. As regards the purely pharmaceutical part of the work a committee of reference in pharmacy, nominated by the pharmaceutical societies of Great Britain and Ireland, was appointed to report to the Pharmacopoeia Committee of the Medical Council.

Some difficulty has arisen since the passing of the Adulteration of Food and Drugs Act concerning the use of the Pharmacopoeia as a legal standard for the drugs and preparations contained in it. The Pharmacopoeia is defined in the preface as only "intended to afford to the members of the medical profession and those engaged in the preparation of medicines throughout the British Empire one uniform standard and guide whereby the nature and composition of substances to be used in medicine may be ascertained and determined." It is obvious that it cannot be an encyclopaedia of substances used in medicine, and can only be used as a standard for the substances and preparations contained in it, and for no others. It has been held in the Divisional Courts (*Dickin v. Randerson*) that the Pharmacopoeia is a standard for official preparations asked for under their pharmacopoeial name. But there are many substances in the Pharmacopoeia which are not only employed in medicine, but have other uses, such as sulphur, benzoin, tragacanth, gum arabic, ammonium carbonate, beeswax, oil of turpentine, linseed oil, and for these a commercial standard of purity as distinct from a medicinal one is needed, since the preparations used in medicine should be of the highest possible degree of purity obtainable, and this standard would be too high and too expensive for ordinary purposes. The use of trade synonyms in the Pharmacopoeia, such as saltpetre for purified potassium nitrate, and milk of sulphur for precipitated sulphur, is partly answerable for this difficulty, and has proved to be a mistake, since it affords ground for legal prosecution if a chemist sells a drug of ordinary commercial purity for trade purposes, instead of the purified preparation which is official in the Pharmacopoeia for medicinal use. This would not be the case if the trade synonym were omitted. For many drugs and chemicals not in the Pharmacopoeia there is no standard of purity that can be used under the Adulteration of Food and Drugs Act, and for these, as well as for the commercial quality of those drugs and essential oils which are also in the Pharmacopoeia, a legal standard of commercial purity is much needed. This subject formed the basis of discussion at several meetings of the Pharmaceutical Society, and the results have been embodied in a work entitled *Suggested Standards for Foods and Drugs*, by C. G. Moor, which indicates the average degree of purity of many drugs and chemicals used in the arts, as well as the highest degree of purity obtainable in commerce of those used in medicine.

An important step has also been taken in this direction by the publication under the authority of the Council of the Pharmaceutical Society of Great Britain of the *British Pharmaceutical Codex*, in which the characters of and tests for the purity of many non-official drugs and preparations are given as well as the character of many glandular preparations and antitoxins that have come into use in medicine, but have not yet been introduced into the Pharmacopoeia. This work may also possibly serve as a standard under the Adulteration of Food and Drugs Act for the purity and strength of drugs not included in the Pharmacopoeia and as a standard for the commercial grade of purity of those in the Pharmacopoeia which are used for non-medical purposes.

Another legal difficulty connected with modern pharmacopoeias is the inclusion in some of them of synthetic chemical remedies, the processes for preparing which have been patented, whilst the substances are sold under trade-mark names such as veronal. The scientific chemical name is often long and unwieldy, and the physician prefers when writing a prescription to use the shorter name under which it is sold by the patentees. In this case the pharmacist is compelled to use the more expensive patented article and the patient complains of the price. If he uses the same article under its pharmacopoeial name when the patented article is prescribed he lays himself open to prosecution by the patentee for infringement of patent rights. The only plan, therefore, is for the physician to use the chemical name (which cannot be patented) as given in the Pharmacopoeia, or—for those synthetic remedies not included in the Pharmacopoeia—to use the scientific and chemical name given in the *British Pharmaceutical Codex*.

International Pharmacopoeia.—Increased facilities for travel have brought into greater prominence the importance of an approach to uniformity in the formulæ of the more powerful remedies, in order to avoid danger to patients when a prescription is dispensed in a different country from that in which it was written. Attempts have been made by international pharmaceutical and medical conferences to settle a basis on which an international pharmacopoeia could be prepared, but, owing to national jealousies and the attempt to include too many preparations in such a work it has not as yet

been produced. The standardization of preparations of patent medicines, as regards the amount of active principles they contain, can only conveniently and economically be done in operating on large quantities, and must naturally lead to the preparations being standardized at wholesale houses, who issue a guarantee with them; but it is not yet certain that deterioration may not take place after standardization, in such as those of ergot or digitalis, so that it is somewhat questionable whether the standardization is of permanent value in all cases. Probably more dependence is to be placed on careful selection of the drug, and skill in its preparation and preservation by the retail pharmacist, who should be personally responsible for the quality and purity of the preparations he sells. Although the attempt to form an international pharmacopoeia has failed, a project for an imperial pharmacopoeia which should be adapted to the general and local requirements of all parts of the British Empire has met with better success. With the aid of the medical and pharmaceutical authorities in each of the seventy administrative divisions of the British Empire an Indian and Colonial addendum to the *British Pharmacopoeia* of 1898 was compiled and published in 1900 in which each article receives official sanction in the countries indicated at the foot of the monographs. This was regarded as a preparatory step to the publication of a complete imperial pharmacopoeia.

Several unofficial universal pharmacopoeias have been published in England and in France, which serve to show the comparative strength of parallel preparations in different countries. The metric or decimal mode of calculation and the centigrade scale of temperature are adopted in all pharmacopoeias except those of Great Britain (in which the metric equivalents are now given) and in some instances of Greece. The majority omit chemical formulae. An alphabetical arrangement is followed in all. The maximum doses of preparations are given in several pharmacopoeias and the physician must indicate on his prescription, if he exceeds this limit, by using a note of explanation after each article, that he purposely intends such a dose to be employed. The great increase of medical literature and international exchange of medical journals has led to the adoption in almost every country of all the really valuable remedial agents, and the more extended use of active principles has given rise to an approximation in strength of their solutions. The difficulty of nomenclature could probably be overcome by a list of synonyms being given with each article, and that of language by the use of Latin. The greatest stumbling-blocks in the way of uniformity are the tinctures and extracts—a class of preparations containing many very powerful drugs, but in which the same name does not always indicate the same thing; thus, extract of aconite signifies an extract of the root in the pharmacopoeias of the United States, Japan and Russia, extract of the leaves in the Danish and Portuguese, inspissated juice of the fresh leaves in the Greek, and alcoholic extract of the root in that of Spain and Italy, and alcoholic extract of the dried leaves in the Chilean pharmacopoeias. It appears probable, however, that the growth of pharmaceutical chemistry will indicate, in time, which of those in use form the most active and trustworthy preparations, while the general adoption of the metric system will lead to clearer approximation of strength than hitherto. The method adopted by the Portuguese Pharmacopoeia comes nearest to that uniformity which is so desirable in such preparations, as the tinctures of the fresh plants are all prepared with equal parts of the drug and alcoholic menstruum; simple tinctures in general, with unfortunately a few exceptions, with one part of the drug in five parts of alcohol of given strength; ethereal tinctures are in the proportion of one part in ten; and the tinctures of the alkaloids and their salts contain one part of the alkaloid in ninety-nine of menstruum.

Homeopathic and eclectic practitioners as well as dentists have also their special pharmacopoeias.

See Bell and Redwood, *Progress of Pharmacy* (London, 1880); Scherer, *Literatura pharmacopoeiarum* (Leipzig and Sorau, 1822); Flint, *Report on the Pharmacopoeias of all Nations* (Washington, 1883). (E. M. H.)

PHARMACOSIDERITE, a mineral species consisting of hydrated basic ferric arsenate, $2\text{FeAsO}_4 \cdot \text{Fe}(\text{OH})_2 \cdot 5\text{H}_2\text{O}$. Crystals have the form of small, sharply defined cubes of an olive- or grass-green colour, and occur together in considerable numbers on the matrix of the specimens. On account of its cubic form the mineral was early known as "cube ore" (Ger., *Würfelerz*), the name pharmacosiderite, given by J. F. L. Hausmann in 1813, alludes to the arsenic and iron present (*pháρμακον*, poison, and *σίδηρος*, iron). The faces of the cube are striated parallel to one diagonal, and alternate corners are sometimes replaced by faces of a tetrahedron. The crystals are feebly doubly refracting, and in polarized light exhibit a banded structure parallel to the cube faces. The hardness is 2½ and the specific gravity 2.8. Recent analyses prove the presence of a small but variable amount of potassium (K_2O , 2.68–4.13%) in the Cornish crystals, though in those from Hungary there is

only a trace; this constituent appears to take the place of basic hydrogen in the above formula. A curious property is to be observed when a crystal of pharmacosiderite is placed in a solution of ammonia—in a few minutes the green colour changes throughout the whole crystal to red; on placing the red crystal in dilute hydrochloric acid the green colour is restored. Natural crystals are sometimes honey-yellow to brown in colour, but this appears to be due to alteration.

Pharmacosiderite is a mineral of secondary origin, the crystals occurring attached to gozany quartz in the upper part of veins of copper ore. It was found in some abundance at the end of the 18th century in the copper mines of the St Day district in Cornwall, and has since been found at a few other localities, for example, at Köszigsberg near Schemnitz in Hungary, and in the Tintic district in Utah. (L. J. S.)

PHARMACY, a term which in the original Greek form signified the use of any kind of drug (*φάρμακον*), potion or spell, and hence also poison and witchcraft. In the modern signification it is applied to the act of preparing, preserving and compounding medicines, according to the prescriptions of physicians. It was used first in this sense in 1597.

In the earliest periods of the world's history of which we have any record, this art, like that of the perfumer, was practised by a special class of the priesthood, as in the case of Eleazar (Num. iv. 16), and that of medicine by another class (Lev. xiii.).

Egyptian inscriptions indicate that the physician-priests sent their prescriptions to be dispensed by the priests of Isis when, accompanied by the chanter of incantations and spells, they visited the sick. A papyrus of Sent, 3300 B.C., gives directions as to the preparation of prescriptions. In the Ebers papyrus, 1550 B.C., mention is made of blisters, ointments, clysters, mineral and vegetable drugs. The art of the apothecary is alluded to very early in the Old Testament history (Exod. xxx. 25–35 and xxxvii. 20) and again in the time of Solomon (Eccles. x. 9), but this word, which is translated *parfumeur* in the French version, only indicates that the preparation of fragrant unguents and incense formed, even at that early date, a part of pharmacy, since the drugs mentioned, viz. galbanum, myrrh, stacte, frankincense, calamus, cassia and cinnamon, were all of them used in perfumes, even the myrrh being probably the kind distinguished at the present time in the Bombay market as perfumed myrrh or bisabol, which still forms an ingredient of the joss sticks used as incense in the temples in China. The myrrh mentioned in Gen. xxxvii. 35 is described under another Hebrew word, and refers to ladanum, a fragrant resin produced in Cyprus, and the use of this drug, as well as that of cinnamon and cassia, indicates even at that early period a knowledge of the products of Somaliland, Arabia and the East Indies and the existence of trade between the farther East and Egypt. In China also at a very early period the art of pharmacy was practised. Ching-Hong, a contemporary of Menes I. of Egypt, was learned in the art, and made decoctions and extracts of plants. The materia medica of the Chinese at the present date affords an excellent illustration of the changes that have taken place in the use of drugs, and of the theories and superstitions that have guided the selection of these from the earliest ages, inasmuch as it still comprises articles that were formerly used in medicine, but have now been utterly discarded. Thus the doctrine of signatures is evident in the use of the celebrated root of China, which, like that of the mandrake (Gen. xxx. 14–16), owed its employment to the fact that the root often divides into branches resembling the arms and legs of a man, and this resemblance gave rise to the belief that it conferred strength and virility. The same belief is shown in the botanical names applied to many plants, e.g. Pulmonaria, Hepatica, Scrophularia, and others.

The astrological belief that plants, animals and minerals are under the influence of the planets is shown in the older names of some of the metals, e.g. Saturn for lead, Venus for copper, and Mars for iron, and the belief that the colours of flowers

¹ The Egyptians believed that the medicinal virtues of plants were due to the spirits who dwelt within them.

indicated the particular planet they were under led to their use in diseases and for constitutions supposed to be under the same planet. Physicians to this day head their prescriptions with a sign that originally meant an invocation to Jupiter, but now represents the word *recipe*.

The belief, which is still held by the Chinese, that the excrements of animals retain the properties and peculiarities of the animals from which they are derived, led to the use in medicine of these disgusting remedies, which are still sold in drug shops in China, and were only omitted from the English Pharmacopoeia as late as 1771. At that date the science of chemistry was very imperfectly known, and the real constituents of ordinary remedies so little understood that different virtues were attributed to different products containing the same constituents. Thus, prepared oyster-shells, coral, pearls, crabs' "eyes" and burnt hart's horn were regarded as specifics in different complaints, in ignorance of the fact that they all contain, as the chief ingredients, calcium phosphate and carbonate. The celebrated Gascoigne's powder, which was sold as late as the middle of the 19th century in the form of balls like sal prunella, consisted of equal parts of crabs' "eyes," the black tips of crabs' claws, Oriental pearls, Oriental bezoar and white coral, and was administered in jelly made of hart's horn, but was prescribed by physicians chiefly for wealthy people, as it cost about forty shillings per ounce. Superstition also entered largely into the choice of remedies. Thus various parts of criminals, such as the thigh bone of a hanged man, moss grown on a human skull, &c., were used, and even the celebrated Dr Culpeper in the 17th century recommended "the ashes of the head of a coal black cat as a specific for such as have a skin growing over their sight."

In course of time the knowledge of drugs, and consequently the number in use, gradually increased, and some of the preparations made in accordance with the art attained a celebrity that lasted for centuries. Thus diachylon plaster was invented by Menecrates in A.D. 1, and was used by him for the same purposes as it is employed to-day. An electuary of opium, known as *Mithradatum*, was invented by Mithradates VI., king of Pontus, who lived in constant fear of being poisoned, and tested the effects of poisons on criminals, and is said to have taken poisons and their antidotes every day in the year. The prescription for the general antidote known as *Mithradatum* was found with his body, together with other medical MSS., by Pompey, after his victory over that king. The prescription was improved by Damocrates and Andromachus, body physicians to Nero. The first was subsequently known as *Mithradatum Damocratis*, and the second as *Theriaca Andromachi*, the name *Theriaca* or *Tiriaca* being derived from the snake called Tyrrus, the flesh of which was added to it by Andromachus. The former contained 55, or, according to some formulae, 72 ingredients, and occurs in all the dispensatories, from that of Corvus Valerius up to the pharmacopoeias of the 19th century; and aromatic preparations of opium are still used, under the name of *Theriaca* in Persia. The *Theriaca* prepared at Venice had the highest reputation, probably because in Venice the component parts were exposed to the inspection of wise men and doctors for two months, to determine whether they were or were not fit for use. The apothecaries' ordinance at Nuremberg provided that no *Theriaca* should in future be branded with the seal of the city unless it had been previously examined and declared worthy of the same by the doctors of medicine, and that every druggist must know the age of the *Theriaca* he sold. Inasmuch as its action changed very materially with age, "the buyer should in all instances be informed, so that he may not be deceived." The last public preparation of *Theriaca* took place at Nuremberg in 1754.

In A.D. 77-78 Dioscorides of Anazarba, in Cilicia, wrote his great work on materia medica, which still remains the most important work on the plants and drugs used in ancient times (of which about 400 were enumerated) and until the 17th century was held as the most valuable guide to medicinal plants and drugs extant. Nearly 700 years afterwards Galen, the imperial physician at Rome (A.D. 131-200), who was learned in surgery,

pharmacy and materia medica, added about 200 more plants to those described by Dioscorides.

Galen believed in the doctrine of humours originated by Hippocrates, which supposes the condition of the body to depend upon the proper mixture of the four elements, hot, cold, moist and dry, and that drugs possess the same elementary qualities, and that on the principle of contraries one or other was indicated, e.g. a cooling remedy for a feverish state. This doctrine was held for many centuries, and drugs are classed by all the old herbalists as having one or other of these qualities in a greater or less degree. Galen is said to have invented *hierac-picra*, which he employed as an anthelmintic; it is still used in England as a domestic remedy. In the 6th century Alexander of Tralles used colchicum for gout, iron for anaemia, and rhubarb in liver weakness and dysentery. The practice of pharmacy was extended by the Arabian physicians, and the separation of it from medicine was recognized in the 8th, and legalized in the 11th century. The practice of "polypharmacy," or the use of a large number of ingredients in prescriptions, which was common in the middle ages, was greatly due to the view enunciated by Alkekendo, and held by one of the Arabian schools of medicine: that the activity of medicine increases in a duplicate ratio when compounded with others; and it was only in the first half of the 18th century that the practice was altogether discontinued in the pharmacopoeias, although the theory was shown to be incorrect by Averroes in the 12th century.

The establishments for dispensing medicines at Cordova, Toledo and other large towns under Arab rule, were placed under severe legal restrictions. Frederick II. in A.D. 1233 passed a law, which remained in force for a long time in the two Sicilies, by which every medical man was required to give information against any pharmacist who should sell bad medicine. The pharmacists were divided into two classes, the *stationarii*, who sold simple drugs and non-magisterial preparations at a tariff determined by competent authorities, and the *confectionarii*, whose business it was to dispense scrupulously the prescriptions of medical men; all pharmaceutical establishments were placed under the surveillance of the college of medicine. In the monastic period pharmacy was to a great extent under the control of the religious orders, particularly the Benedictines, who, from coming into contact with the Arabian physicians, devoted themselves to pharmacy, pharmacology and therapeutics; but, as monks were forbidden to shed blood, surgery fell largely into the hands of barbers, so that the class of barber-surgeons came into existence, and the sign of their skill in blood-letting still appears in provincial districts in England in the form of the barber's pole, representing the application of bandages.

In England the separation between medicine and pharmacy was somewhat later than on the continent of Europe. The earliest record of an apothecary's shop in London was in 1345. The status of the apothecary, as subordinate to the physician in the time of Henry VIII., is evident from the following, out of 21 rules laid down by a prominent apothecary, who was a cousin of Anne Boleyn: "His garden must be at hand, with plenty of herbs and seeds and roots. He must read Dioscorides. He must have mortars, pots, filters, glasses and boxes clean and sweet. He must have two places in the shop, one most clean for physic, and the base place for chirurgic stuff. He is neither to increase nor to diminish the physician's prescription; he is neither to buy nor to sell rotten drugs. He is only to meddle in his own vocation; and to remember that his office is only to be the physician's cook."

The drugs used by the physicians and apothecaries were purchased from the *grossarii* or sellers in gross, who were subsequently called grocers, some of whom specialized as druggists and others as chymists or chemists. The apothecaries, who were the pharmacists of those days, were not represented by any corporate body, but in the reign of King James I., in 1606, were incorporated with the Company of Grocers. This arrangement was not, however, approved of by the physicians, who obtained in 1617 a separate charter for the apothecaries, to the number of 114, which was the number of physicians then

practising in London. At the same time it was enacted that no grocer should keep an apothecary's shop, and that no surgeon should sell medicines, and that the physicians should have the power to search the shops of the apothecaries within 7 m. of London under a penalty of £100 in case of a refusal to permit it. Soon after the apothecaries were formed into a separate company they took into consideration means to prevent the frauds and adulterations practised by the grocers and druggists, and, to remedy the evil, established a manufactory of their own in 1626 so that they might make preparations for their own members. The frauds and adulterations were probably due in part to the apothecaries, for Dr Merrit, a collegiate physician of London, stated that "such chymists which sell preparations honestly made complain that few apothecaries will go to the price of them." The medicinal preparations which required the aid of a furnace, such as mineral earths, were undertaken by the chymists, who probably derived their name from the Alchemists, who flourished from the 14th to the 16th centuries. When the word was discovered to be derived from an Arabic prefix and a Greek word the prefix was dropped. In the 19th century the word chymist became altered to chemist, although the original spelling is still continued to a small extent. The curious signs on the coloured carboys in chemists' windows, which were commonly to be seen until the middle of the 19th century, were signs used by the alchemists to indicate various chemical substances. In 1604 the apothecaries had increased from 114 to nearly 1000, and many of them, having acquired a knowledge of the uses of medicine, began to prescribe medicines for their customers and to assume the functions of the physician, who retired in 1697 by establishing dispensaries, where medicines could be procured at their intrinsic value, or at cost price. The assistants employed at these dispensaries after a time appear to have gone into business on their own account, and in this way the dispensing chemists, as a class, appear to have originated.

In 1748 the Apothecaries' Corporation obtained a charter empowering them to license apothecaries to sell medicines in London, or within 7 m., and intended to use it to restrain chemists and druggists from practising pharmacy, and to prohibit physicians and surgeons from selling the medicines they prescribed, but the apothecaries, by paying increased attention to medical and surgical practice, had not only alienated the physicians and surgeons, but materially strengthened the position of chemists and druggists as dispensers of prescriptions. When a further attempt was made in 1815 to bring a bill into parliament including provisions for prohibiting the practice of pharmacy by uneducated persons, and giving power to examine dispensing chemists, the latter became alarmed, and, finding that the provisions of the bill were entirely in the interests of the apothecaries, and directed against chemists and druggists, the latter took measures to oppose it in parliament, which were so far successful as to prevent apothecaries from interfering in any way with, or obtaining any control over, chemists and druggists. In 1841 another attempt was made by the apothecaries to control the trade of chemists and druggists on the ground that no adequate examination or education in pharmacy existed, and that such should be instituted, and be controlled by the apothecaries and physicians, but the latter disclaimed any desire to take an active part in the matter. The chemists and druggists, recognizing that no institution for the systematic education and examination of chemists and druggists existed in England, and that no proof could be given that each individual possessed the necessary qualifications, decided that this objection must be met, and that pharmacy must be placed upon a more scientific footing. They therefore resolved upon the foundation of a voluntary society, under the title of the Pharmaceutical Society of Great Britain, "for advancing the knowledge of chemistry and pharmacy, and promoting a uniform system of education for those who should practise the same, also for protecting the collective and individual interests and privileges of all its members, in the event of any hostile attack in parliament or elsewhere." This society was instituted in 1841, the original founders being chemists and druggists in the

metropolis and provincial towns. On the 18th of February 1843 a royal charter of incorporation was granted to the society, and a permanent status was thus acquired. Chemists in business before the granting of the charter were entitled to join the society as members, but those who wished to join it subsequently could do so only on condition of passing an examination for the purpose of testing their knowledge of pharmacy. A school of pharmacy was instituted, and a museum and library were started. The chemical laboratory in connexion with the school was, when first instituted, the only one in England for teaching purposes, and the museum is now reputed to be the best pharmaceutical one in the world, the library now containing about 13,000 volumes.

The examinations are three in number. The first is of a preliminary character, qualifying for registration as a student or apprentice; in lieu of this examination, certificates of matriculation at a university, and those of certain other educational bodies, are accepted. The second examination qualifies for registration as a chemist and druggist. This is known as the minor examination, and must be passed before anyone can legally dispense, compound and sell scheduled poisons. The subjects included are systematic botany, vegetable morphology and physiology, chemistry, physics, materia medica, pharmacy, dispensing, poeology, the reading of prescriptions, and a knowledge of poisons and their antidotes. The Poisons and Pharmacy Act of 1908 (section 4) has given the society power to regulate the preliminary training, arrange a curriculum, and divide the qualifying examination into two parts, so that an approximation to the standard of pharmaceutical education on the Continent is likely to take place within a short period. Degrees in science and pharmacy are granted by the universities of Manchester and Glasgow, and other universities were in 1910 considering the question of granting degrees.

The third, or major examination, which qualifies for registration as a pharmaceutical chemist, is not, like the minor, a compulsory one, but ranks as an honours examination. The education for this examination has kept pace with the rapid advances of science, all the following subjects now receiving attention: the microscopic structure of plants and drugs, so as to detect adulterations and impurities in powdered drugs; organic and quantitative analysis, including those of food and drugs, water, soils, gas and urine; optics, so as to enable them to carry out the prescriptions of oculists; spectrum analysis; the use of the polariscope and refractometer; the method of applying Röntgen rays; the preparation of glandular secretions and antidotes; and the chemistry of remedies for the fungoid diseases and insect pests of plants.

Those who have passed this examination are competent to perform analysis of all kinds, and generally obtain the preference for various appointments, such as head dispensers in government or other large hospitals, or as analysts. The society has also established a chemical research laboratory, in which much useful work has been done in connexion with the national pharmacopoeia under the direction of the Pharmacopoeia Committee of the Medical Council.

A pharmacy act, which was passed in 1852, established a distinction between registered and examined, and unregistered and unexamined chemists and druggists, creating a register of the former under the name of pharmaceutical chemists, so that the public might discriminate between the two classes. A subsequent pharmacy act, passed in 1868, added a register of chemists and druggists, and rendered it unlawful for any unregistered person to sell or keep open shop for selling the poisons mentioned in the schedule of this act. The administration of the act was entrusted to the pharmaceutical society, and the duty of prosecuting unauthorized practitioners has been performed by the society ever since, without any pecuniary assistance from the state, although the legal expenses involved in prosecution amount to a considerable portion of its income.

The Poisons and Pharmacy Act of 1908 extended the schedule of poisons instituted by the act of 1868, and it now includes arsenic, aconite, aconitine and their preparations; all poisonous vegetable alkaloids, and their salts and poisonous derivatives; atropine and its salts and their preparations; belladonna and all preparations or admixtures (except belladonna plasters) containing 0.1% or more of belladonna alkaloid; cantharides and its poisonous derivatives; any preparation or admixture of coca-leaves containing 0.1% or more of coca alkaloids; corrosive sublimate; cyanide of potassium and all poisonous cyanides and their preparations; tartar emetic, nux vomica, and all

preparations or admixtures containing 0.2% or more of strychnine; opium and all preparations and admixtures containing 1% or more of morphine; picro-toxine; prussic acid and all preparations and admixtures containing 0.1% or more of prussic acid; savin and its oil, and all preparations or admixtures containing savin or its oil. None of these may be sold to any person who is unknown to the seller, unless introduced by a person known to the seller, and not until after an entry is made in a book kept for the purpose, stating, in the prescribed form, the date of sale, name and address of purchaser, the name and quantity of the article sold, and the purpose for which it is stated by the purchaser to be required. The signature of the purchaser and introducer (if any) must be affixed to the entry.

The following poisons may not be sold, either retail or wholesale, unless distinctly labelled with the name of the article, and the word poison, with the name and address of the seller:—
Almonds, essential oil of (unless deprived of prussic acid). Antimonial wine. Cantharides, tincture and all vesicating liquids, preparations or admixtures of. Carbolic acid, and liquid preparations of carbolic acid and its homologues containing more than 3% of those substances, except preparations for use as sheep-wash or for any other purpose in connection with agriculture or horticulture, contained in a closed vessel distinctly labelled with the word "poisonous," the name and address of the seller, and a notice of the special purposes for which the preparations are intended. Chloral hydrate. Chloroform, and all preparations or admixtures containing more than 20% of chloroform. Coca, any preparation or admixture of, containing more than 0.1% but less than 1% of coca alkaloids. Digitalis. Mercuric iodide. Mercuric sulphocyanide. Oxalic acid. Poppies, all preparations of, excepting red poppy petals and syrup of red poppies (*Papaver Rhoeas*). Precipitate, red, and all oxides of mercury. Precipitate, white. Strophanthus. Sulphonal. All preparations or admixtures which are not included in part I of the schedule, and contain a poison within the meaning of the pharmacy acts, except preparations or admixtures, the exclusion of which from this schedule is indicated by the words therein relating to carbolic acid, chloroform and coca, and except such substances as come within the provisions of section 5 of the act.

It has been erroneously represented by interested persons that the Pharmaceutical Society desires a monopoly of the sale of poisons. This is not the case. Any poisonous substance that is not included in the schedules can be sold by anyone, as, for instance, red lead, sulphate of copper, &c. The duty of the Pharmaceutical Society is a purely legal one, and relates only to the schedules of poisons framed by the government to protect the public by rendering it a difficult matter to obtain the poisons most frequently used for criminal purposes. In continental countries the laws are even more stringent.

In response to an agitation originated by certain manufacturers (one of whom was a member of parliament), who were prosecuted for omitting to label arsenical and nicotine preparations as poisons, as required by the Pharmacy Act of 1868, a new act was passed in 1908, by which persons, without any training in toxicology, and being neither pharmaceutical chemists, nor chemists and druggists, may be granted licences by local authorities to sell poisonous substances used exclusively in agriculture or horticulture, for the destruction of insects, fungi or bacteria, or as sheep dips or weed-killers, but which are poisonous by reason of containing the scheduled poisons, arsenic or nicotine, &c. One condition concerning the granting of such licences has been, it is said, deliberately ignored in many towns, viz. that the local authority, before granting a licence, "shall take into consideration whether, in the neighbourhood, the reasonable requirements of the public are satisfied with regard to the purchase of poisonous substances, and also any objections they may receive from the chief officer of police, or from any existing vendors of the substances to which the application relates." It is left to the Pharmaceutical Society to take legal action against any infringement of the law, although it is obvious that this should be carried out at the government expense, since it is for the benefit of a section of the public, and obviously to the loss of the members of the Pharmaceutical Society. Moreover, the present act nullifies the object of the previous act of 1868, which was to reduce the facilities for obtaining poisons. The fact that a voluntary society with limited funds must contest the illegal decisions of local councils, without government support, seems likely to render this portion of the act of 1908 a dead letter.

At the time of the passing of the Pharmacy Act of 1852 co-operative associations did not come under consideration, and no provision was made concerning them as regards the title of chemist, or as to any action such associations might take to evade the law. It has been decided in the law courts that a limited liability company

is not a person in the eye of the law, and therefore does not come under the operation of the act of 1868. The result of this decision was that any chemist who failed to pass the qualifying examination could constitute himself with a few others, even if ignorant of pharmacy, into a limited liability company, which would then have been outside the powers of the act, and not subject to its provisions. This false position was remedied by the act of 1908, which brings companies into line with individuals.

On the continent of Europe the dispensing of prescriptions is confined to pharmacists (*pharmacians* and *apothecaries*). They are not allowed to prescribe, nor the ^{Foreign} ~~Regulations~~ medical men to dispense, except under special licence, and then only in small villages, where the pharmacist could not make a living. The principle of "one man one shop" is general; a pharmacist may not own more than one shop in the same town. In Holland he may not enter into any agreement, direct or indirect, with a medical man with regard to the supply of medicines. In Austria, Germany, Italy, Rumania and Russia the number of pharmacies is limited according to the population. In France, Switzerland, Belgium and Holland the number is not limited, and every qualified pharmacist has the right to open a shop or buy a pharmacy. Where the number of pharmacies is limited by law prescriptions may only be dispensed at these establishments. The original prescription is kept by the pharmacist for either three or ten years, according to the country, and a certified copy given to the patient, written on white paper if for internal use, or on coloured paper (usually orange yellow) if for external use. The price of the drugs and the tariff for dispensing prescriptions is fixed by government authority. In Russia a prescription containing any of the poisons indicated in the schedules A and B in the Russian pharmacopoeia may not be repeated, except by order of the doctor. The use of pharmacopoeia preparations made by manufacturers is allowed, but the seller is held responsible for their purity and strength. The prices charged for dispensing are lower in countries where the number of pharmacies is limited by law, the larger returns enabling the profit to be lessened.

The educational course adopted in different countries varies as to the details of the subjects taught. The preliminary, or classical examination, is usually that of university matriculation, or its equivalent. The period of study is eighteen months in Denmark or Norway, and two in Austria, Finland, Germany, Portugal, Russia, Sweden and Switzerland, three in Belgium, France, Greece and Italy, four to six in Holland, and five in Spain. In Great Britain the period of study is voluntary, and usually occupies only one year. Two or three years of apprenticeship is required in most countries, including Great Britain, but none in Belgium, Greece, Italy or Spain.

The subject of patent medicines is but little understood by the general public. Any medicine, the composition of which is kept secret, but which is advertised on the label for the cure of diseases, must in Great Britain bear a patent ^{Patent} ~~Medicine~~ medicine stamp equal to about one-ninth of its face value. The British Medical Association published in 1907 a work on *Secret Remedies; what they cost and what they contain*. The analyses published in this work show that nearly all the widely advertised secret remedies contain only well-known and inexpensive drugs. The Pharmaceutical Society on the other hand has also published a *Pharmaceutical Journal Formulary*, including several hundred formulae of proprietary medicines sold by pharmacists, so that it is now possible for any medical man to ascertain what they contain. The government accepts all the therein published formulae as "known, admitted and approved" remedies, and therefore not requiring a patent medicine stamp. In this way widely advertised secret remedies can be replaced by medicines of known composition and accepted value in any part of the world. Most continental countries have issued stringent laws against the sale of secret remedies, and these have been lately strengthened in Germany, France and Italy. In Switzerland secret remedies cannot be advertised without submitting the formula and a sample of the remedy to the board of health. (E. M. H.)

PHARNABAZUS, Persian soldier and statesman, the son of Pharnaces, belonged to a family which from 478 governed the satrapy of Phrygia on the Hellespont, from its headquarters at Dascylium, and, according to a discovery by Th. Nöldeke, was descended from Otanes, one of the associates of Darius in the murder of Smerdis. Pharnabazus first appears as satrap of this province in 413, when, having received orders from Darius II. to send in the outstanding tribute of the Greek cities on the coast, he, like Tissaphernes of Caria, entered into negotiations with Sparta and began war with Athens. The conduct of the war was much hindered by the rivalry between the two satraps, of whom Pharnabazus was by far the more energetic and upright. After the war he came into conflict with Lysander (*q.v.*: see also PELOPONNESIAN WAR), who tried to keep the Greek cities under his own dominion, and became one of the causes of his overthrow, by a letter which he sent to the ephors at Sparta (*Plut. Lys.* 19; *Nepos, Lys.* 4; *Polyaen.* vii. 19). He received Alcibiades at his court and promised him means to go up to the king to reveal the intrigues of Cyrus, but when the Spartans insisted on his death he yielded to their demand for his assassination (*Plut. Alcib.* 37 sqq.; *Diod.* xiv. 11). When in 399 the war with Sparta broke out he again tried to conduct it strenuously. With the help of Conon and Evagoras of Salamis he organized the Persian fleet; and while he was hard pressed on land by Agesilaus he prepared the decisive sea-battle, which was fought in August 394 at Cnidus under his and Conon's command, and completely destroyed the Spartan fleet. He sent support to the allies in Greece, by which the walls of the Peiraeus were rebuilt. But in the war on land he struggled in vain against the lethargy and disorganization of the Persian Empire; and when at last, in 387, in consequence of the embassy of Antalcidas to Susa, the king decided to conclude peace with Sparta and to enter again into close alliance with her, Pharnabazus, the principal opponent of Sparta, was recalled from his command in high honours, to marry Apame, a daughter of the king (*Plut. Artox.* 27). In 385 he was one of the generals sent against Egypt, and in 377 he was ordered to prepare a new expedition against the valley of the Nile. The gathering of the army took years, and when in 373 all was ready, his attempt to force the passage of the Nile failed. A conflict with Iphicrates, the leader of the Greek mercenaries, increased the difficulties; at last Pharnabazus led the army back to Asia. From these campaigns date the silver coins with the name of Pharnabazus in Aramaic writing. When he died is not known.

In the time of Alexander we meet with a Persian general Pharnabazus, son of Artabazus (*Arrian* ii. 1 seq.), who probably was the grandson of the older Pharnabazus.

The name Pharnabazus is also borne by a king of Iberia (Georgia) on the Caucasus, where the dynasty seems to have been of Persian origin, defeated by a general Marcus Antonius (Mark Antony) in 36 B.C. (*Dio Cass.* xlix. 24). In the Georgian dynasty the name occurs as late as the 19th century. (E. M.)

PHARYNGITIS. The pharynx, or upper portion of the gullet (seen to a large extent on looking at the back of the mouth) is frequently the seat of a chronic inflammatory condition, usually associated with derangements of the digestive organs, or with syphilis or gout; sometimes it is due to much speaking or to excessive tobacco-smoking—especially of cigarettes. On inspection, the inflamed mucous membrane is seen unduly red and glazed, and dotted over with enlarged follicles. The condition produces considerable irritation and "dryness," with cough and discomfort, which may eventually become chronic. Treatment consists in removing all sources of irritation, in rectifying gastric disturbance, and in the application of the electric cauter, of astringent lotions or of mild caustic solutions. The pain may be relieved by spraying with certain anodyne solutions. In the case of adenoid growths (see ADENOIDS) there is often an associated granular appearance of the pharynx, due to enlargement of the minute glands of the mucous membrane. The inflamed pharynx of the orator ("clergyman's sore-throat") may be put right by lessons in elocution or by complete rest for a time. The gouty throat may call for a change of diet, or for a stay at one of the watering-places where early rising, moderate

food, regular exercise and the drinking of laxative waters join in restoring health. (E. O.')

PHARYNX (Gr. *φάρυγξ*, throat), in anatomy, the cavity into which both the nose and mouth lead, which is prolonged into the oesophagus or gullet below, and from which the larynx or air tube comes off below and in front; it therefore serves as a passage both for food and air. It may be likened to an empty sack turned upside down and narrowing toward its mouth. The back and sides of the sack are formed by the three constrictor muscles of the pharynx, each of which overlaps the outer surface of the one above it, and these are lined internally by thick mucous membrane. The upturned bottom of the sack is attached firmly to the base of the skull and the internal pterygoid plates, so that this part cannot collapse, but below the anterior and posterior walls are in contact, and a transverse section of the pharynx is a mere slit.

From the front wall, on a level with the floor of the nose and roof of the mouth, a slanting shelf of muscular and glandular tissue covered with mucous membrane, projects downward and backward into the cavity, and divides it into an upper part or naso-pharynx and a lower or oral pharynx (see fig.). This shelf is the *soft palate*, and from the middle of its free border hangs a worm-like projection, of variable length but averaging about half an inch, the *uvula*. The whole of the front wall of the naso-pharynx is wanting, and here the cavity opens into the nose through the posterior nasal apertures (see OLFATORY SYSTEM). On each side of the naso-pharynx, and therefore above the soft palate, is the large triangular opening of the Eustachian tube through which air passes to the tympanum (see EAR). Behind this opening, and reaching up to the roof of the naso-pharynx, is a mass of lymphoid tissue, most marked in children, known as the pharyngeal tonsil. This tissue, when it hypertrophies, causes the disease known as "adenoids."

From the mid-line of the roof of the pharynx a small pouch, the *bursa pharyngea*, best seen in childhood, projects upward, while on each side, above and behind the opening of the Eustachian tube, is a depression known as the lateral recess of the pharynx.

The oral pharynx communicates with the naso-pharynx by the pharyngeal isthmus behind the free edge of the soft palate. Above and in front it is continuous with the cavity of the mouth, and the demarcation between the two is a ridge of mucous membrane on each side running from the soft palate to the side of the tongue, and caused by the projection of the palato-glossus muscle. This is known as the anterior pillar of the fauces or anterior palatine arch. About half an inch behind this ridge is another, made by the palato-pharyngeus muscle, which gradually fades away in the side of the pharynx below. This is the posterior pillar of the fauces or posterior palatine arch, and between it and the anterior is the fossa (tonsillar sinus) in which the tonsil lies.

The *Tonsil* is an oval mass of lymphoid tissue covered by mucous membrane which dips in to form mucous crypts; externally its position nearly corresponds to that of the angle of the jaw. It is very vascular, deriving its blood from five neighbouring arteries. Below the level of the tonsil the anterior wall of the pharynx is formed by the posterior or pharyngeal surface of the tongue (*q.v.*), while below that is the epiglottis and upper opening of the larynx which is bounded laterally by the aryteno-epiglottic folds (see RESPIRATORY SYSTEM). On the lateral side of each of these folds is a pear-shaped fossa known as the *sinus pyriformis*. Below this the pharynx narrows rapidly until the level of the lower border of the cricoid cartilage in front and of the sixth cervical vertebra behind is reached; here it passes into the oesophagus, having reached a total length of about five inches.

The mucous membrane of the naso-pharynx, like that of the rest of the respiratory tract, is lined by ciliated columnar epithelium, but in the oral pharynx the epithelium is of the stratified squamous variety. Numerous racemose glands are present (see EPITHELIAL TISSUES), as well as patches of lymphoid tissue especially in childhood. Outside the mucous membrane and separating it from the constrictor muscles is the pharyngeal aponeurosis, which blends above with the pre-osteum of the base of the skull.

Embryology.—The pharynx is partly formed from the ectodermal stomatodaeal invagination (see EMBRYOLOGY and MOUTH) and partly from the fore gut, which is the cephalic part of the entodermal mesodaeum. Up to the fifteenth day (see MOUTH), the bucco-pharyngeal membrane separates these structures, and, though no vestiges of it remain, it is clear that the upper and front part of the naso-pharynx is stomatodaeal while the rest is mesodaeal. The five visceral arches with their intervening clefts or pouches surround the pharynx, and the Eustachian tube is a remnant of the first of these. The second pouch is represented in the adult by the tonsillar sinus, and until lately the lateral recess of the pharynx was looked upon as part of the same, but it has now been shown to be an independent diverticulum. The *sinus pyriformis* probably represents that part of the fourth groove from which the lateral lobes of the thyroid body are derived.

The *Bursa pharynges* was at one time looked upon as the place whence the pituitary body had been derived from the roof of the pharynx, but this is now disproved and its meaning is unknown. The tonsil is formed in the second branchial cleft or rather pouch, for the clefts are largely incomplete in man, about the fourth month; its lymphoid tissue, as well as that elsewhere in the pharynx, is formed from lymphocytes in the subjacent mesenchyme (see EMBRYOLOGY), though whether these wander in from the blood or are derived from original mesenchyme cells is still doubtful. The

these form the simplest type of true internal gills. In the larval lamprey (*Ammocoetes*) there are eight gill slits opening from the pharynx, but in the adult (*Petromyzon*) they are reduced to seven, and a septum grows forward separating the ventral or branchial part of the pharynx from the dorsal or digestive part. Both these tubes, however, communicate near the mouth.

In fishes there are usually five pairs of gill slits, though a rudimentary one in front of these is often present and is called the spiracle. Occasionally, as in *Hexanchus* and *Heptanchus*, there may be six or seven slits, and the evidence of comparative anatomy is that fishes formerly had a larger number of gill slits than at present.

In the Teleostomi, which include the bony fishes, there is an external gill cover or operculum.

In the Dipnoi or mud fish the work of the gills is shared by that of the lungs, and in the African form, *Protopterus*, external gills, developed from the ectodermal parts of the gill slits, first appear. In the tailed Amphibians (*Urodela*) the first and fifth gill clefts are never perforated and are therefore in the same condition as all the gill clefts of the human embryo, while in the gilled salamanders (*Necturus* and *Proteus*) only two gill clefts remain patent. The gills in all the Amphibia are external and of ectodermal origin, but in the Anura (frogs and toads) these are succeeded before the metamorphosis from the tadpole stage by internal gills, which, unlike those of fish, are said to be derived from the ectoderm.

In the embryos of the Sauropsida (reptiles and birds) five gill clefts are evident, though the posterior two are seldom at any time perforated, while in the Mammalia the rudiments of the fifth cleft are no longer found in the embryo, and in man, at all events, none of them are normally perforated except that part of the first which forms the Eustachian tube. It will thus be seen that in the process of phylogeny there is a gradual suppression of the gill clefts beginning at the more posterior ones.

The soft palate is first found in crocodiles as a membranous structure, and it becomes muscular in mammals. The *bursa pharynges* and pharyngeal tonsil are found in several of the lower mammals. In the sheep the latter is particularly large.

For literature and further details, see R. Wiedersheim's *Comparative Anatomy of Vertebrates*, translated by W. N. Parker (London, 1907); also Parker and Haswell's *Zoology* (London, 1897). (F. G. P.)

PHEASANT (Mid. Eng. *fesaunt* and *fesaun*; Ger. *fasan* and anciently *fasent*; Fr. *faisan*—all from the Lat. *phasianus* or *phasiana*, sc. *avis*), the bird brought from the banks of the river Phasis, now the Rioni, in Colchis, where it is still abundant, and introduced, according to legend, by the Argonauts into Europe. Judging from the

recognition of the remains of several species referred to the genus *Phasianus* both in Greece and in France,¹ it seems not impossible that the ordinary pheasant, the *P. colchicus* of ornithologists, may have been indigenous to this quarter of the globe. If it was introduced into England, it must almost certainly have been brought by the Romans;² for, setting aside several earlier records of doubtful authority,³ Stubbs has shown that by the regulations of King Harold in 1059 *unus phasianus* is prescribed as the

¹ These are *P. archiaci* from Pikerini, *P. alius* and *P. medius* from the lacustrine beds of Sansan, and *P. desmoyersi* from Touraine, see A. Milne Edwards, *Ois. foss. de la France* (ii. 229, 239-243).

² Undoubted remains have been found in excavations at Silchester.

³ Among these perhaps that worthy of most attention is in Probert's translation of *The Ancient Laws of Cambrria*. (ed. 1823, pp. 367, 368), wherein extracts are given from Welsh triads, presumably of the age of Howel the Good, who died in 948. One of them is, "There are three barking hunts: a bear, a squirrel and a pheasant." The explanation is, "A pheasant is called a barking hunt, because when the pointers come upon it and chase it, it takes to a tree, where it is hunted by barking." The present writer has not been able to trace the manuscript containing these remarkable

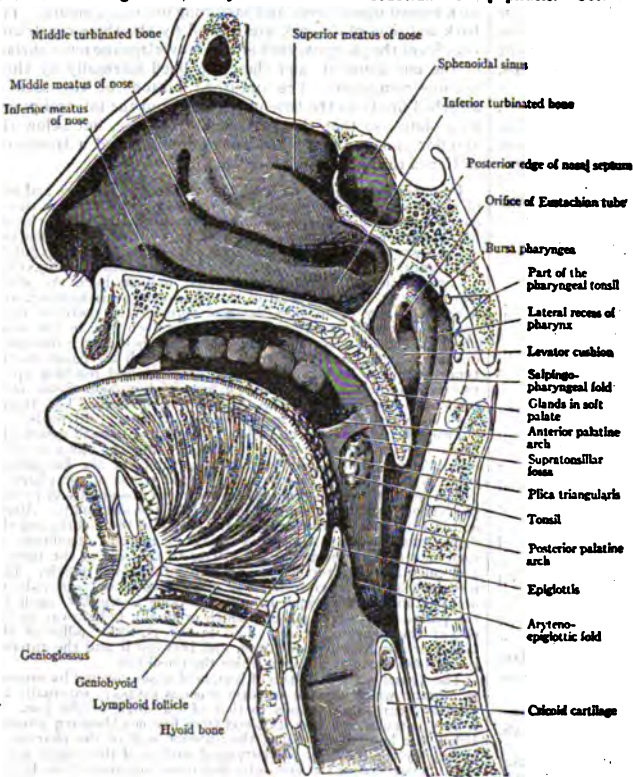

(From Ambrose Birmingham, Cunningham's *Text Book of Anatomy*.)

Sagittal Section through Mouth, Tongue, Larynx, Pharynx and Nasal Cavity.

The section is slightly oblique, and the posterior edge of the nasal septum has been preserved. The specimen is viewed slightly from below, hence in part the low position of the inferior turbinate bone.

development of the ventral part of the pharynx is dealt with in the articles TONGUE and RESPIRATORY SYSTEM.

For literature see Quain's *Elements of Anatomy*, vol. i. (London, 1908), and J. P. McMurrich, *Development of the Human Body* (London, 1906).

Comparative Anatomy.—In the lower, water-breathing, vertebrates the pharynx is the part in which respiration occurs. The water passes in through the mouth and out through the gill slits where it comes in contact with the gills or branchiae.

The lowest subphylum of the phylum Chordata, to which the term *Adelochorda* is sometimes applied, contains a worm-like creature *Balanoglossus*, in which numerous rows of gill slits open from the pharynx, though *Cephalodiscus*, another member of the same subphylum, has only one pair of these.

In the subphylum Urochorda, to which the Ascidians or sea-squirrels belong, there are many rows of gill slits, as there are also in the Acrania, of which Amphioxus, the lancelet, is the type. In all these lower forms there are no true gills, as the blood-vessels lining the large number of slits provide a sufficient area for the exchange of gases.

In the Cyclostomata a reduction of the number of gill slits takes place, and an increased area for respiration is provided by the gill pouches lined by pleated folds of endodermal mucous membrane;

alternative of two partridges or other birds among the "pitantiae" (rations or commons, as we might now say) of the canons of Waltham Abbey, and, as W. B. Dawkins has remarked (*Ibis*, 1869, p. 358), neither Anglo-Saxons nor Danes were likely to have introduced it into England. It seems to have been early under legal protection, for, according to Dugdale, a licence was granted in the reign of Henry I. to the abbot of Amesbury to kill hares and pheasants, and from the price at which the latter are reckoned in various documents, we may conclude that they were not very abundant for some centuries, and also that they were occasionally artificially reared and fattened, as appears from Upton,¹ who wrote about the middle of the 15th century, while Henry VIII. seems from his privy purse expenses to have had in his household in 1532 a French priest as a regular "fesaunt breder," and in the accounts of the Kytsons of Hengrave in Suffolk for 1607 mention is made of wheat to feed pheasants, partridges and quails.

The practice of bringing up pheasants by hand is now extensively followed, and the numbers so reared vastly exceed those that are bred at large. The eggs are collected from birds that are either running wild or kept in pens, and are placed under domestic hens; but, though these prove most attentive foster-mothers, much additional care on the part of their keepers is needed to ensure the arrival at maturity of the poults; for, being necessarily crowded in a comparatively small space, they are subject to several diseases which often carry off a large proportion, to say nothing of the risk they run by not being provided with proper food, or by meeting an early death from various predatory animals attracted by the assemblage of so many helpless victims. As they advance in age the young pheasants readily take to a wild life, and indeed can only be kept from wandering in every direction by being plentifully supplied with food, which has to be scattered for them in the coverts in which it is desired that they should stay. The proportion of pheasants artificially bred that "come to the gun" would seem to vary enormously, not only irregularly according to the weather, but regularly according to the district. In the eastern counties of England, and some other favourable localities, perhaps three-fourths of those that are hatched may be satisfactorily accounted for; but in many of the western counties, though they are the objects of equal or even greater care, it would seem that more than half of the number that live to grow their feathers disappear inexplicably before the coverts are beaten. For the sport of pheasant-shooting see SHOOTING.

Formerly pheasants were taken in snares or nets, and by hawking; but the crossbow was also used, and the better to obtain a "sitting shot,"—for with that weapon men had not learnt to "shoot flying"—dogs appear to have been employed in the way indicated by the lines under an engraving by Höllar, who died in 1677:—

"The Fesaunt Cocke the woods doth most frequent,
Where Spaniels spring and pearch him by the sent."²

Of the many other species of the genus *Phasianus*, two only can be dwelt upon here. These are the ring-necked pheasant of China, *P. torquatus*, easily known by the broad white collar, whence it has its name, as well as by the pale greyish-blue of its upper wing-coverts and rump and the light buff of its flanks, and the *P. versicolor* of Japan, often called the green pheasant statements so as to find out the original word rendered "pheasant" by the translator; but a reference to what is probably the same passage with the same meaning is given by Ray (*Synops. meth. animalium*, pp. 213, 214) on the authority of Lloyd or Lloyd, though there is no mention of it in Wotton and Clarke's *Leges Wallacee* (1730). A charter (Kemble, *Cod. diplom.* iv. 236), professedly of Edward the Confessor, granting the wardenship of certain forests in Essex to Ralph Peperking, speaks of "fesant hen" and "fesant cocke," but is now known to be spurious.

¹In his *De studio militari* (not printed till 1654) he states (p. 195) that the pheasant was brought from the East by "Palladius anarista."

²Quoted by the writer (Broderip?) of the article "Spaniel" in the *Penny Cyclopaedia*. The lines throw light on the asserted Welsh practice mentioned in a former note.

from the beautiful tinge of that colour that in certain lights pervades almost the whole of its plumage, and, deepening into dark emerald, occupies all the breast and lower surface that in the common and Chinese birds is bay barred with glossy black scallops. Both of these species have been introduced into England, and cross freely with *P. colchicus*, while the hybrids of each with the older inhabitants of the woods are not only perfectly fertile *inter se*, but cross as freely with the other hybrids, so that birds are frequently found in which the blood of the three species is mingled. The hybrids of the first cross are generally larger than either of their parents, but the superiority of size does not seem to be maintained by their descendants. White and pied varieties of the common pheasant, as of most birds, often occur, and with a little care a race or breed of each can be perpetuated. A much rarer variety is sometimes seen; this is known as the Bohemian pheasant, not that there is the least reason to suppose it has any right to such an epithet, for it appears, as it were, accidentally among a stock of the pure *P. colchicus*, and offers an example analogous to that of the Japan peafowl (see PEACOCK), being, like that breed, capable of perpetuation by selection. Two other species of pheasant have been introduced to the coverts of England—*P. reevesi* from China, remarkable for its very long tail, white with black bars, and the copper pheasant, *P. soemmerringi*, from Japan. The well-known gold and silver pheasants, *P. pictus* and *P. nycthemerus*, each the type of a distinct section or subgenus, are both from China and have long been introduced into Europe, but are only fitted for the aviary. To the former is allied the still more beautiful *P. amherstiae*, and to the latter about a dozen more species, most of them known to Indian sportsmen by the general name of "kaleege." The comparatively plain pucras pheasants, *Pucrasia*, the magnificent monauls, *Lophophorus*, and the fine snow-pheasants, *Crossopitulum*—of each of which genera there are several species, may also be mentioned.

All the species known at the time are beautifully figured from drawings by J. Wolf in D. G. Elliot's *Monograph of the Phasianidae* (2 vols., fol., 1870-1872)—the last term being used in a somewhat general sense. With a more precise scope W. B. Tegetmeier's *Pheasants: their Natural History and Practical Management* (4th ed., 1904) is to be commended as a very useful work. (A. N.)

PHEIDIAS, son of Charmides, universally regarded as the greatest of Greek sculptors, was born at Athens about 500 B.C. We have varying accounts of his training. Hegias of Athens, Ageladas of Argos, and the Thasian painter Polygnotus, have all been regarded as his teachers. In favour of Ageladas it may be said that the influence of the many Dorian schools is certainly to be traced in some of his work. Of his life we know little apart from his works. Of his death we have two discrepant accounts. According to Plutarch he was made an object of attack by the political enemies of Pericles, and died in prison at Athens. According to Philochorus, as quoted by a scholiast on Aristophanes, he fled to Elis, where he made the great statue of Zeus for the Eleans, and was afterwards put to death by them. For several reasons the first of these tales is preferable.

Plutarch gives in his life of Pericles a charming account of the vast artistic activity which went on at Athens while that statesman was in power. He used for the decoration of his own city the money furnished by the Athenian allies for defence against Persia: it is very fortunate that after the time of Xerxes Persia made no deliberate attempt against Greece. "In all these works," says Plutarch, "Pheidias was the adviser and overseer of Pericles." Pheidias introduced his own portrait and that of Pericles on the shield of his Parthenon statue. And it was through Pheidias that the political enemies of Pericles struck at him. It thus abundantly appears that Pheidias was closely connected with Pericles, and a ruling spirit in the Athenian art of the period. But it is not easy to go beyond this general assertion into details.

It is important to observe that in resting the fame of Pheidias upon the sculptures of the Parthenon we proceed with little evidence. No ancient writer ascribes them to him, and he seldom, if ever, executed works in marble. What he was celebrated

for in antiquity was his statues in bronze or gold and ivory. If Plutarch tells us that he superintended the great works of Pericles on the Acropolis, this phrase is very vague. On the other hand, inscriptions prove that the marble blocks intended for the pedimental statues of the Parthenon were not brought to Athens until 434 B.C., which was probably after the death of Pheidias. And there is a marked contrast in style between these statues and the certain works of Pheidias. It is therefore probable that most if not all of the sculptural decoration of the Parthenon was the work of pupils of Pheidias, such as Alcamenes and Agoracritus, rather than his own.

The earliest of the great works of Pheidias were dedications in memory of Marathon, from the spoils of the victory. At Delphi he erected a great group in bronze including the figures of Apollo and Athena, several Attic heroes, and Miltiades the general. On the Acropolis of Athens he set up a colossal bronze image of Athena, which was visible far out at sea. At Pellene in Achaia, and at Plataea he made two other statues of Athena, also a statue of Aphrodite in ivory and gold for the people of Elis. But among the Greeks themselves the two works of Pheidias which far outshone all others, and were the basis of his fame, were the colossal figures in gold and ivory of Zeus at Olympia and of Athena Parthenos at Athens, both of which belong to about the middle of the 5th century. Of the Zeus we have unfortunately lost all trace save small copies on coins of Elis, which give us but a general notion of the pose, and the character of the head. The god was seated on a throne, every part of which was used as a ground for sculptural decoration. His body was of ivory, his robe of gold. His head was of somewhat archaic type; the Otricoli mask which used to be regarded as a copy of the head of the Olympian statue is certainly more than a century later in style. Of the Athena Parthenos two small copies in marble have been found at Athens (see GREEK ART, fig. 38) which have no excellence of workmanship, but have a certain evidential value as to the treatment of their original.

It will be seen how very small is our actual knowledge of the works of Pheidias. There are many stately figures in the Roman and other museums which clearly belong to the same school as the Parthenos; but they are copies of the Roman age, and not to be trusted in point of style. A. Furtwängler proposes to find in a statue of which the head is at Bologna, and the body at Dresden, a copy of the Lemnian Athena of Pheidias; but his arguments (*Masterpieces*, at the beginning) are anything but conclusive. Much more satisfactory as evidence are some 5th century torsos of Athena found at Athens. The very fine torso of Athena in the Ecole des Beaux Arts at Paris, which has unfortunately lost its head, may perhaps best serve to help our imagination in reconstructing a Pheidian original.

As regards the decorative sculptures of the Parthenon, which the Greeks rated far below their colossus in ivory and gold, see the article PARTHENON.

Ancient critics take a very high view of the merits of Pheidias. What they especially praise is the ethos or permanent moral level of his works as compared with those of the later "pathetic" school. Demetrius calls his statues sublime, and at the same time precise. "That he rode on the crest of a splendid wave of art is not to be questioned; but it is to be regretted that we have no morsel of work extant for which we can definitely hold him responsible." (P. G.)

PHEIDON (8th or 7th century B.C.), king of Argos, generally, though wrongly, called "tyrant." According to tradition he flourished during the first half of the 8th century B.C. He was a vigorous and energetic ruler and greatly increased the power of Argos. He gradually regained sway over the various cities of the Argive confederacy, the members of which had become practically independent, and (in the words of Ephorus) "reunited the broken fragments of the inheritance of Temenus." His object was to secure predominance for Argos in the north of Peloponnesus. According to Plutarch, he attempted to break the power of Corinth, by requesting the Corinthians to send him 1000 of their picked youths, ostensibly to aid him in

war, his real intention being to put them to death; but the plot was revealed. Pheidon assisted the Pisatans to expel the Eleian superintendents of the Olympian games and presided at the festival himself. The Eleians, however, refused to recognize the Olympiad or to include it in the register, and shortly afterwards, with the aid of the Spartans, who are said to have looked upon Pheidon as having ousted them from the headship of Greece, defeated Pheidon and were reinstated in the possession of Pisatis and their former privileges. Pheidon is said to have lost his life in a faction fight at Corinth, where the monarchy had recently been overthrown. The affair of the games has an important bearing on his date. Pausanias (vi. 22, 2) definitely states that Pheidon presided at the festival in the 8th Olympiad (i.e. in 748 B.C.), but in the list of the suitors of Agariste, daughter of Cleisthenes of Sicyon, given by Herodotus, there occurs the name of Leocedes (Lacedas), son of Pheidon of Argos. According to this, Pheidon must have flourished during the early part of the 6th century. It has therefore been assumed that Herodotus confused two Pheidons, both kings of Argos. The suggested substitution in the text of Pausanias of the 28th for the 8th Olympiad (i.e. 668 instead of 748) would not bring it into agreement with Herodotus, for even then Pheidon's son could not have been a suitor in 570 for the hand of Agariste. But the story of Agariste's wooing resembles romance and has slight chronological value. On the whole, modern authorities assign Pheidon to the first half of the 7th century. Herodotus further states that Pheidon established a system of weights and measures throughout Peloponnesus, to which Ephorus and the Parian Chronicle add that he was the first to coin silver money, and that his mint was at Aegina. But according to the better authority of Herodotus (i. 94) and Xenophanes of Colophon, the Lydians were the first coiners of money at the beginning of the 7th century, and, further, the oldest known Aeginetan coins are of later date than Pheidon. Hence, unless a later Pheidon is assumed, the statement of Ephorus must be considered unhistorical. No such difficulty occurs in regard to the weights and measures; it is generally agreed that a system was already in existence in the time of Pheidon, into which he introduced certain changes. A passage in the Aristotelian *Constitution of Athens* (x. 2) states that the measures used before the Solonian period of reform were called "Pheidonian."

See Herodotus vi. 127; Ephorus in Strabo viii. 358, 376; Plutarch, *Amatoriae narrationes*, 2; Marmor parium, ep. 30; Pollux ix. 83; Nicolaus Damascenus, frag. 41 (in C. W. Müller's *Frag. hist. graecorum*, iii.); G. Grote, *History of Greece*, pt. ii. ch. 4; B. V. Head, *Historia Numorum* (1887); F. Hultsch, *Griechische und römische Metrologie* (1882); G. Rawlinson's *Herodotus*, appendix, bk. i., note 8. On the question of Pheidon's date, see J. B. Bury, *History of Greece*, ii. 468 (1902); J. P. Mahaffy, *Problems in Greek History*, ch. 3 (1892); J. C. Frazer's note on Pausanias vi. 22, 2; and especially G. Busolt, *Griechische Geschichte* (2nd ed., 1893), ch. iii. 12. C. Trierer, *Pheidon von Argos* (Hanover, 1886), and J. Rebeck, in *Rheinisches Museum*, xiv. 595 (1890), favour a later date, about 580.

PHELPS, AUSTIN (1820-1890), American Congregational minister and educationalist, was born on the 7th of January 1820 at West Brookfield, Massachusetts, son of Eliakim Phelps, a clergyman, who, during the boyhood of his son was principal of a girls' school in Pittsfield, Massachusetts, and later pastor of a Presbyterian church in Geneva, New York. The son studied at Hobart College in 1833-1835, then at Amherst for a year, and in 1837 graduated at the university of Pennsylvania. He studied theology at Union Theological Seminary, at the Yale Divinity School, and at Andover, and was licensed to preach in 1840 by the Third Presbytery of Philadelphia. He was pastor of the Pine Street (Congregational) Church in Boston in 1842-1848, and in 1848-1879 was professor of sacred rhetoric and homiletics at Andover Theological Seminary, of which he was president from 1869 to 1879, when his failing health forced him to resign. He died on the 13th of October 1890 at Bar Harbor, Maine. His *Theory of Preaching* (1881) and *English*

¹ Eliakim Phelps afterwards lived in Stratford, Merkimar county, New York, where his house was "possessed" and was long a place of curious interest to students of "spiritualism."

Style in Public Discourse (1883) became standard textbooks; and personally he was a brilliant preacher. He married in 1842 Elizabeth Stuart (1815-1852), eldest daughter of Moses Stuart, then president of Andover; she was the author of the popular story *Sunnyside* (1851) and of other books. In 1854 he married her sister, who died only eighteen months later; and in 1858 he married Mary A. Johnson, of Boston.

With Professors E. A. Park and D. L. Furber he edited *Hymns and Chants* (1860), and with Professor Park and Lowell Mason *The Sabbath Hymn Book* (1859). *The Still Hour* (1859), a summary of a series of sermons on prayer, is a devotional classic. His other works are: *The New Birth* (1867), portraying conversion (in some instances) as a gradual change; *Sabbath Hours* (1874); *Studies of the Old Testament* (1878); *Men and Books* (1882); *My Portfolio* (1882); *My Study* (1885); and *My Note Book* (1890).

See *Autism Phelps: A Memoir* (New York, 1891), by his daughter, Elizabeth Stuart Phelps-Ward.

PHELPS, EDWARD JOHN (1822-1900), American lawyer and diplomat, was born on the 11th of July 1822 at Middlebury, Vermont. He graduated from Middlebury College in 1840, was a schoolmaster for a year in Virginia, and was admitted to the bar in 1843. He began practice at Middlebury, but in 1845 removed to Burlington, Vermont. From 1851 to 1853 he was second comptroller of the United States Treasury, and then practised law in New York City until 1857, when he returned to Burlington. Becoming a Democrat after the Whig party had ceased to exist, he was debarred from a political career in his own state, where his party was in the minority, but he served in the state constitutional convention in 1870, and in 1880 was the Democratic candidate for governor of his state. He was one of the founders of the American Bar Association, and was its president in 1880-1881. From 1881 until his death he was Kent Professor of Law in Yale University. He was minister to Great Britain from 1885 to 1889, and in 1893 served as senior counsel for the United States before the international tribunal at Paris to adjust the Bering Sea controversy. His closing argument, requiring eleven days for its delivery, was an exhaustive review of the case. Phelps lectured on medical jurisprudence at the university of Vermont in 1881-1883, and on constitutional law at Boston University in 1882-1883, and delivered numerous addresses, among them that on "The United States Supreme Court and the Sovereignty of the People" at the centennial celebration of the Federal Judiciary in 1890 and an oration at the dedication of the Bennington Battle Monument, unveiled in 1891 at the centennial of Vermont's admission to the Union. In politics Phelps was always Conservative, opposing the anti-slavery movement before 1860, the free-silver movement in 1896, when he supported the Republican presidential ticket, and after 1898 becoming an ardent "anti-expansionist." He died at New Haven, Connecticut, on the 9th of March 1900.

See the *Orations and Essays of Edward John Phelps*, edited by J. G. McCullough, with a *Memoir* by John W. Stewart (New York, 1901); and "Life and Public Services of the Hon. Edward J. Phelps," by Matthew H. Buckham, in *Proceedings of the Vermont Historical Society* (Burlington, Vt., 1901).

PHELPS, SAMUEL (1804-1878), English actor and manager, was born at Devonport on the 13th of February 1804. He was early thrown upon his own resources, and worked in various newspaper offices. Shortly after his marriage in 1826 to Sarah Cooper (d. 1867), he accepted a theatrical engagement in the York circuit at eighteen shillings a week, and afterwards appeared in south of England towns in prominent tragic rôles, attracting sufficient attention to be spoken of as a rival to Kean. He made his first London appearance on the 28th of August 1837 as Shylock at the Haymarket. After a short season there he was with Macready for about six years at Covent Garden, the Haymarket and Drury Lane successively. In 1844 he became co-lessee of Sadler's Wells Theatre with Thomas L. Greenwood and Mrs Mary Amelia Warner (1804-1854). Greenwood supplied the business capacity, Phelps was the theatrical manager, and Mrs Warner leading lady. In this position Phelps remained for twenty years, during which time he raised the Sadler's Wells house to an important position,

and himself appeared in a very extensive and varied repertory. Thirty-four of Shakespeare's plays were presented there under his direction, with great educational effect, both on public and players. In 1861 Greenwood retired from the partnership, and Phelps, unable to cope with the business of management, retired from it in the following year. For the next fifteen years he acted under various managements, achieving considerable success in some of Halliday's dramatic versions of Scott's novels, such as *The Fortunes of Nigel* and *Ivanhoe*. His last appearance was in 1878 as Wolsey in *Henry VIII.*, and he died on the 6th of November 1878. He was a sound and capable actor, rather than one of any marked genius; and, in spite of his predilection for tragedy, was most successful in such characters of comedy as called for dry humour. Perhaps Sir Pertinax Maccyphanth in Charles Macklin's *The Man of the World* was his finest impersonation. He published an annotated edition of Shakespeare's plays (2 vols., 1852-1854).

PHELYPEAUX, a French family of Blésois. Its two principal branches were those of the seigneurs of Herbault, La Vrillière and Saint Florentin, and of the counts of Pontchartrain and Maurepas. Raimond Phelypeaux, seigneur of Herbault and La Vrillière (d. 1629), was treasurer of the *Épargne* in 1590, and became secretary of state in 1621. His son Louis succeeded him in this latter office, and died in 1681. Balthazar Phelypeaux, marquis de Châteauneuf (d. 1700), and Louis, marquis de La Vrillière (d. 1725), respectively son and grandson of Louis, were also secretaries of state. Louis Phelypeaux (1705-1777), count of Saint Florentin and afterwards duke of La Vrillière (1770), succeeded his father as secretary of state; became minister of the king's household in 1749, a minister of state in 1751, and discharged the functions of minister of foreign affairs on the disgrace of Choiseul (1770). He incurred great unpopularity by his abuse of *lettres de cachet*, and had to resign in 1775. Raimond Balthazar Phelypeaux, seigneur du Verger, a member of the La Vrillière branch, was sent as ambassador to Savoy in 1700, where he discovered the intrigues of the duke of Savoy, Victor Amadeus II., against France; and when war was declared he was kept a close prisoner by the duke (1703-1704). At the time of his death (1713) he was governor-general in the West Indies. The branch of Pontchartrain-Maurepas was founded by Paul Phelypeaux (1569-1621), brother of the first-mentioned Raimond; he became secretary of state in 1610.

PHENACETIN, $C_9H_9O_2N$, $NHCOCH_3$ (para-acetaminophenol), a drug prepared by acetylating para-phenetidin, or by heating para-acetylaminophenol and potassium ethyl sulphate with alcoholic soda to 150° C. Para-phenetidin is prepared by treating the sodium salt of para-nitrophenol with ethyl iodide, and reducing the nitrophenol to para-phenetidin or aminophenol. The yield may be doubled by diazotizing para-phenetidin, coupling with phenol, ethylating and reducing:

$$EtO \cdot C_6H_4 \cdot NH_2 \rightarrow EtO \cdot C_6H_4 \cdot N_2OH \rightarrow EtO \cdot C_6H_4 \cdot N \cdot C_2H_4 \cdot OH \rightarrow EtO \cdot C_6H_4 \cdot N \cdot C_2H_4 \cdot NH_2$$

It crystallizes from water in colourless plates, melting at 135° C. It is soluble in about 70 parts of hot and in about 1400 parts of cold water.

Several compounds related to phenacetin have been introduced into medicine. Triphenin is propylphenetidin; lactophenin is lacylphenetidin; pyrantin is para-ethoxyphenyl succinimide, $EtO \cdot C_6H_4 \cdot N[CO \cdot CH_2]_2$; salophen or saliphenin is salicylphenetidin; amygdophenin is mandelylphenetidin. In addition, several other derivatives have been suggested which have a greater solubility than phenacetin, e.g. phesin, which is the sodium salt of phenacetin sulphonic acid, apolysin and citrophen (citrophenin), which are citric acid derivatives of para-phenetidin, &c.

Phenacetin is contained in both the British and United States pharmacopoeia, in the latter under the name of acetphenetidin. The dose is 5 to 10 grs. given in cachets or in suspension. When the drug is carelessly made it may contain impurities, producing considerable irritation of the kidneys. The physiological action of phenacetin consists in a sedative action on the sensory tracts of the spinal cord, and a depressant action on the heart, where it

tends to paralyse the action of the cardiac muscle. Upon the bodily heat it exercises a marked effect, decreasing the action of the heat-producing centre as well as increasing the dissipation of heat, and thus causing a marked fall in temperature. In toxic doses the blood becomes dark and blackish from the formation of methaemoglobin, and the urine is changed in colour from the passage of altered blood. The chief therapeutic use of phenacetin is as an antineuralgic, and it is of service in migraine, rheumatism of the sub-acute type, intercostal neuralgia and locomotor ataxia.

PHENACITE, a mineral consisting of beryllium orthosilicate, Be_2SiO_4 , occasionally used as a gem-stone. It occurs as isolated crystals, which are rhombohedral with parallel-faced hemihedrism, and are either lenticular or prismatic in habit: the lenticular habit is determined by the development of faces of several obtuse rhombohedra and the absence of prism faces (the accom-

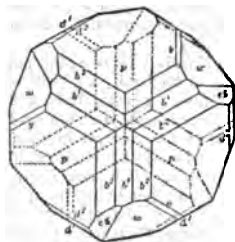

ppanying figure is a plan of such a crystal viewed along the triad, or principal, axis). There is no cleavage, and the fracture is conchoidal. The hardness is high, being 7½–8; the specific gravity is 2.98. The crystals are sometimes perfectly colourless and transparent, but more often they are greyish or yellowish and only translucent; occasionally they are pale rose-red. In general appearance the mineral is not unlike quartz, for which

indeed it had been mistaken; on this account it was named, by N. Nordenskiöld in 1833, from Gr. φήμαξ (a deceiver).

Phenacite has long been known from the emerald and chrysoberyl mine on the Takovaya stream, near Ekaterinburg in the Urals, where large crystals occur in mica-schist. It is also found with topaz and amazon-stone in the granite of the Ilmen mountains in the southern Urals and of the Pike's Peak region in Colorado. Large crystals of prismatic habit have more recently been found in a felspar quarry at Kragerø in Norway. Framont near Schirmeck in Alsace is another well-known locality. Still larger crystals, measuring 12 in. in diameter and weighing 28 lb, have been found at Greenwood in Maine, but these are pseudomorphs of quartz after phenacite.

For gem purposes the stone is cut in the brilliant form, of which there are two fine examples, weighing 43 and 34 carats, in the British Museum. The indices of refraction ($\omega = 1.6540$, $\epsilon = 1.6527$) are higher than those of quartz, beryl or topaz; a faceted phenacite is consequently rather brilliant and may sometimes be mistaken for diamond. (L. J. S.)

PHENACODUS, one of the earliest and most primitive of the ungulate mammals, typifying the family *Phenacodontidae* and the sub-order Condylarthra. The typical *Phenacodus primaevus*, of the Lower or Wasatch Eocene of North America, was a relatively small ungulate, of slight build, with straight limbs each terminating in five complete toes, and walking in the digitigrade fashion of the modern tapir. The middle toe was the largest, and the weight of the body was mainly supported on this and the two adjoining digits, which appear to have been encased in hoofs, thus foreshadowing the tridactyle type common in perissodactyle and certain extinct groups of ungulates. The skull was small, with proportionately minute brain; and the arched back, strong lumbar vertebrae, long and powerful tail, and comparatively feeble fore-quarters all proclaim kinship with the primitive creodont Carnivora (see CREODONTA), from which *Phenacodus* and its allies, and through them the more typical Ungulata, are probably derived. All the bones of the limbs are separate, and those of the carpus and tarsus do not alternate; that is to say, each one in the upper row is placed immediately above the corresponding one in the row below. The full series of forty-four teeth was developed; and the upper molars were short-crowned, or brachydont, with six low cones, two internal, two intermediate and two external, so that they were of the typical primitive bunodont structure. In habits the animal was cursorial and herbivorous, or possibly carnivorous.

In the Puerco, or Lowest Eocene of North America the place of the above species was taken by *Euprotogonia purcensis*, an animal only half the size of *Phenacodus primaevus*, with the terminal joints of the limbs intermediate between hoofs and claws, and the first and fifth toes taking their full share in the support of the weight of the body. These two genera may be regarded as forming the earliest stages in the evolution of the horse, coming below *Hyracotherium* (see EQUIDAE).

As ancestors of the Artiodactyle section of the Ungulata, we may look to forms more or less closely related to the North American Lower Eocene genera *Mioclaenus* and *Pantolestes*, respectively typifying the families *Mioclaenidae* and *Pantolestidae*. They were five-toed, bunodont Condylarthra, with a decided approximation to the perissodactyle type in the structure of the feet. A third type of Condylarthra from the North American Lower Eocene is represented by the family *Meniscotheriidae*, including the genera *Meniscotherium* and *Hyracops*. These, it is suggested, may have been related to the ancestral Hyracoidea. Teeth and jaws probably referable to the Condylarthra have been obtained in European early Tertiary formations. All Ungulata probably originated from Condylarthra.

See H. F. Osborn, *Skeleton of Phenacodus primaevus*; comparison with *Euprotogonia*, Bull. Amer. Mus. x. 159. (R. L.')

PHENANTHRENE, $\text{C}_{14}\text{H}_{10}$, a hydrocarbon isomeric with anthracene, with which it occurs in the fraction of the coal tar distillate boiling between 270°–400° C. It may be separated from the anthracene oil by repeated fractional distillation, followed by fractional crystallization from alcohol (anthracene being the less soluble), and finally purified by oxidizing any residual anthracene with potassium bichromate and sulphuric acid (R. Anschutz and G. Schultz, *Ann.*, 1879, 196, p. 35); or the two hydrocarbons may be separated by carbon bisulphide, in which anthracene is insoluble. It is formed when the vapours of toluene, stilbene, dibenzyl, ortho-ditolyl, or coumarone and benzene are passed through a red-hot tube; by distilling morphine with zinc dust, and with anthracene, by the action of sodium on ortho-brombenzyl bromide (C. L. Jackson and J. F. White, *Amer. Chem. Jour.*, 1880, 2, p. 391). It crystallizes in colourless plates or needles, which melt at 99° C. Its solutions in alcohol and ether have a faint blue fluorescence. When heated to 250° C. with red phosphorus and hydriodic acid it gives a hydride C_{14}H_8 . It is nitrated by nitric acid and sulphated by sulphuric acid. With picric acid it forms a sparingly soluble picrate, which melts at 145° C. On the condition of phenanthrene in alcoholic solution see R. Behrend, *Zeit. phys. Chem.*, 1892, 9, p. 405; 10, p. 265. Chromic acid oxidizes phenanthrene, first to phenanthrene-quinone, and then to diphenic acid, $\text{HO}_2\text{C}\cdot\text{C}_6\text{H}_4\cdot\text{C}_6\text{H}_4\cdot\text{CO}_2\text{H}$.

Phenanthrene quinone, $[\text{C}_6\text{H}_4]_2[\text{CO}]_2$, crystallizes in orange needles which melt at 198° C. It possesses the characteristic properties of a diketone, forming crystalline derivatives with sodium bisulphite and a dioxide with hydroxylamine. It is non-volatile in steam, and is odourless. Sulphurous acid reduces it to the corresponding dihydroxy compound. It combines with ortho-diamines, in the presence of acetic acid, to form *phenazines*.

On the constitution of phenanthrene see CHEMISTRY: § Organic.

PHENAZINE (Azophenylene), $\text{C}_{12}\text{H}_{10}\text{N}_2$, in organic chemistry, the parent substance of many dyestuffs, e.g. the erubodines, toluylene red, indulines and safranines. It is a dibenzoparadiazine having the formula given below. It may be obtained by distilling barium azobenzoate (A. Claus, *Ber.*, 1873, 6, p. 723); by passing aniline vapour over lead oxide, or by the oxidation of dihydrophenazine, which is prepared by heating pyrocatechin with orthophenylene diamine (C. Ris, *Ber.*, 1886, 19, p. 2206). It is also formed when ortho-aminodiphenylamine is distilled over lead peroxide (O. Fischer and E. Hepp). It crystallizes in yellow needles which melt at 171° C., and are only sparingly soluble in alcohol. Sulphuric acid dissolves it, forming a deep-red solution. The more complex phenazines, such as the naphthophenazines, naphthazines and naphtholazines, may be prepared by condensing ortho-diamines with ortho-quinones (O. Hinsberg, *Ann.*, 1887, 237, p. 340); by the oxidation of an ortho-diamine in the presence of a naphthol (O. Witt), and by

the decomposition of ortho-anilido-(toluidido- &c.)-azo compounds with dilute acids. If alkyl or aryl-ortho-diamines be used azonium bases are obtained. The azines are mostly yellow in colour, distil unchanged and are stable to oxidants. They add on alkyl iodides readily, forming alkyl azonium salts.

By the entrance of amino or hydroxyl groups into the molecule dyestuffs are formed. The mono-amino derivatives or *eurohodines* are obtained when the arylmonamines are condensed with ortho-amino-zo compounds; by condensing quinone dichlorimide or para-nitrosodimethyl aniline with monamines containing a free para position, or by oxidizing ortho-hydroxydiaminodiphenylamines (R. Nietzki, *Ber.*, 1895, 28, p. 2976; O. Fischer, *ibid.*, 1896, 29, p. 1874). They are yellowish-red solids, which behave as weak bases, their salts undergoing hydrolytic dissociation in aqueous solution. When heated with concentrated hydrochloric acid the amino group is replaced by the hydroxyl group and the phenolic *eurohodols* are produced.

The symmetrical diaminophenazine is the parent substance of the important dyestuff toluylene red or dimethylaminotoluphenazine. It is obtained by the oxidation of orthophenylene diamine with ferric chloride; when a mixture of para-aminodimethylaniline and meta-toluylenediamine is oxidized in the cold, toluylene blue, an indamine, being formed as an intermediate product and passing into the red when boiled; and also by the oxidation of dimethyl-paraphenylene diamine with metatoluylene diamine. It crystallizes in orange-red needles and its alcoholic solution fluoresces strongly. It dyes silk and mordanted cotton a fine scarlet. It is known commercially as *neutral red*. For the phenazonium salts see SAFRANINE.

Phenazone is an isomer of phenazine, to which it bears the same relation that phenanthrene bears to anthracene. It is formed by reducing diortho-dinitrodiphenyl with sodium amalgam and methyl alcohol, or by heating diphenyl-ortho-dihydrazine with hydrochloric acid to 150° C. It crystallizes in needles which melt at 156° C. Potassium permanganate oxidizes it to pyridazine tetracarboxylic acid.

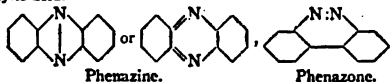

PHENOLPHTHALEIN, in organic chemistry, a compound derived from phthalophenone, or diphenyl phthalide (formula I.), the anhydride of triphenyl-carbinol-ortho-carboxylic acid, which is obtained by condensing phthalyl chloride with benzene in the presence of aluminium chloride. The phthaleins are formed from this anhydride by the entrance of hydroxyl or amino groups into the two phenyl residues, and are prepared by condensing phenols with phthalic anhydride, phenol itself giving rise to phenolphthalein (formula II.) together with a small quantity of fluorene (formula III.), whilst resorcin under similar conditions yields fluorescein (*q.v.*). The phthaleins on reduction yield phthalines, which are derivatives of triphenylmethane carboxylic acid; these reduction products are colourless and may be regarded as the leuco-compounds of the phthaleins, thus phenolphthalein itself gives phenolphthaline (formula IV.). Dehydrating agents usually convert the phenolphthalines into anthraquinone derivatives.

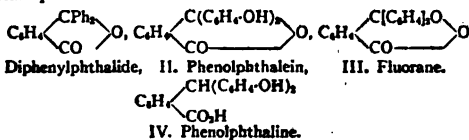

Phenolphthalein is obtained when phenol and phthalic anhydride are heated with concentrated sulphuric acid. It crystallizes in colourless crusts and is nearly insoluble in water, but dissolves in dilute solutions of the caustic alkalis with a fine red colour, being reprecipitated from these solutions by the addition of mineral acid. It dissolves in concentrated caustic alkalis to a colourless solution which probably contains salts of a non-quinonoid character. This difference in behaviour has led to considerable discussion (see H. Meyer, *Momats.*, 1899, 20, p. 337; R. Meyer, *Ber.*, 1903, 36, p. 2949; A. G. Perkin and Green, *Jour. Chem. Soc.*, 1904, p. 398). On fusion with caustic alkali, phenolphthalein yields benzoic acid and para-dihydroxybenzophenone, which shows that in the original condensation the phthalic acid residue has taken the para position to the hydroxyl groups of the phenol.

Fluorene is a product of the condensation of the phthalic acid residue in the ortho position to the hydroxyl groups of the phenol,

anhydride formation also taking place between these hydroxyl groups. It dissolves in concentrated sulphuric acid with a yellowish-green fluorescence. The rhodamines, which are closely related to the phthaleins, are formed by the condensation of the alkyl meta-aminophenols with phthalic anhydride in the presence of sulphuric acid. Their salts are fine red dyes.

PHENOMENON (Gr. φαινόμενον, a thing seen, from φαίνεσθαι, to appear), in ordinary language a thing, process, event, &c., observed by the senses. Thus the rising of the sun, a thunder-storm, an earthquake are natural "phenomena." From this springs the incorrect colloquial sense, something out of the common, an event which especially strikes the attention; hence such phrases as "phenomenal" activity. In Greek philosophy phenomena are the changing objects of the senses as opposed to essences (τὰ ἄρρα) which are one and permanent, and are therefore regarded as being more real, the objects of reason rather than of senses which are "bad witnesses." In modern philosophy the phenomenon is neither the "thing-in-itself," nor the noumenon (*q.v.*) or object of pure thought, but the thing-in-itself as it appears to the mind in sensation (see especially KANT; and METAPHYSICS). In this sense the subjective character is of prime importance. Among derivative terms are "Phenomenalism" and "Phenomenology." Phenomenalism is either (1) the doctrine that there can be no knowledge except by phenomena, *i.e.* sense-given data, or (2) the doctrine that all known things are phenomena, *i.e.* that there are no "things-in-themselves." "Phenomenology" is the science of phenomena: every special science has a special section in which its particular phenomena are described. The term was first used in English in the 3rd edition of the *Ency. Brit.* in the article "Philosophy" by J. Robison. Kant has a special use of the term for that part of the *Metaphysic of Nature* which considers motion and rest as predicates of a judgment about things.

HERECRATES, Greek poet of the Old Attic Comedy, was a contemporary of Cratinus, Crates and Aristophanes. At first an actor, he seems to have gained a prize for a play in 438 B.C. The only other ascertained date in his life is 420, when he produced his play *The Wild Men*. Like Crates, whom he imitated, he abandoned personal satire for more general themes, although in some of the fragments of his plays we find him attacking Alcibiades and others. He was especially famed for his inventive imagination, and the elegance and purity of his diction are attested by the epithet ἀπυκτώτατος (most Attic) applied to him by Athenaeus and the sophist Phrynichus. He was the inventor of a new metre, called after him Pherocratean, which frequently occurs in the choruses of Greek tragedies and in Horace.

A considerable number of fragments from his 16 (or 13) plays has been preserved, collected in T. Kock, *Comicorum Atticorum Fragmenta*, i. (1880), and A. Meineke, *Poetarum Comicorum Graecorum Fragmenta* (1855).

HERECYDES OF LEROS, Greek mythographer, *f. c.* 454 B.C. He is probably identical with Phercydes of Athens, although the two are distinguished by Suidas (also by I. Lipsius, *Quaestiones Iogographicae*, 1886). He seems to have been born in the Island of Leros, and to have been called an Athenian because he spent the greater part of his life and wrote his great work there. Of his treatises, *On Leros*, *On Iphigénia*, *On the Festivals of Dionysus*, nothing remains; but numerous fragments of his genealogies of the gods and heroes, variously called *Ἱστορίαι*, *Γενεαλογίαι*, *Ἀποροβίαι*, in ten books, written in the Ionic dialect, have been preserved (see C. W. Müller's *Frag. hist. graec.*, vol. i. pp. xxxiv., 70). He modified the legends, not with a view to rationalizing them, but rather to adjust them to popular beliefs. He cannot, therefore, be classed with Hecataeus, whose method was far more scientific.

See C. Lütke, *Phercydes* (diss. Göttingen, 1893); W. Christ, *Geschichte der griechischen Literatur* (1898); and especially H. Bertach, *Pherocydische Studien* (1898).

HERECYDES OF SYROS, Greek philosopher (or rather philosophical theologian), flourished during the 6th century B.C. He was sometimes reckoned one of the Seven Wise Men, and is said to have been the teacher of Pythagoras. With the possible

exception of Cadmus (*q.v.*) of Miletus, he was the first Greek prose-writer. He belonged to the circle of Peisistratus at Athens, and was the founder of an Orphic community. He is characterized as "one of the earliest representatives of a half-critical, half-credulous eclecticism" (Gomperz). He was credited with having originated the doctrine of metempsychosis (*q.v.*), while Cicero and Augustine assert that he was the first to teach the immortality of the soul. Of his astronomical studies he left a proof in the "heliotropion," a cave at Syros which served to determine the annual turning-point of the sun, like the grotto of Posillipo (Posilipo, Posillipo) at Naples, and was one of the sights of the island.

In his cosmogonic treatise on nature and the gods, called *Περὶ μύχως* (Preller's correction of Suidas, who has *ἐρράμυχως*) from the five elementary or original principles (aether, fire, air, water, earth; Gomperz substitutes smoke and darkness for aether and earth), he enunciated a system in which science, allegory and mythology were blended. In the beginning were Chronos, the principle of time; Zeus (*Zas*), the principle of life; and Chthonië, the earth goddess. Chronos begat fire, air and water, and from these three sprang numerous other gods. Smoke and darkness appear in a later tradition. A fragment of the "sacred marriage" of *Zas* and Chthonië was found on an Egyptian papyrus at the end of the 19th century.

See H. Diels, *Fragments der Vorsokratiker* (1903); also O. Kern, *De Orphei, Epimenidis, Pherecydis theogonias* (1888); D. Spieliotopoulos, *Περὶ Θεοποιῶν τοῦ Σπύλου* (Athens, 1890); T. Gomperz, *Greek Thinkers* (Eng. trans.), i. 85; B. P. Grenfell, *New Classical Fragments* (1897); H. Weil, *Études sur l'antiquité grecque* (1900).

PHIGALIA, or **PHIGALEIA** (Φιγαλία or Φιγαλεία; mod. *Pavítsa*), an ancient Greek city in the south-west angle of Arcadia, situated on an elevated rocky site, among some of the highest mountains in the Peloponnesus—the most conspicuous being Mt Cotylium and Mt Elasum; the identification of the latter is uncertain.

In 659 B.C. Phigalia was taken by the Lacedaemonians, but soon after recovered its independence by the help of the Orasthians. During the struggle between Achaeans and Aetolians in 221 B.C. it was held by Dorimachus, who left it on the approach of Philip V. of Macedon. In common with the other cities of Arcadia, it appears from Strabo to have fallen into utter decay under the Roman rule. Several curious cults were preserved near Phigalia, including that of the fish-tailed goddess Eurynome and the Black Demeter with a horse's head, whose image was renewed by Onatas. Notices of it in Greek history are rare and scanty. Though its existing ruins and the description of Pausanias show it to have been a place of considerable strength and importance, no autonomous coins of Phigalia are known. Nothing remains above ground of the temples of Artemis or Dionysus and the numerous statues and other works of art which existed at the time of Pausanias's visit, about A.D. 170. A great part of the city wall, built in fine Hellenic masonry, partly polygonal and partly isodomous, and a large square central fortress with a circular projecting tower, are the only remains now traceable—at least without the aid of excavation. The walls, once nearly 2 m. in circuit, are strongly placed on rocks, which slope down to the little river Neda.

One very important monument still exists in a fairly perfect state; this is a temple dedicated to Apollo Epicurius (the Preserver), built, not at Phigalia itself, but at Bassae, 5 or 6 m. away, on the slope of Mt Cotylium; it commemorates the aid rendered by Apollo in stopping a plague which in the 5th century B.C. was devastating Phigalia. This temple is mentioned by Pausanias (viii. 41) as being (next to that of Tegea) the finest in the Peloponnesus, "from the beauty of its stone and the symmetry of its proportions." It was designed by Ictinus, who, with Callicrates, was joint architect of the Parthenon at Athens. Though visited by Chandler, Dodwell, Gell, and other English travellers, the temple was neither explored nor measured till 1811-1812, when C. R. Cockerell and some other archaeologists spent several months in making excavations there. After nearly fifty years' delay, Professor Cockerell published the results of these labours, as well as of his previous work at Aegina, in *Temples of Aegina and Bassae* (1866), one of the most careful

and beautifully illustrated archaeological works produced. The labours of Cockerell and his companions were richly rewarded; not only were sufficient remains of the architectural features discovered to show clearly the whole design, but the internal sculptured frieze of the cella was found almost perfect. This and other fragments of its sculpture are now in the British Museum. The colonnade of the temple has been recently restored by the Greek authorities.

The figure shows the plan of the temple, which is of the Doric order, but has an internal arrangement of its cella unlike that of any other known temple. It stands on an elevated and partly artificial plateau, which commands an extensive view of the oak-clad mountains of Arcadia, reaching away to the blue waters of the Messenian Gulf. Unlike other Doric temples, which usually stand east and west, this is placed north and south; but it has a side entrance on the east. It is hexastyle, with fifteen columns on its flanks; thirty-four out of the thirty-eight columns of the peristyle are still standing, with the greater part of their architrave, but the rest of the entablature and both pediments have fallen, together with the greater part of the internal columns of the cella. It will be seen from the plan that these are very strangely placed, apparently without symmetry, as regards the interior, though they are set regularly opposite the voids in the peristyle.

With the exception of one at the south end, which is Corinthian, the internal columns are of the Ionic order, and are engaged with the cella-wall, forming a series of recesses, which may have been designed to contain statues. Another peculiarity of this interior is that these columns reach to the top of the cella in one order, not in two ranges of columns, one over the other, as was the usual Doric fashion. These inner columns carried an Ionic entablature, of which the frieze now in the British Museum formed a

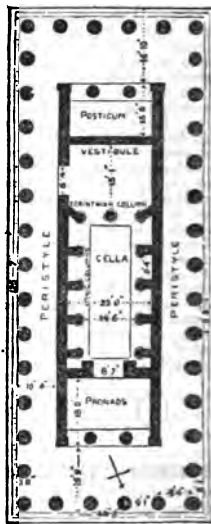

Plan of the Temple at Bassae.

part. The pediments and external metopes of the peristyle appear to have contained no sculpture, but the metopes within the peristyle on the exterior of the cella had sculptured subjects; only a few fragments of these were, however, discovered. The position occupied by the great statue of Apollo is a difficult problem. Cockerell, with much probability, places it in the southern portion of the cella, facing the eastern side door, so that it would be lighted up by the rays of the rising sun. The main entrance is at the northern end through the pronaos, once defended by a door in the end of the cella and a metal screen, of which traces were found on the two columns of the pronaos. There was no door between the posticum and the cella. The general proportions of the fronts resemble those of the *Thesaurus* at Athens, except that the entablature is less massive, the columns thicker, and the diminution less—all proportionally speaking. In plan the temple is long in proportion to its width—measuring, on the top of the stylobate, 125 ft. 7 in. by 48 ft. 2 in., while the *Thesaurus* (built probably half a century earlier) is about 104 ft. 2 in. by 45 ft. 2 in.

The material of which the temple is built is a fine grey limestone (once covered with painted stucco), except the roof-tiles, the capitals of the cella columns, the architraves, the *lacunaria* (ceilings) of the posticum and pronaos, and the sculpture, all of which are of white marble. The roof-tiles, specially noticed by Pausanias, are remarkable for their size, workmanship, and the beauty of the Parian marble of which they are made. They measure 2 ft. 1 in. by 3 ft. 6 in., and are fitted together in the most careful and ingenious manner. Unlike those of the Parthenon and the temple of Aegina, the *ἀροῖ* or "joint-tiles" are worked out of the same piece of marble as the flat ones, for the sake of more perfect fitting and greater security against wet.

Traces of painting on various architectural members were found by Cockerell, but they were too much faded for the colours to be distinguished. The designs are the usual Greek patterns—the fret, the honeysuckle, and the egg and dart.

The sculpture is of the greatest interest, as being designed to decorate one of the finest buildings in the Peloponnesus in the latter half of the 5th century B.C.; see *Brit. Mus. Catalogue of Sculpture*, vol. i. The frieze, now in the British Museum, is complete; it is nearly 101 ft. long by 2 ft. high, carved in relief on twenty-three slabs of marble 4½ to 5 in. thick. The subjects are the battle of the Lapithae and the Centaurs, and that between the Amazons and the Greeks, the

two favourite subjects in Greek plastic art of the best period. They are designed with wonderful fertility of invention, and life-like realism and spirit; the composition is arranged so as to form a series of diagonal lines or zigzags λ , thus forming a pleasing contrast to the unbroken horizontal lines of the cornice and architrave. The various groups are skillfully united together by some dominant line or action, so that the whole subject forms one unbroken composition.

The relief is very high, more than 3½ in. in the most salient parts, and the whole treatment is quite opposite to that of the Parthenon frieze, which is a very superior work of art to that at Bassae. Many of the limbs are quite detached from the ground; the drill has been largely used to emphasize certain shadows, and in many places, for want of due calculation, the sculptor has had to cut into the flat background behind the figures. From this it would appear that no finished clay-model was prepared, but that the relief was sculptured with only the help of a drawing. The point of sight, more than 20 ft. below the bottom of the frieze, and the direction in which the light fell on it have evidently been carefully considered. Many parts, invisible from below, are left comparatively rough. The workmanship throughout is unequal, and the hands of several sculptors can be detected. On the whole, the execution is not equal to the beauty of the design, and the whole frieze is somewhat marred by an evident desire to produce the maximum of effect with the least possible amount of labour—very different from the almost gem-like finish of the Parthenon frieze. Even the design is inferior to the Athenian one; most of the figures are ungracefully short in their proportions, and there is a great want of refined beauty in many of the female hands and faces. It is in the fire of its varied action and its subtlety of expression that this sculpture most excels. The noble movements of the heroic Greeks form a striking contrast to the feminine weakness of the wounded Amazons, or the struggles with teeth and hoofs of the brutish Centaurs; the group of Apollo and Artemis in their chariot is full of grace and dignified power. The marble in which this frieze is sculptured is somewhat coarse and crystalline; the slabs appear not to have been built into their place but fixed afterwards, with the aid of two bronze bolts driven through the face of each.

Of the metopes, which were 2 ft. 8 in. square, only one exists nearly complete, with eleven fragments; the one almost perfect has a relief of a nude warrior, with floating drapery, overcoming a long-haired bearded man, who sinks vanquished at his feet. The relief of these is rather less than that of the frieze figures, and the work is nobler in character and superior in execution.

In addition to the works mentioned in the text, see Leake, *Morea* (i. 490 and ii. 319; Curtius, *Peloponnesos*. i. 319; Ross, *Reisen in Peloponnesos*; Stackelberg, *Der Apollo-Tempel zu Bassae* (1826); Lenormant, *Bas-reliefs du Parthenon et de Phigalie* (1834); and *Histories of Sculpture* mentioned under GREEK ART.

(J. H. M.; E. Gr.)

PHILADELPHIA, the Greek name (1) of a city in Palestine in the land of Ammon (see AMMONITES), and (2) of a city so-called in honour of Attalus II. of Pergamum, the modern Ala-Shehr (q.v.).

PHILADELPHIA, the third city in population in the United States, the chief city of Pennsylvania, and a port of entry, co-extensive with Philadelphia county, extending W. from the Delaware river beyond the Schuylkill River, and from below the confluence of the Delaware and Schuylkill rivers N.E. about 23 m. along the Delaware river and Poquessing Creek. Independence Hall, which is a few squares east by south of the city hall, is in 39° 56' 57" N. and 75° 8' 54" 75" W. The port is about 102 m. from the Atlantic Ocean, and the city hall is 90 m. by rail S.S.W. of New York and 135 m. N.E. of Washington. The city has an area of 132.7 sq. m. At the southern extremity are lowlands protected by dikes from the tide; the business centre between the rivers is about 40 ft. higher but level; the district west of the Schuylkill is generally rolling; and in the upper district the surface rises from the Delaware toward the north-west until in the extreme north-west is a picturesque district overlooking Wissahickon Creek from hills exceeding 400 ft. in height.

Population.—When the first United States census was taken, in 1790, Philadelphia was the second largest city in the Union, and had a population of 28,522. It held this rank until 1830, when it was exceeded in size by Baltimore as well as by New York. In 1850 it was smaller also than Boston; but in 1854 the Consolidation Act extended its boundaries so as to include all Philadelphia county and in 1860 the city had risen again to second rank. This rank it held until 1890 when, although its population had grown to 1,046,064, it was 50,000 less than that of Chicago. In 1900, with a population of 1,203,679, it

was still farther behind both New York and Chicago. In 1900, of the total population, 998,357, or 77.18%, were native-born, as against only 63% native-born in New York and 65.43% native-born in Chicago. Of Philadelphia's native-born white population, however, 414,093, or 44.24% were of foreign-born parentage. The foreign-born population included 98,427 born in Ireland, 71,319 born in Germany, 36,752 born in England, 28,951 born in Russia (largely Hebrews), 17,830 born in Italy, 8,479 born in Scotland and 5154 born in Austria; and the coloured consisted of 62,613 negroes, 1165 Chinese, 234 Indians and 12 Japanese. In 1910 the population was 1,549,008.

Streets.—With the exception of a limited number of diagonal thoroughfares and of streets laid out in outlying districts in conformity with the natural contour of the ground the plan of the city is regular. Market Street—which Penn called High Street—is the principal thoroughfare east and west, Broad Street the principal thoroughfare north and south, and these streets intersect at right angles at City Hall Square in the business centre. The streets parallel with Broad are numbered from First or Front Street west from the Delaware River to Sixty-Third Street, taking the prefix "North" north of Market Street and the prefix "South" south of it; the streets parallel with Market are named mostly from trees and from the governors and counties of Pennsylvania.

The wholesale district is centred at the east end of Market Street near the Delaware river. The best retail shops are farther west on the south side of Chestnut Street and on Market and Arch streets. Most of the leading banks and trust companies are on Chestnut Street and on Third Street between Chestnut and Walnut streets. Several of the larger office buildings and the stations of the Pennsylvania and the Philadelphia & Reading railways are in the vicinity of the city hall; here too, are the Baldwin Locomotive Works. The large textile mills, the great coal wharves and the Cramp Ship-Yards are to the north-east along the Delaware, and in districts west of these are the leading manufacturing of iron and steel. There are large sugar refineries in the south-eastern part of the city. Rittenhouse Square, a short distance south-west of the city hall, is the centre of the old aristocratic residential district, and the south side of Walnut Street between Fourteenth and Nineteenth streets is a fashionable parade. There are fine residences on North Broad Street and on some of the streets crossing it, and many beautiful villas in the picturesque suburbs of the north-west. The most congested tenements, occupied largely by Italians, Hebrews and negroes, are along the alleys between the rivers and south of Market Street, often in the rear of some of the best of the older residences.

The principal structure is the city hall (or "Public Buildings") one of the largest buildings in the world in ground space (4½ acres). It rises 548 ft. to the top of a colossal bronze statue (37 ft. high) of William Penn (by Alexander Calder) surmounting the tower. It accommodates the state and county courts as well as the municipal and county offices. The foundation stone was laid in August 1872. On its first floor is Joseph A. Bailly's statue of Washington, which was erected in front of Independence Hall in 1869. About the Public Buildings are statues of Generals McClellan and Reynolds, President McKinley, and Joseph Leidy and St Gaudens's "Pilgrim." On all sides are great buildings: on the north the masonic temple (1868-1873); on the south the stately Betz Building; on the west the enormous Broad Street station of the Pennsylvania railway. The Pennsylvania Academy of Fine Arts and the Oddfellows' Temple are among other notable buildings in the vicinity. The post office, facing Ninth Street and extending from Market Street to Chestnut Street, was opened in 1884; in front is a seated statue of Benjamin Franklin, by John J. Boyle. The mint is at the corner of Sixteenth and Spring Garden streets. The custom-house, on Chestnut Street, was designed by William Strickland (1787-1854), in his day the leading American architect. It was modelled after the Parthenon of Athens, was built for the Second United States Bank, was completed in 1824, and was put to its present use in 1845. Other prominent buildings of

which Strickland was the architect are the stock exchange, St Paul's Protestant Episcopal Church, St Stephen's Church, the almshouse and the United States Naval Asylum. The main building of Girard College (on Girard Avenue, between North 19th and North 25th streets), of which Thomas Ustick Walter (1804-1887), a pupil of Strickland's, was the architect, is one of the finest specimens of pure Greek architecture in America. Near the Schuylkill river, in West Philadelphia, are the buildings of the university of Pennsylvania. Its free museum of science and art, at South 23rd and Spruce, on the opposite side of the river, was built from the designs of Walter Cope, Frank Miles Day and Wilson Eyre, and its north-western part was first opened in 1899. Tall steel-frame structures, of which the Betz Building, completed in 1893, was the first, have become numerous. The Roman Catholic Cathedral of St Peter and St Paul, east of Logan Square, was begun in 1846 and was eighteen years in building. The Arch Street Methodist Episcopal Church is one of the most handsome churches in the city. The South Memorial Church of the Advocate (1897), on North 18th and Diamond streets, is a reproduction on a smaller scale of Amiens Cathedral.

Perhaps the most famous historical monument in the United States is Independence Hall, on Chestnut Street between Fifth and Sixth streets, designed for the state house by Andrew Hamilton (c. 1676-1741), speaker of the assembly, and was used for that purpose until 1790. The foundations were laid in 1731 and the main building was ready for occupancy in 1735, although the entire building was not completed until 1751. The steeple was taken down in 1774 but was restored by Strickland in 1828, and further restorations of the building to its original condition were effected later. In the east room on the first floor of this building the second Continental Congress met on the 10th of May 1775, George Washington was chosen commander-in-chief of the Continental army on the 15th of June 1775, and the Declaration of Independence was adopted on the 4th of July 1776. The room contains much of the furniture of those days, and on its walls are portraits of forty-five of the fifty-six signers of the Declaration and a portrait of Washington by Peale. At the head of the stairway is the famous Liberty bell, which bears the inscription, "Proclaim liberty through all the land unto all the inhabitants thereof" and is supposed (without adequate evidence) to have been the first bell to announce the adoption of the Declaration of Independence. It was cast in England in 1752, was cracked soon after it was brought to America, was recast with more copper in Philadelphia, and was cracked again in 1835 while being tolled in memory of Chief Justice John Marshall, and on the 22nd of February 1843 this crack was so increased as nearly to destroy its sound. On the second floor is the original of the charter which William Penn granted to the city in 1701 and the painting of Penn's treaty with the Indians by Benjamin West. The building has been set apart by the city, which purchased it from the state in 1816, as a museum of historical relics. On the north-west corner of Independence Square is old Congress hall, in which Congress sat from 1790 to 1800, and in which Washington was inaugurated in 1793 and Adams in 1797. At the north-east corner is the old city-hall, on the second floor of which the Supreme Court of the United States sat from 1791 to 1800. A short distance east of Independence Square in Carpenters' Hall, in which the first continental congress assembled on the 5th of September 1774 and in which the national convention in 1787 framed the present constitution of the United States; the building was also the headquarters of the Pennsylvania committee of correspondence, the basement was used as a magazine for ammunition during the War of Independence, and from 1791 to 1797 the whole of it was occupied by the First United States Bank. The Carpenters' Company (established in 1724) erected the building in 1770, and since 1857 has preserved it wholly for its historic associations. On Arch Street near the Delaware is preserved as a national monument the house in which Betsy Ross, in 1777, made what has been called the first United States flag, in accordance with the resolution of Congress of the 14th of June. Not

far from this house is Christ Church (Protestant Episcopal), a fine colonial edifice designed mainly by Dr John Kearsley (1684-1772). The corner stone was laid in 1727, but the steeple, in part designed by Benjamin Franklin and containing a famous chime of eight bells, was not completed until 1754. The interior was restored to its ancient character in 1882, the pews of Washington and Franklin are preserved, and a set of communion plate presented to the church by Queen Anne in 1708 is used on great occasions. In the churchyard are the graves of Benjamin Franklin, Robert Morris, Brigadier-General John Forbes, John Penn, Peyton Randolph, Francis Hopkinson and Benjamin Rush. St Peter's, the second Protestant Episcopal Church in the city, has a massive tower and a simple spire; within are the original pews. In the south-east part of the city near the Delaware is the ivy-clad Old Swedes' Church, built of brick in 1698-1700. The house which William Penn built about 1683 for his daughter Letitia was removed to Fairmount Park and rebuilt in 1883. In Germantown (q.v.), a suburb which was annexed in 1854, are several other historic buildings.

The dominant feature of the domestic architecture is the long rows, in street after street, of plain two-storey or three-storey dwellings of red ("Philadelphia") pressed brick with white marble steps and trimmings, and with white or green shutters, each intended for one family.

Parks.—Fairmount Park extends along both banks of the Schuylkill for about 5 m. and from the confluence of the Schuylkill and Wissahickon Creek it continues up the latter stream through a romantic glen for 6 m. Its area is about 3418 acres. Five acres of an estate belonging to Robert Morris during the War of Independence and known as "Fair Mount," or "The Hills," were purchased by the municipality for "a city waterworks and for park purposes" in 1812, and from this beginning the park grew to its present dimensions by purchases and gifts. The principal buildings in the park are: the McPherson mansion, once the property of Benedict Arnold and in October 1780 confiscated by the committee of safety; the Peters (or Belmont) Mansion, built in 1745 and much frequented by the notables of the Revolutionary and early national period; the birth-place of David Rittenhouse, the astronomer, and a monastery of the German pietists, both on the banks of Wissahickon; and memorial hall and horticultural hall, both survivals of the centennial exhibition of 1876. On Lemon Hill, near the south end of the park, stands the Robert Morris mansion; in the vicinity is the cabin which was General U. S. Grant's headquarters at City Point, Virginia, during the winter of 1864-1865. Near the Columbia Avenue entrance to the park and near the East Park Reservoir are the children's playhouse and playground, endowed by the will of Mrs Sarah A. Smith (d. 1893). At the Green Street entrance is an imposing monument to Washington, designed by Rudolph Siemering and erected by the Society of the Cincinnati in 1896-1897, with a bronze equestrian statue. The Smith Memorial entrance, whose granite with bronze statues, was erected in memory of the officers of the Civil War. The park also contains a monument to Lincoln by Randolph Rogers; an equestrian statue of Grant by Daniel Chester French and Edward C. Potter; an equestrian statue of Major-General James Gordon Meade by Alexander Milne Calder; an equestrian statue of Joan of Arc by Emmanuel Fremiet; an heroic bust of James A. Garfield by Augustus T. Gaudens; statues of Columbus, Humboldt, Schiller and Goethe; a Tam O' Shanter group of four figures in red sandstone by James Thoms; John J. Boyle's "Stone Age in America"; Cyrus Edwin Dallin's "Medicine Man"; Wilhelm Wolff's "Wounded Lioness" (at the entrance to the Zoological Gardens); Albert Wolff's "Lion Fighter"; Auguste Nicolas Cain's "Lioness bringing a Wild Boar to her Cubs"; Edward Kemeys's "Hudson Bay Wolves"; Frederick Remington's "Cow Boy"; and several artistic fountains, and a Japanese temple-gate. In the down-town district, Franklin, Washington, Rittenhouse and Logan squares, equidistant from the city-hall, have been reserved for public parks from the founding of the city; in Rittenhouse Square is the bronze "Lion and Serpent" of A. L. Barye. In Clarence H. Clark Park, West Philadelphia, is Frank Edwin Elwell's group "Dickens and Little Nell." In Broad and Spring Garden streets opposite the Baldwin Locomotive Works is Herbert Adams's statue of Matthias William Baldwin (1795-1866), founder of the works. Close to the bank of the Delaware, some distance N.N.E. of the city-hall, is the small Penn Treaty Park with a monument to mark the site of the great elm tree under which Penn, according to tradition, negotiated his treaty with the Indians in 1683. In the south-west part of the city, along the Schuylkill, is Bartram's botanical garden (27 acres), which the city

¹ Many of the statues and other works of art in Fairmount and other parks are the gift of the Fairmount Park Art Association (1871; reorganized in 1888 and 1906).

added to its park system in 1891; in it is the stone house, with ivy-covered walls, which the famous botanist built with his own hands.

Through the efforts of the City Park Association, organized in 1888, a number of outlying parks, connecting parkways and small triangular or circular parks, have been placed on the city plan. Among these are League Island Park (300 acres), opposite the United States navy yard on League Island; Penny Pack Creek Park (about 1200 acres), extending 6½ m. along Penny Pack Creek, in the north-east; Cobb's Creek Park, extending about 4 m. along the western border; Fairmount Parkway, 300 ft. wide on a direct line south-east from Fairmount Park to Logan Square and somewhat narrower from Logan Square to the city-hall; and Torresdale Parkway (300 ft. wide and 10½ m. long), from Hunting Park, 4½ m. north of the city-hall, along a direct line north-east to the city limits. A plaza at the intersection of Broad and Johnson streets, radiating streets therefrom, and the widening of Broad Street to 300 ft. from this plaza to League Island Park are also on the city plan. Laurel Hill cemetery, on a high bank of the Schuylkill and contiguous to Fairmount Park, is the city's principal burying ground; in it are the tombs of Dr. Elisha Kent Kane, the Arctic explorer, and Major-General Meade.

Theatres.—The first Shakespearian performance in the United States was probably at Philadelphia in 1749; another company played there in 1754 and 1759; and in 1766 was built the Old South-west theatre, in which Major John André and Captain John Peter De Lancy acted during the British occupation of the city, and which after twenty years of illegal existence was opened "by authority" in 1789. The Walnut Street theatre (1808) is said to be the oldest play-house in the United States. Other theatres are the Garrick, the large Academy of Music, the Chestnut Street opera house, the Lyric, the Adelphi, the Park and the German.

Clubs.—Among social clubs are the Union League, the University (1881), the Philadelphia, the City, the Markham, the Manufacturers (1887), the Rittenhouse, the Lawyers, the Clover, the Pen and Pencil, the Art, the Mercantile, several country clubs and athletic clubs (notably the Racket), and the foremost cricket clubs in the United States, the Belmont, the Philadelphia, the Keystone, the Merjon (at Haverford), and the Germantown (at Manheim).

Museums, Learned Societies and Libraries.—In the southern part of Fairmount Park is a zoological garden with an excellent collection. Its site is the former estate of John Penn, grandson of William Penn. The collection is an outgrowth of the museum, the first in the United States, opened by Charles Willson Peale in Independence Hall in 1802. It is now owned by the Zoological Society (incorporated in 1859) and was opened in 1874. Other museums in Fairmount Park are: the botanical collection in horticultural hall; and in memorial hall the general art collections of the Pennsylvania Museum and School of Industrial Arts and the Wilsch collection of paintings (about 900), including examples of the Italian schools from the 15th to the 17th centuries and of modern French and American painters. Bartram's botanical garden, mentioned above as a city park, was established in 1728 by John Bartram (1699-1777) and is the oldest botanical garden in America. The Philadelphia Commercial Museums, founded in 1804, is a notable institution for promoting the foreign commerce of the United States, having a collection of raw materials and manufactured products from all countries, a laboratory and a library. The institution investigates trade conditions and the requirements of markets in all parts of the world, maintains a bureau of information, issues a weekly bulletin for American exporters and a monthly publication for foreign buyers, and has published several "foreign commercial guides" and other commercial works. The museum is maintained chiefly by municipal appropriations and by fees. Its control is vested in "The Board of Trustees of the Philadelphia Museums," composed of fourteen citizens of Philadelphia chosen for life and eight *ex officio* members who are the incumbents of the leading state and municipal offices. There are home and foreign advisory boards, and the immediate management is under a director. In 1727 Franklin, then in his twenty-second year, formed most of his ingenious acquaintance into a club, which he called the Junto, "for mutual improvement," and out of the Junto grew in 1731 the library of the Library Company of Philadelphia, which he spoke of as the "mother of all North American subscription libraries," but which was not the first subscription library in North America. The Library Company of Philadelphia absorbed in 1769 the Union Library, which had been founded some years before; and in 1792 the Loganian library, a valuable collection of classical and other works provided for under the will of James Logan, a friend of Penn, was transferred to it. Subsequently it acquired by bequest the libraries of the Rev. Samuel Preston of London and of William Mackenzie of Philadelphia. Among the rarities in the latter was a copy of Caxton's *Golden Legend* (1486). In 1869 the Library Company was made the beneficiary, under the will of Dr. James Rush (1786-1869), of an estate valued at about a million dollars, and with this money the Ridgway branch was established in 1878. The library has owned its building since 1790; the building on the present site was opened in 1880 and was enlarged in 1889.

The American Philosophical Society, founded by Franklin in 1743, is the oldest and the most famous academy of science in America. Its organization was the immediate consequence of a circular by

Franklin entitled, *A Proposal for Promoting Useful Knowledge among the British Plantations in America*. In 1769 it united with

(and officially took the name of) "The American Society held at Philadelphia for Promoting Useful Knowledge." Among its early presidents were Franklin, Rittenhouse and Jefferson. It has a valuable library—about 50,000 vols.—containing the great mass of the correspondence of Franklin; here, too, are many interesting relics, among them the chair in which Jefferson sat while writing the Declaration of Independence and an autograph copy of the Declaration. The society has published 27 quarto vols. of *Transactions* (1771-1908); its *Proceedings* have been published regularly since 1838, and in 1884 those from 1744 to 1838, compiled from the manuscript minutes, were also published. The Academy of Natural Sciences of Philadelphia, founded in 1812, has been noted for its collection of birds since it acquired, in 1846, the collection of the duc de Rivoli numbering more than 12,000 specimens; several smaller collections have since been added. The academy has a notable collection of shells and fossils and the "types" of Leidy, Cope, Say, Conrad and other naturalists, and a library. It is composed of the following "sections": biological and microscopical (1868), entomological (1876), botanical (1876), mineralogical and geological (1877) and ornithological (1891). It has published a *Journal* since 1817 and its *Proceedings* since 1841, and periodicals on entomology, conchology and ornithology. To a few young men and women it gives training in scientific investigation without charge. The Pennsylvania Historical Society, organized in 1824, has a valuable collection of historical material, including the papers of the Penn family and the Charlesmagne Tower collection of American colonial laws, and many early American printed handbills and books (especially of Bradford, Franklin and Christopher Saur), portraits and relics. With the proceeds of the society's publication fund the *Pennsylvania Magazine of History and Biography* has been published since 1877. The Numismatic and Antiquarian Society of Philadelphia, organized in 1858, is the oldest numismatic organization in the United States; it has a collection of coins, and since 1865 it has published its *Proceedings*. The College of Physicians and Surgeons has an excellent medical library. The free library of Philadelphia (established 1801) includes a main library and several branches. Other important libraries are that of the university of Pennsylvania, the Mercantile, that of Franklin Institute, that of the Law Association of Philadelphia, the Athenaeum, that of the German Society of Pennsylvania, and Apprentices'. The free museum of science and art of the university of Pennsylvania has valuable archaeological collections, notably the American and the Babylonian collections made by university expeditions.

Schools.—William Penn in his frame of government provided for a committee of manners, education and art. The assembly, in March 1683, passed an act which provided that all children should be taught to read and write by the time they were twelve years of age, that then they should be taught some useful trade, and that for every child not so taught the parent or guardian should be fined five pounds. At a meeting of the provincial council held in Philadelphia in 1683 the governor and council appointed as schoolmaster, Enoch Flower, who for twenty years had held that position in England. But schools were left almost wholly to private initiative until 1818. The first grammar school, commonly known in its early years as the Friends' free school, was established in 1689 under the care of the celebrated George Keith; although maintained by the Friends it was open to all, and for more than sixty years was the only public place for free instruction in the province. It was chartered by Penn in 1701, 1708 and 1711, in time became known as the William Penn Charter School, and is still a secondary school on Twelfth Street. In 1740 a building was erected for a "charity school" and for a "house of worship," but the school had not been opened when, in 1749, Franklin published his *Proposals relating to the Education of Youth in Pennsylvania*. Under the influence of this publication a new educational association was formed which purchased the building and in January 1751 opened in it an institution that was chartered as an "academy and charitable school" in 1753, was rechartered as a college and academy in 1755, and became the university of Pennsylvania by act of the state legislature passed in 1791. The university occupied the site of the present post office from 1802 until 1872, but was then removed to grounds near the western bank of the Schuylkill.

The foundation of the present public school system was laid in 1818 by an act of the legislature which constituted the city and county of Philadelphia the first school district of Pennsylvania and provided for the establishment therein of free schools for indigent orphans and the children of indigent parents; the same act authorized the establishment of a model school for the training of teachers, which was the pioneer school for this purpose in America. In 1834 free elementary schools were authorized for all children of school age, and since then the system has developed until it embraces the Central High School for boys, which has a semi-collegiate course with a department of pedagogy and confers the degrees of B.A. and B.S.; a Normal High School for girls, into which the model school was converted in 1848, in which most of the teachers of the city are trained and which only graduates of the Girls' High School are permitted to enter; the William Penn High School for girls (opened 1909) with academic, commercial, applied arts

household science and library economy departments; a School of industrial arts; two manual training schools; about one hundred night schools (attended mainly by adults); several special schools for habitual truants or insubordinate and disorderly children, and a number of vacation schools and playgrounds for the summer season. In 1909 district high schools were planned as a part of the public school system. The city has also many private high schools and academies.

Besides the university of Pennsylvania and the Central High School for boys the collegiate institutions are La Salle College (Roman Catholic; opened in 1867) and the Temple University (non-sectarian; chartered in 1888 as Temple College after four years of teaching; in 1891 received the power to confer degrees); which is designed especially for self-supporting men and women and was founded by Russell Hermann Conwell (b. 1842), a lawyer and journalist, who entered the Baptist ministry in 1879, was pastor of the Grace Baptist Church of Philadelphia in 1881-1891, became pastor of the Grace Baptist Temple in 1891, and was a public lecturer. He was the first president of the Temple College, which was begun in connexion with the work of his church. Temple University offers instruction both day and evening, has classes from the kindergarten to the highest university grades, and courses in business, civil engineering, domestic art and domestic science, physical training, pedagogy and music; it has a theological school (1893), a law school (1893), a medical school (1901) and a school of pharmacy (1902); and in 1907 the Philadelphia Dental College, one of the best known dental schools in the country, joined the university. In 1893 a trust fund left by Hyman Gratz was used to found the Gratz College for the education of teachers in Jewish schools and for the study of the Hebrew language, and Jewish history, literature and religion; the college is under the control of the Kaal Kidosh Mikoe Israel of Philadelphia. Bryn Mawr College (q.v.), one of the leading institutions in America for the higher education of women, is a few miles beyond the city limits. Schools of medicine, for which Philadelphia has long been noted, include the department of medicine of the university of Pennsylvania (opened in 1765); Jefferson Medical College (1825); the Woman's Medical College (1850), the first chartered school of medicine for women to confer the degree of M.D.; the Medico-Chirurgical College (1881); Hahnemann (homoeopathic) Medical College (1888); and the department of medicine of Temple University (1901). Among other professional schools are the department of law of the university of Pennsylvania (1790), the law school of Temple University (1894); the divinity school of the Protestant Episcopal Church (1862); the Lutheran theological Seminary (1864); Saint Vincent's (Theological) Seminary (R.C., 1868); the theological school of Temple University (non-sectarian, 1833); Pennsylvania College of Dental Surgery (1856); Philadelphia Dental College (1863; since 1907 a part of Temple University); the department of dentistry of the university of Pennsylvania (1878); the department of dentistry of the Medico-Chirurgical College (1897); the Philadelphia College of Pharmacy (1821); the department of pharmacy of the Medico-Chirurgical College (1898); and the school of pharmacy of Temple University (1902). Girard College (see GIRARD, STEPHEN) is a noted institution for the education of poor white orphan boys. The Pennsylvania Academy of the Fine Arts, founded in 1805 in Independence Hall, was the first art school in America; it occupies a fine building on Broad and Cherry streets, with a gallery of about 500 paintings, including examples of early American masters (especially Gilbert Stuart, of whom it has the largest collection), of modern American artists (especially in the Temple collection), and, in the collection of Henry C. Gibson, of French landscapes. The Drexel Institute of Arts and Sciences, founded in 1891 by Anthony J. Drexel and endowed by him with \$2,000,000, occupies a beautiful building (Chestnut Street and 32nd; opened in 1891) and embraces the following departments: architecture, science and technology, commerce and finance, domestic science, domestic arts, library school, English language and literature, history, civil government and economics, physical training, evening classes, department of free public lectures and concerts, library and reading room, and museum and picture gallery. The institution bestows free scholarships on a considerable number of students and charges the others very moderate fees. Its building houses a library, a collection of rare prints and autographs, and a museum with a picture gallery and exhibits of embroidery, textiles, ceramics, wood and metal work, &c. The Pennsylvania Museum and School of Industrial Art founded in 1876 and opened in 1877, has schools at Broad and Pine streets—the museum is housed in Memorial Hall in Fairmount Park. The school is a pioneer in America; it was originally a school of applied art, but in 1884 the Philadelphia textile school was established as another department. The Wagner Free Institute of Science, founded by William Wagner in 1855, has a library and a natural history museum, provides free lectures on scientific subjects, and publishes *Transactions*, containing scientific memoirs. The Franklin Institute for the promotion of mechanic arts (1824) has a technical library (with full patent records of several nations); since 1824 it has held exhibitions of manufactures; it has published since 1826 the *Journal of the Franklin Institute*; the institute provides lecture courses and has night schools of drawing, machine design and naval architecture. The Spring Garden Institute (1851), with day classes in mechanical drawing, handwork,

and applied electricity, and night classes in those subjects and in freehand and architectural drawing; the Philadelphia School of Design for Women (1836), of which Emily Sartain, a daughter of John Sartain, became principal in 1886, and a school of biology (1894) are other manual and industrial training schools within the city, and not far beyond the city limits is the Williamson Free School of Mechanical Trades (1888), endowed by Isaiah Vansant Williamson (1803-1886) with more than \$5,000,000 for the free training of bricklayers, machinists, carpenters, pattern makers, stationary engineers and other mechanics. The Lincoln Institution and Educational Home until 1907 was devoted mainly to the education of Indians.

Newspapers and Periodicals.—The *American Weekly Mercury* was the first newspaper published in Philadelphia and the third in the colonies. It was first issued on the 22nd of December 1719 by Andrew Sowle Bradford, a son of William Bradford, the first printer in the Middle Colonies, and was the first newspaper in these colonies. The second newspaper in the city and in the province was the *Universal Instructor in All Arts and Sciences and Pennsylvania Gazette*. It was established in 1728 by Samuel Keimer, but less than a year afterwards it became the property of Benjamin Franklin and Hugh Meredith, who shortened its title to the *Pennsylvania Gazette*. The only one of the newspapers established during the colonial era which survived the 19th century was the *Pennsylvania Packet or General Advertiser*, which was started in 1771 by John Dunlap, and during the War of Independence was published semi-weekly, with occasional "postscripts" of important news; in 1839 it was absorbed by the *North American* (1826), with which the *United States Gazette* (1789) was united in 1847 and which is still published as the *North American*. The *Aurora and General Advertiser*, established in 1790 by Benjamin Franklin Baehre (1766-1798), a grandson of Franklin, was a notorious anti-Federalist organ in its early years. A pioneer among newspapers at modern prices is the *Public Ledger*, founded in 1836, and in 1864 purchased by George William Childs. Other prominent daily papers now published are the *Inquirer* (Republican; 1829), the *Press* (Republican; 1857), the *Record* (Independent Democrat; 1870), the *Demokrat* (German; 1838), the *Evening Bulletin* (Republican; established in 1815 as the *American Sentinel*), the *Evening Item* (1847), the *Evening Telegraph* (Independent Republican; 1864), and the *Tagblatt* (Labour; German; 1877). Many of the earlier literary periodicals of America were published in Philadelphia; among them were the *American Magazine* (1757-1758 and 1760), Thomas Paine's *Pennsylvania Magazine* (1775-1776), the *Columbian Magazine* (1786-1790; called the *Universal Asylum* in 1790) which was edited by Matthew Carey and by A. J. Dallas, the excellent *American Museum* (1787-1792 and 1798), with which Carey was connected, the *Port Folio* (1801-1827; edited until 1812 by Joseph Dennie) and the *Analectic* (1802-1812) which succeeded *Select Reviews and Spirit of the Foreign Magazines* (1809), of which Washington Irving was editor in 1813-1814, and to which Paulding and Verplanck contributed, and the *American Quarterly Review* (1827-1837). Among others were: *Godley's Lady's Book* (1830-1877), for which Poe, Irving, Longfellow, Willis and others wrote; and *Graham's Lady's and Gentleman's Magazine* (1840-1859), with the contributors just named and Cooper, John G. Saxe, E. P. Whipple and others. *Lippincott's Magazine* (1868) is a monthly, best known for its fiction. The *Saturday Evening Post*, which has the largest circulation of the weekly publications, and the *Ladies' Home Journal* (1883), the semi-monthly with the largest circulation, are owned by the same company. The *Farm Journal* (1877) is a well-known agricultural monthly.

Trusts, Charities, &c.—Girard College and thirty-eight other charities are maintained out of the proceeds of as many trusts, which are administered by a board of directors composed of twelve members, appointed by the courts of common pleas, and the mayor, president of the select council, and president of the common council as *ex-officio* members. In 1907 the invested capital of the Girard Trust alone amounted to \$24,467,770 and the income from it was \$1,988,054. The total capital of all the minor trusts in the same year was \$1,583,026 and the income from this was \$56,730. Among the minor trust funds are: Wills Hospital (established in 1825); Benjamin Franklin Fund (1790) for aiding young married artificers; Thomas D. Groves Fund (1849) for providing the poor with fuel and food; Mary Shields' Almshouse Fund (1880); and the John Scott Medial Fund (1816) for bestowing medals upon young inventors. To Franklin Philadelphia is largely indebted for the Pennsylvania Hospital, the first hospital in the United States, which was projected in 1751 and is one of the foremost of nearly one hundred such institutions in the city. The municipal hospital for contagious diseases and hospitals for the indigent and the insane are maintained by the municipality, but most of the other institutions for the sick are maintained by medical schools and religious sects. Municipal charities are under the supervision of the department of public health and charities. Philadelphia is the seat of the state penitentiary for the eastern district, in which, in 1829, was inaugurated the "individual" system, i.e. the separate imprisonment and discriminating treatment of criminals with a view to effecting their reform.

Transportation and Commerce.—Nearly every street in the business centre and about one-third of the streets throughout the

built-up portion of the city have a single track of electric railway (overhead trolley), and most of the wider ones, except Broad Street, which has none, have a double track. A subway line has been opened for a short distance under Market Street, and other subway lines, as well as elevated lines, have been projected. The entire system, embracing in 1909 a total of 624.21 m., is operated by the Philadelphia Rapid Transit Company. Several inter-urban electric lines afford cheap service to neighbouring towns and cities. The extensive railway system under the control of the Pennsylvania railway, together with the Baltimore & Ohio railway affords transportation facilities north to New York, south to Baltimore, Washington and the south-west to the bituminous coalfields of Pennsylvania, the grain fields of the Middle West, and to Pittsburgh, Cleveland, Cincinnati and Chicago. The Philadelphia & Reading railway connects the city with the great anthracite coal region, and both the Philadelphia & Reading and the Pennsylvania control a line to Atlantic City. The Schuylkill is navigable for small craft to the "Fall line," about 7½ m. above its mouth and for vessels drawing 26 ft. to the oil refineries at Point Breeze, 3 m. from the mouth; from Point Breeze to the head of navigation the channel depth varies from 14 to 22 ft. The Delaware river is navigable to Trenton, New Jersey, about 30 m. above the upper end of the port of Philadelphia, and although in its natural condition this river was only 17 ft. deep at low water in its shallowest part below the port this depth was increased between 1836 and 1899 to 26 ft. (except in three shoal stretches), and a project of the Federal government was adopted in 1899 for increasing the depth to 30 ft. and the width to 600 ft. In 1905 the city of Philadelphia and the state of Pennsylvania appropriated \$750,000 for the improvement of the river between the city and the southern boundary of the state.¹ Steamships ply regularly between Philadelphia and several European ports, ports in the West Indies, and ports of the United States.

The port extends from the Pennsylvania railway terminal at Greenwich Point up the Delaware River to the Philadelphia & Reading terminal at Port Richmond, a distance of about 8 m., and there are minor harbour facilities on the Schuylkill. The natural facilities, together with the improvements that have been made, were long offset by an inefficient port administration under an antiquated law of 1803 which permitted the wharves to pass largely under private control; but in 1907 the old board of port wardens was abolished and in its place was created a municipal department of wharves, docks and ferries.

Until the opening of the Erie Canal, in 1825, Philadelphia was the emporium of the United States; it was then displaced by New York. Some years later Philadelphia lost its lucrative China trade, and its decline in commercial importance continued until 1883, when the value of its imports amounted to only \$32,811,045, the value of its exports to only \$38,662,434, and the city was outranked in foreign trade by New York, Boston, San Francisco and New Orleans. By 1900, however, the value of its imports had risen to \$49,191,236 and the value of its exports to \$81,327,704; in 1909 the value of the imports was \$78,003,464, an amount less than one-eleventh that of New York, but exceeded only by New York and Boston, and the value of the exports was \$80,650,274, an amount less than one-eighth that of New York, but exceeded only by New York, Galveston and New Orleans. The principal imports are sugar, drugs and chemicals, goatskins, wool, tobacco, jute and burkap, and cotton goods, iron ore, manufactured iron, hides and bananas; the principal exports are iron (manufactured), steel, petroleum, wheat, flour, lard, cattle and meat products. The proximity of the city to New York, whence many of its products are shipped, makes the statistics of its direct imports and exports no true index of its commercial importance.

Manufactures.—Philadelphia has always been one of the foremost manufacturing centres in the United States, and in 1905 it was outranked only by New York and Chicago.² The total value of its factory product was \$519,981,812 in 1900, and \$591,388,078 in 1905. Measured by the value of the products, Philadelphia ranked first among the cities of the country in 1905 in refining sugar and molasses (\$37,182,504; 13.4% of the total of the country) and in the manufacture of carpets and rugs (\$25,232,510; 41% of the total of the country), leather (\$23,903,230; 9.5% of the total of the country), hosiery and knit goods (\$15,770,873; 11.5% of the total of the country), woollen goods (\$12,239,881; 8.6% of the total of the country), and felt hats (\$5,847,771; 16% of the total of the country); second in the manufacture of worsted goods (\$26,964,533; 16% of the total of the country) and in dyeing and finishing textiles (\$4,371,006; 8.6% of the total of the country); and third in the manufacture of clothing (\$31,031,882; 5.1% of the total of the country) and silk goods (\$5,079,193; 3.8% of the total of the country). Other large industries are the manufacture of foundry and machine-shop products, cotton goods, malt liquors, iron and steel, chemicals, cigars and cigarettes, soap, confectionery, furniture,

¹ The city had previously expended \$1,555,000 on the improvement of the Delaware and Schuylkill rivers.

² The Philadelphia Museums claim that excluding slaughterhouse and sweat-shop products the value of Philadelphia's manufactured products is greater than that of any other city in the country.

paints, boots and shoes, electrical apparatus, and cordage and twine, and among notable individual establishments are the Baldwin Locomotive Works, the Cramp Ship-Yards and the Dixton or Keystone Saw Works. There are petroleum refineries at Point Breeze near the mouth of the Schuylkill; petroleum is piped to them from the north-west part of the state.

Water Supply.—The first municipal waterworks, installed in 1799-1801, pumped water by steam power from the Schuylkill into an elevated tank in Centre Square, where the city-hall now stands; this was one of the earliest applications of steam to municipal water pumping. In 1812-1815 new steam works were installed on Quarry Hill, or Fairmount; in 1819-1822 pumping works operated by water power were substituted for those operated by steam; and it was in great part for the preservation of the purity of the water supply that Fairmount Park was created. The park, however, did not serve its purpose in this respect. The water was impure and inadequate; additional works were installed from time to time, mostly on the Schuylkill, whence water was pumped by steam to reservoirs from which distribution was made by gravity; and to meet the increasing demands new filtration works and accessories were installed in 1901-1908. These take the water mainly from the Delaware river.

Government and Finances.—Inasmuch as it has been proved that in 1683 there was in use in Philadelphia a seal bearing the inscription "Philadelphia .83. William. Penn. Proprietor. and. Governor" and in all respects different from the provincial seal or the county seal, it seems that there was then a distinct government for the city. In July 1684 the provincial council, presided over by William Penn, appointed a committee to draft a borough charter, but there is no record of the work of this committee, and it is uncertain what the government of Philadelphia was for the next seventeen years.³ In 1701 Penn himself issued a charter creating a close corporation modelled after the English borough and under this the city was governed until the War of Independence. Upon the annulment of the Penn charter by the Declaration of Independence, government by commissions was established, but in 1789 a new charter was granted and, although the government has since undergone many and great changes, it is by virtue of this charter that the city remains a corporation to-day. The Consolidation Act of 1854 extended the boundaries to the county lines without destroying the county government, changed the corporate name from "Mayor, Aldermen, and Citizens of Philadelphia" to "the City of Philadelphia," created the offices of controller and receiver of taxes, and considerably modified the powers and duties of the corporation and its officers. The Bullitt Act, passed in 1885 to go into effect in 1887, and since 1885 amended and supplemented, is a new charter except in name; particularly notable is its transfer of the balance of power from the councils and various self-perpetuating commissions to the mayor.

The mayor is elected for a term of four years and is not eligible to the office for the next succeeding term. With the advice and consent of the select council he appoints the directors of the departments of public safety, public works, health and charities, supplies and (since 1907) wharves, docks and ferries, and the three members of the civil service commission. He may appoint, three persons to examine any department and for reasons given in writing may remove any officer whom he has appointed. His veto power extends to items in appropriation bills, but any item or ordinance may be passed over his veto within five days of such veto by an affirmative vote of three-fifths of the members elected to each council. The select council is composed of one member from each of the 47 wards, and in the common council each ward has one member for every four thousand names on the last completed assessment list (including names of those paying poll taxes as well as those paying taxes on real or personal property); in 1909 there were 80 members of the common council. The several administrative departments

³ A document purporting to be a charter, bearing the date of the 20th of May 1691, and signed by Thomas Lloyd, deputy-governor, was discovered in 1887, but the great seal is missing and there is no evidence that the charter was even in operation. The minutes of "a meeting of the Council held at Philadelphia on the third day of Sixth Month 1691" mention "Humphrey Morrey the present Mayor of the city of Philadelphia"; and this would seem to show that there was a regular municipal government in 1691. See *Philadelphia: Its Founding and Seals: Report of the Committee . . . to determine the Year of the Physical and Legal Founding of the City of Philadelphia* (Philadelphia, 1908).

⁴ In 1905 the state legislature took the appointment of these officers from the mayor and vested it in the councils, but this legislation was repealed in 1906.

are: public safety, public works, receiver of taxes, city treasurer, city controller, law, education, charities and corrections, supplies, wharves, docks and ferries, civil service commission and sinking fund commission (composed of the mayor, the city controller and a commissioner elected by a majority vote of the city council). Members of the select council are elected for three years—one-third each year; members of the common council for two years—one half each year; and the receiver of taxes, the city treasurer, the city controller, and the city solicitor, who is the head of the department of law, for a term of three years. The police constitute a bureau of the department of public safety, and at their head is a superintendent appointed by the director of the department with the approval of the select council. The department of education is administered by a central board appointed (at large) by the judges of the courts of common pleas.

The assessed value of taxable property in the city increased from \$153,369,048 in 1856 to \$536,667,834 in 1880, to \$880,935,265 in 1900, and to \$1,358,675,057 in 1910. The city's yearly expenditure increased from \$5,170,680 in 1856 to \$14,640,479 in 1880, to \$30,628,246 in 1900, and to \$48,012,630 in 1909. The principal items of expenditure in 1909 were: for public schools \$8,242,218; for the bureau of water, \$2,827,200; for streets and highways, \$4,219,260; for police, \$3,810,535; and for protection against fire, \$1,873,720. The receipts for the same year were \$44,372,927, of which \$18,851,442 were from the property tax (municipal and state), and \$4,396,124 were from the water tax. The city's indebtedness increased rapidly for a period of twenty-five years following consolidation. At the beginning of 1856 the funded debt was \$16,781,470, by the beginning of 1870 it had grown to \$42,401,933, and by the beginning of 1880 to \$70,970,041. By the new state constitution adopted in 1873 no municipality is permitted to create a debt exceeding 7% of the assessed value of its taxable property; in 1879 the state legislature passed an act to prevent the city from living beyond its income, and as a consequence of these restrictions the funded debt, less loans held by the sinking fund, was reduced by the beginning of 1895 to \$33,139,695. The great expense of installing the new filter plant, developing the park system, and making other improvements has, however, caused it to grow again; at the beginning of 1910 the total funded debt was \$95,483,820 and the net funded debt was \$84,901,620.

History.—The patent granted to William Penn for the territory embraced within the present commonwealth of Pennsylvania was signed by Charles II. on the 4th of March 1681 and Penn agreed that "a quantity of land or ground plot should be laid out for a large town or city in the most convenient place upon the river for health and navigation," and that every purchaser of 500 acres in the country shall be allowed a lot of 10 acres in the town or city, "if the place will allow it." In September Penn appointed William Crispin, Nathaniel Allen and John Bezan a commission to proceed to the new province and lay out the city, directing them to select a site on the Delaware where "it is most navigable, high, dry and healthy; that is where most ships can best ride, of deepest draught of water, if possible to load or unload at the bank or key side without boating or lightering of it." Crispin, a kinsman of the proprietor, died on the voyage out, but William Heage had been named a fourth commissioner some time after the appointment of the others and the three survivors arrived in the province toward the close of the year. They had been preceded by Penn's cousin, Captain William Markham, as deputy-governor, and were soon followed by the surveyor-general, Thomas Holme. Although the Swedes had established a settlement at the mouth of the Schuylkill not later than 1643 and the site now selected by the commissioners was held by three brothers of the Swenson family, these brothers agreed to take in exchange land in what is now known as Northern Liberties, and as early as July 1682 Holme, according to modified instructions from Penn for making the lots smaller than originally intended, laid out the city extending from the Delaware river on the east to the Schuylkill river on the west, a distance of about 2 m., and from Vine Street on the north to Cedar (now South) Street on the south, a distance of about 1 m. Penn landed at New Castle on the Delaware on the 27th of October 1682 and two days later came up as far as Upland, now Chester, 13 m. south of Philadelphia, but when he came to his newly founded city is not known. He is known, however, to have presided at a meeting of the provincial council held here on the 10th of March 1683, and from that time Philadelphia was the capital of Pennsylvania until

¹ If the debt of a city already exceeded the 7% limit it could be increased only by permission of the legislature.

1790, when Lancaster became the capital. During nearly the whole of this period it was also the most important city commercially, politically and socially in the colonies. Quaker influence remained strong in the city, especially up to the beginning of the 19th century; and it was predominant in Philadelphia long after it had given way before the Scotch-Irish in the rest of Pennsylvania. But even in Philadelphia the academy (later the university of Pennsylvania) soon came under the control of the Protestant Episcopal Church. The first Continental Congress met in Carpenters' Hall on the 5th of September 1774; the second in the old state house (Independence Hall) on the 10th of May 1775; and throughout the War of Independence, except from the 26th of September 1777 to the 18th of June 1778, when it was in possession of the British,² Philadelphia was the virtual capital of the colonies; it was a brilliant social city, especially during the British possession. The national convention which framed the present constitution of the United States sat in Philadelphia in 1787, and from 1790 to 1800 the city was the national capital. Here Benjamin Franklin and David Rittenhouse made their great contributions to science, and here Washington delivered his farewell address to the people of the United States. Here, in July and August 1789, the clerical and lay delegates from the Protestant Episcopal Churches in the United States met and formally organized the Protestant Episcopal Church in the United States. Here the first bank in the colonies—the Bank of North America—was opened in 1781, and here the first mint for the coinage of the money of the United States was established in 1792. The city was visited with an epidemic of yellow fever in 1793 and again in 1798; and in 1832 nearly 1000 inhabitants died of Asiatic cholera.

The original boundaries remained unchanged for 172 years, but the adjoining territory as it became populated was erected into incorporated districts in the following order: Southwark (1762), Northern Liberties (1771), Moyamensing (1812), Spring Garden (1813), Kensington (1820), Penn (1844), Richmond (1847), West Philadelphia (1851) and Belmont (1853). In 1854 all these districts, together with the boroughs of Germantown, Frankford, Manayunk, White Hall, Bridesburg and Aramingo, and the townships of Passyunk, Blockley, Kingsessing, Roxborough, Germantown, Bristol, Oxford, Lower Dublin, Moreland, Byberry, Delaware and Penn was abolished and the boundaries of Philadelphia were extended to the county lines by a single act of the state legislature. The consolidation was in part the outcome of a demand for efficiency in preserving order. There had been occasional outbreaks of disorder: on the 17th of May 1838 an anti-abolition mob had burned Pennsylvania Hall, which had been dedicated three days before to the discussion of abolition, temperance and equality; in May 1844 anti-Catholic rioters had burned St Michael's and St Augustine's churches, and minor riots had occurred in 1835, 1842 and 1843. Philadelphia was from the first strongly anti-slavery in sentiment, and it was here in December 1833 that the American Anti-Slavery Society was organized, and in 1856, on the anniversary of the battle of Bunker Hill, that the first national convention of the Republican party met. During the Civil War the arsenal and the Southwark navy yard were busy manufacturing material for the Federal armies, the city was crowded with wounded soldiers, and here in 1864 was held the great sanitary fair for the benefit of the United States sanitary commission, an organization for the relief and care of wounded and sick soldiers. In 1876, the centennial year of American independence, a great exhibition of the industries of all nations was held in Fairmount Park from the 10th of May to the 10th of November, and about fifty buildings were erected for the purpose. In October 1882 the city celebrated the bi-centennial of the landing of William Penn, and in October 1908 the 225th anniversary of its foundation.

² Lord Howe, who had been in command of the British, embarked for England on the 24th of May, and on the 18th of this month was held for his farewell entertainment the famous *Mischianza*, a feast of gaiety with a tournament somewhat like those common in the age of chivalry, which was in large part planned by Captain John André.

BIBLIOGRAPHY.—J. T. Scharf and T. Westcott, *History of Philadelphia* (Philadelphia, 1884), the standard history; J. F. Watson, *Annals of Philadelphia*, revised by W. P. Hazard (Philadelphia, 1898), often the record of tradition; E. P. Allinson and B. Fenrose, *Philadelphia 1681-1887; a History of Municipal Development* (Philadelphia, 1887); J. H. Young (ed.), *Memorial History of the City of Philadelphia* (New York, 1895); Lillian I. Rhoades, *The Story of Philadelphia* (New York, 1900); T. Williams, "Philadelphia," in L. P. Powell's *Historic Towns of the Middle States* (New York, 1899); F. M. Etting, *An Historical Account of the Old State House* (Philadelphia, 1891); E. K. Price, *History of the Consolidation of Philadelphia* (Philadelphia, 1873); and Agnes Repplier, *Philadelphia, the Place and People* (New York, 1898).

PHILADELPHIANS, a sect of religious mystics, founded in London in the latter part of the 17th century. In 1652 Dr John Fordage (1607-1681), rector of Bradfield, Berkshire, gathered together a few followers of Jakob Boehme, the chief of whom was Jane Lead or Leade (*see* Ward; 1623-1704). Fordage was ejected from his living by the Triers in 1655, but was restored in 1660. Mrs Leade had been from girlhood of a mystical temperament, and experienced phantasms which she recorded in a diary entitled *A Fountain of Gardens*, beginning in 1670, in which year the Philadelphia society was definitely organized. She drew up for it "The Laws of Paradise," which show that the enterprise was designed "to advance the Kingdom of God by improving the life, teaching the loftiest morality, and enforcing the duty of universal brotherhood, peace and love." Its members had a strong faith in what they called the "Divine Secrets," the wonders of God and nature, the profound spiritual experiences of regeneration and soul-resurrection, and the second Advent. In 1693 some of Mrs Leade's writings were translated into Dutch, and by this means and her acquaintance with Francis Lee (1661-1719), an Oxford scholar who studied medicine at Leiden and became her son-in-law, a connexion was opened up with Germany and Holland. In 1703 the Philadelphians drew up their confession, but they made no further progress and soon declined. The Holland branch withdrew, and the English government forbade the society to meet. For many years, however, a considerable number of people regarded Mrs Leade's visions, which were published in a long series of writings, as proofs of her divine calling. In her later years she had a severe struggle with poverty, which was relieved by a pension granted by Baron Kniphausen.

PHILAE, an islet in the Nile above the First Cataract, of great beauty and interest, but since the completion of the Assuan dam in 1902 submerged except for a few months yearly during High Nile (July to October), when the water is allowed to run freely through the sluices of the Assuan dam. Philae is the nearest island to the point where the ancient desert road from Assuan rejoins the river south of the cataract. It marks also the end of the cataract region. Below it the channel is broad and straight with rocky granite islands to the west. The name in Egyptian was Pilak, "the angle (?) island": the Arabs call it Anas el Wagud, after the hero of a romantic tale in the *Arabian Nights*. Ancient graffiti abound in all this district, and on Bigeh, a larger island adjoining Philae, there was a temple as early as the reign of Tethmosis III. The name of Amasis II. (570-535 B.C.) is said to have been found at Philae, and it is possible that there were still older buildings which have been swallowed up in later constructions. About 350 B.C. Nektnebf, the last of the native kings of Egypt, built a temple to Isis, most of which was destroyed by floods. Ptolemy Philadelphus reconstructed some of this work and began a large temple which Ptolemy Euergetes I. completed, but the decoration, carried on under later Ptolemies and Caesars, was never finished. The temple of Isis was the chief sanctuary of the Dodecascoenus, the portion of Lower Nubia generally held by the Ptolemies and Romans. The little island won great favour as a religious resort, not only for the Egyptians and the Ethiopians and others who frequented the border district and the market of Assuan, but also for Greek and Roman visitors. One temple or chapel after another sprang up upon it dedicated to various gods, including the Nubian Mandulis. Ergamenes (Arkamane), king of Ethiopia, shared with the Ptolemies in the building. Besides

the temple of Isis with its birth-temple in the first court, there were smaller temples or shrines of Arsenuphis, Mandulis, Imuthes, Hathor, Harendotes (a form of Horus) and Augustus (in the Roman style), besides unnamed ones. There were also monumental gateways, and the island was protected by a stone quay all round with the necessary staircases, &c., and a Nilometer. The most beautiful of all the buildings is an unfinished kiosque inscribed by Trajan, well known under the name of "Pharaoh's Bed." Graffiti of pilgrims to the shrine of Isis are dated as late as the end of the 5th century A.D. The decree of Theodosius (A.D. 378) which suppressed pagan worship in the empire was of little effect in the extreme south. In A.D. 453 Maximinus, the general of the emperor Marcian, after inflicting a severe defeat on the Nobatae and Blemmyes who were settled in Lower Nubia, and thence raided Upper Egypt, made peace on terms which included permission for these heathen tribes to visit the temple and even to borrow the image of Isis on certain occasions. It was not till the reign of Justinian, A.D. 527-565, that the temple of Philae was finally closed, and the idols taken to Constantinople. Remains of Christian churches were disclosed by the thorough exploration carried out in 1895-1896 in view of the Barrage scheme, under the direction of Captain Lyons. The accumulations of rubbish on the island were cleared away and the walls and foundations of the stone buildings were all repaired and strengthened before the dam was completed. The annual flooding now appears to be actually beneficial to the stonework, by removing the disintegrating salts and incrustations. The tops of most of the buildings and the whole nucleus of the temple of Isis to the floor remained all the year round above the water level until the dam was raised another 26 ft.—a work begun in 1907—when the temples were entirely submerged except during July-October. But the beauty of the island and its ruins and palm trees, the joy of travellers and artists, is almost gone.

See H. G. Lyons, *A Report on the Island and Temples of Philae* (Cairo, 1896), with numerous plans and photographs; a second report, *A Report on the Temples of Philae* (1908), deals with the condition of the ruins as affected by the immersions occasioned by the filling of the Assuan dam; Baedeker's *Egypt*; and on the effects of the submerison, &c., reports in *Annales du service des antiquités*; vols. iv, v. (P. L. C.)

PHILARET [THEODORE NEKITICH ROMANOV] (? 1553-1633), patriarch of Moscow, was the second son of the boyar Nikita Romanovich. During the reign of his first cousin Theodora I. (1584-1598), Theodore Romanov distinguished himself both as a soldier and a diplomatist, fighting against the Swedes in 1590, and conducting negotiations with the ambassadors of the emperor Rudolph II. in 1593-1594. On the death of the childless tsar, he was the popular candidate for the vacant throne; but he acquiesced in the election of Boris Godunov, and shared the disgrace of his too-powerful family three years later, when Boris compelled both him and his wife, Xenia Chestovaya, to take monastic vows under the names of Philaret and Martha respectively. Philaret was kept in the strictest confinement in the Antoniev monastery, where he was exposed to every conceivable indignity; but when the pseudo-Demetrius overthrew the Godunovs he released Philaret and made him metropolitan of Rostov (1605). In 1609 Philaret fell into the hands of pseudo-Demetrius II., who named him patriarch of all Russia, though his jurisdiction only extended over the very limited area which acknowledged the impostor. From 1610-1618 he was prisoner in the hands of the Polish king, Sigismund III., whom he refused to acknowledge as tsar of Muscovy on being sent on an embassy to the Polish camp in 1610. He was released on the conclusion of the truce of Desulin (Feb. 13, 1619), and on the 2nd of June was canonically enthroned patriarch of Moscow. Henceforth, till his death, the established government of Muscovy was a diarchy. From 1619 to 1633 there were two actual sovereigns, Tsar Michael and his father, the most holy Patriarch Philaret. Theoretically they were co-regents, but Philaret frequently transacted affairs of state without consulting the tsar. He replenished the treasury by a more equitable and rational system of assessing and collecting the taxes. His most important

domestic measure was the chaining of the peasantry to the soil, a measure directed against the ever increasing migration of the down-trodden serfs to the steppes, where they became free-booters instead of tax-payers. The taxation of the tsar's *syshchinas lyudi*, or military tenants, was a first step towards the proportional taxation of the hitherto privileged classes. Philaret's zeal for the purity of orthodoxy sometimes led him into excesses; but he encouraged the publication of theological works, formed the nucleus of the subsequently famous Patriarchal Library, and commanded that every archbishop should establish a seminary for the clergy, himself setting the example. Another great service rendered by Philaret to his country was the reorganization of the Muscovite army with the help of foreign officers. His death in October 1633 put an end to the Russo-Polish War (1632-33), withdrawing the strongest prop from an executive feeble enough even when supported by all the weight of his authority.

See R. N. Bain, *The First Romanovs* (London, 1905); S. M. Solovjev, *Hist. of Russia* (Rus.), vol. ix. (St Petersburg, 1895, &c.) (R. N. B.).

PHILATELY (Gr. φιλία, loving, and δρόμος, free of tax), the study and collection of postage-stamps and other marks of prepayment issued by post-offices. The fancy for collecting postage-stamps began a short time after the issue of the first British penny and two-penny stamps in 1840 (see **POST** and **POSTAL SERVICE**). Dr Gray, an official of the British Museum, began collecting them soon after their appearance, and an advertisement in an issue of *The Times* of 1841 asks for gifts of cancelled stamps for a young lady. In 1842 the new hobby was ridiculed in *Punch*. It was not until about 1860, however, that stamp collecting began to be systematically carried on with full regard to such minutiae as the different kinds of paper, water-marks, perforation, shade of colour and distinctive outline. About 1865 a teacher in Paris directed that foreign stamps should be collected and pasted upon the pages of his pupils' atlases and geographies according to countries, and this may have been the first form of the systematic classification of stamps in a collection. Of existing collections the oldest were begun between 1853 and 1860, by which year French collectors had assumed especial prominence. Professional dealers now made their appearance, and in 1861 philatelic literature, now of vast extent, was inaugurated by the publication in Strasburg of a catalogue of stamps issued up to that time. The Paris collectors were the first to classify stamps, measure them by the gauge, note the water-marks and separate the distinct issues of each country. Collecting with due regard to the relationship of different issues is called *plating*. The first English catalogue was issued in 1861, followed in December of the same year by *The Stamp Collector's Review and Monthly Advertiser*, published in Liverpool, the first philatelic periodical, the second, *The Stamp Collector's Magazine*, appearing in 1863. In 1863 also appeared *Le Timbre-Poste*, a Brussels journal. Up to 1910 over 800 philatelic periodicals had appeared.

Although small bodies of enthusiasts had banded together in England, France and the United States for the study and collection of postage-stamps as early as 1865, it was not until 1869 that the first great club, the *Philatelic Society of London*, still the most important in the world, was founded. Other societies in Great Britain are the *Junior Philatelic* of London, and those of Birmingham, Manchester, Edinburgh and Leith. The leading society in America is the American Philatelic Association; in France the *Société Française de Numismatique*; in Germany the *Internationaler Philatelisten-Verein*. More than 400 such organizations are now in existence, the majority of them in the United States and Germany. At a philatelic congress, held in London in 1910, the formation of a universal union of philatelic societies "to discourage unnecessary or speculative issues" was considered.

Not only the stamps themselves were collected, but "entires," i.e. postcards, envelopes with the stamps still adhering, &c. Marks of prepayment at last became so numerous that, about 1880, specialists began to appear, who restricted their collections to the stamps of some particular country or continent, or to

postcards or newspaper-wrappers alone. The most extensive and valuable stamp collection in the world, that of Baron P. von Ferrary of Paris, was begun about 1865. This collection, which cost its owner at least £250,000, contains a cancelled and an uncanceled specimen of each stamp. The next greatest collection is that bequeathed to the British nation in 1891 by T. K. Tapling, M.P., now in the British Museum. Among other important collections may be mentioned those in the German Postal Museum in Berlin, of King George V. of England, W. B. Avery, H. J. Duveen and the earl of Crawford. The largest sum realized for an entire collection was £27,500, which was paid for that of M. P. Castle, consisting of European stamps only. The value of a stamp depends partly upon its age, but much more upon its rarity, which again is dependent upon the number of the particular stamps originally issued. Most stamps have a quoted value, but some possess a conventional value only, such as those of which only one or two specimens are known to exist; for instance, the one-cent stamp of the 1865 issue of British Guiana (one known copy); the Italian 15 *centesimi* stamp of 1865 converted by an overprint into 20 *centesimi* (one copy); the Cape of Good Hope triangular, printed by mistake on paper intended for stamps of other colonies (four copies); and the 2 cent stamps of the earliest issue of British Guiana (ten copies). The best known of the very rare stamps are the 1d. and 2d. "Post-Office" Mauritius, for which higher prices have been paid than for any other stamps, although 23 copies are known to exist out of the 1000 issued. For a fine specimen of these Mauritius stamps £2000 has been offered. Two of them have been sold for £2400. Philatelic exhibitions such as those held in London in 1890 and 1897 and in Manchester in 1909 have proved popular.

"Reprints" are reimpresions, taken from the original plates, of obsolete stamps, and have a much smaller value than specimens of the original issue. Forgeries of the rarer stamps are common but are easily detected. Modern postage-stamp albums are often beautiful specimens of the printer's art, reproductions of every known stamp being given in the original colours.

See W. J. Hardy and E. D. Bacon, *The Stamp Collector* (London, 1898); Oliver Firth, *Postage Stamps and Their Collection*, (1897); F. J. Meville, *A B C of Stamp Collecting* (1903); Calman and Collin, *Catalogue for Advanced Collectors* (New York, 1902); Hastings E. Wright and A. B. Creeke, *History of the Adhesive Stamps of the British Isles* (London, 1899); J. K. Tiffany, *Stamp Collector's Library Companion* (Chicago, 1899); Luft, *The Postage Stamps of the United States* (New York, 1902); W. E. Daniels, *History of British Postmarks* (London, 1898); L. Salfesque, *Le Timbre à travers l'histoire* (Rouen, 1890); R. Senti, *Illustrierter Postmarkenhandbuch* (Leipzig, annually); Kröttsch, *Permanentes Handbuch der Postmarkenkunde* (Leipzig, annually); periodicals: *The London Philatelist* (monthly); *Illustrierte Briefmarken-Zeitung* (Leipzig).

PHILEMON (c. 361-263 B.C.), Greek poet of the New Comedy, was born at Soli in Cilicia, or at Syracuse. He settled at Athens early in life, and his first play was produced in 330. He was a contemporary and rival of Menander, whom he frequently vanquished in poetical contests. Posterity reversed the verdict and attributed Philemon's successes to unfair influence. He made a journey to the east, and resided at the court of Ptolemy, king of Egypt, for some time. Plutarch (*De Cohibenda Ira*, 9) relates that on his journey he was driven by a storm to Cyrene, and fell into the hands of its king Magas, whom he had formerly satirized. Magas treated him with contempt, and finally dismissed him with a present of toys. Various accounts of his death are given; a violent outburst of laughter, excess of joy at a dramatic victory, or a peaceful end while engaged in composing his last work (Apuleius, *Florida*, 16; Lucian, *Macrob.* 25; Plutarch, *An Seni*, p. 725). Of the ninety-seven plays which he is said to have composed, the titles of fifty-seven and considerable fragments have been preserved. Some of these may have been the work of his son, the younger Philemon, who is said to have composed fifty-four comedies. *The Merchant* and *The Treasure* of Philemon were the originals respectively of the *Mercator* and *Trinummus* of Plautus. The fragments preserved by Stobaeus, Athenaeus and other writers contain much wit and good sense. Quintilian (*Instit.* x. 1, 72)

assigned the second place among the poets of the New Comedy to Philemon, and Apuleius, who had a high opinion of him, has drawn a comparison between him and Menander.

See A. Meineke, *Menandri et Philemonis reliquiae* (1823, including Bentley's emendations); T. Kock, *Comicorum graecorum fragmenta*, vol. iii. (1884).

PHILEMON, EPISTLE TO, a scripture of the New Testament. Onesimus, a slave, had robbed (vv. 11, 18-19) and run away from his master Philemon, a prosperous and influential Christian citizen of Colossae (Col. iv. 9), either offence rendering him liable to be crucified. Voluntarily or accidentally, he came across Paul, who won him over to the Christian faith. In the few tactful and charming lines of this brief note, the apostle sends him back to his master with a plea for kindly treatment. After greeting Philemon and his wife, with Archippus (possibly their son) and the Christians who met for worship at Philemon's house (vv. 1-2), Paul rejoices over (vv. 4-7) his correspondent's character; it encourages him to make an appeal on behalf of the unworthy Onesimus (8-21), now returning (Col. iv. 9) along with Tychicus to Colossae, as a penitent and sincere Christian, in order to resume his place in the household. With a line or two of personal detail (22-25) the note closes.

Rome would be a more natural rendezvous for fugitivarii (runaway slaves) than Caesarea (Hilgenfeld and others), and it is probable that Paul wrote this note, with Philippians and Colossians, from the metropolis. As Laodicea is close to Colossae it does not follow, even if Archippus be held to have belonged to the former town (as Lightfoot argues from Col. iv. 13-17), that Philemon's residence must have been there also (so A. Maier, Thiersch, Wieseler, &c.). Paul cannot have converted Philemon at Colossae (Col. ii. 1), but elsewhere, possibly at Ephesus; yet Philemon may have been on a visit to Ephesus, for, even were the Ephesian Onesimus of Ignatius (Eph. ii.) the Onesimus of this note, it would not prove that he had always lived there. No adequate reason has been shown for suspecting that the note is interpolated at any point. The association of Timothy with Paul (v. 2) does not involve any official tinge, which would justify the deletion of *ναλ Τιμωθεος ο εδελφος μου* in that verse, and of *ψυων* in vv. 1-2 (so Holtzmann), and Hausrath's suspicions of the allusion to Paul as a prisoner and of v. 12 are equally arbitrary. The construction in vv. 5-6 is difficult, but it yields to exegetical treatment (cf. especially Haupt's note) and does not involve the interpolation of matter by the later redactor of Colossians and Ephesians (Holtzmann, Hausrath¹ and Brückner, *Reihenfolge d. paul. Briefe*, 200 seq.).

The brevity of the note and its lack of doctrinal significance prevented it from gaining frequent quotation in the early Christian literature, but it appears in Marcion's canon as well as in the Muratorian, whilst Tertullian mentions, and Origen expressly quotes it. During the 19th century, the hesitation about Colossians led to the rejection of Philemon by some critics as a pseudonymous little pamphlet on the slave question—an aberration of literary criticism (reproduced in *Ency. Bib.*, 3693 seq.) which needs simply to be chronicled. It is interesting to observe that, apart from the letter of commendation for Phoebe (Rom. xvi.), this is the only letter in the New Testament addressed, even in part, to a woman, unless the second epistle of John be taken as meant for an individual.

BIBLIOGRAPHY.—In addition to most commentaries on Colossians and to Dr M. R. Vincent's edition of Philippians, compare special exegetical studies by R. Rollock (Geneva, 1602). G. C. Storr (1781), J. K. I. Demme, *Erklärung d. Philemon-Briefes* (1844); H. A. Petermann, *Ad fidem versionum . . . cum eorum textu orig. graece* (Berlin, 1844); M. Rothe, *Pauli ad Philem. epistola interpretatio historico-exegetica* (Bremen, 1844); and H. J. Holtzmann, *Zeitschrift für wissenschaftl. Theologie* (1873), pp. 428 sqq., besides the essays of J. G. C. Klotzsch, *De occasione et indole epistolae ad Philem.* (1792); D. H. Wildschut, *De vi dictionis et sermonis elegantia in epistola ad Philem.* (1809); and J. P. Esser, *Der Brief an Philemon* (1875). An up-to-date survey of criticism is furnished by Dr J. H. Bernard in Hastings's *Dictionary of the Bible*, iv. 832-834, and a good exposition may be found in Z. Weber's *Der Brief an d. Philemon, ein Vorbild für die*

christl. Behandlung sozialer Fragen (1896), as well as in Dr A. H. Drysdale's devotional commentary (London, 1906). (J. M. r.)

PHILEMON and BAUCIS, the hero and heroine of a beautiful story told by Ovid (*Metam.* viii. 610-715), the scene of which is laid in Phrygia. Zeus, accompanied by Hermes, visited earth in human form; tired and weary, they sought shelter for the night, but all shut their doors against them except an aged couple living in a humble cottage, who afforded them hospitality. Before their departure the gods revealed themselves, and bade their hosts follow them to the top of a mountain, to escape the punishment destined to fall on the rest of the inhabitants. The country was overwhelmed by a flood; the cottage, which alone remained standing, was changed into a magnificent temple. The gods appointed Philemon and Baucis priest and priestess, and granted their prayer that they might die together. After many years they were changed into trees—Philemon into an oak, Baucis into a lime. The story, which emphasizes the sacred duty of hospitality, is probably of local Phrygian origin, put together from two widely circulated legends of the visits of gods to men, and of the preservation of certain individuals from the flood as the reward of piety. It lingers in the account (Acts xiv.) of the healing of the lame man by Paul at Lystra, the inhabitants of which identified Paul and Barnabas with Zeus and Hermes, "come down in the likeness of men."

Similar stories are given in J. Grimm, *Deutsche Mythologie* (Eng. trans., 1883, ii. 580, and iii. 38).

PHILES, MANUEL (c. 1275-1345), of Ephesus, Byzantine poet. At an early age he removed to Constantinople, where he was the pupil of Georgius Pachymeres, in whose honour he composed a memorial poem. Philes appears to have travelled extensively, and his writings contain much information concerning the imperial court and distinguished Byzantines. Having offended one of the emperors by indiscreet remarks published in a chronography, he was thrown into prison and only released after an abject apology. Philes is the counterpart of Theodorus Prodromus in the time of the Comneni; his character, as shown in his poems, is that of a begging poet, always pleading poverty, and ready to descend to the grossest flattery to obtain the favourable notice of the great. With one unimportant exception, his productions are in verse, the greater part in dodecasyllabic iambic trimeters, the remainder in the fifteen-syllable "political" measure.

Philes was the author of poems on a great variety of subjects; on the characteristics of animals, chiefly based upon Aelian and Oppian, a didactic poem of some 2000 lines, dedicated to Michael Palaeologus; on the elephant; on plants; a necrological poem, probably written on the death of one of the sons of the imperial house; a panegyric on John Cantacuzene, in the form of a dialogue; a conversation between a man and his soul; on ecclesiastical subjects, such as church festivals, Christian beliefs, the saints and fathers of the church; on works of art, perhaps the most valuable of all his pieces for their bearing on Byzantine iconography, since the writer had before him the works he describes, and also the most successful from a literary point of view; occasional poems, many of which are simply begging letters in verse.

Editions: the natural history poems in F. Lehrs and F. Dübner, *Poetae bucolici et didactici* (Didot series, 1846); *Manuelis Philae Carmine inedita*, ed. A. Martini (1900); *Manuelis Philae Carmine* ed. E. Miller (1855-1857). See also C. Krumbacher, *Geschichte der byzantinischen Litteratur* (1897).

PHILETAS of Cos, Alexandrian poet and critic, flourished in the second half of the 4th century B.C. He was tutor to the son of Ptolemy I. of Egypt, and also taught Theocritus and the grammarian Zenodotus. His thinness made him an object of ridicule; according to the comic poets, he carried lead in his shoes to keep himself from being blown away. Over-study of Megarian dialectic subtleties is said to have shortened his life. His elegies, chiefly of an amatory nature and singing the praises of his mistress Battis (or Bittis), were much admired by the Romans. He is frequently mentioned by Ovid and Propertius, the latter of whom imitated him and preferred him to his rival Callimachus, whose superior mythological lore was more to the taste of the Alexandrian critics. Philetas was also the author of a vocabulary called *Ἀραῦρα*, explaining the meanings of rare

¹ *History of the New Testament Times* (1895), iv. 122-123. See, on this, Schenkel's *Bibel-Lexikon*, iv. 531-532.

and obscure words, including words peculiar to certain dialects; and of notes on Homer, severely criticized by Aristarchus.

Fragments edited by N. Bach (1828), and T. Bergk, *Poetae Lyrici Graeci*; see also E. W. Maass, *De tribus Philaeis carminibus* (1895).

PHILIDOR, FRANÇOIS ANDRÉ DANICAN (1726-1795), French composer and chess-player, was born at Dreux, on the 7th of September 1726, of a musical family. The family name was Danican, but that of Philidor, added in the middle of the 17th century, eventually supplanted the older name. François André received a musical education as a member of the corps of pages attached to the orchestra of the king; and subsequently he earned his living by giving lessons and copying music. Much of his time was, however, devoted to chess, at which he soon became an expert. He spent many years in travelling on the Continent and in England, meeting and defeating the most noted players of the time, and is regarded as the strongest player and greatest theoretician of the 18th century. Returning to France in 1754, he resolved to devote himself seriously to musical composition, and after producing several works of minor importance brought out at Paris, in the year 1759, his successful light opera, *Blaise le Savetier*, which was followed by a number of others, notably *Le Soldat magicien* (1760), *Le Jardinier et son seigneur* (1761), *Le Sorcier* (1762), and *Tom Jones* (1764). He died in London on the 31st of August 1795.

PHILIP (Gr. Φίλιππος, fond of horses, from φάλαξ, to love, and ἵππος, horse; Lat. *Philippus*, whence e.g. M. H. Ger. *Philippes*, Dutch *Filips*, and, with dropping of the final s, It. *Filippo*, Fr. *Philippe*, Ger. *Philipp*, Sp. *Felipe*), a masculine proper name, popularized among the Christian nations as having been that of one of the apostles of Christ. Notices of distinguished men who have borne this name are arranged below in the following order: (1) Biblical; (2) Kings of Macedonia, France, Germany and Spain; (3) other rulers.

PHILIP, one of the twelve apostles, mentioned fifth in all the lists (Matth. x. 3; Mark iii. 18; Luke vi. 14; Acts i. 13). He is a mere name in the Synoptists, but a figure of some prominence in the Fourth Gospel. There he is said to have been "of Bethsaida, the city of Andrew and Peter," and to have received his call to follow Jesus at Bethany, having previously been, it would seem, a disciple of the Baptist (John i. 43, 44; cf. 38). Philip was at that time the means of bringing Nathanael to Jesus (John i. 45), and at a later date he, along with Andrew, carried the request of the inquiring Greeks to the Master (John xii. 22). Philip and Andrew alone are mentioned by name in connexion with the feeding of the five thousand (John vi. 5, 7), and Philip is also one of the few interlocutors in John xiv. Slight though these references are, all agree in presenting Philip as of an inquiring and calculating character, slow to take the initiative, but, when convinced of the path of duty, thoroughly loyal in following it. After the resurrection he was present at the election of Matthias as successor to Judas, but he does not again appear in the New Testament history; it is, however, implied that he still continued in Jerusalem after the outbreak of the first persecution.

Little reliance can be placed on the traditional accounts of Philip, owing to the evident confusion that had arisen between him and the evangelist of the same name, who appears in the book of Acts (see below). According to Polycrates, bishop of Ephesus, in his controversial letter written to Victor of Rome towards the end of the 2nd century (*ap. Euseb. H. E.*, iii. 37, v. 24), the graves of Philip "of the twelve apostles," and of his two aged virgin daughters were in (the Phrygian) Hierapolis; a third daughter, "who had lived in the Holy Ghost," was buried at Ephesus. With this may be compared the testimony of Clement of Alexandria, who incidentally (*Strom.* iii. 6) speaks of "Philip the Apostle" as having begotten children and as having given daughters in marriage. On the other hand, Proclus, one of the interlocutors in the "Dialogue of Caius," a writing of somewhat later date than the letter of Polycrates, mentions (*ap. Euseb. H. E.*, iii. 31) "four prophetesses, the daughters of Philip at Hierapolis in Asia, whose tomb and that of their father are to be seen there," where the mention of the

daughters *prophesying* identifies the person meant with the Philip of Acts (cf. Acts xxi. 8). The reasons for setting aside this latter identification, and for holding that the Philip who lived at Hierapolis was the Apostle are clearly stated by Lightfoot, *Colossians* (2) note 3, p. 45 seq., and fresh confirmation of his view has recently been afforded by the discovery of an inscription at Hierapolis, showing that the church there was dedicated to the memory "of the holy and glorious apostle and theologian Philip" (Ramsay, *Cities and Bishoprics of Phrygia*, vol. i, pt. ii. p. 55a).

See also Corsen, "Die Töchter des Philippus" in the *Zeitschrift für die neutestamentliche Wissenschaft* (1901), p. 289 sqq. The other view, that the Philip of Hierapolis is the Philip of Acts, is taken by Zahn, *Forschungen zur Geschichte des neutestamentlichen Kanons* (1900), vi. 158 sqq.

A later stage of the tradition regarding Philip appears in various late apocryphal writings which have been edited by Tischendorf in his *Acta apostolorum apocrypha*, and in his *Apocalypses apocryphae*. According to the *Acta Philippi*, a work belonging to the earliest to the close of the 4th century (see Zahn, *op. cit.* p. 18 sqq.), Philip, with Bartholomew and his own sister Mariamne, exercised a widespread missionary activity, preaching not only throughout Asia Minor, but also in Hellas the city of the Athenians, in Scythia, and in Gaul, &c. According to one account he died a natural death; according to another he was hanged or crucified, head downwards. An apocryphal gospel, which describes the progress of the soul through the next world, bears his name (Hennecke, *Neutestamentliche Apocryphen*, 1904, p. 40 seq.).

Since the 6th century Philip has been commemorated in the West, along with St James the Less, on the 1st of May, their relics being deposited in the same church in Rome; in the Eastern Church Philip's day is the 14th of November, and that of James the Less the 23rd of October.

PHILIP, "the evangelist," is first mentioned in the Acts (vi. 5) as one of "the seven" who were chosen to attend to certain temporal affairs of the church in Jerusalem in consequence of the murmurings of the Hellenists against the Hebrews. After the martyrdom of Stephen he went to "the city of Samaria," where he preached with much success, Simon Magus being one of his converts. He afterwards instructed and baptized the Ethiopian eunuch on the road between Jerusalem and Gaza; next he was "caught away" by the Spirit and "found at Azotus" (Ashdod), whence "passing through he preached in all the cities till he came to Caesarea" (Acts viii.). Here some years afterwards, according to Acts xxi. 8, 9, where he is described as "the evangelist" (a term found again in the New Testament only in Eph. iv. 11; 2 Tim. iv. 5), he entertained Paul and his companion on their way to Jerusalem; at that time "he had four daughters which did prophesy." At a very early period he came to be confounded with the apostle Philip (see above); the confusion was all the more easy because, as an esteemed member of the apostolic company, he may readily have been described as an apostle in the wider sense of that word (see further Salmon, *Introd. to the New Testament*, 7th ed., p. 313 sqq.). A late tradition describes him as settling at Tralles in Asia Minor, where he became the overseer or ruler of the church. "Philip the deacon" is commemorated on the 6th of June.

PHILIP I., king of Macedonia, a semi-legendary prince, son of Argaeus, was, according to Herodotus (viii. 137-139) and Thucydides (ii. 100), the third of the Macedonian kings. In the texts of Dexippus and Eusebius he ranks sixth, Caranus, Coenus and Thurimas (or Turimmas) being there regarded as the predecessors of Perdiccas I., whom Herodotus and Thucydides regard as the first king of Macedonia. Eusebius and Dexippus assign to Philip I. a reign of 38 and 35 years respectively. There is, however, no real evidence for his existence. (E. R. B.)

PHILIP II. (382-336 B.C.), king of Macedonia, the son of Amyntas II., and the Lyncestian Eurydice, reigned 359-336. At his birth the Macedonian kingdom, including the turbulent peoples of the hill-country behind, was very imperfectly consolidated. In 370 Amyntas died, and the troubled reign of

Philip's eldest brother, Alexander II., was cut short in 368 by his assassination. His murderer, Ptolemy of Alorus, ruled as regent for the young Perdiccas, Amyntas's second son. In 367 Philip was delivered as hostage to the Thebans, then the leading power of Greece (by whom does not seem clear). During the three years he spent at Thebes he no doubt observed and learnt much. When he returned to Macedonia (364) Perdiccas had succeeded in getting rid of Ptolemy; but he fell in 360-359 before an onset of the hill tribes instigated by the queen-mother Eurydice, leaving only an infant son. Various pretenders sprang up and the kingdom fell into confusion. Philip seized the throne and drove back his rivals. He now began the great task of his life—the creation of the Macedonian national army. The first experiment he made with this new organism was brilliantly successful. The hill tribes were broken by a single battle in 358, and Philip established his authority inland as far as Lake Ochrida. In the autumn of the same year he took the Athenian colony, Amphipolis, which commanded the gold-mines of Mt Pangæus. Their possession was all-important for Philip, and he set there the new city, called after him, Philippi. Athens was temporarily pacified by assurances that Amphipolis would be handed over to her later on. The work of fashioning the Macedonian army occupied Philip for the next few years, whilst his diplomacy was busy securing partisans within the states of Greece. He availed as yet a forward policy, and having taken Pydna and Potidaea soon after Amphipolis, he made them over to the Olynthian confederation (see OLYNTHUS). His marriage with the fierce witch-woman, Olympias, daughter of the Epirote king, falls in this period, and in 356 she bore him his greater son, Alexander. In 353 Philip was ready for strong action. He first attacked Abdera and Maronea, on the Thracian sea-board, and then took Methone, which belonged to Athens. An overt breach with Athens was now inevitable. In the same summer he invaded Thessaly, where the Aleuadae of Larissa ranged themselves on his side against the *tyrannos* Lycophron, "tyrant" of Phœrae. Phœrae called in the help of the Phocian mercenaries, who had profaned Delphi, and Philip met with a check. He had, however, the advantage of now being able to present himself to the Greeks as the champion of Apollo in a holy war, and in 352 the Macedonian army won a complete victory over the Phœreans and Phocians. This battle made Philip *tyrannos* of Thessaly, and he claimed as his own Magnesia, with the important harbour of Pagasæ. Hostilities with Athens did not yet take place, but Athens was threatened by the Macedonian party which Philip's *glop* created in Eubœa.

From 352 to 346 Philip did not again come south. He was active in completing the subjugation of the Balkan hill-country to the west and north, and in reducing the Greek cities of the coast as far as the Hebrus (Maritza). For the chief of these, indeed, Olynthus, he continued to profess friendship till its neighbour cities were in his hands. Then, in 349, he opened war upon it. Athens, to whom Olynthus appealed, sent no adequate forces, in spite of the upbraids of Demosthenes (see his *Olynthiacs*), and in the spring of 347 Olynthus fell. Philip razed it to the ground (see OLYNTHUS). Macedonia and the regions adjoining it having now been securely consolidated, Philip celebrated his "Olympian" games at Diium. In 347 Philip advanced to the conquest of the eastern districts about the Hebrus, and compelled the submission of the Thracian prince Cersobleptes. Meanwhile Athens had made overtures for peace (see the *De falsa legatione* of Demosthenes), and when Philip, in 346, again moved south, peace was sworn in Thessaly. The time was come for Philip to assert himself in Greece, and the Phocians, who still dominated Delphi and held Thermopylae, could furnish a pretext to the champion of Pan-Hellenism and Apollo. The Phocian mercenaries at Thermopylae were bought off and Philip crossed into central Greece. Here he made Thebes his ally and visited the Phocians with crushing vengeance. The Pythian games of 346 were celebrated at the delivered Delphi under Philip's presidency. Pan-Hellenic enthusiasts already saw Philip as the destined captain-general of a national crusade against Persia (Isocrates, *Philippus*, about 345). And

such a position Philip had determined to secure: the Macedonian agents continued to work throughout the Greek states, and in the Peloponnesus Sparta soon found herself isolated. Eubœa, too, submitted to Macedonian influence, and even received some garrisons. But more work had to be done in the Balkan highlands. In 344, or one of the following years, the Macedonian arms were carried across Epirus to the Adriatic. In 343 Philip led a great expedition north "comparable to nothing in antiquity since Darius' famous march to Scythia." In 341 his army was still campaigning in eastern Thrace, when Philip felt compelled to show his presence in Thessaly. During these years, although Athens had not overtly broken the peace of 346, there had been various diplomatic bickerings and hostile intrigues between the two powers (cf. the *Philippics* of Demosthenes). Athens had even sent emissaries to the Persian court to give warning of the proposed national crusade. She now egged on the cities of the Propontis (Byzantium, Perinthus, Selymbria), who felt themselves threatened by Philip's Thracian conquests, to declare against him. The sieges of Perinthus and Byzantium (340, 339) ended in Philip's meeting with a signal check, due in some measure to the help afforded the besieged cities by Athens and her allies. Philip's influence all over Greece was compromised. But before marching south he led another expedition across the Balkans into the country now called Bulgaria, and returned to Pella with much spoil but severely wounded in the thigh. In 338 he once more crossed into central Greece. The pretext was the contumacy shown by the Locrian town Amphissa to the rulings of the Amphictyonic Council. Philip's fortification of Elatea filled Athens with alarm. Thebes was induced to join Athens; so were some of the minor Peloponnesian states, and the allies took the field against Philip. This opposition was crushed by the epoch-making battle of Chaeroneia, which left Greece at Philip's feet. In the following year (337) Philip was in the Peloponnesus, and a congress of the Greek states at the Isthmus (from which, however, Sparta held sullenly aloof) recognized Philip as captain-general for the war against Persia. Philip returned to Macedonia to complete his preparations; an advanced force was sent into Asia in the spring of 336. But Philip's plans were suddenly blasted by his assassination in the same year during the marriage festival of his daughter at Aegæa, the old capital of Macedonia. He left, however, in the Macedonian army a splendid instrument which enabled his son within ten years to change the face of the world.

Philip stands high among the makers of kingdoms. Restless energy, determination, a faculty for animating and organizing a strong people, went with unscrupulous duplicity and a full-blooded vehemence in the pleasures of sense. Yet Philip was not untouched by ideal considerations, as is proved by the respect, no doubt sincere, which he showed for Hellenic culture, by the forbearance and deference with which he treated Athens, the sacred city of that culture and his mortal foe. A special interest belongs to the Macedonian kingdom as it was shaped by Philip, since it forestalls a system which was not to find the time ripe for it in European history till many centuries later—the national kingdom quickened with the culture developed by the ancient city-states. The national kingdoms founded by the Northern races, after the fall of the Roman Empire, under the influence of the classical tradition, are the beginnings of the modern European system; Philip of Macedon foreshadows Theodoric, Charlemagne and William the Conqueror. But this first national kingdom within the sphere of Greek culture could not ultimately live between the surge of the Northern barbarians and the Roman power.

See the authorities under GREECE: *History*. A vivid and masterly sketch of Philip's personality and work is given in D. G. Hogarth's *Philip and Alexander* (1897). (E. R. B.)

PHILIP III. [ARREHDAEUS], king of Macedonia, was the feeble-minded son of Philip II. of Macedonia by a Thessalian wife. He was chosen by the Macedonian army at Babylon in 323 to be nominal king conjointly with the infant Alexander, and was killed in Macedonia by order of Olympias (317). (Set MACEDONIAN EMPIRE.)

378 PHILIP (KINGS OF MACEDONIA)—PHILIP II. (FRANCE)

PHILIP IV., king of Macedonia, was the son of Cassander, king of Macedonia: he reigned only one year (207-206).

PHILIP V., king of Macedonia, son of Demetrius II. and Chryseis, was an infant at his father's death in 230-229. His cousin, Antigonus Doson, administered the kingdom as regent till his death in 221-220, when Philip was eighteen years old. Philip now ascended the throne and reigned till 179. His reign was occupied in the vain struggle to maintain the old Macedonian supremacy in the Balkan Peninsula, which became hopeless after the intervention of Rome and the decisive battle of Cynoscephalae (197). See Rome: *History*, § II. "The Republic" (period B, § b). (E. R. B.)

PHILIP I. (1052-1108), king of France, eldest son of Henry I of France and Anne, daughter of Jaroslav I. (d. 1054), grand duke of Kiev, came to the throne, when a child of eight, by the death of his father on the 4th of August 1066. He had been crowned at Reims, in the presence of a number of magnates, on the 23rd of May 1059. Philip passed most of his early years in and around Paris, where the castles of lawless barons, such as that of Montlhéry, threatened even his personal safety. His minority came to an end in 1066. In the long reign that followed he showed no great ability or energy, and a looseness of morals which embroiled him with the Church. Before he was fifty years of age he became "fond of nothing but good cheer and sleep." But he increased the lands of his house around Paris, maintained order in them, and held his own against William I. and William II. of England, whose power in France far exceeded his own. This he accomplished for the most part by taking advantage of the quarrels among his vassals. When Baldwin VI. of Flanders died, in 1070, his son Arnulf was attacked by his uncle Robert the Frisian, count of Holland. Philip interfered, at the prayer of Arnulf's mother, Richildis; but the allies were defeated near Cassel on the 22nd of February 1071 and Arnulf slain. After a second war peace was sealed, apparently, by the marriage of Philip to Robert's step-daughter Bertha, daughter of Gertrude of Saxony and Florence, count of Holland. In 1074 a new rupture led to Philip seizing Corbie, part of the dower of his aunt Adèle, who had married Baldwin IV. of Flanders. By this he secured a sort of outpost in the direction of Flanders. The other main episodes of his reign were the quarrel over the Angevin inheritance and his wars with the dukes of Normandy. In the struggle between Fulke Rechin and his brother Geoffrey the Bearded for the inheritance of their uncle, Geoffrey Martel (d. 1066), count of Anjou, Philip received from Fulke in 1069, as the price of his neutrality, Château Landon and the Gatinais. This acquisition linked the county of Sens, acquired in 1055, with the rest of the domain round Paris, Melun and Orleans. War with William I. was chronic but intermittent. In 1076 Philip forced him to raise the siege of Dol in Brittany. Peace was made in 1077, and in December 1079 they together besieged Robert Curthose in the castle of Gerberoy. On the 8th of May 1080 the siege was raised and peace made. War with William began again in 1081 over the county of Vexin, which Philip had seized on the retirement of its count, Simon of Valois, to a monastery in 1076. William demanded reparation for the raid of Philip's vassals and the cession of Pontoise, Chaumont-en-Vexin and Mantes, but died after sacking Mantes in the same year. In 1008 there was war between Philip and William Rufus in both Maine and the Vexin. William came in person from Maine to lead the attack in the Vexin in September, and crossed the Seine, penetrating to within 30 m. of Paris on the west; but the campaign brought no results. In his last years Philip left the duty of repelling the attacks of his Norman and other enemies to his son Louis, associating him with himself, as "king-designate," some time between the 24th of May 1098 and the 15th of September 1100. It was his second marriage which was the cause of Philip's greatest difficulties. On the 15th of May 1092 he carried off Bertrada, daughter of Simon, baron de Montfort, wife of Fulke Rechin, and prepared to marry her, though his wife Bertha was still living. The bishops, headed by Ivo, bishop of Chartres, refused to attend the ceremony of marriage, but one was found

to perform it. Philip's open simony had long been a cause of friction with the papacy. When he added bigamy and adultery, Urban II. excommunicated him. The bishop of Chartres, in consequence, refused to bring his vassals to help Philip's ally, Robert, duke of Normandy, against his brother William in 1094. Bertha died in that year, but Fulke was still living, and the sentence was renewed at the council of Autun on the 15th of October. Philip replied by summoning the bishops to Paris to try Ivo of Chartres for treason. He gained a respite from the papal sentence by promises of submission, but the sentence was renewed by Urban at the council of Clermont in 1095, in 1096, and in 1097, and at Poitiers in 1101, despite the protest of William IX., count of Poitiers, who entered the church with his knights to prevent his suzerain from being excommunicated on his lands. Philip was reconciled with the Church in 1104, and took an oath not to have any converse or society with Bertrada except in the presence of "non-suspect" persons. But they seem to have gone on living together, and even visited Fulke Rechin (Bertrada's husband) in company on the 15th of October 1106. Philip died at the end of July 1108.

His reign is chiefly remarkable for the steady growth of the royal domain. In addition to the gains mentioned, he bought in 1101 a large slice of territory, including Bourges and Dun-le-Roi, from Eudes Arpin, viscount of Bourges, who was going on the crusade; and toward the end of his reign took Montlhéry, whose lord beset the southern approach to Paris. By his first queen he had four children: Louis VI., who succeeded him; Henry, who died young; Charles; and Constance, who married Hugh I., count of Champagne, and later Bohemund I., prince of Antioch. By Bertrada de Montfort he had three children: Philip, count of Mantes; Fleury or Florus, who married the heiress of Nangis; and Cecilia, who married, first Tancred, prince of Galilee and Antioch, and secondly Pons de Saint Gilles, count of Tripoli.

The materials for the reign of Philip I. are in the *Recueil des historiens des Gaules et de la France*, vols. xi. to xvi. See especially the critical examination by Dom Brial of the historians who have spoken of Philip I. at the beginning of vol. xvi. Consult also E. A. Freeman, *Norman Conquest*, iv., *passim*, and *William Rufus*, ii. 165-302; A. Luchaire, *Louis le Gros* (Paris, 1890), and "Les Premiers Capétiens" in E. Lavisse's *Histoire de France* (II. ii., pp. 168-175). More recent is the *Recueil des actes de Philippe I.*, edited by M. Fron (1908), and B. Monod's *Essai sur les rapports de Pascal II. avec Philippe I.* (Paris, 1907). For notices of the principal chronicles of the time see A. Molinier, *Les Sources de l'histoire de France* (II., esp. p. 307 et seq.).

PHILIP II. (1165-1223), known as PHILIP AUGUSTUS, king of France, son of Louis VII. and Adela, daughter of Theobald II., count of Champagne, was born on the 22nd of August 1165. On the 1st of November 1179 he was associated with his father as king by being crowned at Reims, and at once his father's illness threw the responsibility of government on him, the death of Louis on the 10th of September 1180 leaving him sole king.

The boy-king found himself and his kingdom in a difficult and humiliating position. His long strip of royal domain was hemmed in by the Angevin Empire on the west and by the kingdom of Arles on the south-east. Henry II. of England was feudal lord of the greater part of France, practically all west of a line which began at Dieppe and ended at the foot of the Pyrenees more than half-way across to the Mediterranean, while at one point it nearly touched the Rhone. Philip's predecessors had consolidated the Capetian power within these narrow limits, but he himself was overshadowed by the power of his uncles, William, archbishop of Reims; Henry I., count of Champagne; and Theobald V., count of Blois and Chartres. He secured an ally against them, and an addition to the royal domain, by marrying, on the 28th of April 1180, Isabella or Elizabeth, daughter of Baldwin V., count of Hainaut, and of Marguerite, sister of Philip of Alsace, the reigning count of Flanders, who ceded Arras, St Omer, Aire and Hesdin, and their districts, as Isabella's dowry, a district afterwards called Artois. On the 28th of June 1180 Philip made a treaty with Henry II. at Gisors, and his reign thus opened auspiciously. But from 1181 to 1185 he had to struggle against a feudal league of his Champagnard uncles and other great

barons, whose most active member was Stephen I., count of Sancerre (1152-1191). Though attacked from both north and south, the king's activity enabled him to compel the count of Sancerre to implore peace in 1181. On the death of Isabel of Vermandois, wife of Count Philip of Flanders, in 1182, Philip claimed Vermandois and seized Chauné and St Quentin, and forced his father-in-law, Baldwin of Hainaut, to support him by threatening to divorce Queen Isabel. The count of Flanders was obliged to sign the treaty of Beves in July 1185, which gave the king, in addition to the expectation of Artois, his wife's dower, sixty-five castles in Vermandois and the town of Amiens. By 1186 Hugh, duke of Burgundy, the only member of the coalition not yet subdued, was forced to submit. Then, secure at home, the king turned against Henry II., and by the truce of Châteauroux in June 1187, gained Issoudun and the seignior of Fréteval in the Vendômois. Though the truce was for two years, Philip assembled an army in 1188 to invade Normandy, demanding Gisors and the conclusion of the marriage which had been arranged between his sister Alice and Richard of England, who had meanwhile deserted his father. But the news came that Saladin had taken Jerusalem and Richard took the cross. Shortly afterwards Philip took advantage of a rising against his quondam friend Richard, who was duke of Aquitaine, to seize the county of Berry. At a conference at Bonmotlins on the 18th of November Richard again abandoned his father, and after a second conference at La Ferté Bernard, Philip invaded Maine and forced Henry II. to conclude the treaty of Azay on the 4th of July 1189, by which the English king did homage and surrendered the territories of Gracy and Issoudun. Henry died two days later. Pledges of mutual good faith and fellowship were renewed between Philip and Richard of England on the 30th of December 1189, and they both prepared to go on the crusade.

Before setting out Philip arranged for the government of France during his absence by his famous testament of 1190, by which he proposed to rule France as far as possible from Palestine. The power of the regents, Adela, the queen-mother, and William, archbishop of Reims, was restricted by a council composed mostly of clerks who had the king's confidence. An annual report on the state of the kingdom was to be sent him. On the way to Palestine the two kings quarrelled. At the siege of Acre Philip fell ill, and on the 22nd of July, nine days after its fall, he announced his intention of returning home. He reached Paris at Christmas 1191, having concluded on his way an alliance with the emperor Henry VI. against Richard, despite his pledges not to molest his lands. When Leopold I., duke of Austria, took Richard prisoner and delivered him to the emperor, Philip did his utmost by offers of money to prolong his captivity, and, allied with the English king's brother John, attacked Richard's domains, but upon Richard's return the Normans rallied enthusiastically to his aid. Philip was defeated at Fréteval on the 3rd of July 1194, but he continued the war, generally with ill success, for the next five years. Again a formidable coalition was formed against him, including Baldwin IX., count of Flanders and Hainaut, Renaud of Dammartin, count of Boulogne, Louis, count of Blois, and Raymond VI., count of Toulouse. In Germany, Otto of Brunswick, afterwards the emperor Otto IV., allied himself with Richard, while Philip was supported by Otto's rival, Philip of Swabia. Richard's death, in April 1199, removed his arch-enemy, and Richard's successor, John, concluded the treaty of Le Goulet with Philip on the 22nd of May 1200, ceding to him the county of Evreux, Gracy and Issoudun, and the suzerainty of Berry and Auvergne. John renounced his suzerainty over Brittany and the guardianship of his nephew, Arthur; he engaged not to aid the count of Flanders or Otto IV. without Philip's consent, paid him a relief of 20,000 marks, and recognized himself as his vassal for his continental fiefs. Philip's son Louis, afterwards Louis VIII., married Blanche of Castile, John's niece. But in 1202 the war was renewed, John having seized some castles from the family of Lusignan, whose head was the count of La Marche, and taken for his queen a prospective bride, Isabelle Taillefer, from Hugh, son of Hugh IX., count of La Marche. At an interview at Le Goulet on the 25th of March, Philip demanded

the cession of Anjou, Poitou and Normandy to his ward, Arthur. John refused; he was summoned to Paris before the royal judges, and failing to appear was sentenced at the end of April 1202 to lose all his fiefs. Brittany, Aquitaine and Anjou were conferred on Arthur. Philip invaded Normandy, took Lyons-la-Forêt and Eu, and, establishing himself in Gournay, besieged Arques. But John, joined by William des Roches and other lords of Maine and Poitou, jealous at the increase of Philip's power, defeated and took Arthur prisoner at Mirebeau. Philip abandoned the siege of Arques in a fit of fury, marched to the Loire, burning everywhere, and then returned to Paris. But John soon alienated the Poitevin barons, and William des Roches signed a treaty with Philip on the 22nd of March 1203. Then Philip continued his great task, the conquest of Normandy, capturing the towns around the fortress of Château-Gaillard which Richard had built to command the valley of the Seine. Pope Innocent III. tried to bring about peace, but Philip was obdurate, and after murdering Arthur of Brittany John took refuge in England in December 1203. The fall of Château-Gaillard, after a siege which lasted from September 1203 to April 1204, decided the fate of Normandy. Rouen, bound by ties of trade to England, resisted for forty days; it surrendered on the 24th of June 1204. The conquest of Maine, Touraine, Anjou and Poitou in 1204 and 1205 was little more than a military promenade, though the castles of Loches and Chinon held out for a year. Philip secured his conquest by lavishing privileges on the convents and towns. He left the great lords, such as William des Roches, in full possession of their feudal power. In 1206 he marched through Brittany and divided it amongst his adherents. A truce for two years was made on the 26th of October 1206 by which John renounced all claims in Normandy, Maine, Brittany, Touraine and Anjou, but it did not last six months. Then Poitou was thoroughly subdued, and another truce was made in 1208, little more than southern Saintonge and Gascony being left in the hands of John. Philip had reduced to a mere remnant the formidable continental empire of the Angevins, which had threatened the existence of the Capetian monarchy.

Philip then undertook to invade England. In the assembly of Soissons on the 8th of April 1213 he made every preparation for carrying out the sentence of deposition pronounced by the pope against John. He had collected 1500 vessels and summoned all his barons when Innocent III., having sufficiently frightened John, sent Pandulf with the terms of submission, which John accepted on the 13th of May.

Disappointed of his hopes of England, Philip turned his arms against Ferdinand, count of Flanders. Ferdinand, son of Sancho I., king of Portugal, owed his county to Philip, who, hoping to find him a docile protégé, had married him to Jeanne, heiress of Flanders, daughter of Count Baldwin IX., who became emperor of the East, using the weak Philip of Namur, her guardian, to accomplish that end. They were married in January 1212. On the morrow of the marriage Louis, afterwards Louis VIII., seized Aire and St Omer in right of his mother, Isabella, and on this account Ferdinand refused his feudal duty in the English expedition. Moreover, the trade interests of his subjects, who got their raw wool from England, drew him to an alliance with England. Philip's attack brought this about on the 22nd of May 1213. He invaded Flanders and took the chief towns within a week; but he had part of his fleet burned by the English at Damme, and had to burn the rest to save it from falling into their hands. He returned to Paris, and Ferdinand retook most of the towns which had been taken by the king. A war of fire and pillage began, in which Philip and his son Louis burned their way through Flanders, and Ferdinand did the same through Artois.

In 1214 came the great crisis of Philip's life. All the forces against which he had been struggling united to overwhelm him. Paris was to be attacked from Flanders and Guienne at the same time. A league including his rebel vassals, Renaud of Dammartin, count of Boulogne, and Ferdinand, count of Flanders, with the emperor Otto IV. and a number of German princes of the Rhine region, had been formed in the north-east, while John of England

made one more attempt to recover his heritage at the head of an army of mercenaries aided by the fickle baronage of Poitou. John landed at La Rochelle on the 16th of February 1214, and was at first successful. On the 19th of June he laid siege to La Roche-aux-Moines, the fortress which defended Angers and commanded the Loire valley; but on the approach of a royal army under Prince Louis on the 2nd of July his Poitevin barons refused to risk a pitched battle, and he fled hastily to La Rochelle. The Angevin Empire in France was lost. Meanwhile Philip himself won his greatest victory at the bridge of Bouvines, among the morasses of Flanders. At first taken by surprise, he turned the abortive attack into a complete rout. Renaud and Ferdinand were taken prisoner, and Otto IV. fled from the battlefield. The army of the allies was utterly destroyed (July 27, 1214). Nothing shows the progress of the Capetian monarchy more than the enthusiasm and joy of the people of France, as described by William the Breton, over this crowning victory. The battle of Bouvines, a decisive battle for the history of Germany as well as for France and England, sealed the work of Philip Augustus. The expedition of his son Louis to conquer England can hardly be considered as an incident of his reign, though he was careful to safeguard the rights of the French Crown. More important was the Albigensian crusade, in which he allowed Louis to take part, though he himself, preoccupied with the king of England, had refused time after time to do anything. He treated Simon de Montfort as if he were a royal *bailli*; but it was not in virtue of any deep-laid scheme of his that in the end Amaury de Montfort, Simon's son, resigned himself to leave his lands to the Crown of France, and gave the Crown a power it had never before possessed in Languedoc.

Even more than by his conquests Philip II. marks an epoch in French history by his work as an organizer and statesman. He surrounded himself with clerks and legists of more or less humble origin, who gave him counsel and acted as his agents. His *baillis*, who at first rather resembled the itinerant justices of Henry II. of England, were sent into the royal domain to supervise the conduct of the *prévôts* and hear complaints, while in the newly acquired lands in the south local feudal magnates were given similar powers with the title of *stetchal*. Feudal service was more and more compounded for by a money payment, while additional taxes were raised, all going to pay the mercenaries with whom he fought Richard I. and John. The extension of the system of *sauegarde*, by which abbeys, towns or lay vassals put themselves under the special protection of the king, and that of *pariage*, by which the possessor surrendered half the interest in his estate to the king in return for protection or some further grant, increased the royal power. The small barons were completely reduced to submission, whilst the greater feudatories could often appoint a castellan to their own castles only after he had taken an oath to the king. Philip supported the clergy against the feudal lords, and in many cases against the burgesses of the towns, but rigidly exacted from them the performance of their secular duties, ironically promising to aid the clergy of Reims, who had failed to do so, "with his prayers only" against the violence of the lords of Rethel and Roucy. He clung to his right of *regale*, or enjoyment of the revenues of bishoprics during their vacancy, though it was at times commuted for a fixed payment. The attempt to raise a tithe for the crusade in 1189 failed, however, before a general resistance owing to an unfair assessment.

It has been said with some justice that Philip II. was the first king of France to take the bourgeoisie into partnership. He favoured the great merchants, granting them trade privileges and monopolies. The Jews he protected and plundered by turns, after the fashion of medieval kings. Amongst the subject towns administered by *prévôts* a great extension of the "custom of Lorris" took place during his reign. But it is as the ally and protector of the communes that he takes his almost unique place in French history. Before him they were resisted and often crushed; after him they were exploited, oppressed, and finally destroyed. In the case of Senlis he extended the jurisdiction of the commune to all crimes committed in the district. It is

true that he suppressed some communes in the newly conquered fiefs, such as Normandy, where John had been prodigal of privileges, but he erected new communes in his own private domain, quite contrary to the custom of other kings. He seems to have regarded them as a kind of garrison against feudal unruliness, while the rents they furnished increased his financial resources. He created no new types of commune, however, except Peronne, which received a maximum of political independence, the twenty-four electors, who named the *jurés* and other officers, being elected by the *corps de métiers*.

The newly organized powers of the Crown were in evidence everywhere, interfering in the family affairs of the great feudatories and taking advantage of minorities, such as that of Theobald IV. of Champagne. The great feudatories accepted his legislation on dower in 1214 and 1219 and the *établissement* of 1209 making co-heirs of fiefs hold direct from the king and not from one of their number. The Tournois was substituted for the Angevin money in Normandy after 1204. The army which safeguarded this active monarchy consisted chiefly of mercenaries. The old feudal *ost* was but rarely convoked. The communes, though they appear as taking part in the battle of Bouvines, compounded for their service by a money payment as early as 1194.

Philip's policy of building up a strong monarchy was pursued with a steadiness of aim which excluded both enthusiasm and scruple. But he seems to have prided himself on a certain humanity, or even generosity of temper, which led him to avoid putting his enemies to death, though he did not scruple to condemn Renaud of Dammartin to the most inhuman of imprisonments. He was impulsive and could display extraordinary activity at times, but he possessed also a certain coldness and caution. He shrank from no trickery in carrying out his ends, and had no room for pity. He could not even trust his own son with any power, and was brutal in his relations with his queen, Ingeborg. He is described by Pâris Gâtineau as "a well-knit, handsome man, bald (from his illness at Acre), of agreeable face and ruddy complexion, loving good cheer, wine and women. Generous to his friends, he was miserly to those who displeased him; very skilled in the art of the engineer, catholic in his faith, far-seeing, obstinate in his resolution. His judgment was sound and quick. He was also quick in his anger, but easily appeased." As the result of his steadiness of aim and patient sagacity, at the end of his reign the Crown was victorious over the feudal nobility and the royal domain extended to the frontiers along with royal authority. Artois, the Amienois, Valois, Vermandois, the greater part of the Beauvaisis, Normandy, Maine, Anjou, Touraine, and an important part of Poitou and Saintonge, were added to the domain during his reign. The number of *prévôts* was increased from thirty-eight to ninety-four, and the royal revenue increased from 19,000 livres a month to 1200 livres a day.

Philip Augustus died on the 14th of July 1223. He was thrice married. His first wife, Isabella, by whom he had one son, Louis, died in 1189 or 1190. After her death he married Ingeborg or Ingeborg (*g.s.*), daughter of Valdemar I. of Denmark. This unlucky marriage was negotiated, it is said, chiefly to acquire the old claims of Denmark over England, to be used as a weapon against Richard I. However that may be, he soon repudiated this Danish princess, for whom he seems to have conceived an unconquerable aversion on the very morrow of his marriage to her, and in 1196, in defiance of the pope, who had refused to nullify his union with Ingeborg, married Agnes, daughter of Bertold IV., duke of Meran. This led to his excommunication and brought the interdict upon France, and did more to weaken him than any other act of his. In 1200 he was forced to put away Agnes and to recognize Ingeborg as his lawful wife, but he kept her in prison until 1213. By Agnes (d. 1201) he had a son Philip, called "Hurepel," count of Clermont, and a daughter Mary, who married Philip, count of Namur (d. 1213), and then Henry II., duke of Brabant. Ingeborg lived until 1236.

See A. Luchaire in E. Lavisse's *Histoire de France*, tome III. 83-284 (Paris, 1904), and literature there indicated; L. Deslisle, *Catalogue des actes de Philippe Auguste* (Paris, 1856 and 1901); A. Cartellieri, *Philip II. August*, Ed. I. *Die vom Tode Ludwigs VII.*

(Leipzig, 1899), Ed. II. *Der Kreuzzug* (1906); and W. H. Hutton, *Philip Augustus* (in the Foreign Statesmen series, London, 1896). A. Molinier, *Les Sources de l'histoire de France* (tome iii. pp. 1-38), gives a complete bibliography of the sources for Philip's reign, including the history of the Third Crusade.

PHILIP III. (1245-1285), surnamed "the Bold" (*le Hardi*), king of France, son of Louis IX. and Margaret, daughter of Raymond-Bérenger IV., count of Provence, was born on the 3rd of April 1245. His funeral monument at St Denis depicts a man with beardless, square-cut features, but lacking character and animation. The authenticity of this effigy is fairly well borne out by what is known of him from other sources. He had many of the virtues of St Louis, but neither decision of character nor devotion to duty. He was pious, charitable, of unimpeachable morality, quick-tempered but placable, no great scholar, and only energetic as a hunter. The absence in him of the qualities that fit a man to rule made his court the arena of intriguing factions, which in reality ruled France during his reign of fifteen years. Matthew of Vendôme, abbot of St Denis, an old servant of Louis IX., acted as Philip's counsellor, so the chroniclers state, throughout the reign; but he is only a shadowy figure, and it is difficult to reconcile the statement that "everything was done according to his will" with the known facts. It was probably with administration, and not policy, that Matthew was chiefly concerned. In one instance at least his advice was openly flouted. Coming to the throne by the death of his father on the 25th of August 1270, Philip began his reign by falling entirely under the influence of Pierre de la Brosse, who had been surgeon and valet-de-chambre to his father, upon whom he lavished lands and honours, making him lord (sieur) of Langeais, Châtillon-sur-Indre and Damville. Even Edward I. of England and William Dampierre, count of Flanders, strove to win his favour by gifts. But his fall was assured when Philip, who in 1271 lost his first wife, Isabella, daughter of James I., king of Aragon, married in 1274 Marie, daughter of Henry III., duke of Brabant. She was young and beautiful, and supplied a centre round which those who wished the downfall of the favourite grouped themselves. In June 1278 he was charged with various crimes, including one of poisoning the king's eldest son, and hanged at Montfaucon. His death left the parties of Marie, the queen, and Margaret, the queen-mother, to struggle for the mastery. The first subject of dispute was the inheritance of the count of Provence, Raymond-Bérenger IV., father of Margaret and of Eleanor, wife of Henry III. of England. Upon his death, in 1245, his youngest daughter, Beatrice, wife of Charles of Anjou, the king's uncle, succeeded to his lands, to the exclusion of her elder sisters, who claimed some portion of them for themselves. In 1281 war nearly broke out on this question. Margaret and her friends formed the league of Mâcon against Charles of Anjou, but the king managed to keep them at peace. The settlement of the claims of the king of England in Aquitaine by the treaty of Amiens in 1279 was a victory for the party of Margaret.

Agenais and southern Saintonge, which fell to the Crown by the death of Alfonso of Poitiers in 1276, as part of his vast possessions in Aquitaine and Languedoc, were ceded to Edward I. of England in accordance with the treaty of Paris 1259. Another portion of the heritage of Alfonso, the Venaisins, was ceded to the papacy to redeem an old promise. In general the strong will of Charles of Anjou directed Philip's policy. He secretly urged his nephew's candidature for the imperial crown, left vacant by the death of Richard of Cornwall, king of the Romans, in 1272, but without success. In May 1275 the party of Marie secured for Philip, the king's second son, the hand of Jeanne, the heiress of Navarre and Champagne, along with the guardianship of the kingdom of Navarre during the minority of Jeanne. But early in 1276 Jeanne's mother, Blanche, the widow of Henry III. of Navarre and Champagne, married Edmund, first earl of Lancaster, brother of Edward I.; and she and her English husband kept Champagne until, in 1284, Jeanne came of age.

An expedition of Philip against Castile in aid of the children of his sister, Blanche, proved abortive. Regardless of this warning, he was induced in 1284 to take up the quarrel of his

uncle Charles in Sicily, after the Sicilian Vespers in 1282. Two assemblies of barons and prelates were held at Bourges in November 1283 and February 1284 to deliberate on the question. This was a mere matter of form; Marie of Brabant and her party had decided the matter beforehand, and the crown of Aragon, which the French pope Martin IV. had declared forfeited by Peter, was accepted for Charles of Valois, Philip's third son. The project was strongly opposed by Matthew of Vendôme, who was in correspondence with the king of England on the subject. It was the first warlike expedition undertaken by the house of Capet outside France. It proved a disastrous failure. The French army laid siege to Gerona on the 26th of June 1285. The town surrendered on the 7th of September, but disease and the defeat of the fleet by the Aragonese navy at Las Farniguas Islands led to a retreat, during which, on the 5th of October, the king died. In the same month the garrison placed at Gerona surrendered. It is typical of Philip's character and career that he should die thus, in an expedition undertaken against the interests of his kingdom, at the instigation of his ambitious uncle.

Philip was twice married. On the 28th of May 1262 he married Isabella, daughter of James I., king of Aragon, who died in 1271. By her he had four children: Louis, who died in 1276; Philip, born in 1268; Charles of Valois, born on the 12th of March 1270; and Robert, who died young. By his second wife, Marie (d. 1322), daughter of Henry III. of Brabant, whom he married in 1274, he had three children: Louis, count of Evreux; Margaret, who married in 1299 Edward I., king of England; and Blanche, who married Rudolph III., duke of Austria.

See Ch. V. Langlois, *Le Règne de Philippe le Hardi* (Paris, 1887); and in E. Lavisse's *Histoire de France*, tome iii., ii. 113-117 (Paris, 1901); Fr. Walter, *Die Politik der Kaiser unter Gregor X.* (Berlin, 1894); Registers of Gregory X. and Nicholas III., published by the French school at Rome; R. Sternfeld, *Ludwigs des Heiligen Kreuzzug nach Tunis und die Politik Karls I. von Sizilien* (1896); P. Fournier, *Le Royaume d'Arles* (Paris, 1891). For complete bibliography of sources see A. Molinier, *Les Sources de l'histoire de France*, tome iii. 171-187 (Paris, 1903).

PHILIP IV. (1268-1314), called "*le Bel*" or "*the Fair*," king of France, was the son of Philip III. and his wife, Isabella of Aragon. His reign, which began in October 1285, is one of the most momentous in the history of medieval Europe, yet it belongs rather to the history of France and to that of the papacy than to the biography of the king. Little is known of the personal part played by Philip in the events associated with his name, and later historians have been divided between the view which regards him as a handsome, lethargic nonentity and that which paints him as a master of statecraft who, under a veil of phlegmatic indifference and pious sentiment, masked an inflexible purpose, of which his ministers were but the spokesmen and executors. The first view seems to be borne out by the language of contemporary chroniclers. To his enemy, Bernard Saisset, he was neither man nor beast, but a statue, "the handsomest man in the world, but unable to do anything but stare fixedly at people without saying a word." Guillaume de Nogaret, his minister, draws a far more flattering picture, enlarging on his charm, his amiability, his modesty, his charity to all men, and his piety; and the traits of this over-coloured portrait are more or less repeated by Yves, a monk of St Denis. There is, however, no word of any qualities of will or initiative. All of which suggests a personality mentally and physically phlegmatic, a suggestion strengthened by the fact that Bartholomæus de Neocastro (quoted by Wenck) describes him as corpulent in 1290.

Yet this was the king who with equal implacability brought the papacy under his yoke, carried out the destruction of the powerful order of the Temple, and laid the foundations of the national monarchy of France. In this last achievement Professor Finke finds the solution of a problem which Langlois had declared to be insoluble. In 1302, in the midst of a hostile assembly, Philip cursed his sons should they consent to hold the Crown of any one but God!; and in this isolated outburst he sees the key to his character. "Philip was not a man of violent initiative, the planner of daring and fateful operations; otherwise there

¹ Wenck, p. 49.

would have been some signs of it. His personality was that of a well-instructed, outwardly cold, because cool and calculating man, essentially receptive, afire for only one idea: the highest possible development of the French monarchy, internally and externally, as against both the secular powers and the Church. His merit was that he carried through this idea in spite of dangers to himself and to the state. A resolution once arrived at he carried out with iron obstinacy." Certainly he was no *roi saint*. His courage at the battle of Mons-en-Pévèle was the admiration of friend and foe alike. It was against the advice of his tutor, Aegidius Colonna, that on coming to the throne he chose as his counsellors men of the legal class, and the names of his great ministers—Guillaume de Nogaret, Enguerrand de Marigny, Pierre Flotte (d. 1302)—attest the excellent quality of his judgment. He was, too, one of the few monarchs who have left to their successors reasoned programmes of reform for the state.

The new materials from the Aragonese archives, published by Finke, give the same general impression of "uncanny" reticence on Philip's part; when other contemporary kings would have spoken he keeps silence, allowing his ministers to speak for him. Isolated passages in some of the Aragonese letters included in the collection, however, throw a new light on contemporary estimate of his character, describing him as all-powerful, as "pope and king and emperor in one person."¹

The reign of Philip IV. is of peculiar interest, because of the intrusion of economic problems into the spheres of national politics and even of religion. The increased cost of government and the growing wealth of the middle class, rather than the avarice of the king and the genius of his ministers, were responsible for the genesis and direction of the new order. The greatest event of the reign was the struggle with Pope Boniface VIII. (q.v.). The pope, in his opposition to the imposition of royal taxation upon the clergy, went so far in the bull *Clericis laicos* of 1296 as to forbid any lay authority to demand taxes from the clergy without his consent. When Philip retaliated by a decree forbidding the exportation of any coin from France, Boniface gave way to save the papal dues, and the bulls issued by him in 1297 were a decided victory for the French king. Peace between the two potentates followed until 1301. After the arrest, by Philip's orders, of Bernard Saisset (q.v.), bishop of Pamiers, in that year, the quarrel flamed up again; other causes of difference existed, and in 1302 the pope issued the bull *Unam sanctam*, one of the most extravagant of all statements of papal claims. To ensure the support of his people the king had called an assembly of the three estates of his kingdom at Paris in April 1302; then in the following year Guillaume de Nogaret seized the person of the pope at Anagni, an event immortalized by Dante. Boniface escaped from his captors only to die (October 11), and the short pontificate of his saintly successor, Benedict XI., was occupied in a vain effort to restore harmony to the Church. The conclave that met at Perugia on his death was divided between the partisans of the irreconcilable policy of Boniface VIII. and those of a policy of compromise with the new state theories represented by France. The election was ultimately determined by the diplomacy and the gold of Philip's agents, and the new pope, Clement V., was the weak-willed creature of the French king, to whom he owed the tiara. When in 1309 the pope installed himself at Avignon, the new relation of the papacy and the French monarchy was patent to the world. It was the beginning of the long "Babylonish captivity" of the popes. The most notable of its first-fruits was the hideous persecution of the Templars (q.v.), which began with the sudden arrest of the members of the order in France in 1307, and ended with the suppression of the order by Pope Clement at the council of Vienne in 1313.

It is now tolerably clear that Philip's motives in this sinister proceeding were lack of money, and probably the deliberate

wish to destroy a body which, with its privileged position and international financial and military organization, constituted a possible menace to the state. He had already persecuted and plundered the Jews and the Lombard bankers, and repeated recourse to the debasing of the coinage had led to a series of small risings. But under his rule something was done towards systematising the royal taxes, and, as in England, the financial needs of the king led to the association of the people in the work of government.

In 1294 Philip IV. attacked Edward I. of England, then busied with the Scottish War, and seized Guienne. Edward won over the counts of Bar and of Flanders, but they were defeated and he was obliged to make peace in 1297. Then the Flemish cities rose against the French royal officers, and utterly defeated the French army at Courtrai in 1302. The reign closed with the French position unimproved in Flanders, except for the transfer to Philip by Count Robert of Lille, Douai and Bèthune, and their dependencies. Philip died on the 29th of November 1314. His wife was Jeanne, queen of Navarre (d. 1304), through whom that country passed under the rule of Philip on his marriage in 1284; three of his sons, Louis X., Philip V. and Charles IV., succeeded in turn to the throne of France, and a daughter, Isabella, married Edward II. of England.

See the *Chronique* of Geoffrey of Paris, edited by M. Bouquet, in vol. xiii. of the *Recueil des historiens des Gaules et de la France*. Of modern works see E. Boutaric, *La France sous Philippe le Bel* (1861); G. Digard, *Philippe le Bel et le Saint-Siège* (1900); C. V. Langlois in E. Lavisse's *Histoire de France*, vol. iii. (1901); K. Wencik, *Philipp der Schöne von Frankreich* (Marburg, 1905); H. Finke, *Papsttum und Untergang des Templerordens*, 2 vols. (Münster i. W. 1907), esp. I. ch. ii.

PHILIP V. (c. 1294-1322), "the Tall," king of France, second son of Philip the Fair and Jeanne of Navarre, received the county of Poitiers as an appanage, and was affianced when a year old to Jeanne, daughter and heiress of Otto IV., count of Burgundy. The marriage took place in 1307 when he was thirteen years of age. When his elder brother, Louis X., died, on the 5th of July 1316, leaving his second wife, Clemence of Hungary, with child, Philip was appointed regent for eighteen years by the parliament of Paris, even in the event of a male heir being born. Clemence's son, born on the 15th of November, lived only four days, and Philip immediately proclaimed himself king, though several of the great barons declared that the rights of Jeanne, daughter of Louis X. by his first wife, Margaret of Burgundy, ought to be examined before anything else was done. The coronation at Reims, on the 9th of January 1317, took place with the gates of the city closed for fear of a surprise. The states-general of the 2nd of February 1317, consisting of the nobles, prelates, and the burgesses of Paris, approved the coronation of Philip, swore to obey him, and declared that women did not succeed to the Crown of France. The university of Paris approved this declaration, but its members did not take the oath. The Salic law was not involved, and it was later that the lawyers of the 14th century tried to connect this principle to an article of the Salic law, which accords inheritance in land (*i.e.* property) to males. In the Frankish law the article refers to private property, not to public law. The death of Philip's son Louis, in 1317, disarmed the opposition of Charles, count of La Marche, who now hoped to succeed to the Crown himself. Odo or Eudes IV., duke of Burgundy, was married to Jeanne, Philip's daughter, and received the county of Burgundy as her dower. The barons all did homage except Edward II. of England, and Philip's position was secured. The war with Flanders, which had begun under Philip IV. the Fair, was brought to an end on the 2nd of June 1320. The revolt of the Pastoureaux who assembled at Paris in 1320 to go on a crusade was crushed by the seneschal of Carcassonne, whither they marched. One of the special objects of their hatred, the Jews, were also mulcted heavily by Philip, who extorted 150,000 livres from those of Paris alone. He died at Longchamp on the night of the 2nd of January 1322.

Philip was a lover of poetry, surrounded himself with Provençal poets and even wrote in Provençal himself, but he was also one of the most hard-working kings of the house of Capet. The

¹ Finke, ii. no. 78, p. 122. Anon. to the commanderies of Gardeyne and Aacho: "Pus el es rey et papa et emperador! Car tot lo mon sap, quel papa no es negun et que el fa tot ço ques vol del papa et de la esglia."

insecurity of his position made him seek the support of national assemblies and of provincial estates. His reign in some ways resembled that of Edward I. of England. He published a series of ordinances organizing the royal household and affecting the financial administration, the "parlement" and the royal forests. He abolished all garrisons in the towns except those on the frontier and provided for public order by allowing the inhabitants of his towns to arm themselves under the command of captains. He tried hard to procure a unification of coinage and weights and measures, but failed owing to the opposition of the estates, who were afraid of the new taxation necessary to meet the loss involved in raising the standard of the coinage, and who held to their local measures and currency partly from conservatism, partly as a relic of local liberty. Philip as a reformer was in many ways before his time, but his people failed to understand him, and he died under the reproach of extortion.

See P. Lohéac, *Histoire de Philippe le Long* (Paris, 1897); E. Lavisse, *Histoire de France* (Tome III, 2); and sources indicated in A. Molinier, *Répertoire des sources de l'histoire de France* (Paris, 1903).

PHILIP VI. (1293-1350), king of France, was the son of Charles of Valois, third son of Philip III., the Bold, and of Margaret of Sicily, and was thus the nephew of Philip IV., the Fair, whose sons, Louis X., Philip V. and Charles IV., died successively without leaving male heirs. He succeeded to the throne on the death of his cousin, Charles IV., in 1328. Before his accession Philip had enjoyed considerable influence, for he was count of Valois, Anjou, Maine, Chartres and Alençon. He had married in 1313 Jeanne (d. 1348), daughter of Robert II. of Burgundy, a determined woman who was long known as the real ruler of France. An expedition to Italy in 1319-20 against Galéas Visconti brought him little glory; he was more successful in a small expedition to Guienne, undertaken against a revolted vassal who was supported by the English.

When Charles IV. died, in February 1328, his wife was enceinte, and it became necessary to appoint a regency until the birth of the child, who would, if a son, succeed to the throne. At the assembly of barons called to choose a regent, Edward III. of England, the nephew and nearest male relation of Charles IV., put in a claim. Edward III., however, descended from the royal house of France by his mother Isabel, and the barons, probably actuated by an objection to the regency of an English king, decided that neither a woman, "nor by consequence her son, could succeed to the kingdom of France," and Philip of Valois, in spite of his belonging to a junior branch of the family, was elected regent. On the birth of a girl to the queen widow the regency naturally led to the throne of France, and Philip was crowned at Reims on the 29th of May 1328. Navarre had not accepted the regency, that kingdom being claimed by her husband for Jeanne, countess of Evreux, the eldest daughter of Louis X., the count of Evreux himself being, like Philip of Valois, a grandson of Philip the Bold. The new king secured the friendship of the count by allowing Jeanne's claim to Navarre, in return for a renunciation of any right to Champagne. Edward III. of England, after more than one citation, tendered verbal homage for part of Guienne at Amiens in 1329, but he declined to place his hands between those of Philip VI., and thus formally to acknowledge him as his liege lord. Two years later, however, he forwarded the acknowledgment by letters patent. Meanwhile Philip VI. had won a victory, which he turned into a massacre, at Cassel (August 23, 1328) over Bruges and the other towns of West Flanders, which under the leadership of Jakob van Artevelde had thrown off the authority of their count, Louis of Nevers. The count of Flanders was reinstated, and maintained his authority by a reign of terror.

Much harm was done to Philip VI.'s authority by the scandal arising out of the prosecution of Robert of Artois, count of Beaumont, who was the king's brother-in-law. The count had presented to the parlement of Paris forged deeds in support of his claim to the county of Artois, held by his aunt, Mahaut, countess of Burgundy. The sudden death of Mahaut, and of her daughter and heiress, Jeanne, widow of Philip V., lent colour

to other suspicions, and Robert was driven from France and his goods confiscated. He found refuge, first in Brabant and then at the English court, where he was received as a relative and a victim of false accusations.

Philip VI. enjoyed powerful alliances. In Italy he was allied with his uncle, Robert of Anjou, king of Sicily, and with his former enemy, Galéas Visconti; in the north with the duke of Brabant and the princes of the Netherlands; on the east with the reigning princes of Lorraine and Savoy; with the king of Bohemia and with Pope John XXII. at Avignon, and his successor, Benedict XII. In 1336 it seemed that the Crusade, for which Philip VI. had long been preparing, would at last start; but the relations with Edward III. of England, which had always been strained, became worse, and within a year France was embarked on the struggle of the Hundred Years' War. The causes which led to war, the conflict for commercial supremacy in Flanders, disputed rights in Guienne, the help given by France to the Scots, and the unnatural situation of an English king who was also a vassal of the French Crown are dealt with elsewhere (see FRANCE: History). The immediate rupture in Flanders was due chiefly to the tyranny of the count of Flanders, Louis of Nevers, whom Philip VI. had reinstated. Edward III. had won over most of Philip's German and Flemish allies, and the English naval victory at Sluys (June 24, 1340), in which the French fleet was annihilated, effectually restored English preponderance in Flanders. A truce followed, but this was disturbed after a short duration by the disputed succession to the duchy of Brittany. Edward III. supported John of Montfort; Philip IV. his own nephew, Charles of Blois. A truce made at Malestroit in 1343 at the invitation of the pope, was rudely broken by Philip's violence. Olivier de Clisson, who with fourteen other Breton gentlemen, was suspected of intrigue with Edward III., was invited to a great tournament in Paris. On their arrival they were seized by Philip's orders, and without form of trial beheaded. Then followed Edward III.'s invasion of Normandy and the campaign of Crecy (1346). Philip's army was destroyed; he himself was wounded and fled from the field. He sought in vain to divert Edward from the siege of Calais by supporting the Scots in their invasion of England; but eventually a truce was arranged, which lasted until 1351. Philip VI. died at Nogent-le-roi on the 12th of August 1350.

Philip VI. met his necessities by the imposition of the hated gabelle or salt tax, which was invented by his legal advisers. The value of the coinage fluctuated continuously, to the great hindrance of trade; and although at a meeting of the States-General it was asserted that the king could levy no extraordinary taxes without the consent of the estates, he obtained heavy subsidies from the various provinces. Towards the close of his reign he acquired from Humbert II., comte de Vienne, the province of Dauphiné, and Montpellier from the king of Majorca. These acquisitions made the ultimate annexation of Provence a certainty. Philip married a second wife, Blanche of Navarre. By his first wife he left two sons—his successor, John II., and Philip of Orleans, count of Valois.

See *Continuations de la chronique de Guillaume de Nangis* edited in 1843 by Céraud for the Soc. de l'hist. de France; *Grandes chroniques de Saint Denis*, vol. v. (1837), edition by Paulin Paris; E. Dèprez, *Les Préliminaires de la guerre de cent ans, 1328-1342* (Paris, 1902), based on texts from the English Record Office and the Vatican; Paul Viollet, *Histoire des institutions politiques de la France* vol. II. (Paris, 1898); and E. Lavisse, *Hist. de France*, vol. IV. pt. I. (1902), by A. Colville. Further references will be found in Nos. 3095-3112 and 3165-3240 of A. Molinier's *Sources de l'histoire de France*, vol. IV. (Paris, 1904).

PHILIP (c. 1177-1208), German king and duke of Swabia, the rival of the emperor Otto IV., was the fifth and youngest son of the emperor Frederick I. and Beatrix, daughter of Renaud III., count of Upper Burgundy, and consequently brother of the emperor Henry VI. He entered the church, was made provost of Aix-la-Chapelle, and in 1190 or 1191 was chosen bishop of Würzburg. Having accompanied his brother Henry to Italy in 1191, Philip forsook his ecclesiastical calling, and, travelling again to Italy, was made duke of Tuscany in 1195 and received

an extensive grant of lands. In 1196 he became duke of Swabia, on the death of his brother Conrad; and in May 1197 he married Irene, daughter of the eastern emperor, Isaac Angelus, and widow of Roger II., king of Sicily, a lady who is described by Walther von der Vogelweide as "the rose without a thorn, the dove without guile." Philip enjoyed his brother's confidence to a very great extent, and appears to have been designated as guardian of the young Frederick, afterwards the emperor Frederick II., in case of his father's early death. In 1197 he had set out to fetch Frederick from Sicily for his coronation when he heard of the emperor's death and returned at once to Germany. He appears to have desired to protect the interests of his nephew and to quell the disorder which arose on Henry's death, but events were too strong for him. The hostility to the kingship of a child was growing, and after Philip had been chosen as defender of the empire during Frederick's minority he consented to his own election. He was elected German king at Mühlhausen on the 8th of March 1198, and crowned at Mainz on the 8th of September following. Meanwhile a number of princes hostile to Philip, under the leadership of Adolph, archbishop of Cologne, had elected an anti-king in the person of Otto, second son of Henry the Lion, duke of Saxony. In the war that followed, Philip, who drew his principal support from south Germany, met with considerable success. In 1199 he received further accessions to his party and carried the war into his opponent's territory, although unable to obtain the support of Pope Innocent III., and only feebly assisted by his ally Philip Augustus, king of France. The following year was less favourable to his arms; and in March 1201 Innocent took the decisive step of placing Philip and his associates under the ban, and began to work energetically in favour of Otto. The two succeeding years were still more unfavourable to Philip. Otto, aided by Ottakar I., king of Bohemia, and Hermann I., landgrave of Thuringia, drove him from north Germany, thus compelling him to seek by abject concessions, but without success, reconciliation with Innocent. The submission to Philip of Hermann of Thuringia in 1204 marks the turning-point of his fortunes, and he was soon joined by Adolph of Cologne and Henry I., duke of Brabant. On the 6th of January 1205 he was crowned again with great ceremony by Adolph at Aix-la-Chapelle, though it was not till 1207 that his entry into Cologne practically brought the war to a close. A month or two later Philip was loosed from the papal ban, and in March 1208 it seems probable that a treaty was concluded by which a nephew of the pope was to marry one of Philip's daughters and to receive the disputed dukedom of Tuscany. Philip was preparing to crush the last flicker of the rebellion in Brunswick when he was murdered at Bamberg, on the 21st of June 1208, by Otto of Wittelsbach, count palatine in Bavaria, to whom he had refused the hand of one of his daughters. He left no sons, but four daughters; one of whom, Beatrix, afterwards married his rival, the emperor Otto IV. Philip was a brave and handsome man, and contemporary writers, among whom was Walther von der Vogelweide, praise his mildness and generosity.

See W. von Giesebrecht, *Geschichte der deutschen Kaiserzeit*, Bd. V. (Leipzig, 1888); E. Winkelmann, *Philipp von Schwaben und Otto IV. von Braunschweig* (Leipzig, 1873-1878); O. Abel, *König Philipp der Hohenstaufen* (Berlin, 1852); *Regesta imperii*, V., edited by J. Ficker (Innsbruck, 1881); R. Schwemer, *Innocenz III. und die deutsche Kirche während des Thronstreites von 1198-1208* (Straßburg, 1882); and R. Riant, *Innocent III., Philippe de Souabe, et Boniface de Montferrat* (Paris, 1875).

PHILIP I., the Handsome (1478-1506), king of Spain, son of the emperor Maximilian I., and husband of Joanna the Mad, daughter of Ferdinand and Isabella, was the founder of the Habsburg dynasty in Spain, and was born at Bruges on the 22nd of July 1478. In 1482 he succeeded to the Burgundian possessions of his mother Mary, daughter of Charles the Bold, under the guardianship of his father. In 1496 he married Joanna. The marriage was one of a set of family alliances with Austria and Portugal designed to strengthen Spain against France. The death of John, the only son of Ferdinand and Isabella, opened the succession to the Spanish Crown to Joanna. In

1502 she and her husband received the homage of the cortes of Castile and of Aragon as heirs. Philip returned to Flanders before the close of the year. His life with Joanna was rendered extremely unhappy by his infidelity and by her jealousy, which, working on a neurotic temperament, precipitated her insanity. The princess gave way to paroxysms of rage, in which she was guilty of acts of atrocious violence. Before her mother's death, in 1504, she was unquestionably quite insane, and husband and wife lived apart. When Isabella died, Ferdinand endeavoured to lay hands on the regency of Castile, but the nobles, who disliked and feared him, forced him to withdraw. Philip was summoned to Spain, where he was recognized as king. He landed, with his wife, at Corunna on the 28th of April 1506, accompanied by a body of German mercenaries. Father and son-in-law had interviews at Remesal, near Pueblo de Senabria, and at Renedo, the only result of which was an indecent family quarrel, in which Ferdinand professed to defend the interests of his daughter, who he said was imprisoned by her husband. A civil war would probably have broken out between them; but Philip, who had only been in Spain long enough to prove his incapacity, died suddenly at Burgos, apparently of typhoid fever, on the 25th of September 1506. His wife refused for long to allow his body to be buried or to part from it. Philip was the father of the emperors Charles V. and Ferdinand I.

PHILIP II. (1527-1598) king of Spain, was born at Valladolid on the 21st of May 1527. He was the son of the emperor Charles V., and of his wife Isabella of Portugal, who were first cousins. Philip received his education in Spain. His tutor, Dr Juan Martínez Pedernales, who latinized his name to Siliceo, and who was also his confessor, does not appear to have done his duty very thoroughly. The prince, though he had a good command of Latin, never equalled his father as a linguist. Don Juan de Zufiga, who was appointed to teach him the use of arms, was more conscientious; but he had a very poor pupil. From his earliest years Philip showed himself more addicted to the desk than the saddle and to the pen than to the sword. The emperor, who spent his life moving from one part of his wide dominions to another and in the camps of his armies, watched his heir's education from afar. The trend of his letters was to impress on the boy a profound sense of the high destinies to which he was born, the necessity for keeping his nobles apart from all share in the conduct of the internal government of his kingdom, and the wisdom of distrusting counsellors, who would be sure to wish to influence him for their own ends. Philip grew up grave, self-possessed and distrustful. He was beloved by his Spanish subjects, but utterly without the power of attracting men of other races. Though accused of extreme licentiousness in his relations with women, and though he lived for years in adultery with Doña Maria de Osorio, Philip was probably less immoral than most kings of his time, including his father, and was rigidly abstemious in eating and drinking. His power of work was unbounded, and he had an absolute love of reading, annotating and drafting despatches. If he had not become sovereign of the Low Countries, as heir of Mary of Burgundy through his father, Philip would in all probability have devoted himself to warfare with the Turks in the Mediterranean, and to the conquest of northern Africa. Unhappily for Spain, Charles, after some hesitation, decided to transmit the Netherlands to his son, and not to allow them to go with the empire. Philip was summoned in 1548 to Flanders, where he went unwillingly, and was ill regarded. In 1551 he was back in Spain, and intrusted with its government. In 1543 he had been married to his cousin Mary of Portugal, who bore him a son, the unhappy Don Carlos, and who died in 1545. In 1554, when Charles was meditating his abdication, and wished to secure the position of his son, he summoned Philip to Flanders again, and arranged the marriage with Mary, queen of England, who was the daughter of his mother's sister, in order to form a union of Spain, the Netherlands and England, before which France would be powerless. The marriage proved barren. The abdication of his father on the 16th of January 1556 constituted Philip sovereign of Spain with its American possessions, of the Aragonese inheritance

in Italy, Naples and Sicily, of the Burgundian inheritance—the Netherlands and Franche Comté, and of the duchy of Milan, which his father separated from the empire for his benefit. It was a legacy of immense responsibilities and perils, for France was bound in common prudence to endeavour to ruin a power which encircled her on every side save the sea and threatened her independence. France was for a time beaten at the battles of St Quentin and Gravelines, and forced to make the Peace of Cateau Cambresis (April 2, 1559). But the death of Mary of England on the 17th of November 1558 had deprived Philip of English support. The establishment of Elizabeth on the English throne put on the flank of his scattered dominions another power, forced no less than France by unavoidable political necessities to be his enemy. The early difficulties of Elizabeth's reign secured him a deceitful peace on that side for a time. His marriage with Elizabeth of Valois on the 22nd of June 1559, and the approach of the wars of religion; gave him a temporary security from France. But the religious agitation was affecting his own Flemish possessions, and when Philip went back to Spain, in August 1559, he was committed to a life-long struggle in which he could not prove victorious except by the conquest of France and England.

If Philip II. had deserved his name of the Prudent he would have made haste, so soon as his father, who continued to intervene in the government from his retreat at Yuste in Estremadura, was dead, to relieve himself of the ruinous inheritance of the Low Countries. It was perhaps impossible for him to renounce his rights, and his education, co-operating with his natural disposition, made it morally impossible for him to believe that he could be in the wrong. Like the rest of his generation, he was convinced that unity of religion was indispensable to the maintenance of the authority of the State and of good order. Family pride, also, was carried by him to its highest possible pitch. Thus external and internal influences alike drove him into conflict with the Netherlands, France and England; with the first because political and religious discontent combined to bring about revolt, which he felt bound in duty to crush; with thesecond and third because they helped the Flemings and the Hollanders. The conflict assumed the character of a struggle between Protestantism and Roman Catholicism, in which Philip appeared as the champion of the Church. It was a part he rejoiced to play. He became, and could not but become, a persecutor in and out of Spain; and his persecutions not only hardened the obstinacy of the Dutch, and helped to exasperate the English, but they provoked a revolt of the Moriscos, which impoverished his kingdom. No experience of the failure of his policy could shake his belief in its essential excellence. That whatever he did was done for the service of God, that success or failure depended on the inscrutable will of the Almighty and not on himself, were his guiding convictions, which he transmitted to his successors. The "service of God and his majesty" was the formula which expressed the belief of the sovereign and his subjects. Philip must therefore be held primarily responsible for the insane policy which brought Spain to ruin. He had a high ideal of his duty as a king to his own people, and had no natural preference for violent courses. The strong measures he took against disorderly elements in Aragon in 1561 were provoked by extreme misconduct on the part of a faction. When he enforced his claim to the crown of Portugal (1579–1581) he preferred to placate his new subjects by paying attention to their feelings and their privileges. He even made dangerous political concessions to secure the support of the gentry. It is true that he was ready to make use of assassination for political purposes; but he had been taught by his lawyers that he was "the prince," the embodied state, and as such had a right to act for the public good, *legibus solutus*. This was but in accordance with the temper of the times. Coligny, Lord Burghley and William the Silent also entered into murder plots. In his private life he was orderly and affectionate to his family and servants. He was slow to withdraw the confidence he had once given. In the painful episode of the imprisonment and death of his firstborn son, Don Carlos, Philip behaved honourably. He bore the acute agony of the disease which

killed him with manly patience, and he died piously at the Escorial on the 13th of September 1598.

As an administrator Philip had all the vices of his type, that of the laborious, self-righteous man, who thinks he can supervise everything, is capable of endless toil, and jealous of his authority, and who therefore will let none of his servants act without his instructions. He set the example of the unending discussions in committee and boundless minute writing which finally choked the Spanish administration.

The *Histoire de Philippe II.* of M. H. Forneron (Paris, 1881), contains many references to authorities and is exhaustive, but the author has some violent prejudices. *Philip II.*, by Martin Hume (London, 1897), is more just in its treatment of Philip's personal character, and gives a useful bibliography. The main sources for the political history are the *Documentos Inéditos para la historia de España* (Madrid, 1842, &c.), vols. i., iii., vi., vii., xv., xxi., xxiv., xl., xcviii., ci., ciii., cx., cxi. and others; L. P. Gachard, *Actes des états généraux des Pays Bas, 1576–1585* (Brussels, 1861–1866); and the *Calendars of State Papers, Foreign Series, Elizabeth* (London, 1863–1901). See also Martin Hume, *Two English Queens and Philip* (1908).

PHILIP III. (1578–1621), king of Spain, son of Philip II. and his fourth wife, Anne, daughter of the emperor Maximilian II., was born at Madrid on the 14th of April 1578. He inherited the beliefs of his father, but no share of his industry. The old king had sorrowfully confessed that God had not given him a son capable of governing his vast dominions, and had foreseen that Philip III. would be led by his servants. This calculation was exactly fulfilled. The new king put the direction of his government entirely into the hands of his favourite, the duke of Lerma, and when he fell under the influence of Lerma's son, the duke of Uceda, in 1598, he trusted himself and his states to the new favourite. The king's own life was passed amid court festivities, on which enormous sums of money were wasted, or in the practice of childish piety. It was said that he was so virtuous as hardly to have committed a venial sin. He cannot be justly blamed for having been born to rule a despotic monarchy, without even the capacity which would have qualified him to manage a small estate. He died at Madrid on the 31st of March 1621. The story told in the memoirs of the French ambassador Bassompierre, that he was killed by the heat of a *brassero* (a pan of hot charcoal), because the proper official to take it away was not at hand, is a humorous exaggeration of the formal etiquette of the court.

R. Watson and W. Thompson, *History of Philip III.* (1796), give the most available general account of his reign; see also the continuation of Mariana's *History of Spain* by Miñana (Madrid, 1817–1822).

PHILIP IV. (1605–1665), king of Spain, eldest son of Philip III. and his wife Margaret, sister of the emperor Ferdinand II., was born at Valladolid on the 8th of April 1605. His reign, after a few passing years of barren successes, was a long story of political and military decay and disaster. The king has been held responsible for the fall of Spain, which was, however, due in the main to internal causes beyond the control of the most despotic ruler, however capable he had been. Philip certainly possessed more energy, both mental and physical, than his father. There is still in existence a translation of Guicciardini which he wrote with his own hand in order to qualify himself for government by acquiring a knowledge of political history. He was a fine horseman and keen hunter. His artistic taste was shown by his patronage of Velasquez, and his love of letters by his favour to Lope de Vega, Calderon, and other dramatists. He is even credited, on fairly probable testimony, with a share at least in the composition of several comedies. His good intentions were of no avail to his government. Coming to the throne at the age of sixteen, he did the wisest thing he could by allowing himself to be guided by the most capable man he could find. His favourite, Olivares, was a far more honest man than the duke of Lerma, and was more fit for the place of prime minister than any Spaniard of the time. But Philip IV. had not the strength of mind to free himself from the influence of Olivares when he had grown to manhood. The amusements which the favourite had encouraged became the business of the

king's life. When, in 1643, the disasters falling on the monarchy on all sides led to the dismissal of Olivares, Philip had lost the power to devote himself to hard work. After a brief struggle with the task of directing the administration of the most extensive and the worst organized monarchy in Europe, he sank back into his pleasures and was governed by other favourites. His political opinions were those he had inherited from his father and grandfather. He thought it his duty to support the German Habsburgs and the cause of the Roman Catholic Church against the Protestants, to assert his sovereignty over Holland, and to extend the dominions of his house. The utter exhaustion of his people in the course of a hopeless struggle with Holland, France and England was seen by him with sympathy, but he considered it an unavoidable misfortune and not the result of his own errors, since he could not be expected to renounce his rights or to desert the cause of God and the Church. In public he maintained a bearing of rigid solemnity, and was seen to laugh only three times in the course of his life. But in private he indulged in horseplay and very coarse immorality. His court was grossly vicious. The early death of his eldest son, Baltasar Carlos, was unquestionably due to debauchery encouraged by the gentlemen entrusted by the king with his education. The lesson shocked the king, but its effect soon wore off. Philip IV. died broken-hearted on the 17th of September 1665, expressing the hope that his surviving son, Carlos, would be more fortunate than himself.

The best accounts of Philip IV. will be found in the *Estudios del reinado de Felipe IV.*, by Don A. Cánovas del Castillo (Madrid, 1889), and in the introduction by Don F. Silveira to his edition of the *Cartas de Sor Maria de Agreda y del rey Felipe IV.* (Madrid, 1885-1886).

PHILIP V. (1683-1746), king of Spain, founder of the present Bourbon dynasty, was the son of the Dauphin Louis and his wife, Maria Anna, daughter of Ferdinand Maria, elector of Bavaria. He was born at Versailles on the 19th of December 1683. On the extinction of the male line of the house of Habsburg in Spain he was named heir by the will of Charles II. He had shared in the careful education given to his elder brother, Louis, duke of Burgundy, by Fénelon, and was himself known as duke of Anjou. Philip was by nature dull and phlegmatic. He had learnt morality from Fénelon's teaching, and showed himself throughout his life strongly adverse to the moral laxity of his grandfather and of most of the princes of his time. But his very domestic regularity caused him to be entirely under the influence of his two wives, Maria Louisa of Savoy, whom he married in 1702, and who died in February 1714, and Elizabeth Farnese of Parma, whom he married in December of the same year, and who survived him. He showed courage on the field of battle, both in Italy and Spain, during the War of the Spanish Succession, and was flattered by his courtiers with the title of *El Asinero*, or the spirited. But he had no taste for military adventure. If he had a strong passion, it was to provide for his succession to the throne of France, if his nephew, Louis XV., should die, and he indulged in many intrigues against the house of Orleans, whose right to the succession was supposed to be secured by Philip's solemn renunciation of all claim to the French throne, when he became king of Spain. It was in pursuit of one of these intrigues that he abdicated in 1724 in favour of his son Louis. But Louis died in a few months, and Philip returned to the throne. At a later period he tried to abdicate again, and his wife had to keep him in a species of disguised confinement. Throughout his life, but particularly in the later part of it, he was subject to prolonged fits of melancholia, during which he would not even speak. He died of apoplexy on the 9th of July 1746.

The best account of Philip's character and reign is still that given by Coxe in his *Memoirs of the Kings of Spain of the House of Bourbon* (London, 1815).

PHILIP THE BOLD (1342-1404), duke of Burgundy, fourth son of John II. of France and Bonne of Luxemburg, was born on the 15th of January 1342. He earned his surname by his bravery while fighting by his father's side on the field of Poitiers. After the defeat of King John he accompanied him into captivity

in England. In 1360 he received the title of duke of Touraine, and in June 1363 was entrusted with the government of Burgundy, which John had united to the crown at the death of the last duke of the Capetian family, Philip of Rouvre, in 1361. In September 1363 John bestowed on Philip the title of duke of Burgundy, together with that of first peer of France. John was anxious not to displease the Burgundians, who were accustomed to their independence; and, moreover, with Philip as duke of Burgundy he was in a better posture to resist the king of Navarre, Charles the Bad, who laid claim to the duchy. The donation, which was at first kept secret in spite of a request made in 1363 for its confirmation by the emperor Charles IV., was ratified at the accession of Charles V. of France; but in consequence of Philip's preoccupation with the Grand Companies, which had invaded France, it was not until November 1364 that he definitely took possession of the duchy. Charles continued to show favour to his brother, appointing him (in 1366) his lieutenant in Champagne and marrying him to Margaret, daughter and heiress of Louis of Mâle, count of Flanders, and widow of Philip of Rouvre. Edward III. of England was negotiating for the marriage of his princess with his son Edmund, earl of Cambridge; but Charles prevailed upon Pope Urban V. to refuse the dispensation necessary on grounds of kinship, and even consented to give up Lille, Douai and Orchies to Flanders on condition that Margaret should marry his brother. Philip eventually won the day, thanks to the support of the late count's mother, and the marriage took place with high revel at Ghent on the 19th of June 1369.

During the succeeding years Philip proved a faithful ally to Charles. He took part in the almost bloodless campaign against the duke of Lancaster, who had landed at Calais; in 1377 he took several towns in French Flanders from the English; and in 1379 relieved Troyes, which had been besieged by the English. On Charles's death Philip found himself, with his brothers, the dukes of Anjou and Berry, in charge of the government of France in the name of Charles VI., who was a minor; and in the absence of the duke of Anjou, who left France in 1382 to conquer the kingdom of Naples, Philip occupied the most powerful position in the realm. He persuaded the young king to intervene in Flanders, where the citizens of Ghent, whose rebellious spirit had necessitated Philip's intervention in 1379, had again revolted under Philip van Artevelde and had expelled Louis of Mâle. On the 27th of November 1382 the Franco-Burgundian chivalry crushed the rebels at Rosebeke, and on his return the duke of Burgundy took part in repressing the popular movements which had broken out in Paris and other French towns. In 1383 an insurrection in Flanders supported by England gave rise to another French expedition; but in January 1384 the death of Louis of Mâle made Philip master of the countships of Flanders, Artois, Rethel and Nevers; and in the following year the citizens of Ghent decided to submit. At this period Philip sought to ingratiate himself with the emperor, who was a near neighbour, and of whom he held a part of his dominions, by giving two of his daughters in marriage to two princes of the house of Bavaria; he also took an important part in bringing about the marriage of a princess of the same family, Isabel, to King Charles VI.

Hostilities, however, were renewed between France and England. A formidable expedition was prepared under the direction of the duke of Burgundy, and a fleet of 1400 sail assembled at Sluys; but the enterprise failed owing to the dilatoriness of the duke of Berry. The fatiguing and inglorious expedition in the Netherlands, into which the duke dragged Charles for the purpose of supporting his kinswoman, Joan of Brabant, against the duke of Gelderland, shook Philip's credit with his nephew, who on his return declared himself of age and confided the government to the ancient councillors of his father, the "Marmousets." The king's madness (1392) restored his uncles to power, and particularly Philip, who after assuring peace by treating with the duke of Brittany and by concluding a truce of twenty-eight years with England, made strenuous efforts to put an end to the Great Schism, visiting Pope Benedict XIII.

at Avignon in 1395 in the hope of obtaining a voluntary resignation from him. But the growing influence of the king's brother, Louis of Orleans, who was on terms of great intimacy with Queen Isabel and was accused of being her lover, was a serious obstruction. Discord broke out in the council, and but for the intervention of the dukes of Berry and Bourbon the two princes would have come to an open struggle. For a brief period Philip was dispossessed of authority, but he regained it in 1402 and kept it till his death, which took place on the 27th of April 1404. The cathedral of St Bénigne at Dijon contains his remains, and his tomb (formerly in the Chartreuse of Dijon) is now in the museum in the Hôtel-de-ville.

Although he had to curb the independent spirit of the seigneurs of Franche-Comté, and in spite of frequent collisions with his vassals in Flanders and with the citizens of Besançon (who in 1386 extracted from him a promise to respect their privileges), Philip appears to have governed his territories with sagacity and a certain moderation, and he was particularly successful in employing the resources of France in the interests of Burgundy. He granted numerous privileges to the inhabitants of Dijon, and created in 1386 two *chambres des comptes*, one at Dijon and the other at Lille. He was, in the phrase of a contemporary, "kindly and amiable to high and low and those of middle rank, liberal as an Alexander, noble and pontifical, in court and state magnificent." But his liberality and his love of display involved him in enormous expense, and he left so many debts that his widow was compelled to renounce her personal estate to avoid the responsibility of discharging them. By his wife Margaret (d. 1405) he had a numerous family: John the Fearless, who succeeded him; Charles and Louis, who both died in infancy; Anthony, count of Rethel, and Philip, count of Nevers, both killed at Agincourt; Margaret, who married William of Bavaria, count of Ostrevant; Catherine, wife of Leopold, duke of Austria; Mary, wife of Amadeus VIII. of Savoy; and Bonne, who was betrothed to John of Bourbon and died young.

(R. Po.)

PHILIP THE GOOD (1396-1467), duke of Burgundy, son of John the Fearless, duke of Burgundy, and Margaret of Bavaria, was born at Dijon on the 13th of June 1396, and succeeded his father on the 10th of September 1419. The natural outcome of the assassination of John the Fearless (*q.v.*) was to drive his successor to the English side. In 1419 Philip signed with Henry V. of England the treaty of Arras, by which he recognized Henry as regent and future heir of the kingdom of France, and in 1420 gave his adherence to the treaty of Troyes. Early in December 1420 Philip entered Paris with the king of England, and subsequently took part in the defeat of the French at Mons-en-Vimeu. By a treaty concluded by Philip at Amiens in April 1423 with the dukes of Brittany and Bedford, John, duke of Bedford, married Philip's sister Anne, and Arthur of Brittany, earl of Richmond, became the husband of Philip's sister Margaret. A few years later discord arose among the allies. When the duke of Bedford besieged Orleans the inhabitants offered to surrender, but to the duke of Burgundy; whereupon Bedford retorted that "he did not beat the bushes for others to take the birds." When this speech reached Philip's ears he withdrew his troops in dudgeon, and concluded a truce with France (1429). Bedford, however, succeeded in conciliating him by promises and presents, and in 1430 Philip took part in the campaign against Compiègne.

But another conflict arose between the duke of Burgundy and the English. Jacqueline, countess of Hainaut, the divorced wife of the duke of Brabant and the heiress of Holland and Zealand, had married the duke of Gloucester, who attempted to take forcible possession of his wife's territories. Philip, however, himself claimed Brabant as having been bequeathed to him by his cousin Philip, the late duke, with the result that the Burgundians repulsed the troops of the duke of Gloucester, and Jacqueline was forced to recognize the duke of Burgundy as her lieutenant and heir. Moreover, the duchess of Bedford had died in 1433. Charles VII., who in spite of the efforts of the cardinal of Ste-Croix and the conferences held by him at

Auxerre and Semur had hitherto refused to return to France, finally decided to take part in the conferences which were opened at St Vaast d'Arras on the 6th of August 1435, and to which the whole of Christendom attached very high importance, all the princes of Europe and the pope and the council of Basel being represented. Philip consented to a reconciliation with the king of France, and agreed to recognize him as his legitimate sovereign on condition that he should not be required to pay him homage during his lifetime. Charles, on his part, solemnly craved pardon for the murder of John the Fearless through the mouth of the dean of the church in Paris, and handed over to the duke the counties of Mâcon, Auxerre, Bar-sur-Seine and Ponthieu, and the towns on and near the Somme (Roye, Montdidier, Péronne), reserving the option of redeeming the Somme towns for 400,000 gold crowns. Philip proved a faithful ally of the king, aiding him in re-entering Paris and preparing an expedition against Calais, which, however, failed through the ill-will of his Flemish subjects (1436). In 1440 he paid the ransom of Charles of Orleans (the son of his father's old enemy), who had been a prisoner in England since the battle of Agincourt; received him with great honour at Gravelines; and married him to Mary of Cleves, upon whom he bestowed a handsome dowry. In 1442 Philip entered into a conspiracy to give the duke of Orleans a larger share in the affairs of the kingdom. To René of Anjou, the duke of Lorraine, he showed himself less generous, setting up another claimant to the duchy of Lorraine in the person of Anthony of Vaudemont, and taking René prisoner in 1437; it was not until 1436 that he consented definitively to release René on condition that he should abandon several strong places and pay an enormous ransom. In 1445, at the conferences of Châlons-sur-Marne, the duchess of Burgundy renounced these claims in her husband's name in order to assure the execution of the treaty of Arras.

Philip was frequently disturbed by the insubordination of the Flemish communes. He had to quell seditions at Liège (1430), Ghent (1432) and Antwerp (1435). In 1438 he was driven with the duchess out of Bruges by the revolted citizens, a revolt which he repressed with great severity. In 1448 the citizens of Ghent rose in rebellion, but, disappointed of French support, they were defeated at Ruppelmonde and in 1453 were overwhelmed at the battle of Gavre, where they left 20,000 dead on the field. At a banquet shortly afterwards Philip vowed that he would lead a crusade against the Turks, who had seized Constantinople, and the knights of his court swore to follow his example.¹ The expedition, however, did not take place, and was but a pretext for levying subsidies and for knightly entertainments. In 1459 Philip sent an embassy under the duke of Cleves into Italy to take part in the conferences preparatory to a fresh expedition against the Turks, but this enterprise likewise fell to the ground. In 1456 the duke of Burgundy had given an asylum to the Dauphin Louis (afterwards Louis XI.), who had quarrelled with his father and had been forced to leave France. The "fox who would rob his host's hen-roost," as the old king called Louis, repaid his protector by attempting to sow discord in the ducal family of Burgundy, and then retired to the castle of Genappe in Brabant. At Charles VII.'s death, however, Philip was one of the first to recognize the new king, and accompanied him to Paris. During the journey Louis won over the seigneurs of Croy, the principal counsellors of the duke of Burgundy, and persuaded Philip to allow him to redeem the Somme towns for the sum stipulated in the treaty of Arras. This proceeding infuriated Philip's son Charles, count of Charolais, who prevailed upon his father to break his pledge and declare war on the king of France. On the 12th of April 1465 Philip handed over to his son the entire administration of his

¹ This was the singular vow known as "the vow of the pheasant," from the fact that Philip placed his hand solemnly on a pheasant, which had been brought to him by his herald, and vowed that he would fight the Turks and challenge their sultan to single combat.

estates. The old duke died at Bruges on the 15th of June 1467, and was buried at Dijon.

Philip was a great lover of pomp and luxury and a friend of letters, being the patron of Georges Chastelain, Olivier de la Marche and Antoine de la Salle, and the founder of the collection of MSS. known as the "Bibliothèque de Bourgogne" (now at Brussels), and also of the university of Dôle (1427). He administered his estates wisely; promoted commerce and industry, particularly in Flanders; and left his son a well-laden treasury. He was thrice married: in 1409 to Michelle (d. 1422), daughter of Charles VI. of France; in 1424 to Bonne of Artois (d. 1425); and in 1429 to Isabel (d. 1472), daughter of John I., king of Portugal. On the occasion of his third marriage Philip founded the order of the Golden Fleece. He was succeeded by Charles, afterwards known as Charles the Bold, his only surviving son by Isabel. He had several illegitimate children, among them being Corneille, called the Grand Bastard, who was killed in 1452 at the battle of Ruppelmonde.

(R. Po.)

PHILIP, LANDGRAVE OF HESSE (1504-1567), son of the landgrave William II., was born at Marburg on the 13th of November 1504. He became landgrave on his father's death in 1509, and having been declared of age in 1518, was married in 1523 to Christina, daughter of George, duke of Saxony (d. 1539). In 1522 and 1523 he assisted to quell the rising of Frans von Sickingen (*q.v.*), who had raided Hesse five years previously, and in 1525 he took a leading part in crushing the rebellion of the peasants in north Germany, being mainly responsible for their defeat at Frankenhausen. About this time Philip adopted the reformed faith, of which he was afterwards the zealous and daring defender. Indifferent to theological, or even to patriotic, considerations, his plans to protect the reformers rested upon two main principles—unity among the Protestants at home and military aid from abroad. The schemes he put forward as one of the heads of the league of Schmalkalden, aimed primarily at overthrowing the house of Habsburg; to this end aid was sought from foreigner and native, from Protestant and Catholic alike. Envoys were sent repeatedly to France, England and Denmark; Turkey and Venice were looked to for assistance; the jealousy felt towards the Habsburgs by the Bavarian Wittelsbachs was skilfully fomented; and the German Protestants were assured that attack was the best, nay the only, means of defence. Before the formation of the league of Schmalkalden Philip was very intimate with Zwingli, and up to the time of the reformer's death, in 1531, he hoped that material aid would be forthcoming from his followers. In 1526 he had aided John the Constant, elector of Saxony, to form an alliance of reforming princes; and in 1529 he called together the abortive conference at Marburg, hoping thus to close the breach between Lutherans and Zwinglians. More aggressive was his action in 1528. Deceived by the forgeries of Otto von Pack (*q.v.*), he believed in the existence of a conspiracy to crush the reformers, and was only restrained from attacking his enemies by the influence of John of Saxony and Luther. He succeeded, however, in compelling the archbishop of Mainz and the bishops of Würzburg and Bamberg to contribute to the cost of his mobilization. Philip was freely accused of having employed Pack to concoct the forgery; and, although this charge is doubtless false, his eager acceptance of Pack's unproved statements aroused considerable ill-feeling among the Catholics, which he was not slow to return. In 1529 the landgrave signed the "protest" which was presented to the diet at Spire, being thus one of the original "Protestants"; in 1530 he was among the subscribers to the confession of Augsburg; and the formation of the league of Schmalkalden in the same year was largely due to his energy.

His next important undertaking, the restoration of Ulrich, duke of Würtemberg (*q.v.*) to his duchy, was attended with conspicuous success. Würtemberg had passed into the possession of the Habsburgs, but after Philip's brief and victorious campaign in 1534 the humiliation of Charles V. and his brother, the German king, Ferdinand I., was so complete that it was

said the landgrave had done more for Protestantism by this enterprise than a thousand of Luther's books would do. After this victory Philip entertained the idea of coming to terms with Charles V. on the basis of extensive concessions to the Protestants; but he quickly returned to his former plans for leading a general attack on the Habsburgs. The Concord of Wittenberg, made in 1536, was favourable for these schemes, but after five years spent in assiduous preparation war was prevented by the serious illness of the landgrave and the lukewarmness of his allies. Recovering from his malady, he had returned to his intrigues when an event happened which materially affected the fortunes of the Reformation. His union with Christina was not a happy one, and having fixed his affections upon Margaret von der Saal (d. 1566), he obtained an opinion from Protestant theologians that bigamy was not forbidden by Holy Writ. Luther and Melancthon at length consented to the marriage, but stipulated that it should be kept secret, and it was celebrated in March 1540. The marriage, however, became known, and a great outcry arose against Philip, whose friends quickly deserted him. He objected to Luther's counsel to deny the existence of a second marriage; abused John Frederick, elector of Saxony, for not coming to support him; and caused bigamy to be publicly defended. Alarmed, however, by the strength of his enemies, and by their evident determination to punish him as a bigamist, he in June 1541 made a treaty with Charles V. at Regensburg. In return for a general pardon he undertook to break off relations with France and England and loyally to support the emperor.

During these years Philip had been forwarding the progress of the Reformation in Hesse. This was begun about 1526, when an important synod was held at Homburg; the university of Marburg was founded in the interests of the reformers in 1527; and after the diet of Spire in 1529 the work was conducted with renewed vigour. The Catholic worship was suppressed, and the secularized church revenues supplied an endowment of the new university.

The peace between the emperor and the landgrave was soon broken. In 1542 Philip persuaded the league of Schmalkalden to attack Henry II., duke of Brunswick-Wolfenbüttel, ostensibly in the interests of the Protestant towns of Brunswick and Goslar. The duchy was quickly overrun, and Henry—a Catholic prince—driven out; but the good understanding between the emperor and the landgrave was destroyed, and the relations between Protestants and Catholics became worse than before. Nor was the fissure in the Protestant ranks closed, and Charles took advantage of this disunion to conquer Gelderland and to mature his preparations for overthrowing the league of Schmalkalden. Unlike John Frederick of Saxony, Philip divined, or partly divined, the emperor's intentions, and urged repeatedly that the forces of the league should be put in order. This advice passed unheeded, and when Charles suddenly showed his hand, and in July 1546 issued the imperial ban against the landgrave and the elector, it was seen that the two princes were almost isolated. Fighting began along the upper Danube, and when indecision and want of funds had ruined the league's chances of success, Philip returned to Hesse and busied himself with seeking help from foreign powers; while in April 1547 John Frederick was captured at Mühlberg. After this defeat the landgrave was induced to surrender to Charles in June by his son-in-law, Maurice, now elector of Saxony, and Joachim II., elector of Braundenburg, who promised Philip that he should be pardoned, and were greatly incensed when the emperor refused to assent to this condition. There is, however, no truth in the story that the word *ewiger* was altered by an imperial servant into *ewiger*, thus making the phrase "without any imprisonment" in the treaty of surrender to read "without perpetual imprisonment." Philip was sentenced to detention for fifteen years, and as he was heartily disliked by Charles his imprisonment was a rigorous one, and became still more so after he had made an attempt to escape. His acceptance of the *Interim* in 1548 did not bring him freedom; but this came in consequence of the humiliation of

Charles V. at the hands of Maurice in 1552; and after the conclusion of the peace of Passau in this year he returned to Hesse. Although less active than formerly, the landgrave did not cease to intrigue on behalf of the Protestants while continuing the work of reforming and organizing the Church in Hesse. In 1562 he aided the Huguenots with troops, and he was frequently in communication with the insurgents in the Netherlands; but his efforts to form a union of the Protestants were fruitless. Philip, who is sometimes called the *Magnanimous*, died at Cassel on the 31st of March 1567. By Christina he had four sons and five daughters, and according to his directions the landgraviate was partitioned at his death between his sons. He had also by Margaret von der Saal seven sons, who were called counts of Diets, and one daughter.

See Ch. von Rommel, *Philipp der Grossmüthige* (Giessen, 1830); *Briefwechsel Landgraf Philipps mit Bucer*, edited by M. Lenz (Leipzig, 1881-1890); *Politisches Archiv des Landgrafen Philipps*, edited by F. Kuch (Leipzig, 1904); L. G. Mogen, *Historia capitulatis Philippi Magnanimi* (Frankfort, 1766); W. Falckenheiner, *Philipp der Grossmüthige im Basenarhege* (Marburg, 1887); H. Schwarz, *Landgraf Philipps von Hessen und die Pockschien Handel* (Leipzig, 1881); J. Wille, *Philipp der Grossmüthige von Hessen und die Restauration Ulrichs von Württemberg* (Tübingen, 1882); W. W. Rockwell, *Die Doppelheute des Landgrafen Philipps von Hessen* (Marburg, 1904); A. Heidenhain, *Die Unionspolitik Philipps von Hessen* (Halle, 1890); K. Varentztrapp, *Landgraf Philipps von Hessen und die Universität Marburg* (Cassel, 1904); Von Drach and Könnecke, *Die Bildnisse Philipps des Grossmüthigen* (Cassel, 1905); *Festschrift zum Gedächtnis Philipps*, published by the Verein für hessische Geschichte und Landeskunde (Cassel, 1904); and *Philipp der Grossmüthige, Beiträge zur Geschichte seines Lebens und seiner Zeit*, published by the Historischer Verein für das Grossherzogthum Hessen (Marburg, 1904).

PHILIP, JOHN (1775-1851), British missionary in South Africa, was born on the 14th of April 1775, at Kirkcaldy, Fife, the son of a schoolmaster in that town. After having been apprenticed to a linen draper, and for three years a clerk in a Dundee business house, he entered the Hoxton (Congregational) Theological College, and in 1804 was appointed to a Congregational chapel in Aberdeen. In 1818 he joined the Rev. John Campbell in his second journey to South Africa to inspect the stations of the London Missionary Society, and reported that the conduct of the Cape Colonists towards the natives was deserving of strong reprobation. In 1822 the London Missionary Society appointed him superintendent of their South African stations. He made his headquarters at Cape Town, where he also established and undertook the pastorate of the Union Chapel. His indignation was aroused by the barbarities inflicted upon the Hottentots and Kafirs (by a minority of the colonists), and he set himself to remedy their grievances; but his zeal was greater than his knowledge. He misjudged the character both of the colonists and of the natives, his cardinal mistake being in regarding the African as little removed from the European in intellect and capacity. It was the period of the agitation for the abolition of slavery in England, where Philip's charges against the colonists and the colonial government found powerful support. His influence was seen in the ordinance of 1828 granting all free coloured persons at the Cape every right to which any other British subjects were entitled. During 1826-1828 he was in England, and in the last-named year he published *Researches in South Africa*, containing his views on the native question. His recommendations were adopted by the House of Commons, but his unpopularity in South Africa was great, and in 1830 he was convicted of libelling a Cape official. The British government, however, caused the Cape government to conform to the views of Philip, who for over twenty years exercised a powerful, and in many respects unfavourable, influence over the destinies of the country. One of Philip's ideals was the curbing of colonial "aggression" by the creation of a belt of native states around Cape Colony. In Sir Benjamin D'Urban Philip found a governor anxious to promote the interests of the natives. When however at the close of the Kafir War of 1834-35 D'Urban annexed the country up to the Kei River, Philip's hostility was aroused. He came to England in 1836, in company with a Kafir convert and a Hottentot convert, and aroused public opinion against the Cape government. His views

triumphed, D'Urban was dismissed, and Philip returned to the Cape as unofficial adviser to the government on all matters affecting the natives. For a time his plan of buffer states was carried out, but in 1846 another Kafir rising convinced him of the futility of his schemes. The Kafir chief who had accompanied him to England joined the enemy; and many of his converts showed that his efforts on their behalf had effected no change in their character. This was a blow from which he did not recover. The annexation of the Orange River Sovereignty in 1848 followed, finally destroying his hope of maintaining independent native states. In 1849 he severed his connexion with politics and retired to the mission station at Hankey, Cape Colony, where he died on the 27th of August 1851.

See SOUTH AFRICA: *History*; G. M'C. Theal's *History of South Africa since 1795* (London, ed. 1908); *Missionary Magazine* (1836-1851); R. Wardlaw's *Funeral Sermon*, 1852.

PHILIP, KING (c. 1630-1676), chief sachem of the Wampanoag Indians in America, and the son of Massasoit (d. 1662)—as the English, mistaking this title (great chief) for a proper name, called Woosamequin (Yellow Feather)—who for forty years was the friend and ally of the English colonists at Plymouth. To Massasoit's two sons, Wamsutta and Metacomet, the English gave the names respectively of Alexander and Philip. Alexander succeeded his father as sachem, and in the same year, while in Marshfield, whither he had gone to explain certain alleged unfriendly acts toward the English, was taken ill; he died on his way home. Philip, who succeeded Alexander, suspected the English of poisoning his brother. The English had grown stronger and more numerous, and had begun to meddle in the internal affairs of the Indians. In 1667 one of Philip's Indians accused him to the English of attempting to betray them to the French or Dutch, but this charge was not proved. In 1671 the Plymouth authorities demanded that the Wampanoags should surrender their arms; Philip consented, but his followers failed to comply, and measures were taken to enforce the promise. Philip thereupon went before the general court, agreed to pay an annual tribute, and not to sell lands or engage in war with other Indians without the consent of the Plymouth government. In 1674, when three Wampanoags were executed at Plymouth for the alleged murder of Sassamon, an Indian convert who had played the part of informer to the English, Philip could no longer hold his followers in check. There were outbreaks in the middle of June 1675, and on the 24th of June the massacre of whites began. There was no concerted movement of the various tribes and the war had not been previously planned. The Nipmuck Indians rose in July; the tribes along the Connecticut river in August; those in the present states of Maine and New Hampshire in September and October, and the Narragansets in December, when (on the 19th) they were attacked and seriously crippled, in what is now the township of South Kingstown, Rhode Island, by the English (under Governor Josiah Winslow of Plymouth), who suspected their loyalty.

The colony of Connecticut took quick measures of defence, guarded its frontier, maintained its alliance with the Mohegans, and suffered little injury. Massachusetts and Plymouth were slower in acting and suffered great loss. Rhode Island raised no troops, and suffered severely. Early in the autumn Philip went nearly as far west as Albany in an unsuccessful attempt to get aid from the French and the Mohawks and supplies from the Dutch traders. At Deerfield on the 18th of September about 60 English were killed and the settlement was abandoned. In the spring of 1676 it became evident that the Indian power was waning. The warriors had been unable to plant their crops; they were weaker numerically and more poorly armed than the English, and the latter had also made an alliance with the friendly Naticks and the Niantica. On the 1st of August 1676 Philip's wife and nine-year old son were captured, and on the 11th of August an Indian traitor guided the English to the sachem's hiding place in a swamp at the foot of Mount Hope (in what is now the township of Bristol, Rhode Island), where early the next morning he was surprised, and while trying to escape was killed by an Indian. The head of Philip was sent to Plymouth and set

on a pole in a public place, where it remained for a quarter of a century; his right hand was given to his slayer, who preserved it in rum and won many pennies by exhibiting it in the New England towns. The struggle was now over in southern New England, but it continued along the north-eastern frontier till the spring of 1678, and nearly every settlement beyond the Piscataqua was destroyed. In the colonies of Plymouth, Massachusetts, Rhode Island and Connecticut six hundred men (or about 9% of the fighting population), besides many women and children, had been killed; thirteen settlements had been completely destroyed, and about forty others were partly burned. Plymouth had incurred a debt greater than the value of the personal property of her people. The Indians suffered even worse: in addition to the large number of men, women and children slain, great numbers, among them the wife and son of Philip, were sold into slavery in the Spanish Indies and the Bermudas. Many others migrated from New England to New York; and the few remaining Indians, feeble and dispirited, were no longer a power to be reckoned with. Philip was an Indian patriot and statesman, not a warrior; he united the tribes in their resistance to the colonists, but was not a great leader in battle.

See George M. Bodge, *Soldiers in King Philip's War* (Leominster, Mass., 1896); John Gorham Palfrey, *History of New England*, vol. iii. (Boston, 1864); and especially George W. Ellis and John E. Morris, *King Philip's War* (New York, 1906). See also *Entertaining Passages Relating to King Philip's War* (Boston, 1716; new edition, edited with notes by H. M. Dexter, Boston, 1865), the account by Colonel Benjamin Church (1639-1718), one of the principal leaders of the English, of the warfare in south-eastern New England, in which he took part; it is one of the most famous and realistic accounts of early Indian warfare.

PHILIPPA OF HAINAUT (c. 1314-1369), queen of the English king Edward III., was the daughter of William the Good, count of Holland and Hainaut, and his wife Jeanne de Valois, granddaughter of Philip III. of France. Edward visited the court of Count William in 1326 with his mother Isabella, who immediately arranged a marriage between him and Philippa. After a dispensation had been obtained for the marriage of the cousins (they were both descendants of Philip III.) Philippa was married by proxy at Valenciennes in October 1327, and landed in England in December. She joined Edward at York, where she was married on the 30th of January 1328. Her marriage dowry had been seized by the queen dowager Isabella to pay a body of Hainauters, with whose help she had compassed her husband's deposition. The alliance ensured for Edward in his French wars the support of Philippa's influential kindred; and before starting on his French campaign he secured troops from William the Good, as well as from the count of Gelderland, the count of Julich, and the emperor Louis the Bavarian. Her mother Jeanne de Valois, visited her in 1331 and further cemented the community of interests between England and Flanders. Before 1335 Philippa had established a small colony of Flemish weavers at Norwich, and she showed an active interest in the weaving trade by repeated visits to the town. She also encouraged coal-mining on her estates in Tynedale. Her eldest son, Edward the Black Prince, was born in 1330, and she subsequently bore six sons and five daughters. In November 1342 she became guardian of John of Gaunt and her younger children, with their lands. Her agents are said to have shown great harshness in collecting the feudal dues with which to supply her large household. The anecdotes of her piety and generosity which have been preserved are proof, however, of her popularity. She interceded in 1331 with the king for some carpenters whose careless work on a platform resulted in an accident to herself and her ladies, and on a more famous occasion her prayers saved the citizens of Calais from Edward's vengeance. There is a generally accepted story, based on the chronicles of Jehan le Bel and Froissart, that she summoned the English forces to meet the Scottish invasion of 1346, and harangued the troops before the battle of Neville's Cross. She certainly exercised considerable influence over her husband, whom she constantly accompanied on his campaigns; and her death on the 15th of August 1369 was a misfortune for the kingdom at large, since Edward from that time came under

the domination of the rapacious Alice Perrers. Philippa was the patron and friend of Froissart, who was her secretary from 1361 to 1366. Queen's College, Oxford, was not, as is stated in Skelton's version of her epitaph, founded by her, but by her chaplain, Robert of Eglesfield. Her chief benefactions were made to the hospital of St Katharine's by the Tower, London.

See Agnes Strickland, *Lives of the Queens of England*, vol. i. In addition to the account given in his *Chroniques*, Froissart wrote a formal eulogy of her, which has been lost.

PHILIPPEVILLE, a seaport of Algeria, chief town of an *arrondissement* in the department of Constantine, and 54 m. N. by E. of that city, on the Bay of Stora, in 36° 53' N. 6° 54' E. It is connected by railway with Constantine, Batna and Biskra. The town derives its importance from being the port of Constantine. The harbour works, with every vessel in port, having been destroyed by a storm in 1878, a more commodious harbour was built, at a cost of about £1,200,000. From Cape Skikda, on the east a mole or breakwater projects 450 ft. to the W.N.W., while from Château Vert on the west another mole runs out 1312 ft. to the north, leaving an entrance to the port about 656 ft. wide. The protected area comprises an outer and an inner basin. The depth of water at the entrance is about 33 ft., alongside the quays about 20 ft. The quays are faced with blocks of white marble brought from the quarries at Filfila, 16 m. distant. Pop. (1906), of the town 16,539, of the commune 26,050, of the *arrondissement*, which includes 12 communes, 147,607.

Philippeville occupies the site of successive Phœnician and Roman cities. By the Romans, under whom it attained a high state of prosperity, it was named *Rusicada*. In the middle ages the town ceased to be inhabited. The site was purchased from the Arabs by Marshal Valée in 1838 for £6. Some parts of the Roman theatre remain, but the stones of the amphitheatre, which stood without the walls of the modern town, and which the French found in an almost perfect state of preservation, were used by them for building purposes, and the railway was cut through the site. On a hill above the town are the Roman reservoirs, which have been restored and still supply the town with water. They are fed by a canal from the Wadi Beni Meleh. The Roman baths, in the centre of the modern town, serve as cellars for military stores.

PHILIPPI (Turk. *Filibejik*), a city of ancient Macedonia, on a steep hill near the river Gangitis (mod. *Angista*), overlooking an extensive plain and at no great distance from the coast of the Aegean, on the highway between Neapolis (Kavala) and Thessalonica. Originally called *Crenides* (Fountains), it took its later name from Philip II. of Macedon, who made himself master of the neighbouring gold mines of the Hill of Dionysus, and fortified the city as one of his frontier-towns. In 42 B.C., after the victory gained over the senatorial party by Octavius and Antony, it became a Roman colony, *Colonia Julia Philippensis*, which was probably increased after the battle of Actium (*Col. Aug. Julia Phil.*). The inhabitants received the *Jus Italicum*, and Philippi was one of the specially designated "first cities" (Acts xvi. 12; see Marquardt, *Röm. Staatsverwaltung*, i. 187). The city was twice visited by St Paul, whose Epistle to the Philippians was addressed to his converts here. The site, now uninhabited, is marked by ruins—the substructions of an amphitheatre, parts of a great temple—which have furnished interesting inscriptions. A little to the east is the huge stone monument of C. Vibius, known to the Turks as *Dikelitashlar* and to the Greeks as the *Manger of Bucephalus*.

See Heuzey and Daumet, *Mission arch. en Macédoine*, Paris (1865), and other authorities in bibliography of MACÉDOINE; *Corp. Inscr. Lat.* iii. 1.

PHILIPPIANS, EPISTLE TO THE, a book of the New Testament. Communications had already passed between the Christians of Philippi and Paul, not only when he was at Thessalonica (iv. 15-16), but at some subsequent period (iv. 18), when Epaphroditus had brought him a present of money from them. It is possible that this gift was accompanied by a letter. At any rate the extant epistle is the answer to one received from the Philippian Christians, who had evidently desired information about the

apostle's health and prospects (i. 12), assured him of their prayers (i. 19), and wondered whether he, their pride and glory (*καύχημα*), would return to them (i. 25 seq.).

After a brief greeting (i. 1, 2), Paul assures them of his loving interest in their present attainments and future progress in the faith of the gospel (i. 3-11); then, relieving their anxiety about his own prospects, he expresses the confident hope that he will be released and thus be able to return to them (i. 12-26). Meantime they were to avoid any pride or factiousness which might break their unity¹ as a church (i. 27-ii. 18), and they are promised a visit from two of Paul's coadjutors,² who are well known to them (ii. 19-30). At this point the letter suddenly swerves³ into a passionate warning against some errorists of Judaism (iii. 1-iv. 1), after which the appeal for unity at Philippi is reiterated (iv. 2-9),⁴ and the epistle closes with some personal details (iv. 10-23).

Paul is a prisoner when he writes, and the place of composition may therefore be Caesarea or Rome (Acts xviii. 16, 30-37). The evidence upon the whole seems to point to the latter. The phrase *oikla Kalaeos* (iv. 22) suits Rome better than Caesarea, and, while *παρισίων* (i. 13) does not necessarily imply the capital, it is most naturally understood of Rome.⁵ But the whole tone of the epistle suggests that Paul expected a speedy end to his case. Now at Caesarea this was out of the question. His appeal to Caesar involved a protracted process, and it is very difficult to put expressions like those e.g. of ii. 23 into such a situation. The critical outlook of Philippians does not correspond with the position of the apostle at Caesarea, nor can the latter town be said to have been a centre of vigorous Christian propaganda (i. 17). Finally, the contention that no visit of Timothy to Rome is known is an argument from silence which is of little more weight than the plea of Spitta that the cupidity of Felix (Acts xxiv. 26) was excited by the arrival of the money from Philippi (Phil. iv. 16).

A further examination of the epistle shows that it must have been written towards the close of the *δουρία* *ἐπι* of Acts xviii. 30, not in the earlier part of the Roman captivity. Paul is on the edge and eve of the great decision. Behind him (i. 12-13) lies a period during which considerable progress has been made in the local preaching and extension of the gospel, nor does the language of the apostle suggest that this fresh departure in the propaganda was stimulated by the mere novelty of his arrival. Furthermore, the relations between the Philippians and himself presuppose, on any fair estimate, an interval of time which cannot be crushed into a few months. News of his arrival must have reached them; money was collected (ii. 25, iv. 18) and then forwarded by Epaphroditus, who fell sick after he reached the capital; news of this again floated back to Philippi, and subsequently Paul heard of the Philippians' concern (ii. 26). Not till then did he compose this letter.

Philippians is thus the last extant letter we possess from Paul, unless some of the notes embedded in the pastoral epistles are to be dated subsequent to its composition. It unites the close of his career in Rome with the beginning of his mission work in Europe (iv. 15; cf. Acts xvi. 12), and illustrates not merely the situation of the apostle at Rome, but the terms of exceptional affection which existed from first to last between him and the

¹ For the strong Christian consciousness of solidarity, presupposed in the Philippians, see Von Dobschütz's *Christian Life in the Primitive Church* (1904), pp. 93 seq.

² The touch of acidity in ii. 21 (after i. 14) is probably to be explained by the fact that "Paul had found some of the brethren reluctant to undertake a journey to Macedonia, or to perform some other service which he desired, and the words only express the momentary disappointment of a man who was imprisoned and ready to die for the gospel" (Drummond). Cf. Renan's *Antichrist* (Eng. trans. p. 48).

³ The so-called logion in (Justin's?) *De resurrect.* 9: *ἀποκρίθη τῷ ἐρωτῶντι ἰστορῶν*, seems a mere echo of iii. 20.

⁴ On iv. 8 Von Soden notes (*History of Early Christian Literature*, p. 114) that "it is as if we heard the ripple of the waves at the meeting of the two streams which have their source in Zion and the Parthenon."

⁵ If the expression meant (a) the *praefecti praetorio* or officials charged with the care of prisoners under trial, i.e. the supreme imperial court, or (b) the praetorian guard, or (c) their barracks, this would almost follow. But conceivably it might mean the palace, i.e. of Herod (Acts xxiii. 35). The balance of probabilities falls, however, in favour of the court hypothesis.

Macedonian churches. The main argument for putting it earlier is derived from the admitted affinities between it and Romans, the Colossian and Ephesian epistles containing, it is held, a more advanced christology (so Lightfoot especially, and Hort, *Judaistic Christianity*, pp. 115-129). But such considerations are not decisive. Paul wrote from time to time, not in the execution of a literary plan, but as different objects or interests called out his powers. The Philippians did not require, and therefore did not receive, the same elaborate warnings as the Asiatic churches. Hence on the one hand it is unreal to lay stress on coincidences with Romans, as if these necessarily implied that both epistles must have been composed shortly after one another, while again the further stage of thought on Christ and the Church, which is evident in Colossians, does not prove that the latter must have followed the former. Upon the whole, the internal evidence of the epistle strongly favours its position as the last of the captivity epistles.

The attempts made during the 19th century to disprove the Pauline authorship now possess merely an historic interest, nor have the various hypotheses of more or less extensive interpolation won any serious support.⁶ More significance attaches to the view that the epistle is made up of two separate notes, written to Philippi at different times. The fusion of the two is found in the abrupt hiatus of iii. 1, and evidence is led from supposed inconsistencies between the earlier and the latter parts of the epistle. But the flexibility of a letter-writer, under different moods of feeling, which would naturally lead to rapid transitions, may be adduced as some explanation of the latter phenomena. The exegesis does not absolutely necessitate a partition of the epistle, which (so Heinrichs and Paulus) would make iii. 1-iv. 20 a special letter addressed to some inner circle of the apostle's friends (in spite of iv. 10 seq.), or take iii.-iv. (Hausrath, *History of N. T. Times*, iv. 162 seq. and Bacon, *Story of St Paul*, pp. 367 seq.) as earlier than i.-ii. Besides, as Pfeiderer points out, the hypothesis is shipwrecked on the difficulty of imagining that "each of the epistles had but one essential part: the first, in particular, lacking an expression of thanks for the gift from the Philippians, which must nevertheless, according to ii. 25, have already taken place." In his letter to the Philippians (iii. 2) Polycarp indeed observes that Paul wrote *ἐπινοῶν* to them; but, even if the plural could not be taken as equivalent to a single despatch, it would not necessarily support the partition theory of the canonical Philippians. Polycarp may have known of more than one Pauline note to Philippi, no longer extant, or he may be referring loosely to 2 Thessalonians, which was addressed to a neighbouring Macedonian church. The exegetical arguments are, in short, the final court of appeal, and their verdict tells rather in favour of the epistle's integrity. The simplest account of iii. 1 is to suppose that Paul started afresh to complete or supplement what he had already written, possibly because some fresh tidings from Philippi had reached him in the interval. Psychologically the change from ii. 19 seq., with its note of farewell, to the impassioned outburst of iii. 2 seq., is not incredible in an informal letter from a man like Paul. The hiatus is striking, but it cannot be held to necessitate an editorial dovetailing of two separate epistles. It is doubtful, therefore, if the ingenious attempts to analyse Philippians have proved much more convincing than the similar movement of literary criticism upon the first Philippic of Demosthenes, where research has swung back in the main to a conservative position (cf. A. Baron in *Wiener Studien*, 1884, 173-205).

The first clear echoes of the epistle are heard in Polycarp, though it was probably known to Clement of Rome and Ignatius (cf. the evidence tabulated in *The New Testament in the Apostolic*

⁶ To the details furnished in the present writer's *Historical New Testament* (2nd ed., 1901, pp. 634-635) may be added references to Völter's *Paulus u. seine Briefe* (1905), pp. 286-323, Belsger's *Einleitung in der N. T.* (2nd ed., 1905), pp. 555 seq., and Schmiedel's paragraphs in *Ency. Bib.* (3147-3148). Pfeiderer (*Primitive Christianity*, i. 254 seq.) now hesitates on ii. 6 seq. alone like Brückner and Schmiedel. The objections to Paul's authorship on the score of style and grammar are finally set aside by the philologist Nägeli in *Der Wortschatz des Apostels Paulus* (1905), pp. 80-82.

Fathers, 1905, pp. 53 seq., 71 seq., 94 seq., with R. J. Knowling's *Testimony of St Paul to Christ*, pp. 111 seq. and Gregory's *Canon and Text of N. T.*, 1907, pp. 205-206).

BIBLIOGRAPHY.—The ablest among recent editions of the Greek text are those of R. A. Lipsius (*Hand-Compendium sum N. T.*, 2nd ed., 1892), E. Haupt (in Meyer's *Kommentar*, 1902) and H. A. A. Kennedy (*Expositor's Greek Testament*, 1903), to which may be added the older commentaries of C. J. Elliptic (5th ed., 1888), J. B. Lightfoot (6th ed., 1891) and A. Klöpffer (1893), which in some respects are not yet superseded. Other modern editions by M. R. Vincent (*Internal Crit. Commentary*, 1897), H. C. G. Moule (*Cambridge Greek Testament*, 1897) and J. M. S. Baljon (1904) are worthy of notice, as well as the Roman Catholic commentaries by P. Beelen (Louvain, 1852) and A. Bisping (1866). The earlier work on the epistle is adequately summarized by W. Weiss in his *Der Philippenerbrief ausgelegt u. die Geschichte seiner Auslegung kritisch dargestellt* (1859). There are brief popular commentaries in German by A. Neander (Eng. trans., 1851; Edinburgh), K. Braune (in Lange's *Bibel-Werk*, 2nd ed., 1875), Von Soden (1890), K. J. Müller (1899) and W. Lueken (in *Die Schriften des N. T.*, 1906); in English by C. J. Vaughan, M. F. Sadler (1889), J. Agar Beet, G. C. Martin (*Century Bible*) and Priscilla Drummond (*Internal Handbooks to N. T.*, 1899). In addition to the literature cited in the course of this article, consult the general studies by M. Hasselmann (*Analyse pragmatique de l'épître aux Phil.*, 1862); A. Sabatier (*Encycl. des sciences relig.*, x. 569-573); J. Gibb (Hastings's *Dict. Bible*, iii. 840-844); Sir W. M. Ramsay (*St Paul the Traveller*, ch. x., xv. § 4) and R. R. Smith (*The Epistle of St. Paul's First Trial*, Cambridge, 1899); besides the older essays of Rettig (*Quaestiones philippenses*, Giessen, 1831) and C. Müller (*Comment. de locis quibusdam epistolae ad Phil.*, 1844). The case against the Pauline authorship was stated most fully by F. C. Baur (*Paulus*, Eng. trans., ii. 45 seq. and in *Theol. Jahrb.*, 1849, pp. 501 seq., 1852, pp. 133 seq.); E. Hirsch (*Zeitschrift für wiss. Theol.*, 1873, pp. 59 seq.); S. Hoekstra (*Theol. Tijdschrift*, 1875, pp. 416 seq.); J. P. Straatman (*De Gemeente te Rome*, 1878, pp. 201 seq.); C. Holsten (*Jahrb. für protest. Theologie*, 1875, pp. 425 seq., 1876, pp. 58 seq., 282 seq.); and Van Manen (*Handleiding voor de ouderchrist. Lectoraat*, 1900, pp. 49-51, 82-84; also in *Ency. Bib.*, 3703-3713). The most thorough replies have been those of Lünemann (*Paulus ad Philipp. epistola contra Baurium defensa*, 1847); Ernesti (*Studien und Kritiken*, 1848, pp. 858-924, 1851, pp. 591-632); B. Brückner (*Epistola ad Phil. Paulo auctori vindicata contra Baurium*, 1848); A. Resch (*De l'Authent. de l'épître aux Phil.*, 1850); Grimm (*Zeitschrift für wiss. Theologie*, 1873, pp. 33 seq.); Hilgenfeld (*ibid.*, 1884, pp. 498 seq.); C. Weizsäcker (*Apöstolische Age*, i. 218 seq., 279 seq., ii. 131) and Clemens (*Paulus*, i. 130-138). The religious ideas of the epistle are best stated in English by Principal Rainy (*Philippians, Expositor's Bible*) and H. C. G. Moule (*Philippian Studies*, 1897). Of the numberless monographs on ii. 6 seq. the most full is Tholuck's *Disputatio christologica de loco Pauli*, Phil. ii. 6-9; and discussions of special excellence may be found in A. B. Bruce, *The Humiliation of Christ* (3rd ed., 1880, pp. 15 seq., 357 seq.); Weifenbach's *Zur Auslegung d. Stelle Phil. ii. 5-11* (Karlsruhe, 1884); and E. H. Gifford, *The Incarnation* (reprinted from the *Expositor*, 1896). (J. M.T.)

PHILIPPICS, in classical literature, a series of orations delivered by Demosthenes against Philip of Macedon. The name was applied to the speeches of Cicero against Mark Antony, and "Philippic" has passed into general use in the sense of an impassioned invective or declamation.

PHILIPPICUS, East Roman emperor, 711-713, was the son of the patrician Nicephorus, and became distinguished as a soldier under Justinian II. His proper name, which indicates his Armenian origin, was Bardanes. Relying on the support of the Monothelite party, he made some pretensions to the throne on the outbreak of the first great rebellion against Justinian; these led to his relegation to Cephalonia by Tiberius Absimar, and subsequently to his banishment, by order of Justinian, to Cherson. Here Bardanes, taking the name of Philippicus, successfully incited the inhabitants to revolt, and on the assassination of Justinian he at once assumed the purple. Among his first acts were the deposition of Cyrus, the orthodox patriarch of Constantinople, in favour of John, a member of his own sect, and the summoning of a *conclitabulum* of Eastern bishops, which abolished the canons of the sixth general council. Meanwhile Terbelis, king of the Bulgarians, plundered up to the walls of Constantinople, and shortly afterwards the Saracens made similar inroads from the Asiatic side. The reign of Philippicus was brought to a close through a conspiracy headed by two of his generals, who caused him to be blinded.

See Gibbon, *Decline and Fall of the Roman Empire* (ed. Bury, London, 1896), v. 183-184.

PHILIPPINE ISLANDS, or **THE PHILIPPINES**, an archipelago belonging to the United States of America, situated about 500 m. off the S.E. coast of Asia between 4° 40' and 21° 10' N. and between 116° 40' and 126° 34' E. It is bounded W. and N. by the China Sea, E. by the Pacific Ocean, and S. by the Celebes Sea and the coastal waters of Borneo. Of the large islands, Luzon (40,969 sq. m.) is the most northerly, and Mindanao (36,292 sq. m.), the most southerly. Between Luzon and Mindanao are Samar (5,031 sq. m.), Negros (4,881 sq. m.), Panay (4,611 sq. m.), Mindoro (3,851 sq. m.), Leyte (2,722 sq. m.), Cebu (1,762 sq. m.), Bohol (1,441 sq. m.) and Masbate (1,236 sq. m.). Farther west and separated from the southern portion of this chain is the long narrow island of Palawan or Paragua (4,027 sq. m.). The total land area of the Philippines is about 115,026 sq. m., and 92% of this is included in the eleven islands named above. There are twenty others, which have an area ranging from 106 sq. m. to 682 sq. m., and the total number of islands enumerated within the archipelago is 3,141; of these 2,775 contain less than 1 sq. m. each.

Physical Features.—The islands are mainly of volcanic origin, and their surface is much broken by hills, isolated volcanoes and mountain ranges, trending north and south, north-west and south-east, or north-east and south-west. Extending for 350 m. along the east coast of central and northern Luzon is the Sierra Madre range, rising in occasional peaks to more than 4,500 ft. and seldom less than 3,500 ft. On the west coast are the Caraballos Occidentales north from the Gulf of Lingayen and the Zambales southward from that gulf to Manila Bay. The Caraballos Occidentales range is very complex; the central ridge is in some parts a rolling plateau, but it rises in Mt. Datá to 7,364 ft., and numerous lofty spurs project from it. Much of the Zambales range has an average height of 4,000 ft. or more, and several peaks are more than 5,000 ft. high. Between the Sierra Madre and Caraballos Occidentales is the valley of the Cagayán river, about 50 m. wide, and east of the Zambales range is a lowland basin, about 150 m. long and 50 m. wide, and not more than 100 ft. above the sea except near its centre, where the extinct volcano of Arayat rises to 3,564 ft. The greater part of southern Luzon is occupied by isolated volcanoes and irregular masses of hills and mountains. Mt. Mayon (7,916 ft.), near the south-eastern extremity, is an active volcano with an almost perfect cone. Of less prominence are Mt. Banájao (7,382 ft.), Mt. Isarog (6,634 ft.) and Mt. Masaraga (5,244 ft.). The island of Mindanao is traversed north to south by mountain ranges, which rise in their summits to heights exceeding 4,000 ft. That along the east coast is longest and least broken, and between it and the next range inland is the level valley of the Agusan river, from 40 to 50 m. wide. Farther west and south-west is the valley of the Rio Grande Mindanao, the largest river on the island, and between the lower course of this river and the south coast is a mountain range with a north-west and south-east trend. On the east border of the south portion of the basin of the Rio Grande Mindanao is Mt. Apo (10,312 ft.), an extinct volcano and the highest elevation in the archipelago.

Each of the larger islands between Luzon and Mindanao, except Samar and Bohol, is traversed longitudinally by a single mountain range with occasional spurs. In Leyte there are several isolated volcanic cones, two of which, in the north part, exceed 4,000 ft. In Mindoro the range is broad, extending from coast to coast, and it culminates in Mt. Halcón (about 8,800 ft.). In Negros is Mt. Canlaón (8,192 ft.), a volcano, and several summits exceeding 6,000 ft. In Panay is Mt. Madiaás (7,264 ft.) and several other peaks exceeding 4,000 ft. The highest peaks in Masbate are about 2,500 ft. high, and in Cebu not much more than 2,000 ft. In Samar there are irregular masses of hills. The southern portion of Bohol is very hilly, but the northern portion is more level. Palawan, 275 m. long and about 15 m. wide, is traversed throughout its length by a range of mountains with an average height of 4,000 to 5,000 ft. and a few summits about 6,000 ft. high. Submarine mountain ranges connect not only the islands within the archipelago, but also the archipelago itself with Borneo and Celebes, so that only shallow channels connect the interior waters with the Pacific Ocean and the China Sea. The coast-line of the Philippines, more than 11,000 m. in length, is fringed with coral reefs and broken by numerous gulfs and bays.

The Cagayán river, in north Luzon, is the largest in the archipelago. It is about 220 m. long and drains to the northward about 10,000 sq. m., or nearly one-fourth of the island. The Rio Grande de Mindanao (known in its upper course as the Rio Pulangua) drains to the south and west a larger area in central and southern Mindanao and is second in size. It and the Agusan, which drains to the northward the mountain valley in east Mindanao, are each over 200 m. in length. The principal rivers of the lowland basin of central Luzon are the Pampanga and the Agno. The Pampanga rises in the highlands on the north-east border, flows south by west, and discharges through several channels into Manila Bay. The



.

.

.

.

.

.

.

.

Agno rises in the mountains on the north border, flows south, south-west and north-west, and discharges through several channels into the Gulf of Lingayén. Each of these has a great number of small tributaries, and along the coast of this lowland basin are many small tide water streams. The Pasig is a short but commercially important stream connecting Laguna de Bay with Manila Bay. The Rio Bicol, which rises in Lake Bato and flows N.N.W. into San Miguel Bay, is the principal river of south Luzon. Samar, Panay, Negros, Leyte, Bohol and Cebu are drained by many streams, and a few of those in Samar, Panay and Negros are of considerable size.

In the lowland basin of central Luzon, 6 m. inland from Manila Bay, is Laguna de Bay, the largest body of fresh water in the Philippines. It is 32 m. long from north-west to south-east and its coast-line, broken on the north by two hilly peninsulas, is 108 m. long. Lake Taal, a few miles south-west of Laguna de Bay, occupies the crater of a great volcano. It is 17½ m. long and 12 m. wide. The country rises gently to it on all sides, and on an island near its centre is the active volcano of Taal, 1050 ft. high. In north Luzon is Lake Cagayán. In Mindanao there are lakes Lanao, Liguasan and Buluan in the west-central portion and lakes Malinit, Pinaya, Dagun, Sadocum and Linao in the valley of the Agusan. There are small lakes in some of the other islands.

Geology.—The Philippines appear to be the remnants of a somewhat complex system of mountain arcs, which from their similarity of form and direction seem to be in some way connected with the mountain ranges of Annam. The oldest rocks exposed are gneiss, talc-schist and serpentinite, with intrusive masses of gabbro and diabase. These are overlaid by a limestone, upon which rests conformably a series of sandstones with coal seams. The age of these beds is unknown. In some of the islands nummulitic limestone (Eocene) occurs. Coral limestones, probably of Middle Tertiary age, are also found, sometimes 4000 ft. above the sea, and marine deposits of a very late geological period occur near the coast and in the low-lying depressions. Volcanic rocks of modern date cover extensive areas, especially in the southern part of Luzon and in Mindanao. In Luzon trachytic tuffs are sometimes interstratified with nummulitic limestone, thus showing that the eruptions had already begun in the Eocene period.

Volcanoes and Earthquakes.—There are twelve active volcanoes in the archipelago. They are Babuyán Claro, Camiguín de Babuyan and Didicas in the Babuyan Islands off the north coast of Luzon; Cagua or Casin in north Luzon; Taal, Mayón and Bulusan in south Luzon; Canlaon and Magaós in Negros; Camiguín de Mindanao in the island of Camiguín, off the north coast of Mindanao; and Apo and Calayo in Mindanao. Only a few eruptions have been recorded of any of these, however, except Taal and Mayón, and there has been no great eruption of Taal since 1754. But there were 26 eruptions of Mayón in the 19th century, and those of 1814 and 1897 were of great violence. That of 1897 began practically without warning on the 23rd of June, became alarming on the 24th and destructive on the 25th, and ceased on the 30th. Streams of lava completely destroyed several villages and injured others, as well as the town of San Fernando. The lava flow extended more than 7 m. eastward, and a rain of ashes extended 100 m. to the east and 75 m. to the west. There are eight other volcanoes, which although extinct or dormant have well-preserved cones. They are Arayat, Banásiao, San Cristóbal, Isarog and Malinao in south Luzon, and Macaturin and Matutum in Mindanao.

Earthquakes are frequent and occasionally violent. In the seven years 1902-1908 the microseismograph at Manila recorded 796 local earthquakes. In the 47 years ending March 1909 the various regions of the archipelago were visited by about 60 strong earthquakes; 16 of these, in ten different regions, occurred in the decade from 1890 to 1900. There were 8 in the year 1897 alone, and one of these ruined the town of Zamboanga in west Mindanao and caused considerable loss of life by falling buildings and immense sea waves. A new island appeared at this time off the coast of Borneo, near Labuan. The principal centres of disturbance are in the valley of the Agusan, in the region of Mayón volcano, in the region of Taal volcano, on Masbate island, and along the north shore of Luzon. The islands of Cebu, Bohol, Negros and Palawan are rarely shaken.

Fauna.—The Philippines, politically speaking, and the Philippines, zoologically speaking, are not identical areas; Balabac, Palawan and the Calamianes being characterized by the occurrence of numerous Bornean forms which are conspicuously absent from the remaining islands. Although the Philippines are commonly held to form an eastern extension of the Indo-Malayan sub-region, there is a large amount of specialization in the fauna of the islands eastward of the Palawan group. Mammals are scarce. No marsupials occur. The edentates are represented by the pangolin (*Manis* sp.?) of the Palawan group. In the seas are found the dolphin, cachalot and dugong. Wild hogs of at least two species occur. The beautiful axis deer of Sulu has apparently been brought there by man. Red or brown deer occur in Basilan, Mindanao, Leyte, Samar and the Calamianes Islands. The number of species and their respective ranges have not been satisfactorily determined. In Masbate, Panay, Guimaras and Negros there is a dark-coloured species marked with buff spots. Deer are absent in Palawan, Tawi Tawi, Tablas, Romblon, Sibuyan and Siquijor. Humped

cattle are raised on most of the islands. They are killed for their flesh, hides and horns, and little attention is paid to their milk-giving properties. The water-buffalo, or carabao, occurs in a wild state in Luzon, Mindoro, the Calamianes group, Masbate, Negros and Mindanao, but the wild breeds are believed to have originated from domesticated animals. The domesticated water-buffalo is sluggish in its movements, and will not work through the heat of the day; but it is a wonderful swimmer, and makes its way through the worst quagmire with ease. It is universally used as a draught animal and beast of burden. The most interesting of the ruminants is the timarua (*Bubalus mindorensis*, Heude), peculiar to Mindoro. Unlike the water-buffalo, it does not bathe in water or wallow in mud. It is extremely wild, feeding by night and sleeping by day in the densest jungle. It sometimes charges the hunter without provocation, and is very dangerous when wounded. It attacks and kills the much larger wild buffalo. All attempts to domesticate it have failed. A chevrotain is found in Balabac. The house rat, introduced by man, is a common nuisance, and mice occasionally seriously damage sugar-cane and rice. Squirrels are confined to the eastern chain of islands from Basilan to Samar and to the Palawan-Calamianes group. In the southern islands there is a tiny species, the size of a mouse. Very large flying-squirrels are found in Palawan and Mindanao. Squirrel-shrews occur in the Palawan-Calamianes group, and true shrews at various points in the archipelago. Among the Carnivores are the binturong and an otter, both found in the Palawan-Calamianes group; two civet cats, which range throughout the archipelago, and a wild cat of small size, which has been found in Palawan, Panay, Negros and Luzon. Bats are very numerous, and a number of the species are peculiar to the Philippines. *Galeopithecus* and *Ternisus* range from Basilan to Samar; the former occurs also in Bohol. In spite of all that has been said to the contrary, but one species of monkey (*Macacus philippinensis*, Geoff.) has been discovered in the Philippines. It occurs on every island of any importance. Its flesh is occasionally eaten by the natives. Albino specimens of this monkey are not uncommon, but the pure white monkeys, not albinos, said to inhabit Mindanao, are mythical. The large fruit bats (*Pteropus*) occur in immense colonies, and are sometimes eaten by the natives.

Especial importance attaches to the unexpected discovery by Whitehead of a new and peculiar mammalian fauna, inhabiting a small plateau on the top of Mt. Dana, in north Luzon, at an altitude of more than 7000 ft. Specimens of 15 species were obtained, embracing 5 new genera (*Calamomys*, *Chrotomys*, *Rhynchomys*, *Batomys* and *Carpomys*). Eight of the species were new and strikingly peculiar. Their zoological relationships are probably with Celebes and with Australia. Other discoveries include a few new squirrels and bats, and the occurrence of a lemur (*Nycticebus tardigradus*) in Tawi Tawi.

The islands are as rich in birds as they are poor in mammals, the total number of species recorded up to 1906 being 693, of which about one-half are peculiar to the Philippines. A study of their geographical distribution has demonstrated that the islands may be divided into fairly well-marked groups, in each of which the birds show a degree of specialization closely correlated with diversity of environment and completeness and probable duration of separation from adjacent groups. Balabac, Palawan and the Calamianes show a very strong Bornean element. Mindoro stands by itself. Luzon and the small neighbouring islands have 51 peculiar forms. A close relationship exists between the birds of the entire eastern chain of islands. Numerous genera and some families which are absent from the central islands range from Luzon to Basilan. These genera usually have distinct representative species in Luzon, Samar and Leyte, Mindanao, and in some cases in Basilan also. The greatest differences occur between Luzon and Samar and Leyte. The latter islands have 22 peculiar species.

Sulu and Tawi Tawi belong zoologically to the Philippines, but have 12 well-marked peculiar species, and many of the characteristic Mindanao-Basilan forms are lacking. Panay, Guimaras, Negros and Masbate constitute a sharply defined area, characterized not only by the occurrence of 30 peculiar species, but by the absence of important genera, and even whole families represented in the eastern islands. Most of the mammals characteristic of the latter region are lacking. It is a curious fact that Cebu stands quite by itself, although the deep channel separating it from Negros narrows at one point to about 4 m. Cebu possesses 9 striking species of birds not known to exist elsewhere, and lacks many of the characteristic forms of the central and eastern islands. The zoological position of Bohol has not been satisfactorily determined, but all existing evidence indicates that it must be grouped with Samar and Leyte.

Among the more interesting birds may be mentioned the "mound builder" (*Megopodius cumingi*, Dillwyn), which buries its large eggs in the soft sand along the sea beach, or under great mounds of earth and dead leaves, often at a depth of three or more feet below the surface. The young are forced to dig their way out and shift for themselves. The eggs are highly prized by the natives. The jungle fowl abounds. There are 35 species of pigeons and doves, many of them most beautifully coloured and all edible. Sapsucker, plover, turnstone and other shore birds are abundant during

the cool season, and herons, bitterns and ducks at all times. The birds of prey, 45 species, of which 22 are peculiar to the group, vary in size from a tiny falcon not larger than a sparrow (*Microhierax*), to an immense monkey-catching eagle (*Pitheophaga jefferyi*, Grant), which is strong enough to seize monkeys as they leap from tree to tree. There are 21 species of kingfishers, 15 being peculiar. Of the 12 species of hornbills not one occurs outside of the Philippines. Frog-mouths, bee-birds, night-hawks and swifts are found in considerable variety. One of the last (*Collocalia troglodytes*, Gray) constructs the edible nests so highly prized by the Chinese. The best nests are obtained on the precipitous sides of the Peñon de Coron, between Culion and Busuanga.

There may also be mentioned 21 cuckoos, 1 crocodile, 20 parrots and parakeets, 20 woodpeckers, barbets, woodhills, starlings, orioles, weaver-finches, larks, nuthatches, 28 beautifully coloured sun-birds, and 23 flower-peckers, titmice, shrikes, swallow-shrikes, tailor-birds, thrushes, fruit-thrushes, fairy blue-birds, fire-birds, 42 fly-catchers, 4 swallows, and 5 species of most beautifully coloured ant-thrushes, as well as a large number of birds for which English names cannot be readily supplied.

Reptiles and batrachians are abundant, but have been little studied. Pythona occur throughout the group, and sometimes attain enormous size. There are numerous venomous serpents, but the mortality from snake-bite is low. Geckoes may be seen on the walls and ceilings of any house. Flying lizards abound in the forests. Large iguanas are numerous. Their eggs are prized by the natives, and the flesh of one species, known as ibit of pelubid, is highly esteemed. Crocodiles are extremely numerous in many of the streams, and are occasionally found in the sea along the coasts. Specimens have been obtained measuring 18 ft. in length. Land turtles of small size are common. Very large sea turtles are often captured by the fishermen, and their flesh is highly appreciated as an article of food. A considerable business is done in tortoise-shell. Frogs occur in great variety. One small species appears in immense numbers with the coming of the rainy season, and at night the noise of its outcry almost deadens other sounds.

Fishes, especially marine fishes, are numerous and varied. About 500 species of food fishes have been found, and common among them are the bangos or milkfish, the banaak or mullet, mackerel, herring, anchovies, groupers, snappers, pompano, tarpon and bonito. The "dalag," which is found in the paddy-fields during the wet season, is a favourite with the natives.

The Philippines are famous for the variety, beauty and abundance of their land molluscs. Fresh-water and marine molluscs are also very numerous. While most of the species are of interest chiefly to the conchologist, there are a number of edible forms. The shells of *Placusa placens*, L., split into thin flat plates and, cut into small squares, are almost universally used in place of window glass. The valves of the giant clam (*Tridachna*) sometimes attain a length of 5 ft. and weigh hundreds of pounds. Pearl-oysters are abundant in the southern waters of the archipelago. Pearl-fishing is an important industry in the Sulu islands. The shells of the pearly nautilus are commonly used by the Visayans for drinking cups. From the great opercula of certain marine forms bracelets and other ornaments are carved, while the hard serrated edges of other species are sometimes employed in place of knives for harvesting rice. The land molluscs have been thoroughly classified, but much still remains to be done with the marine species.

Arthropoda are very abundant and as yet little known. Shrimps, crabs and lobsters form an important source of food supply. Mosquitoes are numerous in the wet lowlands. Bees are abundant, and wild honey and wax are gathered in considerable quantities. The number of species of ants is very large. Some of them infest dwelling-houses and swarm over the food. The termites, or so-called "white ants," inflict great damage on wooden buildings. Plagues of locusts occasionally, during a drought, ruin growing crops; in damp wet weather these insects are destroyed by a fungus growth (*Empusa gryllae*) within their bodies.

Land-leeches swarm in the damp lowland forests. The coral beds of Mindanao and the Sulu Archipelago are of unsurpassed beauty, and Guimaras, Cebu and Siquijor are completely covered with a thick cap of coral limestone.

Flora.—The rich and varied flora of the Philippines is essentially Malayan, intermixed with Chinese and Australian elements, but with sufficient individuality to constitute a sub-region, there being at least 769 species peculiar to the archipelago. More than two-thirds of the land surface is covered with forests. In the lowlands and on the lower mountain slopes the forests are composed chiefly of broad-leaved trees, common among which are the bamboo, the coco and other palms, and the banyan tree; but on the higher mountain slopes pines are most abundant. About 750 species of wood are of commercial or local value, among them are woods well-suited for structural purposes, inside finishing, cabinet work and carriage making. Plants valuable for their fibre number about 300, and among them is the abaca (*Musa tenax*), from the leaves of which Manila hemp is made. There are gutta-percha, india-rubber and other trees and plants yielding gums, the banana, mango, and many other trees and plants yielding fruits; and various trees and plants yielding nuts, spices, oils and medicines.

Climate.—A uniformly high temperature, excessive humidity, heavy rainfalls and violent tropical storms, known as typhoons or baguios, are characteristic of the Philippine climate. At Manila the mean annual temperature is about 80° F., the range of mean monthly temperature 6-48°, from 77° in January to 83-48° in May; and the range of extremes (during the period from 1881 to 1902) 39-96° from 60-08° in January 1881 to 100-04° in May 1880. In accordance with the monthly variations in temperature at Manila the year is divided into three seasons: temperate (November, December, January and February), hot (April, May and June) and intermediate (March, July, September and October). Throughout the archipelago the mean annual temperature varies much more with the altitude than with the latitude, but the range in mean monthly temperatures increases from 3-96° F. at Davao, Mindanao, in 7° 1' N. to 12-6° at Santo Domingo, Batan Islands, in 20° 28' N. The equality of the temperature also decreases appreciably from the sea-coast to the interior. The maximum daily range of temperature at Manila varies from 13-8° in June to 17-7° in December. At Manila the monthly average of relative humidity ranges from 70-7° in April to 85-5° in September, and the annual average is 79-4°. The mean annual rainfall in this city is about 76 in., and nearly three-fourths of it is from the middle of June to the middle of October, when the winds blow from the south-west. During the period from 1865 to 1902 the annual rainfall varied from 35-6 in. in 1885 to 117-3 in. in 1867 when in the month of September alone there was a fall of 57-8 in. In July, August and September two-thirds of the days are rainy, but in February, March and April only one-tenth of them are rainy. On the Pacific coast of Luzon, Samar, Leyte and Mindanao the rainy season is from November to May, when the winds blow from the east or the north-east. In the year ending August 1903 the amounts of rainfall at 41 observation stations widely distributed throughout the archipelago varied from 16-2 in. at Zamboanga in west Mindanao to 152 in. at Masinloc, on the west coast of central Luzon. The Philippines are visited on the average by twenty or more typhoons annually. About one-fifth of them occur in September. During January, February, March and April they are rare; in May, June and July they become increasingly common, and in August there is a falling off in the number, which reaches its maximum in September, gradually decreasing in October, November and December. In the famous typhoon of the 20th of October 1882, the vortex of which passed over Manila, an immense amount of damage was done in the city. Two thousand persons lost their lives in Samar and Leyte during the great storm of 1897. The typhoon warnings sent out from the Manila observatory annually save heavy loss of life and property.

Soil.—The soil, usually of a reddish-brown colour, is for the most part disintegrated lava mixed with decayed vegetation; occasionally there is also a mixture of disintegrated coral limestone.

Agriculture.—Agriculture is the principal industry. In 1903 about 40% of the working population were engaged in agricultural pursuits. The industry is, however, in a primitive condition. The native farmers are lazy and slow to appreciate the advantages of the methods recommended by the Americans. Only 9-5% of all the land in the archipelago was included in farms in 1903, and less than one-half of the farm land was under cultivation. In Luzon, Luzon, was the only province in which more than 50% of the land was included in "farms," and Cebu the only island in which more than 25% of the land was included in farms; in the large island of Mindanao only 1-4%, in Masbate only 1-6%, and in Mindoro only 3-9%. There were 815,453 "farms" or individual holdings, but more than one-fifth of these were small parcels or gardens containing less than an acre each; about one-half contained less than 2½ acres each, and the average size was 8-57 acres. More than four-fifths of them were worked by owners, and the remainder chiefly by share tenants. The principal crops are hemp (abaca), sugar, tobacco, coco-nuts and rice. Most of the hemp (538,200 acres in 1902) is grown in south Luzon and in Samar and Leyte, but smaller crops are produced in Cebu, Mindoro, Marinduque, north Mindanao and south Negros; the crop became of commercial importance about 1855, and in 1907 the yield for export amounted to 112,895 tons. About two-thirds of the sugar is produced in Negros, but it is an important crop in the provinces of Pampanga and Tarlac, within the lowland basin of Luzon, also in the province of Batangas on the south coast of Luzon, in the south and east of Panay, and in Cebu. The production increased from about 6000 tons in 1855 to 300,000 tons in 1893, and for many years prior to 1887 it was a more important crop than hemp, but since the American occupation the crop has been smaller. The total acreage in 1902 was 177,620 acres, and in 1907 the yield for export was 118,395 tons. Approximately one-half of the tobacco, 77,632 acres yielding 37-85 lb in 1902, is grown in the valley of the Cagayan river, and most of the remainder, which is of inferior quality, is in the neighbouring provinces of Union, Ilocos Norte and Abra, and in Panay, Cebu, Masbate and Negros. The natives chew betel nuts instead of tobacco, and to the production of these nuts they devote more than 60,000 acres. The rich soil of the lowlands of the province of Laguna is especially well adapted to the culture of the coco-nut palm, and since the American occupation considerable land in this province that had formerly been devoted to sugar

has been planted with these trees. They thrive well also in most low districts along the coasts; in 1908 about 375,000 acres were devoted to the culture of them.

Rice is the staple food of the natives. When the Philippines were discovered by the Spaniards it was the only cultivated crop of importance, and until the 19th century it was the chief article of export, but as the culture of the more profitable crops of hemp, sugar and coco-nuts was extended it became an article of import. As late as 1902, however, about one-half of the land under cultivation was sown to rice. It is grown most extensively in the lowlands of the south half of Luzon, in north Panay and in Negros, but the culture of either the lowland or the upland varieties for local consumption is very general. In some districts Indian corn is the staple food instead of rice, and the production of this cereal in small quantities for livestock is general. It is grown most extensively in the valley of the Cagayan river, in 1902 the total acreage in the archipelago was about 254,470. For several years prior to 1891, coffee, grown principally in the provinces of Cavite, Batangas and Lepanto-Bontoc, Luzon, was nearly as important a crop as tobacco, but between 1891 and 1898 most of the coffee plantations were destroyed by insects and disease. A small quantity of coffee is grown in the province of Benguet, Luzon, and is of superior quality. Cotton, the cultivation of which was discouraged by the Spanish government as a means of increasing the cultivation of tobacco is a very small crop, except in the provinces of Ilocos Norte, and Ilocos Sur on the west coast of north Luzon; in 1902 there were in these provinces about 5525 acres of cotton. Many tropical fruits grow wild but their quality is often inferior; those cultivated most extensively are mangoes and bananas. Grapes, blackberries, figs and strawberries have been introduced from the United States and are grown successfully in the province of Benguet. The natives care little for the garden vegetables common to Europe and America, but in the vicinity of Manila and other large centres of population the Chinese grow many of these for consumption by European and American inhabitants.

With the exception of the water-buffalo, which is indispensable for agricultural purposes, the domestic animals are very inferior in quality and few in numbers. The horses, which are of Mexican, Spanish and Chinese origin, are small and poorly cared for; some American horses have been introduced for the purpose of improving the breed. The neat cattle, which are of Australian and Indian origin, are raised chiefly for beef, their hides and their horns; about nine-tenths of them were destroyed by the rinderpest and the war at the close of the 19th century. Swine are numerous but they are of a kind known in the United States as "razorbacks." There are many goats but only a few sheep. In one district near Manila duck-raising is of considerable importance, but the principal branch of the poultry industry consists in the raising of game-cocks for cock-fighting, which is the national sport.

Mineral Resources.—Numerous mineral deposits have been discovered, but little has been determined with respect to their value. Sub-bituminous coal is widely distributed. That near the surface is generally poor in quality and the difficulties of deep mining may be great because of folds and faults in the rocks. There are, however, promising fields near Danao, in Cebu; on the island of Polillo, off the east coast of Luzon; in the south part of Mindoro; on Batán Island, off the south-east coast of Luzon; on Dinagat Island, off the north coast of Mindanao; and in the north-east corner of Negros. Gold has been found in small quantities in nearly all the provinces. There is some rude gold mining by the natives. As the result of favourable indications extensive gold-mining operations have been instituted in the provinces of Benguet and Ambos Camarines in Luzon, and on the island of Masbate. Copper is scarcely less widely distributed than gold, but the production of it awaits smelters and better facilities for transportation. There are extensive deposits of iron ore (magnetite and hematite) in the province of Bulacan, Luzon. Iron ore has been found in other provinces of Luzon and in the islands of Cebu, Panay and Marinduque. There are outcrops of lead in Marinduque and Cebu, and in Marinduque considerable silver is associated with the lead. Among other minerals are sulphur, lime, gypsum and phosphates.

Manufactures.—The manufacturing industry consists mainly in preparing agricultural products for market, and in the production by the natives of wearing apparel, furniture, household utensils, and other articles required to supply their primitive wants. The most important factories are those for the manufacture of cigars and cigarettes, but most cigars and some of the cigarettes are made by hand. In the manufacture of sugar most of the mills in use extract only about three-fourths of the juice from the cane; in 1902 about 73 % of it was manufactured by 528 mills operated by steam, 17 % by 470 mills operated by hand or by a carabao; and 10 % by 77 mills operated by water-power. In the principal rice-producing districts the rice is threshed and cleaned by machines, but in other districts more primitive methods are employed. Most of the cloth which the natives wear the women weave in their own homes. There are three principal varieties: *sinaway*, which is made from selected hemp fibres and is worn by both men and women, *jusi*, which is made from a mixture of hemp and pineapple-plant fibres with or without the addition of some cotton and silk and is used

for making women's dresses and men's shirts; *piña*, which is made from the fibres in the leaf of the pineapple-plant and is used for making women's garments, handkerchiefs and scarfs. *Nipa*, made from the fibre of the agave or maguey plant and worn by women, is less common. Hats are made of palm leaves, alacá leaves, banana leaves, split bamboo and various grasses. Mats, rugs and carpets are made principally of split bamboo; chairs and beds of baling and other woods and of rattan. Alcohol is distilled from nipa, coco-nuts, buri (*Corypha umbraculifera*), caung (*Caryota omissa*), pugahan (*Caryota surata*) and Indian corn. Other manufactures of the natives include vehicles of various kinds, harnesses, indigo, coco-nut oil, soap, salt and lime.

Communications and Commerce.—The first railway in the Philippines was the line from Manila to Dagupan (120 m.) which was built by an English corporation under a guaranty of the Spanish government and was opened in 1892. There was no further construction for ten years. But in 1902 and 1903 the Philippine government, as established in 1902 by an act of the Congress of the United States, granted franchises for the extension of the Manila-Dagupan railway to Cabanatuan (55 m.) and to Antipolo (24 m.). The first of these branches was completed in 1905, the second in 1906. In February 1905 Congress authorized the Philippine government to aid and encourage the construction of railways by guaranteeing 4 % interest on bonds; the duty on imported materials used in the construction of railways and the internal revenue on Philippine forest products used for that purpose have also been removed. With this assistance the Manila Railroad Company, organized under the laws of the state of New Jersey, agreed to construct about 600 m. of railway in Luzon; and the Philippine Railroad Company, organized under the laws of the state of Connecticut, agreed to construct about 300 m. in Panay, Cebu and Negros. In 1909 there were in operation more than 300 m. in Luzon, 60 m. in Cebu and 50 m. in Panay. At the beginning of the American occupation the roads were very bad and in many of the islands there were none; but in 1909 there were at least 400 m. of good roads. The Cagayan river, which is navigable for native boats 160 m. from its mouth, and for rafts 40 m. farther up, is an important highway of commerce in north Luzon. Many miles of inland water communication with small boats or bamboo rafts are afforded by the Pampanga, Agno, Abra, Paig and Bicol rivers in Luzon, and by the Agusan and Rio Grande de Mindanao in Mindanao. There are few harbours which admit vessels drawing more than 15 ft. of water, but many which admit smaller vessels, and at the close of 1909 there were 151 steamboats and 424 sailboats engaged in the coasting trade. Manila is the principal port of entry, and since the American occupation Manila harbour has been made accessible to vessels drawing 30 ft. of water. Cebu in Cebu and Iloilo in Panay are ports of entry second and third in rank, although small in comparison with Manila; there are others of minor importance.

The foreign commerce of the Philippines consists chiefly in the exportation of Manila hemp, dried coco-nut meat (copra), sugar and tobacco, both in the leaf and in cigars and cigarettes; and in the importation of cotton goods, rice, wheat-flour, fresh beef, boots and shoes, iron and steel, illuminating oil, liquors, paper and paper goods. The value of the exports increased from \$19,751,068 in the year ending the 30th of June 1900 to \$32,816,567 in the year ending the 30th of June 1908, and the value of the imports increased during the same period from \$20,601,436 to \$30,918,357. A very large part of the trade is with the United States and Great Britain. The imports from Great Britain exceed those from the United States, but the exports to the United States are much greater than those to Great Britain, and the total trade with the United States is greater than that with any other country. In 1909 8.05 % of the imports were from the United States; and 17.8 % of the exports were to the United States; in 1908 16.4 % of the imports were to the United States and 31.4 % of the exports were to the United States. In 1909 free trade was established between the United States and the Philippines in all goods which are the growth, product or manufacture of these countries, with the exception of rice, except that a limit to the free importation from the Philippines to the United States in any one year is fixed on cigars at 15,000,000; on wrapper tobacco and on filler tobacco, when mixed with more than 15 % of wrapper tobacco, at 300,000 lb; on filler tobacco at 1,000,000 lb and on sugar at 300,000 gross tons. In the case of manufactures the law provides that only those articles which do not contain more than 20 % in value of foreign materials shall be admitted free.

Population.—The total population of the archipelago as enumerated in the census of 1903 was 7,635,426. Of this number 6,087,868 were classed as civilized and 647,740 as wild, 7,579,288 or 99.2 % were native-born and 56,138 were foreign-born; 7,539,632 were of the Malayan or brown race, 42,097 were of the yellow race, 24,016 were of the black race, 14,271 were of the white race, and 15,410 were of mixed races. Of the black race 23,511, or 97.8 %, were Negritos, who are believed to be the aborigines of the Philippines. Nearly all of them live in a primitive state in the interior of Luzon, Panay, Mindanao and

Negros. They are very short of stature, 4 ft. 10 in. being about the average height of a full-grown man, and the women are shorter. Their colour is black, their skull decidedly round, their hair thick and frizzly, their legs thin and almost without calves, and their toes so prehensile that they can use them nearly as well as their fingers. They tattoo themselves and wear very little clothing, usually only a geestring. They have no fixed abodes but roam about in groups of a few families. They are skilful with the bow and in throwing stones, and they can easily kindle a fire, even in the wet season, by rubbing together two pieces of dry bamboo. Their food consists principally of game, roots and wild fruits. The women, who do all the work, collect wax and honey, which are their principal staples in trade. Few Negritos live to be fifty years of age. The brown race, which came from the south in successive waves of immigration beginning in prehistoric times, is composed of twenty-three distinct tribes varying widely in culture, language and appearance; their languages however belong to one common stock and there is a general resemblance in physical features and in quality of mind. The great bulk of the population, approximately 90%, is included in seven Christian tribes as follows: Visayan, 3,219,030; Tagalog, 1,460,695; Ilocano, 803,942; Bicol, 566,365; Pangasinan, 343,686; Pampangan, 280,984; and Cagayán, 159,648. The Visayans are the principal inhabitants of the islands in the central part of the archipelago (Panay, Cebu, Negros, Leyte, Bohol, Samar, Masbate and Paragua) and on the north and east coasts of Mindanao; they were perhaps the most civilized people in the archipelago when discovered by the Spaniards, by whom they were originally called Pintados because they were in the habit of painting their bodies; but since then their progress has been less rapid than that of the Tagalogs—who constitute the bulk of the population of Manila and central Luzon and the majority of the population of Mindanao—who are now the most cultured of the brown races in the Philippines. Most of the Ilocanos are in the western half of north Luzon; most of the Bicolos in south Luzon; most of the Pangasinans in the province of Pangasinan, which borders on the Gulf of Lingayén, most of the Pampangans in the province of Pampanga, which borders the north shore of Manila Bay; and most of the Cagayáns in the valley of the Cagayán river. More than three-fourths of the wild population is included in the Moro, Igorot and Negrito tribes. The Igorots (197,938 wild and 13,582 civilized) are the chief representatives of the early Malay immigration to the archipelago. They are the principal inhabitants of the provinces of Lepanto-Bontoc and Benguet in north Luzon and are numerous in the mountain districts of neighbouring provinces. Among the wildest of them head-hunting is still a common practice; but the majority are industrious farmers laying out their fields on artificial terraces and constructing irrigation canals with remarkable skill. The Moros (275,224 wild and 2323 civilized) were the last of the Malays to migrate to the islands; they came after their conversion to the Mahomedan religion, and their migration continued until the Spanish conquest. More than one-half of them are in Mindanao and they are the principal inhabitants of the small islands of Jolo, Basilan, Siassi and Tawi Tawi south-west of Mindanao. Slavery is common among them. They are generally miserably poor, cruel and haughty. Nearly three-fourths of the foreign-born and 97.5% of the representatives of the yellow race come from China. The mixture of the races is principally that of the Chinese with the Malays or the Spaniards with the Malays. More than half the representatives of the white race (1903) were Americans. Most of the inhabitants live in groups of villages. In 1903 there were 13,400 villages and nearly three-fourths of them contained fewer than 600 inhabitants each. Laoag in north Luzon with a population of 19,699, Iloilo in Panay with a population of 19,054, Cebu with a population of 18,330, and Nueva Cáceres in south Luzon (10,201), were the only towns with a population exceeding 10,000; and Manila (219,928) was the only city. After the 1903 census many towns were enlarged by annexation of suburbs.

Government.—At the beginning of the American occupation, in August 1898, a purely military government was established; but in May 1899 the military authorities began the re-establish-

ment of civil courts, and in July of the same year they began the organization of civil municipal governments. To continue the work of organizing and establishing civil government the president of the United States appointed in February 1900 a Philippine Commission of five members, with William H. Taft as chairman. On the 1st of September 1900 this body assumed the legislative functions of the central government at Manila; and on the 4th of July 1901 the executive authority was, by order of the president, transferred from the military governor to Judge Taft, whom he had appointed civil governor; and on the 6th of September 1901 the Philippine Commission, by authority of the president, established the four executive departments, of interior, commerce and police, finance and justice, and public instruction; and on the 29th of October 1901 the president appointed a vice-governor. The Congress of the United States, in an act approved on the 1st of July 1902, ratified and confirmed the government as thus established, but required that future appointments by the president of the governor, vice-governor, members of the commission and heads of the executive departments should be made with the consent of the Senate. The organic act contained a bill of rights, provided for the establishment of a popular assembly two years after the completion of a census of the Philippines, and more definitely provided for the organization of the judiciary. The first popular assembly, of 80 members, was opened at Manila on the 16th of October 1907, and since then the legislature has been composed of two branches, the Philippine Commission (five Americans and four, formerly three, Filipinos), and the Philippine Assembly. The members of the Assembly are elected by districts (the population of which is approximately equal) for a term of two years. A voter must be twenty-three years of age, must have been a resident of the municipality for six months, must not be a citizen or subject of any foreign country, and must possess at least one of the following qualifications: have been an office-holder under Spanish rule, own real estate worth 500 pesos, pay taxes amounting annually to 30 pesos, or be able to speak, read and write either Spanish or English. The legislature meets annually; a regular session is limited to 90 days, and a special session to 30 days.

Justice is administered principally by a supreme court, courts of first instance, and courts of justices of the peace. The supreme court consists of seven members, four Americans and three Filipinos; and the chief justice and associate justices of the supreme court are appointed by the president of the United States with the consent of the Senate. The judges of the courts of first instance are appointed by the governor with the consent of the Philippine Commission. A judgment of the supreme court of the Philippines which affects any statute, treaty, title, right or privilege of the United States may be reversed, modified or affirmed by the Supreme Court of the United States; an appeal to the Supreme Court of the United States may also be had in any case in which the value in controversy exceeds \$25,000.

The most common form of provincial government is that by a governor, who is elected biennially by the municipal councillors in convention, and a secretary, a treasurer, a supervisor, and a fiscal or prosecuting attorney, who are appointed by the Philippine Commission. Each municipality is governed by a president, a vice-president, and a municipal council, all of whom are elected biennially by the qualified electors of the municipality. The Philippine "municipality" is an administrative area, often sparsely settled, is often called a town, and may be compared to a New England township; the municipalities are the units into which the provinces are divided. Each municipality is made up of barrios or small villages (about 13,400 in the entire archipelago) and of one, or more, more thickly peopled areas, each called a *poblacion*, and resembling the township "centre" of New England.

Education.—The establishment of an efficient system of elementary schools has been an important part of the work of the American administration. Under Spanish rule the Church established colleges and seminaries for training priests, but the Spanish system of secular schools for elementary instruction, established in 1866, accomplished little; the schools were taught by unqualified native teachers and the supervision of them was very lax. The American

system, established by the Philippine Commission in 1901, provides a course of instruction (in the English language) for 11 years: 4 primary, 3 intermediate and 4 secondary. In the intermediate and secondary departments there is a choice of six courses; general, teaching, farming, toolwork, housekeeping and household arts and business. The administrative head of the system is the director of education, who is appointed by the commission, and who arranges the course of study, approves the plans for school houses, determines in what towns secondary schools shall be established and in what towns American teachers shall teach, divides the archipelago into school divisions and appoints a division superintendent in each, and supervises the examination of teachers and the application of insular school funds. Associated with him is an advisory board also appointed by the commission. In each school division, of which there were 35 in 1908, the division superintendent appoints the native teachers, prepares for the municipal councils estimates of school expenses, and approves all expenditures from municipal school funds. In each municipality there is a school board consisting of the president of the municipality and from four to six other members as the division superintendent shall determine; one-half of them are elected by the municipal council and one-half are appointed by the division superintendent. In 1902 there were 928 American teachers employed in the Philippine schools; the employment of American teachers is only a temporary policy, however, and by 1908 the number has been reduced to 795. In 1910 there were more than 6000 Filipino teachers who were teaching English to more than 500,000 pupils. The total number of children of school age in the islands probably reaches 2,000,000. The insular government also makes annual appropriations for the maintenance of Filipino students at educational institutions in the United States; in 1908 the number so provided for was 130. Besides the elementary schools there are at Manila the Philippine Normal School, the Philippine School of Arts and Trades, the Philippine School of Commerce and the school for the instruction of the deaf and blind, and in 1908 the Philippine legislature passed an act for the establishment of a university of the Philippines.

Finance.—Revenue is derived largely from customs duties and internal revenue taxes. In 1909 the receipts were \$22,739,000, the expenditure \$23,337,000, and the total bonded indebtedness \$16,000,000. (N. D. M.)

History.—The Philippine Islands were discovered by Magellan in March 1521. The first island on which he landed was Malhou, between Samar and Dinagat. Then sailing south he touched at Mindanao, from which he sailed north-west, past Bohol to Cebú. Here he found a good harbour in the bay on which the city of Cebú now stands. He made an alliance with the natives, who undertook to supply him with provisions. With his new allies he crossed to the little island of Mactan, where he was killed in a skirmish. A Portuguese by birth, he had been sailing in the employ of King Charles I. of Spain (the emperor Charles V.), with the object of proving that the Moluccas lay within that part of the world which Pope Alexander VI. and the treaty of Tordesillas (June 7, 1494) had given to Spain and not to Portugal. Magellan named his discovery the Archipelago of San Lazarus. The Spaniards, however, called the group the *Islas de Poniente* (Western Islands). The Portuguese called them the *Islas de Oriente*. The distinction was not accidental: To the Portuguese they constituted the eastern boundary of their world. From the Spanish point of view the islands were on the extreme western verge of the national domain. In 1529, by the treaty of Zaragoza, Spain relinquished to Portugal all claims to the Moluccas and agreed that no Spaniard should trade or sail west of a meridian drawn 207 leagues east of the Moluccas. This was a plain renunciation of any rights over the Philippines, which lie several degrees west of the Moluccas. This fact, however, was ignored and in 1542 an attempt to conquer the Philippines was made by Ruy Lopez de Villabos (c. 1500-1544). Villabos chose to honour the heir-apparent of the Spanish throne by naming some of the islands which he discovered, west and north of Magellan's discovery, the *Islas Filipinas*. After the accession of Philip II. (1555-1598) a much more important expedition was fitted out on the Mexican coast, under the direction of the distinguished conquistador, Miguel Lopez de Legaspi (1524-1572). In the sailing directions, issued in 1561, for the use of this expedition the phrase "las Islas Filipinas" was used as applying to the entire archipelago. Starting on the 2nd of November 1564, from Navidad, with four ships built and equipped on the spot, Legaspi began an enterprise which entitles him to a place among the greatest of colonial pioneers. He was accompanied by five Augustinian friars and four hundred men. In 1565 he founded,

on the island of Cebú, San Miguel, the first permanent Spanish settlement in the islands, destined to become the Villa de Santísimo Nombre de Jesus, later the city of Cebú. In 1571 the city of Manila was founded and became the insular capital. Legaspi's conquest of the islands was facilitated by the fact that there were no established native states, but rather a congeries of small clan-like groups, the headship of which was hereditary. Legaspi was reinforced from time to time by small contingents of troops and friars. Although he encountered enormous obstacles, including famine and mutiny, the hostility and treachery of the natives and of foreigners, and the neglect of the home government, he laid a sure foundation for permanent Spanish occupation. By a combination of tact, courage and resourcefulness he won the hearts of the natives, repelled the Portuguese and, notwithstanding the great distance from Spain, established the new colony on a practical basis. Before his death in 1572 he had explored and pacified a large part of the island territory, had established trade, and had arrested the progress of Mahomedanism.

The conquest of the Philippines was essentially a missionary conquest. Inspired by apostolic zeal the friars braved the terrors of life in the remote villages, raised the natives *The Friars* from barbarianism and taught them the forms of *and the* Christianity. As a result of their labours the Christian Filipinos stand unique as the only large mass of Asiatics converted to Christianity in modern times. The friars promoted the social and economic advancement of the islands, cultivated the native taste for music, introduced improvements in agriculture and imported Indian corn and cacao from America. Tobacco was introduced by the government.

The colonial government was patterned on that of Spanish America. The powers of the governor-general were limited only by the *audiencia* or supreme court, of which he was president, and by the *residencia* or official investigation at the expiration of his term. The islands were subdivided into provinces under *alcaldes mayores* who exercised both executive and judicial functions. The favouritism and corruption that honeycombed the civil service of Spain frequently resulted in placing in responsible positions persons who were entirely unfit. Hairdressers were made into *alcaldes*, and sailors were transformed into *governadores* by the miraculous grace of royal decrees. The provinces were subdivided into *pueblos*, each under a native *gobernadorcillo*, elected annually. The permanent offices could be bought, sold and inherited. The mistake was made of paying very low salaries to the officials, who took this as a justification for illegal exactions. The difficulty of securing proper officials gradually resulted in the more important civil functions being handed over to the friars, who frequently exercised a benevolent despotism. In more than half of the twelve hundred villages there was no other Spaniard beside the priest. The Spanish language was practically unknown. It was far easier for the monks to learn the native dialects than to teach their parishioners Spanish. For two centuries and a half after the conquest there is little narrative history worth recording. There were border wars with rebellious savage tribes, attacks made by Chinese pirates seeking plunder or refuge, volcanic eruptions, earthquakes, tornadoes and the periodical visits of marauders from the southern islands.

In 1762, however, as an incident of the war between Spain and England, a British fleet of thirteen ships, under the command of Admiral Samuel Cornish (d. 1770) and Brigadier *British* General William Draper (1721-1787), was sent to *Occupation* the Philippines. The available Spanish army consisted of about 600 men, while the attacking force numbered 6830. After a bombardment, Manila fell and on the 5th of October the British entered the city. By the terms of the capitulation the whole of the archipelago was surrendered to the British and an indemnity of 4,000,000 pesos was to be paid. As there was no governor-general at the time, the British were obliged to treat with the acting-governor, the Archbishop Manuel Antonio Rojo; but his authority was set aside by a war-party who rallied around Simon Anda y Salazar, a member of the *audiencia*. Anda proclaimed himself governor-general and practically

succeeded in confining the British to Manila. At the close of the war the Philippines were returned to Spain. Manila was evacuated in March 1764.

For the first quarter of a century after the Spanish conquest the islands were allowed free trade. Then came the familiar *Economic Development* restrictions, limiting commerce to a fixed amount annually, and effectively checking economic development. In 1591 direct trade between the Philippines and South America was prohibited. In 1593 trade between the Philippines and Mexico, the only route open between the colony and Spain, was limited to two ships annually, the ships not to exceed 300 tons burden. The result was that the command of the Acapulco galleon was rarely worth less than \$50,000. The passenger fare from Manila to Acapulco, at the end of the 18th century, was \$1000. This monopoly lasted until the Mexican War of Independence forced the Spanish government to regard the Philippines as being in the East instead of the West. Spain's colonial policy was not based on an exaltation of the commercial ideal. However much the administrators may have fallen short in actual practice, the Spanish ideal was to preserve and civilize the native races, rather than to establish lucrative trading posts where the natives might be easily exploited. In America the laws which provided elaborate safeguards for the protection of the Indians were, to a large degree, nullified by the lust for gold and silver and the consequent demand for labourers in the mines. In the Philippines the humane policy of the home government had no such powerful obstacles to contend with. Business was not developed. The natives were allowed to live the indolent life of the tropics. Compared with the results of English or Dutch colonization the conversion and civilization of the Filipinos is a most remarkable achievement. Notwithstanding the undeniable vices, follies and absurd illiberality of the Spanish colonial régime, the Philippines were the only group in the East Indies that improved in civilization in the three centuries following their discovery. The chief defect in the Spanish Philippine policy was that while it made converts it did not make citizens. Self-reliance, free-thought and mental growth were not encouraged. Progress in scientific knowledge was effectively blocked by the friars. Their presses confined their activities to the production of catechisms, martyrologies and handbooks in the native languages after the fashion of the presses of Mexico. Five hundred such works were printed and distributed in Manila alone before 1800. To reach the masses, unfamiliar with Spanish, manuals of devotion and outlines of Christian doctrine were translated into the various native languages. Of the Bible itself, no part was translated or published. A knowledge of reading and writing was generally diffused throughout the group.

The era of discontent may be said to have begun in 1825 when the loss of her colonies on the mainland of America caused Spain to take a more immediate interest in the Philippines, and increased emigration to the islands. Between 1840 and 1872 thirty newspapers were founded. The introduction of secular books and papers, more or less surreptitiously, helped to spread the seeds of sedition. In 1852 the Spanish Filipino Bank was established. In 1856 foreign trade, hitherto confined to Manila, was permitted to enter the port of Iloilo, and foreign traders were allowed to open branch houses outside of the capital. The change in Spain's economic policy, including an attempt to exploit the coalfields and to encourage both agriculture and commerce, helped to awaken hitherto dormant elements. In 1601 the Jesuits had opened a college in Manila for the education of Spanish youth. In 1768 they had been expelled. In 1859 they were permitted to return on the understanding that they were to devote themselves to education.

The Spanish Revolution of 1868 caused a further influx of Spaniards and also the introduction of the pernicious "spoils system." With every change of ministry in Madrid came a new lot of hungry politicians anxious to fill even the more humble colonial offices. The opening of the Suez Canal in 1869, followed by the establishment of direct steam communication between Spain and the Philippines, sounded the death knell of the peaceful

missionary era and brought about the definite entry of the islands into the world of commerce and progress.

The friars, by perpetuating medieval conditions in a country that was now being opened to contact with the civilized world, increased the feeling of discontent. The natural result was a violent conflict. The more advanced Filipinos desired the fulfilment of the decrees of the Council of Trent whereby the incumbencies in Christianized towns and villages should be held by regular clergy and not by friars. Filipinos had for generations been ordained into priesthood although not received into monastic orders. This measure was really aimed at the political and economic supremacy of the Spanish-born friars, who had by this time acquired 400,000 acres of agricultural land, more than half of it in the vicinity of Manila. The agrarian question added to the growing discontent. All the revolutions began in the province of Cavité, where the friars owned 125,000 acres. In 1872 the secret agents of the friars induced the native garrison at Cavité to mutiny and thus give the friars an excuse to press for vigorous action. The mutiny was not successful, but Father Burgos, the leader of the reform party, was publicly garrotted with three other native priests; and the native clergy were declared to be incompetent to have the cure of souls. Several of the richest and best educated Filipinos were convicted of treason and banished.

With the increased facilities for European travel Filipinos began to visit Europe and return with new and broader notions of life. The most distinguished of the travellers was *Rizal* José Rizal (1861-1896). Born in Calainha, in the province of Luzon, of pure Tagalog parentage, he attended the newly reopened Jesuit university in Manila. He was then sent to Europe to complete his studies, first in Madrid, where he became a doctor of medicine, and later in Germany, where he received the degree of Ph.D. He came into touch with advanced methods of scientific research, acquired great ability as a writer, keen perception of truth and an unflinching realization of the defects of his own people, and the unpleasant but essential fact that to have better government they must first deserve it. His propaganda, aimed at the small body of Filipinos who had sufficient education to appreciate political satire, was very effective. His most famous novel, *Noli me tangere*, was published in 1886. In this he drew a masterly picture, not only of the life and immorality of the friars but also of the insolent Filipino chiefs or *caciques*, subservient to the powers above, tyrannical to those below, superstitious, unprogressive and grasping. Caciquism or "bossism," government by local aristocrats, was the prime feature of village life in the islands during the entire period of Spanish rule and existed long before their arrival.

The campaign of Rizal, Marcelo del Pilar, Graciano Lopez Jaena and Apolinario Mabini, the leaders in the "Young Filipino Party," was a protest against both the domination of the friars and economic and administrative caciquism. To escape the vengeance of the friars, Rizal was obliged to flee to Europe. In 1892 he returned to the islands on the assurance of the governor, Eulogio Despujols y Dusay, that he might live there in peace. His enemies, however, succeeded in having him arrested on a charge of treason. Meanwhile he had organized a reform party under the title of *Liga Filipina*. Its object had been to procure, by pacific means, several reforms in the government of the islands, the chief of which were the expulsion of the friars, and the withdrawal of the governor-general's arbitrary power to deport Filipinos. The friars importuned Despujols for Rizal's life but he persistently refused their demand, and met the case half-way by banishing Rizal to Mindanao. Incensed by the failure of their plot, the friars obtained the recall of Despujols.

The new governor, Ramón Blanco, was like Despujols and many of his predecessors, humane at heart, but he could do little more than hold in check the tyrannical schemes of the clergy. The banishment of Rizal convinced the *Katipunan* reform party that peaceful endeavour was futile. A secret organization, the *Katipunan*, was therefore started to secure reforms by force of arms. It was founded by Andrés

Bonifacio, a schoolmaster of Cavité. In 1895-1896 the friars acting as spies for the government, obtained the banishment of many hundreds of natives.

On the day after the Katipunan conspiracy had been brought prematurely to light by a traitor, three hundred prominent

Filipinos were lodged in prison. This precipitated the revolt. ^{Revolt of 1896} The *insurrectos* attacked the civil guard outside the city, but were unsuccessful. A week later some hundreds of insurgents attacked the powder magazine at San Juan del Monte, but were completely routed. Four of their chiefs were taken prisoners and executed in Manila. Ten days after the plot was discovered Manila and five other provinces were officially proclaimed in a state of siege. The *insurrectos* concentrated all their energies upon Cavité province. Several villages fell into their hands. The insurgent commander-in-chief was Emilio Aguinaldo. He was born in 1869 in Cavité, son of a native farmer of considerable ability, and of a half-caste mother whose father was a Chinaman. After attending the Tagalog school at Cavité he entered the Jesuit College in Manila but did not graduate. In 1893 he became municipal alcaide of Cavité, and later joined the Katipunan.

The government was in a difficult position. General Blanco had extremely few European troops at his disposal, and it was doubtful how far native troops could be trusted. Reinforcements were on the way from Spain, but the demands of Cuba had already depleted the Peninsula of the best fighting material. Blanco, blamed for not acting at once, was recalled. In December 1896 General Camilo García de Polavieja (b. 1838) arrived as his successor, with General José Lachambre (b. 1846) as chief of staff. Before Blanco left he had released Rizal and allowed him to go to Spain, but the friars caused his arrest and he was sent back to Manila, where he was executed by Polavieja's orders in December 1896.

Lachambre took the field in Cavité with energy and succeeded in quelling the rebellion in that province. He was then despatched north. Numerous small battles were fought with Aguinaldo and the insurgents, who were repeatedly defeated only to reappear in other places. Polavieja's demand for more troops having been refused, he resigned, and was succeeded in the spring of 1897 by General Fernando-Primo de Rivera. Hostilities continued, but the wet season set in, making operations extremely difficult. Before Primo de Rivera could make much headway against the insurgents affairs in Cuba became so serious that the Spanish government cabled him that pacification was most urgently desired. As a result he suspended operations and signed the treaty of Biacabató (Dec. 12, 1897), by which Aguinaldo and thirty-five of his chief followers were allowed to retire to Hongkong with a cash indemnity of 400,000 pesos. The Madrid government refused to confirm the terms of peace, and the peace rejoicings in Manila were followed by the persecution of all those who were known to have sympathized with the movement.

On the 15th of February 1898 in Havana harbour, the U.S.S. "Maine" was blown up. On the 15th of March Primo de Rivera, learning that the American Commodore George Dewey was mobilizing his fleet in the harbour of

Hongkong, called a council at which the Spanish Admiral Patricio Montojo (b. 1839) stated that, in the event of a conflict, his own fleet would be inevitably destroyed. Primo de Rivera was now recalled and General Basilio Augusti (b. 1840) took his place. With a new governor-general all plans had to be reconsidered. Before suitable defences could be made, word came from Hongkong that Dewey had started for Manila and Montojo hurriedly sailed from Subig Bay to Cavité, barely in time to anchor before Dewey arrived. Few among his crew understood handling a gun properly, and owing to the poor care which his vessels had received they were actually inferior to the individual vessels of the American squadron. Commodore Dewey arrived in the Bay of Manila on the 1st of May, and totally destroyed or disabled the Spanish fleet. The surrender of the city was refused. The Americans occupied Cavité. The battle of Manila Bay and the defeat of the Spanish fleet destroyed the prestige of Spain throughout the islands. Insurrections began

in nearly every province. Aguinaldo and his friends were allowed to come to Cavité in an American transport. With the approval of Commodore Dewey, who allowed arms to be supplied him, Aguinaldo successfully renewed his campaign against the Spaniards until practically all Luzon, except the city of Manila and suburbs, was in his control. Reinforcements arrived, and on the 13th of August Manila was taken by the Americans, under General Wesley Merritt (b. 1836)

The refusal of General Merritt to permit Aguinaldo's troops to enter Manila created resentment on the part of the Filipinos. A so-called constitutional convention was held at Malolos, and a constitution was adopted. At the same time the Visayan Republic was organized, and it professed allegiance to Aguinaldo's government. Neither Aguinaldo's government nor the Visayan government was able to maintain order, and the whole country was subject to the looting of robber bands. The treaty of peace between the United States and Spain, by which the Philippine Islands passed into the hands of the former, was signed in Paris on the 10th of December 1898, but it was not confirmed by the Senate until the 6th of February 1899. During this period the Filipino army remained under arms. On the 4th of February hostilities broke out between the Americans and the Filipinos. The latter were defeated on the 5th, at Paco, with heavy loss. The American troops, now under General E. S. Otis (b. 1838), following up the enemy, drove ^{Revolt} them out of Malolos and then withdrew to ^{Manila} against the Manila to await reinforcements, which brought ^{Americans} the total American force up to about 60,000 men. It is unnecessary to trace in detail the gradual conquest of the islands, or the hundreds of engagements, often small, between the rebels and the Americans. Owing to the nature of the country, and the hope of securing independence from a possible overthrow of the Republican party in the United States, the war was prolonged for two or three years. With the capture of Aguinaldo on the 23rd of March 1901, the resistance became little more than that of guerrillas.

Civil government was introduced as fast as possible. During 1899 the Schurman commission, headed by Dr Jacob G. Schurman of Cornell University, was sent by ^{The Taft} President McKinley to report on the state of affairs. ^{Commission} In February 1900 a second and more powerful commission was appointed, consisting of Judge W. H. Taft, Professor D. C. Worcester (b. 1866), General L. E. Wright (b. 1846), Mr H. C. Ide (b. 1844), and Professor Bernard Moses (b. 1846). Under the presidency of Mr Taft it began to exercise a legislative jurisdiction in September 1900. Its first act was to appropriate \$1,000,000 for the construction and improvement of roads. It next provided for the improvement of Manila harbour, which involved an expenditure of \$3,000,000. The fifth act extended to the islands the benefits of a civil service based on merit. In 1901 a general school law was passed under which 1000 American school teachers were introduced. They were scattered among 500 towns, to teach 2500 Filipino teachers English and modern methods of school teaching. Other legislation provided for the organization of a judiciary, a supreme court, the enactment of a code of civil procedure, the establishment of a bureau of forestry, a health department, and an agricultural bureau and a bureau of constabulary, made up of native soldiers officered by white men. Ladroneism was very widely distributed under Spanish rule, and the old *guardia civil* committed outrages almost equal to those of the brigands themselves. The new constabulary has been eminently successful in maintaining law and order. Great progress has been made in the scientific mapping of the islands.

On the 4th of July 1901 the office of military governor was abolished, the military forces being largely recalled, and the part remaining being made henceforth subordinate ^{Civil} to the civil authorities. Mr Taft became governor-general. A general amnesty was granted to all rebels and political prisoners who would take the oath of allegiance to the United States. On the 1st of July 1902 President

Roosevelt signed an act establishing the civil government of the Philippines and providing for a new legislative body. A census was authorized and was taken in 1903. The act of 1902 also authorized the purchase of land belonging to the friars. Although among such an ignorant and diversified body as that of the Filipinos public opinion can hardly be said to exist, there is no doubt that the hatred of the friars was practically universal. When the revolution came the members of the four orders had to flee for their lives, although the people who killed or imprisoned those they could catch were generally good Catholics. As the insular government could not safely allow the friars to return to their parishes the friars' lands were bought for \$7,000,000. Mr Taft managed the delicate task of conducting negotiations with the Vatican without arousing the hostility of either Catholics or Protestants. On the 1st of February 1904 General L. E. Wright became governor. He was succeeded in 1905 by Mr H. C. Ide, who was succeeded by General James T. Smith in 1906. The elections for the first Philippine Assembly were held on the 30th of July 1907, and 31 Nationalists, 16 Progressives, 33 Independents and others were elected. The total vote cast was about 100,000. In many districts the Nationalists' candidates promised that if they were returned immediate independence would follow. When the Assembly met it became apparent that the great majority were more anxious to act as a dignified branch of the legislature than to maintain consistency with their pre-election declarations. The legislature convened for its second session on the 1st of February 1909. During this session 72 laws were passed, of which 23 had been introduced by the Commission and 49 by the Assembly. Among the acts was one providing for the continuance of Spanish as the official language of the courts until 1913; an act providing for bankruptcy; and an act fixing the age of majority at 21 years.

Governor Smith left the islands in May 1909 and was succeeded by W. Cameron Forbes. On the 6th of August 1909 the Payne and Colton bills became law, greatly promoting trade between the Islands and the United States (see *Communications and Commerce*). On the 2nd of November 1909 delegates were elected for the second Philippine Assembly. (H. Bl.)

BIBLIOGRAPHY.—See, in general, A. P. C. Griffin, *A Last of Books on the Philippine Islands in the Library of Congress* (Washington, 1903), with references to periodicals; T. H. Pardo de Tavera, *Biblioteca Filipina* (ibid. 1903); W. E. Retana, *Aparato bibliográfico de la historia general de Filipinas* (3 vols., Madrid, 1906); idem, *Archivo de bibliófilo Filipino* (Madrid, 1895); J. A. Robertson, *Bibliography of the Philippine Islands* (Cleveland, Ohio, 1908). For statistics, general description and material on administration, see *Census of the Philippine Islands in 1903* (4 vols., Washington, 1905); *Pronouncing Gazetteer and Geographical Dictionary of the Philippine Islands* (Washington, 1902); *Ethnological Survey Publications of the Department of the Interior* (Manila, 1904 sqq.); *Reports of the Philippine Commission* (Washington, 1901 sqq.); Sir John Bowring, *A Visit to the Philippine Islands* (London, 1859); D. C. Worcester, *The Philippine Islands and their People* (New York, 1898); F. W. Atkinson, *The Philippine Islands* (Boston, 1905); C. H. A. F. Lindsay, *The Philippines under Spanish and American Rules* (Philadelphia, 1906); A. H. S. Landor, *The Gems of the East* (New York, 1904); M. A. Hamm, *Manila and the Philippines* (London, 1898); J. A. LeRoy, *Philippine Life in Town and Country* (ibid. 1905); J. B. Devins, *An Observer in the Philippines* (Boston, 1905); R. R. Lala, *Philippine Islands* (New York, 1899); H. C. Potter, *The East To-day and To-morrow* (ibid. 1902); E. Blumentritt, *Die Philippinen* (Hamburg, 1900); H. P. Willis, *Our Philippine Problem, a Study of American Colonial Policy* (New York, 1905); Edith Moses, *Unofficial Letters of an Official's Wife* (ibid. 1908); W. B. Freer, *The Philippine Experiences of an American Teacher* (ibid. 1906); J. G. Schurman, *Philippine Affairs* (ibid. 1902); W. H. Taft, *Civil Government in the Philippines* (ibid. 1902); and *Special Report to the President on the Philippines* (Washington, 1908); and R. C. McGregor, *Manual of Philippine Birds* (New York, 1909). For the history of the islands, see E. H. Blair and J. A. Robertson, *The Philippine Islands, 1493-1898* (55 vols., Cleveland, 1903-1909); J. Montero y Vidal, *Historia general de Filipinas* (3 vols., Madrid, 1887-1895); Juan de la Concepcion (1724-1797), *Historia general de Filipinas* (14 vols., Manila, 1788-1792); Gaspar de San Agustín (1650-1724), *Conquistas de las islas Philipinas* (2 vols., Valladolid, 1890); Le Gentil, *Voyage dans les mers de l'Inde* (Paris, 1781); F. Colin Labor evangelica, *ministerios apostolicos de los obreros de la compañía de Jesus, fundacion, y progresos de su provincia en islas Filipinas*

(3 vols., Barcelona, 1900-1902); J. Martinez de Zúñiga, *Historia de las islas Philipinas* (Sampaloc, 1803; Eng. trans., London, 1814); J. J. Delgado, *Historia general sacro-profana, politica y natural de las islas del Poniente, llamadas Filipinas* (Manila, 1802); E. G. Bourne, *Discovery, Conquest and Early History of the Philippine Islands* (Cleveland, 1907); F. Combes (1620-1665), *Historia de Mindanao y Joló* (Madrid, 1897); J. M. Castillo y Jimenez, *El Katipunan ó el filibusterismo en Filipinas* (Madrid, 1897); E. R. Delmas, *La Insurreccion de Filipinas en 1806 y 1807* (2 vols., Barcelona, 1899); F. D. Millet, *The Expedition to the Philippines* (London, 1899); and J. Fellicena y López, *La Verdad sobre Filipinas* (Manila, 1900).

PHILIPPPOPOLIS (Bulgarian, *Plodiv*; Turkish, *Felibe*), the capital of Eastern Rumelia, and of the department of Philippopolis, Bulgaria; situated in the midst of picturesque granite eminences on the right bank of the river Maritza, 96 m. E.S.E. of Sofia and 97 m. W.N.W. of Adrianople. Pop. (1906) 45,572, of whom a large majority are Bulgarians, and the remainder chiefly Turks, Greeks, Jews, Armenians or gipsies. Philippopolis is on the main railway from Vienna to Constantinople, via Belgrade and Sofia. The Maritza is navigable up to this point, and as the city has communication by rail both with the port of Dédéagatch on the Mediterranean and that of Burgas on the Black Sea, and is situated in a remarkably fertile country, it has become the chief commercial centre of southern Bulgaria, and is the seat of both Greek and Bulgarian archbishops. The residences of the richer Greeks and Bulgarians occupy the slopes of the largest eminence, the Jambaz-tépé, in the centre of the city; between it and the Nobet-tépé, from the summit of which there is a magnificent view of the city, is the Armenian quarter; near the bridge over the Maritza is the poorer Turkish quarter; and south-west of the Jambaz-tépé there is a suburb of villas. On the Bunari-tépé a monument has been erected by the Russians in commemoration of the war of 1877, and near this is the new palace of the king of Bulgaria. The Sahub-tépé is crowned by a clock-tower. Not far from it are the beautiful Exhibition Park laid out in 1892 and the fine Journaia-Jami Mosque. Near the Maritza are the remains of the ancient konak (palace) of the Turkish pashas, the public park formed by the Russians in 1877, the gymnasium, and the new Greek cathedral. The city has a large commerce in rice, attar of roses, and cocoons; other exports being wheat, wine, tobacco, alcohol and hides.

Eumolpia, a Thracian town, was captured by Philip of Macedon and made one of his frontier posts; hence its name of *Philippopolis*, or "Philip's City." Under the Romans Philippopolis or Trimontium became the capital of Thracia; and, even after its capture by the Goths, when 100,000 persons are said to have been slain, it continued to be a flourishing city till it was again sacked by the Bulgarians in 1205. It passed under Turkish rule in 1363; in 1818 it was destroyed by an earthquake; and in 1846 it suffered from a severe conflagration. During the war of 1877-78 the city was occupied by the Russians (see also BULGARIA: *History*).

PHILIPPSBURG, a town of Germany, in the grand duchy of Baden, situated on a sluggish arm of the Rhine, 15 m. N. of Karlsruhe, on the railway Bruchsal-Germersheim. Pop. (1905) 2625. It has manufactures of tobacco and cigars, and some trade in cattle and hops. Philippsburg, formerly an important fortress, originally belonged to the ecclesiastical principality of Spire, and was named Udenheim. In 1338 it was surrounded with walls by bishop Gerhard. A later bishop of Spire, Philipp Christoph von Sötern, made the place his residence early in the 17th century, strengthened the fortifications, and renamed it Philippsburg after himself. At the peace of Westphalia in 1648 the French remained in possession of the town, but in 1679 it was restored to Germany, and though again captured by the French in 1688 it was once more restored in 1697. In 1734 the dilapidated fortress fell an easy prey to the French under Marshal Berwick, who, however, lost his life beneath its walls. It was restored to Germany in 1735, and was again besieged by the French in 1799. The town was assigned to Baden in 1803.

See Nopp, *Geschichte der Stadt Philippsburg* (Philippsburg, 1881).

PHILIPPUS, MARCUS JULIUS, Roman emperor A.D. 244 to 249, often called "Philip the Arab," was a native of Bostra in Arabia Trachonitis. Having entered the Roman army, he rose to be praetorian praefect in the Persian campaign of Gordian III, and, inspiring the soldiers to slay the young emperor, was raised by them to the purple (244). Of his reign little is known except that he celebrated the secular games with great pomp in 248, when Rome was supposed to have reached the thousandth year of her existence. A rebellion broke out among the legions of Moesia, and Decius, who was sent to quell it, was forced by the troops to put himself at their head and march upon Italy. Philip was defeated and slain in a battle near Verona. According to Christian writers, he was a convert to Christianity. See Aurelius Victor, *Caesares*, 28; Eutropius, ix. 3; Zonaras, xii. 19.

PHILIPS, AMBROSE (c. 1675-1740), English poet, was born in Shropshire of a Leicestershire family. He was educated at Shrewsbury school and St John's College, Cambridge, of which he became a fellow in 1699. He seems to have lived chiefly at Cambridge until he resigned his fellowship in 1708, and his pastorals probably belong to this period. He worked for Jacob Tonson the bookseller, and his *Pastorals* opened the 6th volume of Tonson's *Miscellanies* (1709), which also contained the pastorals of Pope. Philips was a staunch Whig, and a friend of Steele and Addison. In Nos. 22, 23, 30 and 32 (1713) of the *Guardian* he was injudiciously praised as the only worthy successor of Spenser. The writer of the papers, who is supposed to have been Thomas Tickell, pointedly ignored Pope's pastorals. In the *Spectator* Addison applauded him for his simplicity, and for having written English eclogues unencumbered by the machinery of classical mythology. Pope's jealousy was roused, and he sent an anonymous contribution to the *Guardian* (No. 40) in which he drew an ironical comparison between his own and Philip's pastorals, censuring himself and praising Philip's worst passages. Philips is said to have threatened to cane Pope with a rod he kept hung up at Button's coffee-house for the purpose. It was at Pope's request that Gay burlesqued Philip's pastorals in his *Shepherd's Week*, but the parody pleased by the very quality of simplicity which it was intended to ridicule. Samuel Johnson describes the relations between Pope and Philips as a "perpetual reciprocation of malevolence." Pope lost no opportunity of scoffing at Philips, who figured in the *Balkos* and the *Dunciad*, as Macer in the *Characters*; and in the "Instructions to a porter how to find Mr Curll's authors" he is a "Pindaric writer in red stockings." In 1718 he started a Whig paper, *The Freethinker*, in conjunction with Hugh Boulter, then vicar of St Olave's, Southwark. He had been made justice of the peace for Westminster, and in 1717 a commissioner for the lottery, and when Boulter was made archbishop of Armagh, Philips accompanied him as secretary. He sat in the Irish parliament for Co. Armagh, was secretary to the lord chancellor in 1726, and in 1733 became a judge of the prerogative court. His patron died in 1742, and six years later Philips returned to London, where he died on the 18th of June 1749.

His contemporary reputation rested on his pastorals and epistles, particularly the description of winter addressed by him from Copenhagen (1709) to the earl of Dorset. In T. H. Ward's *English Poets*, however, he is represented by two of the simple and charming pieces addressed to the infant children of Lord Carteret and of Daniel Pulteney. These were scoffed at by Swift as "little flams on Miss Carteret," and earned for Philips from Henry Carey the nickname of "Nabby-Pamby."

Philips's works are an abridgment of Bishop Hackett's *Life of John Williams* (1700); *The Thousand and One Days*; *Persian Tales* (1722), from the French of F. Pétis de la Croix; three plays: *The Distrest Mother* (1712), an adaptation of Racine's *Andromaque*; *The Briton* (1722); *Humfrey, Duke of Gloucester* (1723). Many of his poems, which included some translations from Sappho, Anacreon and Pindar, were published separately, and a collected edition appeared in 1748.

PHILIPS, JOHN (1676-1708), English poet and man of letters, son of Dr Stephen Philips, archdeacon of Shropshire, was born at his father's vicarage at Bampton, Oxfordshire, on the 30th of December 1676. He was educated at Winchester and Christ

Church, Oxford. He was a careful reader of Virgil and of Milton. In 1701 his poem, *The Splendid Shilling*, was published without his consent, and a second unauthorized version in 1705 induced him to print a correct edition in that year. *The Splendid Shilling*, which Addison in *The Teller* called "the finest burlesque poem in the British language," recites in Miltonic blank verse the miseries consequent on the want of that piece of money. Its success introduced Philips to the notice of Robert Harley and Henry St John, who commissioned him to write a Tory counterblast to Joseph Addison's *Campaign*. Philips was happier in burlesquing his favourite author than in genuine imitation of a heroic theme. His Marlborough is modelled on the warriors of Homer and Virgil; he rides precipitate over heaps of fallen horses, changing the fortune of the battle by his own right arm. *Cyder* (1708) is modelled on the *Georgics* of Virgil. *Cerealia, an Imitation of Milton* (1706), although printed without his name, may safely be ascribed to him. In all his poems except *Blenheim* he found an opportunity to insert an eulogy of tobacco. Philips died at Hereford on the 15th of February 1708/9. There is an inscription to his memory in Westminster Abbey.

See *The Whole Works of . . . John Philips . . . To which is prefixed his life*, by Mr [G.] Sewall (3rd ed., 1720); Johnson, *Lives of the Poets*; and *Biographia Britannica*.

PHILIPS, KATHARINE (1631-1664), English poet, daughter of John Fowler, a merchant of Bucklebury, London, was born on the 1st of January 1631. Her father was a Presbyterian, and Katharine is said to have read the Bible through before she was five years old. On arriving at years of discretion she broke with Presbyterian traditions in both religion and politics, became an ardent admirer of the king and his church policy, and in 1647 married James Philips, a Welsh royalist. Her home at the Priory, Cardigan, became the centre of a "society of friendship," the members of which were known to one another by fantastic names, Mrs Philips being "Orinda," her husband "Antenor," Sir Charles Cotterel "Poliarachus." The "matchless" Orinda, as her admirers called her, posed as the apostle of female friendship. That there was much solid worth under her affectations is proved by the respect and friendship she inspired. Jeremy Taylor in 1650 dedicated to her his "Discourse on the Nature, Offices and Measures of Friendship," and Cowley, Henry Vaughan the Silurist, the earl of Roscommon and the earl of Cork and Orrery all celebrated her talent. In 1662 she went to Dublin to pursue her husband's claim to certain Irish estates, and there she completed a translation of Cornelle's *Pompeii*, produced with great success in 1663 in the Smock Alley Theatre, and printed in the same year both in Dublin and London. She went to London in March 1664 with a nearly completed translation of Cornelle's *Horace*, but died of smallpox on the 22nd of June. The literary atmosphere of her circle is preserved in the excellent *Letters of Orinda to Poliarachus*, published by Bernard Lintot in 1705 and 1709. "Poliarachus" (Sir Charles Cotterel) was master of the ceremonies at the court of the Restoration, and afterwards translated the romances of La Calprenède. Mrs Philips had two children, one of whom, Katharine, became the wife of Lewis Wogan of Boulton, Pembrokeshire. According to Mr Gosse, this lady may have been "Joan Philips," the author of a volume of *Female Poems . . . written by Ephelia*, which are in the style of Orinda, and display genuine feeling with very little reserve.

See E. W. Gosse, *Seventeenth Century Studies* (1883). *Poems; By the Incomparable Mrs K. P.* appeared surreptitiously in 1664 and an authentic edition in 1667. *Selected Poems*, edited with an appreciation by Miss L. I. Guiney, appeared in 1904; but the best modern edition is in Saintsbury's *Minor Poets of the Caroline Period* (vol. I, 1905).

PHILISTINES,¹ the general name for the people of Philistia (Ass. *Palaštu*, *Pilištu*; Eg. *p-r-s-s*), a district embracing the rich lowlands on the Mediterranean coast from the neighbourhood of "Philistine," as a term of contempt, hostility, or reproach, appears first in English, in a sense equivalent to "the enemy," as early as the beginning of the 17th century, and later as a slang term for a bailiff or a sheriff's officer, or merely for drunken or vicious people generally. In German universities the townsfolk

of Jaffa (Joppa) to the Egyptian desert south of Gaza (on the subsequent extension of the name in its Greek form *Palaestina*, see PALESTINE).

1. *Egyptian Evidence.*—The name is derived from the Purasati, one of a great confederation from north Syria, Asia Minor and the Levant, which threatened Egypt in the XXth Dynasty. They are not among the hordes enumerated by Rameses II. or Merneptah, but in the eighth year of Rameses III. (c. 1200-1190) the Purasati hold a prominent place in a widespread movement on land and sea. The Syrian states were overwhelmed and the advance upon Egypt seemed irresistible. Rameses, however, collected a large fleet and an army of native troops and mercenaries and claimed decisive victories. The Egyptian monuments depict the flight of the enemy, the heavy ox-carts with their women and children, and the confusion of their ships. But the sequel of the events is not certain. Even if the increasing weakness of the Egyptian Empire did not invite a repetition of the incursion, it could have allowed the survivors to settle down, and about a century later one of the peoples formerly closely allied with the Purasati is found strongly entrenched at Dor, and together with the more northerly port of Byblos treats with scant respect the traditional suzerainty of Egypt.¹ That some definite political changes ensued in this age have been inferred on other grounds, and the identification of the Purasati with the Philistines may permit the assumption that the latter succeeded in occupying the district with which they have always been associated.

The Egyptian monuments represent the Purasati with a very distinctive feather head-dress resembling that of the Lycians and Mycenaeans. Their general physiognomy is hardly Cilician or Hittite, but European. Their arms comprise two short swords, a longer spear, a round shield, and they sometimes wear a coat of mail; a curious feature is their tactics of fighting in a circle of protecting shields. The chariots resemble the Hittite with two crossed receptacles for the weapons, but obviously these were not used by the Purasati alone. On archaeological grounds the Purasati have been connected with the people of Keftiu, i.e. Mycenaeans of Crete, although a wider application of this term is not to be excluded.

See further, G. Maspero, *Siraggle of the Nations*, pp. 461 sqq.; W. M. Müller, *Asien u. Europa*, pp. 354 sqq.; *Mitteil. d. Vorderasiat. Gesell.*, pp. 1-42 (1900), pp. 113 sqq. (1904); H. R. Hall, *British School of Athens*, viii. 157 sqq., x. 154 sqq.; *Proc. Soc. Bibl. Arch.* xxxi. (1909) *passim*; R. Weill, *Rev. archéol.*, i. 52 sqq. (1904); R. Dussaud, *Rev. de l'hist. des rois*, ii. 52 sqq. (1905). More recently, A. Wiedemann, *Oriental. u. Zeit.* (1910), cols. 49 sqq. disputes the identification of Keft with Crete.

2. *History.*—Biblical tradition, too, has recognized the Philistines as immigrants from Caphtor (Amos ix. 7). They appear in the pre-Mosaic age (Gen. xxi. 32, 34, xxvi.), at the Exodus of the Israelites (Ex. xiii. 17, xv. 14), and the invasion of Palestine. They are represented as a confederation of five cities (Ashdod, Ascalon [Ashkelon], Ekron, Gath and Gaza) which remained unconquered (Joshua xiii. 2 sqq., Judges iii. 3; contrast Joshua xv. 45-47, xix. 43). The institution of the Hebrew monarchy (c. 1000 B.C.) follows upon periods of Philistine oppression (Judges iii. 31, x. 7, xi. xiii. 1-5; see SAMSON; ELI; SAMUEL; SAUL; DAVID). The subjugation of them is ascribed were called by the students *Philistia*; they were "outsiders," the enemy of the chosen people. It is supposed that this use arose in 1693 in Jena after a "town and gown" row in which a student had been killed and a sermon preached on the text "the Philistines be upon you, Samson" (see *Quarterly Review*, April 1899, 438, note, quoted in the *New English Dictionary*). "Philistine" thus became the name of contempt applied by the cultured to those whom they considered beneath them in intellect and taste, and was first so used in English by Carlyle, and Matthew Arnold (*Essays in Criticism*, "Heinrich Heine", 1865) gave the word its vogue and its final connotation, as signifying "inaccessible to and impatient of ideas."—[Ed.]

¹ See the Papyrus first published by W. Golénischeff (*Rec. de travaux*, xxi. 74 sqq.), on which see A. Erman, *Zeit. f. ägypt. Sprache*, pp. 1-14 (1900); W. M. Müller, *Mitteil. d. Vorderasiat. Gesell.*, pp. 14 sqq. (1900); J. H. Breasted, *Hist. of Eg.*, pp. 513 sqq.; *Historical Records*, iv. 274 sqq.; H. W. Hogg, in the *Theolog. Series I.* of the publications of university of Manchester, p. 90 sqq.

to Samuel (1 Sam. vii. 13), Saul (xiv. 47), and David (2 Sam. viii. 1; for Solomon see 1 Kings x. 20); but they evidently recovered their independence, and we find that twice within a short time the northern Israelites laid siege to the border fortress of Gibbethon (1 Kings xv. 27, xvi. 15). Although this place has not been identified, it is mentioned in a list of Danite cities with Ajalon, Ekron, Elekeh and Timnah (Joshua xix. 44, xxi. 23), names of importance for the history. Somewhat later the evidence becomes fuller, and much valuable light is thrown upon the part which the Philistine coast played in the political history of Palestine. Gaza, the most southerly and famous of the Philistine towns, was the terminus of the great caravan-route from Edom and south Arabia, with whose Bedouin it was generally on good terms. It was "the outpost of Africa, the door of Asia" (G. A. Smith), the stepping-off point for the invasion of Egypt, and the fortress which, next in importance to Lachish, barred the maritime road to Phoenicia and Syria.² It is necessary to realize Gaza's position and its links with trading centres, since conditions in the comparatively small and half-desert land of Judah depended essentially upon its relations with the Edomites and Arabian tribes on the south-east and with the Philistines on the west.³ Jehoshaphat's supremacy over Philistines and Arabians (2 Chron. xvii. 11, partly implied in 1 Kings xxii. 47) is followed by the revolt of Libnah (near Lachish) and Edom against his son Jehoram (2 Kings viii. 20, 22). The book of Chronicles mentions Philistines and Arabians, and knows of a previous warning by a prophet of Mareshah (east of Lachish; 2 Chron. xx. 37, xxi. 16). In like manner, the conquests of Uzziah over Edom and allied tribes (2 Kings xiv. 22, see 2 Chron. xxvi. 7) and over Gath, Ashdod and Jabneh (ibid. v. 6) find their sequel in the alliance of Samaria and Damascus against Ahab, when Edom recovered its independence (so read for "Syria" in 2 Kings xvi. 6), and the Philistines attacked Beth-shemesh, Ajalon, Timnah, &c. (2 Chron. xxviii. 17 sqq.).⁴ These notices at least represent natural conditions, and the Assyrian inscriptions now are our authority. Tiglath-pileser IV. (734 B.C.) marched down and seized Gaza, removing its goods and goods. Its king Hanun had fled to Musri, but was pursued and captured; Ascalon, Judah and Edom appear in a list of tributaries. Musri was entrusted to the care of the Arabian Idibi'il (of the desert district), but continued to support anti-Assyrian leagues (see HOSHIA), and again in 720 (two years after the fall of Samaria) was in alliance with Gaza and north Palestine. Assyria under Sargon defeated the southern confederation at Raphia (Raphia on the border of Egypt) and captured Hanun; the significance of the victory is evident from the submission of the queen of Arbi (Arabia), the Sabaean Itamara, and Musri. This Musri appears to have been a district outside the limits of Egypt proper, and although tribes of the Delta may well have been concerned, its relations to Philistia agree with the independent biblical account of the part played previously by Edom and Arabian tribes (see MIZRAIM). But the disturbances continued, and although desert tribes were removed and settled in Samaria in 715, Musri and Philistia were soon in arms again. Ashdod (see Isa. xx.) and Gath were taken and sacked, the people removed, and fresh colonies were introduced. Judah, Edom and Moab were also involved, but submitted (711 B.C.). Scarcely ten years passed and the whole of Palestine and Syria was again torn with intrigues. Sennacherib (Sargon's successor in 705) marched to the land of the "Hittites," traversed

² See G. A. Smith, *Hist. Geog. of the Holy Land*, chs. ix. sqq.; and M. A. Meyer, *History of the City of Gaza* (New York, 1907). For the traditions associating Gaza with Crete, see the latter, *Index*, s.v. Minoes; the resemblance between the Minoans of South Arabia and Cretan Minoas has afforded grounds for all kinds of speculations, ancient (Pliny vi. 157) and modern.

³ Between the central Judean plateau and the later lay the "lowlands" (Shephélah), a district open equally to Judeans and Philistines alike.

⁴ Cf. Gaza and Edom against Judah in Amos i. 6, and, for the part played by Damascus, the later vicissitudes under the Nabataeans (Josephus, *Ant.* xiii. 13. 3). It is difficult to date the alliance of Syria and Philistia against Israel in Isa. ix. 11 sqq. (on the text, see the commentaries).

the coast and, descending from Sidon, took Jaffa, Beth-dagon, Beneberak, Ekron and Timnah (all in the district ascribed to the southern Dan). At Ektekeh (also in Dan) the allies were defeated. Farther south came the turn of Ascalon, Lachish and Libnah; Judah under Hezekiah suffered severely, and its western cities were transferred to the faithful vassals of Ekron, Ashdod and Gaza. The immediate subsequent events are obscure (see further HEEZEKIAH). In the 7th century Gaza, Ascalon, Ashdod and Ekron were Assyrian vassals, together with Judah, Moab and Edom—in all, twenty-two kings of the "Hittites"—and the discovery of Assyrian contract-tablets at Gezer (c. 650) may indicate the presence of Assyrian garrisons. But as the Assyrian power declined Egyptian monarchs formed plans of aggrandizement. Herodotus mentions the Scythian invasion and sack of the temple of Aphrodite Urania (Astarte) at Ascalon, also the prolonged siege of Ashdod by Psammeticus, and the occupation of Kadytis (? Gaza) by Necho (l. 105, ii. 257 sqq., iii. 5). But the Babylonian Empire followed upon traditional lines and thrust back Egypt, and Nabonidus (553 B.C.) claims his vassals as far as Gaza. The Persians took over the realm of their predecessors, and Gaza grew in importance as a seat of international commerce. Nehemiah speaks not of Philistines, but of Ashdodites (iv. 7), speaking an "Ashdodite" dialect (xiii. 24); just as Strabo regards the Jews, the Idumeans, the Gazans and the Ashdodites as four cognate peoples having the common characteristic of combining agriculture with commerce. In southern Philistia at least, Arabian immigration became more pronounced. In the time of Cambyses Arabs were settled at Janyos south of Gaza (Herod. iii. 5), and when Alexander marched upon Egypt, Gaza with its army of Arabs and Persians offered a strenuous resistance. Recent discoveries near Tell Sandahannah (or Marehab) have revealed the presence of North Arabian (Edomite) names about the 2nd century B.C.¹ On the history of the district see further JEWS; MACCABEES; PALESTINE.

3. *Philistine Traditions.*—The interdependence of the south Palestinian peoples follows from geographical conditions which are unchangeable, and the fuller light thrown upon the last decades of the 8th century B.C. illuminates the more fragmentary evidence elsewhere.² Hence the two sieges of the Philistine Gibeon by the Israelites (above) obviously have some significance for Judean history, but the Judean annals unfortunately afford no help (see ASA). Again, the Aramean attack upon Israel by Hazael of Damascus leads to the capture of Gath (2 Kings xii. 17), and this, together with the statement that he took "the Philistine" from Jehoahaz of Israel (ibid. xiii. 22, Lucian's recension), bears upon Judah, but the statements are isolated. Somewhat later the Assyrian king Adad-nirari IV. claimed tribute from Edom, Philistia and Beth-Omri (the Israelite kingdom); the curious omission of Judah has suggested that it was then included with the second or third of these (see JEWS, § 12). The Philistines naturally had a prominent place in popular tradition, and the story of Isaac and the Philistine Abimelech (Gen. xxvi., cf. xxi. 32) is of great interest for its unbiased representation of intercourse, enmity, alliance and covenant. But it is important to notice that a parallel story (xx.) is without this distinctively *Philistine* background, and this variation is significant. One account of the Israelite invasion conceived a conquest of earlier giant inhabitants (Anakim) who survived in Gaza, Gath and Ashdod (Joshua xi. 21 seq., contrast xiii. 3), but were driven out from Hebron by Caleb (Joshua xv. 14, cf. Num. xiii. 22, 28). The Philistines themselves are called the remnant of the Anakim (Jer. xlvi. 5, so the Septuagint), or as Caphtorim replace the earlier Avvim

¹ Peters and Thiersch, *Painted Tombs in the Necropolis of Marissa* (1905).

² Thus, the capture of Gezer by Egypt (1 Kings ix. 16) was presumably only part of some more extensive operations, but their relation to Shishak's great Palestine campaign is uncertain; see A. Alt, *Israel as Aegyptian*, pp. 10-38 (Leipzig, 1909). It would be unsafe to infer much from the Eg. reference to the "messenger" (empty, meaning ambiguous) of Canaan and Philistia (*Bull. Mus. Cairo*, i. 98).

(Deut. ii. 23, see Joshua xiii. 3). Samuel's great defeat of the Philistines leads to "peace between Israel and the Amorites" (1 Sam. vii. 14); and the migration of the Danites is placed after Samson's conflicts with the Philistines (Judges xviii. seq.), or is due to the pressure of Amorites (i. 34). Even in David's fights with the Philistines in Judah, Jerusalem is Jebusite, neighbouring non-Israelite cities are Hivite or Amorite (Joshua ix. 7, 2 Sam. xxi. 2), and his strange adversaries find a close parallel in the semi-mythical sons of Anak (2 Sam. xxi. 16, 18, 20, 22). This fluctuation, due partly to the different circles in which the biblical narratives took shape, and partly to definite reshaping of the traditions of the past, seriously complicates all attempts to combine the early history of Israel with the external evidence. The history of the Philistine district goes back long before the time of the Purasati (c. 1200 B.C.), and if the references to Philistines in pre-Mosaic times are treated as anachronisms, those which can be applied to the 12th-11th century do not at once acquire an historical value.³ The references of the time of the Exodus, the Invasion and the "Judges"—whatever chronological scheme be adopted—must be taken in connexion with a careful examination of all the evidence. It is inherently not improbable that a recollection has been preserved of Philistine oppressions in the 11th century, but it is extremely difficult to sketch any adequate sequence of events, and among the conflicting traditions are situations equally applicable to later periods of hostility. Biblical history has presented its own views of the Israelite and Judean monarchies; Israel has its enemies who come pouring forth from the south (1 Sam. xiii. 17, 18), while the founder of the Judean dynasty has intimate relations with a Philistine king Achish (or Abimelech, Ps. xxxiv.), or, from another point of view, clears the district of a prehistoric race of giants. In the stories of Samson and Samuel, the Philistines are located in the maritime plain, whereas, in the oldest traceable account of Saul's rise (apparently shortly before 1000 B.C.) they hold Israel (1 Sam. ix. 16, xiii. 3 seq., 7, xiv. 1, 11, 21). But there is no historical continuity between the two situations, and the immediate prelude to the achievements of Saul and Jonathan is lost. The biblical evidence does not favour any continued Philistine domination since the time of Rameses III., who indeed, later in his reign, made an expedition, not against the Purasati, but into North Syria, and, as appears from the Papyrus Harris, restored Egyptian supremacy over Palestine and Syria. Upon the (incomplete) external evidence and upon a careful criticism of the biblical history of this period, and not upon any promiscuous combination of the two sources, must depend the value of the plausible though broad reconstructions which have been proposed.⁴

Considerable stress is often laid upon Goliath's armour of bronze and his iron weapon, but even David himself has helmet, sword and coat-of-mail at his disposal (1 Sam. xvii.), and suits of armour had already been taken from Mesopotamia by Tethmosis III. Chariots of iron are ascribed to the Canaanites (Joshua xvii. 16, 18, Judges i. 19, iv. 3); but if early references to iron are treated as unhistorical (Gen. iv. 22, Num. xxxi. 22, xxv. 16, Deut. iv. 20, viii. 9, xix. 5, xxvii. 5, xxviii. 48, xxxiii. 25, Joshua vi. 19, 24) Goliath's iron spear-head must be judged together with the whole narrative in the light of a consistent historical criticism.⁵

³ The inhabitants of Ascalon besieged by Rameses II. are represented as Hittites. For an attempt to treat the pre-Mosaic references as historical, see A. Noordt, *De Philistijnen* (Kampen, 1906).

⁴ See on these, W. M. Müller, *Mittel. d. Vorderasiat. Gesell.* p. 39 seq.; G. F. Moore, *Ency. Bib.*, art. "Philistines," col. 3720 seq., and cf. H. W. Hogg, *op. cit.* p. 91. For the suggestion that the "Philistines" have in certain cases taken the place of another ethnic, see S. A. Cook, *Crit. Notes on O. T. History*, pp. 43 seq., 127 seq., 131 seq., 136 seq., 144; cf. from another point of view, T. K. Cheyne, *Decline and Fall of Kingdom of Judah* (1908), pp. xx. seq. The introduction of iron has been ascribed to about 1000 B.C. (Macalister, *Quart. Statem.* p. 121 [1903], as against p. 122 [1904]; H. Vincent, *Canaan d'après l'exploration récente*, p. 235 seq.). It need hardly be said that the height and might of Goliath must be regarded in the same way as Num. xiii. 32; Deut. ii. 11. The men of the heroic age are giants, as were the Ad and Thaumad to the later Arabs.

4. *Conclusions.*—The Philistines appear in the Old Testament as a Semitic or at least a thoroughly Semitized people. Their proper names show that before and even during the Persian age their languages differed only dialectically from Hebrew. Among the exceptions must be reckoned Achish (Sept. ἀχίσις), with which has been compared Iksu, a king of Ekron (7th century) and the "Keftian" name *Achashok* of the XIXth Egyptian dynasty. Names in *-ash* (Goliath; Ahuzzath, Gen. xvi.) are not restricted to Philistines, and Phicol (ibid.) is too obscure to serve as evidence. The religion is not novel. The male god Dagon has his partner Astarte (q.v.), and Baal-zebub, a famous oracle of Ekron (2 Kings i.) finds a parallel in the local "baals" of Palestine.¹ Even when the region seems to be completely Hellenized after the Persian age, it is not so certain that Greek culture pervaded all classes (see G. F. Moore, *Ency. Bib.* col. 3726), although a certain amount of foreign influence probably made itself felt upon the coast-towns at all times. The use of the term ἀλλοφύλος in Maccabean and later writings (cf. the contemptuous hatred of Ben Sira, Ecclesiasticus i. 26, and the author of Jubilees xxiv. 30 sqq.) correctly expresses the conditions of the Greek age and the Maccabean wars, and naturally an allusion to the situations of many centuries previously is quite unnecessary. Similarly, the biblical evidence represents the traditions in the form which they had reached in the writer's time, the true date of which is often uncertain. Antagonism between Philistines and Israelites was not a persisting feature, and, although the former are styled "uncircumcised" (chiefly in the stories in the book of Samuel), the term gained new force when the expulsion of uncircumcised aliens from the sanctuary of Jerusalem was proclaimed in the writings ascribed to Ezekiel (ch. xliv.).²

In fact the question arises whether the history of the Philistines is not that of a territorial designation, rather than that of the lineal descendants of the Purasati, who, if one of the peoples who took part in the events of the XXth Dynasty, may well have bequeathed their name. The Mediterranean coast-land was always exposed to incursions of aliens, and when Carians appear as royal and temple guards at Jerusalem (2 Kings xi. 4), it is sufficient to recall old Greek traditions of a Carian sea-power and relations between Philistia and Greek lands.³ Even the presence of Carians and Ionians in the time of Psammetichus I. may be assumed, and when these are planted at Deneh it is noteworthy that this is also closely associated with a Jewish colony (viz. Tahpanhes, Jer. xliii. seq.). Although the Purasati appear after the 15th-14th centuries, now illuminated by the Amarna tablets, their own history is perhaps earlier.⁴ But there is no reason at present to believe that their entrance caused any break in the archaeological history. The apparently "Aegean" influence which enters into the general "Amarna" period seems to begin before the age of the Amarna tablets (at Lachish), and it passes gradually into later phases contemporary with the

¹ See further, F. Schwally, *Zeit. Wissensch. Theol.* xxxiv. 103-108. A few Hebrew words have been regarded as Philistine loan-words, so notably *pillagesh*, "concubine" (פילאש, פילאש, Lat. *pellex*), and *seves* (ρίσανος) the title applied to the five lords of the Philistine confederation; *seves* otherwise means "axe," and may have been applied metaphorically like the Arab. *sof* (W. R. Smith). On the other hand, a common origin in Asia Minor is also possible for these words.

² In the prophetic writings the Philistines are denounced (with Ammon, Moab and Edom) for their vengeance upon Judah (Ezek. xxv. 15-17). With Tyre and Sidon they are condemned for plundering Judah, and for kidnapping its children to sell to the Greeks (Joi. iii. 4-8; cf. Amos i. 6-12; 1 Macc. iii. 41). They are threatened with a foe from the north (Jer. xxv. 20; Isa. xiv. 29-31; see ZEPHANIAN), as also is Phoenicia (Jer. xvii. 2-7) upon whom they depend (cf. Zech. ix. 3-8). Judah is promised reprisals (Zeph. ii. 7; Obad. 19), and a remnant of the Philistines may become worshippers of Yahweh (Zech. ix. 7). The historical backgrounds of these passages are disputed.

³ See J. L. Myres, *Journal of Hellenic Studies*, xvi. 84 sqq. (1906); especially pp. 108, 127 sqq.

⁴ This is suggested by the recent discovery at Phaestos in Crete of a disk with evidence for a native script; see A. J. Evans, *Scripta Minoa* (Oxford, 1909), pp. 22 sqq.; E. Meyer, *Sitzungsberichte* of the Berlin Academy for the 21st of October 1909.

Israelite monarchy. There is a fairly continuous intercourse with external culture (Cypriote, early and late Greek), and, if Gath be identified with Tel es-Safi, Bliss and Macalister, who excavated it, found no trace of any interruption in its history. Only at Gezer—perhaps Philistine, a Sam. v. 25—has there been found evidence for a strange race with several distinctive features. Bricked vault tombs were discovered containing bodies outstretched (not contracted); the deposits were of an unusually fine character and comprised silver, alabaster and even iron. The culture appears to find Carian and Lydian parallels, and has been ascribed provisionally to the 13th-10th centuries. So far, however, of the cities lying within or immediately exposed to Philistine influence, the discoveries at Gezer are unique.⁵

According to the biblical traditions the Philistines are the remnant of Caphtor (Jer. xlvii. 4, Amos ix. 7), and the Caphtorim drove out the aboriginal Avva from Gaza and district, as the Horites⁶ and Rephaim were displaced by Edom and Ammon (Deut. ii. 23). These Caphtorim, together with Ludim (Lydians) and other petty peoples, apparently of the Delta, are once reckoned to Egypt (Gen. x. 14).⁷ By Caphtor the Septuagint has sometimes understood Cappadocia, which indeed may be valid for its age, but the name is to be identified with the Egyptian K(a)ptar, which in later Ptolemaic times seems to mean Phoenicia, although *Ka'ptu* had had another connotation. The Cherethites, associated with the Philistine district (1 Sam. xxx. 14, 16, Ezek. xxv. 16, Zeph. ii. 5 seq.), are sometimes recognized by the Septuagint as Cretans, and, with the Pelethites (often taken to be a rhyming form of Philistines), they form part of the royal body-guard of Judaean kings (2 Sam. viii. 18, xv. 18, xx. 7, 1 Kings i. 38, 44; in 2 Sam. xx. 23 the Hebrew text has Carites). However adequate these identifications may seem, the persistence of an independent clan or tribe of Cherethites-Cretans to the close of the 7th century would imply an unbroken chain of nearly six hundred years, unless, as is inherently more probable, later immigrations had occurred within the interval. But upon the ethnological relations either of the south Palestinian coast or of the Delta it would be unsafe to dogmatize. So far as can be ascertained, then, the first mention of the Philistines belongs to an age of disturbance and change in connexion with movements in Asia Minor. Archaeological evidence for their influence has indeed been adduced,⁸ but it is certain that some account must be taken also of the influence by land from North Syria and Asia Minor. The influences, whether from the Levant or from the north, were not confined to the age of Rameses III. alone, and the biblical evidence, especially, while possibly preserving some recollection of the invasion of the Purasati, is in every case late and may be shaped by later historical vicissitudes. It is impossible that Palestine should have remained untouched by the external movements in connexion with the Delta, the Levant and Asia Minor, and it is possible that the course of internal history in the age immediately before and after 1000 B.C. ran upon lines different from the detailed popular religious traditions which the biblical historians have employed. (See further PALESTINE: HISTORY.)

For older studies, see F. Hitzig, *Urgeschichte der Philister* (1845), with the theory of the Pelagic origin of the Philistines; K. Starb, *Gaza u. d. philist. Küste* (1852), and (with special reference to earlier theories) W. Robertson Smith's art. in *Ency. Brit.*, 9th ed. (S. A. C.)

PHILISTUS, Greek historian of Sicily, was born at Syracuse about the beginning of the Peloponnesian War (432 B.C.). He was a faithful supporter of the elder Dionysius, and commander

⁵ See R. A. S. Macalister, *Quarterly Stat. of the Palestine Explor. Fund*, pp. 319 sqq. (1905), pp. 197 sqq. (1907), and J. L. Myres, *ibid.* pp. 240 sqq. (1907). On the other hand, H. Thiersch would connect the painted pottery of Tel es-Safi, &c., with the Philistines (*Jahrbuch d. Arch. Inst.* col. 378 sqq., Berlin, 1908); cf. also H. R. Hall, *Proc. Soc. Bib. Arch.* xxxi. 235.

⁶ v. 13 sqq. may be a secondary addition "written from specially intimate acquaintance with the (later ?) Egyptian geography" (J. Skinner, *Genesis*, p. 214).

⁷ See D. G. Hogarth, *Ionian and the East*, pp. 28 seq. (Oxford, 1909); Evans, *Scripta Minoa*, pp. 77 sqq.

of the citadel. In 386 he excited the jealousy of the tyrant by secretly marrying his niece, and was sent into banishment. He settled at Thurii, but afterwards removed to Adria, where he remained until the death of Dionysius (366). He was then recalled by the younger Dionysius, whom he persuaded to dismiss Plato and Dion. When Dion set sail from Zacynthus with the object of liberating Syracuse from the tyrants, Philistus was entrusted with the command of the fleet, but he was defeated and put to death (356). During his stay at Adria, Philistus occupied himself with the composition of his *Συλλογὴ*, a history of Sicily in eleven books. The first part (bks. i-vii.) comprised the history of the island from the earliest times to the capture of Agrigentum by the Carthaginians (406); the second, the history of the elder and the younger Dionysius (down to 363). From this point the work was carried on by Philistus's fellow countryman Athanas. Cicero (*ad. Q. Fr.* ii. 13), who had a high opinion of his work, calls him the miniature Thucydides (*pusillus Thucydides*). He was admitted by the Alexandrian critics into the canon of historiographers, and his work was highly valued by Alexander the Great.

See *Diod. Sic.* xiii. 103, xiv. 8, xv. 7, xvi. 11, 16; *Plutarch, Dion.* 11-36; *Cicero, Brutus*, 17, *De oratore*, ii. 13; *Quintilian, Inst.* x. 1, 74; fragments and life in C. W. Müller, *Fragmenta historicorum graecorum*, vol. i. (1841); C. Wachsmuth, *Einleitung in das Studium der alten Geschichte* (1895); E. A. Freeman, *History of Sicily* (1891-1894); A. Holm, *Geschichte Siciliens im Alter.* (1870-1898).

PHILLAUR, a town of British India, in Jullundur district, Punjab, on the north bank of the river Sutlej, 8 m. N. of Ludhiana. Pop. (1901), 6986. Founded by the Mogul emperor Shah Jahan, it was long of importance as commanding the crossing of the Sutlej. At the Mutiny in 1857 the fort contained the siege train, which was sent safely to Delhi; but the sepoy regiment in the cantonment shortly afterwards mutinied and escaped. The fort is now occupied by the police training school and the central bureau of the criminal identification department.

PHILLIMORE, SIR ROBERT JOSEPH (1810-1885), English judge, third son of a well-known ecclesiastical lawyer, Dr Joseph Phillimore, was born at Whitehall on the 5th of November 1810. Educated at Westminster and Christ Church, Oxford, where a lifelong friendship with W. E. Gladstone began, his first appointment was to a clerkship in the board of control, where he remained from 1832 to 1835. Admitted as an advocate at Doctors' Commons in 1839, he was called to the bar at the Middle Temple in 1841, and rose very rapidly in his profession. He was engaged as counsel in almost every case of importance that came before the admiralty, probate or divorce courts, and became successively master of faculties, commissary of the deans and chapters of St Paul's and Westminster, official of the archdeacons of Middlesex and London, and chancellor of the dioceses of Chichester and Salisbury. In 1853 he entered parliament as member for Tavistock. A moderate in politics, his energies were devoted to non-party measures, and in 1854 he introduced the bill for allowing *viva voce* evidence in the ecclesiastical courts. He sat for Tavistock until 1857, when he offered himself as a candidate for Coventry, but was defeated. He was appointed judge of the Cinque Ports in 1855, Queen's Counsel in 1858, and advocate-general in admiralty in 1862, and succeeded Dr Stephen Lushington (1782-1873) as judge of the court of arches five years later. Here his care, patience and courtesy, combined with unusual lucidity of expression, won general respect. In 1875, in accordance with the Public Worship Regulation Act, he resigned, and was succeeded by Lord Penzance. When the Judicature Act came into force the powers of the admiralty court were transferred to the High Court of Justice, and Sir Robert Phillimore was therefore the last judge of the historic court of the lord high admiral of England. He continued to sit as judge for the new admiralty, probate and divorce division until 1883, when he resigned. He wrote *Ecclesiastical Law of the Church of England*, a book which still holds its ground, *Commentaries on International Law*, and a translation of Lessing's *Laocoon*. He married, in 1844, Charlotte Anne, daughter of John Demison of Ossington Hall, Newark. He was knighted in 1862, and created a baronet in 1881. He died at Shiplake, near Henley-on-Thames, on

the 4th of February 1885. His eldest son, Sir Walter G. F. Phillimore (b. 1845), also distinguished as an authority on ecclesiastical and admiralty law, became in 1897 a judge of the high court.

PHILLIP, JOHN (1817-1867), Scottish painter, was born at Aberdeen, Scotland, on the 19th of April 1817. His father, an old soldier, was in humble circumstances, and the son became an errand-boy to a tinsmith, and was then apprenticed to a painter and glazier. Having received some technical instruction from a local artist named William Mercer, he began, at the age of about fifteen, to paint portraits. In 1834 he made a very brief visit to London. About this time he became assistant to James Forbes, an Aberdeen portrait-painter. He had already gained a valuable patron. Having been sent to repair a window in the house of Major P. L. Gordon, his interest in the works of art in the house attracted the attention of their owner. Gordon brought the young artist under the notice of Lord Panmure, who in 1836 sent him to London, promising to bear the cost of his art education. At first Philip was placed under T. M. Joy, but he soon entered the schools of the Royal Academy. In 1839 he figured for the first time in the royal academy exhibition with a portrait and a landscape, and in the following year he was represented by a more ambitious figure-picture of "Tasso in Disguise relating his Persecutions to his Sister." For the next ten years he supported himself mainly by portraiture and by painting subjects of national incident, such as "Presbyterian Catechizing," "Baptism in Scotland," and the "Spæwif." His productions at this period, as well as his earlier subject-pictures, are reminiscent of the practice and methods of Wilkie and the Scottish genre-painters of his time. In 1851 his health showed signs of delicacy, and he went to Spain in search of a warmer climate. He was brought face to face for the first time with the brilliant sunshine and the splendid colour of the south, and it was in coping with these that he first manifested his artistic individuality and finally displayed his full powers. In the "Letter-writer of Seville" (1854), commissioned by Queen Victoria at the suggestion of Sir Edwin Landseer, the artist is struggling with new difficulties in the portrayal of unwonted splendours of colour and light. In 1857 Phillip was elected an associate of the Royal Academy, and in 1859 a full member. In 1855 and in 1860 further visits to Spain were made, and in each case the painter returned with fresh materials to be embodied with increasing power and subtlety in the long series of works which won for him the title of "Spanish Phillip." His highest point of execution is probably reached in "La Gloria" (1864) and a smaller single-figure painting of the same period entitled "El Cigarillo." These Spanish subjects were varied in 1860 by a rendering of the marriage of the princess royal with the crown prince of Prussia, executed by command of the queen, and in 1863 by a picture of the House of Commons. During his last visit to Spain Phillip occupied himself in a careful study of the art of Velazquez, and the copies which he made fetched large prices after his death, examples having been secured by the royal and the royal Scottish academies. The year before his death he visited Italy and devoted attention to the works of Titian. The results of this study of the old masters are visible in such works as "La Loteria Nacional," left uncompleted at his death. During this period he resided much in the Highlands, and seemed to be returning to his first love for Scottish subjects, painting several national scenes, and planning others that were never completed. He died in London on the 27th of February 1867.

His works were collected in the International Exhibition of 1873, and many of them are engraved by T. Oldham Barlow. In addition to the paintings already specified the following are among the more important: "Life among the Gypsies of Seville" (1853); "El Pasco" (1855); "Collection of the Offertory in a Scotch Kirk" (1855); "A Gipsy Water-carrier in Seville" (1855); "The Prayer of Faith shall save the Sick" (1856); "The Dying Contrabandist" (1856); "The Prison Window" (1857); "A Huff" (1859); "Early Career of Murillo" (1865); "A Chat round the Brasero" (1866).

PHILLIPS, ADELAIDE (1833-1882), American contralto singer, was born at Stratford-on-Avon, England, her family emigrating to America in 1840. Her mother taught dancing.

and Adelaide began a career on the Boston stage at ten years old. But in 1850 her talent for singing became evident, and through Jenny Lind and others she was sent to London and to Italy to study. In 1855 she returned to America an accomplished vocalist, and for many years she was the leading American contralto, equally successful in oratorio and on the concert platform. She died at Carlsbad on the 3rd of October 1882.

PHILLIPS, EDWARD (1630-1696), English author, son of Edward Phillips of the crown office in chancery, and his wife Anne, only sister of John Milton, the poet, was born in August 1630 in the Strand, London. His father died in 1631, and Anne Phillips eventually married her husband's successor in the crown office, Thomas Agar. Edward Phillips and his younger brother, John, were educated by Milton. Edward entered Magdalen Hall, Oxford, in November 1650, but left the university in 1651 to be a bookseller's clerk in London. Although he entirely differed from Milton in his religious and political views, and seems, to judge from the free character of his *Mysteries of Love and Eloquence* (1658), to have undergone a certain revulsion from his Puritan upbringing, he remained on affectionate terms with his uncle to the end. He was tutor to the son of John Evelyn, the diarist, from 1663 to 1672 at Sayes Court, near Deptford, and in 1677-1679 in the family of Henry Bennet, earl of Arlington. The date of his death is unknown but his last book is dated 1696.

His most important work is *Theatrum poetarum* (1675), a list of the chief poets of all ages and countries, but principally of the English poets, with short critical notes and a prefatory *Discourse of the Poets and Poetry*, which has usually been traced to Milton's hand. He also wrote *A New World in Words, or a General Dictionary* (1658), which went through many editions, a new edition of Baker's *Chronicle*, of which the section on the period from 1650 to 1658 was written by himself from the royalist standpoint; a supplement (1676) to John Speed's *Theatre of Great Britain*, and in 1684, *Enchiridion lingue latine*, said to have been taken chiefly from notes prepared by Milton. Aubrey states that all Milton's papers came into Phillips's hands, and in 1694 he published a translation of his *Letters of State* with a valuable memoir.

His brother, **JOHN PHILLIPS** (1631-1706), in 1652 published a Latin reply to the anonymous attack on Milton entitled *Pro Rege et populo anglicano*. He appears to have acted as unofficial secretary to Milton, but, disappointed of regular political employment, and chafing against the discipline he was under, he published in 1655 a bitter attack on Puritanism entitled *A Satyr against Hypocrites* (1655). In 1656 he was summoned before the privy council for his share in a book of licentious poems, *Sportive Wit*, which was suppressed by the authorities but almost immediately replaced by a similar collection, *Wit and Drollery*. In *Montelion* (1660) he ridiculed the astrological almanacs of William Lilly. Two other skits of this name, in 1661 and 1662, also full of course royalist wit, were probably by another hand. In 1678 he supported the agitation of Titus Oates, writing on his behalf, says Wood, "many lies and villanies." *Dr Oates's Narrative of the Popish Plot* indicated was the first of these tracts. He began a monthly historical review in 1688 entitled *Modern History* or *a Monthly Account of all considerable Occurrences, Civil, Ecclesiastical and Military*, followed in 1690 by *The Present State of Europe, or a Historical and Political Mercury*, which was supplemented by a preliminary volume giving a history of events from 1688. He executed many translations from the French, and a version (1687) of *Don Quixote*.

An extended, but by no means friendly, account of the brothers is given by Wood, *Athen. oxon.* (ed. Bliss, iv. 764 seq.), where a long list of their works is dealt with. This formed the basis of William Godwin's *Lives of Edward and John Phillips* (1815), with which is reprinted Edward Phillips's *Life of John Milton*.

PHILLIPS, JOHN (1800-1874), English geologist, was born on the 25th of December 1800 at Marden in Wiltshire. His father belonged to an old Welsh family, but settled in England as an officer of excise and married the sister of William Smith, the "Father of English Geology." Both parents dying when he was a child, Phillips came under the charge of his uncle; and after being educated at various schools, he accompanied Smith on his wanderings in connexion with his geological maps. In the

spring of 1824 Smith went to York to deliver a course of lectures on geology, and his nephew accompanied him. Phillips accepted engagements in the principal Yorkshire towns to arrange their museums and give courses of lectures on the collections contained therein. York became his residence, where he obtained, in 1825, the situation of keeper of the Yorkshire museum and secretary of the Yorkshire Philosophical Society. From that centre he extended his operations to towns beyond the county; and in 1831 he included University College, London, in the sphere of his activity. In that year the British Association for the Advancement of Science was founded at York, and Phillips was one of the active minds who organized its machinery. He became in 1832 the first assistant secretary, a post which he held until 1850. In 1834 he accepted the professorship of geology at King's College, London, but retained his post at York. In 1834 he was elected F.R.S.; in later years he received hon. degrees of LL.D. from Dublin and Cambridge, and D.C.L. from Oxford; while in 1845 he was awarded the Wollaston Medal by the Geological Society of London. In 1840 he resigned his charge of the York museum and was appointed on the staff of the geological survey of Great Britain under De la Beche. He spent some time in studying the Palaeozoic fossils of Devon, Cornwall and West Somerset, of which he published a descriptive memoir (1841); and he made a detailed survey of the region of the Malvern Hills, of which he prepared the elaborate account that appears in vol. ii. of the *Memoirs of the Survey* (1848). In 1844 he became professor of geology in the university of Dublin. Nine years later, on the death of H. E. Strickland, who had acted as substitute for Dean Buckland in the readership of geology in the university of Oxford, Phillips succeeded to the post of deputy, and at the dean's death in 1856 became himself reader, a post which he held to the time of his death. During his residence in Oxford he took a leading part in the foundation and arrangement of the new museum erected in 1859 (see his *Notices of Rocks and Fossils in the University Museum*, 1863; and *The Oxford Museum*, by H. W. Acland and J. Ruskin, 1859; reprinted with additions 1893). Phillips was also keeper of the Ashmolean museum from 1854-1870. In 1850-1860 he was president of the Geological Society of London, and in 1865 president of the British Association. He dined at All Souls College on the 23rd of April 1874, but on leaving he slipped and fell down a flight of stone stairs, and died on the following day.

From the time he wrote his first paper "On the Direction of the Diluvial Currents in Yorkshire" (1827), down to the last days of his life, Phillips continued a constant contributor to the literature of science. The pages of the *Philosophical Magazine*, the *Journal of the Geological Society*, the *Geological Magazine* and other publications contain valuable essays by him. He was also the author of numerous separate works, which were of great benefit in extending a sound knowledge of geology. Among these may be specially mentioned: *Illustrations of the Geology of Yorkshire* (in two parts, 1829 and 1836; 2nd ed. of pt. 1 in 1835, 3rd ed., edited by R. Etheridge, in 1875); *A Treatise on Geology* (1837-1839); *Memoirs of William Smith* (1844); *The Rivers, Mountains and Sea-Coast of Yorkshire* (1853); *Manual of Geology, Practical and Theoretical* (1855); *Life on the Earth: its Origin and Succession* (1860); *Vesuvius* (1869); *Geology of Oxford and the Valley of the Thames* (1871). To these should be added his *Monograph of British Belemnitidae* (1865), for the Palaeontographical Society, and his geological map of the British Isles (1847).

See Biographical Memoir, with portrait, in *Geol. Mag.* (July 1870).

PHILLIPS, SAMUEL (1814-1854), English journalist, the son of a Jewish tradesman in London, was born on the 26th of December 1814. He was educated at University College, London, and then at Göttingen. Having renounced the Jewish faith, he returned to England and entered Sidney Sussex College, Cambridge, with the design of taking orders. His father's death, however, prevented this, and in 1841 he took to literary work. He wrote a novel, *Caleb Sturkey* (1862), and other tales, and about 1845 began a connexion with *The Times* as literary critic. In the following year he purchased the *John Bull* newspaper, and edited it for a year. Two volumes of his *Essays from The Times* appeared in 1852 and 1854. Phillips took an active part in the formation of the Crystal Palace Company, and wrote their descriptive guides. In 1852 the university of Göttingen

conferred upon him the honorary degree of LL.D. He died at Brighton on the 14th of October 1854.

PHILLIPS, STEPHEN (1868—), British poet and dramatist, was born on the 28th of July 1868 at Somertown near Oxford, the son of the Rev. Stephen Phillips, precentor of Peterborough Cathedral. He was educated at Stratford and Peterborough Grammar Schools, and entered Queen's College, Cambridge; but during his first term at Cambridge, when F. R. Benson's dramatic company visited the town, he joined it, and for six years played various small parts. In 1890 a slender volume of verse was published at Oxford with the title *Primavera*, which contained contributions by him and by his cousin Laurence Binyon and others. In 1894 he published *Eremus*, a long poem of loose structure in blank verse of a philosophical complexion. In 1896 appeared *Christ in Hades*, forming with a few other short pieces one of the slim paper-covered volumes of Elkin Mathews's "Shilling Garland." This poem arrested the attention of watchful critics of poetry, and when it was followed by a collection of *Poems* in 1897 the writer's position as a new poet of exceptional gifts was generally recognized. This volume contained a new edition of "Christ in Hades," together with "Marpessa," "The Woman with the Dead Soul," "The Wife" and shorter pieces, including the fine lines "To Milton, Blind." The volume won the prize of £100 offered by the *Academy* newspaper for the best new book of its year, ran through half a dozen editions in two years, and established Mr Phillips's rank as poet, which was sustained by the publication in the *Nineteenth Century* in 1898 of his poem "Endymion." George Alexander, the actor-manager, moved perhaps by a certain clamour among the critics for a literary drama, then commissioned Mr Phillips to write him a play, the result being *Paolo and Francesca* (1900), a drama founded on Dante's famous episode. Encouraged by the great success of the drama in its literary form, Mr Alexander produced the piece at the St James's Theatre in the course of 1901. In the meantime, Mr Phillips's next play, *Herod: a Tragedy*, had been produced by Beerbohm Tree on the 31st of October 1900, and was published as a book in 1901; *Ulysses*, also produced by Beerbohm Tree, was published in 1902; *The Sin of David*, a drama on the story of David and Bathsheba, translated into the times and terms of Cromwellian England, was published in 1904; and *Nero*, produced by Beerbohm Tree, was published in 1906. In these plays the poet's avowed aim was, instead of attempting to revive the method of Shakespeare and the Elizabethans, to revitalize the method of Greek drama. *Paolo and Francesca* (which admitted certainly one scene on an Elizabethan model) was the most successful, the subject being best adapted to the lyrical cast of Mr Phillips's poetical temperament; but all contained fine poetry, skillfully stage-managed by a writer who had practical experience of stage craft.

See the section on Stephen Phillips in *Poets of the Younger Generation*, by William Archer (1902); also the articles on "Tragedy and Mr Stephen Phillips," by William Watson, in the *Fortnightly Review* (March 1898); "The Poetry of Mr Stephen Phillips," in the *Edinburgh Review* (January 1900); "Mr Stephen Phillips," in the *Century* (January 1901), by Edmund Gosse; and "Mr Stephen Phillips," in the *Quarterly Review* (April 1902), by Arthur Symonds.

For bibliography up to July 1903, see *English Illustrated Magazine* new series, vol. xxix. p. 442.

PHILLIPS, THOMAS (1770-1845), English portrait and subject painter, was born at Dudley in Warwickshire on the 18th of October 1770. Having acquired the art of glass-painting at Birmingham he visited London in 1790 with an introduction to Benjamin West, who found him employment on the windows in St George's Chapel at Windsor. In 1792 Phillips painted a view of Windsor Castle, and in the next two years he exhibited the "Death of Talbot, Earl of Shrewsbury, at the Battle of Castillon," "Ruth and Naomi," "Elijah restoring the Widow's Son," "Cupid disarmed by Euphrosyne," and other pictures. After 1796, however, he mainly confined himself to portrait-painting. It was not long before he became the chosen painter of men of genius and talent, notwithstanding the rivalry of Hoppner, Owen, Jackson and Lawrence; and he left behind portraits of nearly all the illus-

trious characters of his day. In 1804 he was elected associate and in 1808 member of the Royal Academy. In 1824 Phillips succeeded Fuseli as professor of painting to the Royal Academy, an office which he held till 1832. During this period he delivered ten *Lectures on the History and Principles of Painting*, which were published in 1833. He died on the 20th of April 1845.

PHILLIPS, WENDELL (1811-1884), American orator and reformer, was born in Boston on the 29th of November 1811. His father, John Phillips (1770-1823), a man of wealth and influence, graduated at Harvard College in 1788, and became successively "town advocate and public prosecutor," and in 1822 first mayor of Boston, then recently made into a city. Wendell Phillips himself attended the public Latin school, entered Harvard College before he was sixteen, and graduated in 1831 in the same class with the historian John Lothrop Motley. He graduated at the Harvard law school in 1834, and was admitted to the bar in Boston. He soon came under the influence of the anti-slavery movement, witnessing in 1835 the mobbing, in Boston, of William Lloyd Garrison. On the 8th of December 1837 a meeting was held at Faneuil Hall to express the sentiments of the people on the murder of Elijah P. Lovejoy, at Alton, Illinois, for defending his press from a pro-slavery mob. In the course of the meeting a speech was made in opposition to its general current by James T. Austin (1784-1870), attorney-general of the state, who said that Lovejoy had died "as the fool dieth," and compared his murderers to the men who threw the tea into Boston harbour just before the War of Independence. The speech seemed likely to divide the audience, when Wendell Phillips took the platform. "When I heard," he said, "the gentleman lay down principles which placed the murderers of Alton side by side with Otis and Hancock, with Quincy and Adams, I thought these pictured lips (pointing to their portraits) would have broken into voice to rebuke the recreant American, the slanderer of the dead." This appeal not merely determined the sentiment of the meeting, it gave Wendell Phillips his first fame and determined his career. Although loving his profession, and this especially for the opening it gave in the direction of public life, he practically stepped outside the sphere dearest to young Americans, and lived henceforth the life of an agitator, or, like his father, that of a "public prosecutor." Accepting unhesitatingly the leadership of Garrison, and becoming like him gradually a disunionist, he lived essentially a platform life, interested in a variety of subjects, but first and chiefly an abolitionist. In 1865, however, after the Civil War, he broke with Garrison over the question of discontinuing the Anti-Slavery Society, and from that date until the society was disbanded in 1870 he, instead of Garrison, was its president. He was not, moreover, like his great leader, a non-resistant, nor was he, on the other hand, like John Brown, borne on by irresistible necessity to overt action. Nor did he find, like his fellow-worker, Theodore Parker, the leisure to keep up his scholarship and lead in part the life of a student. Early study and travel had indeed furnished him with abundant material for rhetorical illustration; and he was also a great reader of newspapers, but he used to say that he knew in his whole life but one thing thoroughly, namely, the history of the English Civil War, and there were few occasions when he could not draw from it the needful illustration. His style of eloquence was direct and brilliant, but eminently self-controlled. He often surprised his hearers by the quietness of his beginnings, and these were very often the speeches which turned out most brilliant and most irresistible ere the close. He may be said to have introduced the direct and colloquial manner upon the American public platform, as distinct from the highly elaborated and often ornate style which had been established by Edward Everett; nor has there ever been a reversion since his day to the more artificial method. He was capable at times, nevertheless, of highly sonorous periods with superb climaxes; yet his favourite style was the conversational. His logic, while never obtruded, was rarely at fault; but he loved the flash of the rapier, and

was never happier than when he had to face down a mob and utterly foil it by sheer superiority in fencing. The two volumes of his speeches, as edited by James Redpath, were fortunately made from verbatim reports, and they wisely enclose in parentheses those indications of favour or dissent from the audience which transformed so many of his speeches into exhibitions of gladiatorial skill. He was a tribune of the people, associated unflinchingly not merely with the unpopular but with the unpopular; always carrying about him not merely a certain Roman look, but a patrician air. After slavery had fallen Phillips associated himself freely with reformers occupied in other paths, herein separating himself from the other patrician of the movement, Edmund Quincy, who always frankly said that after slavery was abolished there was nothing else worth fighting for. Among other things, Phillips contended, during his later years, for prohibition, woman suffrage and various penal and administrative reforms. He was not always the best judge of character, and was sometimes allied in these movements with men who were little more than demagogues. But the proof he gave by his transfer of energies that the work of reform was never quite finished—this was something of peculiar value, and worth the risk of some indiscretions. The life of a reformer did not in itself make him thoroughly happy; he chafed more and more under its fatigues, and he always felt that his natural place would have been among senators or ambassadors; but he belonged essentially to the heroic type, and it may well have been of him that Emerson was thinking when he wrote those fine words: "What forests of laurel we bring and the tears of mankind to him who stands firm against the opinion of his contemporaries." His domestic life was most happy, though his wife was a confirmed invalid, seldom quitting her room. She was a woman of heroic nature and very strong convictions. Her husband used to say that she first made him an abolitionist. They had no children, but adopted an orphaned daughter of Mrs Eliza Garnaut, a friend, and this young girl (afterwards the wife of George W. Smalley), brought much light and joy into the household. Their worldly circumstances were easy, though they were always ready to impoverish themselves for the sake of others. Wendell Phillips died in Boston on the 2nd of February 1884.

See Lorenzo Sears, *Wendell Phillips, Orator and Agitator* (New York, 1909).

PHILLIPS, WILLIAM (1775–1828), British mineralogist and geologist, son of James Phillips, printer and bookseller in London, was born on the 10th of May 1775. He early became interested in mineralogy and geology, and was one of the founders of the Geological Society of London (1807). His *Outlines of Mineralogy and Geology* (1815) and *Elementary Introduction to the Knowledge of Mineralogy* (1816) became standard textbooks. His digest of English geology, *A selection of Facts from the Best Authorities, arranged so as to form an Outline of the Geology of England and Wales* (1818), formed the foundation of the larger work undertaken by Phillips in conjunction with W. D. Conybeare, of which only the first part was published, entitled *Outlines of the Geology of England and Wales* (1822). This volume made an era in geology. As a model of careful original observation, of judicious compilation, of succinct description and of luminous arrangement it has been of the utmost service in the development of geology in Britain. In this work Phillips reprinted his admirable description of the chalk cliffs of Dover and other parts of East Kent, published in 1819 in *Trans. Geol. Soc.* vol. v. Phillips was a member of the Society of Friends. He was elected a Fellow of the Royal Society in 1827. He died on the 2nd of April 1828.

His brother, **RICHARD PHILLIPS** (1778–1851), was distinguished as a chemist, and became F.R.S. in 1822. He was appointed chemist and curator to the Museum of Economic (afterwards Practical) Geology, then situated in Craig's Court (1830). He was the author of papers published in the *Annals of Philosophy* and *Philosophical Magazine*. In 1796 the two brothers, together with William Allen and Luke Howard, took part in forming the Aakesian Society.

PHILLIPSBURG, a town of Warren county, New Jersey, U.S.A., on the Delaware river, opposite Easton, Pennsylvania, and about 51 m. N.N.W. of Trenton, N.J. Pop. (1900) 20,052, of whom 990 were foreign-born; (1910 U.S. census) 13,003. Served by the Central of New Jersey and other railways, the town is situated in the river bottom and on a bluff which commands beautiful views. The river is spanned here by several bridges. The town has railway shops and various manufactures. In 1905 the value of the factory products was \$6,684,173 (45.8% more than in 1900). Phillipsburg was settled about 1750. It was only a straggling village when the Morris Banking and Canal Company was chartered in 1824, but its growth was accelerated by the canal (no longer used), by the establishment in 1848 of an iron furnace, and by the completion of the Central Railroad of New Jersey to this point in 1852; the town was incorporated in 1861.

PHILLIPSITE, a mineral of the zeolite group; a hydrated potassium, calcium and aluminium silicate, approximating to $(K_2, Ca)Al_4(Si_3O_{10}) \cdot 4H_2O$. It varies somewhat in composition, and a variety ("pseudophillipsite") containing rather less silica has the formula $(K_2, Ca)_2Al_4Si_3O_{19} \cdot 9H_2O$. Crystals are monoclinic, but only complex cruciform twins are known, these being exactly like twins of harmotome (*q.v.*). Crystals of phillipsite are, however, usually smaller and more transparent and glassy than those of harmotome. Spherical groups with a radially fibrous structure and bristled with crystals on the surface are not uncommon. The hardness is 4½, and the specific gravity 2.2. The species was established by A. Lévy in 1825 and named after William Phillips. French authors use the name christianeite (after Christian VIII. of Denmark), given by A. Des Cloizeaux in 1847.

Phillipsite is a mineral of secondary origin, and occurs with other zeolites in the amygdaloidal cavities of basic volcanic rocks: e.g. in the basalt of the Giant's Causeway in County Antrim, and near Melbourne in Victoria; and in leucite near Rome. Small crystals of recent formation have been observed in the masonry of the hot baths at Plombières and Bourbonnelles-Bains, in France. Minute spherical aggregates embedded in red clay were dredged by the "Challenger" from the bottom of the Central Pacific, where they had been formed by the decomposition of lava. (L. J. S.)

PHILLPOTTS, HENRY (1778–1869), English bishop, was born at Bridgewater on the 6th of May 1778, and was educated at Gloucester College school and at Corpus Christi College, Oxford. He became a fellow of Magdalen College, Oxford, in 1795, took orders in 1802, and was select university preacher in 1804. In 1805 he received the living of Stainton-le-Street, Durham, and in addition was appointed to Bishop Middleham, Durham, in the succeeding year. For twenty years he was chaplain to Shute Barrington, bishop of Durham. He was appointed vicar of Gateshead in 1808, prebendary of Durham in 1809, and vicar of St Margaret, Durham, in 1810. After holding the rich living of Stanhope, Durham from 1820, and the deanery of Chester from 1828, he was consecrated bishop of Exeter in 1831, holding with the see a residential canonry at Durham. His published works include numerous speeches and pamphlets, including those connected with his well-known Roman Catholic controversy with Charles Butler (1750–1832). He was an energetic supporter of the Tory party, even when it acted contrary to his views in passing the Roman Catholic Emancipation Act of 1829. He died on the 18th of September 1869. "Henry of Exeter," as he was commonly called, was one of the most striking figures in the English Church of the 18th century. His intellect was strong rather than broad, his position being that of the traditional High Churchman, with little sympathy either with the Evangelicals or with the Tractarians. On the one hand the famous Gorham judgment was the outcome of his refusal to institute to the living of Bramford Speke a clergyman George Cornelius Gorham (1787–1857), who had openly disavowed his belief in baptismal regeneration; on the other he denounced the equally famous Tract XC. in his episcopal charge of 1843. As bishop he was a strict disciplinarian, and

did touch to restore order in a diocese of which the clergy had become extraordinarily demoralized. Though accused of avarice and pluralism, Philpotts was generous in his gifts to the church, founding the theological college at Exeter and spending large sums on the restoration of the cathedral.

PHILO, Jewish Hellenist, and author of an epic poem in Greek hexameters on the history of Jerusalem. Alexander Polyhistor (c. 105-35 B.C.) quotes several passages of the poem, and is the source of the extracts in Eusebius (*Præparatio evangelica*, ix. 20, 24, 37). This is probably the Philo who is mentioned by Clemens Alexandrinus (*Strom.* i. 23, 141) and by Josephus (*Contra Apionem*, i. 23), who calls him "the elder."

See M. Philippon's work on the Jewish poets Ezechiel and Philo (Berlin, 1830).

PHILO, often called PHILLO JUDAËUS, Jewish philosopher, appears to have spent his whole life at Alexandria, where he was probably born c. 20-10 B.C. His father Alexander was alabarch or arabarch (that is, probably, chief farmer of taxes on the Arabic side of the Nile), from which it may be concluded that the family was influential and wealthy (*Jos. Ant.* xviii. 8, 1). Jerome's statement (*De vir. ill.* 11) that he was of priestly race is confirmed by no older authority. The only event of his life which can be actually dated belongs to A.D. 40, when Philo, then a man of advanced years, went from Alexandria to Rome, at the head of a Jewish embassy, to persuade the emperor Gaius to abstain from claiming divine honour of the Jews. Of this embassy Philo has left a full and vivid account (*De legatione ad Gaium*). Various fathers and theologians of the Church state that in the time of Claudius he met St Peter in Rome;¹ but this legend has no historic value, and probably arose because the book *De vita contemplativa*, ascribed to Philo, in which Eusebius already recognized a glorification of Christian monasticism, seemed to indicate a disposition towards Christianity.

Though we know so little of Philo's own life, his numerous extant writings give the fullest information as to his views of the universe and of life, and his religious and scientific aims, and so enable us adequately to estimate his position and importance in the history of thought. He is quite the most important representative of Hellenistic Judaism, and his writings give us the clearest view of what this development of Judaism was and aimed at. The development of Judaism in the diaspora (*q.v.*) differed in important points from that in Palestine, where, since the successful opposition of the Maccabee age to the Hellenization which Antiochus Epiphanes had sought to carry through by force, the attitude of the nation to Greek culture had been essentially negative. In the diaspora, on the other hand, the Jews had been deeply influenced by the Greeks; they soon more or less forgot their Semitic mother-tongue, and with the language of Hellas they appropriated much of Hellenic culture. They were deeply impressed by that irresistible force which was blending all races and nations into one great cosmopolitan unity, and so the Jews too on their dispersion became in speech and nationality Greeks, or rather "Hellenists." Now the distinguishing character of Hellenism is not the absolute disappearance of the Oriental civilizations before that of Greece but the combination of the two with a preponderance of the Greek element. So it was with the Jews, but in their case the old religion had much more persistence than in other Hellenistic circles, though in other respects they too yielded to the superior force of Greek civilization. This we must hold to have been the case not only in Alexandria but throughout the diaspora from the commencement of the Hellenistic period down to the later Roman Empire. It was only after ancient civilization gave way before the barbarian immigrations and the rising force of Christianity that rabbinism became supreme even among the Jews of the diaspora. This Hellenistic-Judaic phase of culture is sometimes called "Alexandrian," and the expression is justifiable if it only means that in Alexandria it attained its highest development and flourished most. For

¹ Euseb., *H. E.* ii. 17, 1; Jer. *ut supra*; Phot. *Bibl. Cod.* 105; Suid., *s.v.* φιλων.

here the Jews began to busy themselves with Greek literature even under their clement rulers, the first Ptolemies, and here the law and other Scriptures were first translated into Greek; here the process of fusion began earliest and proceeded with greatest rapidity; here, therefore, also the Jews first engaged in a scientific study of Greek philosophy and transplanted that philosophy to the soil of Judaism. We read of a Jewish philosopher Aristobulus in the time of Ptolemy VI. Philometor, in the middle of the 2nd century B.C., of whose philosophical commentary on the Pentateuch fragments have been preserved by Clement of Alexandria and Eusebius. So far as we can judge from these, his aim was to put upon the sacred text a sense which should appeal even to Greek readers, and in particular to get rid of all anthropomorphic utterances about God. Eusebius regards him as a Peripatetic. We may suppose that this philosophical line of thought had its representatives in Alexandria between the times of Aristobulus and Philo, but we are not acquainted with the names of any such. Philo certainly, to judge by his historical influence, was the greatest of all these Jewish philosophers, and in his case we can follow in detail the methods by which Greek culture was harmonized with Jewish faith. On one side he is quite a Greek, on the other quite a Jew. His language is formed on the best classical models, especially Plato. He knows and often cites the great Greek poets, particularly Homer and the tragedians, but his chief studies had been in Greek philosophy, and he speaks of Heraclitus, Plato, the Stoics and the Pythagoreans in terms of the highest veneration. He had appropriated their doctrines so completely that he must himself be reckoned among the Greek philosophers; his system was eclectic, but the borrowed elements are combined into a new unity with so much originality that at the same time he may fairly be regarded as representing a philosophy of his own, which has for its characteristic feature the constant prominence of a fundamental religious idea. Philo's closest affinities are with Plato, the later Pythagoreans and the Stoics.² Yet with all this Philo remained a Jew, and a great part of his writings is expressly directed to recommend Judaism to the respect and, if possible, the acceptance of the Greeks. He was not a stranger to the specifically Jewish culture that prevailed in Palestine; in Hebrew he was not proficient, but the numerous etymologies he gives show that he had made some study of that language.³ His method of exegesis is in point of form identical with that of the Palestinian scribes, and in point of matter coincidences are not absolutely rare.⁴ But above all his whole works prove on every page that he felt himself to be thoroughly a Jew, and desired to be nothing else. Jewish "philosophy" is to him the true and highest wisdom; the knowledge of God and of things divine and human which is contained in the Mosaic Scriptures is to him the deepest and the purest.

If now we ask wherein Philo's Judaism consisted we must answer that it lies mainly in the formal claim that the Jewish people, in virtue of the divine revelation given to Moses, possesses the true knowledge in things religious. Thoroughly Jewish is his recognition that the Mosaic Scriptures of the Pentateuch are of absolute divine authority, and that everything they contain is valuable and significant because divinely revealed. The other Jewish Scriptures are also recognized as prophetic, *i.e.* as the writings of inspired men, but he does not place them on the same lines with the law, and he quotes them so seldom that we cannot determine the compass of his canon. The

² The fathers of the Church have specially noticed his Platonism and Pythagoreanism; an old proverb even says, with some exaggeration, ἡ Πλάτωνος φιλοσοφία ἡ φιλωνίου τὰ ἱερὰ (Jerome, Photius and Suidas, *ut supra*). Clement of Alexandria directly calls him a Pythagorean. Eusebius (*H. E.* ii. 4, 3) observes both tendencies. Recent writers, especially Zeller, lay weight also on his Stoic affinities, and with justice, for the elements which he borrows from Stoicism are as numerous and important as those derived from the other two schools.

³ See the list of these in Vallarsi's edition of Jerome (iii. 731-734), and compare Siegfried, "Philonische Studien," in *Merz's Archiv.* ii. 143-163 (1872).

⁴ See Siegfried, *Philo*, pp. 142-159.

decisive and normative authority is to him the "holy laws" of Moses, and this not only in the sense that everything they contain is true but that all truth is contained in them. Everything that is right and good in the doctrines of the Greek philosophers had already been quite as well, or even better, taught by Moses. Thus, since Philo had been deeply influenced by the teachings of Greek philosophy he actually finds in the Pentateuch everything which he had learned from the Greeks. From these premises he assumes as requiring no proof that the Greek philosophers must in some way have drawn from Moses, a view indeed which is already expressed by Aristobulus. To carry out these presuppositions called for an exegetical method which seems very strange to us, that, namely, of the allegorical interpretation of Scripture. The allegorical method had been practised before Philo's date in the rabbinical schools of Palestine, and he himself expressly refers to its use by his predecessors, nor does he feel that any further justification is requisite. With its aid he discovers indications of the profoundest doctrines of philosophy in the simplest stories of the Pentateuch.¹

This merely formal principle of the absolute authority of Moses is really the one point in which Philo still holds to genuinely Jewish conceptions. In the whole substance of his philosophy the Jewish point of view is more or less completely modified—sometimes almost extinguished—by what he has learned from the Greeks. Comparatively speaking, he is most truly a Jew in his conception of God. The doctrine of monotheism, the stress laid on the absolute majesty and sovereignty of God above the world, the principle that He is to be worshipped without images, are all points in which Philo justly feels his superiority as a Jew over popular heathenism. But only over popular heathenism, for the Greek philosophers had long since arrived at least at a theoretical monotheism, and their influence on Philo is nowhere more strongly seen than in the detailed development of his doctrine of God. The specifically Jewish (*i.e.* particularistic) conception of the election of Israel, the obligation of the Mosaic law, the future glory of the chosen nation, have almost disappeared; he is really a cosmopolitan and praises the Mosaic law just because he deems it cosmopolitan. The true sage who follows the law of Moses is the citizen not of a particular state but of the world. A certain attachment which Philo still manifests to the particularistic conceptions of his race is meant only "in majorem Judaeorum gloriam." The Jewish people has received a certain preference from God, but only because it has the most virtuous ancestry and is itself distinguished for virtue. The Mosaic law is binding, but only because it is the most righteous, humane and rational of laws, and even its outward ceremonies always disclose rational ideas and aims. And lastly, outward prosperity is promised to the pious, even on earth, but the promise belongs to all who turn from idols to the true God. Thus, in the whole substance of his view of the universe, Philo occupies the standpoint of Greek philosophy rather than of national Judaism, and his philosophy of the world and of life can be completely set forth without any reference to conceptions specifically Jewish.

His doctrine of God starts from the idea that God is a Being absolutely bare of quality. All quality in finite beings has limitation, and no limitation can be predicated of God, who is eternal, unchangeable, simple substance, free, self-sufficient, better than the good and the beautiful. To predicate any quality (*ποιότης*) of God would be to reduce Him to the sphere of finite existence. Of Him we can say only that He is, not what He is, and such purely negative predications as to His being appear to Philo, as to the later Pythagoreans and the Neoplatonists, the only way of securing His absolute elevation above the world. At bottom, no doubt, the meaning of these negations is that God is the most perfect being; and so, conversely, we are told that God contains all perfection, that He fills and encompasses all things with His being.

A consistent application of Philo's abstract conception of

¹ For details, see Cfrörer, *Philo*, i. 68 seq.; Zeller, *Phil. der Gr.* (3rd ed., vol. iii., pt. II., pp. 346-352); Siegfried, *Philo*, pp. 160 seq.

God would exclude the possibility of any active relation of God to the world, and therefore of religion, for a Being absolutely without quality and movement cannot be conceived as actively concerned with the multiplicity of individual things. And so in fact Philo does teach that the absolute perfection, purity and loftiness of God would be violated by direct contact with imperfect, impure and finite things. But the possibility of a connexion between God and the world is reached through a distinction which forms the most important point in his theology and cosmology; the proper Being of God is distinguished from the infinite multiplicity of divine Ideas or Forces: God himself is without quality, but He disposes of an infinite variety of divine Forces, through whose mediation an active relation of God to the world is brought about. In the details of his teaching as to these mediating entities Philo is guided partly by Plato and partly by the Stoics, but at the same time he makes use of the concrete religious conceptions of heathenism and Judaism. Following Plato, he first calls them Ideas or ideal patterns of all things; they are thoughts of God, yet possess a real existence, and were produced before the creation of the sensible world, of which they are the types. But, in distinction from Plato, Philo's ideas are at the same time efficient causes or Forces (*δυνάμεις*), which bring unformed matter into order conformably to the patterns within themselves, and are in fact the media of all God's activity in the world. This modification of the Platonic Ideas is due to Stoic influence, which appears also when Philo gives to the *ἰδέαι* or *δυνάμεις* the name of *λόγος*, *i.e.* operative ideas—parts, as it were, of the operative Reason. For, when Philo calls his mediating entities *λόγος*, the sense designed is analogous to that of the Stoics when they call God the *Logos*, *i.e.* the Reason which operates in the world. But at the same time Philo maintains that the divine Forces are identical with the "daemons" of the Greeks, and the "angels" of the Jews, *i.e.* servants and messengers of God by means of which He communicates with the finite world. All this shows how uncertain was Philo's conception of the nature of these mediating Forces. On the one hand they are nothing else than Ideas of individual things conceived in the mind of God, and as such ought to have no other reality than that of immanent existence in God, and so Philo says expressly that the totality of Ideas, the *ἄκωμος νοῦτος*, is simply the Reason of God as Creator (*θεὸς λόγος ἢ ἢν κοσμοποιεῖν*). Yet, on the other hand, they are represented as hypostases distinct from God, individual entities existing independently and apart from Him. This vacillation, however, as Zeller and other recent writers have justly remarked, is necessarily involved in Philo's premises, for, on the one hand, it is God who works in the world through His Ideas, and therefore they must be identical with God; but, on the other hand, God is not to come into direct contact with the world, and therefore the Forces through which He works must be distinct from Him. The same inevitable amphiboly dominates in what is taught as to the supreme Idea or *Logos*. Philo regards all individual Ideas as comprehended in one highest and most general Idea or Force—the unity of the individual Ideas—which he calls the *Logos* or Reason of God, and which is again regarded as operative Reason. The *Logos*, therefore, is the highest mediator between God and the world, the firstborn son of God, the archangel who is the vehicle of all revelation, and the high priest who stands before God on behalf of the world. Through him the world was created, and so he is identified with the creative Word of God in Genesis (the Greek *λόγος* meaning both "reason" and "word"). Here again, we see, the philosopher is unable to escape from the difficulty that the *Logos* is at once the immanent Reason of God, and yet also an hypostasis standing between God and the world. The whole doctrine of this mediatorial hypostasis is a strange intertwining of very dissimilar threads; on one side the way was prepared for it by the older Jewish distinction between the Wisdom of God and God Himself, of which we find the beginnings even in the Old Testament (Job xxviii. 12 seq.; Prov. viii., ix.), and the fuller development in the books of Ecclesiasticus and Wisdom, the latter of which comes very near to Philo's ideas if we substitute for the term "wisdom"

that of (divine) "Reason." In Greek philosophy, again, Philo, as we have seen, chiefly follows the Platonic doctrines of Ideas and the Soul of the World, and the Stoic doctrine of God as the λόγος or Reason operative in the world. In its Stoic form the latter doctrine was pantheistic, but Philo could adapt it to his purpose simply by drawing a sharper distinction between the Logos and the world.

Like his doctrine of God, Philo's doctrine of the world and creation rests on the presupposition of an absolute metaphysical contrast between God and the world. The world can be ascribed to God only in so far as it is a cosmos or orderly world; its material substratum is not even indirectly referable to God. Matter (ὕλη, or, as the Stoics said, *ὄψια*) is a second principle, but in itself an empty one, its essence being a mere negation of all true being. It is a lifeless, unmoved, shapeless mass, out of which God formed the actual world by means of the Logos and divine Forces. Strictly speaking, the world is only formed, not created, since matter did not originate with God.

Philo's doctrine of man is also strictly dualistic, and is mainly derived from Plato. Man is a twofold being, with a higher and a lower origin. Of the pure souls which fill airy space, those nearest the earth are attracted by the sensible and descend into sensible bodies; these souls are the Godward side of man. But on his other side man is a creature of sense, and so has in him a fountain of sin and all evil. The body, therefore, is a prison, a coffin, or a grave for the soul which seeks to rise again to God. From this anthropology the principles of Philo's ethics are derived, its highest maxim necessarily being deliverance from the world of sense and the mortification of all the impulses of sense. In carrying out this thought, as in many other details of his ethical teaching, Philo closely follows the Stoics. But he is separated from Stoical ethics by his strong religious interests, which carry him to very different views of the means and aim of ethical development. The Stoics cast man upon his own resources; Philo points him to the assistance of God, without whom man, a captive to sense, could never raise himself to walk in the ways of true wisdom and virtue. And as moral effort can bear fruit only with God's help, so too God Himself is the goal of that effort. Even in this life the truly wise and virtuous is lifted above his sensible existence, and enjoys in ecstasy the vision of God, his own consciousness sinking and disappearing in the divine light. Beyond this ecstasy there lies but one further step, viz. entire liberation from the body of sense and the return of the soul to its original condition; it came from God and must rise to Him again. But natural death brings this consummation only to those who, while they lived on earth, kept themselves free from attachment to the things of sense; all others must at death pass into another body; transmigration of souls is in fact the necessary consequence of Philo's premises, though he seldom speaks of it expressly.

Philo's literary labours have a twofold object, being directed either to expound the true sense of the Mosaic law, i.e. the philosophy which we have just described, to his Jewish brethren, or to convince heathen readers of the excellence, the supreme purity and truth, of the Jewish religion, whose holy records contain the deepest and most perfect philosophy, the best and most humane legislation. Thus as a literary figure Philo, in conformity with his education and views of life, stands between the Greeks and the Jews, seeking to gain the Jews for Hellenism and the Greeks for Judaism, yet always taking it for granted that his standpoint really is Jewish, and just on that account truly philosophical and cosmopolitan.

The titles of the numerous extant writings of Philo present at first sight a most confusing multiplicity. More than three-fourths of them, however, are really mere sections of a small number of larger works. Three such great works on the Pentateuch can be distinguished.

1. The smallest of these is the *Zēthēnara kal Abēstē* (*Quaestiones et solutiones*), a short exposition of Genesis and Exodus, in the form of question and answer. The work is cited under this title by Eusebius (*H. E.* ii. 18, 1, 5; *Præp. Ev.* vii. 13), and by later writers, but the Greek text is now almost wholly lost, and only about one-half preserved in an Armenian translation. Genesis seems to have occupied six books.¹ Eusebius tells us that Exodus filled five books. In the Armenian translation, first published by the learned Mechtarist, J. Bapt. Aucher, in 1826, are preserved four

¹ See, especially Mai, *Script. eccl. nov. coll.* vol. vii. pt. i. pp. 100, 106, 108.

books on Genesis and two on Exodus, but with lacunae. A Latin fragment, about half of the fourth books on Genesis (*Phil. Jud. CII, quaest. . . super Gen.*), was first printed at Paris in 1520. Of the Greek we have numerous but short fragments in various Florilegia.² The interpretations in this work are partly literal and partly allegorical.

II. Philo's most important work is the *Nόμος κατὰ ἀλληγορίας* (Euseb. *H. E.* ii. 18, 1; Phot. *Bibl. Cod.* 103), a vast and copious allegorical commentary on Genesis, dealing with chaps. ii-iv, verse by verse, and with select passages in the latter chapters. The readers in view are mainly Jews, for the form is modelled on the rabbinic Midrash. The main idea is that the characters which appear in Genesis are properly allegories of states of the soul (*ἡρώτων τῆς ψυχῆς*). All persons and actions being interpreted in this sense, the work as a whole is a very extensive body of psychology and ethics. It begins with Gen. ii. 1, for the *De mundi origine*, which treats of the creation according to Gen. i. ii., does not belong to this series of allegorical commentaries, but deals with the actual history of creation, and that under a quite different literary form. With this exception, however, the *Nόμος κατὰ ἀλληγορίας* includes all the treatises in the first volume of Mangey's edition, viz.—*Nόμος κατὰ ἀλληγορίας σπέρμα τῆς γῆς καὶ τῶν κελύμενων* (*Legum allegoriarum*, lib. i., M. i. 43-66), on Gen. ii. 1-17. (2) *Nόμος κατὰ ἀλληγορίας* (*Leg. all. lib. ii.*, M. i. 66-86), on Gen. ii. 18-iii. 1a. (3) *Nόμος κατὰ ἀλληγορίας* (*Leg. all. lib. iii.*, M. i. 87-137), on Gen. iii. 8b-19. The commentaries on Gen. iii. 1b-8a, 20-23 are lost. (4) *Περὶ τῶν χειρῶν καὶ τῆς ἀγγελοῦς βοήθειας καὶ τοῦ ἀριστοῦ σπέρματος καὶ ἐπισημοῦ καὶ τοῦ θεοῦ καὶ τῆς ἀθανάτου ἀθανάτου ἀθανάτου* (*De cherubim et fœmine gladio*, M. i. 138-162), on Gen. iii. 24 and iv. 1. (5) *Περὶ τῶν λειτουργῶν Ἀβελ, τῆς καὶ Καὶν* (*De sacrificiis Abels et Caini*, M. i. 163-190), on Gen. iv. 2-4. The commentaries on Gen. iv. 5-7 are lost. (6) *Περὶ τοῦ τῶν χειρῶν τῶν ἀριστοῦ φύλακτος ἐπισημοῦ* (*Quod diciturus peccatoris insidiosis solus*, M. i. 191-225), on Gen. iv. 8-15. (7) *Περὶ τῶν τῶν ἀθανάτου καὶ τῶν ἀθανάτου καὶ τῶν ἀθανάτου γένους* (*De posteritate Caini, etc.*, M. i. 226-261), on Gen. iv. 16-25; this book, which is wanting in editions prior to Mangey's, is incorrectly given by him, but much more correctly by Tischendorf, *Philonea*, pp. 84-143. None of the preceding is mentioned by its special title by Euseb. *H. E.* ii. 18, while he cites all that follow by their titles. The reason must be that all up to this point, and no further, are included by him in the *Nόμος κατὰ ἀλληγορίας*; agreeing with this we find that these, and these only, are cited under that general title in the Florilegia, especially the so-called *Johannes Monachus ineditus* (see Mangey's notes before each book). We may therefore conclude with confidence that Philo published the continuous commentaries on Gen. ii-iv, under the title *Allegories of the Sacred Laws*, and the following commentaries on select passages under special titles, though the identity of literary character entitles us to regard the latter as part of the same great literary plan with the former. (8) *Περὶ γένους* (*De gigantibus*, M. i. 262-272), on Gen. vi. 1-4. (9) *Ὅτι ἄρρητος τὸ θεῖον* (*Quod Deus sit immutabilis*, M. i. 272-299), on Gen. vi. 4-12. (10) *Περὶ γένους* (*De agricoltura*, M. i. 300-328), on Gen. ix. 20a. (11) *Περὶ φωνητικῆς Νόε τῶν βιβλίων* (*De ebrietate Noe*, M. i. 329-356), on Gen. ix. 20b. (12) *Περὶ μύθου* (*De ebrietate*, M. i. 357-391), on Gen. ix. 21; the introduction shows that this book was preceded by another which put together the views of the philosophers about drunkenness. (13) *Περὶ τοῦ ἡρώτου Νόου* (*De sobrietate*, M. i. 392-493), on Gen. ix. 24. (14) *Περὶ ἐνθυμήσεων ἀβελήων* (*De confusione linguarum*, M. i. 404-435), on Gen. xii. 1-9. (15) *Περὶ ἐνοχίου* (*De migratione Abrahami*, M. i. 436-472), on Gen. xii. 1-6. (16) *Περὶ τοῦ τῆς εἰς θεῖον ἀναγωγῆς ἀναγωγῆς* (*Quæ rerum divinarum hæres sit*, M. i. 473-518), on Gen. xv. 1-18. (17) *Περὶ τῆς εἰς τὴν ἀθανάτου ἀθανάτου ἐπισημοῦ* (*De congressu quærendo æreditionis causa*, M. i. 519-545), on Gen. xvi. 1-6. (18) *Περὶ ἐπισημοῦ* (*De profugis*, M. i. 546-577), on Gen. xvi. 6-14. (19) *Περὶ τῶν μεταμορφώσεων καὶ ἐν ἑσέως μεταμορφώσεων* (*De mutatione nominum*, M. i. 578-619), on Gen. xvii. 1-22; in this work Philo mentions that he had written two books, now wholly lost. *Περὶ ἀθανάτου* (M. i. 586). (20) *Περὶ τοῦ θεοῦ τῶν ἐν τῶν βιβλίων* (*De somniis*, lib. i., M. i. 620-658), on the two dreams of Jacob, Gen. xxviii. and xxxi. (21) Book ii. of the same (M. i. 659-699), on the dreams of Joseph, the chief butler, the chief baker, and Pharaoh, Gen. xxxvii. and xl., xli. Eusebius makes Philo the author of five books on dreams; three, therefore, are lost.

• III. A work of a very different kind is the group of writings which we may call "An Exposition of the Mosaic law for Gentiles," which, in spite of their very various contents, present on nearer examination indubitable marks of close connexion. In them Philo seeks to give an orderly view of the chief points of the Mosaic legislation in the Pentateuch, and to recommend it as valuable to Gentile readers. The method of exposition is somewhat more popular than in the allegorical commentaries, for, though that method of interpretation is not wholly excluded, the main object is to give such a view of the legislation as Philo accepted as historical. This work has three main divisions: (a) an Account of the creation (*ἀναγωγὴ*) which Moses put first to show that his

² See Opp., ed. Mangey, ii. 648-680; Mai, *op. cit.*, vol. vii. pt. i. p. 96 seq.; Euseb. *Præp. Ev.* vii. 13. A fragment on the cherubim, Exod. xxv. 18, has been published by Mai, *Class. Auccl. iv.* 430 seq.; by Grosseman (1856) and by Tischendorf (p. 144 seq.).

legislation was conformed to the will of nature, and that therefore those who followed it were true cosmopolitans; (b) the Biographies of the Virtuous—being, so to speak, the living unwritten laws which, unlike written laws, present the general types of moral conduct; (c) Legislation Proper, in two subdivisions—(α) the ten principal chapters of the Law, (β) the special laws belonging to each of these ten. An appendix adds a view of such laws as do not fall under the rubrics of the decalogue, arranged under the headings of certain cardinal virtues.

The treatises which belong to this work are the following: (1) *Περὶ τῆς Μωϋσέως νομοθεσίας* (*De mundi officio*, M. i. 1-42). This work does not fall within the number of the allegorical commentaries. On the other hand, the introduction to the treatise *De Abrahamo* makes clear its immediate connexion with the *De mundi officio*. The position of the *De mundi officio* at the head of the allegorical commentaries, which is at present usual in the editions, seems indeed to go back to a very early date, even Eusebius cites a passage from it with the formula ἀπὸ τοῦ πρώτου τῶν ἐν τῷ νόμῳ (*Praep. Ev.* viii. 12 fin., ed. Gaisford). The group of the *Βίαι σοφῶν* is headed by (2) *Βίαι σοφῶν τοῦ κατὰ διδασκαλίαν τελειωθέντος ἢ κατὰ νόμον ἀγαθῶν* [4], ἢ κατὰ τὴν ἀβραάμ (*De Abrahamo*, M. ii. 1-40). Abraham is here set forth as the type of διδασκαλίᾳ ἀρετῆς, i.e. of virtue as a thing learned. This biography of Abraham was followed by that of Isaac as a type of φύσει ἀρετῆς, i.e. of innate or natural virtue, which in turn was succeeded by that of Jacob as representing ἀσκητικῆς ἀρετῆς, i.e. virtue acquired by practice; but both these are now lost. Hence in the editions the next treatise is (3) *Βίαι πολιτικῆς διακρίσεως* *Ἰωσήφ* (*De Josepho*, M. ii. 41-79), where Joseph is taken as the pattern of the wise man in his civil relations. The Biographies of the Virtuous are followed by (4) *Περὶ τῶν ἡθελῶν ἢ ἀσπλάχτων νόμων* *ἀπὸ τοῦ δεκαλόγου*, M. ii. 180-209) and (5) *Περὶ τῶν ἀσπλάχτων ἢ ἄλλο νόμον ἐκ τῶν ἐπιτάξεων ἐπιτάξεων τῶν ἑκατὸν λόγων* (*De specialibus legibus*; the unabridged title is given by Eusebius, H.E. ii. 18, 5). Here under the rubrics of the ten commandments a systematic review of the special laws of the Mosaic code is given; for example, under the first and second commandments (divine worship) a survey is taken of the entire legislation relating to priesthood and sacrifice; under the fourth (i.e. the Sabbath law, according to Philo's reckoning) there is a survey of all the laws about feasts; under the sixth (adultery) an account of matrimonial law; and so on. According to Eusebius the work embraced four books, which seem to have reached us entire, but in the editions have been perversely broken up into a considerable number of separate tractates. (α) The first book (on the first and second commandments) includes the following: *De circumcissione* (M. ii. 210-212); *De monarchia*, lib. i. (ii. 213-222); *De monarchia*, lib. ii. (ii. 222-232); *De praemiis sacerdotum* (ii. 232-237); *De victimis* (ii. 237-250); *De sacrificiis*, or *De victimis offerentibus* (ii. 251-264); *De mercede meretricibus non accipienda in sacrum* (ii. 264-269). (β) The second book (on the third, fourth and fifth commandments, i.e. on perjury, Sabbath observance, and filial piety) is incomplete in Mangey (ii. 270-298), the section *De septenario* (on the Sabbath and feasts in general) being imperfect, and that *De colendis parentibus* being entirely wanting. (γ) As to a large extent made good the defect (*De cophini festo et de colendis parentibus*, Milan, 1818), but Tischendorf was the first to edit the full text (*Philonea*, pp. 1-83). (δ) The third book relates to the sixth and seventh commandments (adultery and murder; M. ii. 299-334). (e) To the fourth book (relating to the last three commandments) belongs all that is found in Mangey, ii. 335-374, that is to say, not merely the tractates *De iudice* (ii. 344-348) and *De concupiscentia* (ii. 348-358), but also those *De iustitia* (ii. 358-361) and *De creationis principium* (ii. 361-374). The last-named is, properly speaking, only a portion of the *De iustitia*, which, however, certainly belongs to the fourth book, of which the superscription expressly bears that it treats also *κατὰ διακρίσεις*. With this tractate begins the appendix to the work *De specialibus legibus*, into which, under the rubric of certain cardinal virtues, such Mosaic laws are brought together as could not be dealt with under any of the decalogue rubrics. The continuation of this appendix forms a book by itself. (6) *Περὶ τριῶν ἀρετῶν ἥτοι κατὰ ἀρετὰς καὶ φιλοσοφίας καὶ μετὰ τὰς τὸν φορτίδιον*, M. ii. 375-383; *De caritate*, ii. 383-405; *De poenitentia*, ii. 405-407). Finally, in less intimate connexion with this entire work is another treatise still to be mentioned, (7) *Περὶ ἁθλῶν καὶ ἐπιτιμῶν* (*De praemiis et poenis*, M. ii. 408-428) and *Περὶ ἀρῶν* (*De execrationibus*, M. ii. 429-457), two parts which constitute a single whole and deal with the promises and threatenings of the law.

IV. Besides the above-named three great works on the Pentateuch, Philo was the author of a number of isolated writings, of which the following have reached us either in their entirety or in fragments. (1) *Περὶ βίαις Μωϋσέως* (*Vita Moysi*, lib. i-iii., M. ii. 80-179). It is usual to group this, as being biographical in its character, with the *Βίαι σοφῶν*, and thus to incorporate it immediately after the *De Josepho* with the large work on the Mosaic legislation. But, as has been seen, the *Βίαι σοφῶν* are intended to represent the general types of morality, while Moses is by no means so dealt with, but as a unique individual. All that can be said is that the literary character of the *Vita Moysi* is the same as that of the larger work. As in the latter the Mosaic legislation, so in the former the activity of the legislator himself, is delineated for the

benefit of Gentile readers. (2) *Περὶ τοῦ πάντα ἐπινοήσαντος ἀνθρώπου* (*Quod omnis probus liber*, M. ii. 445-470). In the introduction to this treatise reference is made to an earlier book which had for its theme the converse proposition. The complete work was still extant in the time of Eusebius (*H. E.* ii. 18, 6): *Περὶ τοῦ πάντα ἀνθρώπου πάντα φησὶν, ὅτι πάντα ἐπινοήσας τὸ πάντα ἐπινοήσαντος ἀνθρώπου ἀνθρώπου*. The genuineness of the writing now possessed by us is not undoubted: but see Lucius, *Der Eklekticismus* (1881), pp. 13-23. (3) *Εἰς Ἰθάκην* (*Adversus Flaccum*, M. ii. 517-544) and (4) *Περὶ ἀρετῶν καὶ ὑποβίαις πρὸς Γάϊον* (*De legatione ad Gaium*, M. ii. 545-600). These two works have a very intimate connexion. In the first Philo relates how the Roman governor Flaccus in Alexandria, towards the beginning of the reign of Caligula, allowed the Alexandrian mob, without interference, to insult the Jews of that city in the grossest manner, and even to persecute them to the shedding of blood. In the second he tells how the Jews had been subjected to still greater sufferings through the command of Caligula that divine honours should be everywhere accorded to him, and how the Jews of Alexandria in vain sought relief by a mission to Rome which was headed by Philo. But both together were only parts of a larger work, in five books, of which the first two and the last have perished. For it is clear from the introduction to the *Adversus Flaccum* that it had been preceded by another book in which the Jewish persecutions by Sejanus, under the reign of Tiberius, were spoken of, and the *Chronicon* of Eusebius (ed. Schoene, ii. 150, 151) informs us that these persecutions of Sejanus were related in the second book of the work now under discussion. But from the conclusion of the *Legatio ad Gaium*, which we still possess, we learn that it was also followed by another book which exhibited the *καταστάσεις*, or change of Jewish fortunes for the better. Thus we make out five books in all—the number actually given by Eusebius (*H. E.* ii. 5, 1). (5) *Περὶ προνοίας* (*De providentia*). This work has reached us only in an Armenian translation, which has been edited, with a Latin translation, by Aucher (see below), 1822. It is mentioned by its Greek title in Eusebius (*H. E.* ii. 18, 6; *Praep. Ev.* vii. 20 fin., viii. 13 fin., ed. Gaisford). The Armenian text gives two books, but of those the first, if genuine at all, at any rate appears only in an abridged and somewhat revised state.¹ Eusebius (*Praep. Ev.* viii. 14) quotes from the second book to an extent that amounts to a series of excerpts from the whole. The short passage in *Praep. Ev.* vii. 21, is also taken from this book; and it appears that Eusebius knew nothing at all about the first. (6) *Ἀλιεὺς ἢ κατὰ τὸν λόγον ἔχειν τὰ θύρα ἴσας* (*De Alexandro et quod propriam rationem nulli animalia habeant*; so Jerome, *De Vir. Ill. c.* 11); the Greek title is given in Euseb. *H. E.* ii. 18, 6. This also now exists only in an Armenian translation, which has been edited by Aucher. Two small Greek fragments occur in the *Florilegium* of Leontius and Johannes (Mai, *Scr. vet. nov. coll.* vii. 1, pp. 99, 100a). (7) *Ἐπιτίμια*, a writing now known to us only through fragments preserved in Euseb. *Praep. Ev.* viii. 6, 7. The title, as Bernays² has shown, means "Counsels," or "Recommendations," the reference being to such laws of the Jews as can be recommended also to non-Jewish readers. (8) *Περὶ ἰουδαίας*, a title met with in Euseb. *H. E.* ii. 18, 6. The writing is doubt the same as that which Tischendorf has from which a quotation is given in Euseb. *Praep. Ev.* viii. 11. To this place also, perhaps, belongs the *De nobilitate* (M. ii. 437-444), which treats of that true noblesse of wisdom in which the Jewish people also is not wanting.³

V. *The doubtful treatises:* (1) *Περὶ βίαις διακρίσεως ἢ κατὰ ἀρετὰς* (*De vita contemplativa*). This contains the sole original account of an ascetic community known as the Therapeutae (q.s.) having their home on the shores of Lake Mareotis. These were held by Eusebius and many other Christian writers to be the earliest Christian monks, which of course could not be the case if it was a genuine work of Philo. On this account, amongst others, it was held to be spurious by Graetz and P. E. Lucius; and this view gradually received the assent of most modern scholars. Latterly, however, L. Masseebauer has shown with great thoroughness that in language and thought alike it is essentially Philonic, and the genuineness of the book has also been affirmed by P. Wendland, and especially by F. C. Conybeare. (2) *Περὶ ἀσπλάχτων νόμων* (*De incorruptibilitate mundi*), declared unauthentic by Z. Frankel and J. Bernays, but has successfully defended by F. Cumont. (3) *Περὶ κόσμου* (*De mundo*). It is generally agreed that, in L. Cohn's words, this is "nothing but a compilation from various portions of the *Περὶ ἀσπλάχτων νόμων* and other Philonic works." (4) Two discourses, *De Sampsonis* and *De Iona*, extant only in Armenian, and certain other writings of the same kind. These appear only to have been imputed to Philo by chance, and certainly cannot claim to be his work. (5) *Περὶ τοῦ πάντα ἐπινοήσαντος ἀνθρώπου* (*Quod omnis probus liber sit*) has been questioned by Z. Frankel and R. Anselm; but their arguments would rather point to its being an early work of Philo, which P. Wendland believes to be the case. (6) *Περὶ προνοίας* (*De providentia*), which we possess as a whole

¹ See Diels, *Doxographi Graeci*, 1879, pp. 1-4; Zeller, *Phil. d. Gr.* iii. 2, p. 340 (3rd ed.).
² *Monatsb. d. Berl. Akad.* (1876), pp. 589-609.
³ This conjecture is Dahn's, *Theol. Stud. u. Krit.* (1833), pp. 990, 1037.

duly in an Armenian version, consists of two books, the first of which appears to be in a Christian recension, but there is no reason for denying its Philonic origin.

EDITIONS.—Till recent days the best edition was that of Mangey (2 vols., London, 1742); the finestest the Holzta duodecimo (Leipzig, 1851). Both are still very useful, but for scholars they will be superseded by the enlarged and critical edition of Leopold Cohn and Paul Wendland (Berlin, 1896-1902). See also papers by Cohn in *Hermes*, xxxviii. (1903) and xliii. (1908). There is an English translation of the old text by C. D. Yonge (4 vols., London, 1854).

LITERATURE.—The best special studies of Philo will be found in Siegfried, *Philo von Alex.* (Jena, 1875); Drummond, *Philo-Judaeus* (London, 1888). For his place in philosophy, see Zeller, *Phil. der Griechen* (1881). For his relation to Palestinian speculation, B. Ritter, *Philo und die Halacha* (Leipzig, 1879). An excellent general account will be found in Schürer, *The Jewish People in the time of Jesus Christ* (Eng. trans., 1891), or in Dr Ederheim's article on Philo in the *Dictionary of Christian Biography*. For the question of the genuineness and historical value of the *De vita contemplativa*, see L. Masebrou, in *Revue de l'Histoire des religions*, vol. xvi. (Paris, 1887); F. C. Conybeare, *Philo: About the Contemplative Life* (Oxford, 1893); G. Fayot, *Études sur les Thérapeutes* (Geneve, 1880); P. E. Lacius, *Die Therapeuten* (Straßburg, 1882); P. Wendland, *Die Therapeuten* (Leipzig, 1896). Also F. Cumont, *Philo, de art. mundi* (1891); J. Bernays in the *Abhand. der k. Akad. der Wiss.* (1876). (E. S.*; C. B.)

PHILO OF BYZANTIUM, Greek writer on mechanics, flourished during the latter half of the 2nd century B.C. (according to some, a century earlier). He was the author of a large work *Μηχανικὴ σύνταξις*, of which the fourth and (in epitome) fifth books are extant, treating of missiles, the construction of fortresses, provisioning, attack and defence (ed. R. Schöne, 1893, with German translation in H. Köchly's *Griechische Kriegsschriftsteller*, vol. i. 1853; E. A. Rochas d'Aigun, *Poliorettique des Grecs*, 1872). Another portion of the work, on pneumatic engines, has been preserved in the form of a Latin translation (*De ingeniis spiritualibus*) made from an Arabic version (ed. W. Schmidt, with German translation, in the works of Heron of Alexandria, vol. I, in "Teubner Series," 1899; with French translation by Rochas, *La Science des philosophes . . . dans l'antiquité*, 1882).

A little treatise *On the Seven Wonders of the World*, wrongly attributed to Philo, probably belongs to the 6th century A.D. It is printed in R. Hercher's *Aelian* (1858).

PHILO OF LARISSA, Greek philosopher of the first half of the 1st century B.C. During the Mithradatic wars he left Athens and took up his residence in Rome. He was a pupil of Clitomachus, whom he succeeded as head of the Third or New Academy. According to Sextus Empiricus, he was the founder of the Fourth Academy, but other writers refuse to admit the separate existence of more than three academies (see **ACADEMY, GREEK**). In Rome he lectured on rhetoric and philosophy, and collected around him many eminent pupils, amongst whom Cicero was the most famous and the most enthusiastic. None of his works is extant; our knowledge of his views is derived from Numenius, Sextus Empiricus and Cicero. In general, his philosophy was a reaction against the sceptic or agnostic position of the Middle and New Academy in favour of the dogmatism of Plato.

See Gryssar, *Die Akademiker Philo und Antiochus* (1849); Hermann, *De Philone Larissae* (Göttingen, 1851 and 1855).

PHILO, HERENNIUS, of Byblus, Greek grammarian, was born, according to Suidas, in A.D. 42. He lived into the reign of Hadrian, of which he wrote a history, now lost. He was the author of various works: *On the Acquisition and Choice of Books*; *On Critics and their Famous Men*, epitomized by the grammarian Aelius Sereus, and one of the chief authorities used by Hesychius and Stephanus of Byzantium; *On Synonyms*, of which there is extant an epitome by Ammonius Grammaticus. But he is chiefly known for his translation of the Phoenician history of Sanchuniathon, who was said to have lived before the Trojan war. Of this work considerable fragments have been preserved, chiefly by Eusebius in the *Præparatio evangelica* (l. 9, 10; iv. 16). They present a euhemeristic *réchauffé* of Phoenician theology and mythology, which is represented as translated from the original Phoenician. Sanchuniathon is probably an imaginary personage, whose name is formed from that of the Phoenician god Sanchon.

Editions of the fragments, by J. C. Orelli (1826) and C. Müller, *Frag. hist. graec.* vol. iii. In 1836 F. Wagenfeld brought out what claimed to be a complete translation by Philo (from a MS. discovered in a convent in Portugal, now considered spurious). There are English translations by J. P. Cory (1828) and Bishop R. Cumberland (1720).

PHILOCHORUS, of Athens, Greek historian during the 3rd century B.C., was a member of a priestly family. He was a seer and interpreter of signs, and a man of considerable influence. He was strongly anti-Macedonian in politics, and a bitter opponent of Demetrius Poliorcetes. When Antigonos Gonatas, the son of the latter, besieged and captured Athens (261), Philochorus was put to death for having supported Ptolemy Philadelphus, who had encouraged the Athenians in their resistance to Macedonia. His investigations into the usages and customs of his native Attica were embodied in an *Allhis*, in seventeen books, a history of Athens from the earliest times to 262 B.C. Considerable fragments are preserved in the lexicographers, scholiasts, Athenaeus, and elsewhere. The work was epitomized by the author himself, and later by Asinius Pollio of Tralles (perhaps a freedman of the famous Gaius Asinius Pollio). Philochorus also wrote on oracles, divination and sacrifices; the mythology and religious observances of the tetrapolis of Attica; the myths of Sophocles; the lives of Euripides and Pythagoras; the foundation of Salamis. He compiled chronological lists of the archons and Olympiads, and made a collection of Attic inscriptions, the first of its kind in Greece.

Fragments and life in C. W. Müller, *Fragmenta historicorum graecorum*, vol. i. (1841); A. Böckh, *Gesammelte kleine Schriften*, vol. v. (1871), on the plan of the work; J. Strenge, *Quaestiones philochorae* (Göttingen, 1868); C. Wachsmuth, *Einführung in das Studium der alten Geschichte* (1895).

PHILOCTETES, in Greek legend, son of Poeas king of the Malians of Mt Oeta, one of the suitors of Helen and a celebrated hero of the Trojan War. Homer merely states that he was distinguished for his prowess with the bow; that he was bitten by a snake on the journey to Troy and left behind in the island of Lemnos; and that he subsequently returned home in safety. These brief allusions were elaborated by the "cyclic" poets, and the adventures of Philoctetes formed the subject of tragedies by Aeschylus, Sophocles and Euripides. In the later form of the story Philoctetes was the friend and armour-bearer of Heracles, who presented him with his bow and poisoned arrows as a reward for kindling the fire on Mt Oeta, on which the hero immolated himself. Philoctetes remained at Lemnos till the tenth year of the war. An oracle having declared that Troy could not be taken without the arrows of Heracles, Odysseus and Diomedes (or Neoptolemus) were sent to fetch Philoctetes. On his arrival before Troy he was healed of his wound by Machaon, and slew Paris; shortly afterwards the city was taken. On his return to his own country, finding that a revolt had broken out against him, he again took ship and sailed for Italy, where he founded Petilia and Cremissa. He fell fighting on the side of a band of Rhodian colonists against some later immigrants from Pallene in Achaëa. His tomb and sanctuary were shown at Macalla, on the coast of Bruttium.

Of the Aeschylean and Euripidean tragedies only a few fragments remain; of the two by Sophocles, one is extant, the other, dealing with the fortunes of Philoctetes before Troy, is lost. Some light is thrown upon the lost plays by Dio Chrysostom, who in one of his discourses (52) describes his reading of the three tragedies, and in another (59) gives a prose version of the opening of the *Philoctetes* of Euripides. Philoctetes was also the subject of tragedies by Achaëus of Eretria, Euphorion of Chalcis and the Roman tragedian Accius. According to F. Marx (*Neue Jahrbücher für das klassische Altertum*, 1904, p. 673-685), Philoctetes did not appear in the original legend of Troy. He is a form of the Lemnian Hephaestus, who alighted on the island when flung out of Olympus by Zeus. Like him, he is lame and an outcast for nine years; like him, he is brought back in time of need. His connexion with the fall of Troy indicates that the fire-god himself set fire to the city; in like manner no other than the fire-god was thought worthy to kindle the pyre of Heracles. See Homer, *Iliad*, ii. 718, *Odyssey*, iii. 100, viii. 219; Sophocles, *Philoctetes*; and Job's *Introduction*; Dioid. Sic. iv. 38; Philostratus, *Heroica*, 6; Strabo vi. 254; Hyginus, *Fab.* 36, 102.

PHILODEMUS, Epicurean philosopher and poet, was born at Gadara in Coele-Syria early in the 1st century B.C., and

settled in Rome in the time of Cicero. He was a friend of Calpurnius Piso, and was implicated in his profligacy by Cicero (in *Pisonem*, 29), who, however, praises him warmly for his philosophic views and for the *elegans lascivia* of his poems (cf. Horace, *Satires*, i. 2. 120). The Greek anthology contains thirty-four of his epigrams. From the excavations of the villa at Herculaneum (q.v.) there have been recovered thirty-six treatises attributed to Philodemus, and it has been suggested that the villa was actually owned by him; but this is generally denied. These works deal with music, rhetoric, ethics, signs, virtues and vices, and defend the Epicurean standpoint against the Stoics and the Peripatetics.

The *Rhetoric* has been edited by Sudhaus (1892-1895); the *De Ira* and the *De Pietate* by Gomperz (1864 to 1865); the *De Musica* by Kempke (1884); *De Vitiis* by Ussing (1868); *De Morie* by Meckler (1886). See *Hercul. Volum.* (Oxford, 1824 and 1861); Mayor on Cicero's *De Natura deorum* (1871).

PHILOLAUS (b. c. 480), Greek philosopher of the Pythagorean school, was born at Tarentum or at Crotona¹ (so Diog. Laërt. viii. 84). He was said to have been intimate with Democritus, and was probably one of his teachers. After the death of Pythagoras great dissensions prevailed in the cities of lower Italy. According to some accounts, Philolaus; obliged to flee, took refuge first in Lucania and then at Thebes, where he had as pupils Simmias and Cebes, who subsequently, being still young men (*νεαρότατοι*), were present at the death of Socrates. Before this Philolaus had returned to Italy, where he was the teacher of Archytas. He entered deeply into the distinctively Pythagorean number theory, particularly dwelling on the properties inherent in the decad—the sum of the first four numbers, consequently the fourth triangular number, the *tetractys* (see *Vii. Pythag.* ap. *Phot. Bibl.* p. 712)—which he called great, all-powerful, and all-producing. The great Pythagorean oath was taken by the sacred *tetractys*. The discovery of the regular solids is attributed to Pythagoras by Eudemus, and Empedocles is stated to have been the first who maintained that there are four elements. Philolaus, connecting these ideas, held that the elementary nature of bodies depends on their form, and assigned the tetrahedron to fire, the octahedron to air, the icosahedron to water, and the cube to earth; the dodecahedron he assigned to a fifth element, aether, or, as some think, to the universe (see *Plut. de Pl. Ph.* ii. 6, *ἐκ δὲ τοῦ δωδεκάεδρου τῆς τοῦ παντός σφαιρᾶς* and *Stob. Ecl. Phys.* i. 10; *δὲ τῆς σφαιρᾶς δέκατος*). This theory, however superficial from the standpoint of observation, indicates considerable knowledge of geometry and gave a great impulse to the study of the science. Following Parmenides, Philolaus regarded the soul as a "mixture and harmony" of the bodily parts; he also assumed a substantial soul, whose existence in the body is an exile on account of sin.

Philolaus was the first to propound the doctrine of the motion of the earth; some attribute this doctrine to Pythagoras, but there is no evidence in support of their view. Philolaus supposed that the sphere of the fixed stars, the five planets, the sun, moon and earth, all moved round the central fire, which he called the hearth of the universe, the house of Zeus, and the mother of the gods (see *Stob. Ecl. Phys.* i. 488); but as these made up only nine revolving bodies he conceived, in accordance with his number theory, a tenth, which he called counter-earth, *ἀντίχθων*. He supposed the sun to be a disk of glass which reflects the light of the universe. He made the lunar month consist of 29½ days, the lunar year of 354, and the solar year of 365½ days. He was the first who published a book on the Pythagorean doctrines, a treatise of which Plato made use in the composition of his *Timæus*. This work of the Pythagorean, to which the mystical name *Βάκχου* is sometimes given, seems to have consisted of three books: (1) *Περὶ κόσμου*, containing a general account of the origin and arrangement of the universe; (2) *Περὶ φύσεως*, an exposition of the nature of numbers; (3) *Περὶ ψυχῆς*, on the nature of the soul.

¹ Boeckh places his life between the 70th and 95th Olympiads (496-396 B.C.). He was a contemporary of Socrates and Democritus, but senior to them, and was probably somewhat junior to Empedocles, so that his birth may be placed at about 480.

See Boeckh, *Philolaus des Pythagoreers Lehren nebst den Bruchstücken seines Werkes* (Berlin, 1819); Schaarschmidt, *Die angebliche Schriftstellerei des Philolaus* (1864); also Fabricius, *Bibliotheca graeca*; Zeller, *History of Greek Philosophy*; Chaignet, *Pythagore et la philosophie pythagoricienne, contenant les fragments de Philolaus et d'Archytas* (1873); Th. Gomperz, *Greek Thinkers* (Eng. trans. (1901), i. 123 sqq., 543 sqq. and authorities there quoted; also art. PYTHAGORAS. For fragments see Ritter and Preller, *Hist. Philosoph.* ch. ii.

PHILOLOGY, the generally accepted comprehensive name for the study of the word (Gr. *λόγος*), or languages; it designates that branch of knowledge which deals with human speech, and with all that speech discloses as to the nature and history of man. Philology has two principal divisions, corresponding to the two uses of "word" or "speech," as signifying either what is said or the language in which it is said, as either the thought expressed—which, when recorded, takes the form of literature—or the instrumentality of its expression: these divisions are the literary and the linguistic. Not all study of literature, indeed, is philological: as when, for example, the records of the ancient Chinese are ransacked for notices of astronomical or meteorological phenomena, or the principles of geometry are learned from the textbook of a Greek sage; while, on the other hand, to study Ptolemy and Euclid for the history of the sciences represented by them is philological more than scientific. Again, the study of language itself has its literary side: as when the vocabulary of a community (say of the ancient Indo-Europeans or Aryans) is taken as a document from which to infer the range and grade of knowledge of its speakers, their circumstances and their institutions. The two divisions thus do not admit of absolute distinction and separation, though for some time past tending toward greater independence. The literary is the older of the two; it even occupied until recently the whole field, since the scientific study of language itself has arisen only within the 19th century. Till then, literary philology included linguistic, as a merely subordinate and auxiliary part, the knowledge of a language being the necessary key to a knowledge of the literature written in that language. When, therefore, instead of studying each language by itself for the sake of its own literature men began to compare one language with another, in order to bring to light their relationships, their structures, their histories, the name "comparative philology" naturally enough suggested itself and came into use for the new method, and this name, awkward and trivial though it may be, has become so firmly fixed in English usage that it can be only slowly, if at all, displaced. European usage (especially German) tends more strongly than English to restrict the name philology to its older office, and to employ for the recent branch of knowledge a specific term, like those that have gained more or less currency with us also; as glottic, glossology, linguistics, linguistic science, science of language, and the like. It is not a question of absolute propriety or correctness, since the word philology is in its nature wide enough to imply all language-study of whatever kind; it is one, rather, of the convenient distinction of methods that have grown too independent and important to be any longer well included under a common name.

I.—The Science of Language in general.

Philology, in all its departments, began and grew up as classical; the history of our civilization made the study of Greek and Latin long the exclusive, still longer the predominant and regulating, occupation of secular ^{Nature of the Science.} scholarship. The Hebrew and its literature were held apart, as something of a different order, as sacred. It was not imagined that any tongue to which culture and literature did not lend importance was worthy of serious attention from scholars. The first essays in comparison, likewise, were made upon the classical tongues, and were as erroneous in method and fertile in false conclusions as was to be expected, considering the narrowness of view and the controlling prejudices of those who made them; and the admission of Hebrew to the comparison only added to the confusion. The change which the past century has seen has been a part of the general scientific movement of the age, which has brought about the establishment

of so many new branches of knowledge, both historical and physical, by the abandonment of shackling prejudices, the freedom of inquiry, the recognition of the dignity of all knowledge, the wide-reaching assemblage of facts and their objective comparison, and the resulting constant improvement of method. Literary philology has had its full share of advantage from this movement; but linguistic philology has been actually created by it out of the crude observations and wild deductions of earlier times, as truly as chemistry out of alchemy, or geology out of diluvianism. It is unnecessary here to follow out the details of the development; but we may well refer to the decisive influence of one discovery, the decisive action of one scholar. It was the discovery of the special relationship of the Aryan or Indo-European languages, depending in great measure upon the introduction of the Sanskrit as a term in their comparison, and demonstrated and worked out by the German scholar Bopp, that founded the science of linguistic philology. While there is abundant room for further improvement, it yet appears that the grand features of philologic study, in all its departments, are now so distinctly drawn that no revolution of its methods, but only their modification in minor respects, is henceforth probable. How and for what purposes to investigate the literature of any people (philology in the more proper sense), combining the knowledge thus obtained with that derived from other sources; how to study and set forth the material and structure and combinations of a language (grammar), or of a body of related languages (comparative grammar); how to co-ordinate and interpret the general phenomena of language, as variously illustrated in the infinitely varying facts of different tongues, so as to exhibit its nature as a factor in human history and its methods of life and growth (linguistic science)—these are what philology teaches.

The study of language is a division of the general science of anthropology (*q.v.*), and is akin to all the rest in respect to its *Relation to objects and its methods.* Man as we now see him is a twofold being: in part the child of nature, as to his capacities and desires, his endowments of mind and body; in part the creature of education, by training in the knowledge, the arts, the social conduct, of which his predecessors have gained possession. And the problem of anthropology is this: how natural man has become cultivated man; how a being thus endowed by nature should have begun and carried on the processes of acquisition which have brought him to his present state. The results of his predecessors' labours are not transmuted for his benefit into natural instincts, in language or in anything else. The child of the most civilized race, if isolated and left wholly to his own resources, aided by neither the example nor the instruction of his fellows, would no more speak the speech of his ancestors than he would build their houses, fashion their clothes, practise any of their arts, inherit their knowledge or wealth. In fact, he would possess no language, no arts, no wealth, but would have to go to work to acquire them, by the same processes which began to win them for the first human beings. One advantage he would doubtless enjoy: the descendant of a cultivated race has an enhanced aptitude for the reception of cultivation; he is more cultivable; and this is an element that has to be allowed for in comparing present conditions with past, as influencing the rate of progress, but nothing more. In all other respects it is man with the endowments which we now find him possessed of, but destitute of the gradually accumulated results of the exercise of his faculties, whose progress we have to explain. And it is, as a matter of necessity, by studying recent observable modes of acquisition, and transferring them, with due allowance for different circumstances, to the more primitive periods, that the question of first acquisition or origin is to be solved, for language as for tools, for arts, for family and social organization, and the rest. There is just as much and just as little reason for assuming miraculous interference and aid in one of these departments as in another. If men have been left to themselves to make and improve instruments, to form and perfect modes of social organization, by implanted

powers directed by natural desires, and under the pressure of circumstances, then also to make and change the signs that constitute their speech. All expressions, as all instruments, are at present, and have been through the known past, made and changed by the men who use them; the same will have been the case in the unknown or prehistoric past. And we command now enough of the history of language, with the processes of its life and growth, to determine with confidence its mode of origin—within certain limits, as will appear below.

It is beyond all question, in the first place, that the desire of communication was the only force directly impelling men to the production of language. Man's sociality, *Cause of his disposition to band together with his fellows, Language-making.* for lower and for higher purposes, for mutual help and for sympathy, is one of his most fundamental characteristics. To understand those about one and to be understood by them is now, and must have been from the very beginning, a prime necessity of human existence; we cannot conceive of man, even in his most undeveloped state, as without the recognition of it. Communication is still the universally recognized office of speech, and to the immense majority of speakers the only one; the common man knows no other, and can only with difficulty and imperfectly be brought to see that there is any other; of the added distinctness and reach of mental action which the possession of such an instrumentality gives him he is wholly unconscious: and it is obvious that what the comparatively cultivated being of to-day can hardly be made to realize can never have acted upon the first men as a motive to action. It may perhaps be made a question which of the two uses of speech, communication or the facilitation of thought is the higher; there can be no question, at any rate, that the former is the broader and the more fundamental. That the kind and degree of thinking which we do nowadays would be impossible without language-signs is true enough; but so also it would be impossible without written signs. That there was a time when men had to do what mental work they could without the help of writing, as an art not yet devised, we have no difficulty in realizing, because the art is of comparatively recent date, and there are still communities enough that are working without it; it is much harder to realize that there was a time when speaking also was an art not yet attained, and that men had to carry on their rude and rudimentary thinking without it. Writing too was devised for conscious purposes of communication only; its esoteric uses, like those of speech, were at first unsuspected, and incapable of acting as an inducement; they were not noticed until made experience of, and then only by those who look beneath the surface of things. There is no analogy closer and more instructive than this between speech and writing. But analogies are abundant elsewhere in the history of human development. Everywhere it is the lower and more obvious inducements that are first effective, and that lead gradually to the possession of what serves and stimulates higher wants. All the arts and industries have grown out of men's effort to get enough to eat and protection against cold and heat—just as language, with all its uses, out of men's effort to communicate with their fellows. As a solitary man now would never form even the beginnings of speech, as one separated from society unlearns his speech by disuse and becomes virtually dumb, so early man, with all his powers, would never have acquired speech, save as to those powers was added sociality with the needs it brought. We might conceive of a solitary man as housing and dressing himself, devising rude tools, and thus lifting himself a step from wildness toward cultivation; but we cannot conceive of him as ever learning to talk. Recognition of the impulse to communication as the efficient cause of language-making is an element of primary importance in the theory of the origin of language. No one who either leaves it out of account or denies it will, however ingenious and entertaining his speculations, cast any real light on the earliest history of speech. To inquire under what peculiar circumstances, in connexion with what mode of individual or combined action, a first outburst of oral expression may have taken place, is, on

the other hand, quite futile. The needed circumstances were always present when human beings were in one another's society; there was an incessant drawing-on to attempts at mutual understanding which met with occasional, and then ever more frequent and complete success. There inheres in most reasoning upon this subject the rooted assumption, governing opinion even when not openly upheld or consciously made, that conceptions have real natural names, and that in a state of nature these will somehow break forth and reveal themselves under favouring circumstances. The falsity of such a view is shown by our whole further discussion.

The character of the motive force to speech determined the character of the beginnings of speech. That was first signified *Beginnings of Speech and Writing* which was most capable of intelligible signification, not that which was first in order of importance, and *Writing* as judged by any standard which we can apply to it, or first in order of conceptual development. All attempts to determine the first spoken signs by asking what should have most impressed the mind of primitive man are and must be failures. It was the exigencies and possibilities of practical life, in conditions quite out of reach of our distinct conception, that prescribed the earliest signs of communication. So, by a true and instructive analogy, the beginnings of writing are rude depictions of visible objects; it is now thoroughly recognized that no alphabet, of whatever present character, can have originated in any other way; everything else is gradually arrived at from that—as, indeed, in the ingeniously shaping hands of man, from any central body of signs, though but of small extent, all else is attainable by processes of analogy and adaptation and transfer. Now what is it that is directly signifiable in the world about us? Evidently the separate acts and qualities of sensible objects, and nothing else. In writing, or signification to the eye, the first element is the rude depiction of the outline of an object, or of that one of the sum of its characteristic qualities which the eye takes note of and the hand is capable of intelligibly reproducing; from that the mind understands the whole complex object itself, and then whatever further may in the circumstances of its use be suggested by it. So, for example, the picture of a tree signifies primarily a tree, then perhaps wood, something made of wood, and so on; that of a pair of outstretched wings signifies secondarily flight, then soaring, height, and whatever else these may lead to. No concrete thing is signifiable in its totality or otherwise than by a facile analysis of its constituent qualities and a selection of the one which is both sufficiently characteristic in itself and capable of being called up by a sign before the mind addressed.

And what quality shall be selected depends in great measure upon the instrumentality used for its signification. Of such *Instrumentalities of Expression* men possess a considerable variety. We must leave out of account that of depiction, as just instanced, because its employment belongs to a much more advanced state of cultivation, and leads the way to the invention not of speech but of the analogous and auxiliary art of writing. There remain gesture, or changes of position of the various parts of the body, especially of the most mobile parts, the arms and hands; grimace, or the changes of expression of the features of the countenance (in strictness, a variety of the preceding); and utterance, or the production of audible sound. It cannot be doubted that, in the first stages of communicative expression, all these three were used together, each for the particular purposes which it was best calculated to serve. The nearest approach to such action that is now possible is when two persons, wholly ignorant of one another's speech, meet and need to communicate—an imperfect correspondence, because each is trained to habits of expression and works consciously, and with the advantage of long experience, towards making himself understood, yet it is good for its main purpose. What they do, to reach mutual comprehension, is like what the first speechless men, unconsciously and infinitely more slowly, learned to do: face, hands, body, voice, are all put to use. It is altogether probable that gesture at first performed the principal part, even to such extent that the

earliest human language may be said to have been a language of gesture signs; indeed, there exist at the present day such gesture-languages as those in use between roving tribes of different speech that from time to time meet one another (the most noted example is that of the gesture-language, of a very considerable degree of development, of the prairie tribes of American Indians); or such signs as are the natural resort of those who by deafness are cut off from ordinary spoken intercourse with their fellows. Yet there never can have been a stage or period in which all the three instrumentalities were not put to use together. In fact, they are still all used together; that is even now an ineffective speaking to which grimace and gesture ("action," as Demosthenes called them) are not added as enforcers; and the lower the grade of development and culture of a language, the more important, even for intelligibility, is their addition. But voice has won to itself the *The Voice*, chief and almost exclusive part in communication, inasmuch that we call all communication "language" (i.e. "tonguiness") just as a race of mutes might call it "handiness" and talk (by gesture) of a handiness of grimace. This is not in the least because of any closer connexion of the thinking apparatus with the muscles that act to produce audible sounds than with those that act to produce visible motions; not because there are natural uttered names for conceptions any more than natural gestured names. It is simply a case of "survival of the fittest," or analogous to the process by which iron has become the exclusive material of swords, and gold and silver of money: because, namely, experience has shown this to be the material best adapted to this special use. The advantages of voice are numerous and obvious. There is first its economy, as employing a mechanism that is available for little else, and leaving free for other purposes those indispensable instruments the hands. Then there is its superior perceptibility: its nice differences impress themselves upon the sense at a distance at which visible motions become indistinct; they are not hidden by intervening objects; they allow the eyes of the listener as well as the hands of the speaker to be employed in other useful work; they are as plain in the dark as in the light; and they are able to catch and command the attention of one who is not to be reached in any other way. We might add as the third advantage a superior capability of variation and combination on the part of spoken sounds; but this is not to be insisted on, inasmuch as we hardly know what a gesture-language might have become if men's ingenuity in expression had been expended through all time upon its elaboration; and the superiority, however real, can hardly have been obvious enough to serve as a motive: certainly, there are spoken languages now existing whose abundance of resources falls short of what is attainable by gesture. Oral utterance is the form which expression has inevitably taken, the sum of man's endowments being what it is; but it would be a mistake to suppose that a necessity of any other kind is involved in their relation. The fundamental conditions of speech are man's grade of intellectual power and his social instinct; these being given, his expression follows, availing itself of what means it finds best suited to its purpose; if voice had been wanting it would have taken the next best. So, in certain well-known cases, a marked artistic gift on the part of individuals deprived of the use of hands has found means of exercise in the feet instead. But men in general have hands, instruments of exquisite tact and power, to serve the needs of their intellect; and so voice also, to provide and use the tools of thought; there is no error in maintaining that the voice is given us for speech, if only we do not proceed to draw from such a dictum false conclusions as to the relation between thought and utterance. Man is created with bodily instruments suited to do the work prescribed by his mental capacities; therein lies the harmony of his endowment.

It is through imitation that all signification becomes directly suggestive. The first written signs are (as already noticed) the depictions of visible objects, and could be *imitation* nothing else; and, by the same necessity, the first uttered signs were the imitations of audible sounds. To reproduce

any sound of which the originating cause or the circumstances of production are known, brings up of course before the conception that sound, along with the originator, or circumstances of origination, or whatever else may be naturally associated with it. There are two special directions in which this mode of sign-making is fruitful: imitation of the sounds of external nature (as the cries of animals and the noises of inanimate objects when in motion or acted on by other objects) and imitation of human sounds. The two are essentially one in principle, although by some held apart, or even opposed to each other, as respectively the imitative or onomatopoeic and the exclamatory or interjectional beginnings of speech; they differ only in their spheres of significance, the one being especially suggestive of external objects, the other of inward feelings. There are natural human tones, indicative of feeling, as there are natural gestures, poses, modes of facial expression, which either are immediately intelligible to us (as in the warning cry of the hen to the day-old chicken), or have their value taught us by our earliest experiences. If we hear a cry of joy or a shriek of pain, a laugh or a groan, we need no explanation in words to tell us what it signifies any more than when we see a sad face or a drooping attitude. So also the characteristic cry or act of anything outside ourselves, if even rudely imitated, is to us an effective reminder and awakener of conception. We have no reason to question that such were the suggestions of the beginnings of uttered expression. The same means have made their contributions to language even down to our own day; we call words so produced "onomatopoeic" (i.e. "name-making"), after the example of the Greeks, who could not conceive that actually new additions to language should be made in any other way. What and how wide the range of the imitative principle, and what amount of language-signs it was capable of yielding, is a subject for special investigation—or rather, of speculation, since anything like exact knowledge in regard to it will never be attained; and the matter is one of altogether secondary consequence; it is sufficient for our purpose that enough could certainly be won in this way to serve as the effective germs of speech.

All the natural means of expression are still at our command, and are put to more or less use by us, and their products are as intelligible to us as they have been to any generation of our ancestors, back to the very first. They are analogous also to the means of communication of the lower animals; this, so far as we know, consists in observing and interpreting one another's movements and natural sounds (where there are such). But language is a step beyond this, and different from it. To make language, the intent to signify must be present. A cry wrung out by pain, or a laugh of amusement, though intelligible, is not language; either of them, if consciously reproduced in order to signify to another pain or pleasure, is language. So a cough within hearing of any one attracts his attention; but to cough, or to produce any other sound, articulate or inarticulate, for the purpose of attracting another's attention, is to commit an act of language-making, such as in human history preceded in abundance the establishment of definite traditional signs for conceptions. Here begins to appear the division between human language and all brute expression; since we do not know that any animal but man ever definitely took this step. It would be highly interesting to find out just how near any come to it; and to this point ought to be especially directed the attention of those who are investigating the communication of the lower animals in its relation to human communication. Among the animals of highest intelligence that associate with man and learn something of his ways, a certain amount of sign-making expressly for communication is not to be denied; the dog that barks at a door because he knows that somebody will come and let him in is an instance of it; perhaps, in wild life, the throwing out of sentinel birds from a flock, whose warning cry shall advertise their fellows of the threat of danger, is as near an approach to it as is anywhere made.

But the actual permanent beginnings of speech are only

reached when the natural basis is still further abandoned, and signs begin to be used, not because their natural suggestiveness is seen in them, but by imitation, from the example of others who have been observed to use the same sign for the same purpose. Then for the first time the means of communication becomes something to be handed down, rather than made anew by each individual; it takes on that traditional character which is the essential character of all human institutions, which appears not less in the forms of social organization, the details of religious ceremonial, the methods of art and the arts, than in language. That all existing speech, and all known recorded speech, is purely traditional, cannot at all be questioned. It is proved even by the single fact that for any given conception there are as many different spoken signs as there are languages—say a thousand (this number is rather far within than beyond the truth), each of them intelligible to him who has learned to use it and to associate it with the conception to which it belongs, but unintelligible to the users of the nine hundred and ninety-nine other signs, as these are all unintelligible to him; unless, indeed, he learn a few of them also, even as at the beginning he learned the one that he calls his own. What single sign, and what set of signs, any individual shall use, depends upon the community into the midst of which he is cast, by birth or other circumstances, during his first years. That it does not depend upon his race is demonstrated by facts the most numerous and various; the African whose purity of descent is attested by every feature is found all over the world speaking just that language, or jargon, into the midst of which the fates of present or former slavery have brought his parents; every civilized community contains elements of various lineage, combined into one by unity of speech; and instances are frequent enough where whole nations speak a tongue of which their ancestors knew nothing; for example, the Celtic Gauls and the Germanic Normans of France speak the dialect of a geographically insignificant district in central Italy, while we ourselves can hardly utter a sentence or write a line without bringing in more or less of that same dialect. There is not an item of any tongue of which we know anything that is "natural" expression, or to the possession of which its speaker is brought by birth instead of by education; there is even very little that is traceably founded on such natural expression; everywhere *θῆρ* or human attribution reigns supreme, and the original *φῶν* or natural significance has disappeared and is only to be found by theoretic induction (as we have found it above). It seems to some as if a name like *cuckoo* (one of the most striking available cases of onomatopoeia) were a "natural" one; but there is just as much *θῆρ* in it as in any other name; it implies the observation of an aggregate of qualities in a certain bird, and the selection of one among them as the convenient basis of a mutual understanding when the bird is in question; every animal conspicuous to us must have its designation, won in one way or another; and in this case to imitate the characteristic cry is the most available way. If anything but convenience and availability were involved, all our names for animals would have to be and to remain imitations of the sounds they make. That the name of *cuckoo* is applied also to the female and young, and at other than the singing season, and then to related species which do not make the same sound—all helps to show the essentially conventional character of even this name. An analogous process of elimination of original meaning, and reduction to the value of conventional designation merely, is to be seen in every part of language throughout its whole history. Since men ceased to derive their names from signs having a natural suggestiveness, and began to make them from other names already in use with an understood value, every new name has had its etymology and its historical occasion—as, for example, the name *quarantine* from the two-score (*quarantaine*) of days of precautionary confinement, or *volume* from its being rolled up, or *book* from a beech-wood staff, or *copper* from Cyprus, or *lunacy* from a fancied influence of the moon, or *priest* from being an older (*πρεσβυτερος*) person, or *butterfly* from the butter-yellow colour of a certain

common species: every part of our language, as of every other, is full of such examples—but, when once the name is applied, it belongs to that to which it is applied, and no longer to its relatives by etymology; its origin is neglected, and its form may be gradually changed beyond recognition, or its meaning so far altered that comparison with the original shall seem a joke or an absurdity. This is a regular and essential part of the process of name-making in all human speech, and from the very beginning of the history of speech: in fact (as pointed out above), the latter can only be said to have begun when this process was successfully initiated, when uttered signs began to be, what they have ever since continued to be, conventional, or dependent only on a mutual understanding. Thus alone did language gain the capacity of unlimited growth and development. The sphere and scope of natural expression are narrowly bounded; but there is no end to the resources of conventional sign-making.

It is well to point out here that this change of the basis of men's communication from natural suggestiveness to mutual understanding, and the consequent purely conventional character of all human language, in its every part and particle, puts an absolute line of demarcation between the latter and the means of communication of all the lower animals. The two are not of the same kind, any more than human society in its variety of organization is of the same kind with the instinctive herding of wild cattle or swarming of insects, any more than human architecture with the instinctive burrowing of the fox and nest-building of the bird, any more than human industry and accumulation of capital with the instinctive hoarding of bees and beavers. In all these cases alike the action of men is a result of the adaptation of means at hand to the satisfaction of felt needs, or of purposes dimly perceived at first, but growing clearer with gradually acquired experience. Man is the only being that has established institutions—gradually accumulated and perfected results of the exercise of powers analogous in kind to, but greatly differing in degree from, those of the lower animals. The difference in degree of endowment does not constitute the difference in language, it only leads to it. There was a time when all existing human beings were as destitute of language as the dog; and that time would come again for any number of human beings who should be cut off (if that were practicable) from all instruction by their fellows: only they would at once proceed to recreate language, society and arts by the same steps by which their own remote ancestors created those which we now possess; while the dog would remain what he and his ancestors have always been, a creature of very superior intelligence, indeed, as compared with most, of infinite intelligence as compared with many, yet incapable of rising by the acquisition of culture through the formation and development of traditional institutions. There is just the same *salus* existent in the difference between man's conventional speech and the natural communication of the lower races as in that between men's forms of society and the instinctive associations of the lower races; but it is no greater and no other; it is neither more absolute and characteristic nor more difficult to explain. Hence those who put forward language as *the* distinction between man and the lower animals, and those who look upon our language as the same in kind with the means of communication of the lower animals, only much more complete and perfect, fail alike to comprehend the true nature of language, and are alike wrong in their arguments and conclusions. No addition to or multiplication of brute speech would make anything like human speech; the two are separated by a step which no animal below man has ever taken; and, on the other hand, language is only the most conspicuous among those institutions the development of which has constituted human progress, while their possession constitutes human culture.

With the question of the origin of man, whether or not developed out of lower animal forms, intermediate to the anthropoid apes, language has nothing to do, nor can its study ever be made to contribute anything to the solution of that question. If there once existed creatures above the apes and

below man, who were extirpated by primitive man as his especial rivals in the struggle for existence, or became extinct in any other way, there is no difficulty in supposing them to have possessed forms of speech, more rudimentary and imperfect than ours. At any rate, all existing human speech is one in the essential characteristics which we have thus far noted or shall hereafter have to consider, even as humanity is one in its distinction from the lower animals; the differences are in non-essentials. All speech is one in the sense that every human being, of whatever race he may be, is capable of *Language and Culture*. acquiring any existing tongue, and of using it for the same purposes for which its present possessors use it, with such power and effect as his individual capacity allows, and without any essential change in the mental operations carried on by means of speech—even as he may acquire any other of the items of culture belonging to a race not his own. The difference between employing one language and another is like that between employing one instrument and another in mechanical arts; one instrument may be better than another, and may enable its user to turn out better work, but the human ingenuity behind both is the same, and works in the same way. Nor has the making of language anything whatever to do with making man what he is, as an animal species having a certain physical form and intellectual endowment. Being what he is by nature, man has by the development of language and other institutions become what he is by culture. His acquired culture is the necessary result of his native endowment, not the contrary. The acquisition of the first stumbling beginnings of a superior means of communication had no more influence to raise him from a simian to a human being than the present high culture and perfected speech of certain races has to lift them up to something more than human and specifically different from the races of inferior culture. It cannot be too absolutely laid down that differences of language, down to the possession of language at all, are differences only in respect to education and culture.

How long man, after he came into such being as he now is, physically and intellectually, continued to communicate with imitative signs of direct significance, when the *Development of Language signs* production of traditional signs began, how rapidly they were accumulated, and how long any traces of their imitative origin clung to them—these and the like questions it is at present idle to try to answer even conjecturally; just as it is to seek to determine when the first instruments were used, how soon they were shaped instead of being left crude, at what epoch fire was reduced to service, and so on. The stages of development and their succession are clear enough; to fix their chronology will doubtless never be found practicable. There is much reason for holding, as some do, that the very first items of culture were hardest to win and cost most time, the rate of accumulation (as in the case of capital) increasing with the amount accumulated. Beyond all reasonable question, however, there was a positively long period of purely imitative signs, and a longer one of mixed imitative and traditional ones, the latter gradually gaining upon the former, before the present condition of things was reached, when the production of new signs by imitation is only sporadic and of the utmost rarity, and all language-signs besides are traditional, their increase in any community being solely by variation and combination, and by borrowing from other communities.

Of what nature, in various respects, this earliest language-material was is sufficiently clear. The signs, in the first place, were of the sort that we call "roots." By this is only meant that they were integral signs, significant in their entirety, not divisible into parts, of which one signified one thing and another another thing, or of which one gave the main significance, while another was an added sign of kind or relation. In a language of developed structure like our own, we arrive at such "roots" mainly by an artificial stripping-off of the signs of relation which almost every word still has, or can be shown to have once had. In *un-cost-li-ness*, for example, *cost* is the centrally significant element; so far as English is

concerned it is a root, about which cluster a whole body of forms and derivatives; if we could follow its history no farther it would be to us an ultimate root, as much so as *bind* or *sing* or *mean*. But we can follow it up, to the Latin compound *con-sta*, a root *sta* with a prefixed formative element *con*. Then *sta*, which in slightly varied forms we find in a whole body of related tongues called "Indo-European," having in them all the same significance "stand," is an Indo-European root, and to us an ultimate one, because we can follow its history no farther; but there always remains the possibility that it is as far from being actually original as is the English root *cost*: that is to say, it is not within our power ever to get back to the really primitive elements of speech and to demonstrate their character by positive evidence. The reason for accepting a primitive root-stage of language is in great part theoretical: because nothing else is reconcilable with any acceptable view of the origin of language. The law of the simplicity of beginnings is an absolute one for everything of the nature of an institution, for every gradually developed product of the exercise of human faculties. That an original speech-sign should be of double character, one part of it meaning this and another part that, or one part radical and the other formative, is as inconceivable as that the first instruments should have had handles, or the first shelters a front room and a back one. But this theoretical reason finds all the historical support which it needs in the fact that, through all the observable periods of language-history we see formative elements coming from words originally independent, and not from anything else. Thus, in the example just taken, the *-i-* of *costliness* is a suffix of so recent growth that its whole history is distinctly traceable; it is simply our adjective *like*, worn down in both form and meaning to a subordinate value in combination with certain words to which it was appended, and then added freely as a suffix to any word from which it was desired to make a derivative adjective—or, later but more often, a derivative adverb. The *ness* is much older (though only Germanic), and its history obscurer; it contains, in fact, two parts, neither of them of demonstrable origin; but there are equivalent later suffixes, as *ship* in *hardship* and *dom* in *wisdom*, whose derivation from independent words (*shape*, *doom*) is beyond question. The *un-* of *uncostliness* is still more ancient (being Indo-European), and its probably pronominal origin hardly available as an illustration; but the comparatively modern prefix *be-*, of *become*, *believe*, &c., comes from the independent preposition *by*, by the same process as *-ly* or *-li-* from *like*. And the *con* which has contributed its part to the making of the quasi-root *cost* is also in origin identical with the Latin preposition *cum*, "with." By all the known facts of later language-growth we are driven to the opinion that every formative element goes back to some previously existing independent word; and hence that in analysing our present words we are retracing the steps of an earlier synthesis, or following up the history of our formed words toward the unformed roots out of which they have grown. The doctrine of the historical growth of language-structure leads by a logical necessity to that of a root-stage in the history of all language; the only means of avoiding the latter is the assumption of a miraculous element in the former.

Of what phonetic form were the earliest traditional speech-signs is, so far as essentials are concerned, to be inferred with reasonable certainty. They were doubtless articulate: that is to say, composed of alternating consonant and vowel sounds, like our present speech; and they probably contained a part of the same sounds which we now use. All human language is of this character; there are no sounds in any tongue which are not learned and reproduced as easily by children of one race as of another, all dialects admit a like phonetic analysis, and are representable by alphabetic signs; and the leading sounds, consonant and vowel, are even practically the same in all; though every dialect has its own (for the most part, readily definable and imitable) niceties of their pronunciation, while certain sounds are rare, or even met with only in a single group of languages or in a single language. Articulate sounds are such as are capable of being combined

with others into that succession of distinct yet connectable syllables which is the characteristic of human speech-utterance. The name "articulate" belongs to this utterance, as distinguished from inarticulate human sounds and cries and from the sounds made by the lower animals. The word itself is Latin, by translation from the Greek, and, though very widely misunderstood, and even deliberately misapplied in some languages to designate all sound, of whatever kind, uttered by any living creature, is a most happily chosen and truly descriptive term. It signifies "jointed," or broken up into successive parts, like a limb or stem; the joints are the syllables; and the syllabic structure is mainly effected by the alternation of closer or consonant sounds with opener or vowel sounds. The simplest syllabic combination (as the facts of language show) is that of a single consonant with a following vowel; and there are languages even now existing which reject any other. Hence there is much plausibility in the view that the first speech-signs will have had this phonetic form and been monosyllabic, or dissyllabic only by repetition (reduplication) of one syllable, such as the speech of very young children shows to have a peculiar ease and naturalness. The point, however, is one of only secondary importance, and may be left to the further progress of phonetic study to settle, if it can; the root-theory, at any rate, is not bound to any definite form or extent of root, but only denies that there can have been any grammatical structure in language except by development in connexion with experience in the use of language. What particular sounds, and how many, made up the first spoken alphabet is also a matter of conjecture merely; they are likely to have been the closest consonants and the openest vowels, medial utterances being of later development.

As regards their significant value, the first language-signs must have denoted those physical acts and qualities which are directly apprehensible by the senses; both because these alone are directly signifiable, and because it was only they that untrained human beings had the power to deal with or the occasion to use. Such signs would then be applied to more intellectual uses as fast as there was occasion for it. The whole history of language, down to our own day, is full of examples of the reduction of physical terms and phrases to the expression of non-physical conceptions and relations; we can hardly write a line without giving illustrations of this kind of linguistic growth. So pervading is it, that we never regard ourselves as having read the history of any intellectual or moral term till we have traced it back to a physical origin. And we are still all the time drawing figurative comparisons between material and moral things and processes, and calling the latter by the names of the former. There has never been any difficulty in providing for new knowledge and more refined thought by putting to new uses the earlier and grosser materials of speech.

As a matter of course, whatever we now signify by our simple expressions for simple acts, wants, and the like, was intended to be signified through the first speech-signs by the users of them. But to us, with our elaborated apparatus of speech, the sentence, composed of subject and predicate, with a verb or special predicative word to signify the predication, is established as the norm of expression, and we regard everything else as an abbreviated sentence, or as involving a virtual sentence. With a view to this we must have "parts of speech": that is, words held apart in office from one another, each usable for such and such a purpose and no other, and answering a due variety of purposes, so that when they are combined they fit together, as parts composing a whole, and the desired meaning is made clear. Inflections, too, lend their aid; or else auxiliary words of various kinds answering the same purpose—namely, of determining the relations of the members of the sentence. But all our success in understanding the earliest stages of language depends upon our power to conceive a state of things where none of these distinctions were established, where one speech-sign was like another, calling up a conception in its indefinite entirety, and leaving the circumstances of the case to limit its application.

Such a language is far below ours in explicitness; but it would suffice for a great deal of successful communication; indeed (as will be shown farther on) there are many languages even now in existence which are little better off. So a look of approval or disgust, a gesture of beckoning or repulsion, a grunt of assent or inquiry, is as significant as a sentence, means a sentence, is translatable into a sentence, and hence may even in a certain way be called a sentence; and in the same way, but only so, the original roots of language may be said to have been sentences. In point of fact, between the holophrastic gesture or uttered sign and the sentence which we can now substitute for it—for example between the sign of beckoning and the equivalent sentence, "I want you to come here"—lies the whole history of development of inflective speech.

What has been this history of development, how the first scanty and formless signs have been changed into the immense variety and fullness of existing speech, it is of course impossible to point out in detail, or by demonstration of facts, because nearly the whole process is hidden in the darkness of an impenetrable past. The only way to cast any light upon it is by careful induction from the change and growth which are seen to have been going on in the recent periods for which we have recorded evidence, or which are going on at the present time. Of some groups of related languages we can read the life for three or four thousand years back, and by comparison can infer it much farther; and the knowledge thus won is what we have to apply to the explanation of periods and languages otherwise unknown. Nothing has a right to be admitted as a factor in language-growth of which the action is not demonstrable in recorded language. Our own family of languages is the one of whose development most is known, by observation and well-warranted inference; and it may be well here to sketch the most important features of its history, by way of general illustration.

Apparently the earliest class-distinction traceable in Indo-European speech is that of pronominal roots, or signs of position, from the more general mass of roots. It is not a formal distinction, marked by a structural difference, but, so far as can be seen, is founded only on the assignment by usage of certain elements to certain offices. Formal distinction began with combination, the addition of one element to another, their fusion into a single word, and the reduction of the one part to a subordinate value, as sign of a certain modification of meaning of the other. Thus, doubtless by endings of pronominal origin, were made the first verb-forms, or words used only when predication was intended (since that is all that makes a verb), conveying at first a distinction of persons only, then of persons and numbers, while the further distinctions of tense and mode were by degrees added. To the nouns, which became nouns by the setting up of the separate and special class of verbs, were added in like manner distinctions of case, of number, and of gender. With the separation of noun and verb, and the establishment of their respective inflexion, the creative work of language-making is virtually done; the rest is a matter of differentiation of uses. For the noun (noun substantive) and the adjective (noun adjective) become two parts of speech only by a gradually deepened separation of use; there is no original or formal distinction between them; the pronouns as a rule merely add the noun-inflexion to a special set of stems; adverbs are a part of the same formation as noun-cases; prepositions are adverbs with a specialized construction, of secondary growth; conjunctions are the products of a like specialization; articles, where found at all, are merely weakened demonstratives and numerals.

To the process of form-making, as exhibited in this history, belong two parts: the one external, consisting in the addition of one existing element of speech to another and their combination into a single word; the other internal, consisting in the adaptation of the compound to its special use and involving the subordination of one element to the other. Both parts appear also abundantly in other departments of language-change, and throughout the whole history of our languages; nothing has to be

assumed for the earliest formations which is not plainly illustrated in the latest. For example, the last important addition to the formative apparatus of English is the common adverb-making suffix *-ly*, coming, as already pointed out, from the independent adjective *like*. There was nothing at first to distinguish a compound like *godly* (*godlike*) from one like *storm-tossed*, save that the former was more adaptable than the other to wider uses; resemblance is an idea easily generalized into appurtenance and the like, and the conversion of *godlike* to *godly* is a simple result of the processes of phonetic change described farther on. The extension of the same element to combination with adjectives instead of nouns, and its conversion to adverb-making value, is a much more striking case of adaptation, and is nearly limited to English among the Germanic languages that have turned *like* into a suffix. A similar striking case of combination and adaptation is seen in the Romanic adverb-making suffix *mente* or *ment*, coming from the Latin ablative *mente*, "with mind." So, to make a Romanic future like *dannerai*, "I shall give," there was needed in the first place the pre-existing elements, *donner*, "to give," and *ai*, "I have," and their combination; but this is only a part; the other indispensable part is the gradual adaptation of a phrase meaning "I have [something before me] for giving" to the expression of simple futurity, *donabo*. So far as the adaptation is concerned the case is quite parallel to that of *j'ai donné*, "I have given," &c. (equivalent phrases or combinations are found in many languages), where the expression of possession of something that is acted on has been in like manner modified into the expression of past action. Parallel in both combination and adaptation is the past tense *loved*, according to a widely accepted theory, from *love-did*, while we have again the same adaptation without combination in the equivalent phrase *did love*.

That these are examples of the process by which the whole inflective structure of Ind.-European language was built up admits of no reasonable question. Our belief that it is so rests upon the solid foundation that we can demonstrate no other process, and that this one is sufficient. It is true that we can prove such an origin for our formative elements in only a small minority of instances; but this is just what was to be expected, considering what we know of the disguising processes of language-growth. No one would guess in the mere *y* of *ably* (for *able-ly*) the presence of the adjective *like*, any more than in the altered final of *sent* and the shortened vowel of *led* the effect of a *did* once added to *send* and *lead*. The true history of these forms can be shown, because there happen to be other facts left in existence to show it; where such facts are not within reach we are left to infer by analogy from the known to the unknown. The validity of our inference can only be shaken by showing that there are forms incapable of having been made in this way, or that there are and have been other ways of making forms. Of the former there is evidently but small chance; if a noun-form meaning, "with mind" can become the means of conversion of all the adjectives of a language into adverbs, and a verb meaning "have" (and, yet earlier, "seize") of signifying both future and past time, there is obviously nothing that is impossible of attainment by such means. As regards the latter, no one appears to have even attempted to demonstrate the genesis of formative elements in any other way during the historical periods of language; it is simply assumed that the early methods of language-making will have been something different from and superior in spontaneity and fruitfulness to the later ones; that certain forms, or forms at certain periods, were made out-and-out, as forms; that signs of formal distinction somehow exuded from roots and stems; that original words were many-membered, and that a formative value settled in some member of them—and the like. Such doctrines are purely fanciful, and so opposed to the teachings both of observation and of sound theory that the epithet absurd is hardly too strong to apply to them. If the later races, of developed intelligence, and trained in the methods of a fuller expression, can only win a new form by a long and gradual process of combination and adaptation, why should the earlier and comparatively untrained generations have been able to do any

better? The advantage ought to be, if anywhere, on our side.

The progress of language in every department, accompanying and representing the advance of the race, on the whole, in the art of speaking as in other arts, is from the grosser to the more refined, from the physical to the moral and intellectual, from the material to the formal. The conversion of compounds into forms, by the reduction of one of their elements to formative value, is simply a part of the general process which also creates auxiliaries and form-words and connectives, all the vocabulary of mind, and all the figurative phraseology that gives life and vigour to our speech. If a copula, expressive of the grammatical relation of predication, could be won only by attenuation of the meaning of verbs signifying "grow," "breathe," "stand," and the like; if our auxiliaries of tense and mode all go traceably back to words of physical meaning (as *have* to "seize," *may* to "be great or strong," *shall* to "be under penalty," and so on); if *comes* from the comparatively physical *off*, and *for* from "before, forward"; if relative pronouns are specialized demonstratives and interrogatives; if *right* means etymologically "straight," and *wrong* means "twisted"; if *spirit* is "blowing," and *intellect* a "picking out among," and *understanding* a "getting beneath," and *development* an "unfolding"; if an event *takes place* or *comes to pass*, and then *drops out* of mind and is *forgotten* (opposite of *gotten*)—then it is of no avail to object to the grossness of any of the processes by which, in earlier language or in later, the expression of formal relations is won. The mental sense of the relation expressed is entirely superior to and independent of the means of its expression. He who, to express the plural of *man*, says what is equivalent to *man-man* or *heap-man* (devices which are met with in not a few languages) has just as good a sense of plurality as he who says *men* or *hominines*; that sense is no more degraded in him by the coarseness of the phrase he uses to signify it than is our own sense of eventuality and of pastness by the undisguised coarseness of *take place* and *have been*. In short, it is to be laid down with the utmost distinctness and confidence, as a law of language-growth, that there is nothing formal anywhere in language which was not once material; that the formal is made out of the material, by processes which began in the earliest history of language and are still in action.

We have dropped here the restriction to our own or Indo-European language with which we began, because it is evident that what is true of this family of speech, one of the *Laws of Growth* and most highly organized that exist, may also be true of the rest—must be true of them, unless some valid evidence be found to the contrary. The unity of human nature makes human speech alike in the character of its beginnings and in the general features of its after-history. Everywhere among men a certain store of expression, body of traditional signs of thought, being given, as used by a certain community, it is capable of increase on certain accordant lines, and only on them. In some languages, and under peculiar circumstances, borrowing is a great means of increase; but it is the most external and least organically important of all. Out-and-out invention (which, so far as we can see, must be of the kind called by us onomatopoeic) is found to play only a very insignificant part in the historical periods of language—clearly because there are other and easier modes of gaining new expression for what needs to be expressed. In the course of phonetic change a word sometimes varies into two (or more) forms, and makes so many words, which are differently turned to account. Everything beyond this must be the product of combination; there is no other way, so far as concerns the externals of speech. Then, partly as accompanying and aiding this external growth, partly as separate from and supplementing it, there is in all language an internal growth, making no appearance in the audible part of speech, consisting in multiplication of meanings, their modification in the way of precision or comprehension or correctness, the restriction of words to certain uses, and so on. Along with these, too, a constant change of phonetic form constitutes an inseparable part of the life of language. Speech is no more stable with respect to the sounds of which it is composed than with respect to its

grammatical forms, its vocabulary, or the body of conceptions signified by it. Even nearly related languages differ as much in their spoken alphabets and the combinations of sounds they admit, and in their uttered forms of words historically the same, as in any other part; and the same is true of local dialects and of class dialects within the same community. Phonetic change has nothing whatever to do with change of meaning; the two are the product of wholly independent tendencies. Sometimes, indeed, they chance to coincide, as in the distinction of *minute* "small," and *minute* "moment"; but it is only by chance, as the spoken accordance of *second* in its two meanings ("next" and "sixtieth of a minute") shows; words that maintain their identity of value most obstinately, like the numerals, are liable to vary indefinitely in form (so *four*, *fidvor*, *quatuor*, *τέσσαρες*, &c., from an original *kwetvor*; *five*, *quinque*, *πέντε*, *coic*, &c., from *pentwe*—while, on the other hand, *two* and *three* show as striking an accordance of form as of meaning through all the same languages); what is far the most common is that the word becomes very unlike its former self in both respects, like *priest* from the Greek *πρεσβύτερος* (*presbyter*), literally "older man." Human convenience is, to be sure, the governing motive in both changes; but it is convenience of two different kinds: the one mental, depending on the fact (pointed out above) that a name when once applied belongs to the thing to which it is applied, to the disregard of its etymological connexions, does not need to be changed when the thing changes, and is ready for new application to anything that can be brought into one class with the latter; and the other physical, depending on the organs of speech and their successive movements, by which the sounds that make up the word are produced. Phonetic convenience is economy of effort on the part of those organs; and to no other law than that of economy of utterance have any of the phenomena of phonetic change been found traceable (though it is also to be noted that some phenomena have not hitherto been successfully brought under it, and that the way of effecting this is still unclear). "Euphony," which used to be appealed to as explanation, is a false principle, except so far as the term may be made an idealized synonym of economy. The ear finds that agreeable which the organs of utterance find facile. Economy in utterance is no isolated tendency; it is the same that plays its part in all other kinds of human action, and in language appears equally in the abbreviation of the sentence by leaving out parts that can be spared without loss of intelligibility. It is an insidious tendency, always lying in wait, like gravitation, to pull down what is not sufficiently held up—the holding-up force in language being the faithfulness of tradition, or accurate reproduction by the learner and user of the signs which he has acquired. No generation of men has any intention to speak otherwise than as its predecessor has spoken, or any consciousness that it is doing so; and yet, from generation to generation, words are shortened, sounds are assimilated to one another, and one element passes out of use while a new one is introduced. Abbreviation and assimilation are the most conspicuous departments of phonetic change, and those in which the nature of the governing tendency is most plainly seen. Taken by itself, one sound is as easy as another to the person who has accustomed himself to it from childhood; and those which the young child most easily acquires are not those which in the history of speech are least liable to alteration; it is especially in the combinations and transitions of rapid speaking that the tongue, as it were, finds out for itself easier ways of performing its task, by dropping and slurring and adapting. To trace out the infinitely varied items of this change, to co-ordinate and compare them and discover their reasons, constitutes a special department of language-study, which is treated under the head of PHONETICS. It only needs to be pointed out here that phonetic change plays a necessary part in the structural development of language, by integrating compound words through fusion and loss of identity of their component parts, and, what is of yet more importance, by converting them into forms, through disguise of identity of one of the parts and its phonetic subordination to the other part. It is this that turns, for example, the compound *god-like* into

the derivative *godly*, the compound *low-did* into the verbal form *loved*. And yet one further result sometimes follows: an internal change is wrought by phonetic influence in the body of a word, which change then may in the further history of the word be left as the sole means of distinction between one form and another. It is thus that, in the most recent period, the distinction of *led* from *lead* and *met* from *meet* and so on has been made, the added auxiliary which originally made these preterites induced a shortening of the root-vowel, and this was left behind when the auxiliary disappeared by the usual process of abbreviation. It is in the same way that the distinctions of *men* from *man*, of *were* from *was*, of *set* from *sit*, with all their analogues, were brought about: by a modification of vowel-sound (Ger. *Umlaut*) occasioned by the presence in the following syllable of an *i*-vowel, which in the older stages of the language is still to be seen there. And the distinctions of *sing*, *sang*, *sung* and *song*, of *bind*, *bound*, *bund* and *bond*, are certainly of the same kind, though they go back so far in the history of our family of languages that their beginnings are not yet clearly demonstrable; they were in their origin phonetic accidents, inorganic, mere accompaniments and results of external combinations which bore the office of distinction of meaning and were sufficient to it; in some of our languages they have been disregarded and effaced, in others they have risen to prominent importance. To regard these internal changes as primary and organic is parallel with assuming the primariness of the formative apparatus of language in general; like this, it ignores the positive evidence we have of the secondary production of such differences; they are, like everything else in linguistic structure, the outcome of combination and adaptation.

Borrowing, or the taking-in of material out of another language, has been more than once referred to above as sometimes an important element in language-history, though less deep-reaching and organic than the rest. There is nothing anomalous about borrowing; it is rather

in essential accordance with the whole process of language-acquisition. All our names were adopted by us because they were already in use by others; and a community is in the same way capable of taking a new name from a community with which it comes in contact as an individual from individuals. Not that it seeks or admits in this way new names for old things; but it accepts new things along with the names that seem to belong to them. Hence any degree of intercourse between one community and another, leading to exchange of products or of knowledge, is sure to lead also to some borrowing of names; and there is hardly a language in the world, except of races occupying peculiarly isolated positions, that does not contain a certain amount of foreign material thus won, even as our English has elements in its vocabulary from half the other tongues in the world. The scale of borrowing is greatly increased when one people becomes the pupil of another in respect of its civilization: hence the abundant classical elements in all the European tongues, even the non-Romanic; hence the Arabic material in Persian and Turkish and Malay; hence the Chinese in Japanese and Korean; and, as a further result, even dead languages, like the Greek and Latin and the Sanskrit, become stores to be drawn upon in that learned and conscious quest of new expression which in the school-stage of culture supplements or even in a measure replaces the unconscious growth of natural speech. So, in mixture of communities, which is a highly-intensified form of contact and intercourse, there follows such mixture of speech as the conditions of the case determine; yet not a mixture on equal terms, through all the departments of vocabulary and grammar; the resulting speech (just as when two individuals learn to speak alike) is essentially that of the one constituent of the new community, with more or less material borrowed from that of the other. What is most easily taken in out of another language is the names of concrete things; every degree of removal from this involves additional difficulty—names of abstract things, epithets, verbs, connectives, forms. Indeed, the borrowing of forms in the highest sense, or forms of inflexion, is well-nigh or quite impossible; no example of it has been demonstrated in any of the historical periods of language, though it is some-

times adventurously assumed as a part of prehistoric growth. How nearly it may be approached is instanced by the presence in English of such learned plurals as *phenomena* and *strata*. This extreme resistance to mixture in the department of inflexion is the ground on which some deny the possibility of mixture in language, and hence the existence of such a thing as a mixed language. The difference is mainly a verbal one; but it would seem about as reasonable to deny that a region is inundated so long as the tops of its highest mountains are above water. According to the simple and natural meaning of the term, nearly all languages are mixed, in varying degree and within varying limits, which the circumstances of each case must explain.

These are the leading processes of change seen at work in all present speech and in all known past speech, and hence to be regarded as having worked through the whole history of speech. By their operation every existing tongue has been developed out of its rudimentary radical condition to that in which we now see it. The variety of existing languages is well-nigh infinite, not only in their material but in their degree of development and the kind of resulting structure. Just as the earlier stages in the history of the use of tools are exemplified even at the present day by races which have never advanced beyond them, so is it in regard to language also—and, of course, in the latter case as in the former, this state of things strengthens and establishes the theory of a gradual development. There is not an element of linguistic structure possessed by some languages which is not wanting in others; and there are even tongues which have no formal structure, and which cannot be shown ever to have advanced out of the radical stage. The most noted example of such a rudimentary tongue is the Chinese, which in its present condition lacks all formal distinction of the parts of speech, all inflexion, all derivation; each of its words (all of them monosyllables) is an integral sign, not divisible into parts of separate significance; and each in general is usable wherever the radical idea is wanted, with the value of one part of speech or another, as determined by the connexion in which it stands; a condition parallel with that in which Indo-European speech may be regarded as existing prior to the beginnings of its career of formal development briefly sketched above. And there are other tongues, related and unrelated to Chinese, of which the same description, or one nearly like it, might be given. To call such languages radical is by no means to maintain that they exhibit the primal roots of human speech, unchanged or only phonetically changed, or that they have known nothing of the combination of element with element. Of some of them the roots are in greater or less part dissyllabic; and we do not yet know that all dissyllabism, and even that all complexity of syllable beyond a single consonant with following vowel, is not the result of combination or reduplication. But all combination is not form-making; it needs a whole class of combinations, with a recognized common element in them producing a recognized common modification of meaning, to make a form. The same elements which (in Latin, and even to some extent in English also) are of formal value in *con-stant* and *pre-dict* lack that character in *cost* and *preach*; the same *like* which makes adverbs in *brav-ly* and *right-ly* is present without any such value in *such* and *which* (from *so-like* and *who-like*); *cost* and *preach*, and *such* and *which*, are as purely radical in English as other words of which we do not happen to be able to demonstrate the composite character. And so a Chinese monosyllable or an Egyptian or Polynesian dissyllable is radical, unless there can be demonstrated in some part of it a formative value; and a language wholly composed of such words is a root-language. Recent investigation goes to show that Chinese had at some period of its history a formal development, since extinguished by the same processes of phonetic decay which in English have wiped out so many signs of a formal character and brought back so considerable a part of the vocabulary to monosyllabism. In languages thus constituted the only possible external alteration is that phonetic change to which all human speech, from the

very beginning of its traditional life, is liable; the only growth is internal, by that multiplication and adaptation and improvement of meanings which is equally an inseparable part of all language-history. This may include the reduction of certain elements to the value of auxiliaries, particles, form-words, such as play an important part in analytical tongues like English, and are perhaps also instanced in prehistoric Indo-European speech by the class of pronominal roots. Phrases take the place of compounds and of inflexions, and the same element may have an auxiliary value in certain connexions while retaining its full force in others, like, for instance, our own *have*. It is not easy to define the distinction between such phrase-collocations and the beginnings of agglutination; yet the distinction itself is in general clearly enough to be drawn (like that in French between *donnerai* and *es donné*) when the whole habit of the language is well understood.

Such languages, constituting the small minority of human tongues, are wont to be called "isolating," i.e. using each element by itself, in its integral form. All besides *Agglutinative* *and* *Less* are "agglutinative," or more or less compounded *stems* into words containing a formal part, an indicator of class-value. Here the differences, in kind and degree, are very great; the variety ranges from a scantiness hardly superior to Chinese isolation up to an intricacy compared with which Indo-European structure is hardly fuller than Chinese. Some brief characterization of the various families of language in this respect will be given farther on, in connexion with their classification. The attempt is also made to classify the great mass of agglutinative tongues under different heads: those are ranked as simply "agglutinative" in which there is a general conservation of the separate identity of root or stem on the one hand, and of formative element, suffix or prefix,

Inflective, on the other; while the name "inflective," used in a higher and pregnant sense, is given to those that admit a superior fusion and integration of the two parts, to the disguise and loss of separate identity, and, yet more, with the development of an internal change as auxiliary to or as substitute for the original agglutination. But there is no term in linguistic science so uncertain of meaning, so arbitrary of application, so dependent on the idiosyncrasy of its user, as the term "inflective." Any language ought to have the right to be called inflective that has inflexion: that is, that not merely distinguishes parts of speech and roots and stems formally from one another, but also conjugates its verbs and declines its nouns; and the name is sometimes so used. If, again, it be strictly limited to signify the possession of *inner flexion* of roots and stems (as if simply agglutinated forms could be called "inflective"), it marks only a difference of degree of agglutination, and should be carefully used as so doing. As describing the fundamental and predominant character of language-structure, it belongs to only one family of languages, the Semitic, where most of the work of grammatical distinction is done by internal changes of vowel, the origin of which thus far eludes all attempts at explanation. By perhaps the majority of students of language it is, as a generally descriptive title, restricted to that family and one other, the Indo-European or Indo-Germanic; but such a classification is not to be approved, for, in respect to this characteristic, Indo-European speech ranks not with Semitic but with the great body of agglutinative tongues. To few of these can the name be altogether denied, since there is hardly a body of related dialects in existence that does not exhibit some items of "inflective" structure; the Aryan is only the one among them that has most to show. Outside the Semitic, at any rate, one should not speak of inflective and non-inflective languages, but only of languages more inflective and less inflective.

To account for the great and striking differences of structure among human languages is beyond the power of the linguistic student, and will doubtless always continue so. We are not likely to be able even to demonstrate a correlation of capacities, saying that a race which has done this and that in other departments of human activity might have been expected to form such and such a language.

Every tongue represents the general outcome of the capacity of a race as exerted in this particular direction, under the influence of historical circumstances which we can have no hope of tracing. There are striking apparent anomalies to be noted. The Chinese and the Egyptians have shown themselves to be among the most gifted races the earth has known; but the Chinese tongue is of unsurpassed jejuneness, and the Egyptian, in point of structure, little better, while among the wild tribes of Africa and America we find tongues of every grade, up to a high one, or to the highest. This shows clearly enough that mental power is not measured by language-structure. But any other linguistic test would prove equally insufficient. On the whole, the value and rank of a language are determined by what its users have made it do. The reflex action of its speech on the mind and culture of a people is a theme of high interest, but of extreme difficulty, and apt to lead its investigators away into empty declamation; taking everything together, its amount, as is shown by the instances already referred to, is but small. The question is simply one of the facilitation of work by the use of one set of tools rather than another; and a poor tool in skillful hands can do vastly better work than the best tool in unskillful hands—even as the ancient Egyptians, without steel or steam, turned out products which, both for colossal grandeur and for exquisite finish, are the despair of modern engineers and artists. In such a history of development as that of human speech a fortunate turn may lead to results of unforeseen value; the earlier steps determine the later in a degree quite beyond their own intrinsic importance. Everything in language depends upon habit and analogy; and the formation of habit is a slow process, while the habit once formed exercises a constraining as well as a guiding influence. Hence the persistency of language-structure: when a certain sum and kind of expression is produced, and made to answer the purposes of expression, it remains the same by inertia; a shift of direction becomes of extreme difficulty. No other reason can at present be given why in historical time there has been so marked development out of one grade of structure into another; but the fact no more shakes the linguistic scholar's belief in the growth of structure than the absence of new animal species worked out under his eyes shakes the confidence of the believer in animal development. The modifying causes and their modes of action are clearly seen, and there is no limit to the results of their action except what is imposed by circumstances.

It is in vain to attempt to use dates in language-history; to say when this or that step in development was taken, and how long a period it cost, especially now that the changed views as to the antiquity of man are making it probable that only a small part of the whole history is brought within the reach even of our deductions from the most ancient *Unity of* recorded dialects. At any rate, for aught that we *Origin of* know or have reason to believe, all existing dialects *Speech* are equally old; every one alike has the whole immeasurable past of language-life behind it, has reached its present condition by advance along its own line of growth and change from the first beginnings of human expression. Many of these separate lines we clearly see to converge and unite, as we follow them back into the past; but whether they all ultimately converge to one point is a question quite beyond our power to answer. If in this immensity of time many languages have waxed so little, if everywhere language-growth has been so slow, then we can only differ as to whether it is reasonably certain, or probable, or only possible, that there should have been a considerable first period of human existence without traditional speech, and a yet more considerable one before the fixation of so much as should leave abiding traces in its descendants, and that meanwhile the race should have multiplied and scattered into independent communities. And the mere possibility is enough to exclude all dogmatic assertion of the unity of origin of human speech, even assuming unity of origin of the human race. For to prove that identity by the still existing facts of language is utterly out of the question;

the metamorphosing effect of constant change has been too great to allow it. In point of fact, taking languages as they now exist, only those have been shown related which possess a common structure, or have together grown out of the more primitive radical stage, since structure proves itself a more constant and reliable evidence than material. And this is likely ever to be the case; at any rate, to trace all the world's languages so far back toward their beginnings as to find in them evidences of identity is beyond the wildest hope. We must be content with demonstrating for those beginnings a unity of kind as alike a body of formless roots. But, on the other hand, since this unity is really demonstrated, since all structure is the result of growth, and no degree of difference of structure, any more than of difference of material, refuses explanation, as the result of discordant growth from identical beginnings, it is equally inadmissible to claim that the diversities of language prove it to have had different beginnings. That is to say, the question of the unity of speech, and yet more that of the unity of the race, is beyond the reach of the student of language; the best view he can attain is the hypothetical one, that, if the race is one, the beginnings of speech were perhaps one—but probably not, even then. This negative conclusion is so clearly established as to leave no excuse for the still oft-repeated attempts to press language into service on either side of the controversy respecting human unity of race.

That all making and changing of language is by the act of its speakers is too obvious to call for discussion. No other force capable of acting and of producing effects is either demonstrable or conceivable as concerned in the work. The doctrine that language is an *organism, growing by its own inherent powers, exempt from the interference of those who use it, is simply an indefensible paradox.* Every word that is uttered is so by an act of human will, at first in imitation of others, then more and more by a formed and controlling habit; it is accessible to no change except by influences working in the speaker's mind and leading him to make it otherwise. Not that he is aware of this, or directs his action knowingly to that end. The whole process is unconscious. If any implication of reflective or intended action can be shown to inhere in any doctrine of linguistic science, it vitiates that doctrine. The attitude of the ordinary speaker towards his language is that of unreasoning acceptance; it seems to him that his names for things are their real names, and all others unintelligent nicknames; he thinks himself to possess his speech by the same tenure as his sight or hearing; it is "natural" to him (or, if he reasons about it, he attributes it to a divine origin, as races beginning to philosophize are wont to ascribe their various social institutions to their gods); he knows nothing of its structure and relations; it never occurs to him to find fault with it, or to deem it insufficient and add to or change it; he is wholly unaware that it does change. He simply satisfies his social needs of communication by means of it; and if he has anything to express that is different from what has been expressed before, he takes the shortest way to a provision for the need; while any relaxation of the energy of utterance tends to a variation in the uttered combinations; and thus changes come by his act, though without his knowledge. His sole object is, on the basis of what language he has, to make known his thought in the most convenient way to his fellow; everything else follows with and from that. Human nature and circumstances being what they are, what follows actually is, as already shown, incessant growth and change. For it we have not to seek special disturbing causes in the history of the speakers, although such may come in to brighten and quicken the change; we know that even in a small community, on a narrow islet, cut off from all intercourse with other communities, the speech would grow different—as certainly, if not as rapidly, as anywhere in the world—and only by the action of its speakers: not that the speakers of a language act in unison and simultaneously to produce a given change. This must begin in an individual, or more or less accordantly in a limited number of individuals,

and spread from such example through the community. Initiation by one or a few, acceptance and adoption by the rest—such is the necessary method of all linguistic change, and to be read as plainly in the facts of change now going on among ourselves as in those of former language. The doctrine of the inaccessibility of language to other action than that of its speakers does not imply a power in the individual speaker to create or alter anything in the common speech, any more than it implies his desire to do so. What he suggests by his example must be approved by the imitation of his fellows, in order to become language. The common speech is the common property, and no one person has any more power over it than another. If there are, for example, a thousand speakers of a certain dialect, each one yields in general a thousandth part of the force required to change it—with just so much more as may belong to his excess of influence over his fellows, due to recognized superiority of any kind on his part. His action is limited only by their assent; but this is in effect a very narrow limitation, ensuring the adoption of nothing that is not in near accordance with the already existing; though it is also to be noted that he is as little apt to strike off into startling change as they to allow it; since the governing power of already formed habits of speech is as strong in him as in them. That change to which the existing habits naturally lead is easy to bring about; any other is practically impossible. It is this tendency on the part of the collective speakers of a language to approve or reject a proposed change according to its conformity with their already subsisting usages that we are accustomed to call by the fanciful name "the genius of a language."

On the relation of the part played in language-change by the individual to that by the community, in combination with the inevitableness of change, rests the explanation of the dialectic variation of language. If language were *Dialectic Variation.* stable there would of course be no diversification; but since it is always varying, and by items of difference that proceed from individuals and become general by diffusion, there can be uniformity of change only so far as diffusion goes or as the influences of communication extend. Within the limits of a single community, small or large, whatever change arises spreads gradually to all, and so becomes part of the general speech; but let that community become divided into two (or more) parts, and then the changes arising in either part do not spread to the other, and there begins to appear a difference in linguistic usage between them. It is at first slight, even to insignificance; not greater than exists between the dialects of different localities or ranks or occupations in the same community, without detriment to the general unity of speech. This unity, namely, rests solely on mutual intelligibility, and is compatible with no small amount of individual and class difference, in vocabulary, in grammar and in pronunciation; indeed, in the strictest sense, each individual has a dialect of his own, different from that of every other, even as he has a handwriting, a countenance, a character of his own. And every item of change, as it takes place, must have its season of existence as a local or class or trade peculiarity, before it gains universal currency; some of them linger long in that condition, or never emerge from it. All these differences in the speech of different sub-communities within the same community are essentially dialectic; they differ not in kind, but only in degree, from those which separate the best-marked dialects; they are kept down by general communication within the limit of general mutual intelligibility. Where that restraining influence ceases the limit is gradually but surely overpassed, and real dialects are the result. From what we know of the life of language we can say positively that continued uniformity of speech without continued community is not practicable. If it were possible to divide artificially, by an impassable chasm or wall, a people one for ages, and continuing to occupy the same seats, the language of the divided parts would at once begin to be dialectically different; and after sufficient time had elapsed each would have become unintelligible to the other. That is to say, whenever a community of uniform speech breaks up, its speech breaks

up also; nor do we know of any other cause of dialectic diversity.

In applying this explanation of dialectic growth we have to allow for modifying circumstances of various nature, which alter not indeed the fact but the rate and kind of divarication. Some languages grow and change much more rapidly than others, with a corresponding effect upon divarication, since this is but a result of discordant growth. Usually, when there is division of a community, the parts get into different external circumstances, come in contact or mingle with different neighbouring communities, and the like; and this quickens and increases their divergence of speech. But the modifying factor of by far the highest importance here, as elsewhere in the history of language, is civilization. Civilization in its higher forms so multiplies the forces of communication as to render it possible that the widely-divided parts of one people, living in circumstances and under institutions of very different character, should yet maintain a substantial oneness of speech; of this there is no more striking example than the two great divisions of the English-speaking people on opposite sides of the Atlantic. On the other hand, a savage people cannot spread even a little without dialectic disunity; there are abundant examples to be met with now of mutually unintelligible speech between the smallest subdivisions of a race of obviously kindred tongue—as the different clusters of huts on the same coral islet. It is with linguistic unity precisely as it is with political unity, and for the same reasons. Before the attainment of civilization the human race, whether proceeding from one centre of dispersion or from several, was spread over the earth in a state of utter disintegration; but every centre of civilization becomes also a centre of integration; its influences make for unity of speech as of all other social institutions. Since culture has become incontestably the dominant power in human history, the unifying forces in language have also been stronger than the diversifying; and with culture at its full height, and spread equally to every land and race, one universal language, like one universal community, is not an absurdity or theoretic impossibility, but only a Utopian or millennial dream.

Dialectic variation is thus simply a consequence of the movements of population. As the original human race or races, so the divisions or communities of later formation, from point to point through the whole life of man on the earth, have spread and separated, but jostled and interfered, have conquered and exterminated or mingled and absorbed; and their speech has been affected accordingly. Hence something of these movements can be read in the present condition of languages, as in a faithful though obscure record—more, doubtless, than can be read in any other way, however little it may be when viewed absolutely. Dialectic resemblances point inevitably back to an earlier unity of speech, and hence of community; from what we know of the history of speech, they are not to be accounted for in any other way. The longer the separation that has produced the diversity, the greater its degree. With every generation the amount of accordance decreases and that of discordance increases the common origin of the dialects is at first palpable, then evident on examination, then to be made out by skilled research, then perhaps no longer demonstrable at all; for there is plainly no limit to the possible divergence. So long, now, as any

Families of Speech.

evidence of original unity is discoverable we call the languages "related dialects," and combine them into a "family." The term "family" simply signifies a group of languages which the evidence thus far at command, as estimated by us, leads us to regard as descended by the ordinary processes of dialectic divarication from one original tongue. That it does not imply a denial of the possibility of wider relationship is obvious from what has been said above. That there is abundant room for error in the classification represented by it is also clear, since we may take purely accidental resemblances, or the results of borrowing, for evidence of common descent, or may overlook or wrongly estimate real evidences, which more study and improved method will bring to light.

Grouping into families is nothing more than the best classification attainable at a given stage in the progress of linguistic science; it is in no small part provisional only, and is always held liable to modification, even sweeping, by the results of further research. Of some families we can follow the history by external evidences a great way back into the past; their structure is so highly developed as to be traced with confidence everywhere; and their territory is well within our reach: such we regard with the highest degree of confidence, hardly allowing for more than the possibility that some other dialect, or group, or now-accepted family even, may sometime prove its right to be added on. But these are the rare exceptions; in the great majority of cases we have only the languages as they now exist, and in more or less scanty collections, of every degree of trustworthiness; and even their first grouping is tentative and incomplete, and involves an adjournment of deeper questions to the day of more light. To complete and perfect the work of classification by relationship, or the establishment of families and their subdivisions, is the first object of the comparative study of languages. No other classification has a value in the least comparable with it; that by grade of structure is a mere recreation, leading to nothing; that by absolute worth is of no account whatever, at any rate in the present state of our knowledge. On genetic relationship, in the first place, is founded all investigation of the historical development of languages; since it is in the main the comparison of related dialects, even in the case of families having a long recorded history, and elsewhere only that, that gives us knowledge of their earlier condition and enables us to trace the lines of change. In the second place, and yet more obviously, with this classification is connected all that language has to teach as to the affinities of human races; whatever aid linguistic science renders to ethnology rests upon the proved relationships of human tongues.

That a classification of languages, to which we have now to proceed, is not equivalent to a classification of races, and why this is so, is evident enough from the principles ^{Recapitulation.} which have been brought out by our whole discussion of languages, and which, in their bearing upon this particular point, may well be recapitulated here. No language is a race-characteristic, determined by the special endowments of a race; all languages are of the nature of institutions, parallel products of powers common to all mankind—the powers, namely, involved in the application of the fittest available means to securing the common end of communication. Hence they are indefinitely transferable, like other institutions—like religions, arts, forms of social organization, and so on—under the constraining force of circumstances. As an individual can learn any language, foreign as well as ancestral, if it be put in his way, so also a community, which in respect to such a matter is only an aggregate of individuals. Accordingly, as individuals of very various race are often found in one community, speaking together one tongue, and utterly ignorant of any other, so there are found great communities of various descent, speaking the dialects of one common tongue, which at some period historical circumstances have imposed upon them. The conspicuous example, which comes into every one's mind when this subject is discussed, is that of the Romanic countries of southern Europe, all using dialects of a language which, 2500 years ago, was itself the insignificant dialect of a small district in central Italy; but this is only the most important and striking of a whole class of similar facts. Such are the results of the contact and mixture of races and languages. If language-history were limited to growth and divarication, and race-history to spread and dispersion, it would be a comparatively easy task to trace both backward toward their origin; as the case is, the confusion is inextricable and hopeless. Mixture of race and mixture of speech are coincident and connected processes; the latter never takes place without something of the former; but the one is not at all a measure of the other, because circumstances may give to the speech of the one element of population a greatly disproportionate

preponderance. Thus, there is left in French only an insignificant trace of the Celtic dialects of the predominant race-constituent of the French people; French is the speech of the Latin conquerors of Gaul, mixed perceptibly with that of its later Frankish conquerors; it was adopted in its integrity by the Norse conquerors of a part of the land, then brought into Britain by the same Norsemen in the course of their further conquests, this time only as an element of mixture, and thence carried with English speech to America, to be the language of a still further mixed community. Almost every possible phase of language-mixture is traceable in the history of the abundant words of Latin origin used by American negroes. What events of this character took place in prehistoric time we shall never be able to tell. If any one chooses to assert the possibility that even the completely isolated dialect of the little Basque community may have been derived by the Iberian race from an intrusive minority as small as that which made the Celts of Gaul speakers of Latin, we should have to admit it as a possibility—yet without detriment to the value of the dialect as indicating the isolated race-position of its speakers. In strictness, language is never a proof of race, either in an individual or in a community; it is only a probable indication of race, in the absence of more authoritative opposing indications; it is one evidence, to be combined with others, in the approach towards a solution of the confessedly insoluble problems of human history. But we must notice, as a most important circumstance, that its degree of probability is greatest where its aid is most needed, in prehistoric periods and among uncultivated races; since it is mainly civilization that gives to language a propagative force disproportionate to the number of its speakers. On the whole, the contributions of language to ethnology are practically far greater in amount and more distinct than those derived from any other source.

The genetical classification of languages, then, is to be taken for just what it attempts to be, and no more: primarily as a classification of languages only; but secondarily as casting light, in varying manner and degree, on movements of community, which in their turn depend more or less upon movements of races. It is what the fates of men have left to represent the tongues of men—a record imperfect even to fragmentariness. Many a family once as important as some of those here set down has perhaps been wiped out of existence, or is left only in an inconspicuous fragment; one and another has perhaps been extended far beyond the limits of the race that shaped it—which, we can never tell to our satisfaction.

1. *Indo-European (Indo-Germanic) Family.*—To this family belongs incontestably the first place, and for many reasons: the historical position of the peoples speaking its dialects, who have now long been the leaders in the world's history; the abundance and variety and merit of its literatures, ancient and modern, which, especially the modern, are wholly unapproached by those of any other division of mankind; the period covered by its records; and, most of all, the great variety and richness of its development. These advantages make of it an illustration of the history of human speech with which no other family can bear a moment's comparison as to value, however important various other families may be in their bearing on one and another point or department of history, and however necessary the combination of the testimony of all to a solution of the problems involved in speech. These advantages have made Indo-European language the training-ground of comparative philology, and its study will always remain the leading branch of that science. Many matters of importance in its history have been brought up and used as illustrations in the preceding discussion; but as its constitution and ascertained development call for a fuller and more systematic exposition than they have found here, a special section is devoted to the subject (see Part II. below: also *INDO-EUROPEAN LANGUAGE*).

2. *Semitic Family.*—This family also is beyond all question the second in importance, on account of the part which its peoples (Hebrews, Phœnicians, Assyrians, Syrians, Arabs,

Abyssinians, &c.) have played in history, and of the rank of its literatures. For a special treatment of it see *SEMITIC LANGUAGES*. Some of the peculiarities of the language have been alluded to above, in the monotony and rigidity of its triliteral roots, and in the extended use which it makes of internal vowel-change ("inflection" in the special sense of that term) for the purposes of grammatical distinction, it is more peculiar and unlike all the other known families of language than these are unlike one another. There are, and perhaps will always be, those to whom the peculiarities just mentioned will seem original, but if the views of language and its history taken above are in the main true, then that opinion is untenable; Semitic language must have grown into its present forms out of beginnings accordant in kind, if not identical in substance, with those of other families; and the only question remaining to be solved is, through what processes and under what governing tendencies Semitic speech should have arrived at its present state. And with this solution is most obviously and incontestably bound up that of the other interesting and much discussed question, whether the Semitic family can be shown to be related with other families, especially with the Indo-European. To some the possession in common of grammatical gender, or of the classification of objects in general as masculine and feminine, is of itself enough to prove such relationship; but, though the fact is a striking one, and of no small importance as an indication, this degree of value can by no means be attributed to it in the present state of our knowledge—any more than to any other single item of structure among the infinite variety of such, distributed among the multitude of human tongues. Many others compare the Semitic and Indo-European "roots" with one another, and believe themselves to find there numerous indications of identity of material and signification; but these also must pass for insufficient, until it shall prove possible by their aid to work out an acceptable theory of how Semitic structure should have grown out of such radical elements as underlie Indo-European structure, or out of the accordant initial products of a structural growth that afterwards diverged into two so discordant forms. To show that, both the material and the method have been hitherto wanting, and any confident decision is at least premature; but present probabilities are strongly against the solubility of the question. While many general considerations favour the ultimate unity of these two great civilized and civilizing white races of neighbouring homes, and no discordance of speech (as was shown above) can ever be made to prove their diversity of origin, it seems in a high degree unlikely that the evidence of speech will ever be made to prove them one.

3. *Hamitic Family.*—The prominent importance of this family (see *HAMITIC LANGUAGES*) is due to a single one of its members, the Egyptian. It occupies the north-eastern corner of Africa, with the border-lands of that continent stretching westward along the whole shore of the Mediterranean, and southward to beyond the equator. It falls into three principal divisions: (1) the ancient Egyptian, with its descendant, the more modern Coptic (itself now for some centuries extinct; see *EOYPT, COPTIS*); (2) the Libyan or Berber languages of northern Africa; (3) the Ethiopic languages of eastern Africa. Its situation thus plainly suggests the theory of its intrusion from Asia, across the isthmus of Suez, and its gradual spread from that point; and the theory is strongly favoured by the physical character of the Hamites, and the historical position, especially of the Egyptians, so strikingly different from that of the African races in general. Linguistic evidences of the relationship of Hamite with Semite have also been sought, and by many believed to be found; but the maintenance of the two families in their separateness is an indication that those evidences have not yet been accepted as satisfactory; and such is indeed the case. The Egyptian is a language of extreme simplicity of structure, almost of no structure at all. Its radical words are partly monosyllabic, partly of more than one syllable, but not in the latter case any more than in the former showing traceable signs of extension by formative processes from simpler

elements. It has no derivative apparatus by which noun-stems are made from roots; the root is the stem likewise; there is nothing that can be properly called either declension or conjugation; and the same pronominal particles or suffixes have now a subjective value, indicating use as a verb, and now a possessive, indicating use as a noun. There is no method known to linguistic science by which the relationship of such a tongue as this with the highly and peculiarly inflective Semitic can be shown, short of a thorough working out of the history of development of each family taken by itself, and a retracing in some measure of the steps by which each should have arrived at its present position from a common starting-point; and this has by no means been done. In short, the problem of the relation of Semitic with Hamitic, not less than with Indo-European, depends upon that of Semitic growth, and the two must be solved together. There are striking correspondences between the pronouns of the two families, such as, if supported by evidences from other parts of their material, would be taken as signs of relationship; but, in the absence of such support, they are not to be relied upon, not till it can be shown to be possible that two languages could grow to be so different in all other respects as are Egyptian and Hebrew, and yet retain by inheritance corresponding pronouns. And the possession of grammatical gender by Indo-European, Semitic and Hamitic speech, and by them almost alone, among all human languages, though an extremely noteworthy fact, is (as was pointed out above) in the present condition of linguistic science quite too weak a basis for a belief in the original identity of the three families.

Egyptian is limited to the delta and valley of the Nile, and is the only Hamitic language which has ancient records, of the others the existing forms alone are known.

The Libyan or Berber division of the family occupies the inhabitable part of northern Africa, so far as it has not been displaced by intrusive tongues of other connexion—in later times the Arabic, which since the Mahomedan conquest has been the cultivated tongue of the Mediterranean coast, while the earlier Vandal, Latin and Punic have disappeared, except in the traces they may have left in Berber dialectic speech. The principal dialects are the Kabyle, the Shilha and the Tuarek or Tamashek, corresponding nearly to the ancient Numidian, Mauretanian and Gaetulian respectively.

The third or Ethiopic division includes as its chief members the Beja or Bishárin, the Saho, the Dankali, the Somali, and the more inland Galla; the first two lying along the Red Sea north of Semitic Abyssinia, the others south of it, to the equator. By some authorities (Lepsius, Bleek) there is added to the Hamitic family as a fourth division a group from extreme southern Africa, the Hottentot and Bushman languages. The ground of this classification is the possession by the Hottentot of the distinction of grammatical gender, and even its designation by signs closely corresponding to those used in the Ethiopic division. Others deny the sufficiency of this evidence, and rank the Hottentot as a separate group of African dialects, adding to it provisionally the Bushman, until better knowledge of the latter shall show whether it is or is not a group by itself. If the Hottentot be Hamitic, we shall have to suppose it cut off at a very remote period from the rest of the family, and forced gradually southward, while all the time suffering mixture both of speech and of blood with the negro races, until the physical constitution of its speakers has become completely metamorphosed, and of its original speech no signs are left save those referred to above; and while such exceptional phonetic peculiarities have been worked out as the use of the clicks or clucking sounds: and this must be regarded as at least extremely difficult.

4. *Monosyllabic or South-eastern Asiatic Family.*—This body of languages may well enough be the next taken up; and here again (as was the case with the preceding family) on account of the prominent importance of one of its dialects and of the people speaking it—the Chinese people and language. The territory of the family includes the whole south-eastern corner

of Asia: China on the north-east. Farther India in the south, and the high plateau of Tibet, with the neighbouring Himalayan regions, to the westward. The ultimate unity of all these languages rests chiefly upon the evidence of their form, as being all alike essentially monosyllabic and isolating, or destitute of formal structure; the material correspondences among them, of accordant words, are not sufficient to prove them related. The Chinese itself can be followed up, in contemporary records, to a period probably not far from 2000 B.C., and the language, the people, and their institutions, are then already in the main what they have ever since continued to be (see CHINA); the other leading tongues come into view much later, as they receive culture and religion from China on the one hand (the Annamites), or from India on the other (the Tibetans, Burmese, Siamese); and the territory includes great numbers of wild tribes unknown until our own times, whose race-relations and language-relations are as yet very obscure. Current opinion tends to regard the Annamites, Peguans and Cambodians (the Mon-Khmer group) as forming a more nearly related group or division, and as having been the earlier population of Farther India, in part dispossessed and driven forward by the later intrusion from the north of Siamese and Burmese, of whom the former are more nearly related to the Chinese and the latter to the Tibetans. The Mon-Khmer group is itself more nearly related to the Kolarian and Malay-Polynesian.

The character of the languages of this family, especially as instanced by its most important member, the Chinese, has been pretty fully set forth in the general discussions above. They are languages of roots: that is to say, there is not demonstrable in any of their words a formative part, limiting the word, along with others similarly characterized, to a certain office or set of offices in the formation of the sentence. That the words are ultimate roots, come down from the first period of language-making, we have no reason whatever to believe; and they may possibly have passed through processes of growth which equipped them with some scanty supply of forms; but no evidence to that effect has yet been produced. The indications relied on to show an earlier polysyllabism in the family (though already in Chinese reduced to monosyllabism before the earliest historical appearance of the language, some 4000 years ago) are the comparatively recent loss of certain final mutes in Chinese words, and the presence on a considerable scale in Tibetan spelling of added initial and final consonants, now silent in the literary dialect, but claimed to be still uttered in some parts of the country. If the theory connecting these phenomena be established, the Tibetan will approve itself to be by far the most primitive of the dialects of the family, furnishing the key to the history of the rest.

For further details respecting the various tongues of the monosyllabic family, the articles on the different divisions of its territory (BURMA; CHINA; SIAM; TIBET, &c.) may be consulted. The languages all alike show an addition to the resources of distinction possessed by languages in general, in the use of tones: that is to say, words of which the alphabetic elements are the same differ in meaning according as they are uttered in a higher or a lower tone, with the rising or the falling inflexion, and so on. By this means, for example, the monosyllabic elements of the literary Chinese, numbering but 500 as we should write them, are raised to the number of about 1500 words.

5. *Ural-Altaic (Scythian, Turanian) Family.*—China and Tibet are bordered on the north and west by the eastern branches of another immense family, which stretches through central and northern Asia into Europe, overlapping the European border in Turkey, and reaching across it in Russia and Scandinavia to the very shore of the Atlantic. Usage has not so definitely determined as in the case of most other families by what name it shall be called; Turanian is perhaps the commonest appellation, but also the most objectionable. Five principal branches are generally reckoned as composing the family. The two easternmost are the Tungusian, with the Manchu for its principal division, and the Mongol (see *Manchou*)

Of these two the language is exceedingly simple in structure, being raised but little above the formlessness of the Chinese. The Tungusian, however, some authorities would couple with Japanese as a separate branch. The three others are: the Turkish or Tatar, the dialects of which reach from the mouth of the Lena (Yakut) to Turkey in Europe; the Samoyed, from the Altai down to the arctic shore of Asia, and along this to the White Sea—an unimportant congeries of barbarous tribes; and the Finno-Hungarian, including the tongues of the two cultivated peoples from which it takes its name, and also those of a great part of the population of northern and central Russia, to beyond the Ural Mountains, and finally the Lappish, of northern Scandinavia. The nearer relation of the Samoyed is with the Finno-Hungarian. The Turkish is a type of a well-developed language of purely agglutinative structure: that is, lacking that higher degree of integration which issues in internal change. Whether this degree is wholly wanting in Finnish and Hungarian is made a question; at any rate, the languages named have no reason to envy the tongues technically called "inflective." Of a value not inferior to that of inflective characteristics is one that belongs to all the Ural-Altai tongues, in varying measure and form, and helps to bind them together into a single family—the harmonic sequence of vowels, namely, as between root and endings, or a modification of the vowels of the endings to agree with that of the root or its final syllable.

While the physical race-characteristics known as Mongolian are wanting in the speakers of the western dialects of this family, they are conspicuously present in the people of Japan and Korea; and hence the tendency of scholars to endeavour to connect the languages of the two latter countries, since they also are of agglutinative structure (see JAPAN and KOREA) with the family now under treatment, as also with one another.

Other languages of north-eastern Asia, too little known to group, and too unimportant to treat as separate families, may be mentioned here by way of appendix to their neighbours of the most diversified and widespread Asiatic family. They are the Aino, of Yezo and the Kurile Islands with part of the neighbouring coast; the Kamchatkan; and the Yukagir and Tchuktchi of the extreme north-east. These are sometimes combined with the Eskimo under the title of the Arctic or Hyperborean languages.

The opinion has been held by many scholars that the agglutinative dialects—Sumerian, Accadian, &c.—of the presumed founders of Mesopotamian culture and teachers of the Aseyan Semites (see BABYLONIA) belonged to the Ural-Altai family, and specifically to its Finno-Ugrian branch; but the data for this view are still very uncertain. The mere possession of an agglutinative structure cannot be taken as proving anything in the way of relationship.

6. *Dravidian or South Indian Family.*—This is an important body of nearly and clearly related tongues, spoken by about 50,000,000 people, doubtless representing the main population of all India at the time when the intrusive Indo-European tribes broke in from the north-west, and still filling most of the southern peninsula, the Deccan, together with part of Ceylon. They are languages of a high grade of structure, and of great power and euphony; and the principal ones have enjoyed a long cultivation, founded on that of the Sanskrit. As they obviously have no Indo-European affinities, the attempt has been made to connect them also with the Ural-Altai or Turanian family, but altogether without success, although there is nothing in their style of structure that should make such connexion impossible.

7. *Malay-Polynesian Family.*—Not all the tribes that make up the non-Indo-European population of India speak Dravidian dialects. The Santals and certain other wild tribes appear to be of another lineage. These are now generally known as Kolarian, and are connected with the Malay-Polynesian family.

The islands, greater and smaller, lying off the south-eastern coast of Asia and those scattered over the Pacific, all the way from Madagascar to Easter Island, are filled with their own peculiar families of languages, standing in a more or less distant relationship to the languages of the Mon-Khmer group, and the

Kolarians on the mainland and the Nicobar islanders. The principal one among them is the great Malay-Polynesian family. It falls into two principal divisions, Malayan and Polynesian. The Malayan includes, besides the Malay proper (see MALAYS), which occupies the Malaccan peninsula (yet doubtless not as original home of the division, but by immigration from the islands), the languages also of Sumatra, Java, Borneo, &c., of the Philippine Islands, of part of Formosa, and of Madagascar, together with the coasts of Celebes and other islands occupied in the interior by Papuans. The Polynesian division includes most of the tongues of the remaining scattered groups of islands, and that of New Zealand. Probably to these are to be added, as a third division, the Melanesian dialects of the Melanesian Archipelago, of which both the physical and the linguistic peculiarities would in that case be ascribed to mixture with the black Papuan races. All these languages are extremely simple in phonetic form, and of a low grade of structure, the Polynesian branch being in both respects the lowest, and some of the Malayan dialects having reached a development considerably more advanced. The radical elements are much oftener of two syllables than of one, and reduplication plays an important part in their extension and variation. Malay literature goes back as far as to the 13th century, and there are Javan records even from the early centuries of our era, the result of religion and culture introduced into that island from Brahmanic India. In recent years more active investigation has been carried on with a view to tracing out the special laws of historical development prevailing in the family.

8. *Other Oceanic Families.*—At least two other families, unconnected with the preceding and with one another, are found among the Pacific Islands, and only there. The continental island of Australia, with its dependency Tasmania (where, however, the native tongue has now become extinct), has its own body of probably related dialects, as its own physical type. They have been but imperfectly investigated, their importance, except to the professed student of language, being nothing; but they are not destitute of a rude agglutinative structure of their own. Still less known are the Papuan or Negrito languages, belonging to the black race with frizzled hair inhabiting most of New Guinea, and found also in the interior of some of the other islands, having been driven from the coasts by superior intruders of the Malay race.

9. *Caucasian Languages.*—Of the existing languages of Asia there remain to be mentioned only those of the Caucasian mountains and highlands, between the Black and Caspian Seas, pressed upon the north by Slavonians and Turks, upon the south by Armenians and Kurds and Turks. Its situation makes of the Caucasus a natural eddy in all movements of emigration between Asia and Europe; and its linguistic condition is as if remnants of many families otherwise extinct had been stranded and preserved there. The dialects north of the principal range—Circassian, Mitsjehian, Lesghian, &c.—have not been proved to be related either to one another or to those of the south. Among the latter, the Georgian is much the most widespread and important (see GEORGIA) and, alone among them all, possesses a literature. The Caucasian dialects present many exceptional and difficult features, and are in great part of so high a grade of structure as to have been allowed the epithet inflective by those who attach special importance to the distinction thus expressed.

10. *Remnants of Families in Europe.*—The Basque people of the western Pyrenees, at the angle of the Bay of Biscay, are shown by their speech to be an isolated remnant of some race which was doubtless once much more widely spread, but has now everywhere else lost its separate identity; as such it is of extreme interest to the ethnologist (see BASQUES). The Basque language appears to be unrelated to any other on earth. It is of a very highly agglutinative structure, being equalled in intricacy of combination only by a part of the American dialects. Limited as it is in territory, it falls into a number of well-marked dialects, so that it also may not be refused the name of a "family."

The only other case of the kind worth noting is that of the

Struscan language of northern central Italy, which long ago became extinct, in consequence of the conquest and absorption of Etruria by Rome, but which still exists in numerous brief inscriptions (see *ETRUSCA*). Many attempts have been made to connect the language with other families, and it has even quite recently been pronounced Aryan or Indo-European, of the Italic branch, by scholars of high rank. But its supposed Indo-European relationship was at once shown to be erroneous when, in 1892, a small book which had been used to pack a mummy was discovered in the museum at Agram, and published. The probability of relationship with the ancient Lydian, as was the opinion held in ancient times, has been increased by recent research, and is likely soon to be verified or disproved by the discovery of Lydian records.

In order to complete this review of the languages of the Old World it only remains to notice those of Africa which have not been already mentioned. They are grouped under two heads: the languages of the south and those of the centre of the continent.

11. *South African or Bantu Family*.—This is a very extensive and distinctly marked family (see *BANTU LANGUAGES*), occupying (except the Hottentot and Bushman territory) the whole southern peninsula of the continent from some degrees north of the equator. It is held apart from all other known families of language by a single prominent characteristic—the extent to which it makes use of prefixes instead of suffixes as the apparatus of grammatical distinction; its inflexion, both declensional and conjugational, is by appended elements which precede the stem or root. The most conspicuous part of this is the variety of prefixes, different in singular and plural, by which the various classes or genders (not founded on sex; the ground of classification is generally obscure) of nouns are distinguished; these then reappear in the other members of the sentence, as adjectives and verbs and pronouns, which are determined by the noun, thus producing an alliterative concord that runs through the sentence. The pronominal determinants of the verb, both subject and object, also come before it; but the determinants of mode of action, as causative, &c., are mostly suffixed. The language in general is rich in the means of formal distinction. Those dialects which border on the Hottentots have, apparently by derivation from the latter, the clicks or clucking-sounds which form a conspicuous part of the Hottentot spoken alphabet.

12. *Central African Languages*.—The remaining languages of Africa form a broad band across the centre of the continent, between the Bantu on the south and the Hamitic on the east and north. The Bantu group, extending from north of the equator to the Cape of Good Hope, with a vast variety of dialects, is the most important of all African languages. To it belongs Swahili, the language of Zanzibar, only less valuable as a means of communication and trade than the Hausa of the Sudan, the most important of the dialects under the influence of the Hamitic languages. The African languages are by no means to be called a family, but rather a great mass of dialects, numbering by hundreds, of varying structure, as to the relations of which there is great discordance of opinion even among the most recent and competent authorities. It is no place here to enter into the vexed questions of African linguistics, or even to report the varying views upon the subject; that would require a space wholly disproportioned to the importance of African speech in the general sum of human language. There is no small variety of physical type as well as of speech in the central belt; and, partly upon the evidence of lighter tint and apparently higher endowment, certain races are set off and made a separate division of; such is the Nuba-Fulah division of F. Müller, rejected by Lepsius. The latter regarded all the varieties of physical and linguistic character in the central belt as due to mixture between pure Africans of the south and Hamites of the north and east; but this is at present an hypothesis only, and a very improbable one, since it implies modes and results of mixture to which no analogies are quotable from languages whose history is known; nor does it appear at all probable that the collision of two races and types of speech should produce such an immense and diverse body of transitional types. It is far

from impossible that the present prominence of the South African or Bantu family may be secondary, due to the great expansion under favouring circumstances of a race once having no more importance than belongs now to many of the Central African races, and speaking a tongue which differed from theirs only as theirs differed from one another. None of the Central African languages is a prefix-language in the same degree as the Bantu, and in many of them prefixes play no greater part than in the world's languages in general; others show special forms or traces of the prefix structure; and some have features of an extraordinary character, hardly to be paralleled elsewhere. One group in the east (Oigob, &c.) has a gender distinction, involving that of sex, but really founded on relative power and dignity: things disparaged, including women, are put in one class; things extolled, including men, are put in the other. This is perhaps the most significant hint anywhere to be found of how a gender-distinction like that in our own Indo-European languages, which we usually regard as being essentially a distinction of sex, while in fact it only includes such, may have arisen. Common among the African languages, as among many other families, especially the American, is a generic distinction between animate beings and inanimate things.

13. *American Languages*.—With these the case is closely the same as with the Central African languages: there is an immense number of dialects, of greatly varied structure (see *INDIANS, NORTH AMERICAN*). Even among neighbouring families like the Algonquin, Iroquois and Dakota, whose agreement in style of structure (polysynthetic), taken in connexion with the accordant race-type of their speakers, forbids us to regard them as ultimately different, no material correspondence, agreement in words and meanings, is to be traced; and there are in America all the degrees of polysyntheticism, down to the lowest, and even to its entire absence. Such being the case, it ought to be evident to every one accustomed to deal with this class of subjects that all attempts to connect American languages as a body with languages of the Old World are and must be fruitless.

Literature.—Many of the theoretic points discussed above are treated by the writer with more fulness in his *Language and the Study of Language* (1867) and *Life and Growth of Language* (1875). Other English works to consult are M. Müller's *Lectures on the Science of Language*; Farrar's *Chapters on Language*; Wedgwood's *Origin of Language* (all more or less antiquated); Sayce's *Principles of Philology and Introduction to the Science of Language, &c.*; Sweet, *The History of Language* (1900). In German, see Paul's *Principien der Sprachgeschichte* (Halle, 1880); Delbrück's *Einleitung in das Sprachstudium* (Leipzig, 1880; 4th ed., 1909; 5th ed., 1910; there is also an English version); Brugmann and Delbrück's *Grundriss der vergleichenden Grammatik der indogermanischen Sprachen* (1886–1900; a second edition of the first volume was published in 1897, two parts of vol. ii., including the stem-formation and declension of the noun and pronoun appeared in 1906 and 1909); also the works of W. von Humboldt and of H. Steinthal, the most important of whose linguistic works, *Charakteristik der hauptsächlichsten Typen des Sprachbaues* (1861), was recast and brought up to date under the same title by F. Misteli (1893). See also handy summaries covering the same ground, but without bibliography, in F. N. Finck's *Die Sprachstämme des Erdkreises* (1909) and *Die Haupttypen des Sprachbaues* (1910). Many of the languages of India and Farther India have been treated in the *Linguistic Survey of India*, edited by Dr G. E. Grierson (a government publication still in progress). A short popular account of the subject is given in Porczizinski's *Einleitung in die Sprachwissenschaft* (1910), a German translation of a Russian original. The Bantu languages have been treated by Black, Torrand, and most recently by Meinhof, whose *Lehrbuch der Bantu Sprachen* (1910) is the most complete handling of the subject. As to the classification and relationships of languages, see Hovelacque's *La Linguistique* (Paris, 1876) and F. Müller's *Grundriss der Sprachwissenschaft* (Vienna, 3 vols.; a fourth was left incomplete at the author's

death). Both works are already somewhat antiquated. As to the history of the study, see Lersch's *Sprachphilosophie der Alten* (1840); Steintal's *Geschichte der Sprachwissenschaft bei den Griechen und Römern* (1863); Benfey's *Geschichte der Sprachwissenschaft und Orientalischen Philologie in Deutschland* (1869); Sandys's *History of Classical Scholarship* (3 vols., 1906-1908); Vilh. Thomsen's *Sprogardenskalets Historien Kortfattet framkling* (W. D. W.) (1902).

II.—Comparative Philology of the Indo-European Languages.

The study of Indo-European comparative philology has from its outset necessarily been in close connexion with the study of Sanskrit, a language unparalleled amongst its cognates in antiquity and distinctness of structure, and consequently the natural basis of comparison in this field. It is therefore not to be wondered at that we find no clear views of the mutual relationship of the individual members of the Indo-European family or their position with regard to other languages until Sanskrit began to attract the attention of European philologists, or that the introduction of Sanskrit as an object of study was closely followed by the discovery of the original community of a vast range of languages and dialects hitherto not brought into connexion at all, or only made the objects of baseless speculations. We meet with the first clear conception of this idea of an Indo-European community of languages in the distinguished English scholar

Historical Sketch.

Sir William Jones, who, as early as 1786, expressed himself as follows: "The Sanskrit language, whatever may be its antiquity, is of wonderful structure; more perfect than the Greek, more copious than the Latin, and more exquisitely refined than either, yet bearing to both of them a stronger affinity, both in the roots of verbs and in the forms of grammar, than could have been produced by accident; so strong that no philologist could examine all the three without believing them to have sprung from some common source which, perhaps, no longer exists. There is a similar reason, though not quite so forcible, for supposing that both the Gothic and the Celtic, though blended with a different idiom, had the same origin with the Sanskrit."¹ But neither Sir William Jones nor any of his older contemporaries who had arrived at similar conclusions ever raised this important discovery from a brilliant *aperçu* into a valid scientific theory through a detailed and systematic comparison of the languages in question. To have achieved this is the undoubted merit of the German, Franz Bopp (*q. v.*), the founder of scientific philology of the Indo-European languages, and subsequently through this example also the founder of comparative philology in general. Next to him Jacob Grimm (*q. v.*) must be mentioned here as the father of historical grammar. The first part of his famous *Deutsche Grammatik* appeared in 1819, three years after Bopp had published his first epoch-making book, *Ueber das Conjugationssystem der Sanskritsprache*. Bopp's results were here at once utilized, yet Grimm's whole system was entirely independent of that of Bopp, and had no doubt been worked out before Grimm knew of his illustrious predecessor. In fact, their scientific aims and methods were totally different. Bopp's interest was not concentrated in comparison as such, but chiefly inclined towards the explanation of the origin of grammatical forms, and comparison to him was only a means of approaching that end.

In this more or less speculative turn of his interest Bopp showed himself the true son of a philosophical period when general linguistics received its characteristic stamp from the labours and endeavours of men like the two Schlegels and Wilhelm von Humboldt. Jacob Grimm's aims were of a less lofty character than those of Bopp, whose work, to his own mind, was crowned by his theory of the origin of inflexion through agglutination. In confining his task to a more limited range than the vast field of Indo-European languages embraced in

¹ For this quotation and the following historical sketch in general see Th. Benfey, *Geschichte der Sprachwissenschaft*, p. 43B (Munich, 1869), and especially B. Delbrück, *Introduction to the Study of Language*, p. 1 (Leipzig, 1882; a fifth German edition appeared in 1909).

Bopp's researches, and thus fixing his attention on a group of idioms exhibiting a striking regularity in their mutual relationship, both where they coincide and where they differ, he made it his foremost object to investigate and illustrate the continuous progress, subject to definite laws, by which these languages had been developed from their common source. He thus raised the hitherto neglected study of the development of sounds to an equal level with the study of grammatical forms, which had so far almost exclusively absorbed all the interest of linguistic research. Grimm's discovery of the so-called "Lautverschiebung," or Law of the Permutation of Consonants in the Teutonic languages (which, however, had been partly found and proclaimed before Grimm by the Danish scholar Rask), became especially important as a stimulus for further investigation in this line. Grimm's influence on comparative philology (which is secondary only to that of Bopp, although he was never a comparative philologist in the sense that Bopp was, and did not always derive the benefit from Bopp's works which they might have afforded him) is clearly traceable in the work of Bopp's successors, amongst whom Friedrich August Pott (1802-1887) is universally judged to hold the foremost rank. In his great work, *Etymologische Forschungen auf dem Gebiete der indogermanischen Sprachen, mit besonderem Bezug auf die Lautumwandlung im Sanskrit, Griechischen, Lateinischen, Litauischen, und Gotischen* (Lemgo, 1833-1836), we find Indo-European etymology for the first time based on a scientific investigation of general Indo-European phonology. Amongst Pott's contemporaries Theodor Benfey deserves mention on account of his *Griechisches Wurzellexicon* (Berlin, 1839), a work equally remarkable for copiousness of contents and power of combination, yet showing no advance on Bopp's standpoint in its conception of phonetic changes.

A third period in the history of Indo-European philology is marked by the name of August Schleicher, whose *Compendium der vergleichenden Grammatik der indogermanischen Sprachen* first appeared in 1861. In the period subsequent to the appearance of Pott's *Etymologische Forschungen*, a number of distinguished scholars, too large to be recorded here individually,² had devoted their labours to the different branches of Indo-European philology, especially assisted and promoted in their work by the rapidly progressing Vedic (and Avestic) studies that had been inaugurated by Rosen, Roth, Benfey, Westergaard, Müller, Kuhn, Aufrecht and others. Moreover, new foundations had been laid for the study of the Slavonic languages by Miklosich and Schleicher, of Lithuanian by Kurschat and Schleicher, of Celtic by Zeus. Of the classical languages Greek had found a most distinguished representative in Curtius, while Corssen, Mommsen, Aufrecht, Kirchhoff, &c., had collected most valuable materials towards

² The extensive progress made in this period is best illustrated by the foundation of two periodicals especially devoted to Indo-European comparative philology, Kuhn's *Zeitschrift für vergleichende Sprachforschung* (now 27 vols., Berlin, from 1851), and Kuhn's *Beiträge zur vergleichenden Sprachforschung* (8 vols., Berlin, from 1858). Benfey's school is more especially represented by the contributors to Benfey's *Oriens et Occident* (3 vols., Göttingen, from 1862), and subsequently through Bezzenberger's *Beiträge zur Kunde der indogermanischen Sprachen* (30 vols., Göttingen, from 1877); this journal has now been amalgamated with Kuhn's *Zeitschrift*. The views of the "New Grammarians"—Leskien, Brugmann, Osthoff and their schools—are represented in *Indogermanische Forschungen* (27 vols., since 1890). The Göttingen school has a further representative in Glotta, now (1910) in its third volume. The history of the meaning of words has a special periodical for itself, *Wörter und Sachen*, now in its second volume. Besides those mentioned there are many journals, publications of academies, &c., in Belgium, Sweden, Denmark, Italy, &c., which no serious student of comparative philology can ignore. France possesses two periodicals of the same kind, the *Revue de Linguistique* (Paris, from 1868) and the *Mémoires de la Société de Linguistique de Paris* (also from 1868), while England is represented by the *Proceedings and Transactions of the Philological Societies of London and Cambridge*, the *Classical Review* (23 vols., since 1887), and the *Classical Quarterly* (4 vols., since 1907), and America by the *Transactions of the American Philological Association* (from 1868), the *American Journal of Philology* (30 vols., from 1880), *Classical Philology* (5 vols., from 1906), and other more specialist organs.

the elucidation of Latin and the cognate Italic idioms. In his *Compendium* Schleicher undertook and solved the difficult task of sifting down the countless details amassed since the days of Böpp and Grimm, and thus making the individual languages stand out clearly on their common background, while Bopp's attention had been especially occupied with what was common to all Indo-European tongues. There are two prominent features which characterize this part of Schleicher's work—his assumption and partial reconstruction of a prehistoric parent speech, from which the separate Indo-European languages were supposed to have sprung, and the establishment of a long series of phonetic laws, regulating the changes by which that development of the individual idioms had taken place. On Schleicher's views of and contributions towards general comparative philology (which he erroneously proposed to consider as a branch of natural science) we need not enter here. (See *Evolution and the Science of Language in Darwin and Modern Science*, 1909, pp. 526 sqq.)

For some time after Schleicher's premature death (in 1868) Indo-European philology continued in paths indicated by him and Curtius, with the exception, perhaps, of the school founded by Benfey, who had always stood on independent ground. The difference between the two schools, however, was less strikingly marked in their writings, because it chiefly concerns general views of language and the Indo-European languages in particular, although the characteristic task of the period alluded to was that of working out the more minute details of comparison; but behind all this the general interest still clung to Bopp's old glottogonic problems. In 1876, however, a new movement, inspired in the first instance by the works of W. D. Whitney, began, and a younger school of linguists has sprung up who are united in their opposition to many theories of the older generation, yet often differ materially both with regard to method and the solution of individual problems. In its present state this younger school (often branded with the name of Neo-Græmmarians, "Junggrammatiker," by its opponents real and imaginary) is marked by certain distinct tendencies. In the first place, they are inclined more or less, and the older members of the school perhaps more than the younger, to abandon glottogonic problems as insoluble, if not for ever, yet for the present and with the scanty means that Indo-European philology alone can furnish for this purpose. In this they are in opposition to the whole of the older school. In the second place, they object to the use of all misleading metaphorical comparisons of processes in the history of language with processes of organic development—comparisons used at all times, but especially cherished by Schleicher. In the third place—and this has been of the greatest practical importance—they hold that our general views of language and our methods of comparison should be formed after a careful study of the living languages, because these alone are fully controllable in every minute detail, and can therefore alone give us a clear insight into the working of the different motive forces which shape and modify language, and that the history of earlier periods of language, consequently, can only be duly illustrated by tracing out the share which each of these forces has had in every individual case of change. Of these forces two are found to be especially prominent—phonetic variation and formation by analogy. They generally work in turns and often in opposition to one another, the former frequently tending to differentiation of earlier unities, the latter to abolition of earlier differences, especially to restoration of conformity disturbed by phonetic change. There are, however, other important differences in the action of the two forces. Phonetic change affects exclusively the pronunciation of a language by substituting one sound or sound-group for another. From this simple fact it is self-evident that phonetic changes as such admit of no exceptions. Pronunciation—that is, the use of certain sounds in certain combinations—is perfectly unconscious in natural unstudied speech, and every speaker or generation of speakers has

New Linguistic School.

Phonetic Change.

only one way of utterance for individual sounds or their combinations. If, therefore, a given sound was once changed into another under given circumstances, the new sound must necessarily and unconsciously replace its predecessor in every word that falls under the same rules, because the older sound ceases to be practised and therefore disappears from the language. Thus, for instance, the sound of the short so-called Italian *a* in English has become exchanged for the peculiarly English sound in *man, hat, &c.*, which is so exclusively used and practised now by English speakers that they feel great difficulty in pronouncing the Italian sound, which at an earlier period was almost as frequent in English as in any other language that has preserved the Italian sound up to the present day. Again, the sound of the so-called long English *a* in *make, paper, &c.*, although once a monophthong, is now pronounced as a diphthong, combining the sounds of the English short *e* and *i*, and no trace of the old monophthong is left, except where it was followed by *r*, as in *here, mare* (also *air, their, where, &c.*), where the *a* has a broader sound somewhat approaching that of the short *a* in *hat*. This last instance may at the same time serve to illustrate the restrictions made above as to sounds changing their pronunciation in certain groups or combinations, or under given circumstances only. We may learn from it that phonetic change need not always affect the same original sound in the same way in all its combinations, but that neighbouring sounds often influence the special direction in which the sound is modified. The different sounds of the English *a* in *make* and *here* are both equivalents of the same Old English sound *æ* (= the Italian short *a*) in *macion, kara*. The latter sound has been split in two, but this process again has taken place with perfect regularity, the one sound appearing before *r*, the other before all other consonants. It is easy to see that the common practice of comprising the history of the Old English *a* in the one rule—that it was changed into the sound of the *æ* in *make* except when followed by an *r*—can only be defended on the practical ground that this rule is convenient to remember, because the words exhibiting the former change are more numerous than the instances of the latter; apart from this there is nothing to justify the assumption that one of these changes is the rule and the other the exception. The fact is, that we have two independent cases of change, which ought to be stated in two distinct and independent rules according to the different positions in which the original *æ* stood before the splitting began. It is also easy to observe that the variety of modifying influences may be much more manifold than in the present instance of *make* and *here*, and that the number of special phonetic rules in such cases must be increased in proportion to the progress made in the investigation of the said modifying powers.

In truth, however, the study of phonetic laws falls into several different stages, and the meaning attached to the phrase *phonetic law* has varied at each of these stages. Moreover, the sweeping nature of the original generalizations has become so hedged in and contracted by limitations that a recent writer has been compelled once more to formulate the question whether phonetic laws actually exist. It must be admitted in the first place that the word *law* has been ill chosen for use in this connexion. In phonetic laws there is no element which can be identified as coming under the definition of a law as propounded by a jurist like John Austin. There is no authority which enunciates the law, there is no penalty for the breach of it. But the philologists who first used the term were not thinking of law in its strict signification, but of its use in such metaphorical expressions as scientific laws, for, as already mentioned, Schleicher and his followers in the middle of the 19th century had taken a keen interest in the development of the natural sciences, and had to some extent assimilated their terminology to that employed in those sciences. It was, however, soon recognized that the laws of language and those of natural science were not really alike or akin. A scientific "law" is only a brief method of expressing the fact that universal experience shows that certain causes universally produce certain effects. In chemistry two atoms of

hydrogen and one of oxygen will make water, and they will make nothing else at any time or at any place the world over. Phonetic laws, however, do not hold true universally. They are often curiously limited in the area to which they apply. In ancient Greek, for example, the sound *-s-* between two vowels, which had been handed down from the original language whence Greek and the sister languages are derived, regularly disappears; in Latin, on the other hand, it changes into *-r-*; thus an original genitive of a neuter substantive we find represented in Greek by *γῆρε-ος*, a form which comparison with other languages shows to be traceable to an earlier **genes-ος*, preceding the separation of the languages, while the same original stem with a different vowel in the ending appears in Latin as *gener-is*. Similarly an early **euso* appears in Greek as *εἴκο*, in Latin as *two*. This disappearance of original intervocalic *s* pervades all Greek dialects—the apparent exceptions come under the heading of analogical change; with a very few exceptions similarly explicable Latin intervocalic *s* has become *r*. But Latin was originally limited to a very small part even of Italy, and the next neighbours of the Latins on the east and south—the Sabines, Campanians and Samnites—retained this intervocalic *s* without changing it into *r*. On the other hand, the neighbours to the north-east—the Umbrians in and beyond the Apennines—shared in this rhotacism. Yet the Celts, who bordered on the Umbrians along the Po, and who spoke a language in many respects very closely akin to the dialects of Italy, in this regard agree rather with Greek than the Italic languages. In Latin, again, the period of action of the law which changed intervocalic *s* into *r* did not in all probability exceed the century from 450 B.C. to 350 B.C. So unlike, indeed, are phonetic laws to the laws of natural science in universality that an opponent of the dogma which declares that phonetic laws have no exceptions has compared them with the laws of fashion. The comparison is not so outrageous as it may seem at first sight. For in language there are two kinds of sound change, that which is unconscious, universal at a given time and within a given area, and, on the other hand, that which belongs only to a particular class or clique, deviates consciously from the pronunciation of the majority, is therefore not universal, and exercises no permanent influence on the language. The second kind of sound change corresponds exactly to the laws of fashion; it is in fact one of them. Such sound changes are the pronunciation of the English ending *-ing* as *-in'*, which was fashionable in the middle of the 19th century. This had, though probably without the knowledge of those who used it, an historical justification in the earlier forms from which most of the English words now ending in *-ing* are descended, and which survive in numerous local dialects. A similar conventional mispronunciation was the lisp affected by some would-be artistic persons at a somewhat later period. Belonging to an entirely different social stratum, and now equally obsolete, was the London pronunciation of the first half of the 19th century typified in Tony and Sam Weller's treatment of *v* and *w* in the *Pickwick Papers*. This, however, made a much nearer approach to being a genuine dialect peculiarity. It undoubtedly pervaded the pronunciation of the lower classes in London at one time; had it survived it might conceivably have spread over a wider and wider area until it embraced the whole population of England. A later change, that of the diphthong *ai* into *ei* (so that *day*, *daily* are pronounced *dy*, *dyly*), has spread from Essex and the East End of London over a large part of London and of the adjacent counties, and is still widening its range both geographically and socially. The history of these sound changes has not yet been investigated in detail with the thoroughness which it deserves.

There is, then, a part of sound change which is a matter of fashion and which is conscious. This sound change appears frequently in the pronunciation of individuals who have migrated from one part of a country to another. In many parts of Scotland, for example, the prepositions *with* and *of* appear in dialect only in the forms *wi'* and *o'*, which were originally the unaccented forms. In the conscious attempts to pronounce them as they appear in literary English, the educated Scotsman,

if he remains in his native place, as a rule pronounces them as *with* (with the final sound unvoiced as it appears in the Scottish legal preposition *outwith*) and as *off*, the final sound here also being unvoiced. If he migrates to England or to Australia he will probably in course of time adopt the pronunciation with a voiced final sound. In the course of years habit will become second nature, and in this respect the speaker's pronunciation will become identical with that of his neighbours. It is clear, however, that changes of this nature cannot take place on a large scale. If a large number of persons migrate in a body and continue to live in close intercourse with one another and but little in contact with the outside world, changes such as take place in the pronunciation of the individual emigrant do not occur. There can be no imitation of alien sounds, for there are none; no greater effort to be intelligible is required, for the audience has not changed. Hence it has been often remarked that a population which history shows to have remained undisturbed for very long periods in the same geographical situation manifests but little change in its language. Thus in Arabia and Lithuania the population has remained practically unmixed in the same habitat for thousands of years, with the result that the languages spoken there remain at the present day the most archaic members of the linguistic families to which they respectively belong.

From what has been said it will be obvious that a phonetic law is only an observed uniformity in the treatment of a sound or a combination of sounds within a linguistic area at a given time. In the definition the term *linguistic area* is a very variable quantity. Thus it is a phonetic law that a sound of the original Indo-European language, the precise pronunciation of which cannot be determined, but which was at any rate a palatal sound (*k*), appears in the Indo-European group (Sanskrit, Zend, Old Persian, with their descendants), in Armenian, in Balto-Slavonic and Albanian, in the form of a sibilant, while in Greek, the Italic dialects, Germanic and Celtic, it appears as a *k*-sound (see INDO-EUROPEAN LANGUAGES). Here the linguistic area is extremely wide, and it is clear that the difference between the two groups of languages must be dated back to a very early period. Again, it is a phonetic law of Greek that the original combination *st-* at the beginning of words is retained in Greek. How then are we to explain the existence side by side of *στῆνος* and *τήνος*? The former apparently complies with the law, the latter does not. The former has by its side the verb *στῆναι*, while *τήνος* is supported only by the rare *τήναι*. Yet the forms of the verb and substantive found in the Germanic languages leave no doubt that the forms without *s* represent an extremely old form, for the English *thatch* could not have changed its original *t-* into *th-* if it had been preceded by *s-*, the law being as strict for English as for Greek that initial *st-* remains unchanged. On the other hand, a phonetic law may be limited to a very small area. Thus in the dialect of Eretria, and nowhere else within the area of the Ionic dialect of ancient Greek, do we find the change of the sound which appears elsewhere in Greek as *σ-* between vowels into *ρ-*: *στῆνος* for *στῆρνος* (acc. sing.), *σπαρσῆρνος* for *σπαρσῆσῆρνος* (3rd pl. subjunctive). Why this change should take place here and nowhere else we do not know, although it may be conjectured that the cause was a mixture with immigrants speaking a different dialect, a mixture which ancient tradition supported. Undoubtedly such mixtures are the chief conditions of phonetic change, the effect of which is universal. The manner in which the change takes place is that the basis of articulation, the method in which the sound is produced, becomes changed. Thus along the "Highland line" in Scotland, where the English and Gaelic-speaking populations had their linguistic frontier for centuries, the *wh-* of English, the Anglo-Saxon *hw-*, becomes universally *f-*, *wha?* becoming *fa?* *white*, *file*, &c., *f* being the sound which it was most easy to substitute for the difficult *hw-*. The history of Spanish in the different communities of South America excellently illustrates this point. After the discovery of America there was a large influx of Spaniards into Chile, who ultimately, and chiefly by intermarriage, incorporated amongst them a considerable element from amongst the native Araucanian Indians. The result has been

that the language of Chile is Spanish, pronounced not with the genuine sounds of Spanish, but with the sounds of the Araucanian language substituted for them. Elsewhere in Spanish America the language of the conquerors remained comparatively pure, because the Spaniards were much fewer in number, and had therefore to maintain themselves as a caste apart. For the same reason Latin has split up into the numerous branches which we know as the Romance languages. The particular line of development which, e.g. French followed as compared with Spanish or with the language of the Rhaetian Alps was conditioned by the nature of the sounds in the language which preceded it in the same area, and which was spoken by the ancient Gauls who adopted Latin. The difficulty found in all of these cases is precisely of the same kind as that which an adult at the present day speaking one language finds in attempting to learn the pronunciation of another language. On the one hand, it is only with the greatest difficulty that muscles for many years accustomed to perform one set of movements can be forced into performing another set which are very similar but yet not identical; on the other hand, to an untrained ear the difference between the two sounds may remain unappreciated. The result is that the new language is pronounced with the sounds of the speaker's original language. If the new language is adopted by a whole people to whom it was originally foreign, the children naturally learn it from their parents with the sounds of the old language which has now become obsolete. Thus the basis of articulation is changed, and if, as was the case with Latin, this process be frequently repeated among peoples speaking languages with articulation widely differing one from another, it is clear that a series of different dialects of the adopted language has been created. This kind of change is immediate and universal throughout the whole area where linguistic change has taken place.

Analogue change, on the other hand, does not affect the pronunciation of a language as a whole in the way that phonetic change does, but is confined to the formation, inflexion, syntax and meaning of single words or groups of words, and therefore is very apt to bear an entirely arbitrary and irregular character. A few instances will be sufficient to illustrate this and also to show how the apparently irregular phenomena of analogy may be classified. (a) In Old English a certain number of substantives formed their plurals by mutation of the root vowels, as *fōt, fēl, or bōc, bēc*. In Modern English this system of inflexion has been preserved in some cases, as in *foot, feet*, and altered in others, as *book, books*. Now, while *foot, feet* and *book, books* are the regular modern phonetic equivalents of the old *fōt, fēl, bōc, bēc*, the plural *books* can in no way be phonetically traced back to the old *bēc*, the phonetic equivalent of which in Modern English would be **beech*. The only possible explanation of a form like *books* is that the older *bēc* was at some date given up and replaced by an entirely new formation, shaped after the analogy of the numerous words with a plural in *-s* without modification of the root-vowel. Such changes, which are very numerous, exemplify the first kind of analogy, which is generally termed *formal analogy*. Other examples are the almost entire disappearance from the language of the forms in *er* and *en*, which were earlier used as plurals in English. That they were originally stem and not case suffixes does not affect the point. In Middle English, as in Modern English, *oxen* was spelt as a plural; *oxen* survives, but *eyes*, except in such dialect forms as the Scotch *e'en*, has been replaced by the form in *-s*: *eyes*. Similarly in Middle English the suffix *-er* existed in many words which had been originally of the neuter gender. Thus the plural of *child* was *childer*, of *calf* was *calver*, traces of which, besides the survival in dialect of *childer* and of *calver* (become by the 16th century in northern Scotch *cār*—pronounced as *calr*—which is still in common use), are to be found in the place, and hence personal, names Childer-ley and Calver-ley. The old plural of *brother* was *brōther*, where the suffix, however, contained an original *-r*, not *-s* changed into *-r*, as did *childer* and *calver*. In Old English, alongside the form for *child* making a plural *childer*, there had been a masculine form making its plural in *-s*. It would not have been surprising there-

fore if in Modern English the plural of *child* had been *childs*. But in spite of the common tendency to make the plural of all nouns in *-s*, *child* has gone in the opposite direction and has not only maintained its *-r*, but has added to it the *-en* of stems like *oxen* and *eyes*. In Wiclif we find a similar plural to calf, *calveren*, but here *calves* has long replaced in the literary language both the earlier forms.

(b) Let us now take another instance from the English verb. In Old English the different persons of the preterite indicative in the so-called strong (irregular) verbs were generally distinguished by different root-vowels; *ridan*, "to ride," and *bindan*, "to bind," for instance, form their preterites thus; *ic rād, 88 ride, he rād, wē, gē, hi8 ridon*, and *ic band, 88 bunde, he band, wē, gē, hi8 bundon*. In modern English this difference in the root-vowels has been abandoned, and *rode, bound* now stand for all persons, *rode* being the modern phonetic equivalent of the 1st and 3rd sing. *rād*, while *bound* represents the *u*-form of *bindan*. When one form or set of forms ousts other varying forms from the same paradigm, the change is described variously as *material or logical analogy*. Inasmuch as a similar process of levelling to that seen in *rode* has been carried through in all preterites of Modern English, regularity prevails even here, though a few traces of the old conflict are still visible in such poetic forms as *sung* for the preterite *sige* by side with *sang*. But when we look to its results in the individual verbs we soon find that the choice amongst the different forms which might have served as starting-points has been entirely arbitrary. It is indeed impossible to say why the old singular form should have been chosen as a model in one case, as in *rode*, and the old plural form in another, as in *bound*. From these and numerous similar instances we must draw the conclusion that it is beyond our power to ascertain whence analogical changes start, and to what extent they may be carried through when once begun. All we can do is to classify carefully the single cases that come under our observation, and in this way to investigate where such changes are especially apt to take place and what is their general direction. As to the latter points, it has been observed before that levelling of existing differences is one of the chief features in analogical change (as in the case of *rode* and *bound*). As to the former, it must be borne in mind that, before any analogical change can take place, some mental connexion must exist between the words or forms serving as models and those which are remodelled after the types suggested to the minds of the speakers through the former. Of such natural mental combinations two classes deserve special notice: the mutual relationship in which the different, say inflexional, forms of the same word stand to each other, and the more abstract analogies between the inflexional system of word-groups bearing a similar character, as, for instance, the different declensions of nouns and pronouns, or the different conjugations of verbs. The instance of *rode, bound* may serve to illustrate the former category, that of *books* the latter. In the first case a levelling has taken place between the different forms of the root-vowels once exhibited in the different preterite forms of *ridan* or *bindan*, which clearly constitute a natural group or mental unity in consequence of their meaning. The form of *rode* as a plural has simply been taken from the old singular *rād*, the long *a* of which has become in Modern English *o*, that of *bound* as a singular from the old plural *bundon*, the *u*-sound of which has in Modern English come to be pronounced as a diphthong. In the case of *book, books* for *bōc, bēc*, this explanation would fall short. Although we might say that the vowel of the singular here was carried into the plural, yet this would not explain the plural *-s*. So it becomes evident that the old declension of *bōc, bēc* was remodelled after the declension of words like *arm, arms*, which had always formed their plurals in *-s*. The changes indicated may generally be shown by a proportion, the new analogical formation being the unknown quantity to be ascertained. Thus in the case cited above, *arm: arms = book: x*; and clearly the form to be ascertained is *books*. Isolated words or forms which are no part of natural groups or systems, inflexional, formative or syntactical must be regarded as commonly safe from alterations

through analogy, and are therefore of especial value with regard to establishing rules of purely phonetic development.

(c) In syntactical analogy the mental connexion between the two series of constructions between which the change takes place is generally still more conspicuous. The connexion may be one of similar or of contrasted meaning. In Latin, adjectives of fullness, like other adjectives, no doubt originally were followed by the genitive case; participles, on the other hand, were followed by the instrumental ablative. Thus Plautus in the *Aulularia* 813 and elsewhere could say *aulam auri plenam*, "a pot full of gold," or *802 aulam onustam auro*, "a pot laden with gold." From these the transition was easy to the construction *aulam onustam auri*, as if in English one should say (as was possible in Earlier English), "a pot laden of gold." In English, contrasted words often tend to assimilate their syntactical constructions. Thus, the adjectives *like* and *similar* are followed by the preposition *to* (though in Modern English *like* need have no preposition), and upon the analogy of such words, *different* and *averse*, with which correct speakers and writers couple *from*, are by no means rarely followed by *to*. Nor is it uncommon to hear or to see *differ with* instead of *differ from*, upon the analogy of *agree with*. Curiously enough, Latin, from which *differ* is descended, is found to follow the same analogy even in good writers. Thus Cicero (*Academica Pr.* ii. 143) combines *dissidere with cum*, as later does Seneca (*Epistulae*, 18. 1).

(d) In the development of analogy in meaning, similarity of sound is often the effective cause. Thus *impertinent* is properly *irrelevant, not to the point*, and is still so used in legal language; its more common signification of "saucy" arises from its accidental resemblance in sound to *pert*, a word which curiously enough has reversed its meaning, being now used in the sense of *mal-apert*, while the Old French *apert, aspert* (a confusion of Lat. *apertus*, "open," with *expertus*, "skilled"), meant both "open" and "skilful." Thus from very early times the verbs *fly* and *see* have been confused, though they are of entirely different origins. When Middle English began to lose its verb endings in *-en*, it was very easy for the verb *learn*, "teach," and *learnen*, "learn," to be confused. Hence frequently in Elizabethan English *learn* stands side by side with *teache* in the same signification. Cf. Tottell's Miscellany, p. 129 (Arber):

"I would not have it thought hereby
The dolphin swimme I meane to teache:
Nor yet to learn the Fawcon flie:
I rowe not so farre past my reace."

It is true that the distinction between phonetic and analogical change has always been acknowledged in comparative philology. At the same time it cannot be denied that analogical changes were for a long time treated with a certain disdain and contempt, as deviations from the only course of development then allowed to be truly "organic" and natural, namely, that of gradual phonetic change (hence the epithet "false" so constantly attached to analogy in former times). Amongst those who have recently contributed most towards a more correct evaluation of analogy as a motive power in language, Professor Whitney must be mentioned in the first place. In Germany Professor Scherer (*Zur Geschichte der deutschen Sprache*, 1868) was the first to apply analogy as a principle of explanation on a larger scale, but in a wilful and unsystematic way. Hence he failed to produce an immediate and lasting impression, and the merit of having introduced into the practice of modern comparative philology a strictly systematic consideration of both phonetic and analogical changes as co-ordinate factors in the development of language rests with Professor Leskien of Leipzig, and a number of younger scholars who had more or less experienced his personal influence. Amongst these Brugmann, Osthoff and Paul rank foremost as the most vigorous and successful defenders of the new method, the correctness of which has since been practically acknowledged by most of the leading philologists of all shades of opinion.

While the syntax of individual languages was one of the first features which attracted the grammarians' attention, at any rate in so far as particular authors differed from a given

standard, it is only in very recent times that syntax has received methodical treatment from the comparative point of view. It may indeed be said that almost the whole fabric of the comparative syntax of the ^{Historical} Indo-European languages as it exists to-day has been reared by one man—Professor Berthold Delbrück of Jena. In a series of brilliant studies beginning with a pamphlet on the Locative, Ablative, and Instrumental, published in 1867, and continued in his *Syntactical Researches (Syntaktische Forschungen)* in five volumes, comprising a treatment of the conjunctive and optative moods in Sanskrit and Greek (1871), the theory of the Sanskrit tenses (1877), the order of words in early Sanskrit prose (*Çatapatha Brahmana*; 1878), the foundations of Greek syntax (1879), and the syntax of the oldest Sanskrit (*Altindische Syntax*), dealing exclusively with the literature of the Vedas and Brahmanas (1888), Professor Delbrück laid the foundations for his treatment of comparative syntax in three volumes (1893, 1897, 1900), which has formed the completion of Brugmann's *Grundriss der vergleichenden Grammatik der indogermanischen Sprachen*. The only work by another hand (on a large department of the subject) which deserves to be mentioned by the side of Delbrück's studies is the small treatise by Hübschmann on the theory of the cases (*Zur Casuslehre*, 1875). For the comparative neglect of this field of investigation there are several reasons. The earlier philologists had so much to do in determining the languages which should be included within the Indo-European group, and in organizing the field of research as a whole, that it is not to be wondered at if they were unable to devote much attention to syntax. In the 'seventies, when attention began to be more directed towards comparative syntax, the remarkable discoveries made by Verner with regard to accentuation, and by Brugmann, Collitz and others with regard to the phonology of the Indo-European languages, again distracted attention from the subject. Moreover, the research in itself is infinitely more difficult than that into sounds and forms; for the latter may be carried on by the help of grammars and dictionaries with a comparatively small knowledge of the literature of any individual language, while on the other hand the study of syntax is impossible without a thorough and intimate knowledge of the literature and modes of expression in each separate language. It is not, therefore, matter for wonder that Delbrück has confined himself in the investigation of syntax to a part only of the languages whose sounds and forms are discussed by Brugmann in the earlier volumes of the *Grundriss*. To cover the whole ground is beyond the powers of a single man, and there is a great lack of preliminary studies on the syntax of many of the languages.

One of the most difficult problems connected with syntax, but primarily, as it appears, a question of morphology, is the origin of grammatical gender. It cannot be said to be an advantage to the languages which possess it, while languages which, like English, have dropped it except for an occasional metaphor, suffer no loss. Nor is the problem confined to the history of gender in the substantive. Even more perplexing is the introduction of gender into the adjective. The pronouns of the first and second persons, which are certainly very old, show no trace of gender; the pronouns of the third person, which are more of the nature of deictic adjectives, generally possess it. To the question how grammatical gender arose in the substantive, the answer was till comparatively recently supposed to be that primitive man was given greatly to personification, endowing inanimate things with life and attributing to them influences benign or the reverse upon his own existence. The answer is not quite sufficient, for though this tendency to personification, which philologists have perhaps unduly decried or altogether denied, might account for life being attributed to inanimate objects, it hardly explains why some should be treated as masculine and others as feminine. Nor is it true, as has also been suggested, that in the case of the lower animals the generic name for the larger and stronger animals is masculine and that for the smaller or weaker feminine. In both Greek and Latin the wolf

is masculine and the fox feminine, but the lamb or the chicken which the fox robs from the fold or the hen-roost is rarely feminine, generally masculine. Nor does this explanation account for the mouse in those languages being of the masculine gender, while the ferret or cat which caught them is feminine (*γαλι, felēs*). An explanation which completes the theory of personification, if it does not altogether drive it from the field, has been put forward by Brugmann.¹ In its briefest form this explanation is that gender was attached to certain suffixes because they chanced to occur frequently in words which markedly implied sex. In the Indo-European languages the commonest suffix indicating feminine gender is *a*. According to this theory it had originally nothing to do with gender, but as some early words for woman or wife ended with this sound it came to be identified with feminine gender. Similarly the ending *er* in *o*-stems occurred often in names connected with males and so became identified with the masculine gender. But many stems indicate either gender indifferently, and even the very old sex words *father* and *mother* have the same ending. But when masculine and feminine endings have been attached to certain suffixes in this way, how comes it that in one series of stems the neuter should be marked not by an absence of all suffix but by a separate suffix in *-m*? These are the *o*-stems, other forms of which have been markedly identified with the masculine gender. As this characteristic, like the others mentioned, goes back apparently to a time before the separation of the Indo-European languages, explanation can hardly pass beyond speculation. It is, however, to be noted that the neuter form of the nominative is phonetically identical with the accusative form of the masculine, and it has been ingeniously argued² that such forms were used originally in the accusative, such neuters not forming the subject to a verb. To the same writer the most plausible explanation of the presence of gender in the adjective is due, viz. that gender began with the deictic pronoun *so "that man," *sa "that woman," and that hence it passed to the adjective with which the pronoun was so frequently accompanied. If this explanation be right, analogy has brought into the Indo-European languages the useless multiplication of gender marks in such sentences as the Latin *haec pulchrae feminae caesae sunt*, where the feminine gender is indicated no less than four times without any obvious gain over the English *These fair women were slain*, where grammatical gender is no longer obviously indicated at all.

Closely related to this question is that of the history of the neuter plural, which was first fully worked out by Professor Johannes Schmidt of Berlin.³ The curious construction, most common in ancient Greek, whereby a neuter plural is combined with a singular verb, is now demonstrated to be an archaic survival from the time when the neuter plural was a collective singular. Thus a word like the Latin *ingum* was a single yoke, the plural *inga*, however, which was earlier *ingā*, was a collection of yokes, with the same final *a* as is found generally in feminine substantives. The declension ought therefore to have been originally: nominative *ingā*, genitive *ingās*, &c., like *mensa*, &c., of the first declension. But as *ingum* was used in the neuter singular for both nominative and accusative, *ingā* when it was felt as the corresponding plural was used for the accusative as well as the nominative, while the other cases of the plural were taken over from the masculine *o*-stems, with which the singular neuter in *-o-m* was so closely connected. That collective words should be used for the plural is not surprising; the English *youth*, first an abstract, next a collective, and finally an individual, is a case in point.

For the early history of the syntax of the verb Greek and Sanskrit are important above all other languages, because in them the original forms and the original usages are better preserved than they are elsewhere. And it is in the verb that the great difficulties of comparative syntax present themselves. The noun system is so well preserved in several languages that, when

the number of the original cases had once been determined, the sifting of the pro-ethnic usages attaching to each case was tolerably easy, for besides Sanskrit and (to a less extent) Latin, Lithuanian and Slavonic have kept the pro-ethnic case system almost complete. The ideas also which had to be expressed by the cases were on the whole of a very concrete character, so that here the problem was much simplified. On the other hand, the ideas expressed by the forms of the verb are of a much more subtle nature, while the verb system in all languages except Greek and Sanskrit has broken down earlier and more completely than the noun. It is clear that the verb of the original Indo-European language possessed two voices, and forms corresponding to what we call the Indicative, Subjunctive, and Optative moods, and to the Present, Imperfect, Future, Aorist, and Perfect tenses. The imperative mood seems primitively to have been confined to the second person singular, just as the vocative, which, like the imperative is a stem form without suffix, was confined to the singular. The infinitive, as is well known, is in all languages of this system not originally a verbal but a substantival form. The pluperfect, where it has developed, seems to be a mixed form arising from the application of aorist endings to a perfect stem. Thus far the history of the verb system is tolerably clear. But when we attempt to define the original meaning of the moods and of the tenses we pass into a region where, in spite of assiduous investigation in many quarters during recent years, the scanty amount of light thrown on the problem has only served to make the darkness visible. As regards the tenses, at least, it has been shown that without doubt there is no difference in formation between present, future and aorist stems, while the earliest meaning of the perfect was that of a special kind of present expressing either repeated or intensive action or a state. It has also been proved that the original meaning of the aorist is not past in time, and that in fact the only element whereby these languages could express remoteness in time was the augment. The augment seems to have been originally a pronominal deictic particle. Thus, as there was no original pluperfect, as neither perfect nor aorist originally referred to past time, and as the future, except in Lithuanian (with slight traces in Slavonic) and the Indo-Iranian group, cannot be clearly distinguished from the aorist, the system as a method of expressing time absolutely breaks down. The tenses in fact did not originally express the times when the action took place, but the type of action which took place. Thus the present system in the main expressed continued or durative action, the aorist only the fact that the action had taken place. The action indicated by the aorist might have been of considerable duration, or it might have been begun and ended in a moment; its characteristics in this respect are not in any way indicated by the aorist form, which intimates only that the action is viewed as a completed whole and not as a continuous process. The present system, however, is built up in a great variety of ways (thirty-two according to Brugmann's enumeration). It is a priori unlikely that such a multiplicity of formations had not originally some reason for its existence, and Delbrück thinks that he has discovered a difference in syntactical value between various forms. The reduplicated present forms of the type seen in Sanskrit *ṅigāṁ*, Greek *βίβωμαι*, &c., he regards as expressing originally an action which consisted of repeated acts of the same nature (iterative), though this iterative meaning frequently passed into an intensive meaning. Presents of the type seen in Sanskrit *ṅṅyāṁ*, "is thirsty," and Greek *χαίρω*, "am glad" (for *χαίρω), where the *ṅ* (*y*) of the suffix has modified the first syllable and disappeared, he regards as *cursive*—i.e. they express continuous action without reference to its beginning or end. Verbs which have regard to the beginning or end of the action he calls terminative, and finds them represented (a) in verbs with *-m* suffixes, Sanskrit *ṅṅyāṁ*, *ḥṅyāṁ*, "sets in motion," *ḥṅyāṁ*, "break to pieces"; (b) in verbs with the suffix *-sko-*, Sanskrit *ḡchati*, "goes" (to a definite destination), Greek *βλάω*, &c. The roots he classifies as momentary (punktuell) or non-momentary, according as they do or do not express an action which is begun and ended at once.

¹ *Tschmer's Internationale Zeitschrift für Sprachwissenschaft*, iv. 100.

² B. I. Wheeler, *Journal of Germanic Philology*, ii. 528 sqq.

³ *Flexionsbildungen der indogermanischen Neutra* (1889).

This method of classification was no doubt suggested in the first instance by the characteristics of the Slavonic verb system. In this system a clear distinction is drawn in nearly all verbs between those which express a process (durative verbs) and those which express a completed action (perfective verbs). When perfective and durative verbs are formed from the same root, the perfective are distinguished from the durative forms (a) by having a preposition prefixed, or (b) by having a different stem formation. Thus in the Old Bulgarian (Old Ecclesiastical Slavonic) *to strike* (hit) and *to strike dead* are expressed by the same verb, but in the latter meaning a preposition is found which does not appear in the former, *biti* (infinitive), "to strike"; *u-biti*, "to strike dead." *To strike is durative; to strike dead is perfective.* As an example of difference of stem formation expressing this difference of meaning, we may quote *síti*, "to sit down" (perfective), *séditi*, "to sit" (durative). Verbs with a suffix in *-n* have often a perfective meaning: cf. the Sanskrit and Greek verbs quoted above. The perfective verbs correspond in meaning to the Greek aorist, and are to be carefully distinguished from perfect forms. The same distinction of meaning is often achieved in other languages also by means of prepositions, e.g. in Latin (Seneca, *Epp.* xliii. 20), *Quid autem ad rem pertinet, quamdiu vives, quod evitare non possis?* "What does it matter how long you go on avoiding [durative] what you cannot escape [perfective]." From this example, however, it is clear that, though the means employed to make the distinction are different, there is no difference in meaning between such perfective verbs and those classified by Delbrück as terminative. Here, as in many other parts of this study, the ideas are new, and grammatical terminology has not yet sufficiently crystallized, and still leaves something to be desired both in clearness and in precision.

As regards the moods, the difficulty has been to find any criterion whereby the functions of one mood should be differentiated from those of the others. It has long been recognized that the difference between indicative and subjunctive is one of meaning and not one of formation; that, e.g., in Sanskrit *bharati* (3rd sing. pres. indic.), "bears," is morphologically identical with *bharati*, "may slay" (3rd sing. pres. subj.), and that the latter is described as a subjunctive only because of the meaning, and because there exists a dissyllabic form, *hanati*, which makes the indicative "slays." Similarly in Greek it is impossible to distinguish morphologically between *raúwos*, "I shall check" (fut. indic.) and *raúwos*, "let me check" (3rd aor. subj.). Moreover, in the earliest forms of the languages which preserve the moods best (Greek and Sanskrit), the connexion syntactically between the indicative and the subjunctive forms is closest. Not only does the future express futurity, but also the determination of the subject to carry out the action expressed, which, in Delbrück's discussion of the moods, is precisely the point chosen as characteristic of the subjunctive. On the other hand, the present optative differs from the present (and future) indicative and present subjunctive in having a special mood suffix, and in having secondary while they have primary personal endings. Nevertheless its meaning overlaps that of the other forms, and some excellent authorities, like Professor W. W. Goodwin, see in future indicative, subjunctive and optative only different degrees of remoteness in the future, the remoteness being least in the future and greatest in the optative. Delbrück, however, abides, with slight modifications, by the distinction which he propounded in 1871 that the subjunctive expresses Will and the optative Wish. Here again the problem has not been solved, and it is doubtful how far any definite solution is likely to be arrived at, since there are so many gaps in our knowledge of mood forms. These gaps, owing to the break-up of the system at so early a period, it is hardly probable we shall ever be able to fill. It is possible, however, to do a great deal more than has yet been done even in the most familiar languages. In Latin, for instance, even now, the facts for the uses of the moods within the two centuries of the classical period are very imperfectly known, and it is no exaggeration to say that more has been done in the last hundred years for Sanskrit than has been done in two thousand years of continuous study for Latin or Greek.

A still later addition to the domain of Philology—the study of meaning—presents fewer difficulties, but until recent years has been equally neglected. The study is so recent that the literature of the subject is still extremely small. The only attempts to deal with it on a large scale are M. Bréal's *Essai de Sémiotique* (1897), now translated into English under the title of *Semantics* (1900), with a valuable introduction and appendix by Dr Postgate, and M. de la Grasserie's *Essai d'une Sémiotique intégrale* (1908), a work which deserves mention for its attempt to make a thorough classification and a corresponding terminology for semantic phenomena, but the value of which is much diminished by hasty compilation and imperfect knowledge of many of the languages quoted. From the practical point of view many of the phenomena have been classified in works on rhetoric under the headings of Metaphor, Synecdoche and Metonymy. The psychological principle behind this superficial classification is that of association of ideas. Here, as elsewhere, changes proceed not by accident, but according to definite principles. Here, as elsewhere in language, in history, and the other moral sciences, the particular principle in operation can be ascertained only by beginning with the result and working back to the cause. In the development of meaning much more than in phonetics is this necessarily the case. In phonetics all speakers of the same dialect start with approximately the same sound. But the same combination of sounds which we call a word does not recall the same idea to all persons who use that word. The idea that the phrase *railway station* calls up in the mind of a Londoner is very different from that which occurs to the mind of a child acquainted only with a wayside station serving the wants of a country village of a few hundred inhabitants. The word *herring* suggests one idea or train of ideas to the fisherman who catches the fish, another to the merchant who purchases it from the fisherman, a third to the domestic who cooks it, and so on. To members of the same family the same word may often have widely different associations, and, if so, the metaphors for which the word will be employed will differ in each case.

For the history of meaning it is necessary to have regard to all the forms of association of ideas which psychology recognizes. These are contiguity in place or in time, resemblance and contrast. Contrast, however, as J. S. Mill and Bain have shown, is not a simple form of association, but is evolved partly from contiguity, partly from resemblance. An artificial hollow generally implies also an artificial height made of the materials excavated from the hollow. Hence in most languages some words occur with the two contrasted meanings. Thus in English we find *dyke* in use both for a ditch and for a mound fronted by a ditch, the word *ditch* being, in fact, but a dialectal form of *dyke*. In Scotland, on the other hand, where earthen mounds and stone walls form more frequent boundaries between fields than in England, the word *dyke* is now practically limited to elevated boundaries, while *ditch* is limited to excavated boundaries. Thus the proverb, "February fill dykes," which in England implies that the February rains will fill the ditches, is often understood in Scotland to mean that in February the snow will be level with the tops of the stone or turf walls. Similarly in Latin Tacitus can say *fossas proruere*, which can only apply to levelling raised mounds; while in Greek Xenophon also talks of the ditch (trench) thrown up (*ράφος ἀναβλημένη*). It is only natural, therefore, that other words with several meanings should be used similarly: *moot*, originally a mound of earth or peat, has come to mean a big ditch; while, conversely, soldiers in trenches are not so much in ditches, as the word ought to signify, as behind breastworks. Sometimes, when two actions opposed to one another are contiguous, a word seems to change to the exact opposite of its original meaning. Thus the English verb *wean*, which meant originally to accustom (to cooked food), has been transferred to the necessary preliminary, to disaccustom to the breast.

Resemblances may be (i.) genuine, and (a) of external appearance, or (b) of other characteristics; or (ii.) fanciful or analogical. From resemblance in the external appearance of the object, the word *gem*, which in Latin (*gemma*) usually means a bud, has

come to mean first a pearl and then by extension of the meaning any precious stone. From the concentric coats which appear in both, the Latin word for a pearl (*unio*, acc. *unionem*) appears in English as *onion*. Examples where the characteristics are not of external appearance are such as the German *keiser* and the Russian *tsar*, which are descended from Julius Caesar, while the Lithuanian word for king—*karalins*—is *Cavalus*, i. e. Charlemagne. So in modern Persian, *Kasrov*, "Lord," comes from the Zend proper name Husravah (Chosroes). As already pointed out, the resemblances which have established a connexion between *part* and *impertinent* (properly irrelevant) are in sound only. The same is true of the supposed relation of the verb *cut* to *cullass*, *culler* and *cullet*. While *train oil* really means oil in drops like tears (cf. German *Thräne*), most people connect it with railway trains. The resemblance in some cases is merely in function. Thus, though the fir and the oak have no resemblance one to the other, the word *fir* is now generally identified with the Latin *quercus* in etymology (cf. *four* and *quattro*), in the same way as the Latin *Jugus*, "beech," is with the Greek *φύξος*, "oak," the users of the word having, in the course of their migrations, passed from a land with oaks to a land with firs in the one case, and from a land of beeches to a land of oaks in the other. Resemblance as the basis of metaphor has a very widely extended influence on language.

The most numerous and most varied forms of change in meaning depend, however, upon the law of contiguity. Perhaps the commonest of all forms of contiguity is that where the word indicating some accompanying feature or condition replaces the word for the object referred to. In the countries that border the Mediterranean the heat of midday is accompanied and intensified by the dying away of the wind, a characteristic remarked upon by Aeschylus (*Agam.* 565): "What time upon his noonday couch, windless and waveless sank the sea to rest." From the Greek word *σαύμα*, "burning heat," arises through Late Latin the English *calm*, where the absence of wind is the only idea present, that of heat having altogether disappeared. Again, in *bugle*, which is abbreviated for *buglehorn*, the word which survives properly means *wild ox*, and the originally more important element is lost. In a combination like *silver bugle* the word has gone a stage further; the original meaning of horn has also disappeared. There is no longer any thought of an animal's horn; the only idea that survives is that of a musical instrument. From the cope or cloak (*capella*) of St. Martin, which was preserved as a sacred relic by the Frankish kings, comes the word *chapel*. The word was first transferred from the cloak to the holy place wherein it was kept, and thence to similar shrines, and ultimately to any place, not being a church, where prayers were said. A *jig* was originally not the dance, but the fiddle which supplied the music for the dance. The names of liquors are often replaced by some accompanying as of the place, *port*, *sherry*, *champagne*, or by a qualifying adjective as in *brandy*, properly "burnt," from the Dutch *brandewijn*; or, again, only the less important element of the word is retained as in *whisky*, literally "water," for the older *uisquebaugh*, a corruption of Gaelic words meaning the "water of life" (*equa vitae*). Replacement of substantives by their accompanying adjectives is common in most languages. One of the most common methods of coining a name for a new article is to give it the name of the place or people whence it comes. Thus we have *arras*, lawn (from *laon*), *cravat* (Croat), coach from Kocs in Hungary, *bilboes* (both fetters and swords) from the iron mines of Bilbao in Spain. Equally common are the names of inventors—pinchbeck, tontine, silhouette, guillotine, derrick: In the word *cash*, which comes indirectly from Latin *capsa*, "a box," the thing contained has taken its name from the container. Similarly *mortar*, "cement," derives its name from the mortar in which it was mixed, while in *box* the material (boxwood, Lat. *buxus*, Greek, *βύξος*) has usurped the place of the article made. In *leper* the disease (Lat. *lepra*, the rough disease, from Greek, *λεπρά νόσος*) has been made into the name of the sufferer, who was earlier called a leprous man. As a consequence, a new substantive *leprosy* has to be taken from the adjective to

indicate the disease. The various changes in meaning, which are classed together as *synecdoche*, have their origin in contiguity. Thus we have the species for the genus; the butcher, who properly kills goats only (Old French *boe*), has ousted the fletcher. But we have also the genus for the species; corn, as a rule, means in England wheat; in Scotland oats; in America, maize. The individual becomes collective as in *corps*, navy, body (of men); the collective becomes individual when Latin *racemus*, "bunch of grapes," passes into English "raisin." Here would come the so-called meliorative and pejorative developments in word-meaning, whereby, e.g. *steward*, "the sty-ward," becomes the title of a great officer of the realm and the name of a line of kings; or, on the other side, *son* (Latin *solidus*) passes from the name of a gold coin to that of one of proverbially insignificant value. Here, too, would come many euphemistic uses which are, for the most part, applications of more general terms to avoid the mention of some specific act or object which is unpleasant; as death, murder, bankruptcy, debt, &c., while metaphorical terms for the same things come under resemblance. These examples do not exhaust the forms of contiguity which appear in language, but they are enough to show how far-reaching the effect of this type of association of ideas is upon language, and how extensive the field is which still calls for investigation before the study of meaning attains the same development as the investigation of the other branches of the history of language.

AUTHORITIES (since 1885).—For methods of Linguistic Study: Paul, *Principien der Sprachgeschichte* (3rd ed., 1898); Von der Gabelentz, *Die Sprachwissenschaft* (2nd ed., 1901); Stearns, Logeman & Wheeler, *The History of Language* (1894); an adaptation of the ideas of Paul's *Principien*, with many excellent examples; van Ginneken, *Principes de Linguistique psychologique* (1907). For the Controversy regarding Phonetic Laws: Curtius, *Zur Kritik der neuesten Sprachforschung*; Brugmann, *Zum heutigen Stand der Sprachwissenschaft*; Schuchardt, *Über die Lautgesetze: gegen die Junggrammatiker* (all in 1885); Tarbell, "Phonic Law," in *Transactions of American Philological Association* for 1886, pp. 1 sqq.; Wechseler, "Giebt es Lautgesetze?" (1900), Sonderabzug aus *Forschungen zur romanischen Philologie*; Festschrift für Hermann Suchier; Wundt, *Die Völkerpsychologie* (1900), vol. i.; Oertel, *Lectures on the Study of Language* (1901), lecture iv. For Analogy: Wheeler, "Analogy and the Scope of its Application in Language" (1887), *Cornell University Studies in Classical Philology*. For the Classification of Languages: Misteli, *Charakteristik der hauptsächlichsten Typen des Sprachbaues* (1893). For the Phonology, Morphology and Syntax of the Indo-European Languages: Brugmann and Delbrück, *Grundriss der vergleichenden Grammatik der indogermanischen Sprachen* (1886-1900); a new edition of the *Phonology* by Brugmann in 1897, of the *stem-formations and inflexion of Nouns, Adjectives, Pronouns and Numerals in two parts* (1906, 1909); the first edition of the *Phonology and Morphology*, translated into English in four volumes by Wright, Conway and Rouse. For Discussion of Connected Points: Bechtel, *Die Hauptprobleme der indogermanischen Lautlehre* (1892). For Syntax: Delbrück, in the works mentioned, in the text. For Semantics: besides Breal and Postgate, see Wandsch, *Die Völkerpsychologie*, vol. i. pt. 2, and articles by John Grote in the *Journal of Philology*, vols. iv. and v. A bibliography of the works which have appeared since 1890 will be found in the *Anzeiger für indogermanische Sprach- und Altertumskunde: Beiblatt zu den indogermanischen Forschungen redigiert*, by W. Streitberg. (P. Gl.; E. Sl.)

SUMMARY OF PHILOLOGICAL ARTICLES

In addition to the genetic classification of languages given above (on pp. 426-429), some further guidance as to the actual headings under which the philological section is arranged may be of service to the student.

The pivot of the whole section is the article ALPHABET, which traces the history of language and writing to the earliest stages, embodying the results of archaeological studies in all countries, together with the general conclusions based thereon. In this article (with further details under CRETE) will be found an account of the controversy regarding the Cretan discoveries of Dr A. J. Evans. Supplementary to this comparative survey are the articles PALAEOGRAPHY, INSCRIPTIONS, WRITING and PHONETICS. The first two deal with ancient documents of all kinds: PALAEOGRAPHY with those specimens of ancient writing, literary, economic or legal, which were committed to codices, tablets or rolls by the use of the stylus, the reed or the pen; INSCRIPTIONS with documents engraved on stone or metal.

WRITING deals, chiefly from the anthropological standpoint, with primitive attempts to record ideas in an intelligible form, e.g. with "knot-signs," "message-sticks," picture-writing and the like. PHONETICS covers the whole subject of speech sounds and pronunciation, the organs of speech and national sound systems.

Supplementary, from another point of view, to the article ALPHABET is a complete series of articles on the letters of the English alphabet. In these articles the history of the individual letters is traced from the Phœnician through Aramaic, Greek and Roman to modern times. All these articles may be read in connexion with a comparative table in the article ALPHABET (*ad fin.*), which shows in parallel columns the earliest equivalents of the modern English letters, i.e. Brahmi, Kharoṣṭhi, oldest Æthiopic, Sabæan, Nashki, Tema, Siadjiri, the Moabite stone, Phœnician, Greek, Latin, Cyrillic and Glagolitic. Another important comparative table of written signs is contained in the article SLAVS, showing the various Cyrillic, Glagolitic and Latin letters used by the Slav peoples.

Passing from articles dealing with the method and general subject-matter of philology, the student will find articles on the great families of languages, each with its subordinate articles on special languages and dialects.

1. *Indo-European Languages.*—Of articles on language-families, the most important is that under the heading INDO-EUROPEAN LANGUAGES. This great division, which is dealt with from the comparative standpoint in the second part of the article PHILOLOGY, is under its own heading treated in detail. The article begins with a sub-classification into two main groups—the so-called (A) *centum* and (B) *satem* groups—each of which is further divided into four sections. In accordance with this classification there are separate articles on the individual ancient and modern languages and dialects.

A. (1) GREEK LANGUAGE (supplemented by sections under HOMER, DORIANS, &c.); (2) LATIN LANGUAGE (with OSCA LINGUA, IGVVIUM, &c., and articles on the Italic tribes and places, e.g. VENETI, CARRI); (3) Celtic, s.v. CELT (with subsidiary articles); and (4) Teutonic, s.v. TEUTONIC LANGUAGES, SCANDINAVIAN LANGUAGES, and the like.

The modern descendants of these languages are all further treated separately. Thus following LATIN LANGUAGE is the article ROMANCE LANGUAGES, which traces the development of the Latin tongue during its gradual differentiation into Italian, French, Spanish, Rumanian, &c.; while a more detailed account of these will be found under ITALIAN LANGUAGE; FRENCH LANGUAGE; SPAIN: *Language*; RUMANIA: *Language*. There is also a special article PROVENÇAL LANGUAGE, dealing with the Romanic speech of southern France. The Teutonic languages are similarly dealt with in detail under ENGLISH LANGUAGE (including Anglo-Saxon); DUTCH LANGUAGE; GERMAN LANGUAGE. SCANDINAVIAN LANGUAGE itself includes Icelandic, Norwegian, Swedish, Danish.

B. In the *satem* group of the Indo-European family the four divisions are as follows:—

(1) Indo-Iranian or Aryan. This division may be subdivided into (a) Indo-Iranian, treated mainly in the article PERSIA: *Language and Literature* (including Zend, Old, Middle and New Persian, and the modern dialects), and (b) Indian. The Indian languages are discussed primarily under INDO-ARYAN LANGUAGES, which describes the relations of *Pisaca*, *Sanskrit*, *Prakrit*, and gives a paradigm of the various languages of the three great divisions of India. This central article refers to the separate articles *PISACA*, *SANSKRIT* and *PRAKRIT*, which in turn are supplemented by a number of articles on particular languages. Of these reference may be made to BENGALI; BIHARI; GUJARATI AND RAJASTHANI; HINDOSTANI; KASHMIRI; MARATHI; PALI. The gipsy languages, which may probably be assigned to the Indo-Iranian division, are described under GIPSIES.

(2) The account of Armenian will be found under ARMENIAN LANGUAGE AND LITERATURE.

(3) The Balto-Slavonic Languages. Of these the three comprised in the Baltic group, viz. Lithuanian, Lettic and Old

Prussian, are described under the heading LITHUANIANS AND LETTS. For the Slavonic group, the chief article is SLAVS: *Language*, which deals with the elements common to all the Slavonic tongues, with their early history and differentiation. It contains a comparative table of alphabets. It is supplemented by an article OLD SLAVONIC, and by further information under the headings RUSSIA, BULGARIA, SERBIA, POLAND, BOHEMIA, CROATIA-SLAVONIA, SLOVAKS, SLOVENES, SORBS, KASHUBES, POLABS.

(4) The Albanian dialects are treated under ALBANIA.

2. *Semitic Languages.*—At the heading of this section stands the article SEMITIC LANGUAGES, supplemented by HEBREW LANGUAGE, ARAMAIC LANGUAGES, and linguistic sections under PHOENICIA, ETHIOPIA, and the like.

3. *Hamitic Languages.*—The central article in this family is HAMITIC LANGUAGES, which is supplemented, so far as the Cushitic or Ethiopian group is concerned, by further information in the articles EGYPT; ETHIOPIA; ABYSSINIA; SOMALILAND; and, so far as the Libyan group is concerned, by the articles BERBERES and KABYLES.

4. The chief feature of the *Monosyllabic* family is the section *Language* under CHINA, supplemented again by similar sections in articles on other countries of south-eastern Asia, and by the article TIBETO-BURMAN LANGUAGES. There is also a language section under JAPAN which discusses the affinities between Chinese, Korean and Japanese.

5. The *Ural-Altaic* family is described in outline in the article URAL-ALTAIC, which gives the general relationships of Turkish, Finno-Ugric, Mongol and Manchu, and of minor subdivisions such as Syryenian, Mordvinian and Votyak. Turkish is discussed in the article TURKS: *Language*, which deals with Osmanli proper and the Tatar-Turkish languages generally. The article FINNO-UGRIC is a comparative survey dealing with the language of the Finns, Lapps, Samoyedes, &c.; while Magyar is treated separately in HUNGARY: *Language*. Under MONGOLS there is a special section *Language*, discussing the three groups of East Mongol, West Mongol (including Kalmuck) and Buriat.

6. The principal languages of southern India, e.g. Tamil, Malayalam, Kanarese, Telugu, &c., are dealt with generally under the heading DRAVIDIAN; while there is a separate article TAMILS, containing a section on their language; and brief notes under the headings BRAHUI, TELUGU, MALAYALAM, &c.

7 and 8. The scattered languages of the Malay-Polynesian family and other Oceanic peoples are treated principally in the article MALAYS, where further information is given under the headings POLYNEZIA; SAMOA; JAVA; NEGRIOS, BAITAS, &c.

9. The Caucasian family is described chiefly in the article GEORGIA: *Ethnology*. Further information will be found in CAUCASIA: *Ethnology*.

10. Of the remaining European languages only two need special mention: Basque, which is treated in a special section under the heading BASQUES; and the lost Etruscan, which is treated under ETRURIA and LATIN LANGUAGE.

11. The principal languages of southern and central Africa are treated fully under BANTU LANGUAGES. There is a brief account of the Bushman language under BUSHMEN, and of the Hottentot languages under HOTTENTOTS.

12. *Intermediate African Languages.*—Among the numerous languages spoken by the people of the great central belt of the African continent, the most important is the Hausa, described under that heading.

13. *America.*—The whole question of the languages of the North American Indians is dealt with in the article INDIANS, NORTH AMERICAN, which contains an elaborate linguistic paradigm.

Bibliographical information will be found in practically all the above headings. In addition to the most modern authorities there quoted, there will be found in the article DICTIONARY a very full list of older lexicographical works.

The above summary does not purport to present dogmatically a rigid philological classification. It disregards many problems, and is intended solely to enable the student readily to find the material of which he may be in search.

PHILOMEL (Fr. *Philomèle*; Ger. *Philomela* or *Stahlgeige*), a musical instrument similar to the violin, but having four steel, wire strings. The philomel has a body with incurvations similar to those of the guitar; therefore, without corner blocks, the outline of the upper lobe forms a wavy shoulder reminiscent of the viols but more ornate and fanciful. The peg-box sometimes terminates in a fancy head instead of a scroll. The philomel, never used in the orchestra, is the instrument of the dilettanti, frequently played in Germany with the bowed sither. The accordance of the philomel is the same as for the violin; the timbre is shrill and crystal-like. There is also an alto philomel corresponding to the viola. The bowed melodian is similar to the philomel, and has four steel strings of the same accordance as the violin, but arranged in inverse order; instead of being held like the violin and philomel, under the chin, it is placed on the knees of the performer, so that a hook under the finger-board rests against the table. (K. S.)

PHILON, Athenian architect of the 4th century B.C., is known as the planner of two important works—the portico of the great Hall of the Mysteries at Eleusis and an arsenal at Athens. Of the last we have exact knowledge from an inscription. E. A. Gardner (*Ancient Athens*, p. 557) observes that it "is perhaps known to us more in detail than any other lost monument of antiquity." It was to hold the rigging of the galleys; and was so contrived that all its contents were visible from a central hall, and so liable to the inspection of the Athenian democracy. (See **ATHENS**.)

PHILOPATRIS, the title of a dialogue formerly attributed to Lucian, but now generally admitted to be spurious. Its date and purport have long formed the subject of discussion. The scene is laid at Constantinople. A certain Triephon, who has been converted to Christianity by a bald, long-nosed Galilean, who was carried up through the air into the third heaven (an evident allusion to St Paul), meets a friend, Critias, who is in a state of great excitement. Triephon inquires the reason, and the invocation of Zeus by Critias leads to a discussion on paganism and Christianity, in which all the gods proposed by Critias are rejected by Triephon, who finally suggests that Critias should swear by the Trinity. (The sub-title, *ἡ δοκίμιος*, refers to this "instruction" of Critias in matters relating to Christianity.) Critias goes on to relate how he had been introduced to a gathering of pessimists, who predicted all kinds of disturbances in the empire and defeat at the hands of its enemies. In the meantime a third person appears on the scene, with the news that the imperial armies have obtained a glorious victory. The hope is expressed that Babel (Bagdad, the chief city of the caliphs) may soon be destroyed, Egypt subdued (that is, reconquered from the Arabs), and the attacks of the Scythians (Russians or Bulgarians) repulsed. The whole concludes with thanks to the unknown god of Athens that they have been permitted to be the subjects of such an emperor and the inhabitants of such an empire. The *Philopatris* was for a long time regarded as an attack upon Christianity, and assigned to the time of Julian the Apostate (emperor 361-363). Chronological indications (e.g. the allusion to a massacre of women in Crete) led Niebuhr to ascribe it to the reign of Nicephorus Phocas (963-969), and this view is now generally supported. There being at that time no pagans in Constantinople, the "pessimists" referred to must be Christians—either monks, especially the intimate friends of the patriarch of Constantinople, who, aggrieved at the measures taken by Phocas in regard to the property of the Church, were ready to welcome the defeat of the imperial arms and the ruin of the empire; or harmless visionaries, who claimed to predict the future by fasting, prayer and vigil. In any case, the author, whether he was a sophist commissioned by Phocas to attack the monks, or some professor who hoped to profit by singing the imperial praises, represents the views of the "patriotic" (as the title shows) as opposed to the "unpatriotic" party. According to another view, which assigns the dialogue to the time of Heraclius (610-641), the author was a Christian fanatic, whose object was to make known the existence of a conventicle of belated pagans, the enemies

of the Christian faith and the empire; it is doubtful, however, whether such a pagan community, sufficiently numerous to be of importance, actually existed at that date. The object of the first and longer portion of the dialogue was to combat the humanism of the period, which threatened a revival of polytheism as a rival of Christianity.

BIBLIOGRAPHY.—Editions by J. M. Gesner (1715) and C. B. Hase in the *Bonn Corpus scriptorum hist. byz.* (1828) vol. xi.; also included in Jacobita's edition of Lucian (1839). See R. Crampé, *Philopatris. Ein heidnisches Kommenikel des siebenten Jahrhunderts zu Constantinopel* (1894); R. Garnett, "Alms for Oblivion" in *Cornhill Magazine* (May, 1901); C. Stach, *De Philopatride* (Cracow, 1894), who shows its late origin by linguistic tests; S. Reinach in *Revue archéologique* (1902), vol. i.; B. G. Niebuhr, "Ueber das Alter des Dialogs *Philopatris*" in his *Kleine historische Schriften* (1843), vol. ii. and, for further authorities, article by Von Dobschütz in Herzog-Hauck's *Realencyclopädie für protestantische Theologie* (1904).

PHILOPOEMEN (253-184 B.C.), Greek general, was born at Megalopolis, and educated by the academic philosophers Ecdemus and Demophanes or Megalophanes, who had distinguished themselves as champions of freedom. Avoiding the fashionable and luxurious gymnasia, he devoted himself to military studies, hunting and border forays. In 233-2 Philopoemen skillfully evacuated Megalopolis before the attack of Cleomenes III., and distinguished himself at Sellasia (222). The next eleven years he spent as a condottiere in Crete. Elected commander of the League's cavalry on his return, he reorganized that force and defeated the Aetolians on the Elean frontier (216). Appointed to the chief command two years later, he introduced heavy armour and close formation for the infantry, and with a well-trained army beat Machanidas of Sparta, near Mantinea. The new "liberator" was now so famous that Philip V. of Macedon attempted to poison him. In 202-1 Philopoemen drove Nabis, the Spartan tyrant, from Messene and routed him off Tegea. After another long sojourn in Crete he again received the command against Nabis. Though unsuccessful at sea, he almost annihilated Nabis's land force near Gythium, but was prevented by the Roman Flaminius from taking Sparta. In 190 Philopoemen protected Sparta, which meanwhile had joined the League and thereupon seceded, but punished a renewed defection so cruelly as to draw the censure of Rome upon his country. At Messene he likewise checked a revolt (186), but when that city again rebelled, in 184, he was captured in a skirmish and promptly executed. His body was recovered by the Achaeans and buried with great solemnity.

Philopoemen's great merit lies in his having restored to his compatriots that military efficiency without which the Achaean League for all its skilful diplomacy could never stand. Towards Rome he advocated a courteous but independent attitude. In politics he was a democrat, and introduced reforms of a popular character (see **ACHAEAN LEAGUE**).

Polybius' *Histories* (x.-xxiii.) are our chief authority. These and a special treatise on Philopoemen (now lost) were used by Plutarch (*Philopoemen*), Pausanias (viii. 49-51), Livy (xxxii.-xxxviii.), and indirectly by Justin (xxx.-xxxiv.).

PHILOPONUS, JOANNES (JOHN THE GRAMMARIAN), Greek philosopher of Alexandria, lived in the later part of the 5th and the beginning of the 6th century of our era. The surname *Grammaticus* he assumed in virtue of his lectures on language and literature; that of *Philoponus* owing to the large number of treatises he composed. He was a pupil of Ammonius Hermiae, and is supposed to have written the life of Aristotle sometimes attributed to his master. To Philoponus are attributed a large number of works on theology and philosophy. It is said that, though he was a pupil of Ammonius, he was at first a Christian, and he has been credited with the authorship of a commentary on the Mosaic Cosmogony in eight books, dedicated to Sergius, patriarch of Constantinople, and edited by Balthasar Corderius in 1630. Other authorities maintain that this, as well as the *Disputatio de paschale*, was the work of another author, John the Tritheist. It was perhaps this Philoponus who tried to save the Alexandrian library from the caliph Omar after Amu's victory in 639.

The more certain writings of Philoponus consist of commentaries on Aristotle. These include works on the *Physica*, the *Prior* and the *Posterior Analytics*, the *Meteorologica*, the *De anima*, the *De generatione animalium*, the *De generatione et interitu* and the *Metaphysica*. These have been frequently edited and are interesting in connexion with the adoption of Aristotelianism by the Christian Church. They seem to have embodied the lectures of Ammonius with additions by Philoponus, and are remarkable rather for elaborate care than for originality and insight. He wrote also an attack on Proclus (*De aternitate mundi*). Two treatises on mathematics are ascribed to him: *A Commentary on the Mathematics of Nicomachus*, edited by Hoche (1864 and 1867), and a *Treatise on the Use of the Astrolabe*, published by Hase. The latter is the most ancient work on this instrument, and its authenticity is rendered almost certain by its reference to Ammonius as the master of the author.

PHILOSOPHY (Gr. *φίλος*, fond of, and *σοφία*, wisdom), a general term whose meaning and scope have varied very considerably according to the usage of different authors and different ages. It can best be explained by a survey of the steps by which philosophy differentiated itself, in the history of Greek thought, from the idea of knowledge and culture in general. These steps may be traced in the gradual specification of the term. The tradition which assigns the first employment of the Greek word *φιλοσοφία* to Pythagoras has hardly any claim to be regarded as authentic; and the somewhat self-conscious modesty to which Diogenes Laërtius attributes the choice of the designation is, in all probability, a piece of etymology crystallized into narrative. It is true that, as a matter of fact, the earliest uses of the word (the verb *φιλοσοφείν* occurs in Herodotus and Thucydides) imply the idea of the *pursuit* of knowledge; but the distinction between the *σοφός*, or wise man, and the *φιλόσοφος*, or lover of wisdom, appears first in the Platonic writings, and lends itself naturally to the so-called Socratic irony. The same thought is to be found in Xenophon, and is doubtless to be attributed to the historical Socrates. But the word soon lost this special implication. What is of real interest to us is to trace the progress from the idea of the philosopher as occupied with any and every department of knowledge to that which assigns him a special kind of knowledge as his province.

A specific sense of the word first meets us in Plato, who defines the philosopher as one who apprehends the essence or reality of things in opposition to the man who dwells in appearances and the shows of sense. The philosophers, he says, "are those who are able to grasp the eternal and immutable"; they are "those who set their affections on that which in each case really exists" (*Rep.* 480). In Plato, however, this distinction is applied chiefly in an ethical and religious direction; and, while it defines philosophy, so far correctly, as the endeavour to express what things are in their ultimate constitution, it is not yet accompanied by a sufficient differentiation of the subsidiary inquiries by which this ultimate question may be approached. Logic, ethics and physics, psychology, theory of knowledge and metaphysics are all fused together by Plato in a semi-religious synthesis. It is not till we come to Aristotle—the encyclopaedist of the ancient world—that we find a demarcation of the different philosophic disciplines corresponding, in the main, to that still current. The earliest philosophers, or "physiologists," had occupied themselves chiefly with what we may call cosmology; the one question which covers everything for them is that of the underlying substance of the world around them, and they essay to answer this question, so to speak, by simple inspection. In Socrates and Plato, on the other hand, the start is made from a consideration of man's moral and intellectual activity; but knowledge and action are confused with one another, as in the Socratic doctrine that virtue is knowledge. To this correspond the Platonic confusion of logic and ethics and the attempt to substitute a theory of concepts for a metaphysic of reality. Aristotle's methodic intellect led him to separate the different aspects of reality here confounded. He became the founder of logic, psychology, ethics and aesthetics as separate sciences; while he prefixed to all such (comparatively) special inquiries the investigation of the ultimate nature of existence as such, or of those first principles which are common to, and presupposed in, every narrower field of knowledge. For this investigation

Aristotle's most usual name is "first philosophy" or, as a modern might say, "first principles"; but there has since been appropriated to it, apparently by accident, the title "metaphysics." "Philosophy," as a term of general application, was not, indeed restricted by Aristotle or his successors to the disciplines just enumerated. Aristotle himself includes under the title, besides mathematics, all his physical inquiries. It was only in the Alexandrian period, as Zeller points out, that the special sciences attained to independent cultivation. Nevertheless, as the mass of knowledge accumulated it naturally came about that the name "philosophy" ceased to be applied to inquiries concerned with the particulars as such. The details of physics, for example, were abandoned to the scientific specialist, and philosophy restricted itself in this department to the question of the relation of the physical universe to the ultimate ground or author of things. This inquiry which was long called "rational cosmology," may be said to form part of the general subject of metaphysics, or at all events a pendant to it. By the gradual sifting out of the special sciences philosophy thus came to embrace primarily the inquiries grouped as "metaphysics" or "first philosophy." These would embrace, according to the Wolfian scheme long current in philosophical textbooks, ontology proper, or the science of being as such, with its three-branch sciences of (rational) psychology, cosmology and (rational or natural) theology, dealing with the three chief forms of being—the soul, the world and God. Subsidiary to metaphysics, as the central inquiry, stand the sciences of logic and ethics, to which may be added aesthetics, constituting three normative sciences—sciences, that is, which do not, primarily, describe facts, but rather prescribe ends or set forth ideals. It is evident, however, that if logic deals with conceptions which may be considered constitutive of knowledge as such, and if ethics deals with the harmonious realization of human life, which is the highest known form of existence, both sciences must have a great deal of weight in the settling of the general question of metaphysics.

In sum, then, we may say that "philosophy" has come to be understood at least in modern times as a general term covering the various disciplines just enumerated. It has frequently tended, however, and still tends, to be used as specially convertible with the narrower term "metaphysics." This is not unnatural, seeing that it is only so far as they bear on the one central question of the nature of existence that philosophy spreads its mantle over psychology, logic or ethics. The particular organic conditions of perception and the associative laws to which the mind, as a part of nature, is subjected, are facts in themselves indifferent to the philosopher; and therefore the development of psychology into an independent science, which took place during the latter half of the 19th century and may now be said to be complete, represents an entirely natural evolution. Similarly, logic, so far as it is an art of thought or a doctrine of fallacies, and ethics, so far as it is occupied with a natural history of impulses and moral sentiments, do neither of them belong, except by courtesy, to the philosophic province. But, although this is so, it is perhaps hardly desirable to deprive ourselves of the use of two terms instead of one. It will not be easy to infuse into so abstract and bloodless a term as "metaphysics" the fuller life (and especially the inclusion of ethical considerations) suggested by the more concrete term "philosophy."

We shall first of all, then, attempt to differentiate philosophy from the special sciences, and afterwards proceed to take up one by one what have been called the philosophical sciences, with the view of showing how far the usual subject-matter of each is really philosophical in its bearing, and how far it belongs rather to the domain of "science" strictly so called. The order in which, for clearness of exposition, it will be most convenient to consider these disciplines will be psychology, epistemology or theory of knowledge, and metaphysics, then logic, aesthetics and ethics. Finally, the connexion of the last-mentioned with politics (or, to speak more modernly, with jurisprudence and sociology), with the philosophy of history and the philosophy of religion, will call for a few words on the relation of these sciences to general philosophy.

Philosophy and Natural Science.—In distinguishing philosophy from the sciences, it may not be amiss at the outset to guard against the possible misunderstanding that philosophy is concerned with a subject-matter different from, and in some obscure way transcending, the subject-matter of the sciences. Now that psychology, or the observational and experimental study of mind, may be said to have been definitively included among the positive sciences, there is not even the apparent ground which once existed for such an idea. Philosophy, even under its most discredited name of metaphysics, has no other subject-matter than the nature of the real world, as that world lies around us in everyday life, and lies open to observers on every side. But if this is so, it may be asked what function can remain for philosophy when every portion of the field is already lotted out and enclosed by specialists? Philosophy claims to be the science of the whole; but, if we get the knowledge of the parts from the different sciences, what is there left for philosophy to tell us? To this it is sufficient to answer generally that the synthesis of the parts is something more than that detailed knowledge of the parts in separation which is gained by the man of science. It is with the ultimate synthesis that philosophy concerns itself; it has to show that the subject-matter which we are all dealing with in detail really is a whole, consisting of articulated members. Evidently, therefore, the relation existing between philosophy and the sciences will be, to some extent, one of reciprocal influence. The sciences may be said to furnish philosophy with its matter, but philosophical criticism reacts upon the matter thus furnished, and transforms it. Such transformation is inevitable, for the parts only exist and can only be fully, *i.e.* truly, known in their relation to the whole. A pure specialist, if such a being were possible, would be merely an instrument whose results had to be co-ordinated and used by others. Now, though a pure specialist may be an abstraction of the mind, the tendency of specialists in any department naturally is to lose sight of the whole in attention to the particular categories or modes of nature's working which happen to be exemplified, and fruitfully applied, in their own sphere of investigation; and in proportion as this is the case it becomes necessary for their theories to be co-ordinated with the results of other inquirers, and set, as it were, in the light of the whole. This task of co-ordination, in the broadest sense, is undertaken by philosophy; for the philosopher is essentially what Plato, in a happy moment, styled him, *επισκοπος*, the man who takes a "synoptic" or comprehensive view of the universe as a whole. The aim of philosophy (whether fully attainable or not) is to exhibit the universe as a rational system in the harmony of all its parts; and accordingly the philosopher refuses to consider the parts out of their relation to the whole whose parts they are. Philosophy corrects in this way the abstractions which are inevitably made by the scientific specialist, and may claim, therefore, to be the only "concrete" science, that is to say, the only science which takes account of all the elements in the problem, and the only science whose results can claim to be true in more than a provisional sense.

For it is evident from what has been said that the way in which we commonly speak of "facts" is calculated to convey a false impression. The world is not a collection of individual facts existing side by side and capable of being known separately. A fact is nothing except in its relations to other facts; and as these relations are multiplied in the progress of knowledge the nature of the so-called fact is indefinitely modified. Moreover, every statement of fact involves certain general notions and theories, so that the "facts" of the separate sciences cannot be stated except in terms of the conceptions or hypotheses which are assumed by the particular science. Thus mathematics assumes space as an existent infinite, without investigating in what sense the existence or the infinity of this *Ueding*, as Kant called it, can be asserted. In the same way, physics may be said to assume the notion of material atoms and forces. These and similar assumptions are ultimate presuppositions or working hypotheses for the sciences themselves. But it is the office of philosophy, as a theory of knowledge, to submit such conceptions

to a critical analysis, with a view to discover how far they can be thought out, or how far, when this is done, they refute themselves, and call for a different form of statement, if they are to be taken as a statement of the ultimate nature of the real.¹ The first statement may frequently turn out to have been merely provisionally or relatively true; it is then superseded by, or rather inevitably merges itself in, a less abstract account. In this the same "facts" appear differently, because no longer separated from other aspects that belong to the full reality of the known world. There is no such thing, we have said, as an individual fact; and the nature of any fact is not fully known unless we know it in all its relations to the system of the universe, or, in Spinoza's phrase, *sub specie aeternitatis*. In strictness, there is but one *res completa* or concrete fact, and it is the business of philosophy, as science of the whole, to expound the chief relations that constitute its complex nature.

The last abstraction which it becomes the duty of philosophy to remove is the abstraction from the knowing subject which is made by all the sciences, including, as we shall see, the science of psychology. The sciences, one and all, deal with a world of objects, but the ultimate fact as we know it is the existence of an object for a subject. Subject-object, knowledge, or, more widely, self-consciousness with its implicates—this unity in duality is the ultimate aspect which reality presents. It has generally been considered, therefore, as constituting in a special sense the problem of philosophy. Philosophy may be said to be the explication of what is involved in this relation, or, in Kantian phraseology, a theory of its possibility. Any would-be theory of the universe which makes its central fact impossible stands self-condemned. On the other hand, a sufficient analysis here may be expected to yield us a statement of the reality of things *in its last terms*, and thus to shed a light backwards upon the true nature of our subordinate conceptions.

Psychology, Epistemology and Metaphysics.—This leads to the consideration of the main divisions of philosophy—*PSYCHOLOGY* (*q.v.*), *EPISTEMOLOGY* (theory of knowledge; *Erkenntnistheorie*), and *METAPHYSICS* (ontology; see *METAPHYSIC*). A special relation has always existed between psychology and systematic philosophy, but the closeness of the connexion has been characteristic of modern and more particularly of English thought. The connexion is not difficult to explain, seeing that in psychology, or the science of mind, we study the fact of intelligence (and moral action), and have, so far, in our hands the fact to which all other facts are relative. From this point of view we may even see a truth in Jacobi's dictum as quoted by Sir W. Hamilton: "Nature conceals God, man reveals God." Nature by itself, that is to say, is insufficient. The ultimate explanation of things cannot be given by any theory which excludes from its survey the intelligence in which nature, as it were, gathers herself up. But knowledge, or the mind as knowing, willing, &c., may be looked at in two different ways. It may be regarded simply as a fact; in which case the evolutions of mind may be traced and reduced to laws in the same way as the phenomena treated by the other sciences. This study gives us the science of empirical psychology, or, as it is now termed, psychology *sans phrase*. In order to give an adequate account of its subject-matter, psychology may require higher or more complex categories than are employed in the other sciences, just as biology, for example, cannot work with mechanical categories alone, but introduces the conception of development or growth. But the affinities of such a study are manifestly with the sciences as such rather than with philosophy; and the definitive establishment of psychology as an independent science has already been alluded to. Since it has been taken up by specialists, psychology is being established on a broader basis of induction, and with the advantage, in some departments, of the employment of experimental methods of measurement. But it is not of mind in this aspect

¹ The revisional office which philosophy here assumes constitutes her the critic of the sciences. It is in this connexion that the meaning of the definition of philosophy as "the science of principles" can best be seen. This is perhaps the most usual definition, and though vague, one of the least misleading.

that such assertions can be made as those quoted above. Mind, as studied by the psychologist—mind as a mere fact or phenomenon—grounds no inference to anything beyond itself. The distinction between mind viewed as a succession of "states of consciousness" and the further aspect of mind which philosophy considers was very clearly put by Croom Robertson, who also made a happy suggestion of two terms to designate the double point of view:

"We may view knowledge as mere subjective function, but it has its full meaning only as it is taken to represent what we may call objective fact, or is such as is named (in different circumstances) real, valid, true. As mere subjective function, which it is to the psychologist, it is best spoken of by an unambiguous name, and for this there seems none better than Intellection. We may then say that psychology is occupied with the natural function of *Intellection*, seeking to discover its laws and distinguishing its various modes (perception, representative imagination, conception, &c.) according to the various circumstances in which the laws are found at work. Philosophy, on the other hand, is theory of *Knowledge* (as that which is known)."¹ "Psychology and Philosophy," *Mind* (1883), pp. 15, 16.

The confusion of these two points of view has led, and still leads, to serious philosophical misconception. It is hardly an exaggeration to say that, in the English school since Hume, psychology superseded properly philosophical inquiry. And we find even a thinker with a wider horizon like Sir W. Hamilton encouraging the confusion by speaking of "psychology or metaphysics,"¹ while his lectures on metaphysics are mainly taken up with what belongs in the strictest sense to psychology proper, with an occasional excursus (as in the theory of perception) into epistemology. The distinction between psychology and theory of knowledge was first clearly made by Kant, who repeatedly insisted that the *Critique of Pure Reason* was not to be taken as a psychological inquiry. He defined his problem as the *quid juris* or the question of the validity of knowledge, not its *quid facti* or the laws of the empirical genesis and evolution of intellection (to use Croom Robertson's phraseology). Since Kant philosophy has chiefly taken the form of theory of knowledge or of a criticism of experience. Not, indeed, a preliminary criticism of our faculties or conceptions such as Kant himself proposed to institute, in order to determine the limits of their application; such a criticism *ab extra* of the nature of our experience is essentially a thing impossible. The only criticism which can be applied in such a case is the immanent criticism which the conceptions or categories exercise upon one another. The organized criticism of these conceptions is really nothing more than the full explanation of what they mean and of what experience in its full nature or notion is. This constitutes the theory of knowledge in the only tenable sense of the term, and it lays down, in Kantian language, the conditions of the possibility of experience. These conditions are the conditions of knowledge as such, or as it may be put, of objective consciousness—of a self-consciousness of a world of objects and through them conscious of itself. The inquiry is, therefore, logical or transcendental in its nature, and does not entangle us in any decision as to the conditions of the genesis of such consciousness in the individual. When we inquire into subjective conditions we are thinking of facts causing other facts. But the logical or transcendental conditions are not causes or even factors of knowledge; they are the statement of its idea. Hence the dispute between evolutionist and transcendentalist rests, in general, on an *ignoratio elenchis*; for the history of the genesis of an idea (the historical or genetic method) does not contain an answer to—though it may throw light on—the philosophical question of its truth or validity. Speaking of this transcendental consciousness, Kant goes so far as to say that it is not of the slightest consequence "whether the idea of it be clear or obscure (in empirical consciousness), no, not even whether it really exists or not. But the possibility of the logical form of all knowledge rests on its relation to this apperception as a faculty or potentiality" (*Werke*, ed. Hartenstein, iii. 578 note). Or, if

¹ It is true that he afterwards modifies this misleading identification by introducing the distinction between empirical psychology or the phenomenology of mind and inferential psychology or ontology, *i.e.* metaphysics proper. But he continues to use the terms "philosophy," "metaphysics," and "mental science" as synonymous.

we return to the distinction between epistemology and psychology, by way of illustrating the nature of the former, we may take the following summing up by Professor James Ward in a valuable article on "Psychological Principles" in *Mind* (April 1883, pp. 166, 167): "Comparing psychology and epistemology, then, we may say that the former is essentially genetic in its method, and might, if we had the power to revise our existing terminology, be called biology; the latter, on the other hand, is essentially devoid of everything historical, and treats, *sub specie aeternitatis*, as Spinoza might have said, of human knowledge, conceived as the possession of mind in general."

Kant's problem is not, in its wording, very different from that which Locke set before him when he resolved to "inquire into the original, certainty and extent of human knowledge together with the grounds and degrees of belief, opinion and assent." Locke's *Essay* is undoubtedly, in its intention, a contribution to the theory of knowledge. But, because time had not yet made the matter clear, Locke suffered himself to digress in his second book into the psychological question of the origin of our ideas; and his theory of knowledge is ruined by the failure to distinguish between the epistemological sense of "idea" as significant content and the psychological sense in which it is applied to a fact or process in the individual mind. The same confusion runs through Berkeley's arguments and vitiates his conclusions as well as those of Hume. But appearing with these thinkers as the problem of perception, epistemology widens its scope and becomes, in Kant's hands, the question of the possibility of experience in general. With Hegel it passes into a completely articulated "logic," which apparently claims to be at the same time a metaphysics, or an ultimate expression of the nature of the real.

This introduces us to the second part of the question we are seeking to determine, namely the relation of epistemology to metaphysics. It is evident that philosophy as theory of knowledge must have for its complement philosophy as metaphysics (ontology) or theory of being. The question of the truth of our knowledge, and the question of the ultimate nature of what we know, are in reality two sides of the same inquiry; and therefore our epistemological results have to be ontologically expressed. But it is not every thinker that can see his way with Hegel to assert in set terms the identity of thought and being. Hence the theory of knowledge becomes with some a theory of human ignorance. This is the case with Herbert Spencer's doctrine of the Unknowable, which he advances as the result of epistemological considerations in the philosophical prolegomena to his system. Very similar positions were maintained by Kant and Comte; and, under the name of "agnosticism" (*g.s.*), the theory has popularised itself in the outer courts of philosophy, and on the shifting borderland of philosophy and literature. The truth is that the habit of thinking exclusively from the standpoint of the theory of knowledge tends to beget an undue subjectivity of temper. And the fact that it has become usual for men to think from this standpoint is very plainly seen in the almost universal description of philosophy as an analysis of "experience," instead of its more old-fashioned designation as an inquiry into "the nature of things." As it is matter of universal agreement that the problem of being must be attacked indirectly through the problem of knowledge, this substitution may be regarded as an advance, more especially as it implies that the fact of experience, or of self-conscious existence, is the chief fact to be dealt with. But if so, then self-consciousness must be treated as itself real, and as organically related to the rest of existence. If self-consciousness be treated in this objective fashion, then we pass naturally from epistemology to metaphysics or ontology. (Fox, although the term "ontology" has been as good as disused, it still remains true that the aim of philosophy must be to furnish us with an ontology or a coherent and adequate theory of the nature of reality.) But if, on the other hand, knowledge and reality be *ab initio* opposed to one another—if consciousness be set on one side as over against reality, and merely holding up a mirror to it—then it follows with equal naturalness that the truly real must be something which lurks unrevealed

behind the subject's representation of it. Hence come the different varieties of a so-called phenomenalism. The upholders of such a theory would, in general, deride the term "metaphysics" or "ontology"; but it is evident, none the less, that their position itself implies a certain theory of the universe and of our own place in it, and the establishment of this theory constitutes their metaphysics.

Without prejudice, then, to the claim of epistemology to constitute the central philosophic discipline, we may simply note its liability to be pressed too far. The exclusive pre-occupation of men's minds with the question of knowledge during the neo-Kantian revival in the 'seventies of the last century drew from Lotze the caustic criticism that "the continual sharpening of the knife becomes tiresome, if after all, we have nothing to cut with it." Stillingfleet's complaint against Locke was that he was "one of the gentlemen of this new way of reasoning that have almost discarded substance out of the reasonable part of the world." The same may be said with greater truth of the devotees of the theory of knowledge; they seem to have no need of so old-fashioned a commodity as reality. Yet, after all, Fichte's dictum holds good that knowledge as knowledge—i.e. so long as it is looked at as knowledge—is, *ipso facto*, not reality. The result of the foregoing, however, is to show that, as soon as epistemology draws its conclusion, it becomes metaphysics; the theory of knowledge passes into a theory of being. The ontological conclusion, moreover, is not to be regarded as something added by an external process; it is an immediate implication. The metaphysic is the epistemology from another point of view—regarded as completing itself, and explaining in the course of its exposition that relative or practical separation of the individual knower from the knowable world, which it is a sheer assumption to take as absolute. This, not the so-called assumption of the implicit unity of being and thought, is the really unwarrantable postulate; for it is an assumption which we are obliged to retract bit by bit, while the other offers the whole doctrine of knowledge as its voucher.

Logic, Aesthetics and Ethics.—If the theory of knowledge thus passes insensibly into metaphysics it becomes somewhat difficult to assign a distinct sphere to logic (*q.v.*). Ueberweg's definition of it as "the science of the regulative laws of thought" (or "the normative science of thought") comes near enough to the traditional sense to enable us to compare profitably the usual subject-matter of the science with the definition and end of philosophy. The introduction of the term "regulative" or "normative" is intended to differentiate the science from psychology as the science of mental processes or events. In this reference logic does not tell us how our intellections connect themselves as mental phenomena, but how we ought to connect our thoughts if they are to realize truth (either as consistency with what we thought before or as agreement with observed facts). Logic, therefore, agrees with epistemology (and differs from psychology) in treating thought not as mental fact but as knowledge, as idea, as having meaning in relation to an objective world. To this extent it must inevitably form a part of the theory of knowledge. But, if we desire to keep by older landmarks and maintain a distinction between the two disciplines, a ground for doing so may be found in the fact that all the main definitions of logic point to the investigation of the laws of thought in a subjective reference—with a view, that is, by an analysis of the operation, to ensure its more correct performance. According to the old phrase, logic is the art of correct thinking. Moreover we commonly find the logician assuming that the process of thought has advanced a certain length before his examination of it begins; he takes his material full-formed from perception, without, as a rule, inquiring into the nature of the conceptions which are involved in our perceptive experience. Occupying a position, therefore, within the wider sphere of the general theory of knowledge, ordinary logic consists in an analysis of the nature of general statement, and of the conditions under which we pass validly from one general statement to another. But the logic of the schools is eked out by contributions from a variety of sources (e.g. from grammar on one side and from psychology

on another), and cannot claim the unity of an independent science.

Aesthetics (*q.v.*) may be treated as a department of psychology or physiology, and in England this is the mode of treatment that has been most general. To what peculiar excitation of our bodily or mental organism, it is asked, are the emotions due which make us declare an object beautiful or sublime? And, the question being put in this form, the attempt has been made in some cases to explain away any peculiarity in the emotions by analysing them into simpler elements, such as primitive organic pleasures and prolonged associations of usefulness or fitness. But, just as psychology in general cannot do duty for a theory of knowledge, so it holds true of this particular application of psychology that a mere reference of these emotions to the mechanism and interactive play of our faculties cannot be regarded as an account of the nature of the beautiful. Perhaps by talking of "emotions" we tend to give an unduly subjective colour to the investigation; it would be better to speak of the *perception* of the beautiful. Pleasure in itself is unqualified, and affords no differentia. In the case of a beautiful object the resultant pleasure borrows its specific quality from the presence of determinations essentially objective in their nature, though not reducible to the categories of science. Unless, indeed, we conceive our faculties to be constructed on some arbitrary plan which puts them out of relation to the facts with which they have to deal, we have a *prima facie* right to treat beauty as an objective determination of things. The question of aesthetics would then be formulated—What is it in things that makes them beautiful, and what is the relation of this aspect of the universe to its ultimate nature, as that is expounded in metaphysics? The answer constitutes the substance of aesthetics, considered as a branch of philosophy. But it is not given simply in abstract terms: the philosophical treatment of aesthetics includes also an exposition of the concrete phases of art, as these have appeared in the history of the world, relating themselves to different phases of human culture.

Of ethics (*q.v.*) it may also be said that many of the topics commonly embraced under that title are not strictly philosophical in their nature. They are subjects for a scientific psychology employing the historical method with the conceptions of heredity and development, and calling to its aid, as such a psychology will do, the investigations of all the sociological sciences. To such a psychology must be relegated all questions as to the origin and development of moral ideas. Similarly, the question debated at such length by English moralists as to the nature of the moral faculty (moral sense, conscience, &c.) and the controversy concerning the freedom of the will belong entirely to psychology. If we exclude such questions in the interest of systematic correctness, and seek to determine for ethics a definite subject-matter, the science may be said to fall into two departments. The first of these deals with the notion of duty, and endeavours to define the good or the ultimate end of action; the second lays out the scheme of concrete duties which are deducible from, or which, at least, are covered by, this abstractly stated principle. The second of these departments is really the proper subject-matter of ethics considered as a separate science; but it is often conspicuous by its absence from ethical treatises. However moralists may differ on first principles, there seems to be remarkably little practical divergence when they come to lay down the particular laws of morality. It may be added that, where a systematic account of duties is actually given, the connexion of the particular duties with the universal formula is in general more formal than real. It is only under the head of casuistry (*q.v.*) that ethics has been much cultivated as a separate science. The first department of ethics, on the other hand, is the branch of the subject in virtue of which ethics forms part of philosophy. As described above, it ought rather to be called, in Kant's phrase, the metaphysic of ethics. A theory of obligation is ultimately found to be inseparable from a metaphysic of personality. The connexion of ethics with metaphysics will be patent as a matter of fact, if it be remembered how Plato's philosophy is summed up in the idea of the good, and how

Aristotle also employs the essentially ethical notion of end as the ultimate category by which the universe may be explained or reduced to unity. But the necessity of the connexion is also apparent, unless we are to suppose that, as regards the course of universal nature, man is altogether an *imperium in imperio*, or rather (to adopt the forcible phrase of Marcus Aurelius) an abscess or excrescence on the nature of things. If, on the contrary, we must hold that man is essentially related to what the same writer calls "a common nature," then it is a legitimate corollary that in man as intelligence we ought to find the key of the whole fabric. At all events, this method of approach must be truer than any which, by restricting itself to the external aspect of phenomena as presented in space, leaves no scope for inwardness and life and all that, in Lotze's language, gives "value" to the world. The argument *ex analogia hominis* has often been carried too far; but if a "chief end of man" be discoverable—*ἀπολόγουτον ἄγαθον*, as Aristotle wisely insisted that the ethical end must be determined—then it may be assumed that this end cannot be irrelevant to that ultimate "meaning" of the universe which, according to Lotze, is the quest of philosophy. If "the idea of humanity," as Kant called it, has ethical perfection at its core, then a universe which is really an organic whole must be ultimately representable as a moral order or a spiritual kingdom such as Leibnitz named, in words borrowed from St Augustine, a city of God.

Philosophy of the State (Political Philosophy), Philosophy of History, Philosophy of Religion.—In Plato and Aristotle ethics and politics are indissolubly connected. In other words, seeing that the highest human good is realizable only in a community, the theory of the state as the organ of morality, and itself in its structure and institutions the expression of ethical ideas or qualities, becomes an integral part of philosophy. The difficulty already hinted at, which individualistic systems of ethics experience in connecting particular duties with the abstract principle of duty is a proof of the failure of their method. For the content of morality we are necessarily referred, in great part, to the experience crystallized in laws and institutions and to the unwritten law of custom, honour and good breeding, which has become organic in the society of which we are members. Plato's *Republic* and Hegel's *Philosophie des Rechts* are the most typical examples of a fully developed philosophy of the state, but in the earlier modern period the prolonged discussion of natural rights and the social contract must be regarded as a contribution to such a theory. Moreover, if philosophy is to complete its constructive work, it must bring the course of human history within its survey, and exhibit the sequence of events as an evolution in which the purposive action of reason is traceable. This is the task of the philosophy of history, a peculiarly modern study, due to the growth of a humanistic and historical point of view. Lessing's conception of history as an "education of the human race" is a typical example of this interpretation of the facts, and was indeed the precursor which stimulated many more elaborate German theories. The philosophy of history differs, it will be observed, from the purely scientific or descriptive studies covered by the general title of sociology. Sociology conceives itself as a natural science elucidating a factual sequence. The philosophy of history is essentially teleological; that is to say, it seeks to interpret the process as the realization of an immanent end. It may be said, therefore, to involve a complete metaphysical theory. Social institutions and customs and the different forms of state-organization are judged according to the degree in which they promote the realization of the human ideal. History is thus represented by Hegel, for example, as the realization of the idea of freedom, or rather as the reconciliation of individual freedom and the play of cultured interests with the stable objectivity of law and an abiding consciousness of the greater whole in which we move. So far as the course of universal history can be truly represented as an approximation to this reconciliation by a widening and deepening of both the elements, we may claim to possess a philosophy of history. But although the possibility of such a philosophy seems implied in the postulated nationality of the universe,

many would hold that it remains as yet an unachieved ideal.

There only remains to be briefly noticed the relation of philosophy to theology and the nature of what is called Philosophy of Religion. By theology is commonly understood the systematic presentation of the teaching of some positive or historical religion as to the existence and attributes of a Supreme Being, including his relation to the world and especially to man. But these topics have also been treated by philosophers and religious thinkers, without dependence on any historical data or special divine revelation, under the title of Natural Theology. Natural Theology is specially associated with the Stoic theories of providence in ancient times and with elaborations of the argument from design in the 18th century. But there is no warrant for restricting the term to any special mode of approaching the problems indicated; and as these form the central subject of metaphysical inquiry, no valid distinction can be drawn between natural theology and general metaphysics. The philosophy of religion, on the other hand, investigates the nature of the religious consciousness and the value of its pronouncements on human life and man's relation to the ground of things. Unity, reconciliation, peace, joy, "the victory that overcometh the world"—such, in slightly varying phrases, is the content of religious faith. Does this consciousness represent an authentic insight into ultimate fact, or is it a pitiful illusion of the nerves, born of man's hopes and fears and of his fundamental ignorance? The philosophy of religion assumes the first alternative. The function of philosophy in general is the reflective analysis of experience, and the religious experience of mankind is *prima facie* entitled to the same consideration as any other form of conscious activity. The certainties of religious faith are matter of feeling or immediate assurance, and are expressed in the pictorial language of imagination. It becomes the function of philosophy, dealing with these utterances, to relate them to the results of other spheres of experience, and to determine their real meaning in the more exact terms of thought. The philosophy of religion also traces in the different historical forms of religious belief and practice the gradual evolution of what it takes to be the truth of the matter. Such an account may be distinguished from what is usually called the science of religion by the teleological or metaphysical presuppositions it involves. The science of religion gives a purely historical and comparative account of the various manifestations of the religious instinct without pronouncing on their relative truth or value and without, therefore, professing to apply the idea of evolution in the philosophical sense. That idea is fundamental in the philosophy of religion, which therefore can be written only from the standpoint of a constructive metaphysical theory.

It is, indeed, only from the standpoint of such a theory that the definitions and divisions of the different philosophical disciplines adopted in this article can be said to hold good. But those who, like the positivists, agnostics and sceptics, deny the possibility of metaphysics as a theory of the ultimate nature of things, are still obliged to retain philosophy as a theory of knowledge, in order to justify the asserted limitation or impotence of human reason.

BIBLIOGRAPHY.—The best general histories of philosophy are by J. E. Erdmann, Friedrich Ueberweg and W. Windelband. Windelband's being probably the freshest in its treatment and point of view. Ed. Zeller's *History of Greek Philosophy* still holds the field as the best continuous exposition of the subject, but more recent work in the early period is represented by H. Diels and J. Burnet, while Zeller's view of Plato may be said to have been superseded by the later researches of Lewis Campbell, H. Jackson and others. T. Gomperz's *Greek Thinkers* is an able, if somewhat diffuse, survey of the philosophical development in connexion with the general movement of Greek life and culture. It does not go beyond Plato. B. Hauréau, A. Stöckl and Karl Werner give the fullest and most trustworthy histories of the medieval period, but the subject is very carefully treated by Erdmann and Ueberweg, and a useful compendium, written from a Roman Catholic standpoint, is De Wulf's *History of Medieval Philosophy* (1900; Eng. trans., 1907). For modern times, in addition to the general histories already named, the works of Kuno Fischer, R. Falckenberg and H. Hoffding, and R. Adamson's *Lectures on the Development of Modern Philosophy*,

may be specially mentioned. Writes on the history of philosophy generally prefix to their work a discussion of the scope of philosophy, its divisions and its relations to other departments of knowledge, and the account given by Windeband and Ueberweg will be found especially good. The Introductions to Philosophy published by F. Paulsen, O. Külpe, W. Wundt and G. T. Ladd, deal largely with this subject, which is also treated by Henry Sidgwick in his *Philosophy, its Scope and Relations* (1902), by Ernest Naville, *La Définition de la philosophie* (1894) and by Wundt in the Introduction to his *System der Philosophie* (1889). A useful work of general reference is J. M. Baldwin's *Dictionary of Philosophy and Psychology* (3 vols., 1902-1905). (A. S. P.-P.)

PHILOSTRATUS, the name of several, three (or four), Greek sophists of the Roman imperial period—(1) Philostratus "the Athenian" (c. 170-245), (2) his nephew (?) Philostratus "of Lemnos" (born c. 190); (3) a grandson (?) of (2). Of these the most famous is Philostratus "the Athenian," author of the *Life of Apollonius Tyana*, which he dedicated to Julia Domna, wife of Alexander Severus and mother of Caracalla (see **APOLLONIUS OF TYANA**).¹ He wrote also *Bios Zoographos* (*Lives of the Sophists*), *Gymnasticus* and *Epistolae* (mainly of an erotic character). Very little is known of his career. Even his name is doubtful. The *Lives of the Sophists* gives the praenomen Flavius, which, however, is found elsewhere only in Tzetzes. Eunapius and Synesius call him a Lemnian; Photius a Tyrian; his letters refer to him as an Athenian. It is probable that he was born in Lemnos, studied and taught at Athens, and then settled in Rome (where he would naturally be called *atheniensis*) as a member of the learned circle with which Julia Domna surrounded herself. He was born probably in 175, and is said by Suidas to have been living in the reign of Philip (244-249). The fact that the author of *Apollonius* is also the author of the *Lives of the Sophists* is confirmed by internal evidence. The latter is dedicated to a consul Antonius Gordianus, perhaps one of the two Gordians who were killed in 238. The work is divided into two parts: the first dealing with the ancient Sophists, e.g. Gorgias, the second with the later school, e.g. Herodes Atticus.

The *Lives* are not in the true sense biographical, but rather picturesque impressions of leading representatives of an attitude of mind full of curiosity, alert and versatile, but lacking scientific method, preferring the external excellence of style and manner to the solid achievements of serious writing. The philosopher, as he says, investigates truth; the sophist embellishes it, and takes it for granted. The *Gymnasticus* contains interesting matter concerning the Olympic games and athletic contests generally. The *Letters* breathe the spirit of the New Comedy and the Alexandrian poets; portions of *Letter 33* are almost literally translated in Ben Jonson's *Song to Celia*, "Drink to me only with thine eyes." The *Heracles*, formerly attributed to Philostratus the Athenian, is probably the work of Philostratus the Lemnian. It is a popular disquisition on the heroes of the Trojan War in the form of a conversation between a Thracian vine-dresser on the shore of the Hellespont and a Phoenician merchant who derives his knowledge from the hero Proteus, Palamedes is exalted at the expense of Odysseus, and Homer's unfairness to him is attacked. It has been suggested that Philostratus is here describing a series of heroic paintings in the palace of Julia Domna. His other work is the *Eikones* (*Imagines*), ostensibly a description of 64 pictures in a Neapolitan gallery. Goethe, Welcker, Brunn, E. Bertrand and Hellbig, among others, have held that the descriptions are of actually existing works of art, while Heyne and Friedrichs deny this. In any case they are interesting as showing the way in which ancient artists treated mythological and other subjects, and are written with artistic knowledge and in attractive language. This work is imitated by the third Philostratus (or by some later sophist) of whose descriptions of pictures 17 remain.

There is great difficulty, due to a confused statement of Suidas, in disentangling the works and even the personalities of these Philostrati. Reference is there made to Philostratus as the son of Verus, a rhetorician in Nero's time, who wrote tragedies, comedies and treatises. Suidas thus appears to give to Philostratus the Athenian a life of 200 years! We must be content to assume two Lemnian Philostrati, both sophists, living in Rome. See further a full discussion by K. Mühscher, in *Philologus* (1907), suppl. x., pp. 469-557.

Of works bearing the name Philostratus there is a collected edition by C. F. Kayser (Zurich, 1844; Leipzig, 1870-1871), and another by Westermann (Paris, 1849), with Latin translation; these supersede those by F. Morel (Paris, 1608) and Olearius (Leipzig, 1700). There are separate editions of the *Eikones* by Schenkl and Reich (Leipzig, 1902); of the *Gymnasticus* by Mynas (1858), who discovered the MS., Darmberg (Paris, 1858), Volkmar (Aurich, 1862), and especially Julius Jäthner (1909), with introd., comments and Ger.

¹ As Lemnos was an Athenian island, any Lemnian could be called an Athenian.

trans.; of 75 epistles by Boissonade (Paris, 1842). The *Life of Apollonius* was first published by Aldus (1502); a French translation by Blaise de Vignerot appeared in 1596; an English translation of the first two books was published in London (1680) by Charles Blount, with some notes by Lord Herbert of Cherbury (prohibited in England in 1693; it was reprinted on the Continent); a full translation appeared in 1903. Critical works on the *Eikones* are numerous: K. Friedrichs, *Die Philostratischen Bilder* (1860); Goethe, "Philostrats Gemälde" in *Complete Works* (ed. Stuttgart, 1879); Brunn, *Die Philostratischen Bilder* (1860); A. Bougot, *Une Galerie antique* (1881); E. Bertrand, *Un Critique d'art dans l'antiquité: Philostrate à son école* (1882); Bergk, "Die Philostraten" in *Fünf Abhandlungen zur Geschichte der griechischen Philosophie und Astronomie* (1883); Schmid, *Atticismus* iv. 7, on the attribution of the works.

PHILOXENUS, of Cythera (435-380 B.C.), Greek dithyrambic poet. On the conquest of the island by the Athenians he was taken as a prisoner of war to Athens, where he came into the possession of the dithyrambic poet Melanippides, who educated him and set him free. Philoxenus afterwards resided in Sicily, at the court of Dionysius, tyrant of Syracuse, whose bad verses he declined to praise, and was in consequence sent to work in the quarries. After leaving Sicily he travelled in Greece, Italy and Asia, reciting his poems, and died at Ephesus. According to Suidas, Philoxenus composed twenty-four dithyrambs and a lyric poem on the genealogy of the Aeacidae. In his hands the dithyramb seems to have been a sort of comic opera, and the music, composed by himself, of a debased character. His masterpiece was the *Cyclops*, a pastoral burlesque on the love of the Cyclops for the fair Galatea, written to avenge himself upon Dionysius, who was wholly or partially blind of one eye. It was parodied by Aristophanes in the *Plutus* (290). Another work of Philoxenus (sometimes attributed to Phloxenus of Leucas, a notorious parasite and glutton) is the *Δείπνον* (Dinner), of which considerable fragments have been preserved by Athenaeus. This is an elaborate bill of fare in verse, probably intended as a satire on the luxury of the Sicilian court. The great popularity of Philoxenus is attested by a complimentary resolution passed by the Athenian senate in 393. The comic poet Antiphanes spoke of him as a god among men; Alexander the Great had his poems sent to him in Asia; the Alexandrian grammarians received him into the canon; and down to the time of Polybius his works were regularly learned and annually acted by the Arcadian youth.

Fragments, with life, by G. Bippart (1843); T. Bergk, *Poetae lyrici graeci*.

PHILOXENUS (Syriac, Akšnāyā), of Mabbōg, one of the best of Syriac prose writers, and a vehement champion of Monophysite doctrine in the end of the 5th and beginning of the 6th centuries. He was born, probably in the third quarter of the 5th century, at Tahal, a village in the district of Bēth Garmai east of the Tigris. He was thus by birth a subject of Persia, but all his active life of which we have any record was passed in the territory of the Greek Empire. The statements that he had been a slave and was never baptized appear to be malicious inventions of his theological opponents. He was educated at Edessa, perhaps in the famous "school of the Persians," which was afterwards (in 489) expelled from Edessa on account of its connexion with the Nestorian heresy. The years which followed the Council of Chalcedon (451) were a stormy period in the Syrian Church. Philoxenus soon attracted notice by his strenuous advocacy of Monophysite doctrine, and on the expulsion of Calandio (the orthodox patriarch of Antioch) in 485 was ordained bishop of Mabbōg² by his Monophysite-successor Peter the Fuller (Barhebraeus, *Chron. eccl. i.* 183). It was probably during the earlier years of his episcopate that Philoxenus composed his thirteen homilies on the Christian life. Later he devoted himself to the revision of the Syriac version of the Bible, and with the help of his chorepiscopus Polycarp produced in 508 the so-called Philoxenian version, which was in some sense the received Bible of the Monophysites during the 6th century. Meantime he continued his ecclesiastical activity, working as a bitter opponent of

² According to Barhebraeus (*Chron. eccl. ii.* 55) through the efforts of Philoxenus himself.

³ Hierapolis of the Greeks, Manbij of the Arabs, a few miles west of the Euphrates about latitude 364°.

Flavian II., who had accepted the decrees of the Council of Chalcedon and was patriarch of Antioch from 498 to 512. The Monophysites had the sympathy of the emperor Anastasius, and were finally successful in ousting Flavian in 512 and replacing him by their partisan Severus. Of Philoxenus's part in the struggle we possess not too trustworthy accounts by hostile writers, such as Theophanes and Theodoros Lector. We know that in 498 he was staying at Edessa¹; in or about 507, according to Theophanes, he was summoned by the emperor to Constantinople; and he finally presided at a synod at Sidon which was the means of procuring the replacement of Flavian by Severus. But the triumph was short-lived. Justin I., who succeeded Anastasius in 518, was less favourable to the party of Severus and Philoxenus, and in 519 they were both sentenced to banishment. Philoxenus was sent to Philippopolis in Thrace, and afterwards to Gangra in Paphlagonia, where he met his death by foul play in 523.

Apart from his redoubtable powers as a controversialist, Philoxenus deserves commemoration as a scholar, an elegant writer, and an exponent of practical Christianity. Of the chief monument of his scholarship—the Philoxenian version of the Bible—only the Gospels and certain portions of Isaiah are known to survive (see Wright, *Syr. Lit.* 14). It was an attempt to provide a more accurate rendering of the Greek Bible than had hitherto existed in Syriac, and obtained recognition among the Monophysites until superseded by the still more literal renderings of the Old Testament by Paul of Tella and of the New Testament by Thomas of Harkel (both in 616-617), of which the latter at least was based on the work of Philoxenus. There are also extant portions of commentaries on the Gospels from his pen. Of the excellence of his style and of his practical religious zeal we are able to judge from the thirteen homilies on the Christian life and character which have been edited and translated by Budge (London, 1894). In these he holds aloof for the most part from theological controversy, and treats in an admirable tone and spirit the themes of faith, simplicity, the fear of God, poverty, greed, abstinence and unchastity. His affinity with his earlier countryman Aphraates is manifest both in his choice of subjects and his manner of treatment. As his quotations from Scripture appear to be made from the Peshitā, he probably wrote the homilies before he embarked upon the Philoxenian version.² Philoxenus wrote also many controversial works and some liturgical pieces. Many of his letters survive, and at least two have been edited.³ Several of his writings were translated into Arabic and Ethiopic. (N. M.)

PHILTRE (Lat. *philtrum*, from Gr. *φίλτρον*, *φιλῆν*, to love), a drug or other medicinal drink supposed to have the magical property of exciting love.

PHINEUS, in Greek legend, son of Agenor, the blind king of Salmydessus on the coast of Thrace. He was skilled in the art of navigation, and Apollo had bestowed upon him the gift of prophecy. His blindness was a punishment from the gods for his having revealed the counsels of Zeus to mortals, or for his treatment of his sons by his first wife Cleopatra. His second wife having accused her stepsons of dishonourable proposals, Phineus put out their eyes, or exposed them to the wild beasts, or buried them in the ground up to their waists and ordered them to be scourged. Zeus offered him the choice of death or blindness. Phineus chose the latter, whereupon Helios (the sun-god), offended at the slight thus put upon him, sent the Harpies to torment him. In another story, the Argonauts (amongst whom were Calais and Zetes, the brothers of Cleopatra), on their arrival in Thrace found the sons of Phineus half-buried in the earth and demanded their liberation. Phineus refused, and a fight took place in which he was slain by Heracles, who freed Cleopatra (who had been thrown into prison) and her sons, and reinstated them as rulers of the kingdom. Tragedies on the subject of Phineus were written by Aeschylus and Sophocles. These would directly appeal to an Athenian audience, Phineus's first wife having been the daughter of Orithyia (daughter of Erechtheus, king of Athens), who had been carried off by Boreas to his home in Thrace. The punishment of Phineus would naturally be regarded as a just retribu-

¹ *Chronicle of Joshua Stylites*, ch. 30.

² On these and other points see Budge's introduction to his second volume, which contains also a list of the other works of Philoxenus and a number of illustrative extracts.

³ One by Martin (in *Grammatica chrestomathia et glossarium linguae syriacae*) and one by Guidi (*Le Lettere di Filosseno ai monaci di Tell'Addā*).

tion for the insult put upon a princess of the royal house of Athens.

Apollodorus i. 9, 21, iii. 15, 3; Sophocles, *Antigone*, 966, with Jebb's notes; Diod. Sic. iv. 43, 44; Servius on *Aeneid* iii. 209; Schol. on Apollonius Rhodius ii. 178.

PHIPS (or **PHIPPS**), **SIR WILLIAM** (1651-1695), colonial governor of Massachusetts, was born on the 2nd of February 1651, at Woolwich, Maine, near the mouth of the Kennebec river. He was a shepherd until he was eighteen, and then a ship carpenter's apprentice for four years; worked at his trade in Boston for a year, at this time learning to read and write; and with his wife's property established a ship-yard on the Sheepscot river in Maine, but soon abandoned it because of Indian disorders. In 1684-1686, with a commission from the British Crown, he searched vainly for a wrecked Spanish treasure ship of which he had heard while on a voyage to the Bahamas; he found this vessel in 1687, and from it recovered £300,000. Of this amount much went to the duke of Albemarle, who had fitted out the second expedition. Phips received £16,000 as his share, was knighted by James II., and was appointed sheriff of New England under Sir Edmund Andros. Poorly educated and ignorant of law, Phips could accomplish little, and returned to England. In 1689 he returned to Massachusetts, found a revolutionary government in control, and at once entered into the life of the colony. He joined the North Church (Cotton Mather's) at Boston, and was soon appointed by the General Court commander of an expedition against the French in Canada, which sailed in April 1690 and easily captured Port Royal. A much larger expedition led by Phips in July against Quebec and Montreal ended disastrously. Phips generously bought at their par value, in order to give them credit in the colony, many of the colony's bills issued to pay for the expedition. In the winter of 1690 he returned to England, vainly sought aid for another expedition against Canada, and urged, with Increase Mather, the colonial agent, a restoration of the colony's charter, annulled during the reign of Charles II. The Crown, at the suggestion of Mather, appointed him the first royal governor under the new charter. On reaching Boston in May 1692, Phips found the colony in a very disordered condition, and though honest, persevering and indisposed to exalt his prerogative at the expense of the people, he was unfitted for the difficult position. He appointed a special commission to try the witchcraft cases, but did nothing to stop the witchcraft mania, and suspended the sittings of the court only after great atrocities had been committed. In defending the frontier he displayed great energy, but his policy of building forts was expensive and therefore unpopular. Having the manners of a 17th-century sea captain, he became involved in many quarrels, and engaged in a bitter controversy with Governor Benjamin Fletcher of New York. Numerous complaints to the home government resulted in his being summoned to England to answer charges. While in London awaiting trial, he died on the 18th of February 1695.

See Cotton Mather's *Life of His Excellency Sir William Phips* (London, 1697; republished in his *Magnalia in 1702*); Francis Bowen's "Life of Sir William Phips," in Jared Sparks's *American Biography*, 1st series, vol. vii. (New York, 1856); William Gould's "Sir William Phips," in *Collections of the Maine Historical Society*, series 1, vol. ix. (Portland, 1887); Ernest Myrand's *Sir William Phips devant Québec* (Québec, 1893); Thomas Hutchinson's *History of Massachusetts* (2 vols., Boston; 3rd ed., 1795); and J. G. Palfrey's *History of New England* (5 vols., Boston, 1858-1890).

PHLEBITIS (from Gr. *φλέψ*, a vein), inflammation of a vein. When a vein is inflamed the blood in it is apt to form a clot, or thrombus, which, if loosened and displaced from its original position, may be carried as an embolus towards the heart and there be arrested; or it may pass through the cavities of the heart into the lungs, there to lodge and to give rise to alarming symptoms. If the thrombus is formed in the inflamed vein of a pile it may pass as an embolus (see HAEMORRHOIDS) into the liver. If an embolus is carried through the left side of the heart it may enter the large vessels at the root of the neck and reach the brain, giving rise to serious cerebral disturbance or

to a fatal paralysis. The thrombus may be formed in gout and rheumatism, or in consequence of stagnation of the blood-current due to slowing of the circulation in various wasting diseases. When a thrombus forms, absolute rest in the recumbent posture is to be strictly enjoined; the great danger is the displacement of the clot. An inflamed and clotted vein, if near the surface, causes an elongated, dusky elevation beneath the skin, where the vein may be felt as a hard cord, the size, perhaps, of a cedar pencil, or a pen-holder. Its course is marked by great tenderness, and the tissue which was drained by the branches of that vein are livid from congestion, and perhaps boggy and pitting with oedema. If, as often happens, the inflamed vein is one of those running conspicuously upwards from the foot—a saphenous vein (*saphis*, distinct)—the patient should be placed in bed with the limb secured on a splint in order to protect it from any rough movement. Should the clot become detached, it might give rise to sudden and alarming faintness possibly even to a fatal syncope. Thus, there is always grave risk with an inflamed and clotted vein, and modern surgery shows that the safest course is, when practicable, to place a ligature on the vein upon the heart-side of the clotted piece and to remove the latter by dissection. When, as sometimes happens, the clot is invaded by septic organisms it is particularly liable to become disintegrated, and if parts of it are carried to various regions of the body they may there give rise to the formation of secondary abscesses. In the ordinary treatment of phlebitis, in addition to the insistence on perfect rest and quiet, fomentations may be applied locally, the limb being kept raised. Massage must not be employed so long as there is any risk of a clot being detached. (E. O.*)

PHLEGON, of Tralles in Asia Minor, Greek writer and freedman of the emperor Hadrian, flourished in the 2nd century A.D. His chief work was the *Olympiads*, an historical compendium in sixteen books, from the 1st down to the 229th Olympiad (776 B.C. to A.D. 137), of which several chapters are preserved in Photius and Syncellus. Two small works by him are extant: *On Marvels*, containing some ridiculous stories about ghosts, prophecies and monstrous births, but instructive as regards ancient superstitions; *On Long-lived Persons*, a list of Italians who had passed the age of 100, taken from the Roman censuses. Other works ascribed to Phlegon by Suidas are a description of Sicily, a work on the Roman festivals in three books, and a topography of Rome.

Fragments in C. Müller, *Frag. hist. graec.* iii.; of the *Marvels* and *Long-lived* in O. Keller, *Resum. naturalium scriptores*, i. (1877); see also H. Diehl, "Phlegons Androgyneorakel" in *Sibyllinische Blätter* (1890).

PHLOGOPITE, a mineral belonging to the group of micas (q.v.). It is a magnesium mica, differing from biotite in containing only a little iron; the chemical formula is $[H,K,(MgF)]_2Mg_3Al(SiO_3)_6$. It crystallizes in the monoclinic system, but the crystals are roughly developed. There is a perfect cleavage parallel to the basal plane; the cleavage flakes are not quite so elastic as those of muscovite. Sometimes it is quite colourless and transparent, but usually of a characteristic yellowish-brown colour, and often with a silvery lustre on the cleavage surfaces, hence the trade name "silver amber mica" for some varieties. The name phlogopite is from Gr. *φλογωρός* (fiery-looking), the mineral being sometimes brownish-red and coppery in appearance. The hardness is 2½–3, and the specific gravity 2.78–2.85. The optic axial plane is parallel to the plane of symmetry and the axial angle 0°–10°. Phlogopite occurs chiefly as scales and plates embedded in crystalline limestones of the Archean formation. The mica mined in Canada and Ceylon is mainly phlogopite, and is largely used as an insulator for electrical purposes. In Canada it occurs with apatite in pyroxene rocks which are intrusive in Laurentian gneisses and crystalline limestones, the principal mining district being in Ottawa county in Quebec and near Burgess in Lanark county, Ontario. In Ceylon, the mineral forms irregular veins, rarely exceeding one or two feet in width, traversing granite, especially near the contact of this rock with crystalline limestones. (L. J. S.)

PHLOX (Nat. Ord. Polemoniaceae), a genus of about 30 species, mostly perennial hardy plants of great beauty, natives of North America (one occurs in Siberia), with entire, usually opposite, leaves and showy flowers generally in terminal clusters. Each flower has a tubular calyx with five lobes, and a salver-shaped corolla with a long slender tube and a flat limb. The five stamens are given off from the tube of the corolla at different heights and do not protrude beyond it. The ovary is three-celled with one to two ovules in each cell; it ripens into a three-valved capsule. Many of the species and varieties are tall herbs yielding a wealth of bloom throughout the summer and early autumn. These require a deep, rich, and rather heavy loam, and a cool, moist position to flourish.

The dwarf perennial species and varieties, the "moss pinks" of gardens, are charming plants for the rockery and as edging to beds and borders. They are trailing and tufted in habit, the branches rooting at the nodes. They succeed in poorer soil, and drier situations than the tall kinds. Seed is seldom produced. Propagation is effected by cuttings in July and early August, placed in a cold frame, and by division of the plants, which should be lifted carefully, and cut into rooted portions as required. The tufted kinds decay in patches in winter if the situation is moist and the weather mild and wet.

Phlox Drummondii and its numerous varieties are half-hardy annuals in Britain. It is a small-growing hairy plant, flowering profusely during the summer months. For early flowering it should be sown in heat in March and April and transferred out of doors in June. It succeeds if sown out of doors in April, but the flowering season is later and shorter.

The tall-growing border phloxes are divided into early and late flowering kinds respectively, the former derived mainly from *P. glaberrima* and *P. suffruticosa*, and the latter from *P. maculata* and *P. paniculata*. The salver-shaped flowers with cylindrical tubes range from pure white to almost bright scarlet in colour, passing through shades of pink, purple, magenta lilac, mauve and salmon. New varieties are obtained by the selection of seedlings. Owing to the frequent introduction of new kinds, the reader is referred to the current lists published by growers and nurserymen. The "moss pinks," *P. subulata* and its varieties, are all worthy of a place in the alpine garden.

The varieties are relatively few. The following list includes nearly all the best kinds:—

P. subulata, pink with dark centre; *Aldboroughensis*, rose; *annulata*, bluish white, ringed with purple; *atrolilacina*, deep lilac; *atropurpurea*, purple-rose and crimson; *Brightness*, bright rose with scarlet eyes; *compacta*, clear rose; *Fairy*, lilac; *G. F. Wilson*, mauve; *grandiflora*, pink, crimson blotch; *Little Dot*, white, blue centre; *Nelsoni*, pure white; *Vivid*, rose, carmine centre; all these are about 4 in. high. *P. dimorpha*, lavender, height 1 ft.; *P. ocala*, rose, 1 ft.; *P. reptans*, rose, 6 in.; and *P. amoena*, rose, 9 in., are also charming alpines.

P. Drummondii varieties come true from seed, but are usually sown in mixture.

PHOCAEA (mod. *Fokia* or *Fokka*) an ancient city on the western coast of Asia Minor, famous as the mother city of Marseilles. It was the most northern of the Ionian cities, and was situated on the coast of the peninsula which separates the gulf of Cyme, occupied by Aeolian settlers, from the Hermæan Gulf, on which stood Smyrna and Clazomenae.¹ Its position between two good harbours, Naustathmus and Lampter (*Livy* xxxvii. 31), led the inhabitants to devote themselves to maritime pursuits. According to Herodotus the Phocæans were the first of all the Greeks to undertake distant voyages, and made known the coasts of the Adriatic, Tyrrhenia and Spain. Arganthonius, king of Tartessus in Spain, invited them to emigrate in a body to his dominions, and, on their declining, presented them with a large sum of money. This they employed in constructing a strong wall around their city, a defence which stood them in good stead when Ionia was attacked by Cyrus in 546. Eventually they determined to seek a new home in the west, where they already had flourishing colonies, e.g.

¹ It was said to have been founded by a band of emigrants from Phocis, under the guidance of two Athenian leaders, named Philogenes and Damon, but it joined the Ionian confederacy by accepting the government of Athenian rulers of the house of Codrus.

Alalia in Corsica and Massilia (mod. Marseilles). A large part of the emigrants proceeded only as far as Chios, returned to Phocaea, and submitted to the Persian yoke.

Phocaea continued to exist under the Persian government, but greatly reduced in population and commerce. Though it joined in the Ionian revolt against Persia in 500 it was able to send only three ships to the combined fleet which fought at Lade. But a Phocæan took the supreme command. It never again played a prominent part in Ionian history, and is rarely mentioned. In the time of Timur Fajah was a fortress of Sarukhan, but had been previously in Genoese hands. The ruins still visible on the site bear the name of Palæa Fokia, but they are of little interest. The modern town in the immediate neighbourhood, still known as Fokia, was founded by the Genoese in 1421 on account of the rich alum mines in the neighbourhood. It has a fair natural harbour, which is the nearest outlet of the rich district of Menemen. About 1880, while the Gediz Chai was throwing its silt unchecked into the Gulf of Smyrna and gradually filling the navigable channel, there was talk of reviving Fokia as a new port for Smyrna, and connecting it with the Cassaba railway. But, in deference to Smyrniote protests, a new estuary was cut for the Gediz. Fokia has acquired local importance however as a port of call for coasting steamers, and it is used to some degree as a summer residence by Smyrniotes.

(D. G. H.)

PHOCAS, East Roman emperor (602–610), was a Cappadocian of humble origin. He was still but a centurion when chosen by the army of the Danube to lead it against Constantinople. A revolt within the city soon afterwards resulted in the abdication of the reigning emperor Maurice, and in the elevation of Phocas to the throne, which seems to have been accomplished by one of the circus factions against the wish of the troops. Phocas proved entirely incapable of governing the empire. He consented to pay an increased tribute to the Avars and allowed the Persians, who had declared war in 604 under Chosroes II., to overrun the Asiatic provinces and to penetrate to the Bosphorus. When the African governor Heraclius declared against him, Phocas was deserted by the starving populace of Constantinople, and deposed with scarcely a struggle (610). He died in the same year on the scaffold.

See J. B. Bury, *The Later Roman Empire* (London, 1889), ii. 197–206.

PHOCION, Athenian statesman and general, was born about 402 B.C., the son of a small manufacturer. He became a pupil of Plato and in later life was a close friend of Xenocrates. This academic training left its mark upon him, but it was as a soldier rather than as a philosopher that he first came into notice. Under Chabrias he distinguished himself in the great sea-fight of Naxos (376), and in the subsequent campaigns loyally supported his chief. He won the confidence of the allies by his justice and integrity. In 351–349^a he entered the Persian service and helped to subdue a rebellion in Cyprus. Henceforward he always held a prominent position in Athens, and although he never canvassed he was elected general forty-five times in all. In politics he is known chiefly as the consistent opponent of the anti-Macedonian firebrands, headed by Demosthenes, Lycurgus and Hyperides, whose fervent eloquence he endeavoured to damp by recounting the plain facts of Athens's military and financial weakness and her need of peace, even when the arms of Athens seemed to prosper most. But although he won the respect of his audience, his advice was frequently discarded. Yet his influence was felt at the trial of Aeschines in 343, whom he helped to defend, and after the disaster of Chæroneia (338), when he secured very lenient terms from Philip. He also rendered good service in the field: in 348 he saved the force operating against the philo-Macedonian tyrants in Euboea by the brilliant victory of Tamynæ. Under the Macedonian predominance his reputation steadily increased.

^a Diodorus's statement that Phocion was 75 at his death (i.e. that he became general at 30 and was elected 45 years in succession) would give 394–393 as the date of birth; but he must have been quite 25 as second-in-command at Naxos (376).

^b The chronology is uncertain; the dates given for this period are Beloch's (*Griechische Geschichte*, ii.).

Though by no means inclined to truckle to the Macedonians, as is shown by his protection of the refugee Harpalus and his spirited campaign in defence of Attica in 322, he won the confidence of the conquerors, and in the restricted democracy which Antipater enforced he became the virtual ruler of Athens. Old age, however, was telling on him; when Polyperchon by his proclamation of "freedom" raised a new crisis in 318, Phocion's dilatoriness was interpreted as active treason on Cassander's behalf, and the people, incited by the restored democrats, deposed him from office. Phocion fled to Polyperchon, but was sent back by the latter to be tried at Athens. The assembly, containing numerous slaves and all the city mob, shouted Phocion down and condemned him to death unheard. Not long after, the Athenians decreed a public burial and a statue in his honour.

Phocion's character and policy were throughout inspired by his philosophic training, which best explains his remarkable purity of character and his prudent councils. To the same influence we may ascribe his reserve and his reluctance to co-operate heartily either with the people or with the Macedonian conquerors who put their trust in him: a greater spirit of energy and enterprise might have made him the saviour of his country. Phocion remained famous in antiquity for the pithy sayings with which he used to parry the eloquence of his opponents. Demosthenes called him "the chopper of my periods."

Plutarch (*Life of Phocion*) draws much good information from Philochorus and Duris (who reproduces Hieronymus of Cardia); his numerous anecdotes are repeated in other works of his and in Aelian (*Var. Hist.*). Diodorus (xvi.–xviii.) is likewise based on Duris. See *Helm. Gr. Hist.* vol. iii. (Eng. trans., London, 1896).

(M. O. B. C.)

PHOCIS, an ancient district of central Greece (now a department, pop. 62,246), about 625 sq. m. In area, bounded on the W. by Ozolian Locris and Doris, on the N. by Ojuntian Locris, on the E. by Boeotia, and on the S. by the Corinthian Gulf. The massive ridge of Parnassus (8068 ft.), which traverses the heart of the country, divides it into two distinct portions. Between this central barrier and the northern frontier range of Cnemis (3000 ft.) is the narrow but fertile valley of the Cephissus, along which most of the Phocian townships were scattered. Under the southern slope of Parnassus were situated the two small plains of Crisa and Anticyra, separated by Mt Cirphæ, an offshoot from the main range. Being neither rich in material resources nor well placed for commercial enterprise, Phocis was mainly pastoral. No large cities grew up within its territory, and its chief places were mainly of strategic importance.

The early history of Phocis remains quite obscure. From the scanty notices of Greek legend it may be gathered that an influx of tribes from the north contributed largely to its population, which was reckoned as Aeolic. It is probable that the country was originally of greater extent, for there was a tradition that the Phocians once owned a strip of land round Daphnus on the sea opposite Euboea, and carried their frontier to Thermopylae; in addition, in early days they controlled the great sanctuary of Delphi. The restriction of their territory was due to the hostility of their neighbours of Boeotia and Thessaly, the latter of whom in the 6th century even carried their raids into the Cephissus valley. Moreover the Dorian population of Delphi constantly strove to establish its independence and about 590 B.C. induced a coalition of Greek states to proclaim a "Sacred War" and free the oracle from Phocian supervision. Thus their influence at Delphi was restricted to the possession of two votes in the Amphictyonic Council.

During the Persian invasion of 480 the Phocians at first joined in the national defence, but by their irresolute conduct at Thermopylae lost that position for the Greeks; in the campaign of Plataeæ they were enrolled on the Persian side. In 457 an attempt to extend their influence to the head waters of the Cephissus in the territory of Doris brought a Spartan army into Phocis in defence of the "metropolis of the Dorians." A similar enterprise against Delphi in 448 was again frustrated by Sparta, but not long afterwards the Phocians recaptured the sanctuary with the help of the Athenians, with whom they

had entered into alliance in 454. The subsequent decline of Athenian land-power had the effect of weakening this new connexion; at the time of the Peloponnesian War Phocis was nominally an ally and dependent of Sparta, and had lost control of Delphi.

In the 4th century Phocis was constantly endangered by its Boeotian neighbours. After helping the Spartans to invade Boeotia during the Corinthian War (395-94), the Phocians were placed on the defensive. They received assistance from Sparta in 380, but were afterwards compelled to submit to the growing power of Thebes. The Phocian levy took part in Epaminondas' inroads into Peloponnesus, except in the final campaign of Mantinea (370-62), from which their contingent was withheld. In return for this negligence the Thebans fastened a religious quarrel upon their neighbours, and secured a penal decree against them from the Amphictyonic synod (356). The Phocians, led by two capable generals, Phlomeus and Onomarchus, replied by seizing Delphi and using its riches to hire a mercenary army. With the help of these troops the Phocian League at first carried the war into Boeotia and Thessaly, and though driven out of the latter country by Philip of Macedon, maintained itself for ten years, until the exhaustion of the temple treasures and the treachery of its leaders placed it at Philip's mercy. The conditions which he imposed—the obligation to restore the temple funds, and the dispersion of the population into open villages—were soon disregarded. In 339 the Phocians began to rebuild their cities; in the following year they fought against Philip at Chaeronea. Again in 323 they took part in the Lamian War against Antipater, and in 279 helped to defend Thermopylae against the Gauls.

Henceforth little more is heard of Phocis. During the 3rd century it passed into the power of Macedonia and of the Aetolian League, to which in 196 it was definitely annexed. Under the dominion of the Roman republics national league was dissolved, but was revived by Augustus, who also restored to Phocis the votes in the Delphic Amphictyony which it had lost in 346 and enrolled it in the new Achaean synod. The Phocian League is last heard of under Trajan.

See Strabo, pp. 401, 418, 424-425; Pausanias x. 1-4; E. Freeman, *History of Federal Government* (ed. 1893, London), pp. 113-114; C. Kasarow, *De foederis Phocianum institutis* (Leipzig, 1899); B. Head, *Historia numorum* (Oxford, 1887), pp. 287-288.

(M. O. B. C.)

PHOCYLIDES, Greek gnomic poet of Miletus, contemporary of Theognis, was born about 560 B.C. A few fragments of his "maxims" have been preserved (chiefly in the *Florilegium* of Stobaeus), in which he expresses his contempt for the pomps and vanities of rank and wealth, and sets forth in simple language his ideas of honour, justice and wisdom. A complete didactic poem (230 hexameters) called *Ποικίλα ποικιλιών* or *γνώμας*, bearing the name of Phocylides, is now considered to be the work of an Alexandrian Christian of Jewish origin who lived between 170 B.C. and A.D. 50. The Jewish element is shown in verbal agreement with passages of the Old Testament (especially the book of Sirach); the Christian by the doctrine of the immortality of the soul and the resurrection of the body. Some Jewish authorities, however, maintain that there are in reality no traces of Christian doctrine to be found in the poem, and that the author was a Jew. The poem was first printed at Venice in 1495, and was a favourite school textbook during the Reformation period.

See fragments and the spurious poem in T. Bergk, *Poetae lyrici graeci*, ii. (4th ed., 1882); J. Bernays *Über das Phokylidische Gedicht* (1858); *Phocylides, Poem of Admonition*, with introduction and commentary by J. B. Fordyce, and translation by H. D. Goodwin (Andover, Mass., 1879); F. Susemihl, *Geschichte der griechischen Litteratur in der Alexandrinerzeit*, (1892), ii. 642; S. Krauss (s.n. "Pseudo-Phocylides") in *The Jewish Encyclopedia* and E. Schröter, *Hist. of the Jewish People*, div. ii., vol. iii., 312-316 (Eng. trans., 1886), where full bibliographies are given. There is an English verse translation by W. Hewett (Watford, 1840), *The Perceptive Poem of Phocylides*.

PHOEBE, in astronomy, the ninth satellite of Saturn in order of discovery, or the tenth and outermost now known in

the order of distance. It was discovered by W. H. Pickering in 1899 by photographs of the stars surrounding Saturn. It is remarkable in that its motion around the planet is retrograde. (See SATURN.)

PHOEBUS (Gr. for "bright," "pure,"), a common epithet of Apollo (*q.v.*). Artemis in like manner is called Phoebe, and in the Latin poets and their modern followers Phoebus and Phoebe are often used simply for the sun and moon respectively.

PHOENICIA, in ancient geography, the name given to that part of the seaboard of Syria which extends from the Eleutherus (Nahr el-Kebir) in the north to Mt Carmel in the south, a distance of rather more than two degrees of latitude. These limits, however, were exceeded at various times; thus, north of the Eleutherus lay Aradus and Marathus, and south of Carmel the border sometimes included Dor and even Joppa. Formed partly by alluvium carried down by perennial streams from the mountains of Lebanon and Galilee, and fringed by great sand-dunes which the sea throws up, Phoenicia is covered with a rich and fertile soil. It is only at the mouth of the Eleutherus and at Acre ('Akka) that the strip of coast-land widens out into plains of any size; there is a certain amount of open country behind Beirut; but for the most part the mountains, pierced by deep river-valleys, approach to within a few miles of the coast, or even right down to the sea, as at Räs en-Nakûra (Scala Tyriorum, *Joe. Bell. jud.* ii. 10, 2) and Ras el-Abiad (Pliny's Promunturium Alburn) where a passage had to be cut in the rock for the caravan road which from time immemorial traversed this narrow belt of lowland. From the flanks of Lebanon, especially from the heights which lie to the north of the Qasimiyeh or Kasimiyah (Litány) River, the traveller looks down upon some of the finest landscape in the world; in general features the scenery is not unlike that of the Italian Riviera, but surpasses it in grandeur and a peculiar depth of colouring.

With regard to natural products the country has few worth mentioning; minerals are found in the Lebanon, but not in any quantity; traces of amber-digging have been discovered on the coast; and the purple shell (*murex trunculus* and *brandaris*) is still plentiful. The harbours which played so important a part in antiquity are nearly all silted up, and, with the exception of Beirut, afford no safe anchorage for the large vessels of modern times. A few bays, facing towards the north, break the coast-line, and small rocky islands are dotted here and there just off the shore. Sidon, Tyre and Aradus, though now connected with the mainland, were built originally upon islands, the Phoenicians preferred such sites, because they were convenient for shipping and easily defended against attack.

The chief towns of ancient Phoenicia, as we know of them from the Amarna tablets (15th century B.C.) and from Egyptian, Assyrian and the Old Testament documents, were the following: Acco (now Acre or 'Akka, *Judg.* i. 31), Achish (now es-Zib, *ibid.*), Ashab (in Assyrian Mahallib, *ibid.*),—three towns on the coast south of Tyre, Kânâh (*Josh.* xix. 28), Tyre (Phoen. Sôr, now Sôr), Zarephath or Sarepta (1 Kings xvii. 9 now Sarfand), Sidon (now Saïdâ), Berytus (Biruta in Egyptian, Biruna in the Amarna tablets, now Beirut), Byblus (in Phoen. and Hebr. Gebel, now Jebel), Arka, 80 mi. north of Sidon (*Gen.* x. 17, now 'Arka), Sin (Assyr. Sianu, *ibid.*), Simyra (*Gen.* x. 18, now Sumrâ), Marathus (now Amrit) not important till the Macedonian period, Arvad or Aradus (in Phoen. Arwâd, now Ruâd, *Gen.* x. 18; *Ezek.* xxxvii. 8, 11), the most northerly of the great Phoenician towns, and always famous as a maritime state.

Race and Language.—The Phoenicians were an early offshoot from the Semitic stock, and belonged to the Canaanite branch of it. Curiously enough in *Gen.* x. Sidon, the "first-born" of Canaan, is classed among the descendants of Ham; but the table of nations in *Gen.* x. is not arranged upon strict ethnographic principles; perhaps religious antagonism induced the Hebrews to assign to the Canaanites an ancestry different from their own; at any rate the close connexion which existed from an early date between the Phoenicians and the Egyptians may have suggested the idea that both peoples belonged to the same race. The Phoenicians themselves retained some memory of having migrated from older seats on an eastern sea; Herodotus (i. 1; vii. 89) calls it the "red sea," meaning probably the

Persian Gulf; the tradition, therefore, seems to show that the Phoenicians believed that their ancestors came originally from Babylonia. By settling along the Syrian coast they developed a strangely un-Semitic love for the sea, and advanced on different lines from the other Canaanites who occupied the interior. They called themselves Canaanites and their land Canaan; such is their name in the Amarna tablets, *Kinabhi* and *Kinabhi*; and with this agrees the statement assigned to Hecataeus (*Fr. hist. gr. i. 17*) that Phoenicia was formerly called *Xpā*, a name which Philo of Byblos adopts into his mythology by making "Chna who was afterwards called Phoenix" the eponym of the Phoenicians (*Fr. hist. gr. iii. 569*). In the reign of Antiochus IV. and his successors the coins of Laodicea of Libanus bear the legend "Of Laodicea which is in Canaan";¹ the Old Testament also sometimes denotes Phoenicia and Phoenicians by "Canaan" and "Canaanites" (*Isa. xxiii. 11; Obad. 20; Zeph. i. 11*), though the latter names generally have a more extended sense. But "Sidonians" is the usual designation both in the Old Testament and in the Assyrian monuments (*Sidunnu*); and even at the time of Tyre's greatest ascendancy we read of Sidonians and not Tyrians in the Old Testament and in Homer; thus Ethbaal king of Tyre (*Jos. Ant. viii. 13, 2*) is called king of the Sidonians in 1 Kings xvi. 31. In the Homeric poems we meet with *Σιδώνιοι*, *Σιδωρία* (*Od. iv. 618; Il. vi. 209; Od. xiii. 285; Il. vi. 291*) and *Φοίνικες*, *Φοινίκη* (*Od. xiii. 272, xiv. 288 seq., &c.*), and both terms together (*Od. iv. 83 seq., Il. xxiii. 743 seq.*)² And the Phoenicians themselves used Sidonians as a general name; thus in the oldest Phoenician inscription known (*CIS. i. 5=NSI., No. 11*), Hiram II. king of Tyre in the 8th century is styled "king of the Sidonians." But among the Greeks "Phoenicians" was the name most in use, *Φοίνικες* (plur. of *Φοίνιξ*) for the people and *Φοινίκη* for the land (cf. *PHOENIX*). The former was probably the older word, and may be traced to *φωρός*="blood-red"; the Canaanite sailors were spoken of as the "red men" on account of their sunburnt skin; then the land from which they came was called after them; and then probably the original connexion between *Φοίνιξ* and *φωρός* was forgotten, and new forms and meanings were invented. Thus *φωίνιξ* came to mean a "date-palm"; but the date-palm is not in the least characteristic of Phoenicia, and can hardly grow there; *φωίνιξ* in this sense has no connexion with the original meaning of Phoenician. A derivation has been sought elsewhere, and the Egyptian *Fenḫ* proposed as the origin of the name; but the word *Fenḫ* was apparently used of Asiatic barbarians in general, without any special reference to the Phoenicians (*W. M. Müller, Asien u. Europa*, p. 208 seq.). The Lat. *Poenus* is of course merely an adaptation of the Greek form.³

Language.—Inscriptions, coins, topographical names preserved by Greek and Latin writers, names of persons and the Punic passages in the *Poenulus* of Plautus, all show conclusively that the Phoenician language belonged to the North-Semitic group, and to that subdivision of it which is called the Canaanite and includes Hebrew and the dialect of Moab. A comparison between Phoenician and Hebrew reveals close resemblances both in grammatical forms and in vocabulary; in some respects older features have been preserved in Phoenician, others are later, others again are peculiar to the dialect; many words poetic or rare or late in Hebrew are common in Phoenician. Hence we may conclude that the two languages developed independently from a common ancestor, which can be no other than the ancient Canaanite, of which a few words have survived in the Canaanite glosses to the Amarna tablets (written in Babylonian).⁴ But in forming an estimate of the Phoenician language it must be remembered that our material is scanty and limited in range; the Phoenicians were in no wise a literary people; moreover, with one exception (*CIS. i. 3*), almost all the inscriptions are subsequent

¹ Cooke, *North-Semitic Inscriptions* (elsewhere abbreviated *NSI.*), No. 149 B. 8.

² In this passage "Phoenicians" is a general name for carriers of commerce, not the inhabitants of a particular country. Similarly "Sidonian" in *Il. vi. 209*, is taken to mean Semites in general. Elsewhere "Phoenicians" are merchants, kidnapers, &c., "Sidonians" are artists; to indicate nationality both names seem to be used indifferently, e.g. *Od. xiii. 272, xiv. 288, x. 414*.

³ See especially Pictschmann, *Gesch. d. Phönizier*, 13 sqq., and Winckler, *Keilinschr. u. d. A. T.*, 3rd ed., 127.

⁴ A vocabulary is given in *KAT.*, 652 sqq.; see further Böhl, *Die Sprache d. Amarnatexte* (1909).

to the 6th century B.C.; the majority belong to the 4th century and later, by which time the language must have undergone a certain amount of decay.⁵ Indirectly, however, the Phoenicians rendered one great service to literature; they took a large share in the development and diffusion of the alphabet which forms the foundation of Greek (*Herod. v. 58*) and of all European writing. The Phoenician letters in their earlier types are practically identical with those used by the Hebrews (e.g. the Siloam inscr. *NSI. No. 2*), the Moabites (e.g. the Mesha stone, *ibid. No. 1*), and the Aramaeans of north Syria (e.g. the Zenjirli inscr. *ibid. Nos. 61-63*). They passed through various modifications in the course of time; flowing from the mother country the script acquires a more cursive, flowing style on the stones from Cyprus and Attica; the tendency becomes more strongly marked at the Punic stage; until in the neo-Punic, from the destruction of Carthage (146 B.C.) to the 1st century A.D., both the writing and the language reached their most degenerate form. As a rustic dialect the language lasted on in North Africa till the 5th century A.D. In his sermons St. Augustine frequently quotes Punic words.

History.—The Phoenicians, in imitation of the Egyptians, claimed that their oldest cities had been founded by the gods themselves, and that their race could boast an antiquity of 30,000 years (Africanus in Syncellus, *Early Period*, p. 31). Herodotus quotes (*ii. 44*) a more moderate tradition which placed the foundation of Tyre 2300 years before his time, i.e., c. 2756 B.C. According to Justin (*xviii. 3*) the Phoenicians, who had long been settled on the coast and occupied Sidon, founded Tyre in the year before the fall of Troy; possibly the date 1198 B.C., given by Menander of Ephesus (*in Jos. Ant. viii. 3, 1* and *c. Ap. i. 18*) as that from which the era of Tyre begins, may refer to the epoch which Justin mentions. Little certainty, however, can be allowed to these traditional chronologies. It is probable that in remote ages Babylonia exercised a considerable influence upon Syria and its coast towns; but Mr. L. W. King has shown that the tradition, which was supposed to connect Sargon I. (c. 3800 B.C.) with the western land and sea, has been misunderstood; it was the sea in the east, i.e. the Persian Gulf, which Sargon crossed (*Chronicles concerning Early Bab. Kings*, vol. I. ch. 2, 1907).

The extension of the Egyptian empire in the direction of Asia began about 1600 B.C. under Ahmose (Aahmes, Amasis) I., the founder of the XVIIIth Dynasty, who carried his arms into Syria, and conquered at least Palestine and Phoenicia, the latter being the country called *Ḫa-ḫi* on the Egyptian monuments (Müller, *As. u. Eur.* p. 181). Whether the campaign of Thothmes (Tethmosis) I. to the Euphrates produced any lasting results is doubtful; it was Thothmes III. (1503-1449) who repeated and consolidated the earlier conquest, and established Egyptian suzerainty over all the petty states of Syria and Phoenicia (see *EGYPT: History*, I.). For the geography and civilization of Canaan about 1400 B.C. we have valuable evidence in the Egyptian papyrus Anastasi I., which mentions Kepuna (Gubna, Gebal-Byblos) the holy city, and continues: "Come then to Berytus, to Sidon, to Sarepta. Where is the ford of Nat'-ana (? Nahr el-Kasimiyeh, or a town)? Where is 'Eutu (? Usu, Palaetyrus) ? Another city on the sea is called a haven, D'ar (Tyre) is its name, water is carried to it in boats; it is richer in fish than in sands."⁶ But the fullest information about the state of Phoenicia in the 15th and 14th centuries B.C. comes from the Amarna tablets, among which are many letters from the subject princes and the Egyptian governors of Phoenicia to the Pharaoh.⁷ It was a time of much political disturbance. The Hittites (q.v.) were invading Syria; nomads from the desert supported the invasion; and many of the local chiefs were ready to seize the opportunity to throw off the yoke of Egypt. The towns of Phoenicia were

⁵ For the Phoen. inscr. see *Corpus inscriptionum semiticarum*, pt. I., brought up to date provisionally by *Répertoire d'Épigraphie*. A selection is published by Lidzbarski, *Handbuch d. semitisch-epigraphik* (1898); Cooke, *Textbook of North-Semitic Inscriptions* (1903), with translations and notes; Landau, *Beiträge z. Altertums- u. d. Orient* (1899-1906); Lidzbarski, *Altsem. No. 302 seq.*; Jeremias, *Das A. T. im Lichte d. alt. Cit.*, pt. 37, 172 sqq., 184 sqq.; Jeremias, *Das A. T. im Lichte d. alt. Cit.*, pt. 302 seq.; *Records of the Past*, ii. 109 seq.

⁶ Winckler, *Tell-el-Am. Letters* Nos. 37 sqq.; Petrie, *Syria and Egypt in the Tell of Am. Letters*.

divided; Aradus, Simyra, Sidon supported the rebellion; Ribhabad, the vassal of Byblus, and Abi-melech, king of Tyre, held out for Egypt; but while all the towns made professions of fidelity, they were scheming for their own interests, and in the end Egypt lost them all except Byblus. The tablets which reveal this state of affairs are written in the language and script of Babylonia, and thus show indirectly the extent to which Babylonian culture had penetrated Palestine and Phoenicia; at the same time they illustrate the closeness of the relations between the Canaanite towns and the dominant power of Egypt. After the reign of Amenophis IV. (1370-1366) that power collapsed altogether; but his successors attempted to recover it, and Ramses (Rameses) II. reconquered Phoenicia as far as Beirut, and carved three tablets on the rock beside the Nahr el-Kelb to commemorate his victories; under the XIXth and XXth Dynasties this seems to have remained the northern limit of the Egyptian Empire. But in the reign of Ramses III. (c. 1200) great changes began to occur owing to the invasion of Syria by peoples from Asia Minor and Europe, which ended in the establishment of the Philistines on the coast near Ashkelon. The successors of Ramses III. lost their hold over Canaan; the XXIst Dynasty no longer intervened in the affairs of Syria; but Sheshonk (Shishak), the founder of the XXIInd Dynasty, about 928 B.C. endeavored to assert the ancient supremacy of Egypt (cf. 1 Kings xiv. 25 sqq.), but his successes were not lasting, and, as we learn from the Old Testament, the power of Egypt became henceforward practically ineffective. Not until 608 did a Pharaoh (Necho) lead an Egyptian army so far north, and he was defeated by Nebuchadrezzar. During the period which elapsed before the rise of the Assyrian power in Syria the Phoenicians were left to themselves. This was the period of their development, and Tyre became the leading city of Phoenicia.

Between the withdrawal of the Egyptian rule in Syria and the western advance of Assyria there comes an interval during which the city-states of Phoenicia owned no suzerain. The history of this period is mainly a history of Phoenicia. Tyre, which not only rose to a sort of hegemony among the Phoenician states, but founded colonies beyond the seas (below). From 970 to 772 B.C. the bare outline of events is supplied by extracts from two Hellenistic historians, Menander of Ephesus and Dios (largely dependent upon Menander), which have been preserved by Josephus, *Ant.* viii. 5, 3 and *c. Ap.* i. 17, 18. From the data given in these passages we learn that Hiram I., son of Abi-baal, reigned in Tyre from 970 to 936 B.C. He enlarged the island-town to the east, restored and enriched the temples, built new ones to Heracles (i.e. Melkarth or Melqarth) and Astarte, founded the feast of the awakening of Heracles in the month Peritius, and reduced the inhabitants of Utica to their allegiance. The Tyrian annals, moreover, alluded to the connexion between Hiram and Solomon. Before this time, indeed, the Phoenicians had no doubt lived on friendly terms with the Israelites¹ (cf. Judges v. 17; Gen. xlix. 13); but the two nations seem to have drawn closer in the time of Solomon. 2 Sam. v. 11, which brings David and Hiram together, probably antedates what happened in the following reign. For Solomon's palace and temple Hiram contributed cedar and fir trees as well as workmen, receiving in exchange large annual payments of oil and wine, supplies which Phoenicia must have drawn regularly from Israelite districts (1 Kings v. 9, 11; cf. Ezek. xxvii. 17; Ezr. iii. 7; Acts xii. 20; Jos. *Ant.* xiv. 10, 6); finally, in return for the gold which he furnished for the temple, Hiram received the grant of a territory in Galilee (Cabal, 1 Kings ix. 10-14).² This alliance between the two monarchs led to a

¹ In Judges x. 12 (cf. s. 6, iii. 3) the Sidonians are mentioned among the oppressors of Israel; but there is no record of any invasion of Israel by the Phoenicians, and the statement is due to the post-exilic editor who introduced generalizations of ancient history into the book of Judges.

² Jos. *Ant.* viii. 3, 1, dates the building of Solomon's temple in the 11th year of Hiram, and 420 years after the foundation of Tyre. This gives a Tyrian era which began in 1198-1197 B.C., i.e. at the time when the Philistines settled on the coast of Canaan, an event

joint expedition from Eszongeber on the Gulf of Akaba (strictly: Aqaba) to Ophir (? on the east coast of Arabia, see *OPHIR*) for purposes of trade. The list of Hiram's successors given by Josephus indicates frequent changes of dynasty until the time of Ithobal I. priest of Astarte, whose reign (887-855) marks a return to more settled rule. In contrast to Hiram I., king of Tyre, Ithobal or Ethbaal is styled in 1 Kings xvi. 31 "king of the Sidonians," i.e. of the Phoenicians, showing that in the interval the kings of Tyre had extended their rule over the other Phoenician cities. Under Ethbaal further expansion is recorded; Botrys north of Byblus and Aozai in North Africa are said to have been founded by him; the more famous Carthage owed its origin to the civil discords which followed the death of Metten I. (820), his next successor but one. According to tradition, Metten's son Pygmalion (820-773) slew the husband of his sister Elissa or Dido; whereupon she fled and founded Carthage (*q.v.*) in Libya. (813; Justin xviii. 4-6). At this point Josephus's extracts from Menander come to an end.

From the time of Ethbaal onwards the independence of Phoenicia was threatened by the advance of Assyria. So far back as 1100 B.C. Tiglath-pileser I. had invaded North Phoenicia, and in order to secure a harbour on the coast he occupied Arvad (Aradus); but no permanent occupation followed. In the 9th century, however, the systematic conquest of the west began. In 876 B.C. Assur-nazir-pal III. "washed his weapons in the great sea," and exacted tribute from the kings of Tyre, Sidon, Byblus and other cities, including Arvad (*Keilsinscher. Bibliothek*, i. 109). The inscriptions of his son Shalmaneser II. mention the taking of tribute from the Tyrians and Sidonians in 846 and again in 849; the Byblians are included at the latter date, and among the kings defeated at Karkar in 854 or 853 was Metten-baal, king of the Arvadites (*ibid.* pp. 141, 143, 173). Thus Shalmaneser completed the conquests of his predecessor on the Phoenician coast, and established a supremacy which lasted for over a hundred years and was acknowledged by occasional payments of tribute. In 741 Tiglath-pileser III. mentions on his tribute-lists "Hirmu of Tyre"; and here for the first time a piece of native evidence becomes available. The earliest Phoenician inscription at present known (*CIS*. i. 5-*NSI*. No. 11) is engraved upon the fragments of a bronze bowl dedicated by a certain governor of Qarth-hadasht (or Karti-Hadasti, "New City," i.e. Citium), "servant of Hiram king of the Sidonians to Baal of Lebanon." It is to be noted that this Hiram II. was not only king of Tyre, as the Assyrian inscription calls him, but of Sidon too; and further, that by this time Tyre had established a colony in Cyprus (*q.v.*). In Tiglath-pileser's Philistine campaign of 734 Byblus and Aradus paid tribute, and an Assyrian chief officer (the Rab-shakeh) was sent to Tyre and extorted from the king, now Metten or Mattun, the large sum of 150 talents of gold (*KB*. ii. 23). For the period which follows a certain amount of information is furnished by Menander (in Jos. *Ant.* ix. 14, 2). Elulaeus IX., in Assyrian Luli, who ruled under the name of Pylas, was king of Tyre, Sidon, and other cities at this time (c. 725-690), and at the beginning of his reign suffered from an invasion by Shalmaneser IV. or Salampas (Jos.); this was probably the expedition against Hoshea of Samaria in 725; "the king of Assyria . . . overran all Phoenicia, but soon made peace with them all and returned back." In the reign of Sargon Phoenicia itself seems to have been left alone; but the inhabitants of Citium revolted, showing that the authority of Tyre in Cyprus had grown weak; and Sargon received the submission of seven Cyprian princes, and set up in Larnaca (probably in 700) the triumphal stele now in the Berlin Museum (*Schrader, Cuneif. Inschr. and O. T.*, 2nd ed., vol. ii. p. 87). But Elulaeus, according to Menander, suppressed the revolt of Citium, and early in the reign of Sennacherib joined the league of Philistia and Judah,

which had considerable effect upon the cities of Phoenicia (above, Justin xviii. 3). In the Tyrian annals (*Jos. c. Ap.* i. 18) the reference was probably to the felling of timber in Lebanon for Hiram's temples; Josephus then misinterpreted this by 1 Kings v. 6.

in alliance with Egypt and Ethiopia, which aimed at throwing off the oppressive tyranny of Assyria; as usual, however, the city-states of Phoenicia could not combine even against a common foe, and several broke away from Tyre, so Menander tells us, and sided with Assyria. In the great campaign of 701 Sennacherib came down upon the revolting provinces; he forced Lull, king of Sidon, to fly for refuge to Cyprus, took his chief cities, and set up Tuba'lu (Ethbaal) as king, imposing a yearly tribute (*KB*. ii. 91). The blockade of Tyre by sea, significantly passed over in Sennacherib's inscription, is described by Menander. The island-city proved to be impregnable, but it was the only possession left of what had been the extensive kingdom of Elulæus. Sennacherib, however, so far accomplished his object as to break up the combination of Tyre and Sidon, which had grown into a powerful state.¹ At Sidon the successor of Ethbaal was Abd-milkath; in alliance with a Cilician chief he rebelled against Esarhaddon about the year 678, with disastrous consequences. Sidon was annihilated; Abd-milkath fell into the hands of Esarhaddon, who founded a new Sidon on the mainland, peopled it with foreigners, and called it after his own name. The old name, however, survived in popular usage; but the character of the city was changed, and till the time of Cyrus the kingdom of Sidon ceased to exist (*KB*. ii. 125 seq., 145; *KAT*.² 88). Tyre also came in for its share of hardship. Elulæus was followed by Baal, who in 672 consented to join Tirhaka, the Ethiopian king of Egypt, in a rebellion against Assyria. Esarhaddon, on his way to Egypt for the second time, determined to deal out punishment; he blockaded Tyre, and raised earthworks on the shore and cut off the water-supply; but he did not capture the city itself. His monument found at Zenjirli represents the great king holding Baal of Tyre and Tirhaka of Egypt by cords fastened in their lips;³ there is no evidence, however, that he actually took either of them prisoner. Early in the reign of Assur-bani-pal Tyre was besieged again (668), but Assur-bani-pal succeeded no better than his predecessors. Nevertheless Baal submitted in the end, along with the princes of Gebal and Arvad, Manassch of Judah, and the other Canaanite chiefs; in the island of Cyprus the Assyrians carried all before them (*KB*. ii. 149 seq., 169, 173). On his return from the Arabian campaign Assur-bani-pal severely punished the rebellious inhabitants of Ushu (Palaetyrus) and Akko, and transported the survivors to Assyria (*ibid.* 229). In Phoenicia, as elsewhere, Assyrian rule created nothing and left nothing behind it but a record of barbarous conquest and extortion. An interesting sidelight is thrown upon this period by the list of the Thalassocracies in the *Chronicon* of Eusebius (p. 226, ed. Schoene), which places the 45 years of the sea-power of Phoenicia at a date which, with much probability, may be conjectured to lie between 700, when Cyprus submitted to Sargon, and 664, when Egypt threw off the rule of Assyria. If this dating is correct, and the Phoenician sea-power was at its height during these years, we can understand why Tyre gave so much trouble to the Assyrian kings.⁴

In the last crisis of the dying power of Assyria the Egyptians for a short time laid hands on Phoenicia; but after their defeat at the battle of Carchemish (605), the Chaldeans *The Neo-Babylonians* became the masters of western Asia. Jeremiah's *Parable, 688*-allusion (xxv. 22) in 604 to the approaching downfall of the kings of Tyre and Sidon and the coast-land beyond the sea, i.e. the Phoenician settlements on the Mediterranean, seems to imply that the Phoenician states recovered some measure of independence; if they did it cannot have lasted long. In 588 Apries (Pharaoh Hophra) made an attempt

¹ The above interpretation of Menander and the Assyrian evidence is based upon Ed. Meyer, *Ency. Bib.* col. 3755. For a different explanation see Landau, *Beitr. z. Altertumsk. d. Or.* vol. i., followed by Winckler, *Allor. Forsch.* ii. 65 seq.; these scholars take Menander to refer to the later war of Esarhaddon and Assur-bani-pal against Baal of Tyre.

² See the facsimile in *Ausgrabungen in Sendschirli* (Berlin, 1893), and p. 17 for the above interpretation of it.

³ John L. Myers, *Journ. Hell. Studies* (1906), xxvi. 84 seq., criticizing Winckler, *Der Alte Orient* (1905), vol. vii. pt. 2.

to displace the Chaldaean supremacy; he defeated Tyre and Sidon, and terrorized the other cities into submission (*Herod.* ii. 161; *Diod. Sic.* i. 68). Some of the Phoenician chiefs, among them Ithobal II., the new king of Tyre, while forced to yield to a change of masters, were bold enough to declare their hostility to the Babylonians. This state of affairs did not escape the vigilance of Nebuchadrezzar. After the fall of Jerusalem he marched upon Phoenicia; Apries withdrew his army, and the siege of Tyre began. For thirteen years the great merchant city held out (585-573; *Jos. c. Ap.* i. 21; cf. *Ezek.* xxvi. 1 seq.). Ezekiel says that Nebuchadrezzar and his host had no reward for their heavy service against Tyre, and the presumption is that the city capitulated on favourable terms; for Ithobal's reign ends with the close of the siege, and the royal family is subsequently found in Babylon. The king appointed by Nebuchadrezzar was Baal II. (574-564), after whose death a republic was formed under a single suffete or "judge" (*shôfê*). Josephus (*Jos. Ant.*) is again our authority for the changes of government which followed until the monarchy was revived. At length under Hiram III. Phoenicia passed from the Chaldaeans to the Persians (538), and at the same time Amasis (Ahmosi) II. of Egypt occupied Cyprus (*Herod.* ii. 182). There seems to have been no struggle; the great siege and the subsequent civil disorders had exhausted Tyre, and Sidon took its place as the leading state. About this time, too, Carthage made an effort for independence under Hanno the Great (538-521), the real founder of its fortunes; the old dependence upon Tyre was changed for a mere relation of piety observed by the annual sending of delegates (*theopoi*) to the festival of Melkarth (*Arrian* ii. 24; *Polyb.* xxxd. 20, 12). The disasters and humiliations which befell Tyre during this and the foregoing period might suggest that its prosperity had been seriously damaged. But Tyre always counted for more in commerce than in politics; and in the year 586, just before the great siege, Ezekiel draws a vivid picture (ch. xxvii.) of the extent and splendour of its commercial relations. Even when cut off from its possessions on the mainland the city itself was not captured; its seafaring trade went on; and though by degrees the colonies were lost, yet the ties of race and sentiment remained strong enough to bind the Phoenicians of the mother-country to their kindred beyond the seas.

Constitution.—At this point it is convenient to mention what little is known about the constitution of the Phoenician states. All Canaanite analogy speaks for kingship as the oldest form of Phoenician government. In the native inscriptions the chief of the city in Phoenicia itself and in Cyprus is always called king. The royal houses claimed divine descent,⁵ and the king could not be chosen outside their members. His power, however, was limited by the wealthy merchant families, who possessed great influence in public affairs; thus it was possible for war or peace to be decided at Tyre in the king's absence, or at Sidon against his will (*Arrian* ii. 15 and 16; *Curtius* iv. 1, 15). The priest of Melkarth at Tyre was the second man in the kingdom. Associated with the prince was a council of elders; such was the case at Gebal (Byblus) from the earliest times to the latest (*Ezek.* xxvii. 9); at Sidon this council consisted of 100 members (*Diod.* xvi. 45), perhaps also at Tyre.⁶ Inscriptions of the 3rd and 2nd centuries B.C. mention a *Rab* (chief) in Sidon, Cyprus and Gaulus (Gozo); what his position was it is difficult to say; in the colonies he may have been a district governor. During Nebuchadrezzar's time, as we have seen, a republic took the place of the monarchy at Tyre, and the government was administered by a succession of suffetes (judges); they held office for short terms, and in one instance two ruled together for six years. Much later, in the 3rd century B.C., an inscription from Tyre mentions a suffete (*NSI.* No. 8) without adding more to our knowledge. Carthage, of course, was governed by two suffetes, and these officers are frequently named in connexion with the Carthaginian colonies (*NSI.* p. 113 seq.); but we must be careful not to draw the inference that Phoenicia itself had any such magistracies. Under the Persians a federal bond was formed comprising Sidon, Tyre and Aradus, whose duty it was to contribute 300 talents to the Persian fleet (*Herod.* vii. 89),

⁵ So the Babylonians, Canaanites (e.g. in the case of the Nephilim, *Gen.* vi. 2), Arabs, Greeks, traced the descent of heroic families to the gods. W. R. Smith, *Kingship and Marriage*, p. 206; S. I. Curtis's *Primitive Sem. Rel. Today* (London, 1902), p. 112 seq.

⁶ An inscr. from Tyre may be read, "Abd bal' chief of the Hundred," *NSI.* p. 129; Clermont-Ganneau, *Recueil d'arch.* or. ii. 294 seq.

the lesser towns being under the command of the great cities. Aradus presided over three subordinate townships (Arrian ii. 13); Berytus, which had no king of its own, probably formed with Byblus a single kingdom; while Tripolis consisted of a federation of three cities separated by a stadium from each other, and provided a meeting-place for the federal council, which was chiefly occupied in dealings with the Persian government (Diod. xvii. 41). But federation on a larger scale was never possible in Phoenicia, for the reason that no sense of political unity existed to bind the different states together. Commercial interests dominated everything else, and while these stimulated a municipal life not without vigour, civil discipline and loyalty were but feebly felt. On occasion the towns could defend their independence with strenuous courage; the higher qualities which make for a progressive national life the Phoenicians did not possess.

Phoenicia now became part of the fifth satrapy of the Persian Empire, and entered upon a spell of comparative peace and *The Persian* growing prosperity. Favored for the sake of *Period, 440-333* their fleet, and having common interests against *444 B.C.* Greece,¹ the Phoenicians were among the most loyal subjects of the empire. At this period Sidon occupied the position of leading state; in the fleet her king ranked next to Xerxes and before the king of Tyre (Herod. viii. 67); her situation afforded advantages for expansion which Tyre on its small and densely populated island could not rival. The city was distinguished by its cosmopolitan character; the satrap resided there when he came to Phoenicia, and the Persian monarch had his paradise outside the walls. In the first half of the 4th century Straton I. (in Phoen. 'Abd-asharti or Bod-asharti) was king, c. 374-362. He cultivated friendly relations with Athens, indicated in a decree of *protesia* (Michel, *Rec. d'inscr. gr. No. 93 = CIG. No. 87*); his court was famed for its luxury; and the extent to which phil-Hellenic tendencies prevailed at this time in Sidon is shown by the royal sarcophagi, noble specimens of Greek art, which have been excavated in the necropolis of the city. It was in the reign of Straton that Tyre fell into the hands of Evagoras, king of Salamis, who had already supplanted Phoenician with Greek civilization in Cyprus (Isocr. *Evag. 62, Pomeg. 161*; Diod. xv. 2). Straton made friends with Nicocles, son of Evagoras, and with him came to an untimely end through their implication in the great revolt of the satraps, 362 B.C. (see the story of Straton's death in Jerome, *adv. Jovin. i. 45*). A new revolt of Sidon against the Persians took place under King Tennes owing to the insults offered to the Sidonians at the federal diet in Tripolis. With the aid of Nectanebus of Egypt, who had grievances of his own to avenge, the Sidonians carried the rest of Phoenicia with them and drove the satraps of Syria and Cilicia out of the country. Tennes, however, betrayed his people and opened the city to Artaxerxes III.; the inhabitants to the number of 40,000 are said to have set fire to their houses and perished; Tennes himself was executed after he had served the ends of the great king (346 B.C.; Diod. xvi. 41-45). The last king of Sidon was Straton II. ('Abd-asharti, 346-332) before the Persian Empire came to an end.²

Towards the close of the 5th century the Phoenician coins begin to supplement our historical sources (see ΝΟΜΙΣΜΑΤΙΚΑ). From the time of Darius the Persian monarchs issued a gold coinage, and reserved to themselves the right of doing so; but they allowed their satraps and vassal states to coin silver and copper money at discretion. Hence Aradus, Byblus, Sidon and Tyre issued a coinage of their own, of which many specimens exist: the coins are stamped as a rule with emblem or name of the city, sometimes with the name of the ruler.³ Thus from the coins of Byblus we learn the names of four kings, 'El-pa'al, 'Az-ba'al (between 350 and 340 B.C.), Adar-melek, 'Ain-el; from the coins of the other cities it is difficult

¹ The naval expeditions against Greece in 480-449 and Sparta in 396-387 were mainly fitted out by Phoenicia. See PERSIA: *Ancient History*, for the whole of this section.

² Justin xviii. 3 tells a story about Tyre during this period: the city, after being worn out though not defeated in long wars with the Persians, was so enfeebled that it was seized by the slaves, who rose and massacred their masters; one Straton alone escaped and was afterwards made king. The reference to the Persians is obviously incorrect; the story, if it can be taken seriously at all, must refer to one of the sieges by the Assyrians or Chaldeans, and, as Meyer suggests (*Ency. Bib. col. 3760*), may be derived from the story of Abdalonimus of Sidon mentioned below.

³ See especially E. Babelon, *Les Perses Achéménides*, and cf. *NSI. No. 119*.

to obtain much information. The native inscriptions, however, now become available, though most of them belong to the period which follows, and only a few have been discovered in Phoenicia itself. One of the earliest of these is the inscription of Byblus (*CIS. i. 1 = NSI. No. 3*), dating from the Persian period; it records a dedication made by Yehaw-milk, king of Gebal, and mentions the name of the king's grandfather, Uri-milk, but the exact dates of their reign are not given.

When Alexander the Great entered Phoenicia after the battle of Issus (333 B.C.), the kings were absent with the Persian fleet in the Aegean; but the cities of Aradus, Byblus and The Sidon welcomed him readily, the last-named showing *Macondonius* special zeal against Persia. The Tyrians also offered *Period, 333-69 B.C.* submission, but refused to allow the conqueror to enter the city and sacrifice to the Tyrian Heracles. Alexander was determined to make an example of the first who should offer opposition, and at once began the siege. It lasted seven months. With enormous toil the king drove out a mole from the mainland to the island and thus brought up his engines; ships from the other Phoenician towns and from Cyprus lent him their aid, and the town at length was forced in July 332; 8000 Tyrians were slain, 30,000 sold as slaves, and only a few notables, the king Azemilkos, and the festal envoys from Carthage who had taken refuge in the sanctuary of Melkarth, were spared (Diod. xvii. 40-46). It is not unlikely that Zech. ix. 2-4 refers to this famous siege. For the time Tyre lost its political existence, while the foundation of Alexandria presently changed the lines of trade, and dealt a blow even more fatal to the Phoenician cities.

During the wars of Alexander's successors Phoenicia changed hands several times between the Egyptian and the Syrian kings. Thus in 312 Tyre was captured from Antigonos by Ptolemy I., the ally of Seleucus; in 287 it passed into the dominion of Seleucus; in 275 again it was captured by Ptolemy II. Philadelphus, and began to recover itself as an autonomous municipality. From the year 275 "the people of Tyre" reckoned their era (*CIS. i. 7 = NSI. No. 9, cf. 10*). The Tyrian coins of the period, stamped with native, Greek and Egyptian symbols, illustrate the traditional relations of the city and the range of her ambitions. A special interest attaches to these silver tetradrachms and didrachms (staters and half-staters), because they were used by the Jews for the payment of the temple tax as "shekels of the sanctuary" (*NSI. pp. 351, 44*).

Among the Phoenician states we know most about Sidon during this period. The kingship was continued for a long time. The story goes that Alexander raised to the throne a member of the royal family, Abdalonimus, who was living in obscure poverty and working as a gardener (Justin xi. 10; Curt. iv. 1; Diod. xvii. 47 wrongly connecting the story with Tyre). In 312 Ptolemy, then master of Phoenicia, appointed his general Philocles king of the Sidonians, and a decree in honour of this king has been found at Athens (Michel, *No. 387, cf. 1261*); but he cannot have reigned long. For at the end of the 4th and the beginning of the 3rd century we have evidence of a native dynasty in the important inscriptions of Tabnith, Eshmun-azar and Bod-asharti, and in the series of inscriptions (repeating the same text) discovered at Bostan esh-Shekh near Sidon (*NSI. Nos. 4, 5, 6 and App. i.*)⁴ The last-named texts imply that the first king of this dynasty was Eshmun-azar; his son Tabnith succeeded him, then came Eshmun-azar II., who died young, then Bod-asharti, both of them grandsons of Eshmun-azar I. With Bod-asharti, so far as we know, the dynasty came to an end, say about 250 B.C.; and it is not unlikely that the Sidonians reckoned an era of independence from this event (*NSI. p. 95 n.*).

Of the other Phoenician cities something is known of the history of Aradus. Its era began in 259 B.C., when it probably became a republic or free city. While the rest of Phoenicia passed under the

⁴ The date of this dynasty has been much disputed; but the reference to "the lord of kings" in the great inscr. of Eshmun-azar (line 18) points to the Ptolemaic period, for the Persian monarch is always styled "king of kings." The interpretation of many details of the inscr. from Bostan esh-Shekh is still uncertain.

rule of Ptolemy II. and his successors between 281 and 197, Aradus remained in the kingdom of the Seleucida, who greatly favoured the city and increased its privileges (Strabo xvi. 2, 14; Polyb. v. 68). But its subject-towns availed themselves of the political changes of the period to throw off their allegiance; Marathus from 278 begins to issue a coinage bearing the heads of the Ptolemies, and later on Karne asserted its independence in the same way; but in the end the Aradians recovered their supremacy. Diodorus records a barbarous attempt made by the Aradians, about 148 B.C. to destroy Marathus, which was frustrated by the pity and courage of an Aradian fisherman (xxiii. 5). At last in the time of Tigranes, the Armenian holder of the kingdom of the Seleucida, or soon afterwards, the coins of Marathus cease; the city was levelled to the ground, and its land, with that of Simyra, was parcelled out among the Aradians (Strabo xvi. 2, 12). Akko issued coins of its own down to 267 B.C., if the reckoning was from the Seleucid era (312 B.C.); in 267 it was converted into a Greek city by Ptolemy, and called Ptolemais (Polyb. iv. 37; Strabo xvi. 2, 25; cf. Acts xiii. 7). Laodicea of Libanus was founded by Seleucus Nicator on the plain south-east of Hemesa (Homs) in the region of the upper Orontes, and became an important city; its coins of the 2nd century B.C. bear the interesting legend in Phoenician, "Of Laodicea which is in Canaan" (*NSI*, p. 349 seq.). Another Laodicea "by the sea" (*ad mare*), also of Seleucid foundation, is probably to be identified with the ruined site called Umm el-'Awamid near the coast between Tyre and Akko; several Phoenician inscriptions have been found there (e.g. *CIS*, i. 7 = *NSI*, No. 9; Clermont Ganneau, *Revue*, t. v.).

After the death of Antiochus IV. Epiphanes in 164 B.C., revolts and adventurers made their appearance in many parts of Syria, heralding the collapse of the kingdom of the Seleucids. Berytus was destroyed by the usurper Trypho in 140 B.C. Tyre in 120 and Sidon in 111 received complete independence, and inaugurated new eras from these dates. Byblus and Tripolis fell into the hands of "tyrants" (Strabo xvi. 2, 18; Jos. *Ant.* xiv. 3, 2), and Arab robbers plundered their territories from strongholds in the Lebanon. From 83-69 B.C. the entire kingdom was held by the Armenian Tigranes.

At last in 64 B.C. Pompey arrived upon the scene and established order out of chaos. Phoenicia was incorporated into the Roman province of Syria; Aradus, Sidon, Tyre and Tripolis were confirmed in their rights of self-government and in the possession of their territories. In 14 B.C.

Augustus rebuilt Berytus as a Roman colony and stationed two legions there; later on Ptolemais, Tyre and Sidon received colonial status. Under the beneficent government of Rome the chief towns prospered and extended their trade; but the whole character of the country underwent a change. During the Macedonian period Greek influences had been steadily gaining ground in Phoenicia; relations with the Greek world grew closer; the native language fell into disuse, and from the beginning of the Roman occupation Greek appears regularly in inscriptions and on coins, though on the latter Phoenician legends do not entirely vanish till the 2nd century A.D.; while the extent to which Hellenic ideas penetrated the native traditions and mythologies is seen in the writings of Philo of Byblus. For the purposes of everyday life, however, the people spoke not Greek, but Aramaic. As elsewhere, the Roman rule tended to obliterate characteristic features of national life, and under it the native language and institutions of Phoenicia became extinct.

Navigation, Trade, Colonies.—The Phoenicians were essentially a seafaring nation. Fearless and patient navigators, they ventured into regions where no one else dared to go, and, always with an eye to their monopoly, they carefully guarded the secrets of their trade routes and discoveries, and their knowledge of winds and currents. At the beginning of the 7th century B.C. a Phoenician fleet is said to have circumnavigated Africa (Herod. iv. 42). To the great powers Phoenician ships and sailors were indispensable; Sennacherib, Psammetichus and Necho, Xerxes, Alexander, all in turn employed them for their transports and sea-fights. Even when Athens had developed a rival navy Greek observers noted with admiration the discipline kept on board the Phoenician ships and the skill with which they were handled (*Xén. Oec.* viii.); all the Phoenician vessels from the round merchant-boat (*γαλιός*—after which the island of Gaul, now Gozo, near Malta was called) to the great Tarshish-ships, the "East-Indiamen" of the ancient world, excelled those of the Greeks in speed and equipment. As E. Meyer points out,

the war between the Greeks and the Persians was mainly a contest between the sea-powers of Greece and Phoenicia. At what period did Phoenicia first rise to be a power in the Mediterranean? We are gradually approaching a solution of this obscure problem. Recent discoveries in Crete (*q.v.*) have brought to light the existence of a Cretan or "Minoan" sea-power of remote antiquity, and it is clear that a great deal of what used to be described as Phoenician must receive quite a different designation. The Minoan sea-power was at last broken up by invaders from the north, and a Carian rule became dominant in the Aegean (Herod. i. 171; Thucyd. i. 4, 8). It was a time of disorder and conflict due to the immigration of new races into the ancient seats of civilization, and it synchronised with the weakening of the power of Egypt in the countries which bordered on the eastern Mediterranean. This was in the 12th century B.C. The Tyrian trader saw that his opportunity was come, and the Aegean lay open to his merchant vessels. Where much is still obscure, all that seems certain is that the antiquity of Phoenicia as a sea and trading power has been greatly exaggerated both in ancient and in modern times; the Minoan power of Cnossus preceded it by many centuries; the influence of Phoenicia in the Aegean cannot be carried back much earlier than the 12th century B.C., and, comparatively speaking, it was "foreign, late, sporadic."

A vivid description of the Phoenicians' trade at the time of Tyre's prosperity is given by Ezekiel (xxvii. 12-25), and it shows how extensive were their commercial relations not only by sea, but by land as well. It was they who distributed to the rest of the world the wares of Egypt and Babylonia (Herod. i. 1). From the lands of the Euphrates and Tigris regular trade-routes led to the Mediterranean with trading-stations on the way, several of which are mentioned by Ezekiel (xxvii. 23). In Egypt the Phoenician merchants soon gained a foothold; they alone were able to maintain a profitable trade in the anarchic times of the XXIIInd and XXIIIrd Dynasties (825-650 B.C.), when all other foreign merchants were frightened away. Though there were never any regular colonies of Phoenicians in Egypt, the Tyrians had a quarter of their own in Memphis (Herod. ii. 112). The Arabian caravan-trade in perfume, spices and incense passed through Phoenician hands on its way to Greece and the West (Herod. iii. 107); these articles of commerce were mainly produced not in Arabia, but in East Africa and India, and the trade had its centre in the wealthy state of Sheba in Yemen. Between Israel and Phoenicia the relations naturally were close; the former provided certain necessities of life, and received in exchange articles of luxury and splendour (Ezek. xxvii. 16-18).¹ Israelite housewives sold their homespun to Phoenician pedlars (*Prov.* xxxi. 24 R.V.M.); in Jerusalem Phoenician merchants and money-lenders had their quarter (*Zeph.* i. 11), and after the Return we hear of Tyrians selling fish and all manner of wares in the city (*Neh.* xiii. 16), and introducing other less desirable imports, such as foreign cults (*Isa.* lxxv. 11). The Phoenician words which made their way into Greek at an early period indicate the kind of goods in which the Phoenicians traded with the West, or made familiar through their commerce; the following are some of them—*χρυσός*, *λίλιον*, *βύσσος*, *κόκκινος*, *μάλλιον*, *κόκκος*, *κόκκος*, *μαῖ*, *παλάξις*, *βασιλικός*. Another valuable article of commerce which the Phoenicians brought into the market was amber. They can hardly have fetched it themselves from the Baltic or the North Sea; it came to them by two well-marked routes, one from the Baltic to the Adriatic, the other up the Rhine and down the Rhone. A deposit of amber has also been found in the Lebanon, and perhaps the Phoenicians worked this and concealed its origin.

¹ Burrows, *Discoveries in Crete* (1907), 140 sqq. It may be noted that the traditional or conjectural dates based upon the list of the Thalassocracies preserved by Eusebius carry us back to the 12th century B.C. See Professor John L. Myres's essay referred to above, § 11 (4).

² See Eupolemus (140-100 B.C.) quoted by Alexander Polyhistor, who, in a supposed letter from Solomon to the king of Tyre, mentions the food-supplies required by the Tyrians and promised from Palestine (*Fr. Hist. Gr.* iii. 226).

The Phoenician colonies were all supposed to have been founded from Tyre: with regard to the colonies in Cyprus and north Africa this was undoubtedly true. Cyprus possessed resources of timber and copper which could not fail to tempt the keen-eyed traders across the water, who made Citium (from Kittim, the name of the original non-Semitic inhabitants) their chief settlement, and thence established themselves in Idaliu, Tamassus, Lapethus, Larnaka, Qarth-hadašt (Karti-hadašt) and other towns. In the inscriptions of the 4th to 3rd centuries, the Phoenician potentates in the island call themselves "kings of Kition and Idalion" (*NSI*, pp. 55-89). But the Phoenician rule was not so ancient as used to be supposed. At an early period Greeks from the south coast of Asia Minor had settled in Cyprus before the Phoenicians founded any colonies there; and it is noticeable that in the Assyrian tribute-lists of the latter half of the 7th century (*KB*, ii, pp. 149, 241) not one of the ten Cyprian kings mentioned appears to be Phoenician by name. Menander states (*Jos. Ant.* ix. 14, 2) that the kings of Tyre ruled over Cyprus at the close of the 8th century; but a clear proof that the Phoenician rule was neither ancient nor uninterrupted is given by the fact that the Cyprian Greeks took the trouble to invent a Greek cuneiform character (*Cypricote*) modelled on the Assyrian.

Homer represents the Phoenicians as present in Greek waters for purposes of traffic, but not as settlers (*Il.* xxiii. 744). They occupied trading-stations on some of the Aegean islands and on the Isthmus of Corinth. One of their objects was the collection of murex, of which an enormous supply was needed for the dyeing industry; specially famous was the purple of the Laconian waters, the isles of Elishah of Ezek. xxvii. 7. But a great deal of what was formerly assigned to Phoenician influence in the Aegean at an early period—pottery, ornaments and local myths—must be accounted for by the vigorous civilization of ancient Crete. In the Greek world the Phoenicians made themselves heartily detested; their characteristic passion for gain (*ῥό φιλοχρηματων*, Plato, *Rep.* iv. 435 E.) was not likely to ingratiate them with those who were compelled to make use of their services while they suffered from their greed.

Farther west in the Mediterranean Phoenician settlements were planted first in Sicily, on the south coast, at Heraclea or Ras Melqarth; the islands between Sicily and Africa, Melita (Malta) on account of its valuable harbour, Gaultus and Cossura were also occupied (*Diod.* v. 12); and a beginning was made with the colonization of Sardinia and Corsica; but farther west still, and on the Atlantic coasts to the right and left of the straits, more permanent colonies were established. It was the trade with Tarshish, i.e. the region of Tartessus in south-west Spain, which contributed most to the Phoenicians' wealth; for in this region they owned not only profitable fisheries, but rich mines of silver and other metals. The profits of the trade were enormous; it was said that even the anchors of ships returning from Spain were made of silver (*Diod.* v. 35). From Gadeira (*Punic Gādēr*, Lat. *Gades*, now Cadiz), the town which they built on an island near the mouth of the Guadalquivir, the Sidonian ships ventured farther on the ocean and drew tin from the mines of north-west Spain or from the richer deposits in the Cassiterides, i.e. the Tin Islands. These were discovered to be, not a part of Britain as was imagined at first, but a separate group by themselves, now known as the Scillies; hence it is improbable that the Phoenicians ever worked the tin-mines in Cornwall.

The rich trade with Spain led to the colonization of the West. Strabo dates the settlements beyond the Pillars of Hercules soon after the Trojan War (i. 3, 2), in the period of Tyre's first expansion. Likus in Mauretania, Gades and Utica, are said to have been founded, one after the other, as far back as the 12th century B.C. Most of the African colonies were no doubt younger; we have traditional dates for Aozza (887-855) and Carthage (813). A large part of North-west Africa was colonized from Phoenicia; owing to these first settlers, and after them to the Carthaginians, the Phoenician language became the prevailing one, just as Latin and Arabic did in later times, and the country assumed quite a Phoenician character.

In the days of Tyre's greatness her power rested directly on the colonies, which, unlike those of Greece, remained subject to the mother-city, and paid tithes of their revenues to its chief god, Melqarth, and sent envoys annually to his feast. Then at the beginning of the 8th century B.C. the colonial power of Tyre began to decline; on the mainland and in Cyprus the Assyrians gained the upper hand; in the Greek islands the Phoenicians had already been displaced to a great extent by the advancing tide of Dorian colonization. But as Tyre decayed in power the colonies turned more and more to Carthage as their natural parent and protector. For effective control over a colonial empire Carthage had the advantage of situation over far-away Tyre; the traditional bonds grew lax and the ancient dues ceased to be paid, though as late as the middle of the 6th century Carthage rendered tithes to the Tyrian Melqarth. And the mother-country cherished its claims long after they had lost reality; in the 2nd century B.C., for example, Sidon stamped her coins with the legend, "Mother of Kambē (i.e. Carthage), Hippo, Kition, Tyre" (*NSI*, p. 352).

Manufactures, Inventions, Art.—From an early date the towns of the Phoenician coast were occupied, not only with distributing the merchandise of other countries but with working at industries of their own; especially purple-dyeing and textile fabrics (*Il.* vi. 289 sqq.), metal work in silver, gold and electrum (*Il.* xxiii. 741 sqq.; *Od.* iv. 615 sqq., xv. 458 sqq.), and glass-work, which had its seat at Sidon. The iron and copper mines of Cyprus (not Sidon, as Homer implies, *Od.* xv. 424) furnished the ore which was manufactured into articles of commerce.¹ Egyptian monuments frequently mention the vessels of gold and silver, iron and copper, made by the Dahi, i.e. the Phoenicians (*W. M. Müller, As. u. Eur.* 306); and in Cyprus and at Nimrud bronze and silver paterae have been found, engraved with Egyptian designs, the work of Phoenician artists (see tables C and D in the Nimrud gallery of the Brit. Mus.). The invention of these various arts and industries was popularly ascribed to the Phoenicians, no doubt merely because Phoenician traders brought the products into the market. But dyeing and embroidery probably came from Babylon in the first instance; glass-making seems to have been borrowed from Egypt; the invention of arithmetic and of weights and measures must be laid to the credit of the Babylonians. The ancients believed that the Phoenicians invented the use of the alphabet (e.g. Pliny, *N.H.* v. 13, cf. vii. 57; Lucan, *Bell. Civ.* iii. 220 sqq.); but it is unlikely that any genuine tradition on the subject existed, and though the Phoenician theory has found favour in modern times it is open to much question. The Phoenicians cannot be said to have invented any of the arts or industries, as the ancient world imagined; but what they did was something hardly less meritorious: they developed them with singular skill, and disseminated the knowledge and use of them.

The art of Phoenicia is characterized generally by its dependence upon the art of the neighbouring races. It struck out no original line of its own, and borrowed freely from foreign, especially Egyptian, models. Remains of sculpture, engraved bronzes and gems, show clearly the source to which the Phoenician artists went for inspiration; for example, the uraeus-frieze and the winged disk, the *ankh* or symbol of life, are Egyptian designs frequently imitated. It was in the times of the Persian monarchy that Phoenician art reached its highest development, and to this period belong the oldest sculptures and coins that have come down to us. A characteristic specimen of the former is the stele of Yehaw-milk, king of Gebal (*CIS*, i. 1), in which the king is represented in Persian dress, and the goddess to whom he is offering a bowl looks exactly like an Egyptian Isis-Hathor; the inscription mentions the various objects of bronze and gold, engraved work and temple furniture, which the king dedicated. The whole artistic movement in Phoenicia may be divided into two great periods: in the first, from the earliest times to the 4th century B.C., Egyptian influence and then Babylonian or Asiatic influence is predominant, but the national element is strongly marked; while in the second, Greek influence has obtained the mastery, and the native element, though making itself felt, is much less obtrusive. Throughout these periods works of art, such as statues of the gods and sarcophagi, were imported direct at first from Egypt and afterwards mainly from Rhodes. The oldest example of native sarcophagi are copied from Egyptian mummy-cases, painted with colours and ornamented with carvings in low relief; towards and during the Greek period the contours of the body begin to be marked more clearly on the cover. The finest sarcophagi that have been found in the necropolis of Sidon (now in the Imperial Museum, Constantinople) are not Phoenician at all, but exquisite specimens of Greek art. The Phoenicians spent much care on their burial-places, which have furnished the most important

¹Traces of ancient mining for iron have been found in the Lebanon; cf. LXX. 1 Kings ii. 46c (ed. Swete), which has been taken to refer to this quarrying in search of iron; Jer. xv. 12. See Benzinger on 1 Kings ix. 19.

monuments left to us. The tombs are subterranean chambers of varied and often irregular form, sometimes arranged in two storeys, sometimes in several rows one behind the other. While in early times a mere perpendicular shaft led to these excavations, at a later date stairs were constructed down to the chambers. The dead were buried either in the floor (often in a sarcophagus), or, according to later custom, in niches. The mouths of the tombs were walled up and covered with slabs, and occasionally cippi (Phoen. *masšebēth*) were set up to mark the spot. The great sepulchral monuments, popularly called *magdāsil*, i.e. "spindles," above the tombs near Amrit, have peculiarities of their own; some of them are adorned with lions at the base and with roofs of pyramidal shape. Besides busts and figurines, which belong as a rule to the Greek period, the smaller objects usually found are earthen pitchers and lamps, glass-ware, tesserae and gems. Of buildings which can be called architectural few specimens now exist on Phoenician soil, for the reason that for ages the inhabitants have used the ruins as convenient quarries. Not a vestige remains of the great sanctuary of Melqarth at Tyre; a few traces of the temple of Adonis near Byblos were discovered by Renan, and a peculiar mausoleum, Buri al-Bazzān, is still to be seen near Amrit; recent excavations at Bostan esh-Shekh near Sidon have unearthed parts of the enclosure or foundations of the temple of Eshmun (*NSJ*, p. 401); the conduits of Ras el-'Ain, south of Tyre, are considered to be of ancient date. With regard to the plan and design of a Phoenician temple, it is probable that they were in many respects similar to those of the temple at Jerusalem, and the probability is confirmed by the remains of a sanctuary near Amrit, in which there is a cella standing in the midst of a large court hewn out of the rock, together with other buildings in an Egyptian style. The two pillars before the porch of Solomon's temple (1 Kings vii. 21) remind us of the two pillars which Herodotus saw in the temple of Melqarth at Tyre (*Herod.* ii. 44), and of those which stood before the temples of Paphos and Hierapolis (see W. R. Smith, *Rel. of Sem.* p. 468 seq.).

Religion.—Like the Canaanites of whom they formed a branch, the Phoenicians connected their religion with the great powers and processes of nature.¹ The gods whom they worshipped belonged essentially to the earth; the fertile field, trees and mountains, headlands and rivers and springs, were believed to be inhabited by different divinities, who were therefore primarily local, many in number, with no one in particular supreme over the rest. It seems, however, that as time went on some of them acquired a more extended character; thus Ba'al and Astarte assumed celestial attributes in addition to their earthly ones, and the Tyrian Melqarth combined a celestial with a marine aspect.² The gods in general were called *elōhim*; *elīm*; Plautus uses *alominum valonith* for "gods and goddesses"; (*Poen.* v. 1. 1). These plurals go back to the singular form 'El, the common Semitic name for God; but neither the singular nor the plural is at all common in the inscriptions (*NSJ*, pp. 24, 41, 51); 'El by itself has been found only once³ the fem. 'Elath is also rare (*ibid.* pp. 135, 158). The god or goddess was generally called the Ba'al or Ba'alath of such and such a place, a title which was used not only by the Canaanites, but by the Aramaeans (Be'el) and Babylonians (Bel) as well. There was no one particular god called Baal; the word is not a proper name but an appellative, a description of the deity as *owner* or *mistress*; and the same is the case with Milk or Melek, 'Adon, 'Ammā, which mean *king*, *lord*, *mother*. The god himself was unnamed or had no name. Occasionally we know what the name was; the Baal of Tyre was Melqarth (Melkarth), which again means merely "king of the city"; similarly among the Aramaeans the Ba'al of Harran was the moon-god Sin. As each city or district had its own Ba'al, the author of its fertility, the "husband" (a common meaning of *ba'al*) of the land which he fertilized, so there were many Ba'als, and the Old Testament writers could allude to the Ba'alim of the neighbouring Canaanites. Sometimes the god received a distinguishing attribute which indicates an association not with any particular place, but with some special characteristic; the most common forms are Ba'al-hammūn, the chief deity of Punic north Africa, perhaps "the glowing Ba'al," the god of fertilizing warmth, and Ba'al-shamēm, "Ba'al of the heavens."

The latter deity was widely venerated throughout the North-Semitic world; his name, which does not appear in the Phoenician inscriptions before the 3rd century B.C., implies perhaps a more universal conception of deity than existed in the earlier days.⁴

¹ Cf. Hannibal's oath to Philip of Macedon; beside the named deities he invokes the gods of "sun and moon and earth, of rivers and meadows and waters" (*Polyb.* vii. 9).

² This is well brought out by G. F. Hill, *Church Quarterly Rev.* (April 1908), pp. 118-141, who specially emphasizes the evidence of the Phoenician coins.

³ "To the lord 'El, which Ba'al-shillem . . . vowed," &c.; Clermont-Ganneau, *Revue*, v. 376.

⁴ Probably "the detested thing that causes horror" (עוֹר פֶּה) of Dan. xii. 11, xi. 31, &c., is an intentional disfigurement of עוֹר יָצָא.

The name has been found on an important Aramaic inscr. from North Syria, dating c. 800 B.C., in which Zālūr, king of Hamath and La'ash frequently speaks of his god Be'el-shamīn (*Pognon, Inscr. sem. de la Syrie*, 1908).

The worship of the female along with the male principle was a strongly marked feature of Phoenician religion. To judge from the earliest evidence on the subject, the Ba'alath of Gebal or Byblos, referred to again and again in the Amarna letters (*Bilis to Gubla*, Nos. 55-110), must have been the most popular of the Phoenician deities, as her sanctuary was the oldest and most renowned. The *mistress of Gebal* was no doubt 'Ashtart (Astarte in Greek, 'Ashtōrēth in the Old Testament, pronounced with the vowels of *ōshēth*, "shame"), a name which is obviously connected with the Babylonian Ishtar, and, as used in Phoenician, is practically the equivalent of "goddess." She represented the principle of fertility and generation; references to her cult at Gebal, Sidon, Ashkelon, in Cyprus at Kiton and Paphos, in Sicily at Eryx; in Gauls; at Carthage, are frequent in the inscriptions and elsewhere. The common epithets *Kēphē* and *Kēphēa* (of Kuthera in Cyprus), Cyprus and Paphia, show that she was identified with Aphrodite and Venus. Though not primarily a moon-goddess, she sometimes appears in this character (*Lucian, Deo syr.* § 4; *Herodian* v. 6, 10), and Herodotus describes her temple at Ashkelon as that of the heavenly Aphrodite (i. 103). We find her associated with Ba'al and called "the name of Ba'al," i.e. his manifestation, though this rendering is disputed, and some scholars prefer "Astarte of the heavens of Ba'al" (*NSJ*, p. 37). Another goddess, specially honoured at Carthage, is Tanith (pronunciation uncertain); nothing is known of her characteristics; she is regularly connected with Ba'al on the Carthaginian votive tablets, and called "the face of Ba'al," i.e. his representative or revelation, though again some question this rendering as too metaphorical, and take "face of Ba'al" to be the name of a place, like Peniel ("face of 'El"). Two or three other deities may be mentioned here: Eshmun, the god of vital force and healing, worshipped at Sidon especially, but also at Carthage and in the colonies, identified by the Greeks with Aesclepius; Melqarth, the patron deity of Tyre, identified with Heracles; Reshef or Reshth, the "flame" or "lightning" god, especially popular in Cyprus and derived originally from Syria, whom the Greeks called Apollo. A tendency to form a distinct deity by combining the attributes of two produced such curious fusions as Milk-'ashtart, Milk-ba'al, Milk-osir, Eshmun-melqarth, Melqarth-reshef, &c. As in the case of art and industries, so in religion the Phoenicians readily assimilated foreign ideas. The influence of Egypt was specially strong (*NSJ*, pp. 62, 69, 148, 154); thus the Astarte represented on the stele of Yehaw-milk, mentioned above, has all the appearance of Isis, who, according to the legend preserved by Plutarch (*de Is. et Os.* 15), journeyed to Byblos, where she was called Astarte. The Phoenician settlers at the Peloponnese worshipped the Assyrian Nergal, and their proper names are compounded with the names of Babylonian and Arabian deities (*NSJ*, p. 101). Closer intimacy with the Greek world naturally brought about modifications in the character of the native gods, which became apparent when Ba'al of Sidon or Ba'al-shamēm was identified with Zeus, Tanith with Demeter or Artemis, 'Anath with Athena, &c.; the notion of a supreme Ba'al, which finds expression in the Greek *ἄνωθεος* and *θεοθεός* (the goddess of Byblos), was no doubt encouraged by foreign influences. On the other hand, the Phoenicians produced a considerable effect upon Greek and Roman religion, especially from the religious centres in Cyprus and Sicily. A great number of divinities are known only as elements in proper names, e.g. *Sakun-yathon* (Sanchuniathon), 'Abd-*isam*, *Sed-yathon*, and fresh ones are continually being discovered. It was the custom among the Phoenicians, as among other Semitic nations, to use the names of the gods in forming proper names and thus to express devotion or inyoke favour; thus Hani-ba'al, 'Abd-melqarth, Hani-'ashtart, Eshmun-'azar. The proper names further illustrate the way in which the relation of man to God was regarded; the commonest forms are *servant* ('abd, e.g. 'Abd-'ashtart), *member* or *limb* (bod, e.g. Bod-melqarth), *client* or *guest* (ger, e.g. Ger-eshtun); the religious idea of the *guest* of a deity had its origin in the social custom of extending hospitality to a stranger and in the old Semitic right of sanctuary. The interpretation of such names as 'Abi-ba'al (father of Ba'al), Himilkath (brother of Milkath), Hiram (brother of the exalted one) is not altogether certain, and can hardly be discussed here.

Probably like other Canaanites the Phoenicians offered worship "on every high hill and under every green tree"; but to judge from the allusions to sanctuaries in the inscriptions and elsewhere, the Ba'al or 'Ashtart of a place was usually worshipped at a temple, which consisted of a court or pillared enclosure and a roofed shrine with a portico or pillared hall at the entrance. In the court sometimes stood a conical stone, probably the symbol of Astarte, as on the Roman coins of Byblos (illustrated in Rawlinson, *Phoenicia*, 146, Perrot et Chipiez, *Hist. de l'art*, iii. 60; see also Ohnefalsch-Richter, *Cyprus*, pl. lvi, the temenos at Idalion). Stone or bronze images of the gods were set up in the sanctuaries (*NSJ*, Nos. 13 seq., 23-27, 30, &c.); and besides these the *baetylia* (meteoric stones) which were regarded as symbols of the gods. Pillars, again, had a prominent place in the court or before the shrine (*naṣab*, *ibid.*, pp. 302 seq.); but it is not known whether the sacred pole (*ashērah*), an invariable feature of a Canaanite sanctuary, was usual in a Phoenician temple (*ibid.* pp. 50 seq.). The

⁵ See Frazer, *Adonis, Attis, Osiris*, 44 seq.

inscriptions mention altars of stone and bronze, and from the sacrificial tariffs which have survived we learn that the chief types of sacrifice among the Phoenicians were analogous to those which we find in the Old Testament (*ibid.* p. 117). The ghastly practice of sacrificing human victims was resorted to in times of great distress (e.g. at Carthage, *Diad.* xv. 14), or to avert national disaster (Porphyry, *de Abst.* ii. 56); Philo gives the legend that Cronus or El sacrificed his only son when his country was threatened with war (*Fr. hist. gr. iii.* 570); it was regarded as a patriotic act when Hamilcar threw himself upon the pyre after the disastrous battle of Himera (Herod. vii. 167). The god who demanded those victims, and especially the burning of children, seems to have been Milk, the Moloch or Moloch of the Old Testament. In this connexion may be mentioned the custom of burning the chief god of the city in effigy, or in the person of a human representative, at Tyre and in the Tyrian colonies, such as Carthage and Gades; the custom lasted down to a late time (see Fraser, *loc. cit.* ch. v.). Another horrible sacrifice was regularly demanded by Phoenician religion: women sacrificed their virginity at the shrines of Astarte in the belief that they thus propitiated the goddess and won her favour (Fraser, *ibid.* ch. iii.); licentious rites were the natural accompaniment of the worship of the reproductive powers of nature. These temple prostitutes are called *goddishim* *goddishim*, i.e. sacred men, women, in the Old Testament (Deut. xxiii. 18; 1 Kings xv. 24, &c.). Other persons attached to a temple were priests, augurs, sacrificers, barbers, officials in charge of the curtains, masons, &c. (*NSI.* No. 50); we hear also of religious guilds and corporations, perhaps administrative councils, associated with the sanctuaries (*ibid.* pp. 94, 121, 130, 144 seq.).

No doubt the Phoenicians had their legends and myths to account for the origin of man and the universe; to some extent these would have resembled the ideas embodied in the book of *Mythology* *Genesis*. Two cosmogonies have come down to us which, though they differ in details, are fundamentally in agreement. The one, of Sidonian origin, is preserved by Damascus (*de prim. principis*, 125) and received at his hands a Neoplatonic interpretation; this cosmogony was probably the writing which Strabo ascribes to a Sidonian philosopher, Mochus, who lived before the Trojan times (xvi. 2, 24). The other and more elaborate work was composed by Philo of Byblus (temp. Hadrian); he professed that he had used as his authority the writings of Sanchuniathon (q.v.), an ancient Phoenician sage, who again derived his information from the mysterious inscribed stones (*ἁγῶναις* = *σῶναι*, i.e. images or pillars of Ba'al-hammân in the Phoenician temples. Philo's cosmogony has been preserved, at least in fragments, by Eusebius in *Præp. evang.* vol. i. (*Fr. hist. gr. iii.* 353 seq.). It cannot, however, be taken seriously as an account of genuine Phoenician beliefs. For Sanchuniathon is a mere literary fiction; and Philo's treatment is vitiated by an obvious attempt to explain the whole system of religion on the principles of Euhemerus, an agnostic who taught the traditional mythology as primitive history, and turned all the gods and goddesses into men and women; and further by a patriotic desire to prove that Phœnicia could outdo Greece in the venerable character of its traditions, that in fact Greek mythology was simply a feeble and distorted version of the Phoenician.¹ At the same time Philo did not invent all the nonsense which he has handed down; he drew upon various sources, Greek and Egyptian, some of them ultimately of Babylonian origin, and incidentally he mentions matters of interest which, when tested by other evidence, are fairly well supported. He shows at any rate that some sort of a theology existed in his day; particularly interesting is his description of the symbolic figure of Cronus with eyes before and behind and six wings open and folded (*Fr. hist. gr. iii.* 569), a figure which is represented on the coins of Gebal-Byblus (and century B.C.) as the mythical founder of the city. It is evident that the gods were regarded as being intimately concerned with the lives and fortunes of their worshippers. The vast number of small votive tablets found at Carthage prove this: they were all inscribed by grateful devotees "to the lady Tanith, Face of Ba'al, and the lord Ba'al-hammân, because he heard their voice." The care which the Phoenicians bestowed upon the burial of the dead has been alluded to above; pillars (*masšêbôth*) were set up to commemorate the dead among the living (e.g. *NSI.* Nos. 18, 19, 21, 32); if there were no children to fulfil the pious duty, a monument would be set up by a man during his lifetime (*ibid.* No. 16; cf. 2 Sam. xviii. 18). Any violation of the tomb was regarded with the greatest horror (*ibid.* Nos. 4, 5). The grave was called a resting-place (*ibid.* Nos. 4, 5, 16; 21), and the departed lay at rest in the underworld with the *Refsim*, the weak ones (the same word and idea in the Old Testament, *Isa.* xiv. 9, xxvi. 14, 19; *Job* xvi. 5; *Ps.* lxxxviii. 11, &c.). The curious notion prevailed, as it did also among the Greeks and Romans, that it was possible to communicate with the gods of the underworld by dropping into a grave a small roll of lead (*tabella demotonia*, *NSI.* No. 50), inscribed with the message, generally a curse, which it was desired to convey to them.

BIBLIOGRAPHY.—The principal works bearing on the subject have been mentioned in the text and notes of this article. The

following may be added: Movers, *Die Phönizier* (1842–1856), to be used with caution; Renan, *Mission de Phénicie* (1864); Schröder, *Die phönizische Sprache* (1860); Stade in *Morgenländische Forschungen* (1875); W. Baudissin, *Stadien zur semitischen Religionsgeschichte* (1876, 1878); Baethgen, *Beiträge zur semitischen Religionsgeschichte* (1888); Levy, *Stiegel und Gemmen* (1869); J. L. Myres and Richter, *Catalogue of the Cyprus Museum* (1899); G. F. Hill, *Catalogue of the Greek Coins of Cyprus* (1904); V. Bérard, *Les Phéniciens et l'Odyssee* (1902–1903); Lidzbarski, *Epheueris für semitische Epigraphik* (1902–1906); H. Winkler, *Altorientalische Forschungen* (1893–1906); Freiherr von Landau, "Die Bedeutung der Phönizier im Völkerleben" in *Ex oriente lux* (Leipzig, 1905), vol. i.; Bruston, *Études Phén.* (1903); the articles by Thatcher in *Hastings's Dict. Bible* (1900) and by E. Meyer in the *Encyc. Bibl.* (1902). The articles by A. von Gutschmid and Albrecht Soehn in the *Encyc. Brit.* (9th ed.) have been to some extent incorporated in the present article. (G. A. C.)

PHOENIX (Gr. φοῖνῖξ), a fabulous sacred bird of the Egyptians. The Greek word is also used for a date-palm, a musical instrument like a guitar, and the colour purple-red or crimson. According to the story told to Herodotus (ii. 73), the bird came from Arabia every 500 years, bearing his father embalmed in a ball of myrrh, and buried him in the temple of the sun. Herodotus, who had never seen the phoenix himself, did not believe this story, but he tells us that the pictures of it represented a bird with golden and red plumage, closely resembling an eagle in size and shape. According to Pliny (*Nat. hist.* x. 2), there is only one phoenix at a time, and he, at the close of his long life, builds himself a nest with twigs of cassia and frankincense, on which he dies; from his corpse is generated a worm which grows into the young phoenix. Tacitus (*Ann.* vi. 28) says that the young bird lays his father on the altar in the city of the sun, or burns him there; but the most familiar form of the legend is that in the *Physiologus* (q.v.), where the phoenix is described as an Indian bird which subsists on air for 500 years, after which, lading his wings with spices, he flies to Heliopolis, enters the temple there, and is burned to ashes on the altar. Next day the young phoenix is already feathered; on the third day his pinions are full grown, he salutes the priest and flies away. The period at which the phoenix reappears is very variously stated, some authors giving as much as 1461 or even 7000 years, but 500 years is the period usually named; and Tacitus tells us that the bird was said to have appeared first under Sesostris (Sesawos); then under Amasis (Akhmose) II., under Ptolemy III., and once again in A.D. 34, after an interval so short that the genuineness of the last phoenix was suspected. The phoenix that was shown at Rome in the year of the secular games (A.D. 47) was universally admitted to be an imposture.²

The form and variations of these stories characterize them as popular tales rather than official theology; but they evidently must have had points of attachment in the mystic religion of Egypt, and indeed both Horapollo and Tacitus speak of the phoenix as a symbol of the sun. Now we know from the *Book of the Dead*, and other Egyptian texts, that a stork, heron or egret

called the *benu*  was one of the sacred symbols of the worship

of Heliopolis, and A. Wiedemann ("Die Phönix-Sage im alten Aegypten" in *Zeitschrift für ägyptische Sprache*, xvi. 80) has made it tolerably clear that the *benu* was a symbol of the rising sun, whence it is represented as "self-generating" and called "the soul of Ra (the sun)," "the heart of the renewed Sun." All the mystic symbolism of the morning sun, especially in connexion with the doctrine of the future life, could thus be transferred to the *benu*, and the language of the hymns in which the Egyptians praised the luminary of dawn as he drew near

¹ Some other ancient accounts may be here referred to. That ascribed to Hecataeus is, in the judgment of C. G. G. Gobet (*Mnemosyne*, 1883), stolen from Herodotus by a late forger. The poem of the Jew Ezechiel quoted by Eusebius (*Præp.* iv. ix. 29, 30) appears to refer to the phoenix. Here the sweet song is first mentioned—a song which, according to the poem on the phoenix ascribed to Lactantius, accompanies the rising sun. The bird is often spoken of in Latin poetry, and is the subject of an idyll by Claudian. See also Solinus, *Collectanea*, ch. xxxiii. 11, with Salmasius's *Exercitationes*; Tertullian, *De resur. carnis*, c. 13; Clemens Rom. *Epp. ad Corinthios*, i. 25 and the (? Clementine) *Apostolical Constitutions*, v. 7.

¹ An excellent and critical account of Philo's work is given by Lagrange, *Études sur les rel. sem.* (2nd ed., 1905), ch. xi.

from Arabia, delighting the gods with his fragrance and rising from the sinking flames of the morning glow, was enough to suggest most of the traits materialized in the classical pictures of the phoenix. That the *bennu* is the prototype of the phoenix is further confirmed by the fact that the former word in Egyptian means also "palm-tree," just as the latter does in Greek. The very various periods named make it probable that the periodical return of the phoenix belongs only to vulgar legend, materializing what the priests knew to be symbolic. Of the birds of the heron family the gorgeous colours and plumed head spoken of by Pliny and others would be least inappropriate to the purple heron (*Ardea purpurea*), with which, or with the allied *Ardea cinerea*, it has been identified by Lapeius and Peters (*Altestis Texte des Todtenbuchs*, 1867, p. 51). But the golden and purple hues described by Herodotus may be the colours of sunrise rather than the actual hues of the purple heron. How Herodotus came to think that the bird was like an eagle is quite unexplained; perhaps this is merely a slip of memory.

Many commentators still understand the word *phœnix*, in Job xxx. 28 (A.V. "sand") of the phoenix. This interpretation is perhaps as old as the (original) Septuagint, and is current with the later Jews. Among the Arabs the story of the phoenix was confused with that of the salamander; and the *samand* or *samandal* (Damiri, ii. 36 seq.) is represented sometimes as a quadruped, sometimes as a bird. It was firmly believed in, for the incombustible cloths woven of flexible asbestos were popularly thought to be made of its hair or plumage, and were themselves called by the same name (cf. Yaqut i. 529, and Dozy, s.v.). The *ankh* (Pers. *shamsh*), a stupendous bird like the roc (*rûk*) of Marco Polo and the *Arabian Nights*, also borrows some features of the phoenix. According to Karwin (i. 420) it lives 1700 years, and when a young bird is hatched the parent of opposite sex burns itself alive. In the book of *Kalila and Dimna* the *simûr* or *ankh* is the king of birds, the Indian *garûda*, on whom Vishnu rides.

PHOENIX, the capital of Arizona, U.S.A., and the county-seat of Maricopa county, situated on the Salt river, in the south central part of the state. Pop. (1890), 3152; (1900), 5544 (935 being foreign-born and 128 negroes); (1910) 11,134. It is served by the Arizona Eastern and the Santa Fé, Prescott & Phoenix railways, the former connecting at Maricopa (35 m. distant) with the Southern Pacific and the latter connecting at Ash Fork, near Prescott (194 m. distant), with the Atchison, Topeka & Santa Fé. The city is a popular winter and health resort, with a fine dry climate. The city is the see of a Protestant Episcopal bishopric. About 3 m. north of the city is the Phoenix (non-reservation) boarding-school for Indians, supported by the United States government, with an average attendance of about 700 pupils. The city lies in a great plain, in the centre of a region of pastures, gardens and orchards, the largest and most beautiful farming district of Arizona, irrigated with water stored by the great Roosevelt dam (about 70 m. north-east of Phoenix). Local interests are almost entirely in agriculture, stock-raising and fruit-growing. In the surrounding region are several large ostrich farms and a small exhibition ranch. Phoenix was settled in 1870, became the county-seat on the organization of Maricopa county in 1871, was incorporated in 1881, and became the capital of Arizona in 1889.

PHOENIX ISLANDS, a group of eight small islands in the Pacific Ocean, about 3° S., and 172° W., belonging to Great Britain. They have a land area about 16 sq. m. and a population of 60. Their names are Phoenix, Gardner (Kemin), Hull, Sydney, Birnie, Enderbury, Canton (Mary) and McKean. To the north-west of the group (between the equator and 1° N.) lie two more islets—Baker and Howland. The islands were annexed by Great Britain in 1889-1892.

PHOENIXVILLE, a borough of Chester county, Pennsylvania, U.S.A., on the Schuylkill river at the mouth of French Creek, about 28 m. north-west of Philadelphia. Pop. (1890), 8514; (1900), 9106, of whom 2221 were foreign-born and 278 were negroes; (1910 census), 10,743. It is served by the Pennsylvania (Schuylkill division) and the Philadelphia & Reading railways, and by electric railway to Spring City (pop. in 1910, 2880), 5 m. north-west of Phoenixville on the Schuylkill. Phoenixville is chiefly a manufacturing borough. Its blast-furnaces and iron mills were long among the largest in the country, and the manu-

facture of steel is still the borough's predominant industry. Phoenixville was settled in 1732, and was incorporated in 1849.

PHONETICS (Gr. *phônê*, voice), "the science of speech-sounds and the art of pronunciation. In its widest sense it is the "science of voice," dealing not only with articulate, but also with the inarticulate sounds of animals as well as men. The originally synonymous term, "phonology," is now restricted to the history and theory of sound-changes. The most obvious of the practical applications of phonetics is to the acquisition of a correct pronunciation of foreign languages. But its applications to the study of the native language are not less important: it is only by the help of phonetics that it is possible to deal effectively with vulgarisms and provincialisms of pronunciation and secure uniformity of speech; and it is only on a phonetic basis that the deaf and dumb can be taught articulate speech. From a more theoretical point of view phonetics is, in the first place, the science of linguistic observation. Without phonetic training the dialectologist, and the missionary who is confronted with a hitherto unwritten language, can neither observe fully nor record accurately the phenomena with which they have to deal. These investigations have greatly widened the scope of the science of language. The modern philologist no longer despises colloquial and illiterate forms of speech. On the contrary, he considers that in them the life and growth of language is seen more clearly than in dead literary languages, on whose study the science of comparative philology was at first exclusively built up. It was not till philologists began to ask what were the real facts underlying the comparisons of the written words in Sanskrit, Greek, Latin, and the other Indo-European languages, embodied in such generalizations as Grimm's Law, that "letter-science" developed into "sound-science" (phonology). The rise and decay of inflexions, and the development of grammatical forms generally, are, from the formal point of view, mainly phonetic problems; and phonetics enters more or less into every department of historical and comparative grammar.

Methods of Study and Investigation.—Phonetics is the science of speech-sounds. But sounds may be considered from two opposite points of view—the *organic* and the *acoustic*. From the organic point of view a sound is the result of certain actions and positions of the organs of speech, as when we define *f* as a lip-teeth (dento-labial) consonant. This is the point of view of the speaker of a language. To the hearer, on the other hand, *f* is not a lip-teeth, but a hiss consonant similar to that denoted by *th*. This is the acoustic point of view. Theoretically, the organic study of phonetics is a branch of anatomy and physiology; that part of these sciences which deals with the organs of speech (see MOUTH) and their functions (see VOICE); while, from the opposite point of view, the study of phonetics is based on that branch of physical science known as acoustics (see SOUND), together with the anatomy and physiology of the organs of Hearing (q.v.).

Unfortunately, this basis is still imperfect. The principles of acoustics are well established, and we know much about the anatomy of the ear. But how the ear transmits to the brain the impression of sound is still a mystery. Again, although the mechanism of the vowel is clear enough, there is still no generally received acoustic theory of its formation. In fact, from the physical science point of view there is as yet no science of phonetics.

The real function of phonetics is philological and literary. The only sound basis of a theoretical knowledge of phonetics is the practical mastery of a limited number of sounds—that is to say, of the sounds which are already familiar to the learner in his own language. It is evident that the more familiar a sound is, the easier it is to gain insight into its mechanism and to recognize it when heard. It is indispensable to cultivate both the organic and the acoustic sense. These processes we are continually carrying out in ordinary conversation. All, therefore, that we have to do in dealing with native sounds is to develop this unconscious organic and acoustic sense into a conscious and analytic one. The first step is to learn to isolate each sound: to

pronounce it, as far as possible, apart from its context; and to preserve it unchanged through every variation of length and force, and in every combination of sounds. The next step is to analyse its formation. Let the student, for instance, compare the two consonants in such a word as *fee* by isolating and lengthening them till he can both hear and feel the voice-vibration in the second one. In the same way let him learn to feel the changes in the position of the tongue and lips in passing from one vowel to another. When the native sounds have been thoroughly studied in this way, the learner will proceed to foreign sounds, deducing each new sound from those which are already familiar to him.

The natural method of learning sounds is mainly a subjective one. We listen patiently till our ears are steeped, as it were, in the sound; and then, after repeated trials, we hit on the exact position of the organs of speech by which we can reproduce the sound to the speaker's satisfaction. But the natural method admits also of objective control and criticism of the movements of the lips and jaws by direct observation. The movements and positions of the tongue and soft palate, and other modifications of the mouth and throat passages are also more or less accessible to observation—in the case of self-observation with the help of a small mirror held in the hand. If the mirror is small enough to go into the mouth, and is fixed obliquely to a handle, so that it can be held against the back of the mouth at such an angle as to reflect a ray of light down the throat, we have the *laryngoscope*. Laryngoscopy has confirmed earlier results, and has also added to our knowledge of the throat sounds. But, on the other hand, it has been a fruitful source of error. There has been great discrepancy between the results obtained by different observers; and many results which were at first received with implicit confidence for their supposed rigorously scientific and objective character have been found to be worthless. It seemed at first as if Röntgen's discovery of the so-called X-rays would meet the want of a means of direct observation of the positions of the tongue, not lengthways, but from the side, as also of the interior of the throat. But although the checks are to a certain extent transparent to these rays, the shadow of the tongue projected on the screen is too indistinct to be of any use.

But there are other methods besides those of direct observation by which the positions of the tongue may be objectively determined and measured with more or less accuracy. The interior of the mouth may be explored by the fingers. If the little finger is held against the gums during the articulation of the vowels in *it, at, et*, the difference in the height of the tongue will at once become apparent: in the formation of the first vowel the tongue is pressed strongly against the artificial palate, while in that of the second it only just touches it, and in that of the third it does not touch at all.

Several forms of apparatus have been devised for a more accurate determination of the positions of the tongue and the other movable organs of speech. The best results hitherto as regards the vowel-positions have been obtained by Grandgent, who uses disks of cardboard of various sizes fixed to silver wires. A full description of this and other methods will be found in Scripture's *Elements of Experimental Phonetics*.

There are other methods whose results are obtained only indirectly. The simplest of these are the *palatographic*, by which are obtained "palatograms" recording the contact of the tongue with the palate. The apparatus most generally used consists of a thin, shell-like artificial palate, which is covered with chalk and placed in the mouth; when the sound is made, the articulation of the tongue is inferred from the contact-marks on the plate. This method is evidently limited in its application. It, too, has the drawback of not being applicable to the sounds formed in the back of the mouth. The outlines of palatograms are much vaguer than they appear in the published drawings of them; and it is a question whether the thickness even of the thinnest plate does not modify the record.

The methods hitherto considered are all comparatively simple. They require no special knowledge or training, and are accessible to all. But there are more elaborate methods—with which the name "experimental phonetics" is more specially connected—involving special training in practical and theoretical physics and mathematics, and requiring the help of often complicated and costly, and not easily accessible, apparatus. The investigation of the speech curves of phonograph and gramophone records is a typical example. Good examples of these methods are afforded by E. A. Meyer's investigations of vowel-quantity in English (*Englische Lautdauer*, Uppsala, 1903). Their characteristic feature is their delicacy, and the minuteness of their distinctions, which often go beyond the range of the human ear. Although their results are often of value, they must always be received with caution: the sources of error are so numerous.

The claims of instrumental phonetics have been so prominently brought forward of late years that they can no longer be ignored, even by the most conservative of the older generation of phoneticians.

But it is possible to go too far the other way. Some of the younger generation seem to think that the instrumental methods have superseded the natural ones in the same way as the Arabic superseded the Roman numerals. This assumption has had disastrous results. It cannot be too often repeated that instrumental phonetics is, strictly speaking, not phonetics at all. It is only a help: it only supplies materials which are useless till they have been tested and accepted from the linguistic phonetician's point of view. The final arbiter in all phonetic questions is the trained ear of a practical phonetician: differences which cannot be perceived must—or at least may be—ignored; what contradicts the trained ear cannot be accepted.

Sound-Notation; Spelling Reform.—Next to the analysis of the sounds themselves, the most important problem of phonetics is their representation by means of written and printed symbols. The traditional or "nomic" orthographies of most languages are only imperfectly phonetic. And, unfortunately, of the languages in most general use, two are exceptionally unphonetic in their orthographies, French showing the greatest divergence between sound and symbol, while English shows the maximum of irregularity and arbitrariness. The German orthography is comparatively phonetic: it has hardly any silent letters, and it generally has one symbol for each sound, each symbol having only one value, the exceptions falling under a few simple rules, which are easily remembered. There are other languages which have still more phonetic orthographies, such as Spanish, Welsh and Finnish. But even the best of them are not perfect: even when they are not actually misleading, they are always inadequate. On the other hand, no system of writing is wholly unphonetic. Even in French and English there are many words whose spelling not even the most radical reformer would think of altering. In fact, all writing which has once emerged from the hieroglyphic stage is at first purely phonetic, as far as its defective means will allow. The divergence between sound and symbol which makes spelling unphonetic is the result of the retention of phonetic spellings after they have become unphonetic through changes in the pronunciation of the words themselves. Thus, such English spelling as *knicht* and *wright* were still phonetic in the time of Chaucer; for at that time the initial consonants of these words were still pronounced, and the *gh* still had the sound of *ch* in German *ich*. So also *see* and *sea* are written differently, not by way of arbitrary distinction, but because they were pronounced differently till within the last few centuries—as they still are in Irish-English.

Where there is no traditional orthography, as when Old English (Anglo-Saxon) was first written down in Latin letters, spelling was necessarily phonetic; but where there is a large literature and a class of professional scribes, the influence of the traditional orthography becomes stronger, till at last the invention of printing and the diffusion of one standard dialect over a large area occupied originally by a variety of other dialects make changes of spelling as inconvenient as they were once easy and natural. The ideal orthography for printers is one which is absolutely uniform over the whole territory of the language, and absolutely unchangeable. In such orthographies as those of the present English and French there is no longer any living correspondence between sound and symbol: they are, in intention at least, wholly unphonetic; they are preserved by graphic, not by oral, tradition.

But unphoneticness has its practical limits. A purely unphonetic degradation of an originally phonetic system of writing—one in which there is absolutely no correspondence between sounds and letters—could not be mastered even by the most retentive memory: it would be even more difficult than the Chinese writing. Hence a phonetic reaction is inevitable. In the middle ages the spelling was periodically readjusted in accordance with the changes of pronunciation—as far, of course, as the imperfections of the existing orthography would allow. This adjustment went on even after the introduction of printing. In fact, it is only within the last hundred years or so that the orthographies of English and French have become fixed.

One result of this fixity is that any attempt to continue the process of adjustment assumes a revolutionary character. When, in 1849, the pioneers of the modern spelling-reform

movement—A. J. Ellis and I. Pitman—brought out the *Phonetic News*, few of those who joined in the chorus of ridicule excited by the new alphabet stopped to consider that this uncouthness was purely the result of habit, and that the Authorized Version of the Bible in the spelling of its first edition would seem to us not less strange and uncouth than in the new-fangled phonotypy of Messrs Ellis and Pitman. Nor did they stop to consider that phonetics and phonetic spelling, so far from being innovations, are as old as civilization itself. The Alexandrian grammarians were not only phoneticians—they were spelling-reformers; they invented the Greek accents for the purpose of making the pronunciation of Greek easier to foreigners. The Romans, too, were phoneticians: they learnt Greek by phonetic methods, and paid great attention to niceties of pronunciation. The Sanskrit grammarians were still better phoneticians.

As a matter of fact, English spelling was still phonetic as late as the time of Shakespeare—in intention, at least. But although people still tried to write as they spoke, the inherited imperfections of their orthography made it more and more difficult for them to do so. Hence already in the 16th century a number of spelling-reformers made their appearance, including classical scholars such as Sir John Cheke, and A. Gill, who was head-master of St Paul's School in London. Gill has left us extracts from Spenser's *Faerie Queene* in phonetic spelling; but, strange to say, nothing of Shakespeare's, although he and Shakespeare were exact contemporaries. But Gill's and the other alphabets proposed were too intricate and cumbrous for popular use.

Nevertheless, some important phonetic reforms were successfully carried through, such as getting rid of most of the superfluous final *e*'s, utilizing the originally superfluous distinctions in form between *i* and *j*, *u* and *v*, by using *i*, *u* only as vowels, *j*, *v* only as consonants, instead of at random—a reform which seems to have begun in Italy. Another important reform was the introduction of *ea* and *oo*, as in *sea* and *boat*, which had hitherto been written with *ee* and *oo*, being thus confused with *see* and *boot*.

All these were as much phonetic reforms as it would be to utilize long *s* and tailed *s* (\int , \mathfrak{S}) to denote the final consonants in *fish* and *rouge* respectively; a reform first suggested by A. J. Ellis, who was himself the first to call attention to the works of these early phoneticians and to utilize them in the investigations enshrined in his great work on *Early English Pronunciation*.

With all its defects, the present English spelling is still mainly phonetic; we can still approximately guess the pronunciation of the vast majority of words from their spelling. So when we say that English spelling is unphonetic we merely mean that it is a bad phonetic spelling; and all that spelling-reformers aim at is to make this bad into a good phonetic spelling, that is, an efficient and easy one. But the difficulties are great; and the more we know of phonetics, and the more we experiment with different systems of spelling, the more formidable do they appear. One of the difficulties, however, that is commonly supposed to stand in the way of spelling-reform is quite imaginary: namely, that it would destroy the historical and etymological value of the present system. Thus E. A. Freeman used to protest against it as "a reckless wiping out of the whole history of the language." Such critics fail to see that historical spelling, if carried out consistently, would destroy the materials on which alone history can be based; that these materials are nothing else but a series of phonetic spellings of different periods of the language, and that if a consistent historical and etymological spelling could have been kept up from the beginning, there would have been no Grimm's Law, no etymology; in short, no comparative or historical philology possible.

The advantages of beginning a foreign language in a phonetic notation are many and obvious. In the first place, the learner who has once mastered the notation and learnt to pronounce the sounds the letters stand for, is able to read off at once any text that is presented to him without doubt or hesitation, and without having to burden his memory with rules of pronunciation and spelling. Another advantage of phonetic spelling is that when the learner sees the words written in a representation of their

actual spoken form he is able to recognise them at once when he hears them. And if the learner begins with the phonetic notation, and uses it exclusively till he has thoroughly mastered the spoken language, he will then be able to learn the ordinary spelling without fear of confusion, and quicker than he would otherwise have done.

Spelling-reform may be carried out with various degrees of thoroughness. After the failure of many schemes of radical reform, an attempt was made to begin with those numerous spellings which are both unphonetic and unhistorical, or are against the analogy of other traditional spellings. Accordingly, in 1881 the Philological Society of London "approved (*sic*) of certain partial corrections (*sic*) of English spellings," which were also approved of by the American Spelling-reform Association; and a list of them was issued jointly by the two bodies, and recommended for general adoption. A similar movement has been started in France. But the general feeling appears to be that it is better to keep the ordinary spelling unchanged, and wait till it is possible to supersede it by one on a more or less independent basis.

If the existing Roman alphabet is made the basis of the new phonetic notation of any one language, the most obvious course is to select one of the various traditional representations of each sound, and use that one symbol exclusively, omitting, of course, at the same time all silent letters. A. J. Ellis's *English Glossic* is an example of such a phonetic spelling on a national basis. The following is a specimen:—

Ingliſh glosik iz veri eezɪ tɔ reed. Wið proper trainin a cheild foar yearz ould kan bee rediit taut tɔ reed glosik buks.

But a system which, like this, writes short and long vowels with totally different symbols (*i*, *ee*) is only half phonetic: it is phonetic on an unphonetic basis.

A fully phonetic system, in which, for instance, long vowels and diphthongs are expressed by consistent modifications or combinations of the symbols of the short vowels, and in which simple sounds are, as far as is reasonable and convenient, expressed by single letters instead of digraphs such as *sh*, must necessarily discard any national basis. The best basis on the whole is obtained by giving the letters their original common European sounds, *i.e.* by returning to the Late Latin pronunciation, with such modifications and additions as may be advisable. As regards the vowels at least, this Latin basis is very well preserved in German and Italian. In French, on the other hand, the Latin tradition was greatly corrupted already in the earliest period through the rapid changes which the language underwent. Thus when the Latin *u* in *luna* assumed the sound it now has in French *lune*, the symbol *u* was still kept; and when the sound *u* afterwards developed again out of the diphthong *ou*, this digraph was used to denote the sound. So when the French system of spelling came into use in England after the Norman Conquest these unphonetic symbols were introduced into English spelling, so that such a word as Old English and Early Middle English *hūs*, "house," was written *houſe* in the Late Middle English of Chaucer, although the sound was still that of Scotch *hoos*, *ou* (*ow*) being also used to denote a true diphthong (*ou*) in such words as *know*, *know*, from Old English *cneowan*.

By returning, then, to the original values of the letters we get the "Romic" or international (Continental) basis as opposed to the Glossic or national basis. Thus the passage quoted above appears as follows in Sweet's "Broad Romic" notation:—

ɪŋglɪʃ glɔsɪk ɪz vɛrɪ ɛɪzɪ tɔ rɪd. wɪð prɒpɛ trɛɪnɪŋ ə tʃaɪld fɔə ɪjɔz ould kən biː rɛdɪɪt tɔt tɔ rɪd glɔsɪk buks.

Another important general distinction is that between "broad" and "narrow" systems of notation. A broad notation is one which makes only the practically necessary distinctions in each language, and makes them in the simplest manner possible, omitting all that is superfluous. From a practical point of view the necessary distinctions are those on which differences of meaning depend. A distinction of sound which is significant in one language may be insignificant in another. Thus the distinction between close *e* and open *e*, *é* is significant in French, as in *pêcher*, *pêcher*; so if in French phonetic writing the former

is denoted by (e), it is necessary to find a new symbol (e) for the open sound. But in languages such as English and German, where the short *e* is always open, there is no practical objection to using the unmodified (e) to denote the open sound, even if we regard (e) as the proper symbol of the close sound. And in those languages in which the short *e* is always open and the long *e* always close it is enough to mark the distinction of quantity, and leave the distinction of quality to be inferred from it (e, ee). In such a case as this it is, of course, possible to apply the principle of ignoring superfluous distinctions in the opposite way: by writing the long and short vowels in such a language (e, e), leaving the quantity to be inferred from the quality. But the former method is the more convenient, as it does not require any new letter. The "broad" principle is especially convenient in writing diphthongs. Thus in English Broad Romic we write the diphthongs in *high* and *how* with the same vowel as *ask* (hai, hau, ask), although all these (a)'s represent different sounds in ordinary southern English pronunciation. But the pronunciation of these diphthongs varies so much in different parts of the English-speaking territory, and the distinctions are so minute that it would be inconvenient to express them in writing; and as these distinctions are non-significant, it would be useless to do so. (ai) and (au) are symbols, not of special diphthongs, but of two classes of diphthongs: they can stand for any diphthongs which begin with a vowel resembling the Italian *a*, and end with approximations to *i* and *u* respectively. Theoretically it would be just as correct in English and German to write these diphthongs (ae, ao). But these notations are misleading, because they suggest simple sounds.

In comparing the sounds of a variety of languages, or of dialects of a language, and still more in dealing with sounds in general, we require a "narrow," that is a minutely accurate, notation covering the whole field of possible sounds. It is evident from what has been said above that such a universal scientific alphabet is not suited for practical work in any one language. But the symbols of such a notation as Sweet's "Narrow Romic" are of the greatest use as keys to the exact pronunciation of the vaguer symbols of the Broad Romic notations of each language.

To prevent confusion between these two systems of notations Broad Romic symbols are enclosed in (), Narrow Romic in [], which at the same time serve to distinguish between phonetic and nomic spellings. This in English *i* (i) = [i] means that the English vowel in *finny* is the "wide" sound, not the "narrow" one in French *fini*, although in the Broad Romic notations of both languages (*fini*) is written for *finny* and *fini* alike.

Narrow Romic was originally based on A. J. Ellis's "Palaeotype," in which, as the name implies, no new letters are employed. The symbols of Palaeotype are made up, as far as possible, of the letters generally accessible in printing-offices, the ordinary Roman lower-case letters being supplemented by italics and small capitals (i, i, i) and turned letters (o, o), many digraphs (th, sh) being also used. This notation was a reaction from Ellis's earlier phonotopy, in which a large number of new letters were used. Some of these, however, such as *f*=(sh), *z*=(zh), were afterwards adopted into Broad and Narrow Romic. In his Palaeotype Ellis also discarded diacritical letters, which, as he rightly says, are from a typographical point of view equivalent to new letters. In Narrow Romic a certain number of diacritical letters are used, such as (ñ, ñ), most of which are already accessible. Palaeotype is a Roman-value notation, the main difference as regards the values of the symbols between it and the later systems being that it is more complex and arbitrary. Ellis afterwards had the unhappy idea of constructing a "Universal Glossic" on an English-values basis, which is even more cumbersome and difficult to remember than Palaeotype.

Sweet's Romic systems were made the basis of the "International" alphabet used in *La Matre Phonétique*, which is the organ of the *International Phonetic Association*, directed by P. Passy. Although this system is at the present time more widely known and used than any other, and although it is

constructed on the international Romic principle, it is not really an international system. It is rather an attempt to make a special adaptation of the Romic basis to the needs of the French language into a general notation for all languages. But the phonetic structure of French is so abnormal, so different from that of other languages, that the attempt to force a Broad Romic French notation on such a language as English is even more hopeless than it would be to reverse the process. Although well suited for French, this alphabet must from a wider point of view be regarded as a failure: it is too minute and rigid for practical, and yet not precise enough for scientific purposes. In short, although it has done excellent service, and has helped to clear the way for a notation which shall command general acceptance, it cannot be regarded as a final solution of the problem.

Of the numerous other notations now in use, some still adhere to the diacritic principle of Lepsius's *Standard Alphabet* (1855), intended for missionary use, but found quite unfit for that purpose because of the enormous number of new types required. Most of them prefer to use new letters formed by more or less consistent modifications of the existing italic letters. A. J. Lundell's Swedish dialect alphabet and O. Jespersen's Danish dialect alphabet are good specimens of this tendency. In the latter Roman letters are used for special distinctions, just as italic letters are used in the Romic systems.

But in spite of all diversity, there is much agreement. As regards the vowels, the following approximate values are now pretty generally accepted:—

a	as in father.	i	as in it.
ai	" time.	o	" beau (Fr.).
au	" house.	œ	" peur (Fr.).
æ	" man.	ɔ	" fall.
ə	" 4&6 (Fr.).	ou	" oil.
ei	" veil.	oi	" soul.
e	" there.	u	" full.
ə	" further.	y	" une (Fr.).

Vowel-length is in some systems denoted by doubling (aa), in others by special marks (a: &c.), the diacritic in *a* being used only in the nomic orthographies of dead and oriental languages.

The only consonant-symbols that require special notice are the following:—

c	as in työk (Hung.).	n	as in sing.
ç	" ich (German).	ʃ	" fish.
ç	" then.	þ	" thin.
j	" you.	w	" we.
ɲ	" nagy (Hung.)	x	" loch.
ñ	" ogni (Ital.).	ʒ	" rouge.

All the systems of phonetic notation hitherto considered are based on the Roman alphabet. But although the Roman alphabet has many advantages from a practical point of view, it is evidently impossible to build up a consistent and systematic notation on such an inadequate foundation of arbitrary signs. What is wanted, for scientific purposes especially, is a notation independent of the Roman alphabet, built up systematically—an alphabet in which there is a definite relation between sound and symbol.

This relation may be regarded either from the organic or the acoustic point of view. The tendency of the earlier attempts at an a priori universal alphabet was to symbolize the consonants organically, the vowels acoustically, as in E. Brücke's *Phonetische Transcription* (1863). It is now generally acknowledged that the vowels as well as the consonants must be represented on a strictly organic basis. This was first done in A. M. Bell's *Visible Speech* (1867), which appeared again (1882) in a shorter form and with some modifications under the title of *Sounds and their Relations*. Bell's pupil, H. Sweet, gave a detailed criticism of Visible Speech in a paper on *Sound-notation* (Trans. of Philological Society, 1880-1881), in which he described a revised form of it called the *Organic Alphabet*, which he afterwards employed in his *Primer of Phonetics* and other works. Sweet's Narrow Romic notation already mentioned is practically a transcription of the Organic Alphabet into Roman letters.

Such notations are alphabetic: they go on the general principle of providing separate symbols for each simple sound. But as

the number of possible shades of sounds is almost infinite, even the most minutely accurate of them can do so only within certain limits. The Organic Alphabet especially makes a large use of "modifiers"—characters which are added to the other symbols to indicate nasal, palatal, &c., modifications of the sounds represented by the latter, these modifiers being generally represented by italic letters in the Narrow Romic transcription; thus (*m*) = nasalized (l).

In the Roman alphabet such symbols as *f*, *v* are arbitrary, showing no connection in form either with one another or with the organic actions by which they are formed; but in the Organic symbol of *v*, for instance, we can see the graphic representation of its components "lips, teeth, voice-murmur." By omitting superfluous marks and utilizing various typographical devices the notation is so simplified that the symbols, in spite of their minute accuracy, are often simpler than in the corresponding Roman notation. The simplicity of the system is shown by the fact that it requires only about 110 types, as compared with the 280 of Lepsius's very imperfect Standard Alphabet.

All the systems hitherto considered are also alphabetic in a wider sense: they are intended for continuous writing, the more cumbersome "narrow" notations being, however, generally employed only in writing single words or short groups. An "analphabetic" basis was first definitely advocated by Jespersen, who represents each sound by a group of symbols resembling a chemical formula, each symbol representing not a sound, but an element of a sound: the part of the palate, tongue, &c., where the sound is formed, the degree of separation (openness) of the organs of speech, and so on. The two great advantages of such a system are that it allows perfect freedom in selecting and combining the elements and that it can be built up on the foundation of a small number of generally accessible signs.

As regards Jespersen's scheme, it is to be regretted that he has not worked it out in a more practical manner: that in his choice of the thirty odd symbols that he requires he should have gone out of his way to mix up Greek with Roman letters, together with other characters which would be avoided by any one constructing even a scientific alphabetic notation. And his use of these symbols is open to much criticism. In fact, it cannot be said that the analphabetic principle has yet had a fair trial.

The Organs of Speech.—Most speech-sounds are formed with air expelled from the lungs (voice-bellows), which passes through the two contractible bronchi or bronchial tubes into the also contractible wind-pipe or trachea, on the top of which is fixed the larynx (voice-box). Across the interior of the larynx are stretched two elastic ledges or cushions called "the vocal chords." They are inserted in front of the larynx at one end, and at the other they are fixed to two movable cartilaginous bodies "the arytenoids," so that the passage between them—the glottis—can be narrowed or closed at pleasure. The glottis is, as we see, twofold, consisting of the chord glottis and the cartilage glottis. The two can be narrowed or closed independently. The chords can also be tightened or relaxed, lengthened and shortened in various degrees.

When the whole glottis is wide open, no sound is produced by the outgoing breath except that caused by the friction of the air. Sounds in whose formation the glottis is in this passive state are called "breath" sounds. Thus (*f*) is the breath consonant corresponding to the "voice" or "voiced" consonant (*v*). In the production of voice, the chords are brought close enough together to be set in vibration by the air passing between them. In the "thick" register of the voice (chest voice) the chords vibrate in their whole length, in the "thin" register or falsetto only in part of their length. If the glottis is narrowed without vibration, "whisper" is the result. In the "weak whisper" there is narrowing the whole glottis; in the "strong whisper," which is the ordinary form, the chord glottis is entirely closed, so that the breath passes only through the cartilage glottis. In what is popularly called "whisper"—that is, speaking without voice—the breath sounds remain unchanged, while voiced sounds substitute whisper (in the phonetic sense) for voice. Thus in whispering such a word as *feel*

the (*f*) remains unchanged, while the following vowel and consonant are formed with the glottis only half closed. Whispered sounds—both vowels and consonants—occur in ordinary loud speech in many languages. Thus the final consonants in such English words as *leaves*, *oblige* are whispered, except when followed without a pause by a voiced sound, as in *obfusing*, where the (*z*) is fully voiced.

Above the glottis—still within the larynx—comes the "upper" or "false" glottis, by which the passage can be narrowed. On the top of the larynx is fixed a leaf-like body, the "epiglottis," which in swallowing, and sometimes in speech, is pressed down over the opening of the larynx. The contractible cavity between the larynx and the mouth is called the "pharynx." The roof of the mouth consists of two parts, the "soft" and the "hard palate." The lower pendulous extremity of the soft palate, the "uvula," in its passive state leaves the passage into the nose open. In the formation of non-nasal sounds, such as (*b*), the uvula is pressed up so as to close the passage from the pharynx into the nose. If (*b*) is formed with the passage open, it becomes the corresponding nasal consonant (*m*). The other extremity of the (hard) palate is bounded by the teeth, behind which are the gums, extending from the teeth-ridge to the arch-rim—the projection of the teeth-roots or alveolars.

There is great diversity among phoneticians as regards the mapping out—the divisions—of the palate and tongue, and their names. Foreign phoneticians generally adopt very minute distinctions, to which they give Latin names. Bell in his *Visible Speech* makes a few broad fundamental divisions. In the arrangement adopted here (mainly based on his) sounds formed on the soft palate are called "back," and are subdivided into "inner"—nearer the throat, and "outer"—nearer the teeth, further subdivisions being made by the terms "innermost," "outermost," the position exactly half way between these two last being defined as "intermediate back." Sounds formed on the hard palate or teeth may be included under the common term "forward," more accurately distinguished as "teeth" (dental), "gum" "front" (palatal, afterwards called "top" by Bell), which last is really equivalent to "mid-palatal" including the whole of the hard palate behind the gums. All of these divisions are further subdivided into "inner," &c., as with the back positions.

Of the tongue we distinguish the "back" (root), "front" or middle, "point" (tip), and "blade," which includes the point and the surface of the tongue immediately behind it. The tongue can also articulate against the lips, which, again, can articulate against the teeth. The lip passage can be closed, or narrowed in various degrees. Sounds modified by lip-narrowing are called "lip-modified" (labialized) or "round" (rounded), the last being specially used in speaking of vowels.

Speech-sounds.—The most general test of a simple as opposed to a compound sound (sound-group) is that it can be lengthened without change. As regards place of articulation, no sound is really simple: every sound is the result of the shape of the whole configurative passage from the lungs to the lips; and the ultimate sound-elements, such as voice, are never heard isolated. The most indistinct voice-murmur is as much the result of the shape of the superglottal passages as the clearest and most distinct of the other vowels; and its organic formation is as definite as theirs is, the only difference being that while in what we regard as unmodified voice all the organs except the vocal chords are in their passive, neutral positions, the other vowels are formed by actively modifying the shape of the super-glottal passages—by raising the tongue towards the palate, narrowing the lips, &c.

The most important elements of speech-sounds are those which are dependent on the shape of the glottis and of the mouth passage respectively. It is on the relation between these two factors that one of the oldest distinctions between sounds is based: that of *vowel* and *consonant*. In vowels the element of voice is the predominant one: a vowel is voice modified by the different shapes of the superglottal passages. In consonants, on the other hand, the state of the glottis is only secondary.

Consonants are generally the result of audible friction, as in (f), or of complete stoppage, as in (p). If the glottis is at the same time left open, as in (f, p), the consonant is "breath" or "voiceless"—if it is narrowed enough to make the chords vibrate, as in (v, b), the consonant is "voice" or "voiced"; intermediate positions producing the corresponding "whispered" consonants. Vowels are characterized negatively by the absence of audible friction or stoppage: if an (i) is formed with the tongue so close to the palate as to cause buzzing, it becomes a variety of the front consonant (j). There is, of course, no difficulty in forming a vowel with the glottis in the position for breath and whisper. Thus breath (i) may often be heard in French in such words as *aisi* at the end of a sentence, the result being practically a weak form of the front-breath consonant (ç). The division between vowel and consonant is not an absolutely definite one. As we see, the closer a vowel is—that is, the narrower its configurative passage is—the more like it is to a consonant, and the more natural it is to devocalize it. Some voice consonants, on the other hand, have so little buzz that acoustically they constitute a class between consonants and vowels—a class of "vowel-like" or "liquid" consonants, such as n, m, l).

The changes in sounds which result from active narrowing of the passages admit of an important distinction as "sound-modifying" and "sound-colouring," although the distinction is not always definite. Nasality and rounding are examples of sound-modifying processes. Thus we hear a certain resemblance between (b) and (m), (i) and (y), but we regard all these four as distinct and practically independent sounds. Contraction of the pharynx, on the other hand, as also of the false glottis and windpipe, have only a sound-colouring effect: if a vowel is formed with such contractions its quality (timbre) is altered, but it still remains the same vowel. It follows from the definition of speech-sounds that they admit of a twofold classification: (1) organic and (2) acoustic. As already remarked, the older phoneticians used to classify the consonants organically, the vowels mainly from the acoustic point of view. The first to give an adequate organic classification of the vowels was the author of *Visible Speech*. Bell gave at the same time an independent acoustic classification of the consonants as well as the vowels. His acoustic classification consists simply in arranging the sounds in the order of their "itches" (tone-heights). The pitches of the breath consonants are absolutely fixed in each individual pronunciation, while those of spoken vowels can be varied indefinitely within the compass of each voice by tightening the vocal chords in various ways and shortening their vibrating portions: the tighter and shorter the vibrating body, the quicker its vibrations, and the higher the tone. But when a vowel is whispered or breathed nothing is heard but the resonance of the configurative passages, especially in the mouth, and the pitches of these resonant cavities are as fixed as those of the breath consonants; in other words, a whispered (or breathed) vowel cannot be sung. Although the absolute pitches of voiceless sounds may vary from individual to individual the *relations* of the pitches are constant: thus in all pronunciations (c) and whispered (i) are the highest, breath (w) in *what* and whispered (u) nearly the lowest in pitch among consonants and vowels respectively.

If phonetics were an ideally perfect science there would be no occasion to discuss whether the acoustic or the organic study of the vowels and the other speech-sounds is the more important: a full description of each sound would necessarily imply (1) an exact determination of its organic formation, (2) an acoustic analysis of the sound itself, both from the objective physical point of view and from the subjective one of the impression received by the ear, and (3) an explanation of how (2) is the necessary result of (1). Even this last question has already been solved to some extent. In fact, the connection between the organic formation and the acoustic effect is often self-evident. It is evident, for instance, that (f) and (c) owe their clear sound and high pitch to their being formed by short, narrow passages in the front of the mouth, while (u) owes its low pitch to being formed in exactly the opposite way, the sound being farther

unified and the pitch consequently still more lowered by the rounding.

One reason why it is impossible to classify the vowels exclusively on acoustic principles is that two vowels formed in quite different ways may have the same pitch. Thus the "high-front-round" (y) and the "high-mixed" (i) have the same pitch, the tongue-retraction of the mixed position of the latter having the same effect as the rounding of the former. It is evident, therefore, that the fundamental classification of the vowels must, like that of the consonants, be purely organic. And although for practical purposes it is often convenient to classify sounds partly from the acoustic point of view, a full scientific treatment must keep the two points of view strictly apart, and make a special chapter of the relations between them.

Vowels.—The most obvious distinction between vowels is that which depends on the shape of the lips in their articulation. In such non-round vowels as (i) and (a) the lips are passive, or even separated and spread out at their corners, by which the vowels assume a clearer resonance. If, on the other hand, the lips are actively approximated, they become the round vowels (y) and "open" (o) respectively.

Vowels are formed with different degrees of rounding. As a general rule, the narrowness of the lip-passage corresponds to the narrowness of the mouth-passage. Thus, in passing from the vowel of *too* to those of *so* and *saw* the back of the tongue is progressively lowered, and the rounding is diminished in the same proportion.

But there is also abnormal rounding. Thus, if we pronounce (o) with the lips in the position they have in forming (u), the resulting "over-rounded" vowel sounds half-way between (o) and (u); the second element of the diphthong (ou) in *go* is formed in this way. Conversely, the (u) in *put* is "under-rounded" in the North of England: the tongue position is kept, but the lips are only brought together a little at the corners, as in (ɔ).

The mouth positions of the vowels are the result of two factors: (1) the height of the tongue—its nearness to the palate—and (2) the degree of its retraction. Bell distinguishes three degrees of height: in his system (i) is "high," the (o) of *boy* is "mid," and the (a) of *saw* is "low." He also has three degrees of retraction: in "back" vowels, such as (u), the root of the tongue is drawn to the back of the mouth, and the whole tongue slopes down from back to front. In "front" vowels, such as (i), the front of the tongue is raised towards the hard palate, so that the tongue slopes down from front to back.

Most of these slope-positions yield vowels of a distinct and clear resonance. There is also a class of "flat" vowels, such as (e), in which the tongue is in a more or less neutral position. If the tongue is raised from the low-flat position of (æ) in *bird* to the high position, we get the (i) of North Welsh *dys* "man," which, as already observed, is acoustically similar to (y).

The flat-vowels were called "mixed" by Bell, in accordance with his view that they are the result of combining back and front articulation. And although this view is now generally abandoned, the term "mixed" is still retained by the English school of phoneticians.

In this way Bell mapped out the whole mouth by the following cardinal points:—

high-back	high-mixed	high-front
mid-back	mid-mixed	mid-front
low-back	low-mixed	low-front

In this arrangement "high-back," &c., are fixed points like those of latitude and longitude. Thus normal "high" means that the tongue is raised as close to the palate as is possible without causing consonantal friction, and "back" implies retraction of the same kind. Intermediate positions are defined as "raised," "lowered," "inner," "outer."

The most original and at the same time the most disputed part of Bell's vowel-scheme is his distinction of "primary" and "wide." All vowels fall under one of these categories. Thus, the primary French (i) and the corresponding English wide (ɪ) are both high-front-vowels, and yet they are distinct in sound: the English vowel is a semitone lower in pitch. Bell explained the greater openness of the wide vowels as the result of greater expansion of the pharynx; and he considered the other class to be most nearly allied to the consonants—whence their name "primary"—the voice-passages in the formation of primary vowels being expanded only so far as to remove all fricative quality. But alterations in the shape of the pharynx have only a sound-colouring, not a sound-modifying, effect; and Sweet showed that the distinction depends on the shape of the tongue, and accordingly substituted "narrow" for Bell's "primary." He also showed that the distinction applies to consonants as well as vowels: thus the narrow French (w) in *oui* is a consonantization of the narrow French (u) in *sou*, while the English (w) preserves the wide quality of the (ɔ) in *put*.

In forming narrow sounds there is a feeling of tension in that

part of the tongue where the sound is formed, the tongue being clenched or bunched up lengthwise, so as to be more convex than in its relaxed or "wide" condition.

The distinction between narrow and wide can often be ignored in practical phonetic writing, for it generally depends on quantity; length and narrowness, shortness and wideness going together. When the distinction is marked, wide vowels may be expressed by italics, as in German (*biina*, *bfn*).

Bell's category of "mixed-round" vowels had from the beginning been a source of difficulty to students of *Visible Speech*. But it was not till 1907 that Sweet showed that they are only mixed as regards position: they are really the corresponding back-round vowels moved forward into the middle of the mouth while preserving the slope of back vowels, instead of having the tongue flat as in the (unround) mixed vowels. They are "out-back" vowels: there is an exaggeration of the outer back position of such a back-round vowel as the English (*u*) compared with the full back (*u*) in German *müde*.

In the same way by moving the tongue backwards while forming a front vowel another series of "in-front" vowels is obtained.

The "in-mixed" vowels are obtained by shifting the neutral mixed positions into the full back position, keeping the tongue flat, so that these vowels might also be called "back-flat."

The out-back, in-front and in-mixed vowels are included under the common designation of "shifted," as opposed to "normal" vowels.

There is a large number of other vowel-schemes, of which a survey will be found in W. Victor's *Elements der Phonetik*. Many of the older ones are in the form of triangles, with the three chief vowels *a*, *i*, *u* at the three corners, the other vowels being inserted between these extremes according to their acoustic relations. Since the appearance of *Visible Speech* many attempts have been made to fit his new vowels into these older schemes.

Of all the vowel-schemes the one now most generally known is perhaps that of the International Phonetic Association already mentioned. In this scheme the distinction of narrow and wide, though admitted and occasionally marked, is not an integral part of the system, the vowels being classified first as "velar" (back) and "palatal" (front), and then according to openness as "close," "half-close," "medium," "half-open" and "open."

Consonants.—These are the result of audible friction or stoppage, which may be accompanied either with breath, voice or whisper.

Consonants admit of a two-fold division (*r*) by form, and (*z*) by place. Thus (*p*, *b*) are by place lip-consonants, while by form they are stopped consonants or "stops."

If the mouth-stoppage is kept, and the nose-passage is opened, the stop becomes the corresponding "nasal"; thus (*b*) with the soft palate lowered becomes the nasal (*m*).

In "open" consonants the sound is formed by simply narrowing the passage, as in the back-open-breath (*x*) in Scotch and German *lock*. In some open consonants, such as the lip-teeth (*l*), there is slight contact of the organs, but without impeding the flow of breath.

In "divided" consonants there is central stoppage with openings at the sides, as in the familiar point-divided (*l*). These consonants are sometimes "unilateral"—with the opening on the side only—the character of the sound not being sensibly modified thereby.

When open and divided consonants are formed with the nose-passage open they are said to be "nasalized." Thus (*m*) with incomplete lip-closure becomes the nasalized lip-open-voice consonant.

"Trills" (or rolled) consonants are a special variety of un-stopped consonants resulting from the vibration of flexible parts against one another, as when the lips are trilled, or against some firm surface, as when the point of the tongue trills against the gums in the Scotch (*r*), or the uvula against the back of the tongue, as in the Northumbrian *burred* (*r*), and the French and German (*r*), where—especially in German—the trill is often reduced to a minimum or suppressed altogether.

As regards the place of consonants, there is, as already remarked, great diversity among phoneticians, both in mapping out the palate and tongue and in the names given to these divisions. The classification and nomenclature given here is, in the main, that of Bell.

By place, then, we distinguish seven main classes of consonants: back, front, point, blade, fan, lip, and lip-teeth.

"Back" (guttural) consonants are formed between the root of the tongue and the soft palate. In most languages the positions of these consonants vary according to those of the accompanying vowels: thus the back-stop and back-nasal in *king* are more forward than in *conquer*.

"Front" (palatal) consonants are formed between the middle of the tongue and the hard palate, the point of the tongue lying passively behind the lower teeth. It is easy to make the front-open-voice (*j*) in *you* into the corresponding stop (*ç*) by narrowing the passage till there is complete closure, as in Hungarian *szeg* (*sz*) "world." In the same way the open breath (*ç*) in German *sch* may be made into the stop (*c*)—Hungarian *ty*. (*j*) nasalized becomes (*ñ*)—Italian *gn*, Spanish *ñ*, French *gn* in *signe*. The front-divided-voice consonant is the Italian *gn* and Spanish *ñ*. These are

all simple sounds, distinct from the (*ñ*), (*ny*) in French and English *million* and English *union*.

"Point" consonants when formed against the teeth are called "point-teeth" (dental). English (*þ*) in *this* is the point-teeth-open-breath consonant, (*θ*) in *then* the corresponding voice consonant. If (*θ*) is modified by turning the tip of the tongue back into the inner position—about on the arch-rim—it becomes the untrilled (*r*) in English *rearing*, in which position the tongue is easily trilled, the trilling becoming more and more difficult the more the tongue is approximated to the point-teeth position. In French and many other languages all the point consonants (*t*, *d*, *n*, *l*), &c., are formed on the teeth, except (*r*), which is always more retracted than the other point consonants. If the tip of the tongue is turned so far back as to articulate with its lower edge against the arch of the palate—that is, farther back than for the "inner" position—it is said to be "inverted." Inverted (*r*) is frequent in the dialects of the south-west of England. The opposite of inversion is "protrusion," in which the tip of the tongue articulates against the upper lip.

"Blade" consonants are formed by the blade or flattened tip of the tongue against the gums, as in English (*s*, *z*), or against the teeth, as in the corresponding French sounds. If these consonants are modified by turning the tongue a little back, so as to bring the point more into play, they become the "blade-point" consonants (*ʃ*, *ʒ*), as in *fish*, *measure*. (*ʃ*) is acoustically a dull (*s*). In some languages, such as German, sounds similar to (*ʃ*) and (*z*) are formed partly by rounding, which lowers the pitch of the hiss in the same way as retraction does, so that the tongue-articulation is only imperfectly carried out. When the rounding is very marked there is only a slight raising of the front of the tongue, as in some Swedish dialects; and if the tongue-articulation is progressively shifted back, and the rounding diminished in the same proportion, (*ʃ*) can at last develop into the pure back-open consonant (*x*), as in the present pronunciation of Spanish *x* and *j*.

The English point consonants (*t*, *d*, *n*, *l*) are formed on the gums just behind the teeth, the point of the tongue being flattened, so that they are almost blade consonants.

"Fan" (spread) consonants—the "emphatic" consonants of Arabic—are modifications of point and blade consonants, in which the sides of the tongue are spread out, so that the hiss of such a consonant as (*s*) is formed partly between the sides of the tongue and the back teeth, which gives a peculiar deep, dull quality to these sounds.

"Lip" consonants, such as (*p*, *m*), and "lip-teeth" consonants, such as (*f*, *v*), offer no difficulty. The simple lip-open-breath consonant does not occur in English; it is the sound produced in blowing out a candle. The corresponding voice sound is frequent in German—especially in Middle Germany—in such words as *quale*.

If the lip-open consonants are modified by raising the back of the tongue, they become the "lip-back" consonants (*wh*, *w*) in English *what*, *we*, which may also be regarded as consonantized (*u*). In them the lip articulation predominates. In the "back-lip" consonants, as in German *sch*, the reverse is the case.

This last is one of a large number of "lip-modified" consonants, of which the already-mentioned German *sch* is a further example.

In a similar way consonants may be "front-modified." (*t*) is peculiarly susceptible to such modifications. In French and other languages it is formed with the tongue more convex than in English, and consequently with a tendency to front-modification. Front-modified (*t*) and point (*r*) may be heard in Russian in such words as *гусь* "goose," *царь* "emperor," where the final vowels are silent. Some consonants are formed below the mouth.

When the glottis is sharply opened or closed on a passage of breath or voice an effect is produced similar to that of a stop in the mouth, such as (*k*). This "glottal stop" is the sound produced in hiccupping; and is an independent sound in some languages, such as Arabic, where it is called "hamza." In German all words beginning with a stressed (accented) vowel have a more or less distinct glottal stop before the vowel.

Of the passages below the glottis, the bronchials and the wind-pipe are both susceptible of contraction.

Spasmodic contraction of the bronchial passages is the main factor in producing what is known as "the asthmatic wheeze." If this contraction is regulated and made voluntary it results in the deep hiss of the Arabic *ħā*. If this sound is voiced, it causes a peculiar intermittent vibration of voice, which is habitual with some speakers, especially in Germany. If this effect is softened by slightly expanding the bronchial passages, an (*r*)-like sound is produced, which is that of the Arabic *ṣā*.

Contraction of the windpipe produces a sound similar to the Arabic *ħā*, but weaker, which when followed by a vowel has the effect of a strong aspirate. When voiced it becomes a mere colourer of the accompanying voice-murmur, or vowel, to which it imparts a deep timbre.

Non-expiratory Sounds.—All the sounds hitherto described imply out-breathing or expiration. Many of them can also be formed with in-breathing or inspiration. In English it is a not uncommon trick of speech to pronounce *no* in this manner, to express emphatic denial.

Some consonants are formed without either in- or out-breathing, but solely with the air in the throat or mouth. In forming "voicing-stops" or "clicks" the tongue or lips are put in the position for a stop, and the air is sucked out from between the organs in contact, so that when the stop is loosened, a smacking sound is produced by the air rushing in to fill the vacuum. Thus the point-click is the intersection of impatience commonly written *tut!* In many savage languages clicks are a part of ordinary speech.

Synthesis.—Besides analysing each sound separately, phonetics has to deal with the phenomena which accompany synthesis or the combination of sounds. Although a sentence may consist of a single word, and that word of a single vowel, sounds mostly occur only in combination with one another. The ordinary division into sentences and words is logical, not phonetic: we cannot mark off sentences and cut them up into words until we know what they mean and are able to analyse them grammatically. But the logical division into sentences corresponds to some extent with the phonetic division into "breath-groups," marked off by our inability to utter more than a certain number of syllables in succession without pausing to take breath. Within each of these breath-groups there is no necessary pause between the words, except when we pause for emphasis. The only necessary phonetic divisions within the breath-group are those into syllables, sounds and intervening "glides." But before considering these last it will be necessary to say something about the general factors of synthesis: quantity, stress and intonation.

As regards quantity, it is enough for ordinary purposes to distinguish three degrees: long, half-long or medium and short. In English what are called long vowels keep their full length when stressed and before final voiceless consonants, as in *see, broad*; and become half-long before voiceless consonants, as in *cease, brought*. In most other languages full length is preserved alike before all classes of consonants. The Romance languages have short final stressed vowels, as in French *si*. Unstressed vowels tend to become short in most languages. The distinctions of quantity apply to consonants as well as vowels. Thus English tends to lengthen final consonants after short stressed vowels, as in *man* compared with German *mann*, where the final consonant is quite short. Consonants, like vowels, tend to become short when unstressed. But in some languages, such as Finnish and Hungarian, stress has no effect on quantity, so that in these languages long vowels and double consonants occur as frequently in unstressed as in stressed syllables. Even in English we often lengthen final unstressed vowels in exclamations, as in *what a pity!* Some languages, such as the Romance languages and Russian, tend to level the distinctions of vowel-quantity: most of their vowels are half-long.

Stress is, organically the result of the force with which the breath is expelled from the lungs; while acoustically it produces the effect of loudness, which is dependent on the size of the sound-vibrations: the bigger the waves, the louder the sound, and the greater the stress, of which we may distinguish infinite degrees. If we distinguish only three, they are called *weak, medium* and *strong*. The use of stress in different languages shows the same variety as quantity. Some languages, such as French, make comparatively little use of its distinctions, uttering all the syllables of words and sentences with a more or less even degree of force. English, on the other hand, makes great use of minute distinctions of stress both to distinguish the meanings of words and to mark their relations in sentences.

With stress is closely connected the question of *syllable-division*. A syllable is a group of sounds containing a "syllabic" or syllable-former, which is, of course, able to constitute a syllable by itself. The distinction between syllabic and non-syllabic depends on sonority, the more sonorous sounds being the voiced ones, while of these again, the most open are the most sonorous, the most sonorous of all being the vowels, among which, again, the openest are the most sonorous. But these differences are only relative. When a vowel and a consonant come together the sonority of the vowel always overpowers that of the consonant, so that the two together only constitute one syllable. But in such a word as *little* the second (l) is so much more sonorous than the accompanying voiceless stop that it assumes syllabic function, and the whole group becomes disyllabic to the ear. The beginning of a syllable corresponds with the beginning of the stress-impulse with which it is uttered. Thus in *alone* the strong stress and the second syllable begin on the (t), and in *bookcase* on the second (k), the first (k) belonging to the first syllable, so that the (kk) is here double, not merely long, as in *book* (*bu(k)k*) by itself.

Intonation or variation of tone (pitch) depends on the rapidity of the sound-vibrations: the more rapid the vibrations, the higher the pitch. Intonation is heard only in voiced sounds, as being the only ones capable of variations of pitch.

In singing the voice generally dwells on each note without change of pitch, and then leaps up or down to the next note as quickly

as possible, so that the intervening "glide" is not noticed—except in what is called *portamento*. In speaking, on the other hand, the voice hardly ever dwells on any one note, but is constantly gliding upwards or downwards, so that an absolutely level tone hardly ever occurs in speech. But in the rising and falling inflections of speech we can distinguish between "voice-glides" (*portamentos* or *slurs*) and "voice-leaps," although the distinction is not so definite as in singing.

Of the three primary forms of intonation the level tone () can be approximately heard in *well* as an expression of musing—although it really ends with a slight rise; the rising (´) in the question *well?*; the falling (˘) in the answer *yes*. There are besides compound tones formed by uniting the two last in one syllable. The compound rising tone (v) may be heard in *take care!* the compound falling tone (˘) in the sarcastic *oh!* All these tones may be varied according to the intervals through which they pass. The greater the interval, the more emphatic the tone. Thus a high rise, which begins high, and consequently can only rise a little higher, expresses simple question, while the same word, if uttered with a low rise extending over an interval of between a fifth and an octave—or even more—expresses various degrees of surprise or indignation, as in the emphatic *what!* compared with the simply interrogative *what?*

In English and most European languages, intonation serves to modify the general meaning and character of sentences. This is *sentence-intonation*. But some languages, such as Swedish and Norwegian, and Chinese, have *word-intonation*, by which words which would otherwise be identical in sound are distinguished. The distinction between Gr. *oikoi* and *oikoi* was no doubt one of intonation.

Glides.—Such a word as *cat* consists not only of the vowel and the two consonants of which it is made up, but also of "glides" or transitions between these sounds. The glide from the initial consonant to the vowel consists of all the intermediate positions through which the tongue passes on its way from the (k)-position to the (æ)-position. The number of these positions is infinite, but they are all implied by the mere juxtaposition of the symbols, for it is assumed that in all transitions from one position to another the shortest way is taken. Although the direction of a glide is dependent on the positions of the two fixed points between which it lies, its character may be varied both by the shape of the configurative passages—especially the glottis—and by stress and quantity.

In the word given above the "off-glides" from the consonants are both breath-glides, the glottis being kept open during the transition from the voiceless consonant to the following vowel, or, as in the case of the final consonant, to silence. The "on-glide" from the vowel to the (t) is, on the other hand, a voice-glide, the closure of the glottis being maintained till the stop is made.

In French and most of the languages of the south of Europe voiceless consonants are followed by voice-glides. Thus in French *qui* there is no escape of breath after the (k), as there is in English *Key*. Other languages again have breath on-glides before voiceless stops.

If an independent strong stress is put on the breath-glide of English *key*, it is heard almost as a full independent consonant, and becomes an "aspirate." Aspirated stops may be heard in the Irish-English pronunciation of such words as *cell*, and also in Danish, and in Sanskrit as pronounced in India. If the voice-glide after a voice stop is emphasized in a similar way the "sonant aspirates" of Sanskrit and its modern descendants are produced, as in Sanskrit *dhannu*.

Glides are especially important from an acoustic point of view. Acoustically speaking, indeed, voiceless stops are pure glide-sounds, the stop itself being inaudible. In voice-stops, on the other hand, the stop itself can be made audible as well as the intervening glides. In English these latter are fully voiced when they come between voice sounds, as in *ago*; but when preceded by voiceless sounds or by a pause, as in *go!* they are formed with imperfect vocality, full voice being heard only just before the stop is loosened. So also initial English (z) as in *zeal* is formed with imperfect vocality under the same conditions, so that it sounds like (sz). In French and other languages which have voice-glides after voiceless consonants initial (g, z) &c. are fully voiced.

Consonant-glides may be further modified in various ways. In the formation of "implosive" stops, such as occur in Saxon German, Armenian and other languages, voiceless stops followed

by voice-glides are modified by simultaneous closure of the glottis, the larynx being raised by means of its muscles, so that it acts like a plug, compressing the air between the closed glottis and the mouth-stop, so that when the latter is released a peculiar choky effect is given to the off-glide.

Rounded glides may be heard in Russian in such words as *komala*, where the rounding of the (o) is anticipated in the preceding consonant, being heard, of course, only in the off-glide of the consonant. The acoustic effect is between that of (kwo) and ordinary (ko).

Glideless consonant-combinations remain to be considered. The general articulative principle of taking the shortest way between sounds in juxtaposition necessarily results in certain transitions being effected without any glide at all. This is regularly the case when the consonants have the same place, and differ only in form, as in (nd, dl), where the point of the tongue remains unmoved through the whole sound-group. In such combinations as (mf) the very slight glide is often got rid of entirely by assimilating the place of the first consonant to that of the second, so that the (m) becomes a lip teeth consonant, as in English *ymph*.

Even when consonants are formed in different parts of the mouth it is often possible to join them without any glide. In English such combinations as (kt, pt) are glideless, the point of the tongue being brought into position before the preceding stop is loosened. In French and most other languages such consonants are separated by a breath-glide.

Combinations of stops and vowel-like consonants (tr, gl, kw) are glideless in English and most other languages. In English the breath-glide after a voiceless stop unvoices the beginning of the following vowel-like consonant; thus *try* is almost (tr-hai).

Vowel-glides.—Vowels are begun and ended in various ways. In the gradual beginning, which is the usual one in English and French, the glottis is gradually narrowed while breath is being emitted. In the "clear" beginning the breath is kept back till the glottis is closed for voice, which begins without any "breathiness." German favours the clear beginning, generally exaggerating it into a glottal stop.

In the gradual as well as the clear beginning the stress begins on the vowel. If in the former it is thrown back on the breath-glide, the latter is felt as an independent element and becomes the "aspirate" or (h), which in English and most other languages is a glide not only in the throat but in the mouth as well, the tongue and lips gradually moving up into the position for the following vowel while the glottis is being closed.

There is also a "strong" aspirate, which occurs in Finnish and other languages, in the formation of which the full vowel position is assumed from the beginning of the aspiration, which is therefore a voiceless vowel.

In most languages, when an aspirate comes between voiced sounds it is formed with imperfect vocality, the contrast of which with the full vocalicity of the other sounds is enough to produce the effect of breath. Thus in English *behold* the voice runs on without any actual break, the glottal closure being simply relaxed, not fully opened for breath, as in the emphatic *aha*! In some languages, such as Bohemian, this "voice-aspirate" is used everywhere, initially as well as medially.

Vowels are finished analogously, either by a gradual opening of the glottis, or by a cessation of aspiration while the glottis is still closed for voice. If stress is put on the gradual ending it becomes a distinct aspirate, as in the Sanskrit "visarga" in such a word as *manah*.

Organic Basis.—Every language has certain general tendencies which control the formation of its sounds, constituting its "organic basis" or basis of articulation. The tendency of the present English is to flatten and lower the tongue and draw it back from the teeth, while the lips are kept as much as possible in a neutral position. The flattening of the tongue makes our vowels wide and favours the development of mixed vowels, and gives the dull quality which is especially noticeable in our (i); and its retraction is unfavourable to the development of teeth sounds; while the neutrality of the lips eliminates front-round vowels. In such a language as French everything is reversed. The tongue is arched, and raised, and advanced, and the lips articulate with energy. Hence French sounds tend to narrowness, dentality and distinct rounding.

National Sound-systems.—Each language uses only a part of

the general phonetic material. Each one has only a limited number of sounds; and each one makes only a limited use of the synthetic distinctions of quantity, stress and intonation. As we have seen, many of these differences between individual languages are the result of, or may be referred to, differences in their organic basis.

Just as cognate languages differ from each other in phonetic structure, so also dialects of the same languages differ from each other more or less. Thus the sound-system of Lowland Scotch—which is, historically, a dialect of Northern English—differs considerably from that of standard English. Standard English itself was originally that mixture of the Midland and the Southern dialect which was spoken in London in the middle ages, just as standard French is, historically, the dialect of that district of which Paris is the centre. Standard English, like standard French, is now more a class-dialect than a local dialect: it is the language of the educated all over Great Britain. But it is not yet perfectly uniform. It is still liable to be influenced by the local dialects in grammar and vocabulary, and still more in pronunciation.

Again, English, like all other living languages, changes from generation to generation. Pronunciations which are vulgar in one century may become fashionable in the next. Sounds which are distinct in one generation may be confounded in another, and new distinctions may be made, new sounds may arise. A spoken language is, therefore, necessarily a vague and floating entity, and English is no exception to the rule. The very fixity of its written form gives all the freer play to the influences which cause change.

A standard spoken language is, strictly speaking, an abstraction. No two speakers of standard English pronounce exactly alike. And yet they all have something in common in every sound they utter. There are some divergencies, some peculiarities of pronunciation, which pass unnoticed, while others, less considerable perhaps in themselves, are at once felt as archaisms, vulgarisms or provincialisms, as the case may be, by the majority of educated speakers.

Sounds of English.—The following is a convenient classification of the vowels of standard English:—

a	o	i	e	æ	u	o
aa	oo	ii	ei	uu	ou	oo
ai, au						oi
		io	eo	uo		

Here the vowels are in four rows: (1) normally short, or, more correctly, monophthongic, (2) long, or half-diphthongic, (3) full diphthongs, (4) murmur-diphthongs.

Those under (1) are often lengthened in monosyllables such as *less, good*, but they always remain absolutely monophthongic. The only one in the next row that is always strictly monophthongic is (oo): all the others, as we shall see, tend to become more or less diphthongic, especially in the south of England, being often exaggerated into full diphthongs of the (ai) and (au)-type in vulgar speech.

(a), as in *come up*, is the short vowel corresponding to the (aa) in *caum*. (aa) is the mid-back-wide vowel, and (a) differs from it only in being narrow. Acoustically, (a) is a muffled or obscure (aa): and the same effect may be produced by advancing the tongue from the mid-back to the corresponding out-back position, preserving the wide articulation: this pronunciation of a is common in the south of England. Historically, these sounds are the result of unrounding and older (u).

(o), as in *sofa*, is a mixed vowel, tending to wideness and mid position, which occurs only unstressed. (oo) in *turn, earth*, is low-mixed-narrow. It is the result of absorption of an older (r), weakened into (o).

(e), as in *man*, is low-front-wide, from older mid-back-wide. (i) in *it* is high-front-wide. The long (ii) in *eat* is narrow in the north of England, while in the south it is wide (i) followed by (j).

(e) in *men* is generally mid-front-wide. (ei) in *meise* is the same vowel either narrow or wide, raised in its latter half towards (i).

(u) in *good* is high-back-wide-round. Narrow (uu) in *too* becomes (sw) in southern English.

(o) in *not* is low-back-wide-round. In (ou), as in *no*, the mid-back-round vowel, either narrow or wide, is over-rounded in its latter half. (oo), as in *all*, is low-back-narrow-round.

The full diphthongs (ai, au, oi), as in *eye, now, oil*, all end in lowered high vowels. Their first elements are only roughly indicated by the transcription, and vary in the mouths of different speakers. That of (ai) is generally the out-mid-back-wide, that of (au) the broader low-mixed-wide, that of (oi) the mid-back-wide-round.

The murmur-diphthongs (io) as in *here*, (eo) as in *air*, (uo) as in

poor, all tend to broaden their first elements. That of (oo) is the low-front-narrow vowel. The other two begin with lowered forms of the wide (i) and (u) respectively. In (uu) the lowering is often carried so far as to make poor almost, or completely, into pure (poo).

The following arrangement of the English consonants will show their organic relations to one another:

j r; ʃ, ʒ a, z; ʒ, ʒ wh, w; f, v
 l
 k, g t, d p, b
 w n m

The "aspirate" (h) may be regarded either as a throat-consonant or as a breath-glide.

Characteristic features of the English consonant-system are the large number of hisses and buzzes, the sharp distinction of breath and voice, and, negatively, the absence of the open-back consonants, and of the voiceless forms of the vowel-like consonants (l, r) and the nasals, most of which still existed in Old English.

BIBLIOGRAPHY.—The most important general works are: H. Sweet, *A Primer of Phonetics* (3rd ed., Oxford, 1906); E. Sievers, *Grundzüge der Lautphysiologie* (5th ed., Leipzig, 1901); W. Victor, *Elemente der Phonetik des Deutschen, Englischen und Französischen* (5th ed., Leipzig, 1904); O. Jespersen, *Lehrbuch der Phonetik* (Leipzig, 1904); M. Trautmann, *Die Sprachlaute* (Leipzig, 1884-1886); *Le Maître Phonétique, organe de l'association phonétique internationale* (apply to Dr P. Passy, Bourg-la-Reine, France). For the laws of sound-change, see the above-mentioned work of Sievers; H. Sweet, *A History of English Sounds* (Oxford, 1888); P. Passy, *Les Changements phonétiques* (Paris, 1890). For phonetics in language-teaching see H. Sweet, *The Practical Study of Languages* (London, 1890); O. Jespersen, *How to Learn a Foreign Language* (London, 1904). For phonetic shorthand, H. Sweet, *A Manual of Current Shorthand* (Oxford, 1892). For the application of phonetics and phonetic notation to the practical study of special languages, H. Sweet, *A Primer of Spoken English* (2nd ed., Oxford, 1895); F. Beyer and P. Passy, *Elementarbuch des gesprochenen Französisch* (2nd ed., Cöthen, 1905); W. Victor, *Deutsches Lehrbuch in Lautschrift* (Leipzig, 1896). (H. Sw.)

PHONOGRAPH (Gr. φωνή, sound, γράφω, to write), an instrument for imprinting the vibrations of sound on a moving surface of tinfoil or wax in such a form that the original sounds can be faithfully reproduced by suitable mechanism. Many attempts had been made by earlier experimenters to obtain tracings of the vibrations of bodies emitting sound, such as tuning-forks, membranes, and glass or metallic disks. In 1807 Thomas Young (*Lectures*, I. 701) described a method of recording the vibrations of a tuning-fork on the surface of a drum; his method was fully carried out by Wilhelm Wertheim in 1842 (*Recherches sur l'élasticité, 1^{re} mèm.*). Recording the vibrations of a membrane was first accomplished by Leon Scott in 1857 by the invention of the "phonautograph," which may be regarded as the precursor of the phonograph (*Comptes rendus*, 53, p. 108). This instrument consisted of a thin membrane to which a delicate lever was attached. The membrane was stretched over the narrow end of an irregularly-shaped funnel or drum, while the end of the lever or marker was brought against the surface of a cylinder covered with paper on which soot had been deposited from a flame of turpentine or camphor. The cylinder was fixed on a fine screw moving horizontally when the cylinder was rotated. The marker thus described a spiral line on the blackened surface. When sounds were transmitted to the membrane and the cylinder was rotated the oscillations of the marker were recorded. Thus tracings of vibrations were obtained. This instrument was much improved by Karl Rudolph König, of Paris, who also made with it many valuable observations. (See *Nature*, Dec. 26, 1901, p. 184). The mechanism of the recording lever or marker was improved by William Henry Barlow, in 1874, in an instrument called by him the "logograph" (*Trans. Roy. Soc.*, 1874). The next step was König's invention of manometric flames by which the oscillations of a thin membrane under sound-pressures acted on a small reservoir of gas connected with a flame, and the oscillations were viewed in a rotating rectangular mirror, according to a method devised by Charles Wheatstone. Thus flame-pictures of the vibrations of sound were obtained (*Pogg. Ann.*, 1864, cxiii. 242, 660; see also *Quelques expériences d'acoustique*, Paris, 1882). Clarence Blake in 1876 employed the drum-head of the human ear as a logograph, and thus obtained tracings, similar to those made by artificial membranes and disks (*Archiv.*

für Ophthalmol., 1876, v. 1.). In the same year Sigmund Theodor Stein photographed the vibrations of tuning-forks, violin strings, &c. (*Pogg. Ann.*, 1876, p. 142). Thus from Thomas Young downwards successful efforts had been made to record graphically on moving surfaces the vibrations of sounds, but the sounds so recorded could not be reproduced. This was accomplished by T. A. Edison in 1876, the first patent being dated January 1877.

In the first phonograph a spiral groove was cut on a brass drum fixed on a horizontal screw, so that when the drum was rotated it moved from right to left, as in the phonautograph. The recorder consisted of a membrane of parchment or gold-beater's skin stretched over the end of a short brass cylinder about 2 in. in diameter. In the centre of the membrane there was a stout steel needle having a chisel-shaped edge, and a stiff bit of steel spring was soldered to the needle near its point, while the other end of the spring was clamped to the edge of the brass cylinder over which the membrane was stretched. The recorder was then so placed beside the large cylinder that the sharp edge of the needle ran in the middle of the spiral groove when the cylinder was rotated. The cylinder was covered with a sheet of soft tinfoil. During rotation of the cylinder, and while the membrane was not vibrating, the sharp edge of the marker indented the tinfoil into the spiral groove; and when the membrane was caused to vibrate by sounds being thrown into the short cylinder by a funnel-shaped opening, the variations of pressure corresponding to each vibration caused the marker to make indentations on the tinfoil in the bottom of the groove. These indentations corresponded to the sound-waves. To reproduce the sounds the recorder was drawn away from the cylinder, and the cylinder was rotated backwards until the recorder was brought to the point at which it started. The cylinder was then rotated forwards so that the point of the recorder ran over the elevations and depressions in the bottom of the groove. These elevations and depressions, corresponding to the variations of pressure of each sound-wave, acted backwards on the membrane through the medium of the marker. The membrane was thus caused to move in the same way as it did when it was made to vibrate by the sound-waves falling upon it, and consequently movements of the same general character but of smaller amplitude were produced, and these reproduced sound-waves. Consequently the sound first given to the phonograph was reproduced with considerable accuracy. In 1878 Fleeming Jenkin and J. A. Ewing amplified the tracings made on this instrument by the sounds of vowels, and submitted the curves so obtained to harmonic analysis. (*Trans. Roy. Soc. Edin.* xxviii. 745). The marks on the tinfoil were also examined by P. F. F. Grützner, Mayer, Graham Bell, A. M. Preece, and Lahr (see *The Telephone, the Microphone, and the Phonograph*, by count du Moncel, London, 1884; also *The Speaking Telephone and Talking Phonograph*, by G. B. Prescott, New York, 1878).

The tinfoil phonograph, however, was an imperfect instrument, both as regards the medium on which the imprints were taken (tinfoil) and the general mechanism of the instrument. Many improvements were attempted. From 1877 to 1888 Edison was engaged in working out the details of the wax-cylinder phonograph. In 1885 A. G. Bell and S. Tainter patented the "graphophone," and in 1887, Emile Belfinger, a German domiciled in America, patented the "gramophone," wherein the cylinder was coated with lampblack, and the friction between it and the stylus was made uniform for all vibrations. Incidentally it may be mentioned that Charles Cros deposited in 1877 a sealed packet with the Académie des Sciences, Paris, containing a suggestion for reproducing sound from a Scott phonautograph record. The improvements made by Edison consisted chiefly (1) in substituting for tinfoil cylinders or disks made of a waxy substance on which permanent records are taken; (2) in substituting a thin glass plate for the parchment membrane; (3) in improving the mechanical action of the marker; and (4) in driving the drum carrying the wax cylinder at a uniform and rapid speed by an electric motor placed below the instrument.

In the first place, permanent records can be taken on the wax, which is composed of stearin and paraffin. This material is brittle, but it readily takes the imprints made by the marker, which is now a tiny bit of sapphire. The marker, when used for recording, is shod with a chisel-shaped edge of sapphire; but the sapphire is rounded when the marker is used for reproducing the sound. The marker also, instead of being a stiff needle coming from the centre of the membrane or glass plate, is now a lever, weighted so as to keep it in contact with the surface of the wax. A single vibration of a pure tone consists of an increase of pressure followed by a diminution of pressure. When the disk of glass is submitted to an increase of pressure the action of the lever is such that, while

the wax cylinder is rotating, the point of the marker is angled downwards, and this cuts deeply into the wax; and when there is diminution of pressure the point is angled upwards, so as to act less deeply. In reproducing the sound, the blunt end of the marker runs over all the elevations and depressions in the bottom of the groove cut on the wax cylinder. There is thus increased pressure transmitted upwards to the glass disk when the point runs over an elevation, and less pressure when the point runs over a depression on the wax cylinder. The glass disk is thus, as it were, pulled inwards and thrust outwards with each vibration, but these pulls



FIG. 1a.—Exterior of Edison Phonograph.

and thrusts follow each other so rapidly that the ear takes no cognizance of the difference of phase of the vibrations of the glass plate in imprinting and in reproducing. The variations of pressure are communicated to the glass plate, and these, by the medium of the air, are transmitted to the drum-head of the ear, and the sound is reproduced with remarkable fidelity. It is necessary for accurate reproduction that the point of the marker be in the centre of the groove. In the older phonographs this required accurate adjustment by a fine screw, but in newer forms a certain amount of lateral oscillation is allowed to the marker, by which it slips automatically into the groove. Two other improvements have been effected in the construction of the instrument. A powerful triple-spring motor has been substituted for the electric motor, and the circumference of the wax cylinder has been increased from 6½ in. to 15 in., whilst the disk is 12 in. in diameter. The cylinders make about two revolutions per second, so that with the smaller cylinder the point of the marker runs over nearly 14 in. in one second, while with the larger it runs over about 30 in. The marks corresponding to the individual vibrations of tones of high pitch are therefore less likely to be crowded together with the larger cylinder, and these higher tones in particular are more accurately reproduced. In a form of instrument called the 300-thread machine motion of the drum bearing the cylinder was taken off a screw the thread of which was 50 to the inch, and by a system of gearing the grooves on the cylinder were 200 to the inch, or 1/5 of an inch apart. It was somewhat difficult to keep the marker in the grooves when they were so close together; and the movement is now taken directly off a screw the thread of which is 100 to the inch, so that the grooves on the cylinder are 1/2 of an

inch apart. Thus with the large cylinder a spiral groove of over 300 yds. may be described by the recorder, and with a speed of about two revolutions per second this distance is covered by the marker in about six minutes. By diminishing the speed of revolution, which can be easily done, the time may be considerably lengthened.

In the plate machine the disk is fixed to a table which is rotated at a fixed speed of about 76 revolutions a minute. The speed of the lateral movement of the table is also uniform, and by a regular progression brings the wax blank under the sound-box to the sapphire cutting point, which detaches a fine unbroken thread of wax as it cuts into the surface of the blank to a depth of 3/8 to 4-thousandths of an inch beginning at about half an inch from the circumference and continuing the spiral groove to within a couple of inches of the centre, according to the length of the music to be recorded. The essential difference between the disk and cylinder machine is that in the former the waves are recorded by horizontal motion over the disk, while in the latter the waves are recorded as indentations.

The following is the *modus operandi* of making a record. The person making the record sings or plays in front of a horn or funnel used for the purpose of focusing the sound-waves upon the diaphragm. The artist and the funnel are on one side of a screen and the recording apparatus in charge of an operator on the other. The arrangement of the various instruments in the recording room at proper relative distances from the horn is of the utmost importance in order to preserve the balance of tone. At about 4 ft. from the horn are grouped the violins and the wood wind (flutes, oboes and clarinets), behind the brass wind (horns, trumpets, trombones and tubers), and right at the back the violoncellos and double basses and the kettle-drums and other instruments of percussion which may be required. On the other side of the screen is the sound-box and the recording cylinder or disk.

Cylinder records are duplicated by taking a plaster cast, electroplating, and then using it as a matrix. The disk record admits of similar treatment. After dusting with graphite it is electroplated to about 9 mm. thick. This forms the permanent or master record, from which the working negatives are made by taking wax impressions of it and obtaining copper electrotes in turn from them. The matrix is then nickel-plated and polished and is ready for use in pressing out the commercial records by means of an hydraulic press, the material used being a tough and elastic substance containing shellac and other compounds such as wood charcoal, barium sulphate, earthy colouring matters and cotton flock.

There is still a defect to be overcome in the gramophone, and that is the hissing of the needle produced by friction both during recording and intensified in reproduction. In one device for remedying this the stylus acts like a stylographic pen, depositing on a polished surface a fine stream of some liquid which solidifies and hardens very rapidly, forming a sinuous ridge instead of a groove in a wax blank. A negative is taken of the record and the matrix is made from it in the usual way.

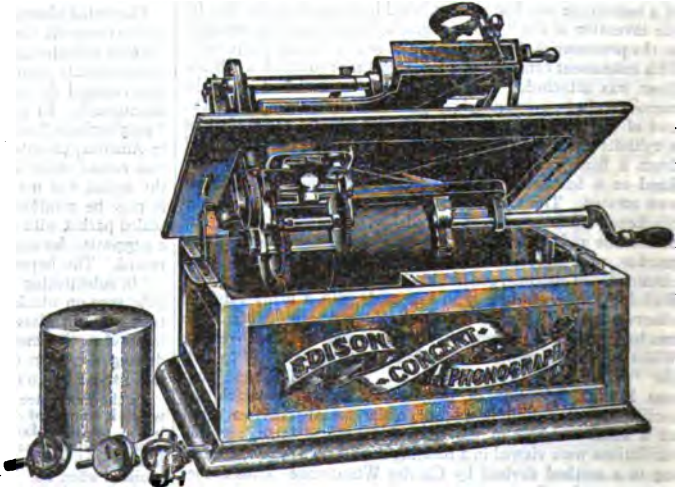

FIG. 1b.—Mechanism of Edison Phonograph.

The auxeto-gramophone or auxetophone, patented by Short in 1898 and improved by the Hon. C. A. Parsons, is similar in scope to the gramophone but attains its results in a different manner. In the Parsons-Short sound-box there is no diaphragm, but a

column of compressed air is controlled by a delicately adjusted grid-valve consisting of a metal comb rigidly connected to the stylus bar, so that as the needle moves the metal comb moves with it, following the lines of vibration fixed on the record and opening or closing the slots in the valve seat. The column of compressed air to which the valve gives access thus receives series of minute pulsations identical with those which originally produced the sounds recorded. In connexion with the sound-box is the apparatus for supplying compressed air, consisting of a six-horse power electric motor driving the compressor, an oil filter, a reservoir and a dust collector to keep the air absolutely free from foreign substances likely to interfere with the action of the valve.

The practical possibilities of the gramophone are being realized in many countries. Matrices of the records of well-known artists have been deposited at the British Museum and at the Grand Opéra in Paris. Austria established a public phonogram record office in 1903, in which are collected folk-songs and records of all kinds for enriching the department of ethnography. The same idea is being carried out in Germany

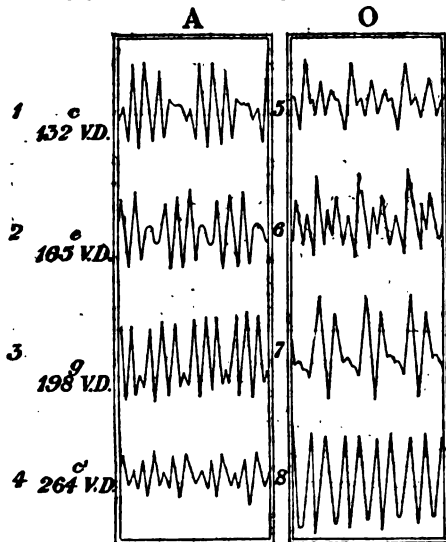

FIG. 2.

by private societies and by royal museums. In Hungary records of the various dialects have been secured. The possibilities of the gramophone as a teacher are far-reaching, not only in the domain of music but in learning languages, &c.

To understand how the phonograph records and reproduces musical tones, it is necessary to remember (1) that *pitch* or *frequency* depends on the number of vibrations executed by the vibrating body in a given period of time, or on the duration of each vibration; (2) that *intensity* or *loudness* depends on the amplitude of the movement of the vibrating body; and (3) that *quality, timbre* or *clang*, first, depends on the form of the individual vibrations, or rather on the power the ear possesses of appreciating a simple pendular vibration producing a pure tone, or of decomposing more or less completely a compound vibration into the simple pendular vibrations of which it is composed. If we apply this to the record of the phonograph, we find that, given a constant and sufficiently rapid velocity of the record, a note or tone of a certain pitch will be heard when the marker runs over a number of elevations and depressions corresponding to the frequency of that note. Thus if the note was produced by 200 vibrations per second, and suppose that it lasted in the music for $\frac{1}{10}$ of a second, 20 marks, each made in $\frac{1}{200}$ of a second, would be imprinted on the wax. Consequently, in reproduction, the marker would run over the 20 marks in $\frac{1}{10}$ of a second, and a tone of that frequency would be reproduced.

The loudness would correspond to the depth of each individual mark on the cylinder or the width on the disk. The greater the depth of a series of successive marks produced by a loud tone, the greater, in reproduction, would be the amplitude of the excursions of the glass disk and the louder would be the tone reproduced. Lastly, the form of the marks corresponding to individual vibrations would determine the quality of the tone or note reproduced, by which we can distinguish the tone of one instrument from another, or the sensation produced by a tone of pure and simple quality, like that from a well-bowed tuning-fork or an open organ pipe, and that given by a trumpet or an orchestra, in which the sounds of many instruments are blended together. When the phonograph records the sound of an orchestra it does not record the tones of each instrument, but it imprints the form of impression corresponding to the very complex sound-wave formed by all the instruments combined. This particular form, infinitely varied, will reproduce backwards,

as has been explained, by acting on the glass plate, the particular form of sound-wave corresponding to the sound of the orchestra. Numerous instruments blend their tones to make one wave-form, and when one instrument predominates, or if a human voice is singing to the accompaniment of the orchestra, another form of sound-wave, or rather a complex series of sound waves, is imprinted. When reproduced, the wave-forms again exist in the air as very complex variations of pressure; these act on the drum-head of the human ear, there is transmission to the brain, and there an analysis of the complex sensation takes place, and we distinguish the trombone from the oboe, or the human voice from the violin obbligato.

Many efforts have been made to obtain graphic tracings of wave-forms imprinted on the wax phonograph records. Thus J. G. M'Kendrick took (1) celloidin casts of the surface, and (2) micro-

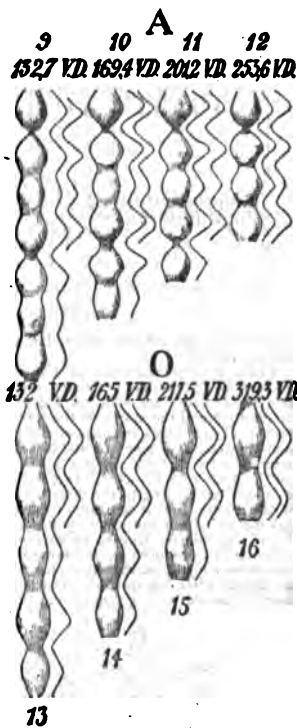

FIG. 3.

photographs of a small portion of the cylinder (*Journ. of Anat. and Phys.*, July 1895). He also devised a phonograph recorder by which the curves were much amplified (*Trans. Roy. Soc. Edin.*, vol. xxviii., *Proc. Roy. Soc. Edin.*, 1896-1897, Opening Address; *Sounds and Speech Waves as recorded by the Phonograph*, London, 1897; and *Schäfer's Physiol.*, vol. ii., "Vocal Sounds," p. 1229). As already mentioned, so long ago as 1873 Fleeming Jenkin and Ewing had examined the marks on the tin-foil phonograph. Professor Ludimar Hermann, of Königsberg, took up the subject about 1890, using the wax-cylinder phonograph. He obtained photographs of the curves on the wax cylinder, a beam of light reflected from a small mirror attached to the vibrating disk of the phonograph being allowed to fall on a sensitive plate while the phonograph was slowly travelling. (For references to Hermann's important papers, see *Schäfer's Physiology*, II. 1222.) Boeke, of Alkmaar, has devised an ingenious and accurate method of obtaining curves from the wax cylinder. He measured by means of a microscope the transverse diameter of the impressions on the surface of the cylinder, on different (generally equidistant) parts of the period, and he infers

from these measurements the depth of the impressions on the same spot, or, in other words, he derives from these measurements the curve of the vibrations of the tone which produced the impression

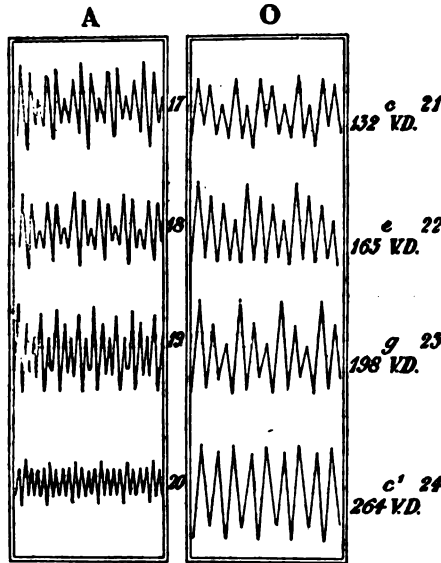

FIG. 4.

(Archiv. f. d. ges. Physiol. Bonn, Bd. 1, S. 297; also Proc. Roy. Soc. Edin., 1898).

From a communication to the Dutch Otorhinolaryngological Society Dr Boeke has permitted the author to select the accompanying illustrations, which will give the reader a fair conception of the nature of the marks on the wax cylinder produced by various tones. Fig. 2 shows portions of the curves obtained by Hermann, and enlarged by Boeke one and a half times. The numbers 1 to 4 refer to periods of the vowel A (as in "hard"), sung by Hermann on the notes *c e g c'*. Numbers 5 to 8 show the curves of the vowel *s* (as in "go") sung to the same notes. The number of vibrations is also noted. Boeke measured the marks for the same vowels by his method, from the same cylinder, and constructing the curves, found the relative lengths to be the same. In fig. 3 we see the indentations produced by the same vowels, sung by Hermann on the notes *c e g c'*, on the same phonograph cylinder, but delineated by Boeke after his method. The curves are also shown in linear fashion beside each group of indentations. From these measure-

ments the curves were calculated and reproduced, as in fig. 4. Thus the curves of the same vowel sounds on the same cylinder are shown by two methods, that of Hermann and that of Boeke.

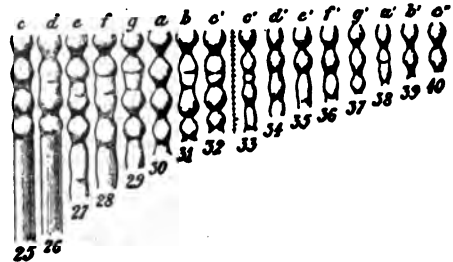

FIG. 5.

In fig. 5 we see the indentations on the vowel *a*, sung by Dr Boeke, aged 55, on the notes *c d e f g a b c'*, and near the frequencies of 128, 144, 160, 170-6, 192, 213-3, 240 and 256. The numbers 33 to 40 show the marks produced by the same vowel, sung by his son, aged 13. It will be seen that the boy sang the notes exactly an octave higher. Fig. 6 shows the marks produced by some musical

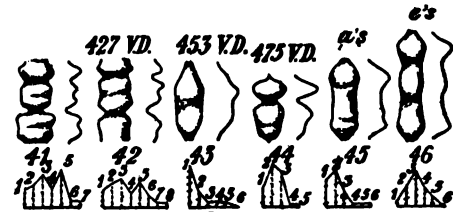

FIG. 6.

sounds. Each shows on the right-hand side the curve deduced from the marks, and under it a graphical representation of the results of its harmonic analysis after the theorem of Fourier, in which the ordinates represent the amplitude of the subsequent harmonic constituents. No. 41 is the period of the sound of a pitch-pipe giving *a'* (425 double vibrations per second), No. 42 the period of a Dutch pitch-pipe, also sounding *a'* (474-64 double vibrations per second). No. 43 is a record of the period of a sound produced by blowing between two strips of indiarubber to imitate the vocal cords, with a frequency of 453 double vibrations per second. No. 44 is that of a telephone pipe used by Hermann (503 double vibrations per second). Nos. 45 and 46 show the marks of a cornet sounding the notes *a* of 400 double vibrations per second, and *e* of 300 double vibrations per second. In fig. 7 are shown a number of vowel curves for the vowels *o, e, a, e, and l*. Each curve has on the right-hand side a graphical representation of its harmonic analysis. The curves are in five vertical columns, having on the

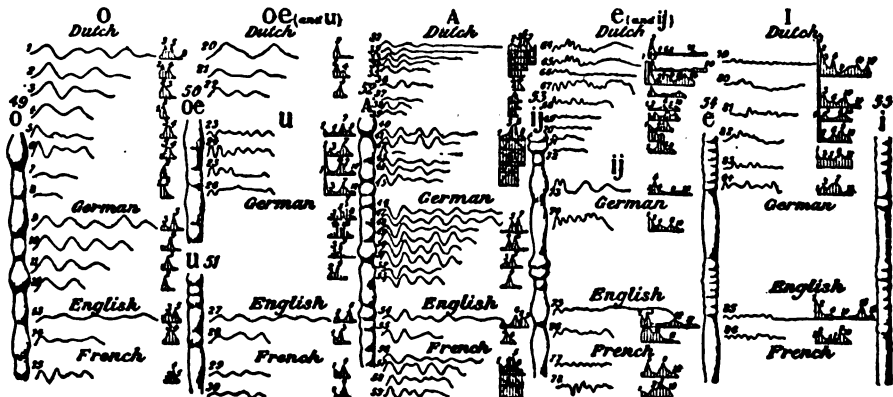

FIG. 7.

left-hand side of each drawing, by Boeke's method, of two periods of the marks of the vowel. The marks are shown for the Dutch, German, English and French languages. The sounds of the vowels are *a*, like *a* in "go"; *o*, like *o* in "too"; *u*, like the German *u* in "Führer"; *h*, like *a* in "hard"; *e*, like *e* in "take"; *i*, not in English words, but somewhat like *i* in "bell"; and *z*, like *z* in "beer." The first section contains only Dutch vowel sounds, either sung or spoken by Boeke or members of his family. The second section contains curves from the voice of Professor Hermann, the third from the voice of the author from a cylinder sent by him to Dr Boeke, and the fourth from the voice of Mlons. H. Manichelle, professeur de l'Institut des Sourds-Muets, also forwarded by him to Dr Boeke. Thus curves and marks of the same vowel are shown from the voices of men of four nationalities.

On the construction of the gramophone, see L. N. Reddie, *Journ. Soc. Arts* (1908).

PHONOLITE (Gr. *φωνή*, sound, and *λίθος*, stone), in petrology, a group of volcanic lavas containing much nepheline and sanidine feldspar. The term "clinkstone" was formerly given by geologists to many fine grained compact lavas, which split into thin tough plates, and gave out a ringing sound when struck with the hammer. Some of these clinkstones were phonolites in the modern sense, but as the name clinkstone was used for a large variety of rocks, many of which have no close affinities with one another, it has been discarded and "phonolite" is substituted for it. The group includes rocks which are rich in alkalis with only a moderate percentage of silica; hence they contain no free quartz but much alkali feldspar (sanidine and anorthoclase) and nepheline. Large plates of sanidine are often visible in the rocks; the nepheline is usually not obvious to the unaided eye. Most phonolites show fluxion structure, both in the orientation of their phenocrysts and in the smaller crystals which make up the ground-mass; and this determines to a large extent the platy jointing. Although vitreous and pumiceous forms are known they are rare, and in the great majority of cases these rocks are finely crystalline with a dull or shimmering lustre in the ground-mass. Marked characteristics are the readiness with which they decompose, and the frequency of veins and cavities occupied by natrolite, analcite, scolecite and other zeolites. Small black grains of augite or hornblende and sometimes blue specks of haüyne may be seen in the rocks when they are fresh.

The dominant minerals are sanidine, nepheline, pyroxene, amphibole, various feldspathoids and iron oxides. The sanidine is usually in two generations; the first consisting of large crystals of flattened and tabular shape, while the second generation is represented by small rectangular prisms arranged in parallel streams in the ground-mass; these feldspars are nearly always simply twinned on the Carlsbad plan. They contain often as much soda as potash. The nepheline takes the form of hexagonal prisms with flat ends, and may be completely replaced by fibrous zeolites, so that it can only be recognized by the outlines of its pseudomorphs. In some phonolites it is exceedingly abundant

magnetite and zircon occur in the phonolites, and sphene is often rather common. Another mineral which is more frequent in phonolites than in many other rocks is brown melanite garnet.

The majority of the rocks of this group are of Tertiary or Recent age, but in Scotland Carboniferous phonolites occur in several localities, e.g. Traprain in Haddingtonshire, also in the Eildon Hills and in Renfrewshire. In Brazil phonolites belonging to the same epoch are also known. There are several districts in Europe where Tertiary or Recent phonolites occur in considerable numbers, as in Auvergne (Mont Dore), the Eifel, and Bohemia. The Wolf Rock which lies off the south coast of Cornwall, and is the site of a well-known lighthouse, is the only mass of phonolite in England; it is supposed to be the remains of a Tertiary lava or intrusion. The Canary Islands, Cape Verde Islands, Sardinia, Aden, British East Africa and New Zealand contain many types of phonolites; they are known also in New South Wales, while in the United States phonolites occur in Colorado (at Cripple Creek) and in the Black Hills of South Dakota.

Leucite occurs in place of nepheline in a small group of phonolites (the leucite-phonolites), known principally from Rocca Monfina and other places near Naples. Blue haüyne is rather a conspicuous mineral in some of these rocks, and they also contain a good deal of sphene. When sanidine, nepheline and leucite all occur together in a volcanic rock it is classed among the leucitophyres (see PETROLOGY, Plate III. fig. 2).

The chemical analyses of phonolites given below show that these rocks are very rich in alkalis and alumina with only a moderate amount of silica, while lime, magnesia and iron oxides are present only in small quantity. They have a close resemblance in these respects to the nepheline-syenites of which they provide the effusive type. (J. S. F.)

PHORCYA (PHORCYS, PHORCYN), in Greek mythology, son of Pontus (Sea) and Gaëa (Earth), father of the Graeae, the Gorgons, Scylla, and Ladon (the dragon that guarded the golden apples of the Hesperides). In Homer (*Odyssey*, xiii. 96) he is an aged sea-deity, after whom a harbour in Ithaca was named. According to Varro (quoted by Servius in *Aeneid*, v. 824) Phorcys was a king of Corsica and Sardinia, who, having been defeated by King Atlas in a naval engagement in the course of which he was drowned, was subsequently worshipped as a marine divinity.

PHORMIUM, or NEW ZEALAND FLAX (also called "New Zealand hemp"), a fibre obtained from the leaves of *Phormium tenax* (nat. ord. Liliaceae), a native of New Zealand, the Chatham Islands and Norfolk Island. This useful plant is one of the many which were discovered by Sir Joseph Banks and Dr Solander who accompanied Captain Cook on his first voyage of discovery. The seeds brought home by Banks in 1771 did not succeed, but the plant was introduced by him to the Royal Gardens at Kew in 1789, and was thence liberally distributed

	SiO ₂	Al ₂ O ₃	Fe ₂ O ₃	FeO	MgO	CaO	Na ₂ O	K ₂ O	H ₂ O
I. Phonolite, Wolf Rock, Cornwall	56.46	22.29	2.70	0.97	tr	1.47	11.13	2.81	2.05
II. Phonolite, Teplitzer Schloßberg, Bohemia	58.16	21.57	2.77	—	1.26	2.01	5.97	6.57	2.03
III. Leucite-phonolite, Rocca Monfina, Italy	58.48	19.56	—	4.99	0.53	2.66	3.14	10.47	0.24

in the ground-mass, and these rocks form transitions to the nephelinites (nephelinitoid phonolites) (see PETROLOGY, Plate III. fig. 1); in others it is scarce and the rocks resemble trachytes containing a little nepheline (trachytoid phonolites). The feldspathoid minerals, sodalite, haüyne and nosean, which crystallize in isometric dodecahedra, are very frequent components of the phonolites; their crystals are often corroded or partly dissolved and their outlines may then be very irregular. Small rounded enclosures of glass are often numerous in them. The pyroxenes may be pale green diopside, dark green aegirine-augite, or blackish green aegirine (soda iron pyroxene), and in many cases are complex, the outer portions being aegirine while the centre is diopside. Fine needles of aegirine are often found in the ground-mass. The commonest hornblende is dark brown barkevicite. Biotite and olivine are not really frequent in these rocks, and usually have been affected by resorption. The ordinary accessory minerals of igneous rocks, apatite,

in Great Britain and the continent of Europe. It grows luxuriantly in the south of Ireland, where it was introduced in 1798, and also flourishes on the west coast of Scotland, and is generally cultivated as an ornamental garden plant in Europe. It has been introduced for economic purposes into the Azores and California. The name Phormium is from Gr. *φορμύς*, a basket, in allusion to one of the uses made of its leaves by the New Zealanders.

In its native country the plant is generally found near the coast. It has a fleshy rootstock, creeping beneath the surface of the soil and sending up luxuriant tufts of narrow, sword-shaped leaves, from 4 to 8 ft. long and from 2 to 4 in. in diameter. The leaves are vertical, and arranged in two rows as in the garden flag; they are very thick, stiff and leathery, dark green above, paler below, with the margin and nerve reddish-orange. From the centre of the tuft ultimately arises a tall flower-bearing stem, 5 to 15 ft. high, bearing on its numerous

branches a very large number of lurid red or yellow, somewhat tubular flowers, recalling those of an aloe, and from 1 to 2 in. long. After flowering the plant dies down, but increases by new lateral growths from the rootstock. The plant will grow in almost any soil, but best on light rich soil, by the side of rivers and brooks, where sheltered from the wind.

Phormium has been treated as a cultivated plant in New Zealand, though only to a limited extent; for the supplies of the raw material dependence has been principally placed on the abundance of the wild stocks and on sets planted as hedges and boundaries by the Maoris. Among these people the fibre has always been an article of considerable importance, yielding cloaks, mats, cordage, fishing-lines, &c., its valuable properties having attracted the attention of traders even before colonists settled in the islands. The leaves, for fibre-yielding purposes, come to maturity in about six months, and the habit of the Maoris is to cut them down twice a year, rejecting the outer and leaving the central immature leaves. Phormium is prepared with great care by native methods, only the mature fibres from the under-side of the leaves being taken. These are collected in water, scraped over the edge of a shell to free them from adhering cellular tissue and epidermis, and more than once washed in a running stream, followed by renewed scraping till the desired purity of fibre is attained. This native process is exceedingly wasteful, not more than one-fourth of the leaf-fibre being thereby utilized. But up till 1860 it was only native-prepared phormium that was known in the market, and it was on the material so carefully, but wastefully, selected that the reputation of the fibre was built up. The troubles with the Maoris at that period led the colonists to engage in the industry, and the sudden demand for all available fibres caused soon afterwards by the Civil War in America greatly stimulated their endeavours. Machinery was invented for disintegrating the leaves and freeing the fibre, and at the same time experiments were made with the view of obtaining it by water-retting, and by means of alkaline solutions and other chemical agencies. But the fibre produced by these rapid and economical means was very inferior in quality to the product of Maori handiwork, mainly because weak and undeveloped strands are, by machine preparation, unavoidably intermixed with the perfect fibres, which alone the Maoris select, and so the uniform quality and strength of the material are destroyed. The New Zealand government in 1893 offered a premium of £1750 for a machine which would treat the fibre satisfactorily, and a further £250 for a process of treating the tow; and with a view to creating further interest in the matter a member of a commission of inquiry visited England during 1897. The premium was again issued in 1899. In 1903 it was stated that a German chemist had discovered a method of working and spinning the New Zealand fibre. An idea of the extent of the growth of the fibre may be gathered from the fact that the exports for 1905 amounted to 28,877 bales at a value of nearly £700,000.

Phormium is a cream-coloured fibre with a fine silky gloss, capable of being spun and woven into many of the heavier textures for which flax is used, either alone or in combination with flax. It is, however, principally a cordage fibre, and in tensile strength it is second only to manila hemp; but it does not bear well the alternations of wet and dry to which ship-ropes are subject. The fibre has come into use as a suitable material for binder-twine as used in self-binding reaping machines.

PHORONIDEA, a zoological order, containing a single genus *Phoronis*, which is known to be of practically world-wide distribution, while there are many records of its larva, *Actinotrocha*, from localities where the adult has not been found. *Phoronis* is often gregarious, the tubes which it secretes being sometimes intertwined in an inextricable mass. These associations of individuals can hardly be the result of the metamorphosis of a corresponding number of larvae, but are probably due to a spontaneous fragmentation of the adult animals, each such fragment developing into a complete *Phoronis* (De Selys-Longchamps). The animal is from a quarter of an inch to six inches (*P. australis*) in length. The free end of the long vermiform body ends in a horseshoe-shaped "lophophore," or tentacle-bearing region (fig. 1, a), which strikingly resembles that of the *Phylactolaematus* Polyzoa (see POLYZOA).

In some species (figs. 2, 3) the two ends of the lophophore are rolled into spirals. An oral view of this region (fig. 2) shows: the mouth (m), continuous on either side with the groove between the two series of tentacles; the anus (a), in the middle line, at no great distance from the mouth; a transversely elongated epistome (ep), between the mouth and the anus; and, in the concavity of the lophophore, the apertures of the nephridia (n.o.) which, according to De Selys-Longchamps, open into the two large sensory or glandular "lophophoral organs," the orifices of which are seen at g. The mouth leads into the oesophagus, which extends straight down the body nearly to the aboral end or "ampulla," where it

dilates into a stomach, from which the ascending limb of the U-shaped alimentary canal passes directly to the anus. The coelomic body-cavity is divided by a transverse septum (fig. 3, s) which lies near the bases of the tentacles. The preseptal or lophophoral coelom is continued into each of the tentacles and into the

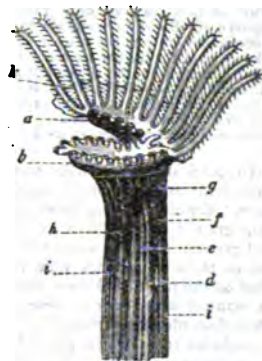

(After Allan.)

FIG. 1.—The Tentacular End of *Phoronis*, with most of the tentacles removed.

- a. The horseshoe-shaped lophophore.
 b. Mouth.
 c. Optical section of the epistome (seen immediately below the end of the reference-line).
 d. Oesophagus.
 e. Intestine.
 f. Efferent vessel.
 g. One of the two efferent lophophoral vessels, uniting to form f.
 h. Dorsal or afferent vessel.
 i. Body-wall.
 h. Fused bases of the tentacles.

epistome. The postseptal coelom is partially divided by a ventral mesentery which is attached along the entire length of the convex side of the loop of the alimentary canal (a, a') and by two lateral mesenteries (a'') which further connect the oesophagus with the

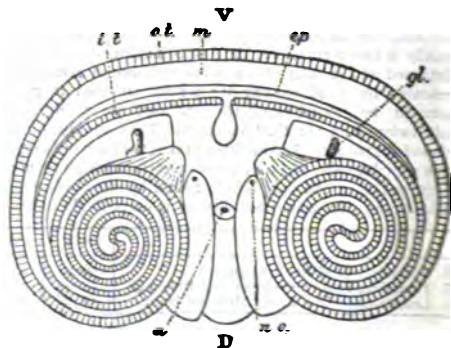

(After Busham.)

FIG. 2.—Dorsal View of *Phoronis australis*, showing the spirally coiled ends of the lophophore.

- a. Anus.
 D. Posterior surface.
 ep. Epistome.
 g. Lophophoral organ.
 i.t., Bases of inner tentacles.
 m. Position of the mouth.
 n.o., Nephridial surface.
 n.o., Nephridial opening.
 o.t., Bases of outer tentacles.
 V. Anterior surface.

body-wall. Each nephridium is provided with either one or two funnels which open into the postseptal division of the coelom (m.f.). The nervous system lies in the epidermis, externally to the basement-membrane. A general nerve-plexus probably exists over considerable parts of the skin, and there are special nervous concentrations in the region of the epistome and along a double crescent (N) which follows the parietal attachment of the coelomic septum. The part which lies at the base of the epistome is morphologically dorsal in position. It is said by Schultz (11) to develop, in specimens which are regenerating the lophophoral end, from an invagination of the ectoderm; and in this condition is compared by him with

the hollow central nervous system of some Ectoparasites and of Vertebrates. This comparison is not admitted by De Selys-Longchamps. The vascular system contains numerous red blood-corpuscles. The principal blood-channels are two longitudinal vessels which run down the entire length of the body, and are known as the "afferent" vessel (*af*) and the "efferent" vessel (*ef*) respectively, from their relation to the tentacles. According to researches in 1907 by De Selys-Longchamps, the blood is driven by the afferent vessel (*af*) to a crescentic lophophoral vessel (*d.v.*) which supplies the tentacles. Each of these contains a single blindly

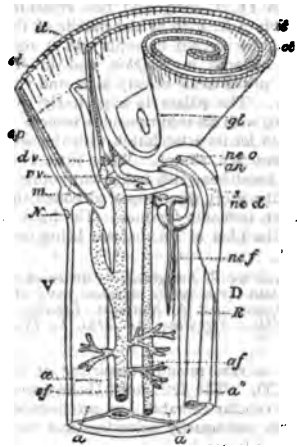

(From Fowler, after Behnam.)

FIG. 3.—Diagram of oral end of *Phoronis australis*, seen from the left side.

- | | |
|--------------------------------------|------------------------------------------|
| a, Oesophageal (ventral) mesenteric. | N, Post-oral nerve-tract at tery. |
| a', Right lateral mesenteric. | base of lophophore. |
| a'', Intestinal mesenteric. | ne.d., Duct of nephridium. |
| af, Afferent vessel. | ne.f., Larger nephridial funnel. |
| an, Anus. | ne.o., External opening of nephridium. |
| ep, Posterior surface. | o, Oesophagus. |
| d.v., Afferent lophophoral vessel. | ol., Bases of outer tentacles. |
| ef, Efferent vessel. | R, Intestine. |
| ep, Epistome. | r.v., Right efferent lophophoral vessel. |
| gl, Lophophoral organ. | s, Coelomic septum. |
| st, Bases of inner tentacles. | V, Anterior side. |
| m, Mouth. | |

ending vessel which bifurcates at its base (see fig. 3). One of these branches communicates with the afferent lophophoral vessel, while the other one opens into the crescentic efferent lophophoral vessel (*r.v.*). From this blood passes into two lateral vessels which pierce the coelomic septum (*s*), the right vessel proceeding on the anterior side of the oesophagus, as shown in fig. 3, to effect a union with the left one, and thus to constitute the main efferent vessel, which gives off numerous caecal branches as it passes down the body. Hence the blood returns once more to the afferent vessel through a splanchnic sinus which surrounds the stomach. The circulation is maintained by the rhythmical contraction of the afferent vessel and by less regular contractions of some of the other vessels. The reproductive organs lie on the left side, near the aboral end, both ovary and testis being present in the same individual in some of the species. They are said to be developed from the coelomic epithelium which covers the efferent vessel or its caeca. The reproductive cells pass to the exterior by means of the nephridia. Reproduction by budding does not occur, although spontaneous fragmentation of the body, followed by complete regeneration of each of the pieces, is known to take place. Regeneration of the tentacular end of the animal is of frequent occurrence.

Development and Affinities.—The eggs of *Phoronis* are small and usually undergo their early development attached to the tentacles of the adult. The attachment is probably effected (Masterman) by the secretion of the lophophoral organs (fig. 2, *gl.*). After the formation of an invaginate gastrula the larval form is rapidly acquired. On quitting the shelter of the parent tentacles the embryo becomes a pelagic larva, known as *Actinotrocha* (fig. 4) characterized by the possession of a line of tentacles running obliquely round the body. Locomotion is effected principally by means of a posterior ring of cilia surrounding the anus. The mouth (*o*) is in front of the tentacles, on the ventral side, and is overhung by a mobile **praecoral hood**, in which is the principal part of the nervous system.

An oblique septum which follows the bases of the tentacles and corresponds with that of the adult animal divides the body-cavity into two portions. The postseptal division is a coelomic space, partially subdivided by a ventral mesentery. The praeseptal cavity is a vascular space, since it is in free communication with the dorsal vessel of the larva, and it persists in part as the two lophophoral vascular crescents of the adult. It contains two tufts of peculiar excretory cells, described by Goodrich (5) as "solenocytes," which surround the blind ends of a pair of nephridia. These pass backwards through the septum and open to the exterior ventrally. After the *Actinotrocha* has led a pelagic life for some time it develops a large ventral invagination of its body-wall (fig. 4, 2, *iv.*). At the metamorphosis, this sac is everted and the alimentary canal is drawn into it in the form of a loop (fig. 4, 3, 4). Most of the praetentacular region and the larval tentacles separate off, being then taken into the alimentary canal, where they are digested. The relations of the surfaces after the metamorphosis are clearly very different from those which obtained in the larva. The dorsal surface of the adult is the one between the mouth and the anus, while the median ventral line is the one which corresponds with the convexity of the alimentary canal. This view of the surfaces is, however, disputed by De Selys-Longchamps, who regards the aboral extremity of the adult as the posterior end.

The development of *Phoronis* was supposed by Caldwell (2) to furnish the explanation of the relations of the surfaces in Brachiopoda, Polyzoa and perhaps the Sipunculoid Gephyrea, in which the ontogenetic evidence is less clear. Caldwell's views were accepted by Lankester (8) in the 9th edition of this work, the Phylum Podaxozoa being there instituted to include the groups just mentioned, together with the Pterobranchia. The peduncle of the Brachiopoda was supposed to correspond with the everted ventral sac of *Actinotrocha*, but the question is complicated by the want of any complete investigation of the development of the Brachiopoda, and by the absence of the anus in the majority of the genera. There is, however, a considerable amount of resemblance between the lophophore of *Phoronis australis*, with its spirally twisted ends, and that of a typical Brachiopod; nor do the structural details of the adult Brachiopods forbid the view that they may be related to *Phoronis*. The comparative study of the development does not support the hypothesis that the Polyzoa (*q.v.*) are comparable with *Phoronis*. In *Pedicularia*, the only Polyzoan in which the alimentary canal of the larva is known to become that of the first adult individual, the line between the mouth and anus is ventral in the larva; and since there is no reversal of the curvature of the digestive loop during the metamorphosis it must be regarded as ventral in the adult. There are, indeed, remarkable similarities between the external characters of the Phylactolaematus Polyzoa and the Phoronidea, and notably between their lophophores. The supposed occurrence of a pair of nephridia in certain Phylactolaemata, in a position corresponding with that of the nephridia of *Phoronis*, must also be mentioned,

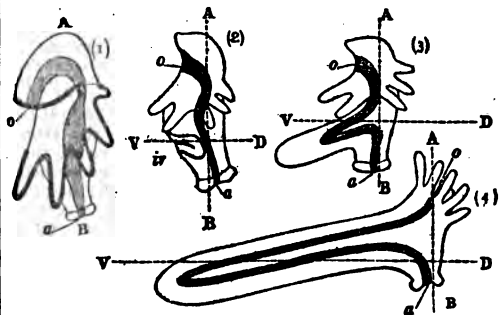

FIG. 4.—Diagrams illustrating the Metamorphosis of *Actinotrocha*.

- | | |
|-----------------------------|-----------------------------------------------------------------------------------------------------------|
| AB, Anteroposterior axis. | 3, Commencement of the metamorphosis. |
| DV, Dorsoventral axis. | 4, Later stage in the metamorphosis: <i>a</i> , anus; <i>iv</i> , ventral invagination; <i>o</i> , mouth. |
| 1, 2, <i>Actinotrocha</i> . | |

although it has been maintained that the "nephridia" of Phylactolaemata are merely ciliated portions of the body-cavity and not indeed nephridia at all. But a serious objection to the comparison is that the development of Phylactolaemata can be explained by supposing it to be a modification of what occurs in other Polyzoa, while it appears to have no relation whatever to that of *Phoronis*. Most observers consider that *Actinotrocha* is a highly modified Trochophore, and this would give it some claim to be regarded as distantly related to the Entoproct Polyzoa and to other groups which have a Trochophore larva.

Phoronis has long been regarded as a possible ally of *Rhabdopleura* (see PTERORHACHIA); and Masterman (10) has attempted to demonstrate the existence in *Actinotrocha* of most of the structures which occur in the Pterobranchia. According to his view the praerostral hood of *Actinotrocha* (cf. fig. 4) corresponds with the "proboscis" of Pterobranchia; the succeeding region, as far as the bases of the tentacles, with the collar; and the post-tentacular region with the metacoelom. Masterman's more detailed comparisons have for the most part been rejected by other morphologists. One of the most formidable difficulties in the way of the attempt to reduce *Actinotrocha* to the Pterobranchiate type of structure is the condition of the coelom in the former. There is indeed a perfectly definite transverse septum which divides the body-cavity in the region of the tentacle-bases. Even if it be admitted that the post-septal space may be the metacoelomic cavity, the praeseptal space can hardly be regarded as coelomic in nature, since it is in continuity with the vascular system; while Masterman's conclusion that the cavity of the praerostral hood (the supposed proboscis-cavity) is separated from that of the supposed collar has received no confirmation. In spite of these difficulties it must be conceded that the dorsal flexure of the alimentary canal of the Pterobranchia is very *Phoronis*-like. It has, moreover, been shown (see especially Goodrich, 5) that shortly before its metamorphosis, *Actinotrocha* develops a coelomic space which lies immediately in front of the oblique septum, and gives rise later to the cavity of the lophophore and tentacles. Regarding this as a collar-cavity, it becomes possible to agree with Masterman that the region shown in fig. 4, 1. between the tentacles and the praerostral hood, is really a collar the coelom of which develops relatively late. It will be noticed that the lophophore of *Phoronis* is, on this assumption, a derivative of the collar just as it is in the Pterobranchia. The epistome of the adult *Phoronis* cannot well be the proboscis since its cavity is continuous with the lophophoral coelom, and because the praerostral hood of *Actinotrocha* is entirely lost at the metamorphosis. It is possible that this consideration will account for the want of an anterior body-cavity in *Phoronis*. Since the proboscis is a purely larval organ in this genus, it may be supposed that the coelomic space which properly belongs to it fails to develop, but that the praerostral hood itself is none the less the morphological representative of the proboscis. In spite of the criticisms which have been made on the conclusion that *Phoronis* is allied to the Pterobranchia, it is thus possible that the view is a sound one, and that the Phoronidea should take their place, with the Enteropneusta and the Pterobranchia, as an order of the Hemichordata.

BIBLIOGRAPHY.—(1) Benham, *Quart. Journ. Mic. Soc.* xxx. 125 (1890); (2) Caldwell, *Proc. Roy. Soc.* xxvii. 371 (1883); (3) Cori, *Zeitschr. wiss. Zool.* li. 480 (1891); (4) Fowler, art. "Hemichorda," *Ency. Brit.* xxix. 249 (1902); (5) Goodrich, *Quart. Journ. Mic. Soc.* xlvii. 103 (1904); (6) Harmer, *Siboga Rep.* xxvi. 114, bis (Pterobranchia), (1905); (7) Ikeda, *J. Coll. Sci. Japan*, xiii. 507 (1901); (8) Lankester, art. "Polyzoa," *Ency. Brit.* xix. 430, 433 (1885); (9) De Selys-Longchamps, *Arch. Biol.* xviii. 495 (1902); *Wiss. Meeresunt.* (N. F.) vi. Abt. Helgoland (1903), *Left* i.; *Mém. classe sci. acad. Belgique*, vol. i. (1904); *Fauna u. Flora G. v. Neapel*, 30 Monogr. (1907); (10) Masterman, *Quart. Journ. Mic. Soc.* xl. 281 (1898); xliii. 375 (1900); (11) Schultz, *Zeitschr. wiss. Zool.* lxxv. 391, 473 (1903); (12) Shearer, *Milch: zool. Stat. Neapel*, xvii. 487 (1906); (13) Shipley, *Cambr. Nat. Hist.* ii. 450 (1896).

(S. F. H.)

PHORORHACOS, the best-known genus of the extinct Patagonian *Stereornithes* (see BIRD: *Fossil*). Among the bones found in the strata of the Santa Cruz formation (now considered as mainly of mid-Miocene date) was the piece of a mandible which F. Ameghino described in 1837 as that of an edentate mammal, under the name of *Phoryrhacos longissimus* (*Bolet. Mus. de la Plata*, i. 24). In 1891 (*Rev. Argent. Hist. Nat.* i. 225)

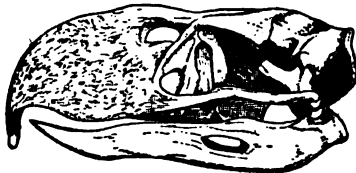

(From life-size model in Brit. Mus. Nat. Hist.)
Skull of *Phororhacos longissimus*.

he amended the name and recognized the bone as that of a bird, *Phororhacos*, which with *Brentornis* and others constituted the family *Phororhacidae*. About six species of the type genus are now known, the most complete being *Ph. inflatus*, with skull, mandible, pelvis, limbs and some of the vertebrae.

These birds were at first considered as either belonging to the Ratitae, or at least related to them, until C. W. Andrews, after much of the interesting material had been acquired by the British Museum, showed the gruiform affinities of *Phororhacos* (*Ibis*, 1896, pp. 1-12), a conclusion which he was able to further corroborate after the clearing of the adherent stony matrix from the skulls (*Tr. Z. S.* 1901, xv. pp. 55-86, pls. 14-17). The skull of *Ph. longissimus* is about 2 ft. long and 10 in. high; that of *Ph. inflatus* is 13 in. long, and this creature is supposed to have stood only 3 ft. high at the middle of the back. The under jaw is slightly curved upwards and it contains a large foramen as for instance in *Psophia* and in *Mycteria*. The strongly hooked upper beak is very high, and very much compressed laterally. The palate is imperfectly desmognathous, as in *Dicholophus*, with an inconspicuous vomer. The quadrate has a double knob for its articulation with the skull, and basipterygoid processes are absent. What little is known of the shoulder-girdle (breastbone still unknown) points to a flightless bird, and so do the short wing bones, although these are stout. The pelvis has the ischiadic foramen. The hind limbs are distinctly slender, the tibia of *Ph. inflatus* being between 15 and 16 in. in length.

For further detail see F. Ameghino, "Sur les oiseaux fossiles de la Patagonie," *Bolet. inst. geogr. argentino*, xv. chs. 11 and 12 (1895); F. P. Moreno and A. Mercet, *Catálogo de los pájaros fosiles de la República Argentina*, An. Mus. La Plata (1891; with 21 plates). (H. F. G.)

PHOSGENITE, a rare mineral consisting of lead chlorocarbonate, (PbCl)₂CO₃. The tetragonal (holosymmetric) crystals are prismatic or tabular in habit, and are bounded by smooth, bright faces: they are usually colourless and transparent, and have a brilliant adamantine lustre. Sometimes the crystals have a curious helical twist about the tetrad or principal axis. The hardness is 3 and the specific gravity 6.3. The mineral is rather sectile, and consequently was early known as "corneous lead" (Ger. *Hornblei*). The fanciful name phosgenite was given by A. Breithaupt in 1820, from phosgene, the old name of carbon oxychloride, because the mineral contains the elements carbon, oxygen and chlorine. At Cromford, near Matlock, it was long ago found in an old lead mine, being associated with anglesite and matlockite (PbOCl₂) in cavities in decomposed galena; hence its common name cronfortite. Fine crystals are also found in galena at Monteponi near Iglesias in Sardinia, but the largest are those recently found near Dundas in Tasmania. Crystals of phosgenite, and also of the corresponding bromine compound [PbBr]₂CO₃, have been prepared artificially.

(L. J. S.)

PHOSPHATES, in chemistry, the name given to salts of phosphoric acid. As stated under PHOSPHORUS, phosphoric oxide, P₂O₅, combines with water in three proportions to form H₂O·P₂O₅ or HPO₃, metaphosphoric acid; 2H₂O·P₂O₅ or H₂P₂O₇, pyrophosphoric acid; and 3H₂O·P₂O₅ or H₃PO₄, orthophosphoric or ordinary phosphoric acid. These acids each give origin to several series of salts, those of ordinary phosphoric acid being the most important, and, in addition, are widely distributed in the mineral kingdom (see below under *Mineral Phosphates*).

Orthophosphoric acid, H₃PO₄, a tribasic acid, is obtained by boiling a solution of the pentoxide in water; by oxidizing red phosphorus with nitric acid, or yellow phosphorus under the surface of water by bromine or iodine; and also by decomposing a mineral phosphate with sulphuric acid. It usually forms a thin syrup which on concentration in a vacuum over sulphuric acid deposits hard, transparent, rhombic prisms which melt at 41.7°. On long heating the syrup is partially converted into pyrophosphoric and metaphosphoric acids, but on adding water and boiling the ortho-acid is re-formed. It gives origin to three classes of salts: M'H₂PO₄ or M'H₂P₂O₇; M'HPO₃ or M'H₂P₂O₇, M'₂PO₄, M',P₂O₇, or M'''PO₄, wherein M', M'', M''' denote a mono-, di-, and tri-valent metal. The first set may be called monometallic, the second dimetallic, and the third trimetallic salts. Per-acid salts of the alkalis, e.g. (K,Na,NH₄)₂H₂(PO₃)₂, are also known; these may be regarded as composed of a monometallic phosphate

with phosphoric acid, thus $M'H_2PO_4$, H_2PO_4 . The three principal groups differ remarkably in their behaviour towards indicators. The monometallic salts are strongly acid, the dimetallic are neutral or faintly alkaline, whilst the soluble trimetallic salts are strongly alkaline. The monometallic salts of the alkalis and alkaline earths may be obtained in crystal form, but those of the heavy metals are only stable when in solution. The soluble trimetallic salts are decomposed by carbonic acid into a dimetallic salt and an acid carbonate. All soluble orthophosphates give with silver nitrate a characteristic yellow precipitate of silver phosphate, Ag_3PO_4 , soluble in ammonia and in nitric acid. Since the reaction with the acid salts is attended by liberation of nitric acid: $NaH_2PO_4 + 3AgNO_3 = Ag_3PO_4 + NaNO_3 + 2HNO_3$, $Na_2HPO_4 + 3AgNO_3 = Ag_3PO_4 + 2NaNO_3 + HNO_3$, it is necessary to neutralize the nitric acid if the complete precipitation of the phosphoric acid be desired. The three series also differ when heated: the trimetallic salts, containing fixed bases are unaltered, whilst the mono- and dimetallic salts yield meta- and pyrophosphates respectively. If the heating be with charcoal, the trimetallic salts of the alkalis and alkaline earths are unaltered, whilst the mono- and di-salts give free phosphorus and a trimetallic salt. Other precipitants of phosphoric acid or its salts in solution are: ammonium molybdate in nitric acid, which gives on heating a canary-yellow precipitate of ammonium phosphomolybdate, $12[MoO_4](NH_4)_3PO_4$, insoluble in acids but readily soluble in ammonia; magnesium chloride, ammonium chloride and ammonia, which give on standing in a warm place a white crystalline precipitate of magnesium ammonium phosphate, $Mg(NH_4)PO_4 \cdot 6H_2O$, which is soluble in acids but highly insoluble in ammonia solutions, and on heating to redness gives magnesium pyrophosphate, $Mg_2P_2O_7$; uranic nitrate and ferric chloride, which give a yellowish-white precipitate, soluble in hydrochloric acid and ammonia, but insoluble in acetic acid; mercurous nitrate which gives a white precipitate, soluble in nitric acid, and bismuth nitrate which gives a white precipitate, insoluble in nitric acid.

Pyrophosphoric acid, $H_2P_2O_7$, is a tetrabasic acid which may be regarded as derived by eliminating a molecule of water between two molecules of ordinary phosphoric acid; its constitution may therefore be written $(HO)_2OP-O-PO(OH)_2$. It may be obtained as a glassy mass, indistinguishable from metaphosphoric acid, by heating phosphoric acid to 215° . When boiled with water it forms the ortho-acid, and when heated to redness the meta-acid. After neutralization, it gives a white precipitate with silver nitrate. Being a tetrabasic acid it can form four classes of salts; for example, the four sodium salts $Na_4P_2O_7$, $Na_3HP_2O_7$, $Na_2H_2P_2O_7$, $NaH_3P_2O_7$, are known. The most important is the normal salt, $Na_4P_2O_7$, which is readily obtained by heating disodium orthophosphate, Na_2HPO_4 . It forms monoclinic prisms (with $10H_2O$) which are permanent in air. All soluble pyrophosphates when boiled with water for a long time are converted into orthophosphates.

Metaphosphoric acid, HPO_3 , is a monobasic acid which may be regarded as derived from orthophosphoric acid by the abstraction of one molecule of water, thus $H_2PO_4 - H_2O = HPO_3$; its constitution is therefore $(HO)PO_3$. The acid is formed by dissolving phosphorus pentoxide in cold water, or by strongly heating orthophosphoric acid. It forms a colourless vitreous mass, hence its name "glacial phosphoric acid." It is readily soluble in water, the solution being gradually transformed into the ortho-acid, a reaction which proceeds much more rapidly on boiling. Although the acid is monobasic, salts of polymeric forms exist of the types $(MPO)_n$, where n may be 1, 2, 3, 4, 6. They may be obtained by heating a monometallic orthophosphate of a fixed base, or a dimetallic orthophosphate of one fixed and one volatile base, e.g. microcosmic salt: $MH_2PO_4 = MPO_3 + H_2O$, $(NH_4)_2NaHPO_4 = Na_2PO_7 + NH_3 + H_2O$; they may also be obtained by acting with phosphorus pentoxide on trimetallic orthophosphates: $Na_3PO_4 + P_2O_5 = 3NaPO_3$. The salts are usually non-crystalline and fusible. On boiling their solutions they yield orthophosphates, whilst those of the heavy metals on boiling with water give a trimetallic orthophosphate and orthophosphoric acid:

$3AgPO_3 + 3H_2O = Ag_3PO_4 + 2H_2PO_4$. On heating with an oxide or carbonate they yield a trimetallic orthophosphate, carbon dioxide being evolved in the latter case. Metaphosphoric acid can be distinguished from the other two acids by its power of coagulating albumen, and by not being precipitated by magnesium and ammonium chlorides in the presence of ammonia.

(C. E. *)

Mineral Phosphates.—Those varieties of native calcium phosphate which are not distinctly crystallized, like apatite (*q.v.*), but occur in fibrous, compact or earthy masses, often nodular, and more or less impure, are included under the general term phosphorite. The name seems to have been given originally to the Spanish phosphorite, probably because it phosphoresced when heated. This mineral, known as Estremadura phosphate, occurs at Logrossan and Cáceres, where it forms an important deposit in clay-slate. It may contain from 55 to 62% of calcium phosphate, with about 7% of magnesium phosphate. A somewhat similar mineral, forming a fibrous incrustation, with a mammillary surface, and containing about 9% of calcium carbonate, is known as staffelite, a name given by A. Stein in 1866 from the locality Staffel, in the valley of the Lower Lahn, where (as also in the valley of its tributary the Dill) large deposits of phosphorite occur. Dabillite is a Norwegian phosphorite, containing calcium carbonate, named in 1888 by W. C. Brøgger and H. Bäckström after the Norwegian geologists T. and J. Dahll. Osteolite is a white earthy phosphorite occurring in the clefts of basaltic rocks, named in 1851 by J. C. Brømer from the Greek *ostion*, bone.

Phosphorite, when occurring in large deposits, is a mineral of much economic value for conversion into the superphosphate largely used as a fertilizing agent. Many of the impure substances thus utilized are not strictly phosphorite, but pass under such names as "rock-phosphate," or, when nodular, as "coprolite" (*q.v.*), even if not of true coprolitic origin. The ultimate source of these mineral phosphates may be referred in most cases to the apatite widely distributed in crystalline rocks. Being soluble in water containing carbonic acid or organic acids it may be readily removed in solution, and may thus furnish plants and animals with the phosphates required in their structures. On the decay of these structures the phosphates are returned to the inorganic world, thus completing the cycle.

There are three sources of phosphates which are of importance geologically. They occur (a) in crystalline igneous and metamorphic rocks as an original constituent, (b) in veins associated with igneous rocks, and (c) in sedimentary rocks either as organic fragments or in secondary concretionary forms.

The first mode of occurrence is of little significance practically, for the crystalline rocks generally contain too little phosphate to be valuable, though occasionally an igneous rock may contain enough apatite to form an inferior fertilizing agent, e.g. the trachyte of Cabo de Gata in south-east Spain, which contains 12-15% of phosphoric acid. In many deposits of iron ores found in connexion with igneous or metamorphic rocks small quantities of phosphate occur. The Swedish, Norwegian, Ontario and Michigan mines yield ores of this kind; and though none of them can be profitably worked as a source of phosphate, yet on reducing the ore it may be retained in the slags, and thus rendered available for agriculture.

Another group of phosphatic deposits connected with igneous rocks comprises the apatite veins of south Norway, Ottawa and other districts in Canada. These are of pneumatolytic origin (see PNEUMATOLYSIS), and have been formed by the action of vapours emanating from cooling bodies of basic eruptive rock. Veins of this type occur at Oedegarden in Norway and Dundret in Lapland. From 1500 to 3500 tons of apatite are obtained yearly in Norway from these veins. In Ontario apatite has been worked for a long time in deposits of similar nature. The total output of Canada in 1907 was only 680 tons.

The phosphatic rocks which occur among the sedimentary strata are the principal sources of phosphates for commerce and agriculture. They are found in formations of all ages from the Cambrian to those which are accumulating at the present day. Of the latter the best known is guano (see MANURES and MANURING).

Where guano-beds are exposed to rain their soluble constituents are removed and the insoluble matters left behind. The soluble phosphates washed out of the guano may become fixed by entering into combination with the elements of the rock beneath. Many of the oceanic islets are composed of coral limestone, which in this

way becomes phosphatized; others are igneous, consisting of trachyte or basalt, and these rocks are also phosphatized on their surfaces but are not so valuable, inasmuch as the presence of iron or alumina in any quantity renders them unsuited for the preparation of artificial manures.

The leached guano and phosphatized rocks, which are grouped with them for commercial purposes, have been obtained in great quantities in many islands of the Pacific Ocean (such as Baker, Howland, Jarvis and McKean Islands) between long. 150° to 180° W. and lat. 10° N. to 10° S. In the West Indies from Venezuela to the Bahamas and in the Caribbean Sea many islands yield supplies of leached guano; the following are important in this respect: Sombbrero, Navassa, Aves, Aruba, Curacao. Christmas Island has been a great source of phosphates of this type; also Jaluit Island in the Maldive Archipelago, Banaba or Ocean Island, and Nauru or Pleasant Island. On Christmas Island the phosphate has been quarried to depths of 100 ft. To these leached guano and phosphatized limestones the name *sombrerite* has been given. It has been estimated that 500,000 tons of phosphate were obtained in Aruba, 1,000,000 tons from Curacao since the deposits were discovered in 1870, and Christmas Island in 1907 yielded 290,000 tons.

In the older formations the phosphates tend to become more and more mineralized by chemical processes. In whatever form they were originally deposited they often suffer complete or partial solution and are redeposited as concretionary lumps and nodules, often called coprolites. The "Challenger" and other oceanographic expeditions have shown that on the bottom of the deep sea concretions of phosphate are now gathering around the dead bodies of fishes lying in the ooze; consequently the formation of the concretions may have been carried on simultaneously with the deposition of the strata in which they occur.

Important deposits of mineral phosphates are now worked on a large scale in the United States, the annual yield far surpassing that of any other part of the world. The most active operations are carried on in Florida, where the phosphate was first worked in 1887 in the form of pebbles in the gravels of Peace river. Then followed the discovery of "hard rock-phosphate," a massive mineral, often having cavities lined with nearly pure phosphorite. Other kinds not distinctly hard and consisting of less rich phosphatic limestone, are known as "soft phosphate": those found as smooth pebbles of variable colour are called "land pebble-phosphate," whilst the pebbles of the river-beds and old river-valleys, usually of dark colour, are distinguished as "river pebble-phosphate." The land pebble is worked in central South Florida; the hard rock chiefly between Albion and Bay City. In South Carolina, where there are important deposits of phosphate, formerly more productive than at present, the "land rock" is worked near Charleston, and the "river rock" in the Coosaw river and other streams near Beaufort. The phosphate beds contain Eocene fossils derived from the underlying strata and many fragments of Pleistocene vertebrata such as mastodon, elephant, stag, horse, pig, &c. The phosphate occurs as lumps varying greatly in size, scattered through a sand or clay; they often contain phosphatized Eocene fossils (Mollusca, &c.). Sometimes the phosphate is found at the surface, but generally it is covered by alluvial sands and clays. Phosphate mining began in South Carolina in 1868, and for twenty years that state was the principal producer. Then the Florida deposits began to be worked. In 1892 the phosphates of Tennessee, derived from Ordovician limestones, came into the market. From North Carolina, Alabama and Pennsylvania, also, phosphates have been obtained but only in comparatively small quantities. In 1900 mining for phosphates was commenced in Arkansas. In 1908 Florida produced 1,673,651 tons of phosphate valued at 11 million dollars. All the other states together produce less phosphate than Florida, and among them Tennessee takes the first place with an output of 403,180 tons.

Algeria contains important deposits of phosphorite, especially near Tebessa and at Tocqueville in the province of Constantine. Near Jebel Kouif, on the frontier between Algeria and Tunis, there are phosphate workings, as also in Tunis, at Gafsa. The deposits belong to the Lower Eocene, where it rests unconformably upon the Cretaceous. The joint production of Tunis and

Algeria in 1907 was not less than a million tons. Phosphates occur also in Egypt, in the desert east of Keneh and in the Dakla oasis in the Libyan desert.

France is rich in mineral phosphates, the chief deposits being the departments of the Pas-de-Calais, Somme, Aisne, Oise and Meuse, in the north-east, and another group in the departments of Lot, Tarn-et-Garonne and Aveyron, in the south-west: phosphates occur also in the Pyrenees. The deposits near Caylus and in Quercy occupy fissures and pockets in Jurassic limestone, and have yielded a remarkable assemblage of the relics of Tertiary mammals and other fossils. Phosphates occur in Belgium, especially near Mons, and these, like those of north-east France, are principally in the Upper Chalk. Two varieties of phosphate rock are recognised in these districts, viz. the phosphatic chalk and the phosphate sand, the latter resulting from the decomposition of the former. Large and valuable deposits of the sand have been obtained in sinks and depressions on the surface of the chalk. The production is on the whole diminishing in Belgium (180,000 tons in 1907), but in France it is still large (375,000 tons in 1907).

In the Lahn district of Nassau (Germany) there are phosphate beds in Devonian rocks. The deposits were rich but irregular and local, and were much worked from 1866 to 1884, but are no longer of economic importance. In northern Estremadura in Spain and Alemtezo in Portugal there are vein deposits of phosphate of lime. As much as 200,000 tons of phosphate have been raised in these provinces, but in 1906 the total production of Spain was only 1300 tons. Large deposits of phosphate occur in Russia, and those in the neighbourhood of Kertch have attracted some attention; it is said that the Cretaceous rocks between the rivers Dniester and Volga contain very large supplies of phosphate; though probably of low grade.

Phosphatic nodules and concretions, with phosphatized fossils and their casts, occur at various geological horizons in Great Britain. Bands of black nodules, highly phosphatic, are found at the top of the Bala limestone in North Wales; beds of concretions occur in the Jurassic series; and important deposits are known in the Cretaceous strata, especially in the Lower Greensand and at the base of the Gault. The Lower Greensand phosphates have been worked, under the name of "coprolites," at Pottos in Bedfordshire and at Upware and Wickon in Cambridgeshire. The Cambridge Greensand, rich in phosphatic nodules, occurs at the base of the Chalk Marl. The chalk occasionally becomes phosphatized, as at Taplow (Bucks) and Leves (Sussex). At the base of the Red Crag in East Anglia, and occasionally at the base of the other Pliocene Crags, there is a "nodule bed," consisting of phosphatic nodules, with rolled teeth and bones, which were formerly worked as "coprolites" for the preparation of artificial manure. Professor R. J. Strutt has found that phosphatized nodules and bones are rich in radioactive constituents, and has brought this into relation with their geological age.

BIBLIOGRAPHY.—For American phosphates see *The Phosphates of America*, by Francis Wyatt (5th ed., New York and London, 1894); the Annual Reports on *Mineral Resources of the U.S.* (U.S. Geol. Survey), including some valuable reports by C. W. Hayes, also those in Rothwell's *Mineral Industry*; "Nature and Origin of Deposits of Phosphate of Lime," by R. A. F. Penrose, Jun., *Bull. U.S. Geol. Survey*, No. 45 (1888); *Florida, South Carolina and Canadian Phosphates*, by C. C. Hoyer Miller (London, 1892); and *The Non-metallic Minerals*, by G. P. Merrill (1904). Many of the above include descriptions of mineral phosphates in other parts of the world. For a general discussion of the origin of the phosphates, see "The Natural History of Phosphate Deposits," by J. J. H. Teall, *Proc. Geol. Assoc.* xvi. 369 (1900). Consult also *Etude complète sur les phosphates*, by A. Deckers (Liège, 1894).

(J. S. F.; F. W. R.)

PHOSPHORESCENCE, a name given to a variety of physical phenomena due to different causes, but all consisting in the emission of a pale, more or less ill-defined light, not obviously due to combustion. The word was first used by physicists to describe the property possessed by many substances of themselves becoming luminous after exposure to light. This property has been noticed from early times. Pliny speaks of various gems which shine with a light of their own, and Albertus Magnus knew that the diamond becomes phosphorescent when moderately heated. But the first discovery of this property which apparently attracted scientific attention seems to have been that of the Bologna stone (barium sulphide), which was discovered

by Vincenzo Cascariolo, a cobbler of Bologna, in about 1602. This was followed by the discovery of a number of other substances which become luminous either after exposure to light or on heating, or by attrition, and to which the general name of "phosphori" (from $\phi\acute{o\sigma$ and $\phi\acute{o\sigma}\rho\acute{o}\varsigma$, bringing light) was given. Among these may be mentioned Homberg's phosphorus (calcium chloride), John Canton's phosphorus (calcium sulphide) and Baldwin's phosphorus (calcium nitrate). Of late years it has been found convenient to limit the strict meaning of the word "phosphorescence" to the case of bodies which, after exposure to light, become self-luminous (even if only for a fraction of a second). The general term "luminescence" has been proposed by E. Wiedemann to include all cases in which bodies give off light not due to ignition. This general term embraces several subdivisions. Thus, fluorescence (q.v.) and phosphorescence are included under the same heading, "photoluminescence," being distinguished from each other only by the fact that fluorescent bodies emit their characteristic light only while under the influence of the exciting illumination, while phosphorescent bodies are luminous for an appreciable time after the exciting light is cut off.

Phosphorescence, in its restricted meaning as above explained, is most strikingly exhibited by the artificial sulphides of calcium, strontium and barium. If any of these substances is exposed for some time to daylight, or, better, to direct sunlight, or to the light of the electric arc, it will shine for hours in the dark with a soft coloured light. The colour depends not only on the nature of the substance, but also on its physical condition, and on its temperature during insolation, that is, exposure to the sun's rays. Thus the phosphorescent light emitted by calcium sulphide may be orange-yellow, yellow, green or violet, according to the method of preparation and the materials used. Balmain's luminous paint, a preparation of calcium sulphide, shines with a white light. The colour also depends on the temperature during exposure to light. Thus A. E. Becquerel found that the light given by a specimen of strontium sulphide changed from violet to blue, green, yellow and orange, as the temperature during the corresponding previous insolation was 20°, 40°, 70°, 100° or 200° C. The duration of phosphorescence varies greatly with different substances. It may last for days or for only a fraction of a second.

As in the case of fluorescent bodies, the light produced by phosphorescent substances consists commonly of rays less refrangible than those of the exciting light. Thus the ultra-violet portion of the spectrum is usually the most efficient in exciting rays belonging to the visible part of the spectrum. V. Klatt and Ph. Lenard (*Wied. Ann.*, 1889, xxxviii. 90), have shown that the phosphorescence of calcium sulphide and other phosphori depends on the presence of minute quantities of other substances, such as copper, bismuth and manganese. The maximum intensity of phosphorescent light is obtained when a certain definite proportion of the impurity is present, and the intensity is diminished if this proportion is increased. It appears likely that when a phosphorescent body is exposed to light, the energy of the light is stored up in some kind of strain energy, and that the phosphorescent light is given out during a more or less slow recovery from this state of strain. Klatt and Lenard have shown that the sulphides of the alkaline earths lose the property of phosphorescing when subjected to heavy pressure. Many fluorescent solutions become briefly phosphorescent when rendered solid by gelatin.

When the duration of phosphorescence is brief, some mechanical device becomes necessary to detect it. The earliest and best-known instrument for this purpose is Becquerel's phosphoscope. It consists essentially of a shallow drum, in whose ends two eccentric holes, exactly opposite one another, are cut. Inside it are fixed two equal metal disks, attached perpendicularly to an axis, and divided into the same number of sectors, the alternate sectors of each being cut out. One of these disks is close to one end of the drum, the other to the opposite end, and the sectors are so arranged that, when the disks are made to rotate, the hole in one end is open while that in the other is closed, and vice versa. If the eye be placed near one hole, and a ray of sunlight be admitted by the other, it is obvious that while the sun shines on an object inside the drum the aperture next the eye is closed, and vice versa. If the disks be made to revolve with great velocity by means of a train of toothed wheels the object will be presented to the eye almost instantly after it has been exposed to sunlight, and these presentations succeed one another so rapidly as to produce a sense of continuous vision. By means of this apparatus we can test with considerable accuracy the duration of the phenomenon after the light has been cut off. For this purpose we require to know merely the number of sectors in the disks and the rate at which they are turned.

Thermoluminescence.—Some bodies which do not emit light at ordinary temperatures in a dark room begin to do so if they are heated to a temperature below a visible red heat. In the case of

chlorophane, a variety of fluor-apat, the heat of the hand is sufficient. Many yellow diamonds exhibit this form of luminescence. It has been shown, however, that a previous exposure to light is always necessary. Sir James Dewar found that if ammonium platino-cyanide, Balmain's paint and some other substances are cooled to the temperature of liquid air and exposed to light, they do not phosphoresce, but as soon as they are allowed to warm up to the ordinary temperature they emit a brilliant light. On the other hand, some bodies, such as gelatin, celluloid, paraffin and ivory, are phosphorescent at very low temperatures, but lose the property at ordinary temperatures.

Triboluminescence (from *tribolus*, to rub) is luminescence excited by friction, percussion, cleavage or such mechanical means. Calcium chloride, prepared at a red heat, exhibits this property. If sugar is broken in the dark, or two crystals of quartz rubbed together, or a piece of mica cleft, a flash of light is seen, but this is probably of electrical origin. Closely allied to this form of luminescence is *crystallo-luminescence*, a phosphorescent light seen when some substances crystallize from solution or after fusion. This property is exhibited by arsenious acid when crystallizing from solution in hydrochloric acid.

Chemiluminescence is the name given to those cases in which chemical action produces light without any great rise of temperature. Phosphorus exposed to moist air in a dark room shines with a soft light due to slow oxidation. Decaying wood and other vegetable substances often exhibit the same property.

Electroluminescence is luminescence due to electrical causes. Many gases are phosphorescent for a short time after an electric discharge has been passed through them, and some solid substances, especially diamonds and rubies, are strongly phosphorescent when exposed to cathode rays in a vacuum tube.

See generally, Winkelmann, *Handbuch der Physik*, Bd. vi. (1906); E. Becquerel, *La Lumiere* (1867). (J. R. C.)

Phosphorescence in Zoology.

The emission of light by living substance is a widespread occurrence, and is part of the general metabolism by which the potential energy introduced as food is transformed into kinetic energy and appears in the form of movement, heat, electricity and light. In many cases it is probably an accidental by-product, and like the heat radiated by living tissues, is not necessarily of use to the organism. But in other cases the capacity to produce light is awakened on stimulation, as when the wind ripples the surface of the sea, or when the water is disturbed by the blade of an oar. It has been suggested that the response to the stimulus may be protective, and that enemies are frightened by the flash of light. In luminous insects and deep-sea fish the power of emitting light appears to have a special significance, and very elaborate mechanisms have been developed. The pale glow of phosphorescence has a certain resemblance to the light emitted by phosphorus, and it was an early suggestion that the phenomenon in living organisms was due to that substance. Phosphorus, however, and its luminous compounds are deadly poisons to all living tissues, and never occur in them in the course of natural metabolism, and the phosphorescence of life cannot therefore be assigned to the oxidation of phosphorus. On the other hand, it is certainly the result of a process of oxidation, as the emission of light continues only in the presence of oxygen. J. H. Fabre showed in 1855 that the luminous fungus, *Agaricus*, discharges more carbolic acid when it is emitting light, and Max Schultz in 1865 showed that in insects the luminous cells are closely associated with the tracheae, and that during phosphorescence they withdraw oxygen from them. In 1880 B. Radziszewski showed that many fats, ethereal oils and alcohols emit light when slowly combined with oxygen in alkaline fluids at appropriate temperatures. Probably the phosphorescence of organisms is due to a similar process acting on the many fats, oils and similar substances found in living cells. The colour varies much in different organisms; green has been observed in the glow-worm, fire-flies, brittle-stars, centipedes and annelids; blue in the Italian fire-fly (*Luciola italica*); blue and light green are the predominant colours in the phosphorescence of marine organisms, but red and lilac have also been observed. The Lantern-Fly (*Fulgora pyrorhynchus*) is said to have a purple light, and E. H. Giglioli has recorded that an individual *Appendicularia* appeared first red, and then blue, and then green. P. Panerri, chiefly in the case of *Salps*, and S. P. Langley and F. W. Very in the case of *Pyrophorus*, have investigated the light spectroscopically, and

found that it consisted of a continuous band without separate bright lines. The solar spectrum extends farther both towards the violet and the red ends, but is less intense in the green when equal luminosities are compared.

Many of the bacteria of putrefaction are phosphorescent, and the light emitted by dead fish or molluscs of flesh is probably due in every case to the presence of these. Under the microscope, the individual bacteria appear as shining points of light. The phosphorescence of decaying wood is due to the presence of the mycelium of *Agaricus melleus*, and various other species of *Agaricus* have been found to be luminous. The great displays of phosphorescence in sea-water are usually due to the presence of very large numbers of small luminous organisms, either protozoa or protophyta. Of these *Noctiluca miliaris* and species of *Peridinium* and *Pycnostis* are the most frequent, the two former near land and the latter in mid-ocean.

In higher animals the phosphorescence tends to be limited to special parts of the body which may form elaborate and highly specialized luminous organs. Many coelenterates show the beginning of such localization; in medusae the whole surface may be luminous, but the light is brighter along the radial canals, in the ovaries, or in the marginal sense-organs. In Pennatulids each polyp has eight luminous bands on the outer surface of the digestive cavity. Some Chaetopods (*Chaetopterus* and *Tomopteris*) have luminous organs at the base of the lateral processes of the body. *Pyrosoma*, a colonial pelagic ascidian, is responsible for some of the most striking displays of phosphorescence in tropical seas; it has two small patches of cells at the base of each inhalant tube which on stimulation discharge light, and the luminosity has been observed to spread through the colony from the point of irritation.

Amongst the Crustacea, many pelagic Copepods are phosphorescent. W. Giesbrecht has shown that the light is produced by a fluid secreted by certain dermal glands. A similar fluid in other Copepods hardens to form a protective case, and it may be that the display of light is in such cases an accidental by-product. Glands in the labrum of the Ostracod *Pyrocypria* and on the maxillae of the Mysid *Gastrophysia* similarly produce a luminous secretion. In the Euphausiacea, on the other hand, phosphorescence is produced by elaborate luminous organs which are situated on the thoracic appendages and the abdomen, and which were at first believed to be ocular organs. The deep-sea Decapod Crustaceans belonging to many families are luminous. A. Alcock observed that in some of the deep-sea prawns a luminous secretion was discharged at the bases of the antennae, but in most cases the luminous organs are numerous eye-like structures on the limbs and body.

The rock-boring mollusc, *Pholus*, which Pliny knew to be phosphorescent, has luminous organs along the anterior border of the mantle, two small triangular patches at the entrance of the anterior siphon, and two long parallel cords within the siphon. The cells of these organs have peculiar, granulated contents. W. E. Hoyle, in his presidential address to the Zoological Section of the British Association in 1907, brought together observations on the occurrence of luminous organs in no less than thirty-three species of Cephalopods. In *Heteroleuthis*, *Sepiola* and *Rostia* the light is produced by the secretion of a glandular organ on the ventral side of the body behind the funnel. The secretion glows through the transparent wall with a greenish colour, but, at least in the case of *Heteroleuthis*, continues to glow after being ejected into the water. In most cases the luminous organs are nonglandular and may be simple, or possess not only a generator but a reflector, lens and diaphragm. The different organs shine with different coloured lights, and as the Cephalopods are for the most part inhabitants of the depths of the sea, it has been suggested that they serve as recognition marks.

Some centipedes (e.g. *Geophilus electricus* and *G. phosphoreus*) are luminous, and, if allowed to crawl over the hand, are stated to leave a luminous trail. Amongst insects, elaborate luminous organs are developed in several cases. The abdomen of a Ceylonese May-fly (*Teloganodes*) is luminous. The so-called New Zealand "glow-worm" is the larva of the fly *Boleophila luminosa*, and some gnats have been observed to be luminous, although the suggestion is that in their case disease is present and the light emanates from phosphorescent bacteria. An ant (*Oryza*) and a poduran (*Ammophorus*) are occasionally luminous. The so-called lantern flies are Homoptera allied to the Cicadas, and the supposed luminous organ is a huge projection of the front of the head, regarding the luminosity of which there is some doubt. The glow-worms and true fire-flies are beetles. Eggs, larvae and adults are in some cases luminous. The organs consist of a pale transparent superficial layer which gives the light, and a deeper layer which may act as a reflector. They are in close connexion with the tracheae and the light is produced by the oxidation of a substance formed under the influence of the nervous system, and probably some kind of organic fat. In the females the phosphorescence is probably a sexual lure; in the males its function is unknown.

Phosphorescent organs known as *phosphores* are characteristic structures in many of the deep-sea Teleostome fishes, and have been developed in widely different families (*Stomiidae*, *Scopelidae*,

Halosauridae and *Anomalopidae*), whilst numerous simple luminous organs have been detected in many species of Selachii. The number, distribution and complexity of the organs vary much in different fish. They are most frequent on the sides and ventral surface of the anterior part of the body and the head, and may extend to the tail. The simpler forms are generally arranged in rows, sometimes metamericly distributed; the more complex organs are larger and less numerous. In *Opastomus micrionus* there is a large organ on a median barbel hanging down from the chin, others below the eyes, and one on the elongated first ray of the pectoral fin. In *Sternopyx diaphana* there is one on the lower jaw, and in many species one or two below the eyes. The luminous organs appear to be specialized skin glands which secrete a fluid that becomes luminous on slow oxidation. The essential part of the organ remains a collection of gland cells, but in the more complex types there are blood vessels and nerves, a protecting membrane, an iris-like diaphragm, a reflector and lens. As the distribution and probably the colour of the light varies with the species, these organs may serve as recognition marks. They may also attract prey, and from their association with the eyes in such a position as to send light downwards and forwards it is probable that in the higher types they are used by the fish actually as lanterns in the dark abysses of the sea. (P. C. M.)

PHOSPHORITE, in mineralogy, the name given to impure massive apatite (q.v.; see also PHOSPHATES).

PHOSPHORUS (Gr. φῶς, light, φέρω, to bear), the name originally given to any substance which possessed the property of phosphorescence (q.v.), i.e. the power of shining in the dark, but now generally restricted to a non-metallic element, which was first known as *Phosphorus mirabilis* or *igneus*. This element is very widely distributed in nature in combination, but is never found free. In the mineral kingdom it is exceptionally abundant, forming large deposits of phosphates (q.v.). It is also necessary to animal and vegetable life (see MANURE). It occurs in the urine, blood, tissues, and bones of animals, calcium phosphate forming about 58% of bones, which owe their rigidity to its presence.

The element appears to have been first obtained in 1669 by Brand of Hamburg; Kraft bought his secret and in 1677 exhibited specimens in England, where it created an immense sensation. Its preparation was assiduously sought for, and Kunkel in 1678 and Boyle in 1680 succeeded in obtaining it by the same process as was discovered by Brand, i.e. by evaporating urine to dryness and distilling the residue with sand. This method was generally adopted until 1775, when Scheele prepared it from bones, which had been shown by Gahn in 1769 to contain calcium phosphate. Scheele treated bone ash with nitric acid, precipitated the calcium as sulphate, filtered, evaporated and distilled the residue with charcoal. Nicolas and Pelletier improved the process by decomposing the bone-ash directly with sulphuric acid; whilst Fourcroy and Vauquelin introduced further economies. In modern practice degreased bones (see GELATIN), or bone-ash which has lost its virtue as a filtering medium, &c., or a mineral phosphate is treated with sufficient sulphuric acid to precipitate all the calcium, the calcium sulphate filtered off, and the filtrate concentrated, mixed with charcoal, coke or sawdust and dried in a muffle furnace. The product is then distilled from Stourbridge clay retorts, arranged in a galley furnace, previously heated to a red heat. The temperature is now raised to a white heat, and the product led by malleable iron pipes into condensing troughs containing water, when it condenses. The chemical reactions are as follows: the treatment of the calcium phosphate with the acid gives phosphoric acid, H₃PO₄, which at a red heat loses water to give metaphosphoric acid, HPO₃; this at a white heat reacts with carbon to give hydrogen, carbon monoxide and phosphorus, thus: 2HPO₃ + 6C = H₂ + 6CO + P₄.

Electrothermal processes are also employed. Calcium phosphate, mixed with sand and carbon, is fed into an electric furnace, provided with a closely fitting cover with an outlet leading to a condenser. At the temperature of the furnace the silica (sand) attacks the calcium phosphate, forming silicate, and setting free phosphorus pentoxide, which is attacked by the carbon, forming phosphorus and carbon monoxide. As phosphorus boils at 200° C. (554° F.), it is produced in the form of vapour, which, mingled with carbon monoxide, passes to the

condenser, where it is condensed. It is then cast under water. The calcium silicate remains in the furnace in the form of a liquid slag, which may be run off, so that the action is practically continuous. Kaolin may with advantage be used in addition to or in part substitution for sand, because the double silicate thus formed is more fusible than the single silicate of lime. The alternating current is generally used, the action not being electrolytic. One of the special advantages of the electrical over the older process is that the distilling vessels have a longer life, owing to the fact that they are not externally heated, and so subjected to a relatively high temperature when in contact with the corrosive slag formed in the process. The Readman-Parker process (see *Jour. Soc. Chem. Ind.*, 1891, x, 445) appears to be very generally adopted. Readman, experimenting with a Cowles furnace in Staffordshire in 1888, patented his process, and in the same year Parker and Robinson, working independently, patented a similar one. The two inventors then co-operated, an experimental plant was run successfully, and the patents were taken over by the leading manufacturers. With the object of obtaining a valuable by-product in place of the slag produced in this furnace, several patentees (e.g. Hilbert and Frank, Billaudot, Bradley and Jacobs, and others) have sought to combine the manufacture of calcium carbide and phosphorus by using only calcium phosphate and carbon, effecting direct reduction by carbon at a high temperature.

The crude phosphorus is purified by melting under water and then filtering through animal black and afterwards through chamois leather, or by treating it, when molten, with chromic acid or a mixture of potassium bichromate and sulphuric acid; this causes the impurities to rise to the surface as a scum which can be skimmed off. It is usually sent on the market in the form of sticks, which were at one time prepared by sucking the molten material up glass tubes; but the dangers to the workmen and other disadvantages of this method have led to its replacement by a continuous process, in which the phosphorus leaves the melting-pot for a pipe surrounded by water, in which it solidifies and can be removed as a continuous rod.

Properties.—When perfectly pure phosphorus is a white, transparent, waxy solid, but as usually prepared it is yellowish owing to the presence of the allotropic "red phosphorus." J. Böeseken (*Abs. Jour. Chem. Soc.*, 1907, ii, 343, 766) prepares perfectly pure phosphorus by heating the crude product with chromic acid solution, washing and drying in a vacuum, first at 40°, then at 80°. It remains colourless in vacuum tubes in the dark, but on exposure it rapidly turns yellow. At 25° to 30° C. it is soft and flexible, but it hardens when strongly cooled, and can then only be cut with difficulty. The fracture is distinctly crystalline; large crystals, either regular dodecahedra or octahedra, may be obtained by crystallization from carbon bisulphide, sulphur chloride, &c., or by sublimation. It is a non-conductor of electricity. Its density at 0° is 1.836; this regularly diminishes up to the melting-point, 44.3°, when a sudden drop occurs. Molten phosphorus is a viscid, oily, highly refractive liquid, which may be supercooled to 32° before solidification. It boils at 290°, forming a colourless vapour which just about the boiling-point corresponds in density to tetraatomic molecules, P₄; at 1500° to 1700°, however, Blitz and Meyer detected dissociation into P₂ molecules. Beckmann obtained P₄ molecules from the boiling-point of carbon bisulphide solutions, and Hertz arrived at the same conclusion from the lowering of the freezing-point in benzene solution; E. Paternò and Nasini, however, detected dissociation. Phosphorus is nearly insoluble in water, but dissolves in carbon bisulphide, sulphur chloride, benzene and oil of turpentine.

The element is highly inflammable, taking fire in air at 34° and burning with a bright white flame and forming dense white clouds of the pentoxide; in perfectly dry air or oxygen, however, it may be distilled unchanged, H. B. Baker showing that a trace of water vapour was necessary for combination to occur. When exposed to the air a stick of phosphorus undergoes slow combustion, which is revealed by a greenish-white phosphorescence when the stick is viewed in the dark. This phenomenon was

minutely studied by Boyle, who found that solutions in some essential oils (oil of cloves) showed the same character, whilst in others (oils of saffron and aniseed) there was no phosphorescence. He also noticed a strong garlic-like odour, which we now know to be due to ozone. Frederick Stare noticed that the luminosity increased when the air was rarefied, an observation confirmed by Hawkabee and Homberg, and which was possibly the basis of Berzelius's theory that the luminosity depended on the volatility of the element and not on the presence of oxygen. Lampadius, however, showed that there was no phosphorescence in a Torricellian vacuum; and other experimenters proved that oxygen was essential to the process. It depends on the partial pressure of the oxygen and also on temperature. In compressed air at ordinary temperature there is no glowing, but it may be brought about by heating. Again, in oxygen under ordinary conditions there is no phosphorescence, but if the gas be heated to 25° glowing occurs, as is also the case if the pressure be diminished or the gas diluted. It is also remarkable that many gases and vapours, e.g. Cl, Br, I, NH₃, N₂O, NO, H₂S, SO₂, CS₂, CH₄, C₂H₆, inhibit the phosphorescence.

The theory of this action is not settled. It is certain that the formation of hydrogen peroxide and ozone accompany the glowing, and in 1848 Schönbein tried to demonstrate that it depended on the ozone. E. Jungfleisch (*Comptes rendus*, 1905, 240, p. 444) suggested that it is due to the combustion of an oxide more volatile than phosphorus, a view which appears to be supported by the observations of Scharff (*Zeit. physik. Chem.*, 1908, 62, p. 178) and of L. and E. Bloch (*Comptes rendus*, 1908, 147, p. 842).

The element combines directly with the halogens, sulphur and selenium, and most of the metals burn in its vapour forming phosphides. When finely divided it decomposes water giving hydrogen phosphide; it also reduces sulphurous and sulphuric acids, and when boiled with water gives phosphine and hypophosphorous acid; when slowly oxidized under water it yields hypophosphoric acid.

Allotropic Phosphorus.—Several allotropic forms of phosphorus have been described, and in recent years much work has been done towards settling their identities. When the ordinary form immersed in water is exposed to light, it gradually loses its transparency and becomes coated with a thin film. This substance was regarded as an allotrope, but since it is not produced in non-aerated water it is probably an oxide. More important is the so-called "red phosphorus," which is produced by heating yellow phosphorus to about 230° for 24 hours in an inert atmosphere, or in closed vessels to 300°, when the change is effected in a few minutes. E. Kopp in 1844 and B. C. Brodie in 1853 showed that a trace of iodine also expedited the change. The same form is also produced by submitting ordinary phosphorus to the silent electric discharge, to sunlight or the ultraviolet light. Since this form does not inflame until heated to above 350°, it is manufactured in large quantities for consumption in the match industry. The process consists in heating yellow phosphorus in iron pots provided with air-tight lids, which, however, bear a long pipe open to the air. A small quantity of the phosphorus combines with the oxygen in the vessel, and after this the operation is practically conducted in an atmosphere of nitrogen with the additional safety from any risk of explosion. The product is ground under water, and any unchanged yellow form is eliminated by boiling with caustic soda, the product being then washed and dried and finally packed in tin boxes. The red variety is remarkably different from the yellow. It is a dark red microcrystalline powder, insoluble in carbon bisulphide, oil of turpentine, &c., and having a density of 2.2. It is stable to air and light, and does not combine with oxygen until heated to above 350° in air or 260° in oxygen, forming the pentoxide. It is also non-poisonous. When heated in a vacuum to 550° it sublimates, and on condensation forms microscopic needles.

Hittorf's phosphorus is another crystalline allotrope formed by heating phosphorus with lead in a sealed tube to redness, and removing the lead by boiling the product with nitric acid

hydrochloric acid. It is also obtained by heating red phosphorus under pressure to 580°. It forms a lustrous, nearly black crystalline mass, composed of minute rhombohedra. G. E. Linck and P. Möller (*Ber.*, 1908, 41, p. 1404) have affirmed that the product of the first process always contains lead. E. Cohen and J. Olie, Jun. (*Abs. Jour. Chem. Soc.*, 1909, ii, 998) regard red phosphorus as a solid solution of the white in Hittorf's, but this is contradicted by A. Stock (*Ber.*, 1909, 42, p. 4510), who points out that ordinary red phosphorus melts at 605°–610°, whilst Hittorf's melts at 620°; moreover, the latter is less reactive than the former at high temperatures.

Another form was obtained by R. Schenck (*Zeit. Elektrochem.*, 1905, ii, 117) as a scarlet amorphous powder by deposition of solutions of phosphorus in the tri-iodide, tribromide or sulphide (P₂S₃). It phosphoresces in ozone, but not in air, and is non-poisonous; from its solution in alcoholic potash acids precipitate the hydride P₂H₄, and when heated it is transformed into the red modification. It has been used in combination with potassium chlorate as a composition for matches to strike on any surface. Finally a black phosphorus was described by Thénard as formed by rapidly-cooling melted phosphorus.

Phosphine (phosphoretted hydrogen), PH₃, a gas formed in the putrefaction of organic matter containing phosphorus, was obtained by Gengembre (*Crell's Ann.*, 1789, i, 450) by the action of potash upon phosphorus, the gas so prepared being spontaneously inflammable. Some time later Davy, by heating phosphorous acid, obtained a phosphoretted hydrogen which was not spontaneously inflammable. These gases were considered to be distinct until Le Verrier (*Ann. chim. phys.*, 1835 [2], 60, p. 174) showed that the inflammability of Gengembre's phosphine was due to small quantities of liquid phosphoretted hydrogen, P₂H₄. Phosphine may be prepared by the decomposition of calcium phosphide with water (P₂H₄ being formed simultaneously); by the decomposition of phosphorous and hypophosphorous acids when strongly heated; and by the action of solutions of the caustic alkalis on phosphorus: P₄+3NaOH+3H₂O=PH₃+3NaH₂PO₂; hydrogen and P₂H₄ are produced at the same time, and the gas may be freed from the latter substance by passing into a hydrochloric acid solution of cuprous chloride, and heating the solution, when pure phosphine is liberated (Ribau, *Comptes rendus*, 58, p. 581). The pure gas may also be obtained by heating phosphonium iodide with caustic potash (A. W. Hofmann, *Ber.*, 1871, 4, p. 200); by the decomposition of crystalline calcium phosphide or of aluminium phosphide with water (H. Moissan, *Bull. soc. chim.*, 1890 (3), 21, p. 926; Matignon, *Comptes rendus* 1900, 130, p. 1391); and by the reduction of phosphorous acid with nascent hydrogen.

It is a colourless, extremely poisonous gas, possessing a characteristic offensive smell, resembling that of rotting fish. It becomes liquid at -90°C., and solid at -133°C. (K. Olaszewski, *Monats.*, 1866, 7, p. 371). It is only slightly soluble in water, but is readily soluble in solutions of copper sulphate, hypochlorous acid, and acid solutions of cuprous chloride. It burns with a brightly luminous flame, and is spontaneously inflammable at about 100°C. When mixed with oxygen it combines explosively if the mixture be under diminished pressure, and is violently decomposed by the halogens. It is also decomposed when heated with sulphur or with most metals, in the latter case with the liberation of hydrogen and formation of phosphide of the metal. It combines with the halide derivatives of boron and silicon to form, e.g. PH₃.2BF₃, 2PH₃.SiCl₄ (Besson, *Comptes rendus*, 1890, 110, 80, pp. 240, 516; 1891, 113, p. 78), with the halogen acids to form phosphonium salts, PH₄X (X=Cl, Br, I), and with sodammonium and potassiumammonium to form PH₃N₃, PH₃K (Ioannis, *Comptes rendus*, 1894, 119, p. 557). It oxidizes slowly in air, and is a reducing agent. It decomposes when heated, hydrogen and red phosphorus being formed.

Liquid Phosphoretted Hydrogen, P₂H₄, first obtained by P. Thénard (*Comptes rendus*, 1844, 18, p. 652) by decomposing calcium phosphide with warm water, the products of reaction being then passed through a U tube surrounded by a freezing mixture (see also L. Gattermann, *Ber.*, 1890, 23, p. 1174). It is a colourless liquid which boils at 57°–58°C. It is insoluble in water, but soluble in alcohol and ether. It is very unstable, being readily decomposed by heat or light. By passing the products of the decomposition of calcium phosphide with water over granular calcium chloride, the P₂H₄ gives a new hydride, P₂H₆, and phosphine, the former being an odourless, canary-yellow, amorphous powder. When heated in a vacuum it evolves phosphine, and leaves an orange-red residue of a second new hydride, P₂H₈ (A. Stock, W. Böttcher, and W. Lenger, *Ber.*, 1909, 42, pp. 2839, 2847, 2853).

Solid Phosphoretted Hydrogen, P₂H₆, first obtained by Le Verrier (*loc. cit.*), is formed by the action of phosphorus trichloride on gaseous phosphine (Besson, *Comptes rendus*, 111, p. 972); by the action of water on phosphorus di-iodide and by the decomposition of calcium phosphide with hot concentrated hydrochloric acid. It is a yellow

solid, which is insoluble in water. It burns when heated to about 200°C. Oxidizing agents decompose it with great violence. When warmed with alcoholic potash it yields gaseous phosphine, hydrogen and a hypophosphite. It reduces silver salts.

Phosphonium Salts.—The chlorides, PH₄Cl, was obtained as a crystalline solid by Ogier (*Comptes rendus*, 1879, 89, p. 705) by combining phosphine and hydrochloric acid gas under a pressure of from 14–20 atmospheres; it can also be obtained at -30° to -35°C. under ordinary atmospheric pressure. It crystallizes in large transparent cubes, but rapidly dissociates into its constituents on exposure. The bromide, PH₄Br, was first obtained by H. Rose (*Pogg. Ann.*, 1832, 24, p. 151) from phosphine and hydrobromic acid; it also results when phosphorus is heated with hydrobromic acid to 100–120°C. in sealed tubes (Damoiseau, *Bull. soc. chim.*, 1881, 35, p. 49). It crystallizes in colourless cubes, is deliquescent, and often inflames spontaneously on exposure to air. It is readily decomposed by water and also by carbonyl chloride (Besson, *Comptes rendus*, 1896, 122, p. 140): 6PH₄Br + 5COCl₂ = 10HCl + 5CO + 6HBr + 2PH₃ + P₂H₄. The iodide, PH₄I, first prepared by J. Gay-Lussac (*Ann. chim. phys.*, 1814, 91, p. 14), is usually obtained by the action of water on a mixture of phosphorus and iodine (A. W. Hofmann, *Ber.*, 1873, 6, p. 286). It is also prepared by the action of iodine on gaseous phosphine, or by heating anhydrous phosphorus with concentrated hydrochloric acid solution to 160°C. It crystallizes in large cubes and sublimes readily. It is a strong reducing agent. Water and the caustic alkalis readily decompose it with liberation of phosphine and the formation of iodides or hydrochloric acid. It is also decomposed by carbonyl chloride (Besson, *loc. cit.*).

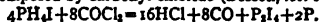

Just as the amines are derived from ammonia, so from phosphine are derived the primary, secondary and tertiary organic phosphines by the exchange of hydrogen for alkyl groups, and corresponding to the phosphonium salts there exists a series of organic phosphonium bases. The primary and secondary phosphines are produced when the alkyl iodides are heated with phosphonium iodide and zinc oxide to 150°C. (A. W. Hofmann, *Ber.*, 1871, 4, pp. 200, 605), thus: 2RI + 2PH₃ + ZnO = 2R-PH₂-HI + 2PH₄I + H₂O, 2RI + PH₃ + ZnO = R₂-PH-HI + ZnI₂ + H₂O. The reaction mixture on treatment with water yields the primary phosphine, the secondary phosphine being then liberated from its hydriodide by caustic soda. The tertiary phosphine, discovered by L. Thénard (*Comptes rendus*, 1845, 21, p. 144; 1847, 25, p. 892), are formed (together with the quaternary phosphonium salts) by heating alkyl iodides with phosphonium iodide to 150–180°C.: PH₄I + 3CH₃I = P(CH₃)₃HI + 3HI; P(CH₃)₃HI + CH₃I = P(CH₃)₄I + HI (see also Fireman, *Ber.*, 1897, 30, p. 1088). They are also formed by the interaction of phosphorus trichloride and zinc alkyls (Cahours and Hofmann, *Ann.*, 1837, 104, p. 1): 2PCl₃ + 3Zn (C₂H₅)₂ = 3ZnCl₂ + 2P(C₂H₅)₃.

The primary and secondary phosphines are colourless compounds, and with the exception of methyl phosphine are liquid at ordinary temperature. They possess an unpleasant odour, fume on exposure to air, show a neutral reaction, but combine with acids to form salts. They oxidize very rapidly on exposure, in many cases being spontaneously inflammable. On oxidation with nitric acid the primary compounds give monoalkyl phosphinic acids, R-P(O)(OH)₂, the secondary yielding dialkyl phosphinic acids, R₂P(O)(OH), the primary phosphines are very weak bases, their salts with acids being readily decomposed by water. The tertiary phosphines are characterized by their readiness to pass into derivatives containing pentavalent phosphorus, and consequently they form addition compounds with sulphur, carbon bisulphide, chlorine, bromine, the halogen acids and the alkyl halides with great readiness. On oxidation they yield phosphine oxides, R₃P=O. The quaternary phosphonium salts resemble the corresponding nitrogen compounds. They are stable towards aqueous alkalis, but on digestion with moist silver oxide yield the phosphonium hydroxides, which are stronger bases than the caustic alkalis. They differ from the organic ammonium hydroxides in their behaviour when heated, yielding phosphine oxides and paraffin hydrocarbons: R₃P-OH = R₃P=O + RH. The boiling-points of some members of the series are shown in the table:—

	Primary.	Secondary.	Tertiary.
Methyl . . .	-14° C.	25° C.	40–42° C.
Ethyl . . .	+25° C.	85° C.	128° C.
Isopropyl . . .	41° C.	118° C.	—
Isobutyl . . .	62° C.	153° C.	215° C.
Isosamyl . . .	107° C.	210–215° C.	300° C. (?)

The alkyl phosphinic acids are colourless crystalline compounds which are easily soluble in water and alcohol. They yield two series of salts, viz. RHM-PO₂ and RM₂PO₂ (M=metal). The dialkyl phosphinic acids are also colourless compounds, the majority of which are insoluble in water. They yield only one series of salts. **Oxides**.—Phosphorus forms three well-defined oxides, P₂O₃, P₂O₄ and P₂O₅; two others, P₂O and P₂O, have been described.

Phosphorus suboxide, P₂O, is said to be formed, mixed with the

other oxides, when the element is burnt in a limited supply of air or in pure oxygen under reduced pressure (E. Jungfleisch, *Ann. Jour. Chem. Soc.*, 1907, ii, 761), and also when a solution of phosphorus in the trichloride or tribromide is exposed to light. It is a yellow or red powder which becomes dark red on heating; it is stable in air and can be heated to 300° without decomposition. Its existence, however, has been denied by A. Stock (*Ann. Jour. Chem. Soc.*, 1910, ii, 121). The oxide P_2O_3 was obtained by Besson (*Comptes rendus*, 1897, 124, p. 763; 1901, pp. 132, 1556) by heating a mixture of phosphonium bromide and phosphorus oxychloride in sealed tubes to 50°.

Phosphorus oxide, P_2O_5 , discovered by Sage in 1777, is a product of the limited combustion of phosphorus in air. It may be conveniently prepared by passing a rapid current of air over burning phosphorus contained in a combustion tube, and condensing the product in a metal condenser, from which it may be removed by heating the condenser to 50°–60° (Thorpe and Tutton, *Jour. Chem. Soc.*, 1890, pp. 545, 632; 1891, p. 1019). Jungfleisch has obtained it by carrying out the combustion with oxygen under reduced pressure, or diluted with an inert gas. It forms crystals, apparently monoclinic, which melt at 22.5° to a clear, colourless, mobile liquid of boiling-point 173.1°. Its specific gravity is 2.135 at 21°. Vapour density and cryoscopic determinations point to the double formula, P_2O_5 . It is comparatively stable up to 200°, but when heated in a sealed tube to 440° it gives phosphorus and the tetroxide P_2O_4 . It is unaffected by light when pure, but if phosphorus be present, even in minute quantity, it turns yellow and ultimately dark red. It oxidizes on exposure to air to the pentoxide, and with a brilliant inflammation when thrown into oxygen at 50°–60°. It slowly reacts with cold water to form phosphorous acid; but with hot water it is energetically decomposed, giving much red phosphorus or the suboxide being formed with an explosive evolution of spontaneously inflammable phosphoretted hydrogen; phosphoric acid is also formed. With dilute alkalis phosphites are slowly formed, but with concentrated solutions the decomposition follows the same course as with hot water. With chlorine it gives phosphoryl and "metaphosphoryl" chlorides, the action being accompanied with a greenish flame; bromine gives phosphorus pentabromide and pentoxide which interact to give phosphoryl and "metaphosphoryl" bromides; iodine gives phosphorus di-iodide, P_2I_4 , and pentoxide, P_2O_5 ; whilst hydrochloric acid gives phosphorus trichloride and phosphorous acid, which interact to form free phosphorus, phosphoric acid and hydrochloric acid. It combines violently with sulphur at 160° to form phosphorus sulphide, P_2S_5 , which forms highly lustrous tetragonal plates (after sublimation), melting at 102° and boiling at 295°; it is decomposed by water into sulphuretted hydrogen and metaphosphoric acid, the latter changing on standing into orthophosphoric acid. Sulphur trioxide and sulphuric acid oxidize phosphorus oxide, giving the pentoxide and sulphur dioxide, whilst sulphur chloride, S_2Cl_2 , gives phosphoryl and thiophosphoryl chlorides, free sulphur and sulphur dioxide. Ammonia also reacts immediately, giving phosphorus diamide, $P(OH)(NH)_2$, and the corresponding ammonium salt. Phosphorous oxide is very poisonous, and is responsible for the caries set up in the jaws of those employed in the phosphorus industries (see below). It is probable, however, that pure phosphorous oxide vapour is odourless, and the odour of phosphorus as ordinarily perceived is that of a mixture of the oxide with ozone.

Phosphorus tetroxide, P_2O_4 , was obtained by Thorpe and Tutton by heating the product of the limited combustion of phosphorus *in vacuo* as a sublimate of transparent, highly lustrous, orthorhombic crystals. They are highly deliquescent, and form with water a mixture of phosphorous and phosphoric acids: $P_2O_4 + 3H_2O = H_2PO_3 + H_2PO_4$. The vapour density at about 1400° is 230, i.e. slightly less than that required by P_2O_4 (*West. Jour. Chem. Soc.*, 1902, p. 923).

Phosphoric oxide, or phosphorus pentoxide, P_2O_5 , formed when phosphorus is burned in an excess of air or oxygen, or from dry phosphorus and oxygen at atmospheric pressure (Jungfleisch, *loc. cit.*), was examined by Boyle and named "flowers of phosphorus" by Marggraf in 1740. It is a soft, flocculent powder, which on sublimation forms transparent, monoclinic crystals. It is extremely deliquescent, hissing when thrown into water, with which it combines to form phosphoric acid. It is reduced when heated with carbon to phosphorus, carbon monoxide being formed simultaneously. Its vapour density at 1400° points to the double formula (*West. Jour. Chem. Soc.*, 1896, p. 154).

Oxyacids.—Phosphorus forms several oxyacids: hypophosphorous acid, H_3PO_2 , and hypophosphoric acid, $H_4P_2O_6$ or $H_2P_2O_7$, of which the anhydrides are unknown; phosphorous acid, H_3PO_3 , derived from P_2O_3 ; monoperphosphoric acid, $H_2P_2O_8$; perphosphoric acid, $H_4P_2O_9$; and meta-, pyro-, and ortho-phosphoric acids, derived from P_2O_5 , for which see PHOSPHATES.

Hypophosphorous acid, $HP(OH)_2$, discovered by Dulong in 1816, and obtained crystalline by Thomson in 1874 (*Ber.*, 7, p. 994), is prepared in the form of its barium salt by warming phosphorus with baryta water, removing the excess of baryta by carbon dioxide, and crystallizing the filtrate. The acid may be prepared by evaporating in a vacuum the solution obtained by decomposing the barium salt with the equivalent amount of sulphuric acid. The acid forms a white crystalline mass, melting at 17.4° and having a strong acid

reaction. Exposure to air gives phosphorous and phosphoric acids, and on heating it gives phosphine and phosphoric acid. A characteristic reaction is the formation of a red precipitate of cuprous hydride, Cu_2H , when heated with copper sulphate solution to 60°. It is a monobasic acid forming salts which are permanent in air, but which are gradually oxidized in aqueous solution. On heating they yield phosphine and leave a residue of pyrophosphate, or a mixture of meta- and pyrophosphates, with a little phosphorus. They react as reducing agents. On boiling with caustic potash they evolve hydrogen, yielding a phosphate.

Phosphorous acid, $P(OH)_3$, discovered by Davy in 1812, may be obtained by dissolving its anhydride, P_2O_3 , in cold water; by immersing sticks of phosphorus in a solution of copper sulphate contained in a well-closed flask, filtering from the copper sulphide and precipitating the sulphuric acid simultaneously formed by baryta water, and concentrating the solution *in vacuo*; or by passing chlorine into melted phosphorus covered with water, the first formed phosphorus trichloride being decomposed by the water into phosphorous and hydrochloric acids. It may also be prepared by leading a current of dry air into phosphorus trichloride at 60° and passing the vapours into water at 0°, the crystals thus formed being drained, washed with ice-cold water and dried in a vacuum. The crystals melt at 70°. The acid is very deliquescent, and oxidizes on exposure to air to phosphoric acid. It decomposes on heating into phosphine and phosphoric acid. It is an energetic reducing agent; for example, when boiled with copper sulphate metallic copper is precipitated and hydrogen evolved. Although nominally tribasic the commonest metallic salts are dibasic. Organic ethers, however, are known in which one, two and three of the hydrogen atoms are substituted (Michaëlis and Becker, *Ber.*, 1897, 30, p. 1003). The metallic phosphites are stable both dry and in solution; when strongly heated they evolve hydrogen and yield a pyrophosphate, or, especially with the heavy metals, they give hydrogen and a mixture of phosphide and pyrophosphate.

Hypophosphoric acid, $H_4P_2O_6$ or $H_2P_2O_7$, discovered by Salaer in 1877 among the oxidation products of phosphorus by moist air, may be prepared by oxidizing phosphorus in an aqueous solution of copper nitrate, or by oxidizing sticks of phosphorus under water, neutralizing with sodium carbonate, forming the lead salt and decomposing this with sulphuretted hydrogen (J. Cavalier and E. Cornée, *Ann. Jour. Chem. Soc.*, 1910, ii, 31). The aqueous solution may be boiled without decomposition, but on concentration it yields phosphorous and phosphoric acids. Deliquescent, rectangular tablets of $H_4P_2O_6 \cdot 10H_2O$ separate out on concentrating a solution in a vacuum, which on drying further give the acid, which melts at 85°, and decomposes suddenly when heated to 70° into phosphorous and metaphosphoric acids with a certain amount of hydrogen phosphide. The solution is stable to oxidizing agents such as dilute hydrogen peroxide and chlorine, but is oxidized by potassium permanganate to phosphoric acid; it does not reduce salts of the heavy metals. With silver nitrate it gives a white precipitate, $Ag_2P_2O_6$. The sodium salt, $Na_2P_2O_6 \cdot 10H_2O$, forms monoclinic prisms and in solution is strongly alkaline; the acid salt, $Na_2H_2P_2O_7 \cdot 9H_2O$, forms monoclinic tablets. The formula of the acid is not quite definite. Cryoscopic measurements on the sodium salt points to the double formula, but the organic esters appear to be derived from $H_4P_2O_6$ (see A. Rosenheim and M. Pritze, *Ber.*, 1908, 41, 2708; E. Cornée, *Ann. Jour. Chem. Soc.*, 1910, ii, 121).

Monoperphosphoric and perphosphoric acids, $H_2P_2O_8$ and $H_4P_2O_9$, were obtained by J. Schmidlin and P. Massini (*Ber.*, 1910, 43, 1162). The first is formed when 30% hydrogen peroxide reacts with phosphorus pentoxide or meta- or pyrophosphoric acids at low temperatures and the mixture diluted with ice-cold water. The solution is strongly oxidizing, even converting manganous salts to permanganates in the cold, a property not possessed by monoperphosphoric acid. Perphosphoric acid is formed when pyrophosphoric acid is treated with a large excess of hydrogen peroxide.

Halogen Compounds.—**Phosphorus trifluoride, PF_3** , discovered by Davy, may be obtained mixed with the pentafluoride; by direct combination of its elements, from the tribromide and arsenic trifluoride (MacIvor); from the tribromide and zinc fluoride, and from dried copper phosphide and lead fluoride (H. Moissan). It is a colourless, non-fuming gas, which gives a colourless, mobile liquid at -10° and 20 atmospheres; the liquid boils at -95° and solidifies at -160° (Moissan, *Comptes rendus*, 1904, 138, p. 786). It does not burn in air, but explodes, under the action of a flame or the electric spark, when mixed with half its volume of oxygen, giving the oxyfluoride, POF_2 . It is slowly decomposed by water giving hydrofluoric and phosphorous acids, or, in addition, fluorophosphorous acid, HPF_2 . It has no action on glass in the cold, but when heated it gives phosphorus and silicon tetrafluoride. **Phosphorus pentafluoride, PF_5** , discovered by Thorpe (*Proc. Roy. Soc.*, 1877, 25, p. 122), may be obtained by burning the trifluoride in fluorine, from the pentachloride and arsenic trifluoride and from the trifluoride and bromine, the first formed fluorobromide, PF_2Br_2 , decomposing into the pentabromide and pentafluoride: $5PF_2Br_2 = 3PF_5 + 2PBr_5$. It is a colourless gas 4½ times heavier than air, and liquefies at 15° under 40 atmospheres, solidifying when the pressure is diminished. It is incompletely and extinguishes flame. It fumes in moist air and is quickly decomposed by water giving hydrofluoric and phosphoric

acids. It does not dissociate on heating as do the pentachloride and pentabromide, thus indicating the existence of pentavalent phosphorus in a gaseous compound; dissociation, however, into the trifluoride and free fluorine may be brought about by induction sparks of 150 to 200 mm. in length. It combines directly with ammonia in the proportion $2PF_5:3NH_3$, and with nitrogen peroxide at -10° in the proportion $PF_5:NO_2$. Phosphorus trifluorodichloride, PF_2Cl_2 , prepared from chlorine and the trifluoride, is a pungent-smelling gas, which at 250° gives the pentachloride and fluoride. The trifluorodichloride (see above) is an amber-coloured mobile liquid. Phosphorus trifluoride, PF_3 , may be obtained by exploding a volume of phosphorus trifluoride with 1 volume of oxygen (Moissan, 1886); by heating 2 parts of finely-divided cryolite and 3 parts of phosphorus pentoxide (Thorpe and Hambley, *Jour. Chem. Soc.*, 1899, p. 759); or from phosphoryl chloride and zinc fluoride at 40° to 50° . It is a colourless fuming gas, which liquefies under ordinary pressure at -50° , and under a pressure of 15 atmospheres at 16° ; it may be solidified to a snow-like mass. Water gives hydrofluoric and phosphoric acids. The corresponding sulphur compound, thiophosphoryl fluoride, PSF_5 , obtained by heating lead fluoride and phosphorus pentasulphide to 200° , is a colourless gas, which may be condensed to a clear transparent liquid. It spontaneously inflames in air or oxygen; and when the gas is issuing from a jet into air the flame is greyish green, with a faintly luminous and yellow tip; the flame is probably one of the coldest known. The combustion probably follows the equation $PSF_5 + O_2 = PF_5 + SO_2$, the trifluoride at a higher temperature decomposing according to the equations: $10PF_5 + 5O_2 = 6PF_3 + 2P_2O_5$, $2PF_5 + O_2 = 2POF_3$, the complete reaction tending to the equation: $10PSF_5 + 15O_2 = 6PF_5 + 2P_2O_5 + 10SO_2$. The gas dissolves in water on shaking; $PSF_5 + 4H_2O = H_2S + H_2PO_4 + 3HF$, but is more readily taken up by alkaline solutions with the formation of fluoride and thiophosphate: $PSF_5 + 6NaOH = Na_2PSO_4 + 3NaF$. Heated in a glass tube it gives silicon fluoride, phosphorus and sulphur, $PSF_5 = PF_3 + S$; $4PF_3 + 3SiO_2 = 3SiF_4 + P_4 + 3O_2$. Electric sparks give at first free sulphur and the trifluoride, the latter at a higher temperature splitting into the pentachloride and phosphorus. With dry ammonia it gives ammonium fluoride and a compound $(PNH_3)_2F$.

Phosphorus trichloride or phosphorus chloride, PCl_3 , discovered by Gay-Lussac and Thénard in 1808, is obtained by passing a slow current of chlorine over heated red phosphorus or through a solution of ordinary phosphorus in carbon disulphide (purifying in the latter case by fractional distillation). It is a colourless, mobile liquid of specific gravity 1.6128 at 0° and boiling-point 76° . With chlorine it gives the pentachloride, PCl_5 , and with oxygen when heated phosphoryl chloride, $POCl_3$. Water gives hydrochloric and phosphoric acids, with separation of red phosphorus if the water be hot. When led with hydrogen into liquid ammonia it gives $NH_3:PNH_3$, which on elevation of temperature gives $P_2(NH)_4$ (Joannis, *Comptes rendus*, 1904, 139, p. 364). By submitting a mixture of phosphorus chloride and hydrogen to an electric discharge A. Besson and A. Fournier (*Comptes rendus*, 1901, 130, p. 102) obtained phosphorus dichloride, P_2Cl_4 , as a colourless, oily, strongly fuming liquid, freezing at -28° and boiling at 180° with decomposition. With water it gave phosphorous acid and a yellow indefinite solid. It decomposes slowly at ordinary temperatures. Phosphorus pentachloride, PCl_5 , discovered by Davy in 1810 and analysed by Dulong in 1816, is formed from chlorine and the trichloride. It is a straw-coloured solid, which by fusion under pressure gives prismatic crystals. It sublimes when heated, but under pressure it melts at 148° , giving a normal vapour density, but on further heating it dissociates into the trichloride and chlorine; this dissociation may be retarded by vaporizing in an atmosphere of chlorine. It fumes strongly in moist air, giving hydrochloric acid and phosphoryl chloride, $POCl_3$; with water it gives phosphoric and hydrochloric acids.

Phosphoryl trichloride or phosphorus oxychloride, $POCl_3$, corresponding to phosphoric acid, $(HO)_3PO$, discovered in 1847 by Wurtz, may be produced by the action of many substances containing hydroxy groups on the pentachloride; from the trichloride and potassium chlorate; by leaving phosphorus pentoxide in contact with hydrochloric acid: $2P_2O_5 + 3HCl = POCl_3 + 3HPO_3$; or by heating the pentachloride and pentoxide under pressure: $3PCl_5 + P_2O_5 = 5POCl_3$. It is a colourless liquid, boiling at 107.2° , and when solidified it melts at 0.8° . Water gives hydrochloric and phosphoric acids; dilute alcohol gives monoethyl phosphoric acid, $C_2H_5H_2PO_4$, whilst absolute alcohol gives triethyl phosphate, $(C_2H_5)_3PO_4$. Pyrophosphoryl chloride, $P_2O_5Cl_4$, corresponding to pyrophosphoric acid, was obtained by Geuther and Michaelis (*Ber.*, 1871, 4, p. 766) in the oxidation of phosphorus trichloride with nitrogen peroxide at low temperature; it is a colourless fuming liquid which boils at about 212° with some decomposition. With water it gives phosphoric and hydrochloric acids. Thiophosphoryl chloride, $PSCl_3$, may be obtained by the direct combination of sulphur with the trichloride; from sulphuretted hydrogen and the pentachloride; from antimony trisulphide and the pentachloride; by heating the pentasulphide with the pentachloride; and by dissolving phosphorus in sulphur chloride and distilling the solution: $2P + 3S_2Cl_2 = 4S + 2PSCl_3$. It is a colourless mobile liquid, boiling at 125.1° and having a pungent, slightly aromatic odour. It is slowly decomposed by water giving phosphoric and hydrochloric acids, with

sulphuretted hydrogen; alkalis form a thiophosphate, e.g. $PS(OK)_2$ and a chloride.

Phosphorus tribromide, PBr_3 , prepared by mixing solutions of its elements in carbon disulphide and distilling, is a transparent, mobile liquid, boiling at 173° and resembling the trichloride chemically. The pentabromide, PBr_5 , which results from phosphorus and an excess of bromine, is a yellow solid, and closely resembles the pentachloride. The bromochloride, PCl_2Br_3 , is an orange-coloured solid formed from bromine and the trichloride, into which component it decomposes at 45° . Phosphorus tribromide, PBr_3 , is a solid, melting at 45° and boiling at 195° . Thiophosphoryl bromide, PBr_3 , obtained after the manner of the corresponding chloride, forms yellow octahedra which melt at 38° , and have a penetrating, aromatic odour. With water it gives sulphur, sulphuretted hydrogen, hydrobromic, phosphorous and phosphoric acids, the sulphur and phosphorous acid being produced by the interaction of the previously formed sulphuretted hydrogen and phosphoric acid. Pyrophosphoryl thiobromide, $(PBr_2)_2S$, and metaphosphoryl thiobromide, $P_2S_2Br_4$, are also known.

Phosphorus forms three iodides. The subiodide, PI , was obtained by R. Boulough (*Comptes rendus*, 1905, 141, p. 256), who acted with dry iodine on phosphorus dissolved in carbon disulphide; with alkalis it gives $PI(OH)$. The di-iodide and tri-iodide are formed similarly; the first is deposited as orange-coloured prisms which melt at 110° to a red liquid (see Doughty, *Jour. Amer. Chem. Soc.*, 1905, 27, p. 1444), whilst the second forms dark-red hexagonal plates which melt at 55° .

Sulphides and Thio-acids.—Phosphorus and sulphur combine energetically with considerable rise of temperature to form sulphides. The researches of A. Stock (*Ber.*, 1908, 41, pp. 558, 657; 1909, 42, p. 2062; 1910, 43, pp. 150, 414) show that three exist, P_2S_2 , P_2S_4 , P_2S_5 . The first is prepared by heating red phosphorus with finely powdered sulphur in a tube sealed at one end and filled with carbon dioxide. The product is extracted with carbon disulphide and the residue distilled in carbon dioxide. It forms light yellow crystals from benzene, which melt at 172° and boil at 407° – 408° with slight decomposition. Alkalis give hydrosulphide and phosphine. The second, P_2S_4 , is obtained by heating a mixture of red phosphorus and sulphur in the proportions given by $P_2S_4 + 5\frac{1}{2}P_2S_5$, and crystallizing from carbon disulphide in which P_2S_4 is readily soluble. It forms small, slightly yellow prisms, which melt at 310° and boil at 523° . The third, or pentasulphide, P_2S_5 , was obtained as a substance resembling flowers of sulphur by A. Stock and K. Thiel (*Ber.*, 1905, 38, p. 2719; 1910, 43, p. 1223), who heated sulphur with phosphorus in carbon disulphide solution with a trace of iodine to 120° – 130° . It exists in two forms, one having the formula P_2S_5 , and the other a lower molecular weight. With liquid ammonia it gives $P_2S_5 \cdot 7NH_3$, which is a mixture of ammonium iminotriphosphite, $P(SNH_2)_3$:NH, and ammonium nitridodithiophosphate, $P(SNH_2)_2$:N. Water converts the former into ammonium thiophosphate, $PO(SNH_2)_2 \cdot H_2O$, whilst the latter heated to 300° in a vacuum gives thiophosphoric nitride, $NiP:S$ (Stock, *ibid.*, 1906, 39, p. 1967).

Thiophosphates result on dissolving the pentasulphide in alkalis. Sodium monothiophosphate, $Na_2PSO_4 \cdot 12H_2O$, is obtained by adding one P_2S_5 to six NaOH, adding alcohol, dissolving the precipitate in water and heating to 90° . On cooling the salt separates as white six-sided tablets. Sodium dithiophosphate, $Na_2P_2S_5 \cdot 11H_2O$, is obtained by heating the above solution only to 50° – 55° , cooling and adding alcohol, which precipitates the dithio salt. On heating it gives the monothio salt. Sodium triphosphite appears to be formed when the pentasulphide acts with sodium hydrosulphide at 20° . All thiophosphates are decomposed by acids giving sulphuretted hydrogen and sometimes free sulphur. They also act in many cases as reducing agents.

Nitrogen Compounds.—Phosphorus pentachloride combines directly with ammonia, and the compound when heated to redness loses ammonium chloride and hydrochloric acid and gives phosphazene, PNH_4 , a substance first described by Davy in 1811. It is a white, infusible, very stable solid, which decomposes water on heating, giving ammonia and metaphosphoric acid, whilst alkalis give an analogous reaction. With methyl and ethyl alcohols it forms secondary amines (Vidal, *Comptes rendus*, 1891, 112, p. 950; 1892, 115, p. 123). The diamide, PN_2H_4 , was obtained by Hugot (*ibid.*, 1905, 141, p. 1235) by acting with ammonia gas on phosphorus tribromide or tri-iodide at -70° ; it is very unstable, and decomposes at -25° . Phosphorus combines with nitrogen and chlorine to form several polymeric substances of the general formula $(PNCl_2)_x$, where x may be 1, 3, 4, 5, 6, 7, or 11; they may be obtained by heating the pentachloride with ammonium chloride in a sealed tube and separating the mixture by fractional distillation (H. N. Stokes, *Amer. Chem. Jour.*, 1898, 20, p. 740; also see Besson and Rosset, *Comptes rendus*, 1906, 37, p. 143). The commonest form is $P_3N_3Cl_4$, a crystalline solid, insoluble in water, but soluble in alcohol and ether. Several phosphoamides have been described. The diamide, $PO(NH_2)(NH)$, results when the pentachloride is saturated with ammonia gas and the first formed chlorophosphamide, $PCl_2(NH_2)$, is decomposed by water. The triamide, $PO(NH_2)_3$, results from ammonia and phosphorus oxychloride. Both these compounds on heating give phosphoamide, PON , of which a polymer $(PON)_n$ had been described by Oddo (*Gazz. chim. Ital.*, 1899, 29 (ii.), p. 330). Stokes (*Amer. Chem. Jour.*

1892, 16, p. 168; 1894, 16, pp. 123, 154) has described $\text{PO}(\text{OH})_2\text{NH}_2$ and $\text{PO}(\text{OH})(\text{NH}_2)$, whilst the compound $\text{PO}(\text{OH})\text{NH}$ was obtained by Schiff (*Ann.*, 1857, 103, p. 168) by acting with ammonia on the pentoxide. Numerous other nitrogen compounds have been obtained.

The atomic weight of phosphorus was determined by Berzelius, Pflouze, Jacquelin, Dumas, Schrotter, Brodie and van der Plaats. More recent are the investigations of G. Ter Gazarian (*Compt. rend.*, 1909, 148, p. 1397) on hydrogen phosphide, which gave the value 30.966, and of G. P. Baxter and C. Jones (*Journ. Amer. Chem. Soc.*, 1910, 32, p. 298) on silver phosphate, which gave the value 31.04.

Therapeutics.—The phosphorus used in the British pharmacopoeia is obtained from calcium phosphate, and is a waxlike non-metallic substance soluble in oils and luminous in the dark. There are various medicinal preparations. In young animals phosphorus has a remarkable influence on the growth of bone, causing a proliferation of the jelly-like masses and finally a deposit in them of true bony material. Owing to this influence it has been used in rickets and osteomalacia. Its most effective use, however, is as a nerve tonic in paralysis agitans, locomotor ataxia, impotence and nervous exhaustion. In some skin diseases such as psoriasis, chronic eczema and acne indurata, phosphorus is very useful, and cases of diabetes mellitus and lymphadenoma have improved under some of its compounds. The hypophosphites have been recommended in pulmonary affections, being said to act as free phosphorus without being irritant, and the glycerophosphates are certainly useful to stimulate metabolism. Dilute phosphoric acid is used as a gastric stimulant. It does not resemble phosphorus in its physiological action and cannot be used to replace it.

Toxicology.—Poisonous amounts of phosphorus are frequently taken or administered, criminally or accidentally, it being easily accessible to the public in the form of matches or of vermin pastes. They may have been swallowed several hours before symptoms of acute poisoning show themselves, with nausea and vomiting, and a burning in the oesophagus, stomach and abdomen. The important thing is to prevent the absorption of the poison, so emetics and purgatives should be given at once. Sulphate of copper, in doses of 3 to 5 gr., freely diluted and repeated every few minutes forms the harmless, black phosphide of copper, which is rapidly eliminated by the kidneys. The stomach may be washed out with warm water and then with a 2% solution of permanganate of potash, an enema of the same solution being given. The old French oil of turpentine is the best antidote to use in phosphorus poisoning, delaying the toxic effects; but ordinary oils are not only useless but harmful. When some time has elapsed before treatment and the phosphorus has become absorbed, the organic degenerative changes cannot be easily controlled. For the chronic form of industrial poisoning in the manufacture of lucifer matches—a form of necrosis, known in England as "phossy jaw" and in France as "*mal chimique*," a localized inflammatory infection of the periosteum, ending with the death and exfoliation of part of the bone—see MATCH.

PHOTIUS (c. 820–892), patriarch of Constantinople (858–867 and 878–886). From his early years he displayed an extraordinary talent and appetite for knowledge, and as soon as he had completed his own education he began to teach with distinguished success grammar, rhetoric, divinity and philosophy. The way to public life was probably opened for him by the marriage of his brother Sergius to the princess Irene, sister of Theodora, who, upon the death of her husband Theophilus in 842, had assumed the regency of the empire. Photius became captain of the guard and subsequently first imperial secretary. The dissensions between the patriarch Ignatius and Bardas, the uncle of the youthful Emperor Michael III., brought promotion to Photius. Ignatius was arrested and imprisoned (Nov. 858), and upon refusing to resign his office was illegally deposed, while Photius, although a layman, received all the necessary sacerdotal orders within six days, and was installed as patriarch in his place. Ignatius, continuing to refuse the abdication which could alone have given Photius's elevation a semblance of legality, was treated with extreme severity. His cause was subsequently espoused by Pope Nicholas in a manner highly offensive to the

independent feeling of the Eastern Church. Photius felt himself the champion of Eastern Christianity against Latin pretensions; and when in 863 Nicholas finally anathematized and deposed him, he replied by a counter-excommunication. Meanwhile, the situation was suddenly changed by the murder of Photius's patron, Bardas, by order of the emperor Michael, who was himself assassinated by his colleague Basil in the following year (867). The fall of Photius immediately ensued; he was removed from his office and banished about the end of September 867, a few days after the accession of Basil, and Ignatius was reinstated on the 23rd of November. About 876 Photius was suddenly recalled to Constantinople and entrusted with the education of Basil's children. On the death of Ignatius, probably in October 878, Photius, after a decent show of reluctance, again filled the patriarchal throne. He then proceeded to obtain the formal recognition of the Christian world. In November 879 a synod was convened at Constantinople. The legates of Pope John VIII. attended, prepared to acknowledge Photius as legitimate patriarch, a concession for which John was much censured by Latin opinion. He stood firm, however, on the other two points which had long been contested between the Eastern and Western Churches, the ecclesiastical jurisdiction over Bulgaria and the introduction of the "filioque" clause into the creed. He disowned his legates, who had shown a tendency to yield, again excommunicated Photius, and thus aroused the open hostility which has never been appeased to this day. Strong in the support of the council, Photius simply ignored him. At the height of glory and success he was suddenly precipitated from his dignity by another palace revolution. After the death of Basil (886), his son and successor Leo, who had formerly been devoted to Photius, but in recent years displayed great hatred towards him, deprived him of his office and banished him to the monastery of Bordi in Armenia. From this time Photius disappears from history. No letters of this period of his life are extant, which leads to the inference that his imprisonment was severe. The precise date of his death is not known, but it is said to have occurred on the 6th of February 892.

For long after Photius's death his memory was held in no special honour by his countrymen. But when, in the crusading age, the Greek Church and state were alike in danger from Latin encroachments, Photius became a national hero, and is at present regarded as little short of a saint. To this character he has not the least pretension. Few men, it is probable, have been more atrociously calumniated; but, when every specific statement to his prejudice has been rejected, he still appears on a general review of his actions worldly, crafty and unscrupulous. Yet he shows to no little advantage as an ecclesiastical statesman. His firmness was heroic, his sagacity profound and far-seeing; he supported good and evil fortune with equal dignity; and his fall was on both occasions due to revolutions beyond his control. In erudition, literary power, and force and versatility of intellect he far surpassed every contemporary.

The most important of the works of Photius is his renowned *Bibliotheca* or *Myriobiblon* (ed. I. Bekker, 1824–1825), a collection of extracts from and abridgments of 280 volumes of classical authors (usually cited as *Codices*), the originals of which are now to a great extent lost. The work is especially rich in extracts from historical writers. To Photius we are indebted for almost all we possess of Ctesias, Memnon, Conon, the lost books of Diodorus Siculus, and the lost writings of Arrian. Theology and ecclesiastical history are also very fully represented, but poetry and ancient philosophy are almost entirely ignored. It seems that he did not think it necessary to deal with those authors with whom every well-educated man would naturally be familiar. The literary criticisms, generally distinguished by keen and independent judgment, and the excerpts, vary considerably in length. The numerous biographical notices are probably taken from the work of Hesyclus of Miletus. The *Lexicon* (*Ἀλέξων Δυναμῶν*), published later than the *Bibliotheca*, was probably in the main the work of some of his pupils. It was intended as a book of reference to facilitate the reading of old classical and sacred authors, whose language and vocabulary were out of date. The only MS. of the *Lexicon* is the Codex Galeanus, formerly in the possession of Thomas Gale (q.v.), and now in the library of Trinity College, Cambridge (ed. S. A. Naber, 1864, with introduction on the authorities, critical commentary, and valuable indexes). His most important theological work is the *Amphilochia*, a collection of some 300 questions and answers on difficult points in Scripture, addressed to Amphilochus, archbishop of Cyzicus (ed. Sophocles Oeconomus, Athens, 1858). Other similar works are his treatise in four books

against the Manichaeans and Paulicians, and his controversy with the Latins on the Procession of the Holy Spirit. His *Epistles*, political and private, addressed to high church and state dignitaries, are valuable for the light they throw upon the character and versatility of the writer (ed. J. Valettas, London, 1864). A large number of his speeches and homilies have been edited by S. Aristarches (1900). The only complete edition is Bishop Malou's in Migne's *Patrologia graeca*, ci.-cv. R. Reitzenstein (*Der Anfang des Lexikons des Photius*, 1907) has published a hitherto-unedited MS. containing numerous fragments from various verse and prose authors.

After the allusions in his own writings the chief contemporary authority for the life of Photius is his bitter enemy, Nicetas the Paphlagonian, the biographer of his rival Ignatius. The standard modern work is that of Cardinal Hergenröther, *Photius, Patriarch von Constantinopel* (1867-1869). As a dignitary of the Roman Catholic Church, Cardinal Hergenröther is inevitably biased against Photius as an ecclesiastic, but his natural candour and sympathy with intellectual eminence have made him just to the man.

See also article by F. Kattenbusch in Herzog-Hauck's *Realencyclopädie für protestantische Theologie* (1904), containing full bibliographical details; J. A. Fabricius, *Bibliotheca graeca*, 2, 670-776, xi, 1-37; C. Krumbacher, *Geschichte der byzantinischen Literatur*, pp. 73-79, 515-524 (2nd ed., 1897); J. E. Sandys, *History of Classical Scholarship* (2nd ed., 1906).

PHOTOCHEMISTRY (Gr. *phōs*, light, and "chemistry"), in the widest sense, the branch of chemical science which deals with the optical properties of substances and their relations to chemical constitution and reactions; in the narrower sense it is concerned with the action of light on chemical change. The first definition includes such subjects as refractive and dispersive power, colour, fluorescence, phosphorescence, optical isomerism, spectroscopy, &c.—subjects which are treated under other headings; here we only discuss the subject matter of the narrower definition.

Probably the earliest photochemical investigations were associated with the darkening of certain silver salts under the action of light, processes which were subsequently utilized in photography (*q.v.*). At the same time, however, it had been observed that other chemical changes were regulated by the access of light; and the first complete study of such a problem was made by J. W. Draper in 1843, who investigated the combination of hydrogen and chlorine to form hydrochloric acid, a reaction which had been previously studied by Gay-Lussac and Thenard. Draper concluded that the first action of sunlight consisted in producing an allotrope of chlorine, which subsequently combined with the hydrogen. This was denied by Bunsen and Roscoe in 1857; and in 1887 Pringsheim suggested that the reaction proceeded in two stages: $\text{H}_2\text{O} + \text{Cl}_2 = \text{Cl}_2\text{O} + \text{H}_2$, $2\text{H}_2 + \text{Cl}_2\text{O} = \text{H}_2\text{O} + 2\text{HCl}$. This view demands the presence of water vapour (H. B. Baker showed that the perfectly dry gases would not combine), and also explains the period which elapses before the reaction commenced (the "photochemical induction" of Bunsen and Roscoe) as taken up by the formation of the chlorine monoxide necessary to the second part of the reaction. The decomposition of hydriodic acid into hydrogen and iodine was studied by Lemoine in 1877, who found that 80% decomposed after a month's exposure; he also observed that the reaction proceeded quicker in blue vessels than in red. A broader investigation was published by P. L. Chastaing in 1878, who found that the red rays generally oxidized inorganic compounds, whilst the violet reduces them, and that with organic compounds the action was entirely oxidizing. These and other reactions suggested the making of actinometers, or instruments for measuring the actinic effect of light waves. The most important employ silver salts; Eder developed a form based on the reaction between mercuric chloride and ammonium oxalate: $2\text{HgCl}_2 + (\text{NH}_4)_2\text{C}_2\text{O}_4 = 2\text{HgCl} + 2\text{NH}_4\text{Cl} + 2\text{CO}_2$, the extent of the decomposition being determined by the amounts of mercurous chloride or carbon dioxide liberated.

The article **PHOTOGRAPHY** (*q.v.*) deals with early investigations on the chemical action of light, and we may proceed here to modern work on organic compounds. That sunlight accelerates the action of the halogens, chlorine and bromine, on such compounds, is well known. John Davy obtained phosgene, COCl_2 , by the direct combination of chlorine and carbon monoxide in sunlight (see Weigert, *Ann. d. Phys.*, 1907 (iv.), 24, p. 55):

chlorine combines with half its volume of methane explosively in sunlight, whilst in diffused light it substitutes; with toluene it gives benzyl chloride, $\text{C}_6\text{H}_5\text{CH}_2\text{Cl}$, in sunlight, and chlorotoluene, $\text{C}_6\text{H}_4(\text{CH}_3)\text{Cl}$, in the dark; with benzene it gives an addition product, $\text{C}_6\text{H}_6\text{Cl}_2$, in sunlight, and substitutes in the dark. Bromine departs itself similarly, substituting and forming addition products with unsaturated compounds more readily in sunlight. Sometimes isomerization may occur; for instance, Wislicenus found that angelic acid gave dibromangelic acid in the dark, and dibromitiglic acid in sunlight. Many substances decompose when exposed to sunlight; for example, alkyl iodides darken, owing to the liberation of iodine; aliphatic acids (especially dibasic) in the presence of uranic oxide lose carbon dioxide; polyhydric alcohols give products identical with those produced by fermentation; whilst aliphatic ketones give a hydrocarbon and an acid.

Among aromatic compounds, benzaldehyde gives a trimeric and tetrameric benzaldehyde, benzoic acid and hydrobenzoin (G. L. Ciamician and P. Silber, *Atti. R. Accad. Lincei*, 1909); in alcoholic solution it gives hydrobenzoin; whilst with nitrobenzene it is oxidized to benzoic acid, the nitrobenzene suffering reduction to nitrosobenzene and phenyl- β -hydroxylamine; the latter isomerizes to ortho- and para-aminophenol, which, in turn, combine with the previously formed benzoic acid. Similarly acetophenone and benzophenone in alcoholic solution give dimethylhydrobenzoin and benzopinacol. With nitro compounds Sach and Hilbert concluded that those containing a $\cdot\text{CH}$ side group in the ortho position to the $\cdot\text{NO}_2$ group were decomposed by light. For example, ortho-nitrobenzaldehyde in alcoholic solution gives nitrosobenzoic ester and 2' azoxybenzoic acid, with the intermediate formation of nitrobenzaldehyde-diethylacetal, $\text{NO}_2\cdot\text{C}_6\text{H}_4\cdot\text{CH}(\text{OC}_2\text{H}_5)_2$ (E. Bamberger and F. Elgar, *Ann.* 1910, 371, p. 319). Bamberger also investigated nitrosobenzene, obtaining azoxybenzene as chief product, together with various azo compounds, nitrobenzene, aniline, hydroquinone and a resin.

For the photochemistry of diazo derivatives see Ruff and Stein, *Ber.*, 1901, 34, p. 1668, and of the terpenes see G. L. Ciamician and P. Silber, *Ber.*, 1907 and 1908.

Light is also powerful in producing isomerization and polymerization. Isomerization chiefly appears in the formation of stable stereo-isomers from the labile forms, and more rarely in inducing real isomerization or phototropy (Marckwald, 1899). As examples we may notice the observation of Chatterway (*Journ. Chem. Soc.*, 1906, 89, p. 462) that many phenylhydrazones (yellow) change into azo compounds (red), of M. Padoa and F. Graziani (*Atti. R. Accad. Lincei*, 1909) on the β -naphthylhydrazones (the α -compounds are not phototropic), and of A. Senier and R. G. Shephard (*Journ. Chem. Soc.*, 1909, 95, p. 1943) on the arylidene- and naphthylidene-amines, which change from yellow to orange on exposure to sunlight. Light need not act in the same direction as heat (changes due to heat may be termed *thermotropic*). For example, heat changes the form of benzyl- β -aminocrotonic ester into the β form, whereas light reverses this; similarly heat and light have reverse actions with *as*-diphenyl ethylene, $\text{CH}_2\cdot\text{C}(\text{C}_6\text{H}_5)_2$ (R. Stoermer, *Ber.*, 1909, 42, p. 4865); the change, however, is in the same direction with Senier and Shephard's compounds. With regard to polymerization we may notice the production of benzene derivatives from acetylene and its homologues, and of tetramethylenes from the olefines.

Theory of Photochemical Action.—Although much work has been done in the qualitative and quantitative study of photochemical reactions relatively little attention has been given to the theoretical explanation of these phenomena. That the solution was to be found in an analogy to electrolysis was suggested by Grothuss in 1818, who laid down: (1) only those rays which are absorbed can produce chemical change, (2) the action of the light is analogous to that of a voltaic cell; and he regarded light as made up of positive and negative electricity. The first principle received early acceptance; but the development of the second is due to W. D. Bancroft who, in a series of

papers in the *Journal of Physical Chemistry* for 1908 and 1909, has applied it generally to the reactions under consideration. Any electrolytic action demands a certain minimum electromotive force; this, however, can be diminished by suitable depolarizers, which generally act by combining with a product of the decomposition. Similarly, in some photochemical reactions the low electromotive force of the light is sufficient to induce decomposition, but in other cases a depolarizer must be present. For example, ferric chloride in aqueous solution is unchanged by light, but in alcoholic solution reduction to ferrous chloride occurs, the liberated chlorine combining with the alcohol. In the same way Bancroft showed that the solvent media employed in photographic plates act as depolarizers. The same theory explains the action of sensitizers, which may act optically or chemically. In the first case they are substances having selective absorption, and hence alter the sensitivity of the system to certain rays. In the second case there are no strong absorption bands, and the substances act by combining with the decomposition products. Bancroft applied his theory to the explanation of photochemical oxidation, and also to the chlorination and bromination of hydrocarbons. In the latter case it is supposed that the halogen produces ions; if the positive ions are in excess side chains are substituted, if the negative the nucleus.

Standard treatises are: J. M. Eder, *Handbuch der Photographie*, vol. i. pt. 2 (1906); H. W. Vogel, *Photochemie* (1906). An account of the action of light on organic compounds is given in A. W. Stewart, *Recent Advances in Organic Chemistry* (1908).

PHOTOGRAPHY (Gr. *φῶς*, light, and *γράφειν*, to write), the science and art of producing pictures by the action of light on chemically prepared (sensitized) plates or films.

History.

It would be somewhat difficult to fix a date when what we now know as "photographic action" was first recorded. No doubt the tanning of the skin by the sun's rays was what was first noticed, and this is as truly the effect of solar radiation as is the darkening of the sensitive paper which is now in use in photographic printing operations. We may take it that K. W. Scheele was the first to investigate the darkening action of sunlight on silver chloride. He found that when silver chloride was exposed to the action of light beneath water there was dissolved in the fluid a substance which, on the addition of lunar caustic (silver nitrate), caused the precipitation of new silver chloride, and that on applying a solution of ammonia to the blackened chloride an insoluble residue of metallic silver was left behind. He also noticed that of the rays of the spectrum the violet most readily blackened the silver chloride. In Scheele, then, we have the first who applied combined chemical and spectrum analysis to the science of photography. In 1782 J. Senebier repeated Scheele's experiments, and found that in fifteen seconds the violet rays blackened silver chloride as much as the red rays did in twenty minutes.¹ In 1798 Count Rumford contributed a paper to the *Philosophical Transactions* entitled "An inquiry concerning the chemical properties that have been attributed to light," in which he tried to demonstrate that all effects produced on metallic solution could be brought about by a temperature somewhat less than that of boiling water. Robert Harrup in 1802, however, conclusively showed in *Nicholson's Journal* that, at all events, salts of mercury were reduced by visible radiation and not by change of temperature.

In 1801 we come to the next decided step in the study of photographic action, when Johann Wilhelm Ritter (1776-1810) proved the existence of rays lying beyond the violet, and found that they had the power of blackening silver chloride. Such a discovery naturally gave a direction to the investigations of others, and Thomas Johann Seebeck (1770-1831) (between 1802 and 1808) and, in 1812, Jacques Étienne Bérard (1789-1869) turned their attention to this particular subject, eliciting valuable information. We need only mention two or three other cases

¹ It may here be remarked that had he used a pure spectrum he would have found that the red rays did not blacken the material in the slightest degree.

where the influence of light was noticed at the beginning of the 19th century. William Hyde Wollaston observed the conversion of yellow gum guaiacum into a green tint by the violet rays, and the restoration of the colour by the red rays—both of which are the effect of absorption of light, the original yellow colour of the gum absorbing the violet rays, whilst the green colour to which it is changed absorbs the red rays. Sir Humphry Davy found that puce-coloured lead oxide, when damp, became red in the red rays, whilst it blackened in the violet rays, and that the green mercury oxide became red in the red rays—again an example of the necessity of absorption to effect a molecular or chemical change in a substance. U. R. T. Le Bouvier Desmorties in 1801 observed the change effected in Prussian blue, and Carl Wilhelm Böckman noted the action of the two ends of the spectrum on phosphorus, a research which John William Draper extended farther in America at a later date.

To England belongs the honour of first producing a photograph by utilizing Scheele's observations on silver chloride. In June 1802 Thomas Wedgwood (1771-1805) published in the *Journal of the Royal Institution* the paper—"An account of a method of copying paintings upon glass and of making profiles by the agency of light upon nitrate of silver, with observations by H. Davy." He remarks that white paper or white leather moistened with a solution of silver nitrate undergoes no change when kept in a dark place, but on being exposed to the daylight it speedily changes colour, and, after passing through various shades of grey and brown, becomes at length nearly black. The alteration of colour takes place more speedily in proportion as the light is more intense.

"In the direct beam of the sun two or three minutes are sufficient to produce the full effect, in the shade several hours are required, and light transmitted through different-coloured glasses acts upon it with different degrees of intensity. Thus it is found that red rays, or the common sunbeams passed through red glass, have very little action upon it; yellow and green are more efficacious, but blue and violet light produce the most decided and powerful effects."

Wedgwood goes on to describe the method of using this prepared paper by throwing shadows on it, and inferentially by what we now call "contact printing." He states that he has been unable to fix his prints, no washing being sufficient to eliminate the traces of the silver salt which occupied the unexposed or shaded portions. Davy in a note states that he has found that, though the images formed by an ordinary camera obscura were too faint to print out in the solar microscope, the images of small objects could easily be copied on such paper.

"In comparing the effects produced by light upon muriate of silver (silver chloride) with those upon the nitrate it seemed evident that the muriate was the more susceptible, and both were more readily acted upon when moist than when dry—a fact long ago known. Even in the twilight the colour of the moist muriate of silver, spread upon paper, slowly changed from white to faint violet; though under similar circumstances no intermediate alteration was produced upon the nitrate. . . . Nothing but a method of preventing the unshaded parts of the delineations from being coloured by exposure to the day is wanting to render this process as useful as it is elegant."

In this method of preparing the paper lies the germ of the silver-printing processes of modern times, and it was only by the spread of chemical knowledge that the hiatus which was to render the "process as useful as it is elegant" was filled up—when sodium thiosulphate (hyposulphite of soda), discovered by François Chausier in 1799, or three years before Wedgwood published his paper, was used for making the print permanent. Here we must call attention to an important observation by Seebeck of Jena in 1810. In the *Farbenlehre* of Goethe he says:—

"When a spectrum produced by a properly constructed prism is thrown upon moist chloride of silver paper, if the printing be continued for from fifteen to twenty minutes, whilst a constant position for the spectrum is maintained by any means, I observe the following. In the violet the chloride is a reddish brown (sometimes more violet, sometimes more blue), and this coloration extends well beyond the limit of the violet; in the blue the chloride takes a clear blue tint, which fades away, becoming lighter in the green. In the yellow I usually found the chloride unaltered; sometimes, however, it had a light yellow tint; in the red and beyond the red it took a rose or lilac tint. This image of the spectrum shows beyond the red and the violet a region more or less light and uncoloured. This is how the decomposition of the silver chloride is seen in this region. Beyond

the brown band, . . . which was produced in the violet, the silver chloride was coloured a grey-violet for a distance of several inches. In proportion as the distance from the violet increased, the tint became lighter. Beyond the red, on the contrary, the chloride took a feeble red tint for a considerable distance. When moist chloride of silver, having received the action of light for a time, is exposed to the spectrum, the blue and violet behave as above. In the yellow and red regions, on the other hand, it is found that the silver chloride becomes paler; . . . the parts acted upon by the red rays and by those beyond take a light coloration."

This has been brought forward by J. M. Eder as being the first record we have of photographic action lending itself to production of natural colours. This observation of Seebeck was allowed to lie fallow for many years, until it was again taken up and published as a novelty.

The first to found a process of photography which gave pictures that were subsequently unaffected by light was Nicéphore de Niepce. His process, which he called provisionally "héliographie, dessins, et gravures," consists in coating the surface of a metallic plate with a solution of asphaltum in oil of lavender and exposing it to a camera image. He recommends that the asphaltum be powdered and the oil of lavender dropped upon it in a wine-glass, and that it be then gently heated. A polished plate is covered with this varnish, and, when dried, is ready for employment in the camera. After requisite exposure, which is very long indeed, a very faint image, requiring development, is seen. Development is effected by diluting oil of lavender with ten parts by volume of white petroleum. After this mixture has been allowed to stand two or three days it becomes clear and is ready to be used. The plate is placed in a dish and covered with the solvent. By degrees the parts unaffected by light dissolve away, and the picture, formed of modified asphaltum, is developed. The plate is then lifted from the dish, allowed to drain, and finally freed from the remaining solvents by washing in water. Subsequently, instead of using oil of lavender as the asphaltum solvent, Niepce employed an animal oil, which gave a deeper colour and more tenacity to the surface-film.

Later, Louis Jacques Mandé Daguerre (1789-1851) and Niepce used as a solvent the brittle residue obtained from evaporating the oil of lavender dissolved in ether or alcohol—a transparent solution of a lemon-yellow colour being formed. This solution was used for covering glass or silver plates, which, when dried, could be used in the camera. The time of exposure varied somewhat in length. Daguerre remarked that "the time required to procure a photographic copy of a landscape is from seven to eight hours, but single monuments, when strongly lighted by the sun, or which are themselves very bright, can be taken in about three hours." Perhaps there is no sentence that illustrates more forcibly the advance made in photography from the days when this process was described. The ratio of three hours to $\frac{1}{25}$ th of a second is a fair estimate of the progress made since Niepce. The development was conducted by means of petroleum-vapour, which dissolved the parts not acted upon by light. As a rule silver plates seem to have been used, and occasionally glass; but it does not appear whether the latter material was chosen because an image would be projected through it or whether simply for the sake of effect. Viewed in the light of present knowledge, a more perfectly developable image in half-tone would be obtained by exposing the film through the back of the glass. The action of light on most organic matter is apparently one of oxidation. In the case of asphaltum or bitumen of Judæa the oxidation causes a hardening of the material and an insolubility in the usual solvents. Hence that surface of the film is generally hardened first which first feels the influence of light. Where half-tones exist, as in a landscape picture, the film remote from the surface first receiving the image is not acted upon at all, and remains soluble in the solvent. It is thus readily seen that, in the case of half-tone pictures, or even in copying engravings, if the action were not continued sufficiently long when the surface of the film farthest from the glass was first acted upon, the layer next the glass would in some places remain soluble, and on development would be dissolved away, carrying the top layer of hardened resinous

matter with it, and thus give rise to imperfect pictures. In carbon-printing development from the back of the exposed film is absolutely essential, since it depends on the same principles as does heliography, and in this the same mode of procedure is advisable.

It would appear that Niepce began his researches as early as 1814, but it was not till 1827 that he had any success worth recounting. At that date he communicated a paper to Dr Bauer of Kew, the secretary of the Royal Society of London, with a view to its presentation to that society. Its publication, however, was prevented because the process, of which examples were shown, was a secret one. In an authentic MS. copy of Niepce's "Mémoire," dated "Kew, le 8 Décembre 1827," he says that "in his framed drawings made on tin the tone is too feeble, but that by the use of chemical agents the tone may be darkened." This shows that Niepce was familiar with the idea of using some darkening medium even with his photographs taken on tin plates.

Daguerreotype.—We have noticed in the joint process of Daguerre and Niepce that polished silver plates were used, and we know from the latter that amongst the chemical agents tried iodine suggested itself. Iodine vapour or solution applied to a silvered plate would cause the formation of silver iodide on those parts not acted upon by light. The removal of the resinous picture would leave an image formed of metallic silver, whilst the black parts of the original would be represented by the darker silver iodide. This was probably the origin of the daguerreotype process. Such observers as Niepce and Daguerre, who had formed a partnership for prosecuting their researches, would not have thus formed silver iodide without noticing that it changed in colour when exposed to the light. What parts respectively Daguerre and Niepce played in the development of the daguerreotype will probably never be known with absolute accuracy, but in a letter from Dr Bauer to Dr J. J. Bennett, F.R.S., dated the 7th of May 1839, the former says:—

"I received a very interesting letter from Mons. Isidore Niepce, dated 12th March about a month after the publication of the daguerreotype process, and that letter fully confirms what I suspected of Daguerre's manoeuvres with poor Nicéphore, but Mr Isidore observes that for the present that letter might be considered confidential."

Dr Bauer evidently knew more of "poor Nicéphore's" work than most people, and at that early period he clearly thought that an injustice had been done to Niepce at the hands of Daguerre. It should be remarked that Nicéphore de Niepce died in 1833, and a new agreement was entered into between his son Isidore de Niepce and Daguerre to continue the prosecution of their researches. It appears further that Niepce communicated his process to Daguerre on the 5th of December 1829. At his death some letters from Daguerre and others were left by him in which iodine, sulphur, phosphorus, &c., are mentioned as having been used on the metal plates, and their sensitiveness to light, when thus treated, commented upon. We are thus led to believe that a great part of the success in producing the daguerreotype is due to the elder Niepce; and indeed it must have been thought so at the time, since, on the publication of the process, life-pensions of 6000 francs and 4000 francs were given to Daguerre and to Isidore Niepce respectively. In point of chronology the publication of the discovery of the daguerreotype process was made subsequently to the Talbot-type process. It will, however, be convenient to continue the history of the daguerreotype, premising that it was published on the 6th of February 1839, whilst Talbot's process was given to the world on the 25th of January of the same year.

Daguerreotype pictures were originally taken on silver-plated copper, and even now the silvered surface thus prepared serves better than electro-deposited silver of any thickness. An outline of the operations is as follows. A brightly-polished silver plate is cleaned by finely-powdered pumice and olive oil, and then by dilute nitric acid, and a soft buff is employed to give it a brilliant polish, the slightest trace of foreign matter or stain being fatal to the production of a perfect picture. The plate, thus prepared, is ready for the iodizing operation. Small fragments of iodine are scattered over a saucer, covered with gauze. Over this the plate is placed, face downwards, resting on supports, and the vapour from the iodine is allowed to form upon it a surface of silver iodide. It is essential to note the colour of the surface-formed iodide at its several stages, the varying colours being due to interference colours

caused by the different thicknesses of the minutely thin film of iodide. The stage of maximum sensitiveness is obtained when it is of a golden orange colour. In this state the plate is withdrawn and removed to the dark slide of the camera, ready for exposure. A plan frequently adopted to give an even film of iodide was to saturate a card with iodine and hold the plate a short distance above the card. Long exposures were required, varying in Paris from three to thirty minutes. The length of the exposure was evidently a matter of judgment, more particularly as over-exposure introduced an evil which was called "solarization," but which was in reality due to the oxidation of the iodide by prolonged exposure to light.

As a matter of history it may be remarked that the development of the image by mercury vapour is said to be due to a chance discovery of Daguerre. It appears that for some time previous to the publication of the daguerreotype method he had been experimenting with iodised silver plates, producing images by what would now be called the "printing out process." This operation involved so long an exposure that he sought some means of reducing it by the application of different reagents. Having on one occasion exposed such a plate to a camera-image, he accidentally placed it in the dark in a cupboard containing various chemicals, and found after the lapse of a night that he had a perfect image developed. By the process of exhaustion he arrived at the fact that it was the mercury vapour, which even at ordinary temperatures volatilizes, that had caused this intensification of the almost invisible camera-image. It was this discovery that enabled the exposures to be very considerably shortened from those which it was found necessary to give in mere camera-printing.

The development of the image was effected by placing the exposed plate over a slightly heated (about 75° C.) cup of mercury. The vapour of mercury condensed on those places where the light had acted in an almost exact ratio to the intensity of its action. This produced a picture in an amalgam, the vapour of which attached itself to the altered silver iodide. Proof that such was the case was subsequently afforded by the fact that the mercurial image could be removed by heat. The developing box was so constructed that it was possible to examine the picture through a yellow glass window whilst the image was being brought out. The next operation was to fix the picture by dipping it in a solution of hyposulphite of soda. The image produced by this method is so delicate that it will not bear the slightest handling, and has to be protected from accidental touching.

The first great improvement in the daguerreotype process was the resensitizing of the iodized film by bromine vapour. John Frederick Goddard published his account of the use of bromine in conjunction with iodine in 1846, and A. F. J. Claudet (1797-1867) employed a combination of iodine and chlorine vapour in 1841. In 1844 Daguerre published his improved method of preparing the plates, which is in reality based on the use of bromine with iodine. That this addition points to additional sensitiveness will be readily understood when we remark that so-called instantaneous pictures of yachts in full sail, and of large size, have been taken on plates so prepared—a feat which is utterly impossible with the original process as described by Daguerre. The next improvement in the process was toning or gilding the image by a solution of gold, a practice introduced by H. L. Fizeau. Gold chloride is mixed with hyposulphite of soda, and the levelled plate, bearing a sufficient quantity of the fluid, is warmed by a spirit-lamp until the required vigour is given to the image, as a consequence of which it is better seen in most lights. Nearly all the daguerreotypes extant have been treated in this manner, and no doubt their permanence is in a great measure due to this operation. Images of this class can be copied by taking electrolytes from them, as shown by Sir W. R. Grove and others. These reproductions are admirable in every way, and furnish a proof that the daguerrean image is a relief.

Fox-Talbot Process.—In January 1839 Fox Talbot described the first of his processes, photogenic drawing, in a paper to the Royal Society. He states that he began experimenting in 1834, and that in the solar microscope he obtained an outline of the object to be depicted in full sunshine in half a second. He published in the *Philosophical Magazine* full details of his method, which consisted essentially in soaking paper in common salt, brushing one side only of it with about a 12% solution of silver nitrate in water, and drying at the fire. Fox Talbot stated that by repeating the alternate washes of the silver and salt—always ending, however, with the former—greater sensitiveness was attained. This is the same in every respect as the method practised by Wedgwood in 1802; but, when we come

to the next process, which he called "calotype" or "beautiful picture," we have a distinct advance. This process Talbot protected by a patent in 1841.

It may be briefly described as the application of silver iodide to a paper support. Carefully selected paper was brushed over with a solution of silver nitrate (100 grains to the ounce of distilled water), and dried by the fire. It was then dipped into a solution of potassium iodide (500 grains being dissolved in a pint of water), where it was allowed to stay two or three minutes until silver iodide was formed. In this state the iodide is scarcely sensitive to light, but is sensitized by brushing "gallo-nitrate of silver" over the surface to which the silver nitrate had been first applied. This "gallo-nitrate" is merely a mixture, consisting of 100 grains of silver nitrate dissolved in 7 oz. of water, to which is added one-sixth of its volume of acetic acid, and immediately before applying to the paper an equal bulk of a saturated solution of gallic acid in water. The prepared surface is then ready for exposure in the camera, and; after a short insolation, develops itself in the dark, or the development may be hastened by a fresh application of the "gallo-nitrate of silver." The picture is then fixed by washing it in clean water and drying slightly in blotting paper, after which it is treated with a solution of potassium bromide and again washed and dried. Here there is no mention made of hyposulphite of soda as a fixing agent, that having been first used by Sir J. Herschel in February 1840.

In a strictly historical notice it ought to be mentioned that development by means of gallic acid and silver nitrate was first known to Rev. J. B. Reade. When impressing images in the solar microscope he employed gallic acid and silver in order to render more sensitive the silver chloride paper that he was using, and he accidentally found that the image could be developed without the aid of light. The priority of the discovery was claimed by Fox Talbot; and his claim was sustained after a lawsuit, apparently on the ground that Reade's method had never been legally published. Talbot afterwards made many slight improvements in the process. In one of his patents he recognizes the value of the proper fixing of his photogenic drawings by hyposulphite of soda, and also the production of positive prints from the calotype negatives. We pass over his application of albumen to porcelain and its subsequent treatment with iodine vapour, as also his application of albumen in which silver iodide was held in suspension to a glass plate, since in this he was preceded by Niepce de St Victor in 1848.

Albumen Process on Glass.—It was a decided advance when Niepce de St Victor, a nephew of Nicéphore de Niepce, employed a glass plate and coated it with iodised albumen. The originator of this method did not meet with much success. In the hands of Blanquart Evarad it became more practicable; but it was carried out in its greatest perfection by G. Le Gray.

The outline of the operations is as follows: The whites of five fresh eggs are mixed with about one hundred grains of potassium iodide, about twenty grains of potassium bromide and ten grains of common salt. The mixture is beaten up into a froth and allowed to settle for twenty-four hours, when the clear liquid is decanted off. A circular pool of albumen is poured on a glass plate, and a straight ruler (its ends being wrapped with waxed paper to prevent its edge from touching the plate anywhere except at the margins) is drawn over the plate, sweeping off the excess of albumen, and so leaving an even film. The plate is first allowed to dry spontaneously, a final heating being given to it in an oven or before the fire. The heat hardens the albumen, and it becomes insoluble and ready for the silver nitrate bath. One of the difficulties is to prevent crystallization of the salts held in solution, and this can only be effected by keeping them in defect rather than in excess. The plate is sensitized for five minutes in a bath of silver nitrate, acidified with acetic acid, and exposed whilst still wet, or it may be slightly washed and again dried and exposed whilst in its desiccated state. The image is developed by gallic acid in the usual way.

After the application of albumen many modifications were introduced in the shape of starch, serum of milk, gelatin, all of which were intended to hold iodide *in situ* on the plate; and the development in every case seems to have been by gallic acid. At one time the waxed-paper process subsequently introduced by Le Gray was a great favourite. Paper that had been made translucent by white wax was immersed in a solution of potassium iodide until impregnated with it, after which it was sensitized in the usual way, development being by gallic acid. In images obtained by this process the high lights are represented by metallic silver, whilst the shadows are translucent. Such a print is called a "negative." When silver chloride paper is darkened by the passage of light through a negative, we get the highest lights represented by white paper and the shadows by darkened chloride. A print of this kind is called a "positive."

Collodion Process.—A great impetus was given to photography

in 1850, on the introduction of collodion (*q.v.*), a very convenient vehicle on account of the facility with which the plates are prepared, and also because it is a substance as a rule totally unaffected by silver nitrate, which is not the case with other organic substances. Thus albumen forms a definite silver compound, as do gelatin, starch and gum. The employment of collodion was first suggested by Le Gray, but it remained for Frederick Scott Archer of London, closely followed by P. W. Fry, to make a really practical use of the discovery. When collodion is poured on a glass plate it leaves on drying a hard transparent film which under the microscope is slightly reticulated. Before drying, the film is gelatinous and perfectly adapted for holding *in situ* salts soluble in ether and alcohol. Where such salts are present they crystallise out when the film is dried, hence such a film is only suitable where the plates are ready to be immersed in the silver bath. As a rule, about five grains of the soluble gun-cotton are dissolved in an ounce of a mixture of equal parts of ether and alcohol, both of which must be of low specific gravity, .725 and .805 respectively. If the alcohol or ether be much diluted with water the gun-cotton (pyroxylina) precipitates, but, even if less diluted, it forms a film which is "crapey" and uneven. Such was the material which Le Gray proposed and which Archer brought into practical use. The opaque silver plate with its one impression was abandoned; and the paper support of Talbot, with its inequalities of grain and thickness, followed suit, though not immediately. When once a negative had been obtained with collodion on a glass plate—the image showing high lights by almost complete opacity and the shadows by transparency (as was the case, too, in the calotype process)—any number of impressions could be obtained by means of the silver-printing process introduced by Fox Talbot, and they were found to possess a delicacy and refinement of detail that certainly eclipsed the finest print obtained from a calotype negative. To any one who had practised the somewhat tedious calotype process, or the waxed-paper process of Le Gray with its still longer preparation and development, the advent of the collodion method must have been extremely welcome, since it effected a saving in time, money and uncertainty. The rapidity of photographic action was much increased, and the production of a different character of pictures thus became possible.

We give an outline of the procedure. A glass plate is carefully cleaned by a detergent such as a cream of tripoli powder and spirits of wine (to which a little ammonia is often added), then wiped with a soft rag, and finally polished with a silk handkerchief or chamois leather. A collodion containing soluble iodides and bromides is made to flow over the plate, all excess being drained off when it is covered. A good standard formula for the collodion is—55 grains of pyroxylin, 5 oz. of alcohol, 5 oz. of ether; and in this liquid are dissolved 24 grains of ammonium iodide, 2 grains of cadmium iodide and 2 grains of cadmium bromide. When the collodion is set the plate is immersed in a bath of silver nitrate—a vertical form being that mostly used in England, whilst a horizontal dish is used on the continent of Europe—a good formula for which is 350 grains of silver nitrate with 10 oz. of water. The plate is steadily lowered into this solution, and moved in it until all the repellent action between the aqueous solution of the silver and the solvents of the collodion is removed, when it is allowed to rest for a couple of minutes, after which period it is taken out and placed in the dark slide ready for exposure in the camera. After undergoing proper exposure the plate is withdrawn, and in a room lighted with yellow light the developing solution is applied, which originally was a solution of pyrogallol acid in water restrained in its action by the addition of acetic acid. One of the old formulæ employed by P. H. Delamotte was 9 grains of pyrogallol acid, 2 drachms of glacial acetic acid and 3 oz. of water. The image gradually appears after the application of this solution, building itself up from the silver nitrate clinging to the film, which is reduced to the metallic state by degrees. Should the density be insufficient a few drops of silver nitrate are added to the pyrogallol acid solution and the developing action continued.

In 1844 Robert Hunt introduced another reducing agent, which is still the favourite, viz. ferrous sulphate. By its use the time of necessary exposure of the plate is reduced and the image develops with great rapidity. A sample of this developing solution is 20 grains of ferrous sulphate, 30 minims of acetic acid, with 1 oz. of water. This often leaves the image thinner than is requisite for the formation of a good print, and it is intensified with pyrogallol acid and silver. Other intensifiers are used to increase the deposit on a plate by means of mercury or uranium, followed by other solutions to still further darken the double salts formed on the film.

Such intensifying agents have to be applied to the image after the plate is fixed, which is done by a concentrated solution of hyposulphite of soda or by potassium cyanide, the latter salt having been first introduced by Martin and Marc Antoine Augustin Gaudin in 1853 (*La Lumière*, April 23, 1853). Twenty-five grains of potassium cyanide to one ounce of water is the strength of the solution usually employed. The reaction of both these fixing agents is to form with the sensitive salts of silver double hyposulphites or cyanides, which are soluble in water and salt. The utility of bromides in the collodion process seems to have been recognized in its earliest days, Scott Archer (1852) and R. J. Bingham (1850) both mentioning it. We notice this, since as late as 1866 a patent-right in its use was sought to be enforced in America, the patent being taken out by James Cutting in July 1854.

Positive Pictures by the Collodion Process.—In the infancy of the collodion process it was shown by Horne that a negative image could be made to assume the appearance of a positive by whitening the metallic silver deposit. This he effected by using with the pyrogallol acid developer a small quantity of nitric acid. A better result was obtained by P. W. Fry with ferrous sulphate and ferrous nitrate, whilst Hugh Diamond gave effect to the matter in a practical way. F. Scott Archer used mercuric chloride to whiten the image. To Robert Hunt, however, must be rewarded the credit of noticing the action of this salt on the image (*Phil. Trans.*, 1843). The whitened picture may be made to stand out against black velvet, or black varnish may be poured over the film to give the necessary black background, or, more recently, the positive pictures may be produced on japanned iron plates (lithotype plates) or on japanned leather. This process is still occasionally practised by itinerant photographers.

Moist Collodion Process.—It is seen that for the successful working of the collodion process it was necessary that the plate should be exposed very shortly after its preparation; this was a drawback, inasmuch as it necessitated taking a heavy equipment into the field. In 1856, Sir William Crookes and J. Spiller published in the *Philosophical Magazine* a process whereby they were enabled to keep a film moist (so as to prevent crystallization of the silver nitrate) several days, enabling plates to be prepared at home, exposed in the field, and then developed in the dark room. The plate was prepared in the usual way and a solution of zinc nitrate and silver nitrate in water was made to flow over it. The hygroscopic nature of the zinc salt kept sufficient moisture on the plate to attain the desired end. Various modifications in procedure have been made.

Dry Plates.—It would appear that the first experiments with collodion dry plates were due to Marc Antoine Augustin Gaudin. In *La Lumière* of the 22nd of April and the 27th of May 1854 he describes his researches on the question; whilst in England G. R. Muirhead, on the 4th of August 1854, stated that light acts almost as energetically on a dry surface as on a wet after all the silver has been washed away from the former previous to desiccation. J. M. Taupenot, however, seems to have been the first to use a dry-plate process that was really workable. His original plan was to coat a plate with collodion, sensitize it in the ordinary manner, wash it, cause a solution of albumen to flow over the surface, dry it, dip it in a bath of silver nitrate acidified with acetic acid, and wash and dry it again. The plate was then in a condition to be exposed, and was to be developed with pyrogallol acid and silver. In this method we have a double manipulation, which is long in execution, though perfectly effective.

A great advance was made in all dry-plate processes by the introduction of what is known as the "alkaline developer," which is, however, inapplicable to all plates on which silver nitrate is present in the free state. The developers previously described, either for collodion or paper processes, were dependent on the reduction of metallic silver by some such agent as ferrous sulphate, the reduction taking place gradually and the reduced particles aggregating on those portions of the film which had been acted upon by light. The action of light being to reduce the silver iodide, bromide or chloride, these reduced particles really acted as nuclei for the crystallized metal. It will be evident that in such a method of development the molecular attraction

acts at distances relatively great compared with the diameters of the molecules themselves. If it were possible to reduce the altered particles of silver salt it was plain that development would be more rapid, and also that the number of molecules reduced by light would be smaller if the metallic silver could be derived from silver compounds within shorter distances of the centres of molecular attraction. Alkaline development accomplished this to a very remarkable extent; but the method is only really practicable when applied to films containing silver bromide and chloride, as silver iodide is only slightly amenable to the alkaline development. The introduction of this developer is believed to be of American origin; and it is known that in the year 1867 Major C. Russell used it with the dry plates he introduced.

An alkaline developer consists of an alkali, a reducing agent and a restraining agent. These bodies, when combined and applied to the solid silver bromide or chloride, after being acted upon by light, were able to reduce the sub-bromide or sub-chloride, and to build up an image upon it, leaving the unaltered bromide intact, except so far as it was used in the building up. In 1877 Sir W. Abney investigated this action. A dry plate was prepared by the bath process in the usual manner (to be described below), and exposed in the camera. The exposed film was covered with another film of colloidobromide emulsion, which of course had not seen the light. An image was obtained from the double film by means of the alkaline developer, which penetrated through the upper unexposed film. The development was prolonged until an image appeared through the unexposed film, when the plate was fixed, washed and dried. A piece of gelatinous paper was cemented on the upper film, and a similar piece on the lower after both had been stripped off the glass. When quite dry the two papers were forcibly separated, a film adhering to each. The upper film, *although never exposed to light*, showed an image in some cases more intense than the under film. The action of the alkaline developer was here manifest: the silver bromide in close contiguity to the exposed particles was reduced to the metallic state. Hence, from this and similar experiments, Abney concluded that silver bromide could not exist in the presence of a freshly precipitated or reduced metallic silver, and that a sub-bromide was immediately formed. From this it will be seen that the deposited silver is well within the sphere of molecular attraction, and that consequently a less exposure (*i.e.* the reduction of fewer molecules of the sensitive salt) would give a developable image.

The alkalis used embraced the alkalis themselves and the mono-carbonates. The sole reducing agent up till recent times was pyrogallic acid. In the year 1880 Abney found that hydroquinone was even more effective than pyrogallic acid, its reducing power being stronger. Various other experimentalists tried other kindred substances, but without adding to the list of really useful agents until recently.

The following are some of the most effective:—

Eikonogen Developer.

Eikonogen	25 parts.
Sodium sulphite	50 "
Sodium carbonate	50 "
Potassium bromide	1 "
Water	1000 "

This is a one-solution developer, and acts energetically.

Metol Developer.

Solution A.	
Metol	2 parts.
Sodium sulphite	18 "
Water	100 "

Solution B.	
Sodium carbonate	6 parts.
Potassium bromide	1 "
Water	100 "

For use, take one part of A to from 1 to 3 parts of B.

Amidol Developer.

Amidol	3 parts.
Sodium sulphite	100 "
Potassium bromide	1 to 3 "
Water	1000 "

This developer requires no addition of alkali.

Ortol Developer.

Solution A.	
Ortol	15 parts.
Sodium metabisulphite	7 "
Water	1000 "

Solution B.

Sodium carbonate	100 parts.
Sodium sulphite	125 "
Potassium bromide	3 "
Water	1000 "

A and B solutions are mixed together in equal proportions.

Besides these, there are several more, such as adurol, glycin, pyrocatechin, which have been used with more or less success. They all give a black in lieu of that dark olive-green deposit of silver which is so often found with pyrogallic developers. All are alkaline developers, and the image is built up from the sensitive salt within the film. They are applicable to gelatin or collodion plates, but for the latter rather more bromide of an alkali is added, to retard fogging.

Another set of developers for dry plates dependent on the reduction of the silver bromide and the metallic state is founded on the fact that certain organic salts of iron can be utilized. In 1877 M. Carey Lea of Philadelphia and William Willis announced almost simultaneously that a solution of ferrous oxalate in neutral potassium oxalate was effective as a developer, and from that time its use has been acknowledged. In 1882 J. M. Eder demonstrated that gelatino-silver chloride plates could be developed with ferrous citrate, which could not be so readily accomplished with ferrous oxalate. The exposure for chloride plates when developed by the latter was extremely prolonged. In the same year Abney showed that if ferrous oxalate were dissolved in potassium citrate a much more powerful agent was formed, which allowed not only gelatino-chloride plates to be readily developed but also colloidio-chloride plates. These plates were undevelopable except by the precipitation method until the advent of the agents last-mentioned owing to the fact that the chloride was as readily reduced as the sub-chloride.

Amongst the components of an alkaline developer we mentioned a restrainer. This factor, generally a bromide or chloride of an alkali, serves probably to form a compound with the silver salt which has not been acted upon by light, and which is less easily reduced than is the silver salt alone—the altered particles being left intact. The action of the restrainer is regarded by some as due to its combination with the alkali. But whichever theory is correct the fact remains that the restrainer does make the primitive salt less amenable to reduction. Such restrainers as the bromides of the alkalis act through chemical means; but there are others which act through physical means, an example of which we have in the preparation of a gelatin plate. In this case the gelatin wraps up the particles of the silver compound in a colloidal sheath, as it were, and the developing solution only gets at them in a very gradual manner, for the natural tendency of all such reducing agents is to attack the particles on which least work has to be expended. In the case of silver sub-bromide the developer has only to remove one atom of bromine, whereas it has to remove two in the case of silver bromide. The sub-bromide formed by light and that subsequently produced in the act of development are therefore reduced. A large proportion of gelatin compared with the silver salt in a film enables an alkaline developer to be used without any chemical restrainer; but when the gelatin bears a small proportion to the silver such a restrainer has to be used. With collodion films the particles of bromide are more or less unenveloped, and hence in this case some kind of chemical restrainer is absolutely necessary. We may say that the organic iron developers require less restraining in their action than do the alkaline developers.

In Major Russell's process the plate was prepared by immersion in a strong solution of silver nitrate and then washed and a preservative applied. The last-named agent executes two functions, one being to absorb the halogen liberated by the action of light and the other to preserve the film from atmospheric action. Tannin, which Major Russell employed, if we mistake not, is a good absorbent of the halogens, and acts as a varnish to the film. Other collodion dry-plate processes carried out by means of the silver-nitrate bath were very numerous at one time, many different organic bodies being also employed. In most cases ordinary iodized collodion was made use of, a small percentage of soluble bromide being as a rule added to it. When plates were developed by the alkaline method this extra bromide induced density, since it was the silver bromide alone which was amenable to it, the iodide being almost entirely unaffected by the weak developer which was at that time in general use.

Dry-Plate Bath Process.—One of the most successful bath dry-plate processes was introduced by R. Manners Gordon. The plate was given an edging of albumen and then coated with ordinary iodized collodion to which one grain per ounce of cadmium bromide had been added. It was kept in the silver-nitrate bath for ten minutes, after which it was washed thoroughly. The following preservative was then applied:—

1.	{ Gum arabic	20 grs.
	{ Sugar candy	5 "
	{ Water	6 dr.
2.	{ Gallic acid	3 grs.
	{ Water	2 dr.

These ingredients were mixed just before use and, after filtering, applied for one minute to the plate, which was allowed to drain and set up to dry naturally. Great latitude is admissible in the exposure; it should rarely be less than four times or more than twenty times that which would be required for a wet plate under ordinary circumstances. The image may be developed with ferrous sulphate restrained by a solution of gelatin and glacial acetic acid, to which a solution of silver nitrate is added just before application, or by an alkaline developer.

In photographic processes not only has the chemical condition of the film to be taken into account but also the optical. When light falls on a semi-opaque or translucent film it is scattered by the particles in it and passes through the glass plate to the back. Here the rays are partly transmitted and partly reflected, a very small quantity of them being absorbed by the material of the glass. Theory points out that the strongest reflection from the back of the glass should take place at the "critical" angle. In 1875 Abney investigated the subject and proved that practice agreed with theory in every respect, and that the image of a point of light in development on a plate was surrounded by a ring of reduced silver caused by the reflection of the scattered light from the back surface of the glass, and that this ring was shaded inwards and outwards in such a manner that the shading varied with the intensity of the light reflected at different angles. To avoid "halation," as this phenomenon is called, it was usual to cover the back of dry plates with some material which should be in optical contact with it, and as nearly as possible of the same density as glass, and which at the same time should absorb all the photographically active rays. This was called "backing a plate."

Collodion Emulsion Processes.—In 1864 W. B. Bolton and B. J. Sayce published the germ of a process which revolutionized photographic manipulations. In the ordinary collodion process a sensitive film is procured by coating a glass plate with collodion containing the iodide and bromide of some soluble salt, and then, when set, immersing it in a solution of silver nitrate in order to form silver iodide and bromide in the film. The question that presented itself to Bolton and Sayce was whether it might not be possible to get the sensitive salts of silver formed in the collodion whilst liquid, and a sensitive film given to a plate by merely letting this collodion, containing the salts in suspension, flow over the glass plate. Gaudin had attempted to do this with silver chloride, and later C. W. Simpson had succeeded in perfecting a printing process with collodion containing silver chloride, citric acid and silver nitrate; but the chloride until recently has been considered a slow working salt, and nearly incapable of development. Up to the time of W. B. Bolton and B. J. Sayce's experiments silver iodide had been considered the staple of a sensitive film on which to take negatives; and though bromide had been used by Major Russell and others, it had not met with so much favour as to lead to the omission of the iodide. At the date mentioned the suspension of silver iodide in collodion was not thought practicable, and the inventors of the process turned their attention to silver bromide, which they found could be secured in such a fine state of division that it remained suspended for a considerable time in collodion, and even when precipitated could be resuspended by simple agitation. The outline of the method was to dissolve a soluble bromide in plain collodion, and add to it drop by drop an alcoholic solution of silver nitrate, the latter being in excess or defect according to the will of the operator. To prepare a sensitive surface the collodion containing the emulsified sensitive salt was poured over a glass plate, allowed to set, and washed till all the soluble salts resulting from the double decomposition of the soluble bromide and the silver nitrate, together with the unaltered soluble bromide or silver

nitrate, were removed, when the film was exposed wet, or allowed to dry and then exposed. The rapidity of these plates was not in any way remarkable, but the process had the great advantage of doing away with the sensitizing nitrate of silver bath, and thus avoiding a tiresome operation. The plates were developed by the alkaline method, and gave images which, if not primarily dense enough, could be intensified by the application of pyrogallic acid and silver nitrate as in the wet collodion process. Such was the crude germ of a method which was destined to effect a complete change in the aspect of photographic negative taking; but for some time it lay dormant. In fact there was at first much to discourage trial of it, since the plates often became veiled on development.

M. Carey Lea of Philadelphia, and W. Cooper, jun., of Reading, may be said to have given the real impetus to the method. Carey Lea, by introducing an acid into the emulsion, established a practicable collodion emulsion process, which was rapid and at the same time gave negative pictures free from veil. To secure the rapidity Carey Lea employed a fair excess of silver nitrate, and Colonel H. Stuart Wortley gained further rapidity by a still greater increase of it; the free use of acid was the only means by which this could be effected without hopelessly spoiling the emulsion. The addition of the mineral acids such as Carey Lea employed is to prevent the formation of (or to destroy when formed) any silver sub-bromide or oxide, either of which acts as a nucleus on which development can take place. Abney first showed the theoretical effect of acids on the sub-bromide, as also the effect of oxidizing agents on both the above compounds (see below). A more valuable modification was introduced in 1874 by W. B. Bolton, one of the originators of the process, who allowed the ether and the alcohol of the collodion to evaporate, and then washed away all the soluble salts from the gelatinous mass formed of pyroxilin and sensitive salt. After washing for a considerable time, the pellicle was dried naturally or washed with alcohol, and then the pyroxilin redissolved in ether and alcohol, leaving an emulsion of silver bromide, silver chloride or silver iodide, or mixtures of all suspended in collodion. In this state the plate could be coated and dried at once for exposure. Sometimes, in fact generally, preservatives were used as in the case of dry plates with the bath, in order to prevent the atmosphere from rendering the surface of the film spotty or insensitive on development. This modification had the great advantage of allowing a large quantity of sensitive salt to be prepared of precisely the same value as to rapidity of action and quality of film.

A great advance in the use of the collodion bromide process was made by Colonel Stuart Wortley, who in June 1873 made known the powerful nature of a strongly alkaline developer as opposed to the weak one which up to that time had usually been employed for a collodion emulsion plate, or indeed for any dry plate.

An example of the preparation of a collodion emulsion and the developer is the following: 2½ oz. of alcohol, 5 oz. of ether, 75 grains of pyroxilin. In 1 oz. of alcohol are dissolved 200 grains of zinc bromide; it is then acidulated with 4 or 5 drops of nitric acid, and added to half the above collodion. In 2 drachms of water are dissolved 330 grains of silver nitrate, 1 oz. of alcohol being added. The silvered alcohol is next poured into the other half of the collodion and the brominated collodion dropped in, care being taken to shake between the operations. An emulsion of silver bromide is formed in suspension; and it is in every case left for 10 to 20 hours to what is technically called "ripen," or, in other words, to become creamy when poured out upon a glass plate. When the emulsion has ripened it may be used at once or be poured out into a flat dish and the solvents allowed to evaporate till the pyroxilin becomes gelatinous. In this state it is washed in water till all the soluble salts are carried away. After this it may be either spread out on a cloth and dried or treated with two or three doses of alcohol, and then redissolved in equal parts of alcohol (specific gravity, .805) and ether (specific gravity, .720). In this condition it is a washed emulsion, and a glass plate can be coated with it and the film dried, or it may be washed and some of the many preservatives, such as albumen, beer, coffee, gum, &c., applied.

The type of a useful alkaline developer for collodion plates is as follows:—

1.	{ Pyrogallic acid	66 grs.
	{ Alcohol	1 oz.
2.	{ Potassium bromide	12 grs.
	{ Water distilled	1 oz.
3.	{ Ammonium carbonate	80 grs.
	{ Water	1 oz.

To develop the plate 6 minims of No. 1, ½ drachm of No. 2, and 3 drachms of No. 3 are mixed together and made to flow over the plate after washing the preservative off under the tap. Sometimes the

¹ An account of Sayce's process is to be found in the *Photographic News* of October 1865, or the *Photographic Journal* of the same date.

² The advantages of this salt were pointed out by Leon Warnerke in 1875.

development is conducted in a flat dish, sometimes the solution is poured on the plate.¹ The unreduced salts are eliminated by either cyanide of potassium or sodium hyposulphite. Intensity may be given to the image, if requisite, either before or after the "fixing" operation. Where resort is had to ferrous oxalate development, the developer is made in one of two ways—(1) by saturating a saturated solution of neutral potassium oxalate with ferrous oxalate, and adding an equal volume of a solution (10 grains to 1 oz. of water) of potassium bromide to restrain the action, or (2) by mixing, according to Eder's plan, 3 volumes by measure of a saturated solution of the potassium oxalate with 1 volume by measure of a saturated solution of ferrous sulphate, and adding to the ferrous oxalate solution thus obtained an equal bulk of the above solution of potassium bromide. The development is conducted in precisely the same manner as indicated above, and the image is fixed by one of the same agents.

Gelatin Emulsion Process.—The facility with which silver bromide emulsion could be prepared in collodion had turned investigation into substitutes for it. As early as September 1871 Dr R. L. Maddox had tried emulsifying the silver salt in gelatin, and had produced negatives of rare excellence. In November 1873 J. King described a similar process, getting rid of the soluble salts by washing. Efforts had also been made in this direction by J. Burgess in July 1873. R. Kennett in 1874 may be said to have been the first to put forward the gelatin emulsion process in a practical and workable form, as he then published a formula which gave good and quick results. It was not till 1878, however, that the great capabilities of silver bromide when held in suspension by gelatin were fairly known; in March of that year C. Bennett showed that by keeping the gelatin solution liquid at a low temperature for as long as seven days extraordinary rapidity was conferred on the sensitive salt. The molecular condition of the silver bromide seemed to be altered, and to be amenable to a far more powerful developer than had hitherto been dreamt of. In 1874 J. S. Stas had shown that various modifications of silver bromide and chloride were possible, and it seemed that the green molecular condition (one of those noted by Stas) of the bromide was attained by prolonged warming. It may be said that the advent of rapid plates was 1878, and that the full credit of this discovery should be allotted to C. Bennett. Both Kennett and Bennett got rid of the soluble salts from the emulsion by washing; and in order to attain success it was requisite that the bromide should be in excess of that necessary to combine with the silver nitrate used to form the emulsion. In June 1879 Abney showed that a good emulsion might be formed by precipitating a silver bromide by dropping a solution of a soluble bromide into a dilute solution of silver nitrate. The supernatant liquid was decanted, and after two or three washings with water the precipitate was mixed with the proper amount of gelatin. D. B. van Monckhoven of Ghent, in experimenting with this process, hit upon the plan of obtaining the emulsion by acting on silver carbonate with hydrobromic acid, which left no soluble salts to be extracted. He further, in August 1879, announced that he had obtained great rapidity by adding to the bromide emulsion a certain quantity of ammonia. This addition rapidly altered the silver bromide from its ordinary state to the green molecular condition referred to above. At this point we have the branching off of the gelatin emulsion process into two great divisions, viz. that in which rapidity was gained by long-continued heating, and the other in which it was gained by the use of ammonia—a subdivision which is maintained to the present day. Opinions as to the merits of the two methods are much divided, some maintaining that the quality of the heated emulsion is better than that produced by alkalinity, and vice versa. We may mention that in 1881 Dr A. Herschel introduced a plan for making an alcoholic gelatin emulsion with the idea of inducing rapid drying of the plates, and in the same year H. W. Vogel of Berlin introduced a method of combining gelatin and pyroxylin together by means of a solvent which acted on the gelatin and allowed the addition of alcohol in order to dissolve the pyroxylin. This "colloid-gelatin emulsion" was only a short-lived process, which is not surprising, since its preparation involved the inhalation of the fumes of acetic acid.

¹ For further details the reader is referred to *Instruction in Photography*, 11th ed., p. 362.

The warming process introduced by Bennett was soon superseded. Colonel Stuart Wortley in 1879 announced that, by raising the temperature of the vessel in which the emulsion was stewed to 150° F., instead of days being required to give the desired sensibility only a few hours were necessary. A further advance was made by boiling the emulsion, first practised, we believe, by G. Mansfield in 1879. Another improvement was effected by W. B. Bolton by emulsifying the silver salt in a small quantity of gelatin and then raising the emulsion to boiling point, boiling it for from half an hour to an hour, when extreme rapidity was attained. Many minor improvements in this process have been made from time to time. It may be useful to give an idea of the relative rapidities of the various processes we have described.

Daguerreotype, originally	half an hour's exposure
Calotype	2 or 3 minutes' "
Collodion	10 seconds' "
Collodion emulsion	15 seconds' "
Rapid gelatin emulsion	1/10th second "

TECHNIQUE OF PHOTOGRAPHY

Gelatin Emulsions.

The following is an outline of two representative processes. All operations should be conducted in light which can act but very slightly on the sensitive salts employed, and this is more necessary with this process than with others on account of the extreme ease with which the equilibrium of the molecules is upset in giving rise to the molecule which is developable. The light to work with is gaslight or candlelight passing through a sheet of Chance's stained red glass backed by orange paper. Stained red glass allows but few chemically effective rays to pass through it, whilst the orange paper diffuses the light. If daylight be employed, it is as well to have a double thickness of orange paper. The following should be weighed out:—

1. Potassium iodide	5 grs.
2. Potassium bromide	135 "
3. Nelson's No. 1 photographic gelatin	30 "
4. Silver nitrate	175 "
5. { Autotype or other hard gelatin	100 "
{ Nelson's No. 1 gelatin	100 "

Nos. 3 and 5 are rapidly covered with water or washed for a few seconds under the tap to get rid of any dust. No. 2 is dissolved in 1½ oz. of water, and a little tincture of iodine added till it assumes a light sherry colour. No. 1 is dissolved in 60 minims of water. No. 4 is dissolved in ½ oz. of water, and No. 3 is allowed to swell up in 1 oz. of water, and is then dissolved by heat. All the flasks containing these solutions are placed in water at 150° F. and carried into the "dark room," as the orange-lighted chamber is ordinarily called; Nos. 3 and 4 are then mixed together in a jar or flask, and No. 2 added drop by drop till half its bulk is gone, when No. 1 is added to the remainder, and the double solution is dropped in as before. When all is added there ought to be formed an emulsion which is very ruddy when examined by gaslight, or orange by daylight. The flask containing the emulsion is next placed in boiling water, which is kept in a state of ebullition for about three-quarters of an hour. It is then ready, when the contents of the flask have cooled down to about 100° F., for the addition of No. 5, which should in the interval be placed in 2 oz. of water to swell and finally be dissolved. The gelatin emulsion thus formed is placed in a cool place to set, after which it is turned into a piece of coarse canvas or mosquito netting made into a bag. By squeezing, threads of gelatin containing the sensitive salt can be made to fall into cold water; by this means the soluble salts are extracted. This is readily done in two or three hours by frequently changing the water, or by allowing running water to flow over the emulsion-threads. The gelatin is next drained by straining canvas over a jar and turning out the threads on to it, after which it is placed in a flask, and warmed till it dissolves, half an ounce of alcohol being added. Finally it is filtered through chamois leather or swansdown calico. In this state it is ready for the plates.

The other method of forming the emulsion is with ammonia. The same quantities as before are weighed out, but the solutions of Nos. 2 and 3 are first mixed together and No. 4 is dissolved in 1 oz. of water, and strong ammonia of specific gravity .880 added to it till the oxide first precipitated is just redissolved. This solution is then dropped into Nos. 2 and 3 as previously described, and finally No. 1 is added. In this case no boiling is required; but to secure rapidity it is as well that the emulsion should be kept an hour at a temperature of about 90° F., after which half the total quantity of No. 5 is added. When set the emulsion is washed, drained, and redissolved as before; but in order to give tenacity

to the gelatin the remainder of No. 5 is added *before* the addition of the alcohol, and *before* filtering.

Coating the Plates.—Glass plates are best cleaned with nitric acid, rinsed, and then treated with potash solution, rinsed again, and dried with a clean cloth. They are then ready for receiving the emulsion, which, after being warmed to about 120° F., is poured on them to cover well the surface. This being done, the plates are placed on a level shelf and allowed to stay there till the gelatin is thoroughly set; they are then put in a drying cupboard, through which a current of warm air is made to pass. It should be remarked that the warmth is only necessary to enable the air to take up the moisture from the plates. They ought to dry in about twelve hours, and they are ready for use.

Exposure.—With a good emulsion and on a bright day the exposure of a plate to a landscape, with a lens whose aperture is one-sixteenth that of the focal distance, should not be more than one-half to one-fifth of a second. This time depends, of course, on the nature of the view; if there be foliage in the immediate foreground it will be longer. In the portrait-studio, under the same circumstances, an exposure with a portrait lens may be from half a second to four or five seconds.

Development of the Plate.—To develop the image either a ferrous oxalate solution or alkaline pyrogallol acid may be used. No chemical restrainer such as potassium bromide is necessary, since the gelatin itself acts as a physical restrainer. If the alkaline developer be used, the following may be taken as a good standard:—

1.	Pyrogallol	50 gra.
	Citric acid	10 "
2.	Potassium bromide	10 gra.
	Water	1 oz.
3.	Ammonia, 880	1 dr.
	Water	9 "

One dram of each of these is taken and the mixture made up to 2 oz. with water. The plate is placed in a dish and the above poured over it without stoppage, whereupon the image gradually appears and, if the exposure has been properly timed, gains sufficient density for printing purposes. It is fixed in a solution of hyposulphite of soda, as in the other processes already described, and then thoroughly washed for two or three hours to eliminate all the soluble salt. This long washing is necessary on account of the nature of the gelatin.

Intensifying the Negative.—Sometimes it is necessary to intensify the negative, which can be done in a variety of ways with mercury salts. An excellent plan, introduced by Chapman Jones, is to use a saturated solution of mercuric chloride in water. After thorough washing the negative is treated with ferrous oxalate. This process can be repeated till sufficient density is attained. With most other methods with mercury the image is apt to become yellow and to fade; with this apparently it is not.

Varnishing the Negative.—The negative is often protected by receiving first a film of plain collodion and then a coat of shellac or other photographic varnish. This protects the gelatin from moisture and also from becoming stained with the silver nitrate owing to contact with the sensitive paper used in silver printing. Another varnish is a solution of celloidin in amyl acetate. This is an excellent protection against damp.

Printing Processes.

The first printing process may be said to be that of Fox Talbot (see above), which has continued to be generally employed (with the addition of albumen to give a surface to the print—an addition first made, we believe, by Fox Talbot).

Paper for printing is prepared by mixing 150 parts of ammonium chloride with 240 parts of spirits of wine and 2000 parts of water, though the proportions may vary. These ingredients are dissolved, and the whites of fifteen fairly-sized eggs are added and the whole beaten up to a froth. In hot weather it is advisable to add a drop of carbonic acid to prevent decomposition. The albumen is allowed two or three days to settle, when it is filtered through a sponge placed in a funnel, or through two or three thicknesses of fine muslin, and transferred to a flat dish. The paper is cut of convenient size and allowed to float on the solution for about a minute, when it is taken off and dried in a warm room. For dead prints, on which colouring is to take place, plain salted paper is useful. It can be made of the following proportions—90 parts of ammonium chloride, 100 parts of sodium citrate, 10 parts of gelatin, 5000 parts of distilled water. The gelatin is first dissolved in hot water and the remaining components are added. It is next filtered, and the paper allowed to float on it for three minutes, then withdrawn and dried.

Sensitising Bath.—To sensitize the paper it is floated on a 10% solution of silver nitrate for three minutes. It is then hung up and allowed to dry, after which it is ready for use. To print the image the paper is placed in a printing frame over a negative and exposed to light. It is allowed to print till such time as the image appears rather darker than it should finally appear.

Toning and Fixing the Print.—The next operation is to tone and fix the print. In the earlier days this was accomplished by means of a bath of *sel d'or*—a mixture of hyposulphite of soda and gold chloride. This gilded the darkened parts of the print which light had reduced to the semi-metallic state; and on the removal of the chloride by means of hyposulphite an image composed of metallic silver, an organic salt of silver and gold was left behind. There was a suspicion, however, that part of the coloration was due to a combination of sulphur with the silver, not that pure silver sulphide is in any degree fugitive, but the sulphuretted organic salt of silver seems to be liable to change. This gave place to a method of alkaline toning, or rather, we should say, of neutral toning, by employing gold chloride with a salt, such as the carbonate or acetate of soda, chloride of lime, borax, &c. By this means there was no danger of sulphurization during the toning, to which the method by *sel d'or* was prone owing to the decomposition of the hyposulphite. The substances which can be employed in toning seem to be those in which an alkaline base is combined with a weak acid, the latter being readily displaced by a stronger acid, such as nitric acid, which must exist in the paper after printing. This branch of photography owes much to the Rev. T. F. Hardwich, he having carried on extensive researches in connexion with it during 1854 and subsequent years. A. Davanne and A. Girard, a little later, also investigated the matter with fruitful results.

The following may be taken as two typical toning-baths:—

{	Gold chloride	1 part.
	Sodium carbonate	10 parts.
{	Water	5000 "
	(a) Borax	100 "
{	Water	4000 "
	(β) Gold chloride	1 part.
{	Water	4000 parts

In the latter (a) and (β) are mixed in equal parts immediately before use. Each of these is better used only once. A third bath is:—

Gold chloride	2 parts.
Chloride of lime	2 "
Chalk	40 "
Water	8000 "

These are mixed together, the water being warmed. When cool the solution is ready for use. In toning prints there is a distinct difference in the *modus operandi* according to the toning-bath employed. Thus in the first two baths the print must be thoroughly washed in water to remove all free silver nitrate, that salt forming no part in the chemical reactions. On the other hand, where free chlorine is used, the presence of free silver nitrate or some active chlorine absorbent is a necessity. In 1872 Abney showed that with such a toning-bath free silver nitrate might be eliminated, and if the print were immersed in a solution of a salt such as lead nitrate the toning action proceeded rapidly and without causing any fading of the image whilst toning, which was not the case when the free silver nitrate was totally removed and no other chlorine absorbent substituted. This was an important factor, and one which had been overlooked. In the third bath the free silver nitrate should only be partially removed by washing. The print, having been partially washed or thoroughly washed, as the case may be, is immersed in the toning-bath till the image attains a purple or bluish tone, after which it is ready for fixing. The solution used for this purpose is a 20% solution of hyposulphite of soda, to which it is best to add a few drops of ammonia in order to render it alkaline. About ten minutes suffice to effect the conversion of the chloride into hyposulphite of silver, which is soluble in hyposulphite of soda and can be removed by washing. The organic salts of silver seem, however, to form a different salt, which is partially insoluble, but which the ammonia helps to remove. If it is not removed there is a sulphur compound left behind, according to J. Spiller, which by time and exposure becomes yellow.

The use of potassium cyanide for fixing prints is to be avoided, as this reagent attacks the organic coloured oxide which, if removed, would render the print a ghost. The washing of silver prints should be very complete, since it is said that the least trace of hyposulphite left behind renders the fading of the image a mere matter of time. The stability of a print has been supposed to be increased by immersing it, after washing, in a solution of alum. The alum, like any acid body, decomposes the hyposulphite into sulphur and sulphurous acid. If this be the case, it seems probable that the destruction of the hyposulphite by time is not the occasion of fading, but that its hygroscopic character is. This, however, is a moot point. It is usual to wash the prints some hours in running water. We have found that half a dozen changes of water, and between successive changes the application of a sponge to the back of each print separately, are equally or more efficacious. On drying the print assumes a darker tone than it has after leaving the fixing bath.

Different tones can thus be given to a print by different toning-baths; and the gold itself may be deposited in a ruddy form or in a blue form. The former molecular condition gives the red and sepia tones, and the latter the blue and black tones. The degree of minute subdivision of the gold may be conceived when it is

stated that, on a couple of sheets of albuminized paper fully printed, the gold necessary to give a decided tone does not exceed half a grain.

Colloido-chloride Silver Printing Process.—In the history of the emulsion processes we stated that Gaudin attempted to use silver chloride suspended in collodion, but it was not till the year 1864 that any practical use was made of the suggestion so far as silver printing is concerned. In the autumn of that year George Wharton Simpson worked out a method which has been more or less successfully employed. The formula appended is Simpson's:—

1. {	Silver nitrate	60 parts.
	Distilled water	60 "
	Strontium chloride	64 "
2. {	Alcohol	1000 "
	Citric acid	64 "
3. {	Alcohol	1000 "

To every 1000 parts of plain collodion 30 parts of No. 1, previously mixed with 60 parts of alcohol, are added; 60 parts of No. 2 are next mixed with the collodion, and finally 30 parts of No. 3. This forms an emulsion of silver chloride and also contains citric acid and silver nitrate. The defect of this emulsion is that it contains a large proportion of soluble salts, which are apt to crystallize out on drying, more particularly if it be applied to glass plates. The addition of the citric acid and the excess of silver nitrate is the key to the whole process; for, unless some body were present which on exposure to light was capable of forming a highly-coloured organic oxide of silver, no vigour would be obtained in printing. If pure chloride be used, though an apparently strong image would be obtained, yet on fixing only a feeble trace of it would be left, and the print would be worthless. The colloido-chloride emulsion may be applied to glass, or to paper, and the printing carried on in the usual manner. The toning takes place by means of the chloride of lime or by ammonium sulphocyanide and gold, which is practically a return to the *sel d'or* bath. The organic salt formed in this procedure does not seem so prone to be decomposed by keeping as does that formed by albumen, and the washing can be more completely carried out. There are in the market several papers which are colloido-chloride.

Gelatino-citro-chloride Emulsion.—A modified emulsion printing process was introduced by Abney in 1881, which consisted in suspending silver chloride and silver citrate in gelatin, there being no excess of silver present. The formula of producing it is as follows:—

1. {	Sodium chloride	40 parts.
	Potassium citrate	40 "
	Water	500 "
2. {	Silver nitrate	150 "
	Water	500 "
	Gelatin	300 "
3. {	Water	1700 "

Nos. 2 and 3 are mixed together whilst warm, and No. 1 is then gently added, the gelatin solution being kept in brisk agitation. This produces the emulsion of citrate and chloride of silver. The gelatin containing the suspended salts is heated for five minutes at boiling point, when it is allowed to cool and subsequently slightly washed, as in the gelatino-bromide emulsion. It is then ready for application to paper or glass. The prints are of a beautiful colour, and seem to be fairly permanent. They may be readily toned by the borax or by the chloride of lime toning-bath, and are fixed with the hyposulphite solution of the strength before given. Most, if not all, of the gelatin papers now extant are made somewhat after this manner.

Printing with Salts of Uranium.—The sensitiveness of the salts of uranium to light seems to have been discovered by Niepce, and was subsequently applied to photography by J. E. Burnett in England. One of the original formulae consisted of 20 parts of uranic nitrate with 600 parts of water. Paper, which is better if slightly sized previously with gelatin, is floated on this solution. When dry it is exposed beneath a negative, and a very faint image is produced; but it can be developed into a strong one by 6 to 10% solution of silver nitrate to which a trace of acetic acid has been added, or by a 2% solution of gold chloride. In both these cases the silver and gold are deposited in the metallic state. Another developer is a 2% solution of potassium ferrocyanide to which a trace of nitric acid has been added, sufficient to give a red coloration. The development takes place most readily by letting the paper float on these solutions.

Self-toning Papers.—There are several self-toning papers based on the chloride emulsion process. These contain the necessary amount of gold to tone the print. The print is produced in the ordinary way and then immersed in salt and water or in some cases potassium sulphocyanide. The print is finished by immersing in weak hyposulphite of soda.

Printing with Chromates: Carbon Prints.—The first mention of the use of potassium bichromate for printing purposes seems to have been made by Mungo Ponton in May 1839, when he stated that paper, if saturated with this salt and dried, and then exposed to the sun's rays through a drawing, would produce a yellow picture on an orange ground, nothing more being required to fix it than

washing it in water, when a white picture on an orange ground was obtained. In 1840 Edmond Bequerel announced that paper sized with iodide of starch and soaked in potassium bichromate was, on drying, more sensitive than unsized paper. Joseph Dixon of Massachusetts, in the following year, produced copies of bank-notes by using gum arabic with potassium bichromate spread upon a lithographic stone, and, after exposure of the sensitive surface through a bank-note, by washing away the unaltered gum and inking the stone as in ordinary lithography. The same process, with slight modifications, has been used by Simonau and Toovey of Brussels, and produces excellent results. Dixon's method, however, was published in the *Scientific American* for 1854, and consequently, as regards priority, it ranks after Fox Talbot's photo-engraving process (see below), published in 1835. On the 13th of December 1855 Alphonse Poitevin took out a patent in England, in which he vaguely described a method of taking a direct carbon-print by rendering gelatin insoluble through the action of light on potassium bichromate. This idea was taken up by John Pouncey of Dorchester, who perhaps was the first to produce veritable carbon-prints, notwithstanding that Testud de Beaugrand took out a somewhat similar patent to Poitevin's at the end of 1857.

Pouncey published his process on the 1st of January 1859; but, as described by him, it was by no means in a perfect state, half-tones being wanting. The cause of this was first pointed out by Abbé Laborde in 1858, whilst describing a kindred process in a note to the French Photographic Society. He says, "In the sensitive film, however thin it may be, two distinct surfaces must be recognized—an outer, and an inner which is in contact with the paper. The action of light commences on the outer surface; in the washing, therefore, the half-tones lose their hold on the paper and are washed away." J. C. Burnett in 1858 was the first to endeavour to get rid of this defect in carbon printing. In a paper to the Photographic Society of London he says, "There are two essential requisites . . . (2) that in printing the paper should have its unprepared side (and not its prepared side, as in ordinary printing) placed in contact with the negative in the pressure-frame, as it is only by printing in this way that we can expect to be able afterwards to remove by washing the unacted-upon portions of the mixture. In a positive of this sort printed from the front or prepared side the attainment of half-tones by washing away more or less depth of the mixture, according to the depth to which it has been hardened, is prevented by the insoluble parts being on the surface and in consequence protecting the soluble part from the action of the water used in washing; so that either nothing is removed, or by steeping very long till the inner soluble part is sufficiently softened the whole depth comes bodily away, leaving the paper white." This method of exposing through the back of the paper was crude and unsatisfactory, and in 1860 Fargier patented a process in which, after exposure to light of the gelatin film which contained pigment, the surface was coated with collodion, and the print placed in warm water, where it separated from the paper support and could be transferred to glass. Poitevin successfully opposed this patent, for he had used this means of detaching the films in his powder-carbon process, in which ferric chloride and tartaric acid were used. Fargier at any rate gave an impetus to carbon-printing, and J. W. Swan took up the matter, and in 1864 secured a patent. One of the great features in Swan's innovations was the production of what is now known as "carbon-tissue," made by coating paper with a mixture of gelatin, sugar and colouring matter, and rendered sensitive to light by means of potassium or ammonium bichromate. After exposure to light Swan placed the printed carbon-tissue on an india-rubber surface, to which it was made to adhere by pressure. The print was immersed in hot water, the paper backing stripped off, and the soluble gelatin containing colouring matter washed away. The picture could then be retransferred to its final support of paper. In 1869 J. R. Johnson of London took out a patent in which he claimed that carbon-tissue which had been soaked in water for a short period, by its tendency to swell further, would adhere to any waterproof surface such as glass, metal, waxed paper, &c., without any adhesive material being applied. This was a most important improvement. Johnson also applied soap to the gelatin to prevent its excessive brittleness on drying, and made its final support of gelatinized paper, rendered insoluble by chrome alum. In 1874 J. R. Sawyer patented a flexible support for developing on; this was a sized paper coated with gelatin and treated with an ammoniacal solution of shellac in borax, on which wax or resin was rubbed. The advantage of this flexible support is that the dark parts of the picture have no tendency to contract from the lighter parts, which they were apt to do when a metal plate was used, as was the case in Johnson's original process. With this patent, and minor improvements made since, carbon-printing has arrived at its present state of perfection.

According to P. E. Liesegang, the carbon-tissue when prepared on a large scale consists of from 120 to 150 grains of gelatin (a soft kind), 15 grains of soap, 21 grains of sugar and from 4 to 8 grains of dry colouring matter. The last-named may be of various kinds, from lamp-black pigment to soluble colours such as alizarin. The gelatin, sugar and soap are put in water and allowed to stand for an hour, and then melted, the liquid afterwards receiving the

colours, which have been ground on a slab. The mixture is filtered through fine muslin. In making the tissue in large quantities the two ends of a piece of roll-paper are pasted together and the paper hung on two rollers; one of wood about 5 in. in diameter is fixed near the top of the room and the other over a trough containing the gelatin solution, the paper being brought into contact with the surface of the gelatin by being made to revolve on the rollers. The thickness of the coating is proportional to the rate at which the paper is drawn over the gelatin: the slower the movement, the thicker the coating. The paper is taken off the rollers, cut through, and hung up to dry on wooden laths. If it be required to make the tissue sensitive at once, 120 grains of potassium bichromate should be mixed with the ingredients in the above formula. The carbon-tissue when prepared should be floated on a sensitizing bath consisting of one part of potassium bichromate in 40 parts of water. This is effected by turning up about 1 in. from the end of the sheet of tissue (cut to the proper size), making a roll of it, and letting it unroll along the surface of the sensitizing solution, where it is allowed to remain till the gelatin film feels soft. It is then taken off and hung up to dry in a dark room through which a current of dry warm air is passing. Tissue dries quickly, though not so sensitive as more manageable work than if more slowly dried. As the tissue is coloured, it is not possible to ascertain by inspection whether the printing operation is sufficiently carried out, and in order to ascertain this it is usual to place a piece of ordinary silvered paper in an actinometer, or photometer, alongside the carbon-tissue to ascertain the amount of light that has acted on it. There are several devices for ascertaining this amount, the simplest being an arrangement of a varying number of thicknesses of gold-beater's skin. The value of 1, 2, 3, &c., thicknesses of the skin as a screen to the light is ascertained by experiment. Supposing it is judged that a sheet of tissue under some one negative ought to be exposed to light corresponding to a given number of thicknesses, chloride of silver paper is placed alongside the negative beneath the actinometer and allowed to remain there until it takes a visible tint beneath a number of thicknesses equivalent to the strength of the negative. After the tissue is removed from the printing-frame—supposing a double transfer is to be made—it is placed in a dish of cold water, face downwards, along with a piece of Sawyer's flexible support. When the edges of the tissue begin to curl up, its surface and that of the flexible support are brought together and placed flat. The water is pressed out with an india-rubber squeezer or "squeegee" and the two surfaces adhere. About a couple of minutes later they are placed in warm water of about 90° to 100° F., and the paper of the tissue, loosened by the gelatin solution next it becoming soluble, can be stripped off, leaving the image (reversed as regards right and left) on the flexible support. An application of warm water removes the rest of the soluble gelatin and pigment. When dried the image is transferred to its permanent support. This usually consists of white paper coated with gelatin and made insoluble with chrome alum, though it may be mixed with barium sulphate or other similar pigments. This transfer-paper is made to receive the image by being soaked in hot water till it becomes slimy to the touch; and the surface of the dampened print is brought into contact with the surface of the retransfer-paper, in the same manner as was done with the flexible support and the carbon-tissue. When dry the retransfer-paper bearing the gelatin image can be stripped off the flexible support, which may be used again as a temporary support for other pictures. If a reversed negative be used the image may be transferred at once to its final support instead of to the temporary flexible support, which is a point of practical value, since single-transfer are better than double-transfer prints.

Printing with Salts of Iron.—Sir John Herschel and Robert Hunt entered into various methods of printing with salts of iron. At the present time two or three are practised, being used in draughtsmen's offices for copying tracings (see SUN-COPYING).

Photo-mechanical Printing Processes.—Pestevia claimed to have discovered that a film of gelatin impregnated with potassium bichromate, after being acted upon by light and damping, would receive greasy ink on those parts which had been affected by light. But Paul Orclot seems to have made the discovery previous to 1854, for in his patent of that year he states that his designs were inked with printing ink before being transferred to stone or zinc. C. M. Tessie de Motay (in 1865) and C. R. Marechal of Metz, however, seem to have been the first to produce half-tones from gelatin films by means of greasy ink. Their general procedure consisted in coating metallic plates with gelatin impregnated with potassium or ammonium bichromate or tri-chromate and mercuric chloride, then treating with silver oleate, exposing to light through a negative, washing, inking with a lithographic roller, and printing from the plates as for an ordinary lithograph. The half-tints by this process were very good, and illustrations executed by it are to be found in several existing works. The method of producing the plates, however, was most laborious, and it was simplified by A. Albert of Munich. He had been experimenting for many years, endeavouring to make the gelatin films more durable than those of Tessie de Motay. He added gum-resins, alum, tannin and other such matters, which had the property of hardening gelatin; but the difficulty of adding sufficient to the mass in its liquid state before

the whole became coagulated rendered these unmanageable. It at last occurred to him that if the hardening action of light were utilized by exposing the surface next the plate to light after or before exposing the front surface to the film and the image, the necessary hardness might be given to the gelatin without adding any chemical hardeners to it. In Tessie de Motay's process the hardening was almost absent, and the plates were consequently not durable. It is evident that to effect this one of two things had to be done: either the metallic plate used by Tessie de Motay must be abandoned, or else the film must be stripped off the plate and exposed in that manner. Albert adopted the transparent plate, and his success was assured, since instead of less than a hundred impressions being pulled from one plate he was able to take over a thousand. This occurred about 1867, but the formula was not published for two or three years afterwards, when it was divulged by Ohm and Grossman, one of whom had been employed by Albert of Munich, and had endeavoured to introduce a process which resembled Albert's earlier efforts. The name of "Lichtdruck" was given about this time to these surface-printing processes, and Albert may be considered, if not the inventor, at all events the perfecter of the method. Another modification of "Lichtdruck" was patented in England by Ernest Edwards under the name of "heliotype."

Woodbury Type.—This process was invented by W. Woodbury about the year 1864, though we believe that J. W. Swan had been working independently in the same direction about the same time. In October 1864 a description of the invention was given in the *Photographic News*. Marc Antoine A. Gaudin claimed the principle of the process, insisting that it was old, and basing his pretensions on the fact that he had printed with translucent ink from intaglio blocks engraved by hand; but at the same time he remarked that the application of the principle might lead to important results. It was just these results which Woodbury obtained, and for which he was entitled to the fullest credit. Woodbury subsequently introduced certain modifications, the outcome being what is known as the "stannotype process," of which in 1880 he read a description before the French Photographic Society (see PROCESS).

Photo-lithography.—Reference has been made to the effect of light on gelatin impregnated with potassium bichromate, whereby the gelatin becomes insoluble, and also incapable of absorbing water where the action of the light has had full play. It is this last phenomenon which occupies such an important place in photolithography. In the spring of 1859 E. J. Asser of Amsterdam produced photographs on a paper basis in printer's ink. Being anxious to produce copies of such prints mechanically, he conceived the idea of transferring the greasy ink impression to stone, and multiplying the impressions by mechanical lithography. Following very closely upon Asser, J. W. Osborne of Melbourne made a similar application; his process is described by himself in the *Photographic Journal* for April 1860 as follows: "A negative is produced in the usual way, bearing to the original the desired ratio. . . . A positive is printed from this negative upon a sheet of (gelatinized) paper, so prepared that the image can be transferred to stone, it having been previously covered with greasy printer's ink. The impression is developed by washing away the soluble matter with hot water, which leaves the ink on the lines of print of the map or engraving." The process of transferring is accomplished in the ordinary way. Early in 1860 Colonel Sir H. James, R.E., F.R.S., brought forward the Southampton method of photo-lithography, which had been carefully worked out by Captain de Courcy Scott, R.E. The "papyrotype process" was published by Abney in 1870 (see LITHOGRAPHY and PROCESS).

Photographs in Natural Colours.

The first notice on record of coloured light impressing its own colours on a sensitive surface is in the passage already quoted from the *Farbenlehre* of Goethe, where T. J. Seebeck of Jena (1810) describes the impression he obtained on paper impregnated with moist silver chloride. In 1839 Sir J. Herschel (*Athenaeum*, No. 621) gave a somewhat similar description. In 1848 Edmond Becquerel succeeded in reproducing upon a daguerreotype plate not only the colours of the spectrum but also, up to a certain point, the colours of drawings and objects. His method of proceeding was to give the silver plate a thin coating of silver chloride by immersing it in ferric or cupric chlorides. It may also be immersed in chlorine water till it takes a feeble rose tint. Becquerel preferred to chlorinize the plate by immersion in a solution of hydrochloric acid in water, attaching it to the positive pole of a voltaic couple, whilst the other pole he attached to a platinum plate also immersed in the acid solution. After a minute's subjection to the current the plate took successively a grey, a yellow, a violet and a blue tint, which order was again repeated. When the violet tint appeared for the second time the plate was withdrawn and washed and dried over a spirit-lamp. In this state it

produced the spectrum colours, but it was found better to heat the plate till it assumed a rose tint. At a later date Niepce de St Victor chlorinized by chloride of lime, and made the surface more sensitive by applying a solution of lead chloride in dextrin. G. W. Simpson also obtained coloured images on silver chloride emulsion in collodion, but they were less vivid and satisfactory than those obtained on daguerreotype plates. Poitevin obtained coloured images on ordinary silver chloride paper by preparing it in the usual manner and washing it and exposing it to light. It was afterwards treated with a solution of potassium bichromate and cupric sulphate, and dried in darkness. Sheets so prepared gave coloured images from coloured pictures, which he stated could be fixed by sulphuric acid (*Comptes rendus*, 1868, 61, p. 11). In the *Bulletin de la Société Française* (1874) Colonel St Florent described experiments which he made with the same object. He immersed ordinary or albuminized paper in silver nitrate and afterwards plunged it into a solution of uranium nitrate and zinc chloride acidulated with hydrochloric acid; it was then exposed to light till it took a violet, blue or lavender tint. Before exposure the paper was floated on a solution of mercuric nitrate, its surface dried, and exposed to a coloured image.

It is supposed—though it is very doubtful if it be so—that the nature of the chloride used to obtain the silver chloride has a great effect on the colours impressed; and Niepce in 1857 made some observations on the relationship which seemed to exist between the coloured flames produced by the metal and the colour impressed on a plate prepared with a chloride of such a metal. In 1880 Abney showed that the production of colour really resulted from the oxidation of the chloride that was coloured by light. Plates immersed in a solution of hydrogen peroxide took the colours of the spectrum much more rapidly than when not immersed, and the size of the molecules seemed to regulate the colour. He further stated that the whole of the spectrum colours might be derived from a mixture of two or at most three sizes of molecules.

In 1841, Robert Hunt published some results of colour-photography by means of silver fluoride. A paper was washed with silver nitrate and with sodium fluoride, and afterwards exposed to the spectrum. The action of the spectrum commenced at the centre of the yellow ray and rapidly proceeded upwards, arriving at its maximum in the blue ray. As far as the indigo the action was uniform, whilst in the violet the paper took a brown tint. When it was previously exposed, however, a yellow space was occupied where the yellow rays had acted, a green band where the green had acted, whilst in the blue and indigo it took an intense blue, and over the violet there was a ruddy brown. In reference to these coloured images on paper it must not be forgotten that pure salts of silver are not being dealt with as a rule. An organic salt of silver is usually mixed with silver chloride paper, the organic salt being due to the sizing of the paper, which towards the red end of the spectrum is usually more sensitive than the chloride. If a piece of ordinary silver chloride paper is exposed to the spectrum till an impression is made, it will usually be found that the blue colour of the darkened chloride is mixed with that due to the coloration of the darkened organic compound of silver in the violet region, whereas in the blue and green this organic compound is alone affected, and is of a different colour from that of the darkened mixed chloride and organic compound. This naturally gives an impression that the different rays yield different tints, whereas this result is simply owing to the different range of sensitiveness of the bodies. In the case of the silver chlorinized plate and of true colloid-chloride, in which no organic salt has been dissolved, we have a true coloration by the spectrum. At present there is no means of permanently fixing the coloured images which have been obtained, the effect of light being to destroy them. If protected from oxygen they last longer than if they have free access to it, as is the case when the surface is exposed to the air.

A method devised by Gabrielle Lippmann, of Paris, by which the natural colours of objects are reproduced by means of interference, may be briefly described as follows: A sensitive plate is placed in contact with a film of mercury, and the exposure to the spectrum, or to the image of coloured objects to be photographed, is made through the back of the plate. On development, the image appears coloured when viewed at one particular angle, the colours being approximately those of the object. The necessary exposure to produce this result was very prolonged in the first experiments in which the spectrum was photographed, and a longer exposure had to be given to the red than was required for the blue. Lippmann at first employed collodion dry plates, prepared, it is believed, with albumen, and it required considerable manipulation to bring out the colours correctly. A. Lumière used gelatin plates dyed with

appropriate dyes (orthochromatic plates); the exposure was much diminished, and very excellent representations were produced of all natural colours. The main point to aim at in the preparation of the plate seems to be to obtain a very sensitive film without any, or, at all events, with the least possible, "grain" in the sensitive salt. A formula published by Lumière seems to attain this object. Viewed directly, the developed images appear like ordinary negatives, but when held at an angle to the light the colours are vivid. They are not pure monochromatic colours, but have very much the quality of colours obtained by polarized light. It appears that they are produced by what may be termed "nodes" of different-coloured lights acting within the film. Thus in photographing the spectrum, rays penetrate to the reflecting mercury and are reflected back from it, and these, with the incident waves of light, form nodes where no motion exists, in a somewhat similar way to those obtained in a cord stretched between two points when plucked. In the negative these nodal points are found in the thickness of the silver deposit. When white light is sent through the film after the image has been developed, theoretically only rays of the wavelengths which formed these nodes are reflected to the eye, and thus we get an impression of colour.

Action of Light on Chemical Compounds.

Reference has been made above to early investigations on the chemical action of light. In 1777 Karl Wilhelm Scheele (*Hunt's Researches in Light*) made the following experiments on silver salts:—

"I precipitated a solution of silver by sal-ammoniac; then I dulcorated it and dried the precipitate and exposed it to the beams of the sun for two weeks; after which I stirred the powder, and repeated the same several times. Hereupon I poured some caustic spirit of sal-ammoniac (strong ammonia) on this, in all appearance, black powder, and set it by for digestion. This menstruum dissolved a quantity of *luna cornua* (horn silver), though some black powder remained undissolved. The powder having been washed was, for the greater part, dissolved by a pure acid of nitre (nitric acid), which, by the operation, acquired volatility. This solution I precipitated again by means of sal-ammoniac into horn silver. Hence it follows that the blackness which the *luna cornua* acquires from the sun's light, and likewise the solution of silver poured on chalk, is silver by reduction. . . . I mixed so much of distilled water with well-dulcorated horn silver as would just cover this powder. The half of this mixture I poured into a white crystal phial, exposed it to the beams of the sun, and shook it several times each day; the other half I set in a dark place. After having exposed the one mixture during the space of two weeks, I filtrated the water standing over the horn silver, grown already black; I let some of this water fall by drops in a solution of silver, which was immediately precipitated into horn silver."

This, as far as we know, is the first intimation of the reducing action of light. From this it is evident that Scheele had found that the silver chloride was decomposed by the action of light liberating some form of chlorine. Others have repeated these experiments and found that chlorine is really liberated from the chloride; but it is necessary that some body should be present which would absorb the chlorine, or, at all events, that the chlorine should be free to escape. A tube of dried silver chloride, sealed up *in vacuo*, will not discolour in the light, but keeps its ordinary white colour. A pretty experiment is to seal up *in vacuo*, at one end of a bent tube, perfectly dry chloride, and at the other a drop of mercury. The mercury vapour volatilizes to a certain extent and fills the tube. When exposed to light chlorine is liberated from the chloride, and calomel forms on the sides of the tube. In this case the chloride darkens. Again, dried chloride sealed up in dry hydrogen discolours, owing to the combination of the chlorine with the hydrogen. Poitevin and H. W. Vogel first enunciated the law that for the reduction by light of the haloid salts of silver halogen absorbents were necessary, and it was by following out this law that the present rapidity in obtaining camera images has been rendered possible. To put it briefly, then, the *visible* action of light is a reducing action, which is aided by or entirely due to the fact that other bodies are present which will absorb the halogens.

In the above we have alluded to the *visible* results on silver salts. It by no means follows that the exposure of a silver salt to light for such a brief period as to leave no visible effect must be due to the same effect, that is, that any of the molecules are absolutely reduced or split up by the light. That this or some other action takes place is shown by the fact that the silver salt is capable of alkaline development, that is, the particles

which have suffered a change in their molecules can be reduced to metallic silver, whilst those which have not been acted upon remain unaltered by the same chemical agency. Two theories have been offered to explain the invisible change which takes place in the salts of silver. One is based on the supposition that the molecules of the salt can rearrange their atoms under the vibrations caused by the ether waves placing them in more unstable positions than they were in before the impact of light took place. This, it is presumed, would allow the developer to separate the atoms of such shaken molecules when it came in contact with them. The other theory is that, as in the case of the visible effects of light, some of the molecules are at once reduced and that the developer finishes the disintegration which the light has begun. In the case of the alkaline development the unaltered molecules next those primarily reduced combine with the reduced silver atom and again form an unstable compound and are in their turn reduced.

The first theory would require some such action as that just mentioned to take place and cause the invisible image formed by the shaking apart of the light-stricken molecules to become visible. It is hard to see why other unacted upon molecules close to those which were made unstable and which have been shaken apart by the developer should themselves be placed in unstable equilibrium and amenable to reduction. In the second theory, called the "chemical theory," the reduction is perfectly easy to understand. Abney adopts the chemical theory as the balance of unsubstantiated evidence is in its favour. There is another action which seems to occur almost simultaneously when exposure takes place in the absence of an active halogen absorbent, as is the case when the exposure is given in the air, that is, an oxidizing action occurs. The molecules of the altered haloid salts take up oxygen and form oxides. If a sensitive salt be briefly exposed to light and then treated with an oxidizing substance, such as potassium bichromate, potassium permanganate, hydrogen peroxide, ozone, an image is not developed, but remains unaltered, showing that a change has been effected in the compound which under ordinary circumstances is developable. If such an oxidized salt be treated very cautiously with nascent hydrogen, the oxygen is withdrawn and the image is again capable of development.

Spectrum Effects on Silver Compounds.—The next inquiry is as to the effect of the spectrum on the different silver compounds. We have already described Seebeck's (1810) experiments on silver chloride with the spectrum whereby he obtained coloured photographs, but Scheele in 1777 allowed a spectrum to fall on the same material, and found that it blackened much more readily in the violet rays than in any other. Senecber's experiments have been already quoted. We merely mention these

have become the foundation of nearly all subsequent researches of the same kind. The effects of the spectrum have been studied by various experimenters since that time, amongst whom we may mention Edmond Becquerel, John William Draper, Alphonse Louis Pottévin, H. W. Vogel, Victor Schumann and W. de W. Abney. Fig. 1 is compiled from a cut which appeared in the *Proc. Roy. Soc.* for 1882, and shows the researches made by Abney as regards the action of the spectrum on the three principal haloid salts of silver. No. 7 shows the effect of the spectrum on a peculiar modification of silver bromide made by Abney, which is seen to be sensitive to the infra-red rays.

Effect of Dyes on Sensitive Films.—In 1874 Dr H. W. Vogel of Berlin found that when films were stained with certain dyes and exposed to the spectrum an increased action on development was shown in those parts of the spectrum which the dye absorbed. The dyes which produced this action he called "optical sensitizers," whilst preservatives which absorbed the halogen liberated by light he called "chemical sensitizers." A dye might, according to him, be an optical and a chemical sensitizer. He further claimed that, if a film were prepared in which the haloid soluble salt was in excess and then dyed, no action took place unless some "chemical sensitizer" were present. The term "optical sensitizer" seems a misnomer, since it is meant to imply that it renders the salts of silver sensitive to those regions of the spectrum to which they were previously insensitive, merely by the addition of the dye. The idea of the action of dyes was at first combated, but it was soon recognized that such an action did really exist. Abney showed in 1875 that certain dyes combined with silver and formed true coloured organic salts of silver which were sensitive to light; and Dr Robert Amory went so far as to take a spectrum on a combination of silver with eosin, which was one of the dyes experimented upon by J. Waterhouse, who had closely followed Dr Vogel, and proved that the spectrum acted simply on those parts which were absorbed by the compound. Abney further demonstrated that, in many cases at all events, the dyes were themselves reduced by light, thus acting as nuclei on which the silver could be deposited. He further showed that even when the haloid soluble salt was in excess the same character of spectrum was produced as when the silver nitrate was in excess, though the exposure had to be prolonged. This action he concluded was due to the dye.

Correct Rendering of Colours in Monochrome.—In Plate IV., fig. 14 the sensitiveness of a plate stained with homocol is shown, and it is evident that as it is sensitive throughout the visible spectrum there must be some means of cutting off by a transparent screen so much of the spectrum luminosity at different parts that every colour having the same luminosity to the eye shall be shown on a negative of equal density. When this is done the relative luminosities of all colours will be shown by the same relative densities or in a print by different depths of greys. Abney devised a sensitometer which should be used to ascertain the colour of the screen that should be employed. By proper means the luminosity of the light of day coming through a red, a green, a blue and an orange glass can be very accurately measured; if $\frac{1}{4}$ -in. squares of these coloured glasses, together with a white glass of the same area, be placed in a row and cemented on white glass, we have a colour-screen which we can make available for finding the kind of light-filter to be employed. This is readily done by reducing the luminosity of the light coming through all the glasses to that of the luminosity of the light coming through the blue glass. If the luminosity of the blue be γ and that of the white light ρ ; then the luminosity of the former must be reduced to $\frac{\gamma}{\rho}$ of its original value, and so with the other glasses. The luminosity of the light coming through each small glass square can be made equal by rotating in front of them a disk in which apertures are cut corresponding to the reduction required. The

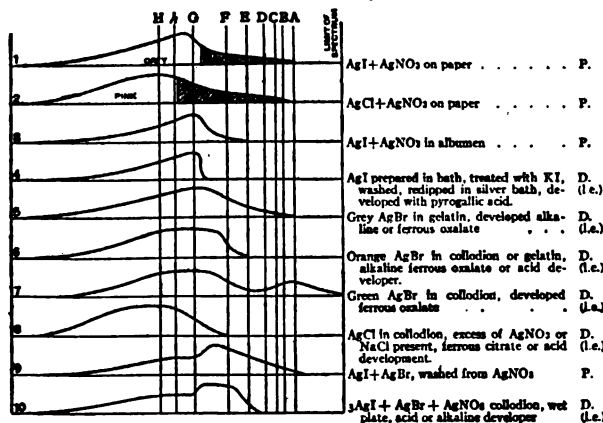

FIG. 1.—Spectrum Effects on Salts of Silver.
[P. = print; D. = developed; l.e. = long exposure].

two for their historical interest, and pass on to the study of the action of the spectrum on different compounds by Sir J. Herschel (*Phil. Trans.*, 1840). He describes many experiments, which

¹See Abney, "Destruction of the Photographic Image," *Phil. Mag.* (1878), vol. v.; also *Proc. Roy. Soc.* (1878), vol. xxvii.



"Carrolling." By H. P. Robinson.



Portrait. By David Octavius Hill, R.S.A.



Portrait Study. By James Craig Annan.



Landscape. By A. Horsley Hinton. (The right-hand printing is from the same negative, but with the action of the light controlled.)

PHOTOGRAPHY



Continuous Spectrum taken with the Electric Arc.



Fluorescent Spectrum of Eosin.



Spectrum of Volatilized Lithium and Sodium.

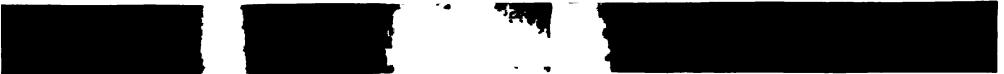

Absorption Spectrum of Eosin.



Graduation Scale on Homocol Stained "Seed" Plate.



Graduation Scale on Unstained Plate.



Impressed Continuous Spectrum.



Spectrum of Bright Lines of Metals.

blue glass, for instance, would not be covered by the disk at all, while opposite the white square the disk would have an aperture of an angle of 18°. When a plate is exposed behind the row of glass squares, with the light passing through the rotating disk, having the appropriate apertures for each glass, the negative obtained would under ordinary conditions, show square patches of very different opacity. A light-filter of some transparent colour, if placed in the path of the light, will alter the opacities, and eventually one can be found which will only allow such coloured light to be transmitted as will cause all the opacities in the negative to be the same. As the luminosities of the white light passing through the glasses are made equal, and as the photographic deposits are also rendered equal, this light-filter, if used in front of the camera lens, will render all coloured objects in correct monochrome luminosity. Another plan, based on the same principles, is to place segments of annuluses of vermilion, chrome yellow, emerald green, French blue and white on a disk, and to complete the annuluses with black segments, the amount of black depending on the luminosity of the pigments, which can be readily measured. When the disk is rotated, rings of colour, modified in brightness by black, are seen, and each ring will be of the same luminosity. As before, a screen (light-filter) to be used in front of the lens must be found which will cause the developed images of all the rings to appear of equal opacity. It must be remembered that the light in which the object is to be photographed must be the same as that in which the luminosity of the glasses or pigments is measured.

Action of the Spectrum on Chromic Salts.—The salts most usually employed in photography are the bichromates of the alkalis. The result of spectrum action is confined to its own most-refrangible end, commencing in the ultra-violet and reaching as far as in the solar spectrum. Fig. 2 shows the relative action of



FIG. 2.—The top letters have reference to the Fraunhofer lines; the bottom letters are the initials of the colours. The relative sensitiveness is shown by the height of the curve above the base-line. The various parts of the spectrum on potassium bichromate. If other bichromates are employed, the action will be found to be tolerably well represented by the figures. No. 1 is the effect of a long exposure, No. 2 of a shorter one. It should be noticed that the solution of potassium bichromate absorbs those rays alone which are effective in altering the bichromate. This change is only possible in the presence of organic matter of some kind, such as gelatin or albumen.

Action of the Spectrum on Asphaltum.—This seems to be continued into and below the red, the blue rays, however, are the most effective. The action of light on this body is to render it less soluble in its usual solvents.

Action of the Spectrum on Salts of Iron.—The commonest ferric salt in use is the oxalate, by which the beautiful platinotype prints are produced. We give this as a representation (fig. 3) of

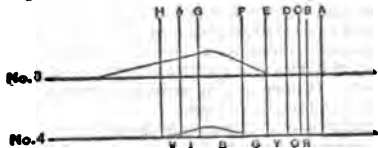

FIG. 3.—Same description as for fig. 2.

the spectra obtained on ferric salts in general. Here, again, we have an example of the law that exists as to the correlation between absorption and chemical action. One of the most remarkable compounds of iron is that experimented upon by Sir J. Herschel and later by Lord Rayleigh, viz. ferrocyanide of

potassium and ferric chloride. If these two be brushed over paper, and the paper be then exposed to a bright solar spectrum, action is exhibited into the infra-red region. This is one of the few instances in which these light-waves of low refrangibility are capable of producing any effect. The colour of this solution is a muddy green, and analysis shows that it cuts off these rays as well as generally absorbs those of higher refrangibility.

Action of Light on Uranium.—The salts of uranium are affected by light in the presence of organic matter, and they too are only acted upon by those rays which they absorb. Thus nitrate of uranium, which shows, too, absorption-bands in the green blue, is affected more where these occur than in any other portion of the spectrum.

Some salts of mercury, gold, copper, lead, manganese, molybdenum, platinum, vanadium, are affected by light, but in a less degree than those which we have discussed. In the organic world there are very few substances which do not change by the continuous action of light, and it will be found that as a rule they are affected by the blue end of the spectrum rather than by the red end (see PHOTOCHEMISTRY).

The following table gives the names of the observers of the action of light on different substances, with the date of publication of the several observations. It is nearly identical with one given by Dr Eder in his *Geschichte der Photo-Chemie*.

Substance.	Observer.	Date.
<i>Silver.</i>		
Nitrate solution mixed with chalk, gives in sunshine copies of writing	J. H. Schulze . . .	1727
Nitrate solution on paper	Hellot . . .	1737
Nitrate photographically used . . .	Wedgwood and Davy . . .	1802
Nitrate on silk	Fulham . . .	1797
Nitrate with white of egg . . .	Rumford . . .	1798
Nitrate with lead salts . . .	B. Fischer . . .	1812
Chloride	Herschel . . .	1839
Chloride in the spectrum . . .	J. B. Beccarius . . .	1757
Chloride photographically used . . .	Scheele . . .	1777
Chloride blackened	Wedgwood . . .	1802
Iodide by action of iodine (on metallic silver)	Lassaigne . . .	1839
Iodide photographically used . . .	Davy . . .	1814
Iodide with gallic acid	Daguerre . . .	1839
Iodide with ferrous sulphate . . .	Herschel . . .	1840
Chloride and iodide by chlorine and iodine (on metallic silver) . . .	Talbot . . .	1841
Bromide	Hunt . . .	1844
Bromide by action of bromine (on metallic silver)	Claudet . . .	1840
Sulpho-cyanide	Balard . . .	1826
Nitrite	Goddard . . .	1840
Oxide with ammonia	Grotthus . . .	1818
Sulphate	Hess . . .	1828
Chromate	Mitscherlich . . .	1827
Carbonate	Bergmann . . .	1779
Oxalate	Vauquelin . . .	1798
Benzoate	Buchholz . . .	1800
Citrate	Bergmann . . .	1779
Kinate	Trommsdorf . . .	1793
Borate	Vauquelin . . .	1798
Pyrophosphate	Henry and Plisson . . .	1829
Lactate	Rose . . .	1830
Formiates	Stromeyer . . .	1830
Fulminates	Pelouze and Gay-Lussac . . .	1833
Sulphide by vapour of sulphur (on metallic silver)	Hunt . . .	1844
Phosphide by vapour of phosphorus (on metallic silver)	Hunt . . .	1844
<i>Gold.</i>		
Oxide	Niepce . . .	1820
Chloride on paper	Hunt . . .	1844
Chloride on silk	Scheele . . .	1777
Chloride in ethereal solution . . .	Hellot . . .	1737
Chloride with ferrocyanide and ferricyanide of potassium . . .	Fulham . . .	1794
Chloride and oxalic acid	Rumford . . .	1793
Chromate	Hunt . . .	1844
Plate of gold and iodine vapour . . .	Dobereiner . . .	1831
	Hunt . . .	1844
	Goddard . . .	1842

Substance.	Observer.	Date.	Substance.	Observer.	Date.
<i>Platinum.</i>			Bismuth salts	Hunt	1844
Chloride in ether	Gehlen	1804	Cadmium salts	Hunt	1844
Chloride with lime	Herschel	1840	Rhodium salts		
Iodide	Herschel	1840	Vanadic salts	Roscoe	1874
Bromide	Hunt	1844	Iridium ammonium chloride	Döbereiner	1831
Cyanide			Mungo Ponton	1838	
Double chloride of platinum and potassium	Döbereiner	1828	Potassium bichromate	Becquerel	1840
<i>Mercury.</i>			Potassium with iodide of starch	Hunt	1843
Oxide (mercurous)	Gay-Lussac and Thénard	1811	Metallic chromates	Gay-Lussac and Thénard	1809
Oxide	Davy	1812	Chlorine and hydrogen	Draper	1842
Oxide (mercuric)	Davy	1797	Chlorine and ether		
Oxide (more accurate observations)	Abildgaard	1797	Chlorine in water	Cahours	1810
Chloride (mercurous)	Harup not till	1801	Chlorine and ethylene	Berthollet	1785
Chloride (mercuric)	K. Neumann previously to	1739	Chlorine and carbon-monoxide	Gay-Lussac and Thénard	1809
Chloride with oxalic acid	Boullay	1803	Chlorine and hydrocyanic acid	Davy	1812
Sulphate	Bergmann	1776	Bromide and hydrogen	Henry	1821
Oxalate (mercuric)	Meyer	1764	Iodine and ethylene	Serullas	1827
Oxalate (mercurous)	Bergmann	1776	Cyanogen, solution of	Balard	1832
Sulphate and ammonia (mercurous)	Harff	1836	Various other methyl compounds	Faraday	1821
Acetate (mercurous)	Fourcroy	1791		Hydrocyanic acid	Pelouze and Richardson
Bromide (mercuric)	Garot	1826	Hypochlorites (calcium and potassium)		Cahours
Iodide (mercurous)	Löwig	1828	Uranium chloride and ether	Torosewicz	1836
Iodide (mercuric)	Torosewicz	1836	Molybdenate of potassium and tin salts	Döbereiner	1813
Citrate (mercuric)	Artus	1836	Crystallization of salts under influence of light	Gehlen	1804
Tartrate and potassium (mercurous)	Field	1836		Phosphorus (in hydrogen, nitrogen, &c.)	Jäger
Carbonate (mercuric)	Harff	1836	Phosphuretted hydrogen		Petit
Nitrate	Carbonell and Bravo	1831	Nitric acid	Chaptal	1788
Sulphide (mercuric)	Davy	1812	Hog's fat	Dize	1789
Sulphate (ferrous)	Herschel	1840	Asphalt	Bockmann	1800
			Sulphide (mercuric)	Vitruvius	1 B.C.
Chloride (ferric) and alcohol	Chastaing	1877	Resins (mastic, sandarac, gamboge, ammoniacum, &c.)	A. Vogel	1812
Chloride and ether	Bestuscheff	1725	Guaiaicum	Scheele	1777
Oxalate (ferric)	Klaproth	1782	Bitumens all decomposed, all residues of essential oils	Vogel	1806
Ferrocyanide of potassium	Döbereiner	1831	Coloured extracts from flowers	Fier	1832
Sulphocyanide	Heinrich	1808	Similar colouring matters spread upon paper	Niepce	1814
Prussian blue	Grotthus	1818	Yellow wax bleached	Senebier	1782
Ferric citrate with ammonium	Scopoli	1783	Eudoxia macrebolittisa (purple dye)	Herschel	1842
Ferric tartrate	Herschel	1840	Other purple dyes	Cole	1684
Chromate	Herschel	1840	Oils generally	Réaumur	1711
<i>Copper.</i>			Nitric ether	Senebier	1782
Chloride (cupric dissolved in ether)	Gehlen	1804	Nicotine	Henry & Boutron-Charlard	1836
Oxalate with sodium	A. Vogel	1813	Santonine	Merk	1883
Chromate	Hunt	1844	<i>Effect of Hydrogen Peroxide on Sensitive Plates.</i> —Dr W. J. Russell made a series of experiments on the effect of exposure of sensitive plates to the action of vapours and gases for long periods. It has long been known that contact of plates with such substances as wood caused a sensitive surface to show "fog" on development. By a somewhat exhaustive series of experiments, Russell showed that the probable cause of this fog is hydrogen peroxide, since substances which favoured its formation produced the same effect. This is somewhat remarkable, as this same substance will completely destroy the effect that light has had on a sensitive plate; indeed, it affords one way of destroying a light image on a sensitive collodion plate. The experiments of Russell give a warning to store exposed plates for brief periods. It appears that negatives wrapped in paraffin paper are secure from this danger.		
Carbonate			A. Vogel	1859	<i>The Application of Photography to Quantitative Measures.</i> —In order to employ photography for the measurement of light it was necessary that some means should be devised by which the opacity of the deposit produced on the development of a plate could be determined. It is believed that in 1874 the first attempt was made by Sir W. Abney to do this. In the <i>Phil. Mag.</i> he showed how density could be measured by means of an instrument, the diaphanometer, he had devised, in which transparent
Iodide	Kratoch	1841			
Sulphate	Talbot	1841			
<i>Manganese.</i>					
Sulphate	Brandenburg	1815			
Oxalate	Suckow	1832			
Potassium permanganate	Frommberg	1824			
Peroxide and cyanide of potassium	Hunt	1844			
Chloride	Hunt	1844			
<i>Lead.</i>					
Oxide	Davy	1802			
Iodide	Schönbein	1850			
Sulphite	Gay-Lussac	1811			
Peroxide	Hunt	1844			
Red lead and cyanide of potassium	Hunt	1844			
Acetate	Hunt	1844			
<i>Nickel.</i>					
Nitrate	Hunt	1844			
Nitrate with ferro-prussiates					
Iodide					
<i>Tin.</i>					
Purple of cassius	Uncertain				
<i>Various Substances.</i>					
Cobalt salts	Hunt	1844			
Arsenic sulphide (realgar)	Sage	1803			
Antimony sulphide	Suckow	1832			

black wedges were used to make matches between the naked light and the same light after passing through the photographic opacity that had to be measured. In 1887, owing to the perfecting of the rotating sectors, which could be made to increase or diminish the apertures at pleasure during its rotation, the measurement of opacities became easy. The Rumford method of comparing the light through the deposit with the naked beam, using the sectors to equalize the illumination, was adopted, the deposit being placed between the light and the screen, the comparison light being a beam reflected from the same light on to the screen.

Owing to the fact that photographic deposit scatters light more or less, the opacities measured by this plan were slightly greater than was shown when such opacities were to be used for contact printing. The final plan adopted by Abney was to place the part of the plate carrying the deposit to be measured behind a screen

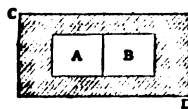

FIG. 4.

rod in the path of this last beam was made to prevent this light falling on A. When a portion of a plate bearing a deposit was placed behind and close to A, the light thrown on B had to be diminished by the sector till the two squares appeared equally bright and the aperture of the sector was noted and compared with that required when the deposit was removed.

With this screen accurate measures of printing densities can be made, and it can also be used in the determination of the comparative photographic brightness of the light issuing from different objects. For instance, the relative brightness of the different parts of the corona as seen in a total eclipse can be readily determined if a "time scale" of gradation is impressed on the plate on which it is taken. Both scale and streamer can then be enlarged optically and thrown on the part of the screen A. The measures of the streamer densities can then be directly compared with the densities of the scale and the relative "photographic" brightness of the different parts of the streamer be ascertained by comparison with this scale also.

The same method of measurement was adopted in ascertaining quantitatively the sensitiveness of the spectrum of ordinary plates and of plates in which dyes are present. The figures on Pl. IV show reproductions of plates which were exposed to the spectrum. No. 1 is a continuous spectrum taken with the electric light; no. 7 is an impressed continuous spectrum; no. 8 shows the bright lines of metals; no. 3 the line spectrum of volatilized lithium and sodium so indicate the position of the spectrum colours. Nos. 4 and 2 are the absorption and fluorescent spectra of eosin. No. 5 is the gradation scale formed by a bromogelatin "Seed" plate stained with homocoll, a cyanine derivative sensitive to the red; no. 6 is a similar scale formed by an unstained plate. The small numbers placed below the different bands show an empiric scale which is made to apply to each of them. The first step is to measure

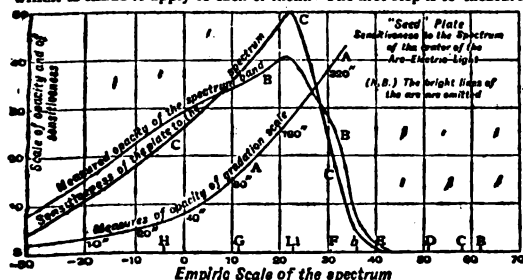

FIG. 5.

the opacity of the gradation scale, next the opacity of the continuous spectrum at the various numbers of the empiric scale, and also the opacity of the other bands at the same scale numbers. The continuous spectrum will give the sensitiveness of the plate to the different parts of the spectrum when the measures of its different opacities are compared with those of the scale of gradation, and a curve of sensitiveness can be plotted from these comparisons. It is evident that the measures of the other two bands will give us information as to the fluorescence and the absorption of the eosin. Fig. 5 shows the curve of opacity of the image of the spectrum at

its different parts, and also the curve of sensitiveness of the plate to the different parts of the spectrum. This last is derived from a comparison of the measured densities with those of the gradation scale.

Measurement of the Rapidity of a Plate.—The first attempt that was made to ascertain the rapidity of a plate was by Abney (*Phil. Mag.* 1874), who demonstrated that within limits the transparency of deposit varied as the logarithm of the exposure.

The last formula has not been accepted for general use, though it is believed that it is not absolutely correct, though very approximately true and sufficiently near to be of practical value. This belief is based on the further researches described below.¹

In 1888 Sir W. Abney pointed out that the speed of a plate could be determined by the formula $T = E \cdot \mu (\log E + C)^2$, where T is the transparency, E is the exposure (or time of exposure \times intensity of light acting), and C a constant. If the abscissae (exposures) are plotted as logarithms, the curve takes the same form as that of the law of error, which has a singular point, a tangent through which lies closely along the curve and cuts the axis of Y at a point which has a value of $2/\sqrt{E}$. If the total transparency be unity, this ordinate has a value of 1.212, the singular point having a value of 0.606. The ordinate of the zero point of the curve will be where the tangent to the singular point cuts the line drawn at 1.212. The difference between the measurements of this zero point for two kinds of plates (i.e. C in the formula) from the points in the abscissae marking the same exposure, will give the relative sensitiveness of the two plates in terms of $\log x^2$. In 1890 Hurter and Driffield (*Journ. Soc. Chem. Ind.* Jan. 19, 1891) worked out a less empirical formula connecting the exposure E with the density of deposit, which in an approximate shape had the form $D = \gamma \log(E/\delta)$, where D is the density of deposit (or $\log 1/T$), δ the "inertia" of the plate, T the transparency of the deposit. In the customary way a small portion of a plate was exposed to a constant light at a fixed distance and for a fixed time, and another small portion to the same light for double the time, and so on. By measuring the densities of the various deposits and constructing a curve, a large part of which was approximately a straight line, it was found possible, by the production of the straight portion to meet the axis of X, to give the relative sensitiveness of different plates by the distance of the intersection from the zero point L. (See also *Exposure Meters*, below, under § 1, APPARATUS.)

Effect of Temperature on Sensitiveness.—In 1876 Abney showed that heat apparently increased, while cold diminished, the sensitiveness of a plate, but the experiments were rather of the qualitative than the quantitative order. In 1893, from fresh experiments,² he found that the effect of a difference in temperature of some 40° C. invariably caused a diminution in sensitiveness of the sensitive salt at the lower temperature, a plate often requiring more than double the exposure at a temperature of about -18° C. than it did when the temperature was increased to +33° C. The general deduction from the experiments was that increase in temperature involved increase in sensitiveness so long as the constituents of the plate (gelatin, &c.) were unaltered. Sir James Dewar stated at the Royal Institution in 1896 that at a temperature of -180° C. certain sensitive films were reduced in sensitiveness to less than a quarter of that which they possess at ordinary temperatures. It appears also, from his subsequent inquiry, that when the same films were subjected to the temperature of liquid hydrogen (-255° C.) the loss in sensitiveness becomes asymptotic as the absolute zero is approached. Presumably, therefore, some degree of sensitiveness would still be preserved even at the absolute zero.

Effect of Small Intensities of Light on a Sensitive Salt.—When a plate is exposed for a certain time to a light of given intensity, it is commonly said to have received so much exposure (E). If the time be altered, and the intensity of the light also, so that the exposure (time \times intensity) is the same, it was usually accepted that the energy expended in doing chemical work in the film was the same. A series of experiments conducted under differing conditions has shown that such is not the case, and that the more intense the light (within certain limits) the greater is the chemical action, as shown on the development of a plate. Fig. 6 illustrates the results obtained in three cases. The exposure E is the same in all cases. The curves are so drawn that the scale of abscissae

¹ Those applicable to the correction of star magnitudes as determined by photography have been verified and confirmed by Schwarzschild, Michalke and others.

² Abney, *Proc. Roy. Soc.* 1893.

³ Abney, *Proc. Roy. Soc.* 1893, and *Journ. Camera Club*, 1893.

is the intensity of the light in powers of -2 , and the ordinates show the percentages of chemical action produced. If the chemical action remained the same when the intensity of light was reduced, E remaining the same, each of the curves would be shown as a straight line at the height of 100, which is the transparency of deposit with the unit of light. As it is, they show diminishing percentages as the light intensity is diminished.

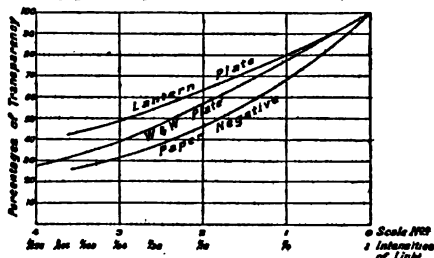

FIG. 6.

Thus, when the intensity of the light is reduced to $\frac{1}{16}$ of the original, and the time of exposure is prolonged 64 times, the useful energy expended on a lantern plate is only 50% of that expended when the light and time of exposure are each unity. In the cases to which the diagram refers, the light used was a standard amyl acetate lamp, and the unit of intensity taken was this light at a distance of 2 ft. from the plate, and the unit of time was 10 seconds. The lamp being moved to 16 ft. from the plate, gave an intensity of $\frac{1}{16}$ the unit, and the time of exposure had to be increased to 640 seconds, so that E was the same in both cases. Further, it was found that when the times of exposure on different parts of the plate were successively doubled, light at a fixed distance being used for one series, and altered for a second series, the slopes of the curves of transparency (i.e. the gradation) were parallel to one another. This investigation is of use when camera images are in question, as the picture is formed by different intensities of light, not very different from those of the amyl acetate lamp, the time of exposure being the same for all intensities. The deductions made from the investigation are that with a slow plate the energy expended in chemical action is smaller as the intensity is diminished, while with a quick plate the variation is much less. As a practical deduction, we may say that to obtain proper contrast in a badly lighted picture it is advisable to use a slow plate.

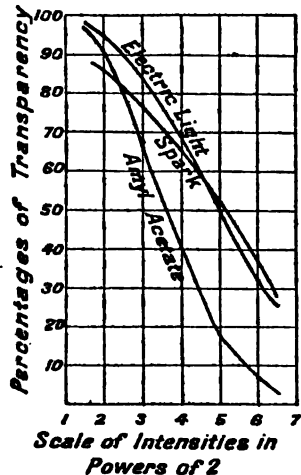

FIG. 7.

Effect of very Intense Light on a Sensitive Salt.—Another investigation was made as to the effect of very intense light on sensitive surfaces. In this case a screen of step-by-step graduated opacities was made use of, and plates exposed through it to the action of lights markedly differing in intensity, one being that of the amyl acetate lamp, another that of the arc light, and a third the light emitted from the spark of a Wimshurst machine. The exposures were so made that one of the opacities produced on the plate from exposure to each source of light was approximately the same. The unit of

intensity of light is, of course, in each case widely different. The slope of the curve due to the spark light is less steep than that due to the arc light, and the latter, again, is much less steep than that due to the amyl acetate lamp. A further investigation was made of the effect of increasing the time of exposure when the intense light was diminished, and it was found that with all plates the useful chemical energy acting on a plate was least with the most intense light, but increased as the intensity diminished, though the time was correspondingly increased. This is the reverse of what we have recorded as taking place when a comparatively feeble light was employed. Further, it was proved that the variation was greatest in those plates which are ordinarily considered to be the most rapid. It follows, therefore, that there is some intensity of light when the useful chemical energy is at a maximum, and that this intensity varies for each kind of plate.

Intermittent Exposure of a Sensitive Salt.—The same investigator has shown that, if a total exposure is made up of intermittent exposures, the chemical action on a sensitive salt is less than it is when the same exposure is not intermittent. It was also proved that the longer the time of rest between the intermittent exposures (within limits) the less was the chemical action. We may quote one case. Exposures were first made to a naked light, and afterwards to the same light for six times longer, as a rotating disk intervened which had 12 apertures of 5° cut in it at equal intervals apart, and 720 intermittent exposures per second were given. The plate was moved to different distances from the light, so that the intensity was altered. The apparent loss of exposure by the intervention of the disk increases as the intensity diminishes, the ratios of the chemical energy usefully employed of the naked light exposure to that of the intermittent exposures being:—

For intensity 1	1 to .815
" " $\frac{1}{2}$	1 " .500
" " $\frac{1}{4}$	1 " .423
" " $\frac{1}{8}$	1 " .370

These results appear to be explicable by the theoretical considerations regarding molecular motion.

Effect of Monochromatic Light of Varying Wave-lengths on a Sensitive Salt.—It has been a subject of investigation as to whether the gradation on a plate is altered when exposures are made to lights of different colours; that is to say, whether the shades of tone in a negative of a white object illuminated by, say, a red light, would be the same as those in the negative if illuminated by a blue light. Abney¹ announced that the gradation was different; and, quite independently, Chapman Jones made a general deduction for isochromatic plates that, except with a certain developer, the gradation was steeper (that is, the curve shown graphically would be steeper) the greater the wave-lengths of the light to which the sensitive salt was subjected. For plates made with the ordinary haloid salts of silver Chapman Jones's deduction requires modification. When monochromatic light from the spectrum is employed, it is found that the gradation increases with wave-lengths of light which are less, and also with those which are greater, than the light whose wave-lengths has a maximum effect on the sensitive salt experimented with. Thus with bromo-iodide of silver the maximum effect produced by the spectrum is close to the blue lithium line, and the gradation of the plate illuminated with that light is less steep than when the light is spectrum violet, green, yellow or red. From the red to the yellow the gradation is much the steepest. Whether these results have any practical bearing on ordinary photographic exposures is not settled, but that they must have some decided effect on the accuracy of three-colour work for the production of pictures in approximately natural colours is undoubted, and they may have a direct influence on the determination of star magnitudes by means of photography.

Reproduction of Coloured Objects by means of Three Photographic Positives.—Ives's Process.—A practical plan of producing images in approximately the true colours of nature has been devised by preparing three positives of the same object, one

¹ Proc. Roy. Soc., 1900.

illuminated by a red, the other by a green, and the third by a blue light; the images from these three transparencies, when visually combined, will show the colours of the object. This plan was scientifically and practically worked out by F. E. Ives of Philadelphia, though in France and elsewhere it had been formulated, especially by Hauron Du Cros.

The following description may be taken as that of Ives's process: by the trichromatic theory of colour-vision every colour in nature can be accounted for by the mixture of two or three of the three-colour sensations, red, green and blue, to which the eye is supposed to respond. Thus a mixture of a red and green sensation produces the sensation of yellow; of a green and blue, that of a blue-green; of red and blue, that of purple, and of all three, that of white. For the sensations we may substitute those colours which most nearly respond to the theoretical sensations without any material loss of purity in the resulting sensation. We must take the spectrum of white light as the only perfect scale of pure colours. It has been proved that the red sensation in the eye is excited by a large part of the visible spectrum, but with varying intensities. If, then, we can on a photographic plate produce a developed image of the spectrum which exactly corresponds in opacity and position to the amount of red stimulation excited in those regions, we shall, on illuminating a transparent positive taken from such a negative with a pure red light, have a representation of the spectrum such as would be seen by an eye which was only endowed with the sensation of red. Similarly, if negatives could be taken to fulfil the like conditions for the green and for the blue sensations, we should obtain positives from them which, when illuminated by pure green and blue light respectively, would show the spectrum as seen by an eye which was only endowed with a green or a blue sensation. Evidently if by some artifice we can throw the coloured images of these three positives on a screen, superposing them one over the other in their proper relative positions, the spectrum will be reproduced, for the overlapping colours, by their variation in intensity, will form the colours intermediate between those used for the illumination of the positives. For the purpose of producing the three suitable negatives of the spectrum, three light-filters, through which the image has to pass before reaching the photographic plate, have to be found. With all present plates these are compromises. Roughly speaking, the screens used for taking the three negatives are an orange, a bluish-green and a blue. These transmit those parts of the spectrum which answer to the three sensations. When these are obtained an image of a coloured object can be reproduced in its true colours.

Abney devised sensitometers for determining the colours of the screens to be placed before the lens in order to secure the three-colour negatives which should answer these requirements. Their production depends upon the same principles indicated as necessary for the correct rendering in monochrome of a coloured object. When the sensitometer takes the form of glasses through which light is transmitted to the plate, the luminosities of the coloured lights transmitted are determined, and also their percentage composition in terms of the red, green, and blue lights, and thence are deduced the luminosities in terms of red, green and blue. For ascertaining what screen should be used to produce the red negative the luminosity transmitted through each glass is so adjusted that the luminosity of the red components in each is made equal by rotating a disk with correct apertures cut out close to the row of glasses. This gives a sensitometer of equal red values. A coloured screen has to be found which, when placed in front of the lens, will cause the opacities of the deposit on the plate, corresponding to each square of glass, to be the same throughout. This is done by trial, the colour being altered till the proper result is obtained. In a similar way the "green" and "blue" screens are determined. Coloured pigments rotating on a disk can also be employed, as indicated in the paragraph on the correct rendering of colour in monochrome.

As to the camera for the amateur, whose plates are not as a rule large, all of the three negatives should be obtained on one plate, since only in this way can they be developed and the densities increased together. (For commercial work the negatives often cannot be taken on the same plate, as it would make the plate too large to manipulate.) The camera may be of an ordinary type, with a repeating back, bringing successively three different portions of the plate opposite the lens. It is convenient to have a slide, in front of which a holder containing the three screens can be fixed, which will then be close to the plate; such a one has been devised by E. Sanger-Shepherd. The light passes through them one by

one as the plate is moved into the three positions. The three exposures are given separately, after which the plate is ready for development. The three separate exposures are, however, a source of trouble at times, particularly in the case of landscapes, for the lighting may vary and the sky may have moving clouds, in which case the pictures would show variations which should not exist. Sanger-Shepherd has a "one-exposure" camera by which the three images are thrown side by side on the plate. Thus any movement in the picture affects all three negatives alike. Abney has also introduced a "one-exposure" camera which takes in a larger angle than that of Sanger-Shepherd. The next point is the exposures which should be given through each screen. This can be done by placing in front of the plate and extending its whole length a scale of gradation through which the light coming from a sun-illuminated white card passes, as well as through the screens. In the case of the three-exposure camera the times of exposure are varied till the densities of the image of the gradation appear the same in each of the three images. In the case of the one-exposure camera, the light reaching the plate through the screens is altered by cutting off with a shutter more or less of the lens used. As the plates employed for the purpose of the three-colour negatives must be sensitive to every colour, the ordinary dark-room light should be most cautiously used. If used at all, it should be very feeble and development must be carried out in a dish with a cover to it. The plate is manipulated in the usual way.

Joly's Process.—Professor J. Joly, of Dublin, in 1897 introduced a colour process by which an image in approximately natural colours could be thrown upon a screen by an optical lantern, only one transparency being employed, instead of three, as in the Ives process. A "taking" screen was ruled with alternating orange, blue-green and blue lines $\frac{1}{16}$ to $\frac{1}{8}$ in. apart, touching one another and following one another in the above order. When such a screen was placed in front of a sensitive plate in the camera, and exposure made to the image of a coloured object, there were practically three negatives on the same plate, each being confined to the area occupied by lines of the same colour. The shades of colour and the depth of the colours used in ruling depended on the brand of plate. When a perfect triline negative was obtained, a transparency was made from it, and in contact with this was placed a screen ruled with lines the same distance apart, but of the colours corresponding to the three colour sensations, namely red, green and blue. The red lines were made to fall on the image taken through the orange lines, the green on that of the blue-green, and the blue or violet on that of the blue. On the screen there are practically three differently coloured images shown by one transparency. The eye blends the different colours together and a picture is seen in approximately the correct colours of the original.

Autochrome.—A very remarkable process, founded on J. Joly's process, was introduced in 1907 by A. Lumière et ses Fils of Lyons. Starch grains of very minute size, some of which were dyed with a red stain, a second portion with a green, and a third portion with a blue, are mixed together in such proportions that a fine layer of them appears grey when viewed by transmitted light. Under a magnifying glass the grains are coloured, but owing to the want of focus in the eye the colours blend one with the other. Such a layer is embedded on the surface of a glass plate in a waterproof vehicle, and a film of sensitive emulsion held *in situ* in some material, the composition of which has not been published, covers this layer. When such a plate is placed in the camera, with the back of the plate next the lens, the light passes through the coloured granules, and again we have three negatives on one plate, but instead of each negative being represented by lines as in the Joly process they are represented by dots of silver deposit. Owing to the way in which the three-coloured film is prepared, it is evident that a positive taken from such a negative could not be backed with granules of the right colour, as the granules are placed at random in the layer. Lumière, to overcome this difficulty, converted the negative into a positive in a very ingenious way. The plate was developed with pyrogallol and ammonia in the usual way, but instead of fixing it, it was plunged into a solution of potassium permanganate and sulphuric acid. This dissolved all the silver that had been deposited during development and left a film of unaltered silver salt. On looking through the plate the colours of the coloured layer coming through the different dots where the silver was at

first deposited appeared in view, and the image was the image in colour of the object photographed. The plate after being washed was taken into the light and redeveloped with an alkaline developer, which converted the sensitive salt of silver to the metallic state. The image now consisted of black particles of silver and the coloured image. The plate was next fixed in hyposulphite of soda to remove any unreduced silver salt that might be left, and the picture after washing was complete. The coloured image so obtained is a very close representation of the true colours, but as the "taking" screen is the same as the "viewing" screen some little variation must result.

Positives in Three Colours.—Ives was the first to show that a transparency displaying approximately all the colours in nature could be produced on the same principles that underlie the three-colour printing. This he effected by printing each of the three negatives, produced for his triple projection process as already described, on gelatine films sensitized by bichromate of potash. Each of the three transparent films was dyed with a colour complementary to the colour of the light which he transmitted through the positives when used for projection. Thus the "red" positive he dyed with a blue-green dye, the "green" positive with a purple dye, and the "blue" positive with a yellow dye. These three films, when superposed, gave the colours of the original object. Sanger-Shepherd has made the process a commercial success (see *Process*) and produces lantern slides of great beauty, in which all colours are correctly rendered. Instead of using a dye for the "red" transparency, he converts the silver image of a positive image into an iron salt resembling Prussian blue in colour. (W. DE W. A.)

II.—PHOTOGRAPHIC APPARATUS

Photographic apparatus consists essentially of the camera with lens and stand, lens shutters, exposure meters, prepared plates for the production of negatives or transparencies, sensitive papers and apparatus for producing positive prints, direct or by enlargement. Besides these there are many subsidiary accessories.

Since the introduction of highly sensitive dry plates and their extended use in hand cameras, the art and practice of photography have been revolutionized. Numerous special forms of apparatus have been created suitable for the requirements of the new photography, and their manufacture and sale have become important industries. The value of the exports of photographic materials from the United Kingdom in 1906 was £22,716. The most important improvement has been in the construction of anastigmatic lenses, which, having great covering power, flatness of field, and freedom from astigmatism, can be worked with very much larger apertures than was possible with the earlier forms of rectilinear or aplanatic lenses. The increased rapidity of working thus gained has rendered it easy to photograph objects in very rapid motion with great perfection. This has encouraged the construction of the very light and compact hand cameras now so universally in use, while, again, their use has been greatly simplified by improvements in the manufacture of sensitive plates and films and the introduction of light, flexible, sensitive films which can be changed freely in daylight. The introduction in 1907 of Messrs Lumière's "Autochrome" process of colour photography has also been a great advance, tending to popularize photographic work by the facility it offers for reproducing objects in the colours of nature.

The Camera.

Historical.—The camera obscura (*q.v.*) was first applied to photographic use by Thomas Wedgwood between 1792 and 1802. No description of his camera is available, but it was probably one of the sketching cameras then in use. In 1812 W. H. Wollaston found that by using a meniscus lens with a concave surface towards the object and the convex towards the screen, a diaphragm being placed in front, the projected image of the camera obscura was greatly improved in sharpness over a larger field. The first photographic lenses made by V. and Ch. L. Chevalier in Paris (1830-1840) were on this principle. The photographic camera in its simplest form is a rectangular box,

one end of which is fitted to carry a lens and the opposite one with a recess for holding the focusing screen and plate holders, these ends being connected by a rigid or expanding base-board and body, constructed to keep out all light from the sensitive plate except that passing through the lens. In 1816 Joseph Nicéphore Niepce, of Chalon-sur-Saône, for his photographic experiments made a little camera, or artificial eye, with a box six inches square fitted with an elongated tube carrying a lens of glass. There are now in the Chalon Museum cameras of his with an iris diaphragm for admitting more or less light to the lens; some with an accordion bellows, others with a double expanding rigid body for adjusting the focus. The iris diaphragm was adopted later by Chevalier for his photographic lenses. In 1835 W. H. Fox Talbot constructed simple box cameras for taking views of his house on sensitive paper, and claimed them as the first photographs of a building (*Phil Mag* 1839, 14, p. 206). Fr. von Kobell and C. A. Steinheil, early in 1839, made a camera with an opera glass lens for taking landscapes on paper. Later in 1839 J. W. Draper successfully used a camera for his daguerreotype experiments made of a spectacle lens, 14 in. focus, fitted into a cigar box. He also used a camera fitted with a concave mirror instead of a lens. Similar cameras were constructed by A. T. Wolcott (1840) and R. Beard (1841) for reversing the image in daguerreotype portraits. They have also been recommended by V. Zenger (1875) and D. Mach (1890) for scientific work.

L. J. M. Daguerre's camera, as made by Chevalier in 1839 for daguerreotype, was of Niepce's rigid double body type, fitted with an achromatic meniscus lens with diaphragm in front on Wollaston's principle, the back part with the plate moving away from the lens for focusing, and fixed in its place with a thumb-screw. This expanding arrangement enabled lenses of different focal lengths to be used. With modifications cameras of this type were in use for many years afterwards for portrait and studio purposes. For work in the field they were found inconvenient, and many more portable forms were brought out, among them G. Knight's and T. Ottewill's single and double folding cameras (1853), made collapsible with hinges, so as to fold on to the base-board. Cameras with light bodies made of waterproof cloth, &c., also came into use, but these were superseded by cameras with collapsible bellows-body of leather, which, invented by Niepce, were used in France, in 1830, by Baron A. P. de Séguier and others for daguerreotype. The first record of them in England is, apparently, J. Atkinson's portable stereoscopic camera of parallel-side bellows form (*Ph Journ* 1857, 3, p. 261), which was soon followed by C. T. H. Kinnear's lighter conical form, made by Bell of Edinburgh (*Ph Journ* 1858, 4, p. 166). They have since been made in various patterns, conical, oblong and square, by P. Meagher, G. Hare and others, and are still, in modified forms, in general use as studio, field or hand cameras. When wet collodion plates were used many cameras were fitted with arrangements for developing in the field.

Information on these and other early cameras will be found in the photographic journals, in C. Fabre's *Traité encyclopédique de photographie*, vol. i., and in J. M. Eder's *Ausführliches Handbuch der Photographie*, 2nd ed., vol. I, pt. ii.

The distinctive feature of present dry photography is the world-wide use of the hand camera. Its convenience, the ease with which it can be carried and worked, and the remarkably low prices at which good, useful cameras of the kind can be supplied, concurrently with improvements in rapid sensitive plates and lenses, have conduced to this result. It has also had a valuable educational influence in quickening artistic perception and scientific inquiry, besides its use in depicting scenes and passing events for historical record. Small portable cameras had been made by B. G. Edwards (1855), T. Scaife (*Pistolgraph*, 1858), A. Bertsch (1860), T. Ottewill (1861), and others, but it was not until rapid gelatin dry plates were available in 1861 that T. Bolas brought out his "detective" camera (*Ph Journ* 1881, p. 50). It consisted of a double camera (one as finder, the other for taking the picture) enclosed in another box, suitably covered, which also contained the double-plate carriers and had apertures

in front of the viewing and taking lenses. In another form the finder was omitted. A month later A. Loiseau and J. B. Germeuil-Bonnaud patented an opera glass camera. Various forms of portable magazine cameras followed, among them A. Pumphrey's "Repeating Camera" (1881), W. Rouch's "Eureka" (1887), R. Krugener's camera (book form, 1888), and others in collapsible or box forms disguised as books, watches, &c., but they did not come into general use before 1888, when the Eastman Company of Rochester, U.S.A., brought out their very portable roll-film cameras, now known under the trade name of "Kodak." The manufacture of these and other light hand cameras has since become a very important and flourishing industry in Great Britain, Germany, France and the United States. It is noteworthy that the most modern form of hand camera, the reflex, goes back to an early type of portable camera obscure, figured by Johann Zahn in 1686, in which a mirror was used for reflecting the image on to a horizontal focusing screen, at the same time reversing it. The first photographic camera on this principle was T. Sutton's (1860), which has served as a basis for many subsequent developments. A. D. Loman's (1889) and R. Krugener's (1891) were early examples of the hand camera type, but great improvements have since been made.

Modern cameras differ so much in details of improved construction that only a few of the more important requirements can be noticed. A camera should be well and strongly made of seasoned wood or of metal, perfectly rigid when set up, to avoid any shifting of the axis of the lens in respect to the sensitive plate. The front and back of the camera should normally be vertical and parallel, and the axis of the lens perpendicular to the centre of the plate, but arrangements are usually made by vertical and lateral adjustments on the camera front for raising the lens to take in less foreground or vice versa, or for moving it right or left, the latter becoming a vertical movement when the camera has to be turned on its side. In the Adams "Idento" camera the lens and finder can be rotated together on the rising front according as the camera is used horizontally or vertically, the finder showing in either case the identical view projected on the plate. The best modern field cameras are fitted with a swing-back or swing-front and sometimes with both. A swing-back is necessary for bringing back the plate to the vertical position, so as to prevent convergence of vertical lines, when the camera has to be tilted. A rising swing-front, in which the lens is tilted, answers the same purpose, provided the camera is kept level. If further tilting is necessary, when taking high buildings &c., the swing-back and front may both be required, but must be kept vertical and parallel and the effect is that of an abnormal rising front. Many modern cameras are fitted with a double rising front. The vertical and side swings are also useful for equalizing the definition of objects at different distances from the camera, but they alter the perspective. These swing-movements should preferably be round the central horizontal or vertical axis of the back or front, but are frequently effected by simple inclination of the back or lens front on a hinge. When the rising front is used a lens of extended covering power is desirable, and it may be necessary to stop it down to obtain good definition over the extended area of the picture. A slight inclination of the lens may also be useful in readjusting the focus. The camera and plate carriers must be perfectly light-tight and all inner bright surfaces made dead black to prevent reflections from bright spots being thrown on the plate. The black varnish used, preferably of shellac and lampblack in spirit, must have no deleterious effect on the plates. Although the weight and bulk are increased it is convenient to have the camera square and fitted with a reversible back, so that the greatest length of the plate may be horizontal or vertical, as desired. Many cameras are fitted with revolving backs to be used in either position. In some French cameras the back part of the camera with the bellows is reversible, to be used upright or horizontal.

Focusing—The earlier cameras were focused by drawing out the back and clamping it with a thumb-screw working in a slot in the base-board. When bellows cameras were introduced they were focused by an endless screw, and these are still used for large copying cameras. Most modern cameras are fitted with rack and pinion movements working either in front or at the back of the camera or both. Many hand cameras, requiring to be brought to focus at once, are fitted with studs (infinity catches) which fix the front in focus for distant objects, nearer distances being noted on an engraved scale attached to the base-board. Such scales should be verified by measurement. In hand cameras with fixed infinity focus, the necessary adjustments for distance of near objects are made on the lens mount. The focusing screen may be ruled with parallel cross lines for purposes of measurement, and as a check on the verticality of the camera when photographing buildings or other objects with vertical lines. The distance of the lens from the focusing screen and from the sensitive plate in the dark slide must coincide exactly. This can be tested by measurement or by focusing a

bright, well-defined object on the screen and then on a ground-glass plate placed in each of the slides to be examined. A level or other means of showing that the camera is level and the plate vertical should be attached to the camera, also a view meter or finder, showing the exact extent of the picture on the focusing glass. In the view meter the picture is viewed directly through a pin-hole mounted at the back of the camera as it appears in a frame with cross wires on the rising front, adjusted to the size of the plate and the focus of the lens. Finders are practically small reflex cameras, and a reduced image is seen reflected from a mirror or prism. A rectangular concave glass mounted on the camera is also a convenient form; it can be combined with a mirror for vertical observation, and in Watson's new form is also arranged as a level and telemeter (*B. J. A.* p. 724, 1908). The image seen in the finders should correspond exactly with that on the plate. When the rising front is used special arrangements have to be made to ensure the correspondence of the images in the finder and on the ground-glass. This is done in the "Adams Inderoscope" (1908), which is fitted to the swing front and adjusted by a lever to follow the movement of the lens.

Plate-holders or Dark-slides.—The dark-slides or backs, holding sensitive plates, are made either single or double, the former usually for wet plates, the latter for dry plates. The ordinary book-form double dark-slide has been in use since the early days of calotype paper negatives, and contains two plates separated by a blackened metal plate; three of them usually form a set, the shutters being numbered 1 to 6, the odd numbers on the opening side. Inner frames can be used for smaller plates if desired. The slides should fit easily into the camera and the shutters run smoothly out and in. They must be perfectly light-tight, the corner joints, the hinges in the shutters, and the openings in the sides and top of the book-form slides are all weak points requiring occasional careful examination or protection by metal plates. The shutters of dark-slides are either jointed or solid and removable; the former is perhaps the more convenient, but both forms may become liable to let in light. Various forms of solid slides, single and double, are now made in wood or metal, or of wood for the frame and metal for the shutters; they are lighter, more compact and less liable to admit light to the plates. In some cases one slide can suffice for the exposure of several plates or stiff films, enclosed in separate envelopes, as in the "Wishart-Mackenzie" slide, the "Victrix" and other similar ones, or contained in a single packet, as in the "Premo Film-pack" and similar arrangements which enable twelve thin celluloid films to be placed in the camera, exposed one after the other, and removed again safely in daylight, the pack being replaced, if necessary, by another. The packets of films are made of light cardboard, and effect a great saving of bulk and weight (fig. 1). Roll-holders are also a convenient way of carrying sensitive celluloid films in lengths of six or twelve exposures, rolled on spools, which can be changed in daylight. Changing boxes for holding a reserve of plates or celluloid films in sheaths, are used with some magazine and other cameras. They are arranged to fit on the camera in place of the dark-slide and the plates are changed automatically so that exposed plates are placed in order successively at the back, a fresh plate going forward for exposure and the number of the exposure being recorded at the same time.

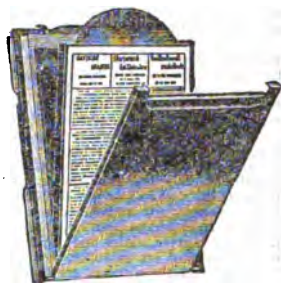

FIG. 1.—Premo Film-pack.

Studio cameras, for portraiture, are usually of the square bellows type, of solid construction, to take large and heavy lenses; adjustable from front and back with rack and pinion movements, to enable long or short focus lenses to be used, with extra extension for copying or enlarging. They are generally fitted with repeating backs, allowing two or more exposures to be made on one plate. The backs are square or reversible, so that the plates can be used upright or lengthways, and are fitted with double swing movements at the back. When single dark slides are used they are best fitted with a flexible shutter to avoid jerking and movement of the camera. For portraiture they are mounted on solid pillar stands, being raised or lowered with an endless screw or rack-work, and the table-top usually has vertical and horizontal angular movements. Large cameras with long extension for copying purposes are made in many forms with special arrangements for the various photo-mechanical processes, and are mounted on substantial table-stands with screw adjustments for obtaining the various motions above noted, and also a rectilinear traversing motion right or left. All these stands should be absolutely rigid and free from tremor. Process cameras are, however, sometimes mounted,

together with the copying board, on swinging stands, to avoid the effects of vibration.

Portable and field cameras include cameras of the Hare and Meagher types for outdoor work and general purposes on plates 15 in. X 12 in. to 8½ in. X 6½ in., and in lighter forms from 6½ in. X 4½ in. to 4½ in. X 3½ in. For general purposes they are usually made with square bellows and folding tail-board, rather more substantially than those with conical bellows intended for outdoor work. There are many patterns, the principal modern improvements in field cameras being swinging fronts, tripod head and turntable in the base-board, double and sometimes triple extension movements from the back and front for long or short focus lenses, and the use of aluminium for some of the metal-work. They are fitted with a focusing screen and are intended for use on a tripod stand, though some of the smaller sizes of the modern light hand or stand cameras can be used as hand cameras with finders. The plates are carried in the usual dark-slides, but the smaller sizes, from half-plate downwards, can be fitted with roll-holders for flexible films, or with film packs or other daylight changing arrangements.

Folding and Hand Cameras.—Folding cameras form a class of modern portable cameras which have many conveniences for hand

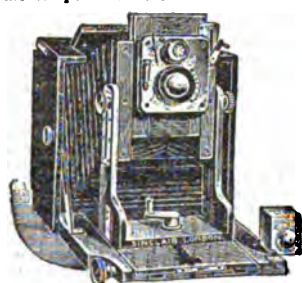

FIG. 2.—Sinclair Folding Camera.

or stand work from quarter-plate to 7 in. X 5 in. They may have all the fittings of a stand camera and be made to take glass plates, flat or roll films, but have the advantage of forming when closed a convenient package enclosing camera, lens and shutter, all in position for immediate use when opened out (fig. 2). Most of them are fitted with focusing glass and finders, and may focus by scale in the same way as hand cameras. With an apparatus of this kind on a light stand any class

of ordinary indoor or outdoor work can be undertaken within the size of the plate, and the extension of the bellows, which should be quite double the focus of the lens.

The multiplicity of forms and arrangements of hand cameras makes it difficult to classify them into distinct types; but they may be mainly divided into *box* and *folding* cameras, and further into (a) cameras with enclosed changing magazines for plates or flat films; (b) with enclosed roll film on spools; (c) with separate changing magazines, changing boxes or roll-holders; (d) with single, double or multiple plate carriers or film-packs. Most cameras that will take glass plates in the ordinary plate-holders will take cut films in suitable sheaths or can be fitted with envelope slides, film-packs or roll-holders. The normal size for hand cameras is the quarter-plate (4½ in. X 3½ in.), or the continental size 9 X 12 cm.; 5 in. X 4 in. is also a popular size, and cameras for the post-card size, 5½ in. X 3½ in. or 15 X 10 cm. have been largely adopted. Smaller sizes are also made for lantern plates and for the lighter pocket cameras, some in the form of stereoscopes, field-glasses or watches, as in the "Tickla," but the pictures are small and require enlarging. Hand cameras are constructed on the same principles as stand cameras, but, being specially intended for instantaneous work, they are simplified and adapted for rapid focusing and exposing. The focusing screen is superseded or supplemented by finders arranged to show the limits of the subject on the plate, the focus being adjusted by the infinity catches and focusing scales above noticed. Swing-backs and fronts are often dispensed with, but are desirable adjuncts, and a rising and falling front particularly so. Lenses of fairly large aperture, $f/6$ to $f/8$, and good covering power, preferably of the anastigmatic type, or a rapid applanat, should be used, but for very rapid work anastigmats working from $f/4$ to $f/6$ will be more useful. Hand cameras can also be fitted with telephoto objectives of large aperture. Some cheap hand cameras are fitted with single landscape lenses or applanats working about $f/11$ or lower, but the want of intensity limits their use to well-illuminated subjects. Shutters of the between-lens type are now generally used in hand cameras, and for ordinary purposes should give fairly accurate exposures from $\frac{1}{2}$ to $\frac{1}{500}$ of a second or less and also time exposures. Some central shutters are speeded for shorter exposures to $\frac{1}{10}$ of a second, but for these focal plane shutters are preferable, and for the more rapid exposures to $\frac{1}{100}$ of a second and less are necessary. The shutter should be efficient, regular in action, and readily released by gentle pressure, pneumatic or otherwise. Mechanism for automatically changing plates or films in hand cameras of the box magazine type must be certain in action, simple and not readily put out of order, special care being taken to avoid rubbing or abrasion of the plates in changing or transport. In changing plates or films the number of plates exposed should be recorded automatically, and duplicate exposures prevented as

far as practicable. A circular level placed near the finder is useful.

The choice of a hand camera depends upon the circumstances in which it is to be used, and the purpose for which it is principally required. For general work and with the modern facilities for carrying and changing plates and films in daylight, the numerous folding hand or stand cameras for plates, flat or roll films, with full adjustments, will be found most useful. Box or magazine cameras in which a supply of cut films or plates can be carried, changed mechanically, and exposed rapidly in succession, are convenient, but their use is limited and they are liable to get out of order.

A third class are the reflex and other hand cameras with focal plane shutters for specially rapid instantaneous work as noticed below.

There are two types of light folding hand or stand cameras, specially adapted for hand camera work—those made for taking glass plates and the folding pocket Kodak or other roll-film cameras. The former are now made of very light construction with mahogany or metal bodies, wooden or aluminium base-boards, thin metal dark-slides (fig. 3). The cameras of the pocket Kodak type are of similar construction, but made to take roll films on spools, or with an attachment for focusing glass and dark-slides for taking plates and cut films. Attached to a sling-strap the quarter-plate size can be quite conveniently carried in a side-pocket. Watson's "Deft" folding camera is fitted with a focal plane shutter (fig. 4). The "Self-erecting" camera has a self-erecting front bringing the lens at once into position for use on opening out. Those fitted with lenses of fairly large aperture, double extension, and rising and falling fronts are to be preferred. Of box or magazine cameras there is an immense variety. In some the lens is fixed in focus for all objects within a certain distance, in others it is adjusted by a focusing scale on the lens or by an extending front. Some have a single magazine, others two or more. Some take only glass plates, others plates or cut films. All of them are, however, self-contained and ready for immediate exposure. One of the earliest forms of single magazine cameras, still in use, as in the "Eureka" and "Yale," is the "bag," in

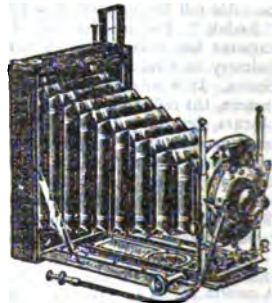

FIG. 3.—Ernemann's Pocket Camera.

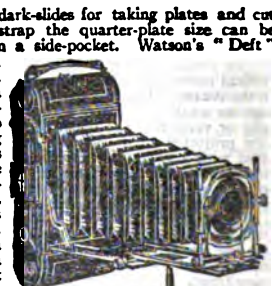

FIG. 4.—The "Deft" Folding Focal-plane Camera.



FIG. 5.—Double-magazine Box Camera.

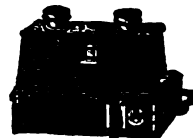

FIG. 6.—The Verascope, Richard.

which a supply of plates or films in sheaths, is kept in a magazine behind the camera, ready for exposure, the plates as exposed being lifted with the fingers into a bag or expanding chamber above the magazine and placed behind the rest of the plates at the back, a fresh plate taking its place in front. In some forms the magazines are removable and replaceable by others. The arrangement is simple and effective, but the bag, usually made of soft leather or cloth, is liable to wear and puncture, and may make dust. The cameras with double magazines in which unexposed plates are kept in one recess and transferred successively after exposure to a second recess are more complicated, and many

ingenious devices have been invented for effecting the change (fig. 5). Some forms are effective and popular on account of their compactness and readiness for immediate exposure, but there is always a risk of the mechanism failing, and care has to be taken in charging them to lay the plates truly in their places. The very handy binocular cameras, or *photo-jumelles*, of which the "Verascope" (fig. 6) is a type, are of this class, and have additional

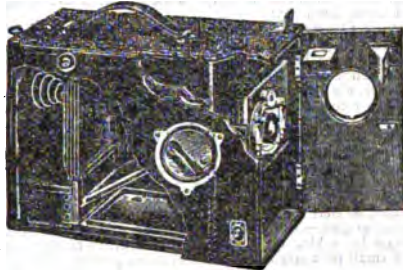

FIG. 7.—Beck's Dai-Cornex Daylight-loading Camera. magazines. So also are hand cameras of R. and J. Beck's "Frena" type, specially constructed for using stiff celluloid films. The films are notched on two sides and packed in bundles alternately with cards similarly notched. The pack of films and cards is placed in a magazine at the back of the camera, and by the movement of a lever, after exposure, the exposed film and its following card are released, and by turning the camera down are dropped into a second receptacle. A "folding Frena" is now made as a folding camera with attached magazine for films, without which it can be used separately for plates. R. and J. Beck's new "Dai-Cornex" is a great improvement in this form of camera, being a daylight-loading box magazine camera for plates, the plates being packed in a bundle of ridged sheaths, so that they are quite protected from light and can be put into or taken out of the camera in full daylight. In other respects it resembles other magazine cameras (fig. 7). Another useful magazine camera is the "Zambex," carrying either plates or films, held in skeleton frames in envelopes which can be loaded or unloaded in daylight, and are kept ready for use in the back of the camera and exposed consecutively. For work in which speed is of primary importance hand cameras fitted with very rapid lenses and focal plane shutters are necessary, and several forms of portable collapsible cameras of this kind are now available, such as the Goerz-Anschütz, Zeiss's "Palmas," Watson's "Vril" (fig. 8), Adams, "Idento," &c., and are lighter and more portable than the reflex cameras. Hand cameras are generally fitted with screw-bushes for mounting on a tripod stand when time exposures are wanted. The light folding wooden or aluminium stands noted below are specially suitable.

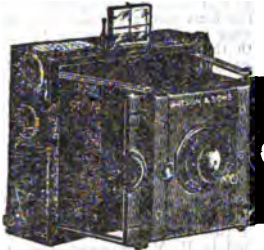

FIG. 8.—Watson's "Vril" Camera.

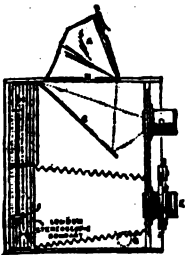

FIG. 9.—Camera fitted with Twin Lenses, section to show working.
 A. Hood of finder.
 B. Ground glass screen.
 C. Mirror.
 D. Viewing lens.
 E. Working lens.
 F. Shutter.
 G. Focusing pinion.
 H. Plate carrier.
 I. Plate.

exactly equal focus and focused together by the same motion of the rack-work, the object being viewed on the focusing screen of the upper compartment, and the plate kept ready in the lower

to be exposed when desired. Binocular hand cameras are also made on this principle, one compartment serving for focusing, the other holding lens and plates. Stereoscopic cameras are another form of twin-lens cameras, and are usually made for also taking single panoramic pictures.

In reflex cameras only one lens is necessary, though two are convenient, and can be used somewhat as in fig. 9. They generally consist of a cubical box camera containing a movable mirror facing the lens at an angle of 45° and throwing up the image projected from it on to a horizontal focusing screen, on which it is viewed through a flexible hood which folds down in the upper part of the camera when not in use (fig. 10). In order to get the greatest rapidity of exposure a focal-plane shutter is generally fitted, and by a single movement of the release the mirror is smoothly lifted and the plate exposed simultaneously. They should be fitted with anastigmatic lenses working at large apertures for very rapid work. In some forms the lens is fixed, but usually there is a front bellows extension for long-focus lenses, with rising and falling front, to which swing motion may be given, a swing-back not being generally used with the focal plane shutter. In the "Ernex" camera E. Human has made an arrangement by which the camera back, horizontal viewing screen and reflector are made to swing simultaneously, by a rack and pinion movement. They may also have reversing or revolving backs for quickly changing the position of the plate. 5 in. X 4 in. and 3½ in. X 4½ in. are the usual sizes of the plates, but larger and smaller sizes are also available. These cameras require the best workmanship and perfect mechanism for successful working and freedom from any jarring movement in releasing the shutter or mirror. The focusing screen must also be in accurate register with the focus of the lens on the plate. Those forms in which the image can also be viewed at the height of the eye, as in the Graflex (fig. 10), are preferable. Although reflex cameras are rather heavy and bulky as hand cameras, they have many advantages over the ordinary hand camera with finder and focusing scales for the purpose of the press photographer, the naturalist and others, in observing and recording very rapid movements, and have come into very general use for such purposes. They permit the accurate focusing of a full-sized image on the ground-glass up to the moment of exposure, especially useful when lenses of long or short focus are required and when the rising or swing front is in use. The aspect of this image on the ground-glass is also a great aid in the selection and placing of the subject and in judging the exposure required for it. They practically have all the advantages of a stand camera and can be used as such on a stand for subjects requiring prolonged exposure. They are also coming into increasing use in studio work for portraits of children, &c. Their use and adjustments are discussed by G. E. Brown in the *British Journal of Amateur Photography* for 1909.

Panoramic Cameras.—Many so-called "panoramic" cameras have been introduced from time to time, among them T. Sutton's (1861), and J. R. Johnson's "Pantascopic" (1864), but did not

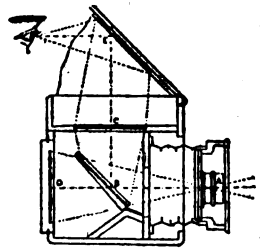

FIG. 10.—Reflex Camera.

- A. Lens.
- B. Mirror.
- C. Ground-glass.
- D. Plate.
- E. Supplementary mirror.

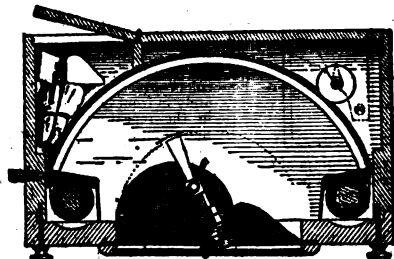

FIG. 11.—Section of "Al-Vista" Panoramic Camera.

come into general use till the use of curved surfaces of celluloid film enabled such cameras of convenient size and weight to be put on the market. They are on the same principle as one made by F. von Martens in 1845 for curved daguerreotype plates, and covering an angle of 150°. P. Moëssard's "Cylindrographe" of 1869 was the first of the modern type. It consists of a semi-circular

camera, the front of it formed of light-proof cloth and the back by the curved flexible carriers. The lens is fitted on a vertical axis, so that the nodal point of emergence remains motionless, and is revolved round it by means of a handle worked by hand and carrying a view meter. The illumination of the image is regulated by an adjustable vertical slit in a tube attached to the lens inside the box, and by altering the rate at which the lens is revolved. The pictures taken embrace less than 180°. The apparatus folds together and is quite portable; it is fully described in Moëssard's *Le Cinématographe* (Paris, 1899). The "Al-Vista" (1904) and the "Panoram Kodak" (1900) are on the same principle, but arranged as roll-holder hand cameras, in two sizes, carrying film for several exposures, 7 in. \times 2½ in. or 4 in. \times 12 in. They work instantaneously, and by means of a clock-spring the lens rotates rapidly over a half-circle when released. The angle of view is about 120°

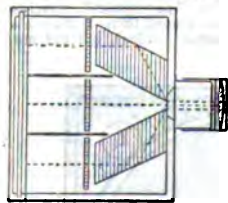

FIG. 12.—"Al-Vista" Panoramic Camera, closed.

used for stereoscopic or single pictures. Other more elaborate instruments driven by clockwork have been made for making a complete tour of the horizon. Among them C. Damoiseau's "Cyclographe," which can be used with lenses of different foci and takes the pictures on a roll-film, which is unrolled as the instrument revolves on its axis, the lens also rotating on its nodal point of emergence; and thus the image always remains sharp (*Bull. Soc. Franc. d. Phot.*, 1891, p. 183). Commandant A. Daubresse has improved on Moëssard's apparatus, by placing the lens vertically between two right-angled prisms, the upper of which receives the image and projects it through the lens on to the lower prism, from which, by rotation of the system on the vertical axis, it is projected on to a cylindrical film through an angle of 360° (*Ibid.*, 1906, p. 430; *E. Jb.*, 1907, p. 91). The "Periphot" and Ernemann's "Rundblick" camera are improved forms (*E. Jb.*, 1908, p. 322).

Many early forms of panoramic cameras are described in *B. J. A.* 1892, p. 517. Colonel R. W. Stewart's "Panoram" (1893), A. Chevalier's "Photographic Plane Table," J. Bridges Lee's "Photo-Theodolite" (1894), and similar cameras fitted with telescopes, levels and divided circles, are instruments of precision suitable for photographic surveying. Improved instruments for topographical surveying with stereo-photographic apparatus on the principle worked out by Dr. C. Pulfrich, of Messrs Zeiss & Co., in his stereo-comparator (1903), are being practically developed, and much information regarding them will be found in papers by E. Dolezal and others in *J. M. Eder's Jahrbücher*, 1903 to 1908; also a paper by Lieut. F. V. Thompson in *Geographical Journal*, 1908, xxxi, 534.

Cameras for Three-Colour Photography.—Many forms of camera have been constructed for making the three negatives required for trichromatic photography. They fall into two types: (1) those with a repeating back fitted with three colour-screens or filters—red, green and violet—through which the colour impressions are made successively with one lens upon a single colour-sensitive plate, as in the Sanger-Shepherd system. The colour-screens are placed immediately in front of the sensitive plate in the repeating back, which is moved on for each exposure. In a more recent form, by the same maker, the three images are taken on the sensitive plate with one exposure. The camera is divided into three compartments, and fitted with a special diaphragm which can be regulated for the varying sensitiveness of different batches of plates. The central image is impressed directly on the plate; the other two by reflection from prisms arranged so as to equalize the sizes of the three images on the sensitive plates, the light rays passing in each case through a suitable colour-filter—red, green and blue-violet—somewhat on the principle of F. E. Ives's camera of 1900 (fig. 13). It is convenient and successful in working. (2) Cameras made on the reflecting principle of L. Ducos du Hauron (1876), elaborated by F. E. Ives (1894) in his photo-chromoscope, in which three images are taken through three colour-screens on separate plates with one lens, the respective



exposures being regulated by reflection of the light coming from the lens by plane mirrors on to the sensitive plates, and its filtration through the colour-screens in front of them. Many variations of this method have been proposed, in which reflecting prisms replace the mirrors. The different systems have been discussed by W. Gamble (*Ph. Jour.*, 1905, xiv, 130), the latter also by E. T. Butler (*Ibid.*, p. 199). Sir W. de W. Abney has described three-colour cameras for landscape work in *Ph. Jour.*, 1904, xiv, 81, and 1908, xlviii, 331.

Enlarging Cameras.—These cameras vary in form, according to the nature of the illumination, but ordinarily consist of a double or triple extension bellows camera, with a holder for the negative or transparency at one end, and for the sensitive plate or paper at the other, the lens being placed on a fixed partition between the two. Some recent forms of "daylight enlargers" can be used as an ordinary camera. Other cheaper ones are on the fixed focus principle. Enlargers for use with artificial light are made like a magic lantern, with a condenser, projecting an enlarged image on to a sensitive plate or paper fixed on an easel or screen. A simple arrangement for daylight enlarging is to fix a suitable camera on to a larger one by a sliding front, and mount the two on a studio stand tilted so that the image may be illuminated by the open sky.

Cinematographs.—Many special cameras and lenses have been introduced for taking on a long flexible sensitive film an extended series of small photographs of the successive phases of movements, and again projecting them on a screen so as to reproduce the scene, with an illusion of motion, in what are known as "living pictures," biographs, &c. As each photograph requires a certain minimum time for exposure and must be kept in true position in sequence with the rest, some means of regulating the intermittent exposures and keeping the film in position have to be adopted; and there are many different ways of doing it, either by a continuous or intermittent motion and exposure of the film while it is being unwound from one roller on to another. The films used are similar to the ordinary celluloid films, but in narrow bands from 1½ in. to 2½ in. in width, the length varying with the number of exposures required, at the rate of 16 to 20 per second. They are perforated on both sides, so that they may run true and have the necessary intermittent motion, the perforations fitting on to studs on a sprocket wheel in connexion with the driving wheel and crank handle. Special lenses of short focus, from 1 in. to 3 in., with good covering power and large apertures $f/4$ to $f/2$, are required both for photographing and projecting; several such are noted below. Absolute rigidity in the camera is essential. Special stands are made for the purpose, but if a tripod stand is used it should be well braced. Special apparatus is required for developing and fixing the exposed films. They are wound on large rollers supported over troughs containing the necessary solutions (see CINEMATOGRAPHY). The mechanical arrangements are treated in H. V. Hopwood, *Living Pictures* (1899); F. P. Liesegang, *Handbuch der praktischen Kinetographie* (1907); K. W. Wolf-Czapke, *Die Kinetographie* (1908); G. Lindsay Johnson, *Photographic Optics* (1909); *Eder's Jahrbücher*.

A method of cinematography in colour was introduced by G. A. Smith and C. Urban in 1906, the main features of it being the use of a film sensitive to all colour waves to the furthest red; superimposing the colour records by persistence of vision; the use of two-colour records instead of three, in order to reduce the interval between the successive presentations; adaptation to existing cinematograph machinery and films. These conditions are fulfilled by the use, in place of the ordinary revolving sector shutter in front of the lens passing intermittent white light, of a special, more rapidly revolving shutter divided into four sectors, one fitted with orange-red glass, another with bluish-green glass and two intermediate opaque sectors, so that at every revolution of the shutter an exposure is made through the red and green glasses alternately. The former passes white and yellow, and then orange, scarlet to deepest red; whilst the latter also passes white and yellow, green, blue-green, blue, all in proportion according to the red and green sensitiveness of the specially sensitized panchromatic emulsion on the film. The same shutter and colour screens are used for projection, some supplementary blue rays being added. The results are satisfactory and the method promises to be of great practical value (see *Jour. Roy. Soc. Arts*, 1908, 57, No. 2926).

Special cameras are made for various branches of scientific research in photo-micrography, photo-spectroscopy, astronomical photography, &c.

Tripod Stands.—Field cameras are usually supported on wooden tripod stands, folding in two or more sections, the head being separate or fixed in the base-board of the camera. The legs should be capable of extension to about 5 ft. and adjustable in length for use on uneven ground. A tripod stand may be light, but must be firm and rigid when set up. To prevent slipping, shoes of india-rubber or cork may be fitted to the points of the legs, and in some cases it may be desirable to strengthen the tripod by a folding adjustable brace. W. Butler's "Swincam" camera stand is made to enable the camera to be securely fixed in awkward positions, and has many valuable special features, great extension, swivel points to the feet, &c. For hand cameras the very light, portable metal folding and walking-stick stands are convenient.

Photographic Objectives or Lenses.

The objective is the most important item of photographic apparatus, because upon it depends the perfection with which a correct and well-defined picture is projected upon the plane surface of the sensitive plate of objects in the different planes forming the field of view, which naturally would come to a focus on a series of curved surfaces. This flattened picture must be equally illuminated and sharply defined, within a limit of confusion from $\frac{1}{16}$ to $\frac{1}{2}$ of an inch, over a sufficiently wide angle. A good objective must also pass sufficient light to produce the required effect on the photographic plate with short exposures; the chemical and visual foci must coincide exactly, and it must not distort straight or parallel lines. The fulfilment of these conditions is complicated by the presence of sundry focal displacements or aberrations. (1) *Spherical aberration*, or non-coincidence of the foci of the central and marginal pencils of rays passing through the lens. It is corrected by varying the curves of the component lenses and by the use of a diaphragm. (2) *Coma*, or blur, due to lateral spherical aberration of oblique rays, and mostly found in unsymmetrical combinations and single view lenses. It is partly eliminated by the diaphragm. (3) *Astigmatism*, which accompanies coma in single lenses, and is usually present in symmetrical aplanats, manifests itself by forming two sets of images of points off the axis, lying in two separate curved surfaces, one set focusing tangentially as more or less horizontal lines, the other radially as more or less vertical lines. It increases with the obliquity of the rays and causes want of definition and difference of focus between horizontal and vertical lines away from the centre. (4) *Curvature of field*, also increasing with the obliquity of the rays. (5) *Distortion*, outward or inward, according to the nature and construction of the objective. With the single meniscus view lens, used with its concave surface towards the object and a diaphragm in front, a square will appear barrel shaped from inward contraction of the lines towards the centre; but with the convex surface towards the object and the diaphragm behind, it will appear with concave sides from outward expansion from the centre. It can be corrected by using two such lenses with the convex sides outwards and a central diaphragm, as in periscopic or rectilinear lenses. Lenses of the orthoscopic and telephoto types generally show the latter form of distortion. (6) *Chromatic aberration*, produced by the dispersion of the white light passing through the lens, and the different coloured rays composing it coming to a focus at different distances from the visual focus in the order of their wave-lengths. It thus affects both the positions and sizes of the image for the different colours. For ordinary photographic work it suffices for the blue-violet and yellow rays to be coincident, but for the new processes of photography in three colours, apochromatic lenses, in which perfect coincidence of the coloured rays is secured, are required to obtain the accurate register of the three images. The corrections are effected by compensating lenses of different refractive powers (see ABERRATION).

In constructing photographic objectives these aberrations and distortions have to be neutralized, by regulating the curves of the different positive and negative component lenses, the refractive and dispersive indices of the glasses from which they are made, and the distances of the refracting surfaces, so as to make the objective as far as possible *stigmatic* or focusing to a point, giving an image well defined and undistorted. This perfect correction could never be effected in objectives made before 1887, and very few could be effectively used at their full apertures, because although linear distortion could be overcome there were always residual aberrations affecting the oblique rays and necessitating the use of a diaphragm, which by lengthening out the rays caused them to define clearly over a larger surface, at the expense of luminous intensity and rapidity of working. The introduction of rapid gelatin dry plates enabled photographs to be taken with much greater rapidity than before, and led to a demand for greater intensity of illumination and better definition in lenses to meet the requirements of the necessarily very rapid exposures in hand cameras. For studio and copying work quick-acting lenses are also valuable in dull weather or in winter.

The rapidity of a lens with a light of given intensity depends upon the diameter of its aperture, or that of the diaphragm used, relatively to the focal length. In order, therefore, to obtain increased rapidity combined with perfect definition, some means had to be found of constructing photographic objectives with larger effective apertures. This necessity had long been recognized and met by many of the best makers for objectives of the single meniscus and aplanatic types, but with only partial success, because such objectives are dependent upon the diaphragm for the further correction necessary to obtain good definition over an extended field. The difficulty was in the removal of astigmatism and curvature of the field, which, as J. Petzval had shown, was impossible with the old optical flint and crown glasses. In 1886 Messrs E. Abbe and O. Schott, of Jena, introduced several new varieties of optical glasses, among them new crown glasses which, with a lower dispersion than flint glass, have a higher instead of a lower refractive power. It was thus rendered possible to overcome the old difficulties and to revolutionize photographic optics by

enabling objectives to be made free from astigmatism, working at their full apertures with great flatness of field independently of the diaphragm, which is now chiefly used to extend the area of definition or angle of view, and the so-called "depth of focus" for objects in different planes.

Photographic objectives may be classed as follows:—

- | | |
|-------------------------------------------------------------|--------------|
| 1. Single achromatic combinations. | } Old types. |
| 2. Unsymmetrical doublets. | |
| 3. Symmetrical doublets. | |
| 4. Triple combinations. | } New types. |
| 5. Anastigmatic combinations—symmetrical and unsymmetrical. | |
| 6. Telephotographic objectives. | |
| 7. Anachromatic combinations. | |

They are also sometimes classified according to their rapidity, as expressed by their effective apertures, into "extra rapid," with apertures larger than $f/6$; "rapid," with apertures from $f/6$ to $f/8$; "slow" with apertures less than $f/11$. Another classification is according to the angle of view, "narrow angle" up to 35° ; "medium angle" up to 60° ; "wide angle" up to 90° , 100° , or more. Many lenses are made in series, differing in rapidity and angle of view as well as in length of focus.

1. *Single Achromatic Combination or Landscape Lens.*—This is the earliest form of photographic objective, evolved from W. H. Wollaston's improved single periscopic meniscus camera obscura lens (1812). It was made achromatic by Ch. Chevalier, and so used by L. J. M. Daguere, though it required correction for chemical focus, as did the object glasses of telescopes or opera glasses first used for photography. The single landscape lens usually consists of an achromatic compound meniscus, formed of a biconvex positive crown cemented to a biconcave negative flint to secure achromatism and partially correct the spherical aberration, and may be taken as the type of the "old photographic achromat" (fig. 14). It is used with its concave side towards the object and a diaphragm in front, thus producing inward or barrel-shaped distortion, inherent in this type of objective, and rendering it unsuitable for copying or architecture, though not very noticeable in landscape work. The full aperture has to be largely reduced by a diaphragm to improve definition; so it is slow, though many improved forms have been brought out. It has always been popular for pure landscape work on account of the equality of illumination over the plate, depth of focus, and the softness and brilliancy of the image owing to its thinness and freedom from reflecting surfaces. In some of its improved and "long focus" forms it is preferred by portraitists for large heads, on account of the general softness it gives when used with large apertures.



FIG. 14.—Single Landscape Lens.

The following are some of the best-known improved objectives of this type: T. Grubb's "Aplanatic" (1857), $f/15$ to $f/30$

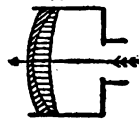

FIG. 15.—Grubb's "Aplanatic" Lens.

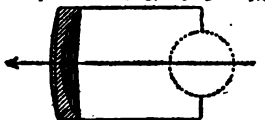

FIG. 16.—Rapid Landscape Lens. Long Focus.

(fig. 15); J. H. Dallmeyer's "Wide Angle Landscape Lens" (1865), $f/15$, angle 75° . In its distortion was reduced and marginal definition improved. The "Rapid (long focus) Landscape Lens" (1884), $f/12$, angle 40° (fig. 16), was a modification of it, and at $f/8$ is useful for heads in portraiture. W. Wray's "Landscape Lens" (1886), $f/11$, is also useful for portraiture in the larger sizes at $f/8$. Fr. Voigtlander's "Wide-Angle Landscape Lens" (1888)

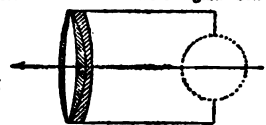

FIG. 17.—Rectilinear Landscape Lens.

In the diagrams of lenses which follow, a uniform system of indicating the nature of the glass employed by means of the shading has been adopted.

- Flint glass is indicated thus:—
 - Crown glass of low refractive power thus:—
 - Crown glass of high refractive power thus:—
- (These two are used indiscriminately in lenses made before the introduction of the new Jena glass.)
- Extra light flint glass thus:—
- In most cases the front of the lens is on the right.

§15, angle 90°, with great covering power and depth of focus. T. R. Dallmeyer's "Rectilinear Landscape Lens" (1888), $f/14$, angle 60° (fig. 17), was of novel construction, free from distortion, brilliant in working and useful for copying. Messrs Ross's "Wide-Angle Landscape Lens" (1890), $f/16$, angle 70°, triple cemented and made of Jena glass. Many other excellent objectives of this type have been made by British and foreign makers and are still used, though somewhat superseded by the fully corrected anastigmats specially made to work singly, or as single elements of anastigmatic doublets, as noticed in § 5.

2. *Unsymmetrical Doublets: Old Types.*—This class includes objectives with comparatively large apertures formed of two dissimilar combinations, in most cases correcting each other, with a diaphragm between them. In some the single elements may be used independently. All the older "portrait" lenses, some of the aplanatic doublets and Fr. von Voigtländer's "Orthoscopic" Lens (1857), now disused, are of this type. Even with the present improved conditions, the portraitist working in a studio requires a quick-acting objective of large effective aperture and comparatively short focus, giving a brilliant well-defined image of near objects in different planes over a restricted field of view. The early single lenses were found to be too slow for portraiture by the daguerreotype and talbotype processes, and the efforts of opticians were directed to the problem of obtaining the maximum amount of light, together with good definition and flatness of field, and about 1840 compound lenses were brought out by Andrew Ross and C. Chevalier, consisting of two achromatic compounds, one at each end of a tube. Ross's lens, made for H. Collen, is interesting as the first lens corrected photographically, so that the visual and chemical foci were coincident (fig. 18). Ch. Chevalier also combined lenses of different foci, as is now done for "convertible" objectives, used singly or combined. He also fitted them with iris diaphragms. These forms were soon superseded by the compound portrait lens, calculated by J. Petzval and brought out by

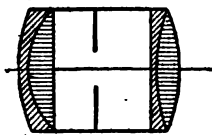

FIG. 18.—First English Portrait Lens.



FIG. 19.—Portrait Lens.

Fr. von Voigtländer in 1841. It consists of two dissimilar achromatic combinations widely separated. At first the diaphragms were in front, but now they are central. The front element is a plano-convex composed of a biconvex crown cemented to a plano-concave flint, while the back element is a double convex, composed of a biconvex crown separated by an air-space from a concavo-convex flint (fig. 19). This form of objective quickly supplanted all other for portraitures, and is still largely used, though it has defects which prevent its use for general purposes and is being superseded for portraiture by some of the rapid anastigmats. In his "Quick Acting Portrait Lens" (1860), $f/4$, angle 45°, J. H. Dallmeyer improved the correction for spherical aberration, and in his "Extra Quick Acting Portrait Lens" (1860), $f/2.2$, used for cinematograph work, attained greater rapidity. In the "Patent Portrait Lens" (1866), $f/3.4$ and $f/6$, angles 50° to 55° (fig. 20), he made great changes in the form and relative positions of the back elements, giving a flatter field and freedom from flare spot. By separating the two components of the back element more or less spherical aberration could be introduced to give softer definition and greater depth of focus. In 1875 Dr. A. Steinheil made an unsymmetrical aplanatic portrait combination of peculiar construction, working at $f/3.2$. It was an improvement on his similar symmetrical "Portrait-Aplanat,"



FIG. 20.—Dallmeyer's Patent Portrait Lens.

portrait combination of peculiar construction, working at $f/3.2$. It was an improvement on his similar symmetrical "Portrait-Aplanat,"

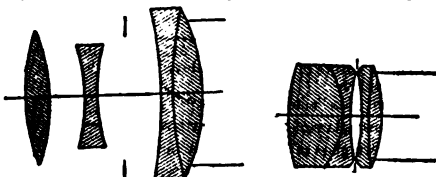

FIG. 21.—Portrait Aplanat. FIG. 22.—Group Aplanat. Form I. of 1874, but was superseded in 1881 by the "Portrait Aplanat," $f/4$ and free from astigmatism over an angle of 14°.

It had six reflecting surfaces and nearly approached a triplet (fig. 21). Steinheil's "Group Aplanat" (1879), $f/6.4$, angle 70°, were an improvement on the ordinary "Aplanats," but were superseded in 1881 by the "Group Aplanats," $f/15$, angle 70°, lenses of a distinct type (fig. 22). They were a further advance on the "Aplanats," working at larger apertures and giving of better definition. This lens is interesting as the first in which astigmatism was eliminated by combining a "crown-shaped" lens of high refractivity, with a "flint-shaped" of lower refractivity, though made of the old glasses. In his "Rapid Aplanat" (1893), $f/6.5$, angle 30°, Dr. R. Steinheil improved the "Group Aplanat" (as regards astigmatism and covering power by replacing the thick back combination by a triple long-focus negative element consisting of a crown between two flints, with a heavy barium crown in the front element instead of a flint (fig. 23). Voigtländer, who originally constructed the Petzval portrait lens, improved it in 1876 and 1885, and now makes two lenses on the same principle, series I. $f/3.2$, angle 28°, for ordinary portraiture and projection, and series II., $f/2.3$, angle 22° (1900) for astrophotography, cinematography, &c., when intense illumination is required over a small field. Both are quite free from coma.

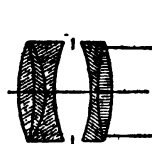

FIG. 23.—R. Steinheil's Improved Group Aplanat.

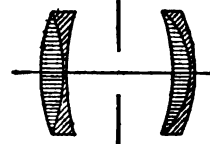

FIG. 24.—Ordinary Angle Actinic Doublet.

Most of the above are portrait objectives of large aperture, but unsymmetrical doublets have also been made for landscape work. J. T. Goddard's "Combination Landscape Lens" (1859) was one of the first, and was free from distortion, gave a flat field, and could be used as a convertible lens. In 1864 T. Ross issued his "Actinic Doublets," a modified form of the Collen lens, in three series—"small angle," $f/8$, angle 40° to 50°; "ordinary angle," $f/14$, angle 60° to 75° (fig. 24); "large angle," $f/16$, angle 80° to 95°. These lenses were similar to the "Globe," but unsymmetrical and more rapid. The separate elements could be used alone. Some of them were fitted with a shutter near the diaphragm. They were superseded by the "Symmetrical" lenses.

3. *Symmetrical Doublets.*—This class includes objectives formed of two similar combinations of lenses, usually of the convergent meniscus form, with their concave surfaces inwards and a diaphragm between them; consequently they are rectilinear and practically free from marginal distortion. Until the introduction of anastigmatic doublets they were in general use for all purposes under the names "Aplanat," "Rectilinear," "Symmetrical," "Euryscope," &c. They are still largely used and have been improved by the use of Jena glasses in their construction.

The first recorded lens of this type was Dr J. W. Draper's combination used in 1839 for daguerreotype portraits, consisting of two double-convex lenses 4 in. diameter, with a united focus of 8 in., mounted in a tube with a diaphragm $3/4$ in. in front. In 1841 T. Davidson made a combination of two single landscape lenses very similar to the later rectilinear doublets. Being slower than the Petzval portrait lens its value as a non-distorting lens for general purposes was not recognized. G. S. Cundell (1844) combined two uncorrected meniscus lenses with a diaphragm between them. In 1860 T. Sutton brought out his "Panoramic Lens," which worked on curved plates covering about 100°. It was followed

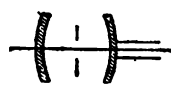

FIG. 25.—C. A. Steinheil's "Periskop."

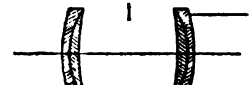

FIG. 26.—A. Steinheil's "Aplanat."

by C. C. Harrison's "Globe Lens" (1862), angle 75°, composed of a symmetrical pair of deep compound menisci, the exterior surfaces forming part of a sphere. Though defective and slow it was popular for a time. C. A. Steinheil's "Periskop" (1865), $f/13.5$, angle 90°, was a symmetrical doublet formed of two plain crown menisci with central diaphragm (fig. 25). It gave a larger field than the "Globe," the lenses being closer together. Being monochromatic it had to be adjusted for chemical focus. It was quite free from distortion, with a very flat field, and both nodal points together. It is considered the best possible combination of two plain lenses, and is still used in some of the cheaper hand cameras with fixed focus, the difference of the chemical and visual foci being allowed for in the camera or by adjustable lens mounts. G. Rodenstock's "Bistigmats" are of this class. J. Zentmayer made a similar unsymmetrical lens. In A. Steinheil's "Aplanat" (1866) the same principle was carried out with achromatized lenses, and a great

improvement was effected in the construction of non-distorting objectives of fairly large aperture. It consisted of two cemented flint menisci, each composed of a dense flint with negative focus outside and a light flint with positive focus inside, its concave surfaces facing the centre (fig. 26). This use of flint glasses alone was peculiar, former achromatic lenses having been made of flint and crown. These lenses were made in three rapidities: "Ordinary," $f/6$ or $f/7$, angle 60° ; "Landscape," $f/12$ to $f/15$, angle 90° , also used in convertible sets; "Wide Angle Landscape," $f/20$ to $f/25$, angle 104° ; "Wide Angle Reproduction," similar to the last, but with sharper definition. The "Aplanat" had many advantages over previous doublets and the triplet, being more rapid, perfectly symmetrical, so that there was no necessity for turning them when enlarging, and free from distortion or flare. There was no chemical focus. Each component could be used alone for landscape work with double focus, subject to the ordinary defects of single lenses. By the use of Jena glasses in the "Universal Aplanat" (1886) the components of this lens were brought closer together, its intensity increased, and it was made more portable. J. H. Dallmeyer had been working in the same direction simultaneously with Steinheil, and in 1866 brought out his "Wide Angle Rectilinear," $f/15$, angle 100° , made of flint and crown, the front element being larger than the back (fig. 27). It was slow for ordinary purposes and was succeeded in 1867 by the well-known "Rapid Rectilinear," $f/8$, on the same



FIG. 27.—Wide-Angle Rectilinear Lens.

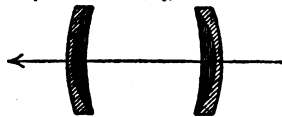

FIG. 28.—Rapid Rectilinear Lens.

principle as Steinheil's "Aplanat," but made of flint and crown (fig. 28). Ross's "Rapid" and "Portable Symmetrical" lenses, Voigtländer's "Euryscopes," and other similar lenses of British and foreign manufacture are of the same type, and still in use. They are excellent for general purposes and copying, but astigmatism is always present, and although they can be used with larger apertures than the triplets they displaced, they require stopping down to secure good marginal definition over the size of plate they are said to cover. By the use of Jena glasses they have been improved to work at larger apertures, and some are made with triple cemented elements.

4. *Triple Combinations: Old Types.*—This class comprises objectives composed of three separate combinations of glasses widely separated from each other. An early form of this type was made by Andrew Ross (1841) for W. H. Fox Talbot, others by F. S. Archer, J. T. Goddard (1859), T. Sutton (1860), but they never came into general use. J. H. Dallmeyer's "Triple Achromatic Lens" (1861), $f/10$, angle 60° , now out of date, was an excellent non-distorting lens, very useful for general work and copying (fig. 29). As made by Dallmeyer, the inner surfaces of the front and back components were slightly concave, but in T. Ross's "Actinic

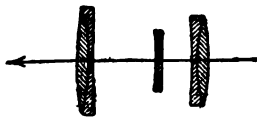

FIG. 29.—Triple Achromatic Lens.

Triplets" (1861), $f/16$, they were flat. The centre lens was an achromatic negative serving to flatten the field.

5. *Anastigmatic Combinations, Symmetrical and Unsymmetrical.*—As already stated, it was found practically impossible to obtain flatness of field, together with freedom from astigmatism, in objectives constructed with the old optical glasses. A. Steinheil attempted it in the "Antiplanets," but with only partial success. The Abbe and Schott Jena glasses, issued in 1886, put a new power into the hands of opticians by largely increasing their choice of glasses with different refractive and dispersive powers. Whereas the old glasses had high refractivity with high dispersion, in the new ones high refractivity with lower dispersion could be set against lower refractivity with higher dispersion.

Between 1887 and 1889 the first attempts to make anastigmatic objectives with the new glasses were made by M. Mittenzwei of Zwickau, R. D. Gray of New Jersey, E. Hartnack and A. Miethe of Berlin ("Pantoscope"), K. Fritsch of Vienna ("Apochromat") and Fr. von Voigtländer of Brunswick, with more or less success, but progress was hindered by the instability of some of the early glasses, which was afterwards overcome by sandwiching the soft glasses between two hard ones. In 1888 Dr H. L. H. Schroeder worked out for Messrs Ross the "Concentric Lens" (fig. 30) issued in 1892 (*Ph. Jour.*, 16, p. 276). It was a symmetrical

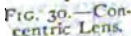

FIG. 30.—Concentric Lens.

doublet of novel construction, each element consisting of a plano-convex crown of high refractivity cemented to a plano-concave flint of lower refractivity, but about equal or higher dispersion. Both the

uncemented surfaces were spherical and concentric. At $f/16$ it gave sharp definition and flatness of field with freedom from astigmatism, distortion or flare over an angle of 75° . It was an excellent lens, though slow, and has been superseded by the "Homocentric" and other more rapid anastigmata. Dr Paul Rudolph, of Messrs Carl Zeiss & Co., Jena, worked out in 1889 a new and successful method of constructing a photographic objective by which astigmatism of the oblique rays and the want of marginal definition due to it could be

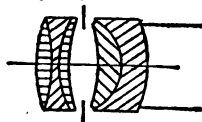

FIG. 31.—Anstigmat. Series II. $f/6.3$.

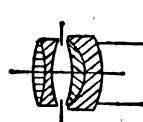

FIG. 32.—Anstigmat. Series IIIa. $f/9$.

eliminated without loss of rapidity, so that a comparatively extended field could be covered with a large aperture. This he did on the principle of the opposite or opposed gradation of the refractive indices in the front and back lenses, by a combination of two dissimilar systems of single lenses cemented together, the positive element of each having in one case a higher and in the other a lower refractive index than that of the negative element with which it was associated. The front system, relied upon for the correction of spherical aberration, was made of the old glasses, a crown positive of low and a flint negative of high refractivity, whilst the back system, relied upon for the anastigmatic flattening of the field, was made of the new glasses, a crown positive of high and a flint negative of low refractivity. Both systems being spherically and chromatically corrected for a large aperture, the field was flattened, the astigmatism of the one being corrected by the opposite astigmatism of the other, without destroying the flatness of the field over a large angle (see *E. Jb.*, 1891 and 1893; M. von Rohr's *Geschichte*, and O. Lummer, *Photographic Optics*, for further details). They were issued by Messrs Zeiss and their licensees (in England, Messrs Ross), in 1890, in two different types. The more rapid had five lenses (fig. 31), two of ordinary glasses in the front normal achromat, and three in the back abnormal achromat, two crowns of very high refractive power, with a negative flint of very low refractive power between them.

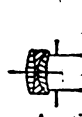

FIG. 33.—Anstigmat. Series VI.



FIG. 34.—Satz Anstigmat. Series VIa.

The fifth lens assisted in removing spherical aberrations of higher orders with large apertures. The second type, series IIIa., $f/9$, 1899 (fig. 32), had only two lenses, the functions of which were as above. These combinations could not be used separately as single lenses. They are now issued as "Protars," series IIa., $f/8$; IIIa., $f/9$; V., $f/18$. In 1891 Dr Rudolph devoted himself to perfecting the single landscape lens, and constructed on the same principle a single combination of three lenses, the central one having a refractive index between the indices of the two others, and one of its cemented surfaces diverging, while the other was converging. At $f/14.5$ this lens gave an anastigmatically flat image with freedom from spherical aberration on or off the axis. It was, however, not brought out till 1893, as a convertible lens or "Satz-Anstigmat," series VI., $f/14.5$, and VIa., $f/17$ (figs. 33 and 34). In the meantime Dr E. von Höegh (C. B. Goertz) and Dr A. Steinheil had also been working at the problem and had independently calculated lenses similar to Rudolph's, but, whereas he had devoted himself to perfecting the single lens, they sought more perfect correction by combining two single anastigmatic lenses to form a doublet. Dr Rudolph had had the same idea, but Messrs Goertz secured the priority of patent in 1892, and in 1893 brought out their "Double Anastigmat," now known as

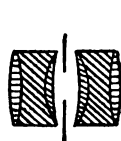
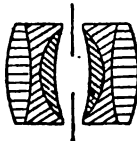

FIG. 35.

Ross-Goertz "Dagor," Series III. Ross-Goertz. Series IV. "Dagor." It was the first symmetrical anastigmat which combined freedom from astigmatism with flatness of field and great covering power at the large aperture of $f/7.7$ (fig. 35). Both these types of Zeiss's "Protars" and Goertz's "Dagor" anastigmata have since

been made by Messrs Ross in England. Messrs Steinheil brought out their first "Orthostigmats" in 1893, but, owing to patent difficulties, were unable to manufacture them in Germany, and they were issued later in France and England. They were followed by a second type, which has since been issued in several series by Messrs Steinheil and by Messrs Beck in England (fig. 36). According to Dr R. Steinheil (*E. Jb.*, 1897, p. 172) this lens was an application of two principles recognized by Dr A. Steinheil as necessary for the spherical and anastigmatic correction of a lens. He attempted to carry them out in the "Antiplanet," but was prevented by the want of suitable glass. He found that for anastigmatic correction an objective should have the separating surface between two media concave towards the medium of higher refraction (new achromat), and for

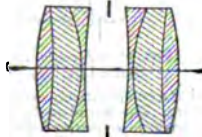

FIG. 36.—Steinheil's "Orthostigmat."

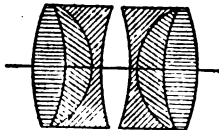

FIG. 37.—"Collinear." Series II.

spherical correction the separating surface should be convex towards the higher refracting medium. A fully corrected cemented lens cannot, therefore, be made with less than three glasses, but with uncemented lenses an air-space may form one of the media. In 1895 Dr D. Kaempfer worked out the "Collinear" for Messrs Voigtlander, constructed on the same principles as the "Orthostigmat," type II, and similar to it (fig. 37). It is made in three series: II., $f/3.4$ and $f/6.3$; III., $f/6.8$ and $f/7.7$ (convertible); IV., $f/12.5$, and the apochromatic collinear $f/8$, calculated by Dr H. Harting for three-colour reproduction, &c. (*Ph. Jour.*, 1901, 25, p. 323.)

In 1894 Dr Rudolph extended the application of his principle by combining the old achromat and the new achromat into a single quadruple cemented lens (fig. 38), which, according to T. R. Dallmeyer, was the most perfectly corrected single lens that had been

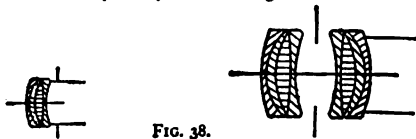

FIG. 38.

Series VII. $f/12.5$.

Series VIIa. $f/6.3$.

evolved up to 1900, Dr Rudolph having succeeded in obtaining freedom from spherical aberration and astigmatism, and also in eliminating coma (*Ph. Jour.*, 1901, 25, p. 68). These lenses were issued in 1895 as series VII. singly and VIIa., in combinations now known as "Convertible Protars," and the earlier series VI. and VIa. were withdrawn. The single lenses of series VII., $f/12.5$, angle 85° , have great anastigmatic flatness of field and only very slight marginal distortion, a condition not realized before in a single lens. The relative rapidities of the double combinations of series VIIa. vary from $f/6.3$ to $f/8$, according to the lenses used. They are excellent lenses for all general purposes.

In their "Convertible Protars," series IV. (1908), $f/12.5$, angle 60° , Messrs Zeiss have simplified and cheapened the construction of these lenses by the use of new Jena glasses, so that they consist of three instead of four lens elements cemented together, while possessing the same high efficiency as series VII. They are issued as "single" or "double" Protars, $f/12.5$ and $f/6.3$ or $f/7$, also in sets of three or four objectives of different foci, which are combined to give pictures of different angles of view from the same standpoint. With both series when using the "Protar" lens singly, it should be screwed behind the iris diaphragm of the mount, to avoid curvature of the field, and when two such lenses are combined the one with the greater focal length should be placed in front.

In 1895 Messrs Goetz patented a double anastigmat, $f/5.6$, with quintuple single lens components as a convertible lens, for which greater sharpness of definition and intensity, with perfect freedom from astigmatism and distortion in the single lens, were claimed. It was issued in 1898, but, like an earlier analogous quintuplet of Messrs Turner & Reich (1895), it has not come into use on account of the cost and difficulty of construction. The latter firm, however, brought out in 1906 a new symmetrical quintuplet at $f/6.8$.

A triple anastigmatic combination containing remarkable new features, constructed and patented by H. D. Taylor, was issued in 1895 by Messrs Taylor, Taylor & Hobson under the name of the "Cooke Lens," and later by Messrs Voigtlander as the "Triple Anastigmat." It consists of three single lenses, two of them positive crossed lenses of crown glass with high refraction and low dispersion, with their most convex sides outwards, and between them, in front of the diaphragm, a single biconcave of light flint (fig. 39). All

these lenses are designed to be free from diaphragm corrections, while the focal power of the negative lens is made as closely equal to the combined focal powers of the two positive lenses as may be

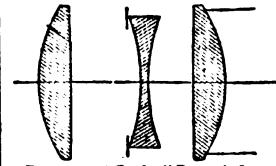

FIG. 39.—Cooke "Portrait Lens." Aperture $f/4.5$.



FIG. 40.—"Cooke" Lens. Series III.

necessary for the flattening of the field and correcting marginal astigmatism. They are not convertible, but arrangements are made for replacing the back lens by a low-power extension lens (*Ph. Jour.*, 1895, 19, p. 64). Series III., $f/6.5$ (fig. 40), and series IV., $f/5.6$, are portrait lenses. In the larger objectives of series II. the back lenses are adjustable for uniform sharp definition or a soft diffusion of focus. In a later series VI. (1907), $f/5.6$, this adjustment for diffusion is given to the front lens and is so arranged for portraiture that the diffusing adjustment and iris diaphragm can be operated from the back of the camera while viewing the focusing screen. A special fully corrected "Process" lens on the same general principle has recently been brought out for three-colour work and fine-line reproduction. Another distinctly new type of anastigmatic objective involving several new principles of construction was patented by H. L. Aldis in 1895, and brought out by Messrs Dallmeyer in three series, under the name of "Stigmatic" (*Ph. Jour.*, 1896, 20, p. 117). It also approaches the triplet construction and depends on the introduction of air-spaces between the component lenses. According to Aldis, three conditions must be observed to obtain a flat field free from marginal astigmatism: (1) The converging lenses must be of high, the diverging of low, refractive index; (2) the converging and diverging components must be separated by a considerable interval; (3) thick meniscus glasses should be used. The first "Stigmatic" was a portrait lens, series I., 1896, $f/4$. It has been made in two forms, first with a triple front lens, and a back negative system formed of a single thick crown lens of high refractivity with a negative cemented meniscus. In the second form (fig. 41) the front component consists of a cemented positive and negative, and both parts of the back component are cemented lenses. All the converging lenses are of dense baryta crown, while both the diverging lenses in the back component are a light silicate crown. It is fully corrected for spherical and chromatic aberration, free from distortion and nearly so for astigmatism, giving equal illumination over a flat field of 60° . Diffusion of focus is obtained by unscrewing the back cell. Series II. (1897) is on the same principle but differs in construction, working at $f/6$ over an angle of 85° as a universal and convertible lens (fig. 42). The front or back component can be used alone, giving the choice of two focal lengths, 1½ and twice the focal length of the complete lens. The principles of its construction were described by T. R. Dallmeyer in *Ph. Jour.*, 1897, 21, p. 167. Series III., $f/7.5$, will at $f/16$ give sharp definition over a plate two sizes larger. The single components are not convertible.



FIG. 41.—Stigmatic Portrait Lens. Series I.

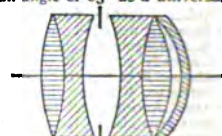

FIG. 42.—Stigmatic Lens. Series II.

In 1897 Messrs Zeiss issued the "Planar," an objective of large aperture based on the principle of the Gauss telescope objective. It is a symmetrical doublet, each element consisting of three lenses, the two inner ones being a double convex and a double concave, of equal refractive but different dispersive power, cemented together and separated by an air-space from the outer convex meniscus (fig. 43). Its special points are its good colour correction, large relative aperture and intensity, varying from $f/3.6$ to $f/6$, with perfectly sharp definition and anastigmatic flatness of field over an angle of view from 62° to 79° . It is a very rapid wide-angle lens useful for instantaneous work with the cinematograph and hand cameras, also for portraits and groups, photo-micrography and enlargements or reductions (see *E. Jb.*, 1898, p. 79, Von Rohr, p. 390, and Lummer, p. 81). Apochromatic planars with reduced secondary spectrum were brought out in 1903 for three-colour photography, and are also useful for astrophotography, the circle of diffusion being very small. The "Unar" (1900), $f/4.5$ in the smaller and $f/6.5$ in the larger sizes, angle 65° and 68° , was a further improvement by Dr Rudolph, &c.

consists of two dissymmetrical combinations, each formed of two single lenses of very transparent glass, dense baryta crown and light flint, separated by positive and negative air-spaces (fig. 44). The separate halves cannot be used as single lenses, neither being fully corrected for colour. It is well adapted for portraiture, groups or landscapes, especially for rapid hand camera work, on account of its covering power, with freedom from astigmatism and sharp definition with large relative aperture.

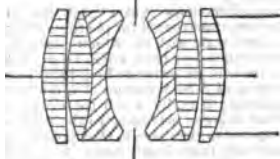

FIG. 43.—Planar. Series Ia. $f/4$.

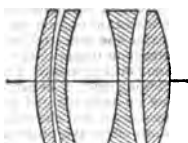

FIG. 44.—Zeiss's "Unar."

In 1898 Messrs Goerz patented their "Double Anastigmat Color," series 16., $f/4.5$ to $f/5.5$. It is a symmetrical doublet, each element consisting of two thin single lenses: a positive of high and a negative of low refractive index, separated by an air-space (fig. 45). It is derived from the triple anastigmats by decreasing the refractive power of the central convex meniscus to the refractive power of air, so that it becomes a convex air-space between a double convex and a double concave lens. Less deeply curved surfaces can be given to the lenses, and the doublet gives anastigmatic flatness of field over an angle of 62° to 66° , equal to the best anastigmats with a still larger aperture. Series 1c., $f/6.3$, is similar and recommended for hand cameras, the aperture being smaller. Goerz's "Hypergon," (1900) $f/22$, angle 135° , is a

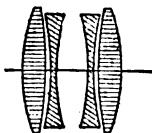

FIG. 45.—Goerz's "Color."

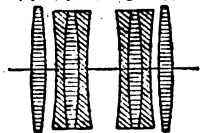

FIG. 46.—Goerz's "Alethar."

symmetrical doublet of remarkable construction, consisting of only two single semi-globular, very thin lenses, with diaphragm at the centre of curvature between them. Astigmatism and curvature have been eliminated, and definition is good over the above wide angle with no distortion. Chromatic aberration is uncorrected, but compensated for by using a small stop. A star mask is fitted in front of the lens to allow for falling off of illumination towards the margin (*E. Jb.*, 1901, p. 103). The "Syntor" (1903), Series 1d., $f/6.8$, angle 64° to 70° , is on the same principle as the "Color," but cheaper, for use in hand cameras or telephoto combinations. The "Alethar," series V. (1903), $f/11$, is a lens with diminished secondary spectrum, for three-colour reproductions, half-tone process work, and general purposes. It is a symmetrical doublet, each element consisting of a negative and positive separated by an air-space (fig. 46). The negative is composed of three cemented lenses, which correct the spherical and chromatic aberrations more fully than hitherto possible, so that all the colours of the spectrum are focused in the same invariable plane. It gives great crispness of definition at full aperture (*W. Zschokke, E. Jb.*, 1904, p. 165). Goerz's "Fantar," $f/6.3$ (1904), is a convertible 4-lens anastigmat, and an improvement on the "Dagor," in that the single elements are completely corrected for coma, and thus form efficient long-focus lenses for landscape, &c., at an aperture of $f/12.5$, while the doublets formed by various combinations of the single elements are universal objectives working from $f/6.3$ to $f/17.7$. The single elements are similar to those of the "Dagor," but have an additional negative

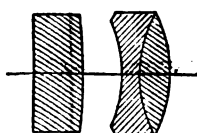

FIG. 47.—Aldis Lens. Series II.

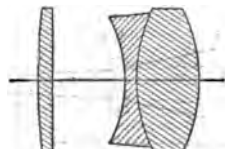

FIG. 48.—Aldis Lens. Series III.

lens at the back, so that the outer two of the three cemented surfaces have a collective and the inner one a dispersive action, by which coma is eliminated (*E. Jb.*, 1905, p. 55).

In 1902 H. L. Aldis issued the "Aldis Lens," $f/6$, a doublet composed of a cemented meniscus in front and a single double-

convex back lens. It is a long-focus objective with short back focus, and is made in two forms, series II., $f/6$ (fig. 47), and series III. (1903), $f/7.7$ (fig. 48). In the latter the back element is very thin; and the front combination of infinite focal length. By discarding the symmetrical form simplicity is secured, while open or reflecting surfaces are avoided. Special attention has been paid to perfect correction of spherical aberration in the centre of the field. It is lighter, smaller and cheaper than series II. The "Duo" lens of the same maker (1907) is intended to replace the front lens and double the focus, but with less rapidity and without any loss of quality. The "Trio" (1908) is similar, but only increases the focus one and a half times and is thus more suitable for cameras of short extension. The Aldis "Oxya" anastigmat, series II. (1908), $f/5.65$, angle 85° , is an improved form. Being an unsymmetrical cemented doublet it is free from the defects incidental to air-spaces and is constructed to give more perfect correction for flatness of field with large aperture and wide angle.

It is generally stated that it is impossible to make a spherically, chromatically and anastigmatically corrected photographic objective with the old optical glasses. K. Martin, of Messrs Busch of Rathenow, has, however, shown (*E. Jb.*, 1902, p. 68) that it is quite possible to do so with a system of separated lenses, and that it is immaterial whether the index of the flint or the crown is the higher. An anastigmat on this principle was issued by Messrs Busch in 1902, as the "Omnar," series III., $f/7.7$ (fig. 49). Series II., $f/5.5$, angle 75° , and I., $f/4.5$, have since been issued. It is a symmetrical



FIG. 49.—"Omnar," Series III.

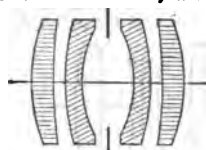

FIG. 50.—Ross's "Homocentric."

doublet, each element consisting of a negative flint meniscus of higher refraction, and a positive crown of lower refraction with an air-space between them in the form of a negative lens. The back element can be used alone. The "Lumar" series, by G. Rodenstock, is similar. In 1902 Messrs Ross brought out the "Homocentric," a symmetrical doublet, each element consisting of a negative and positive meniscus separated by an air-space (fig. 50). It is constructed so that all rays of light emanating from any one point of the object are converged again into one point in the image. It is also quite free from spherical zones, is not altered in focus with different diaphragms, and thus has exquisite defining power. The colour correction is so perfect that the different coloured images are identical in size and position, thus rendering it specially suitable for three-colour and process work. The back lens can be used alone, with diaphragms, as a single lens of about double the focus of the doublet. It is made in several series: II., $f/5.6$, and III., $f/6.3$, for rapid and instantaneous work; V., $f/8$, for ordinary purposes; VI., $f/8$, for process work and three-colour reproduction. A later series, IV. (1907), "Compound Homocentric," $f/6.8$, differs from the others in being a symmetrical doublet composed of two triple cemented elements, very close together and separated by a diaphragm. It is

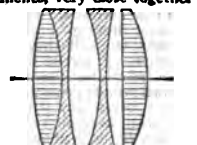

FIG. 51.—Zeiss's Tessar.

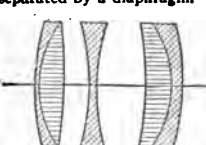

FIG. 52.—Voigtlander's Heliar.

specially suitable for outdoor work, also for copying and enlarging, having good covering power. Zeiss's "Tessar" (1902) is a rapid unsymmetrical doublet, formed of two separated uncemented positive and negative lenses in the front element and a cemented meniscus at the back (fig. 51). The two halves cannot be used separately. The glasses used are very transparent, permanent and lessen the secondary spectrum. Three series are made by Messrs Ross, I., $f/3.5$ for cinematographic work and portraiture, and $f/4.5$ for hand-camera work and portraiture; II., $f/6.3$ for general purposes, and VIII., the "Apochromatic Tessar," specially corrected for three-colour work and reproduction. They all give fine definition over a large flat field, free from any zonal aberration. The $f/3.5$ portrait lenses, with double the field and covering power of the Petzval lens, are anastigmatic and free from distortion. Messrs Voigtlander's "Heliar" (1902), $f/4.5$, angle 50° , calculated by Dr H. Harting, is an objective of large aperture, suitable for portraits and very rapid instantaneous work, being well corrected for astigmatism, coma and curvature of field, with freedom from flare. It is a triplet consisting

of a central negative lens, with cemented double front and back lenses (fig. 52). The negative lenses are of light silicate flint, the two positive of the heaviest baryta crown. Besides being a rapid universal lens, it is specially suitable for half-tone process work, with a large diaphragm (*E. Jb.*, 1903, p. 117). The "Dynar" (1903), $f/6$, angle 60° , is of somewhat similar construction, but differs from the "Heliar" in the positive lenses of the cemented pairs being outside instead of towards the central lens. It can only be used as a whole. It is made of hard colourless Jena glasses, giving great brilliancy and uniformity of illumination over a large angle, and is specially adapted for very rapid hand-camera work.

Dr R. Steinheil's "Unofocal" (1903), $f/4.5$ is a symmetrical doublet, each element consisting of two single separated lenses of equal refractive power and of equal focus of opposite signs, hence its name. Each half can be used as a single lens with small stops. In its construction a quite new principle was followed, the separation of the lenses fulfilling an important part in the colour correction, as explained by Conrad Beck in *Ph. Journ.* (1904), 44, p. 177. This plan satisfies the Petzval condition and removes its restrictions, so that a lens of $f/4.5$ can be produced with telescopic central definition, perfect freedom from distortion and flare over a flat field of 60° , with great equality of illumination (fig. 53). They are made by Messrs Beck in two series: II., $f/4.5$, for portraiture, rapid hand-camera work, telephotography and projection; and I., $f/6$, in which the lenses are closer together, for hand-camera work and general purposes. E. Arbet's "Euryplan" anastigmats (1903), made by Schultze Bros., Potsdam, are apochromatic objectives of quite new construction, giving perfect definition with large apertures over a

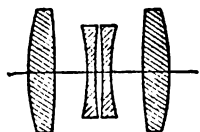

FIG. 53.—Beck-Steinheil "Unofocal."

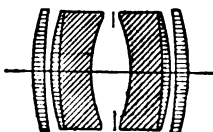

FIG. 54.—Euryplan, $f/4.5$.

wide angle, made in four series: I., $f/4.5$, angle 80° ; II., $f/5.6$, angle 90° ; III., $f/6.8$ to 7.5 , angle 82° ; IV., $f/6.5$. They are symmetrical doublets, each element consisting of three lenses, a new achromat formed of a biconvex of heavy baryta crown of high refractivity and low dispersion, separated by an air-space from a positive meniscus of the same baryta crown, with its concave side towards the diaphragm. In series I., $f/4.5$, the two positives are placed outside (fig. 54), in series II. and III. they are inside. The single elements are fully corrected astigmatically and chromatically, and can be used singly at double the focus (*E. Jb.* 1904, p. 35).

Beck's "Isostigmat" (1907) is a new anastigmat showing a distinct departure from the ordinary principles of construction, in that it does not fulfil the Petzval condition that the sum of the focal powers of its individual lenses multiplied by the reciprocals of their respective refractive indices should be equal to zero, or $\sum(1/\mu f) = 0$. It is a 5-lens combination, two separated thin single lenses in the



FIG. 55.—Beck's "Isostigmat."

front element and three in the back (fig. 55). In departing from the Petzval condition very low power lenses can be used, thus reducing the initial errors to be corrected; no individual component having a shorter focal length than one-half that of a complete objective. A special feature is the excellent correction of the oblique spherical aberrations and central aberrations, giving a practically flat field without astigmatism over angles from 60° to 90° . The half combinations can also be used alone with diaphragms as long focus lenses of different foci (*Ph. Journ.* 1907, 47, p. 191). It is issued in six series: I. (1908), $f/4.5$, large aperture, series, for reflex press work and portraiture; Ia., $f/6.5$, angle $60^\circ-65^\circ$,

latter is very useful when an extended use of the rising front is required, either at a wide or ordinary angle. V. (1908), $f/11$, "Process" lenses specially corrected to give a flat field for copying. They can be fitted with suitable reversing prisms. VI. (1908), $f/5.6$, variable portrait lenses, adjustable for sharp or soft definition from the back of the camera while focusing.

The above represent the principal types of anastigmats, but many more objectives of the kind, triple or quadruple, cemented or uncemented, with air-spaces, in many modifications, have been issued by English and foreign makers.

6. *Telephotographic Objectives*.—For some years past special objectives, or attachments, have been constructed for photographing near or distant objects on an enlarged scale with an ordinary camera, the extension required being very much less than would be needed to obtain an image of the same size with an ordinary long-focus lens without enlargement. They consist of a combination of a positive converging with a negative dispersing lens, by which the image is picked up and enlarged to varying degrees, according to the system of lenses used and the extension given to the camera, thus producing the same effect as a positive lens of very much longer focus. Enlarged images of this kind can also be made by a combination of two converging lenses, one of them forming an image of the object, which is received on the other of shorter focus and projected on the sensitive plate, being enlarged more or less according to the optical conditions and relative positions of the lenses and sensitive plate. The telephotographs at Greenwich and other solar observatories, designed by Warren de la Rue, are on this principle. Portable apparatus of the kind was made in 1869 by MM. Borie and de Tourneville, and later by Jarret, but this system requires much greater extension of the camera, entailing more loss of intensity of the image, and has never come into use.

The modern telephotographic combination is generally looked upon as an application of the principle of the "Barlow" lens, but it really goes back to the Galilean telescope (c. 1610). J. B. Porta mentions the combination of concave and convex lenses for giving enlarged and clearer images of near and distant objects (*Magia Naturalis*, lib. 17, cap. 10, 1589). J. Kepler showed that by a combination of a convex with a concave lens images of objects could be depicted on paper of a larger size than by the convex lens alone, but reversed (*Dioptrica*, Prob. cv. 1611). Christopher Scheiner made use of the same principle in his "Heliocope" for solar observations (*Rosa Ursina*, cap. vii. 1630). F. M. Deschales and P. Z. Traber also dealt with the question, and in J. Zahn's *Oculus artificialis Teledioptricus* (1686) we find figured a reflecting camera fitted with a compound enlarging lens on this principle. In his *Nova Dioptrica* (1692), W. Molyneux has given some interesting problems for calculating the position of the compound focus of a convex with a concave lens, also the angles subtended by an object on the focal plane. If for the simple uncorrected glasses then used we substitute a system of photographically corrected positive and negative lenses, suitably mounted, and put a sensitive plate in place of the paper, we have the modern telephotographic arrangement. I. Porro seems to have been the first to use a combination of this kind for photographing an eclipse in 1857, and later for terrestrial objects. It consisted of a small achromatic single lens combined with a concave lens. Many attempts were afterwards made in France, and also in England, to utilize the principle, but special lenses for the purpose were not available. Ad. Steinheil constructed one in 1889 for the Brussels Observatory, and another in 1890 for the Marine Department in Berlin. In 1891, curiously enough, three such combinations were worked out quite independently and patented, by T. R. Dallmeyer in London, A. Miethe in Berlin and A. Dubosq in Paris. Since that time these combinations have been greatly improved by increase in the working apertures and reduction in size and weight, so that they can be used in hand cameras. They are exceedingly valuable for obtaining details of inaccessible objects at a distance, whether architectural or topographical, and for photographing animals without approaching them too closely. Large portraits can also be taken with much better perspective effects and more conveniently than by using long-focus lenses much nearer to the sitter. With the very perfect telephoto-

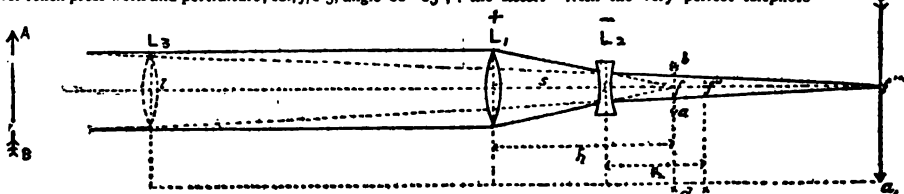

FIG. 56.

long focus, for portraiture, &c.; II., $f/5.8$, angle 70° , for general use; III., $f/7.7$, angle 65° , similar to II. but less rapid; IV., $f/6.3$, angle 90° , wide angle, giving satisfactory definition at full aperture over an angle from 80° to 85° . Having such a large reserve of covering power the

graphic objectives now available the loss of intensity of illumination, which no doubt was the bar to early progress in this direction, has been overcome, and definition has also been improved, so that snapshots can readily be made with combinations of high intensity, while

with those of ordinary intensity the exposures are not unduly prolonged, and good definition can be obtained over an extended field.

The optical principle on which these combinations are based is very simple, and will be understood from fig. 56. It depends mainly on the fact that in order that a real image may be thrown on the screen of an object AB, the rays proceeding from it, which pass through the positive system L_1 , must come to a focus at a point f within the secondary focus f' of the negative system L_2 . Falling within this limit, they will be intercepted by L_2 and made less convergent, so that instead of coming to a focus at f , they will continue to converge till they reach the screen at f' , and will there form a proportionally larger image $a'b'$ of AB than the image ab given by the positive lens alone at f ; just as stated in Kepler's problem. Moreover, this image $a'b'$ will be of the same size as if it had been produced directly by a positive lens L_1 with a focal length equal to lf'' , and this distance is the equivalent focal length of the entire system. It can be found from the formula $F = f_1 f_2 / d$, where f_1 and f_2 are the focal lengths of L_1 and L_2 respectively, and $d = f_1 + f_2 - s$, s being the distance between the lenses. In many instruments of the kind a scale showing the value of d is engraved on the mount. If the rays from AB come to a focus in front of L_2 , on it, or beyond f' , no real image can be projected on the screen. There is therefore a certain limit, which is greater in proportion to the length of focus of the negative system, within which the focus of the positive system L_1 may fall and produce a series of well-defined images on the screen, which can be varied in size by altering the amount of separation of the two systems of lenses within the above limit, and the distance of the screen from L_2 . Every change in the position of the screen will involve a corresponding adjustment of the lenses. The greater the extension of the camera and the closer the lenses, the greater the size of the image, and vice versa. The camera extension for a given magnification can be found by multiplying the focal length of the negative system by the number of magnifications, less one. The magnification produced by a given camera extension is found by dividing the latter by the focal length of the negative system, and adding one.

In its usual form (fig. 57) the telephotographic combination consists of a quick-acting portrait lens, or an anastigmatic doublet of

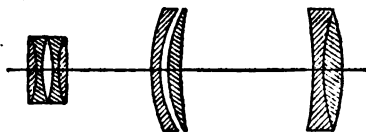

FIG. 57.—T. R. Dallmeyer's Compound Telephotographic Lens.

large aperture and relative intensity of suitable focal length, fitted at one end of a tube, in which slides a smaller tube carrying a properly corrected negative system, which may vary in focus, but must be of shorter focus than the positive (usually about half); the shorter the focus the greater the magnifying power for a given extension of camera. The amount of separation of the lenses is limited on the one hand by the position of the focus of the positive system, and on the other by the focus of the negative system, as explained above, and can be adjusted within these limits by a rack and pinion. The tubes are adjusted so that when closed up the two foci may coincide, or nearly so, and $d = 0$, or its minimum value; and when opened to their fullest extent the focus of the positive may fall upon the negative system, or so that d may not exceed the focal length of the negative system. Within these limits the focal length of the combination will be positive, and a real image formed on the screen. Several forms of them have been brought out by various makers, some, as Zeiss's, with a special positive lens, others (or use with anastigmats and other lenses of large apertures). The negative lenses are also made of various powers.

Messrs Dallmeyer's "Adon" (1902) is a telephotographic lens, for use with hand cameras, composed of two achromatic combinations adjusted for parallel rays, a front positive lens 4½ in. focal length, and a back negative lens of 2½ in. focus. These are mounted to permit of great variation in the separation, so that when the "Adon" is fixed on the front of a suitable lens, near or distant objects may be taken on an enlarged scale without altering the focus of the camera, or the enlargement can be varied with further extension of the camera. Used alone it is a complete telephoto lens of moderate magnifying power, and will cover plates 15 in. X 12 in. In 1903 a special form, the "Junior Adon," was made in three kinds for use with kodaks and similar folding hand cameras, single and double extension, giving a fixed degree of magnification without loss of rapidity, while focusing can be effected by scale. It is intended to replace the front lens of an R.R. or anastigmatic lens and cannot be used independently. Messrs Busch's "Bis-Telar," $f/9$ (1905), is another compact fixed focus telephoto lens, specially for use with hand cameras. It is a complete lens in itself, requiring no attachments and can be fitted to a central shutter. It is made in three sizes magnifying from two to three times. An improved form of this lens (1908), working at the large aperture of

$f/7$, is similar to an old form of "Dialytic" lens worked out by J. Petzval, having a positive front and negative back meniscus, with their concave surfaces facing inwards (fig. 58). As in the old "Orthoscopic" and lenses of that type there is some outward distortion, but it is very slight. These lenses are made in five sizes with focal from 8 to 22 in., requiring camera extensions from 4½ in. to 11½ in. They magnify about twice. According to K. Martin, a telephoto-combination of the Bis-Telar type can be used in a reversed position as a projecting lens for the lantern, with the advantage of increasing the illumination from a given source of light (*E. Jb.* 1908, p. 46).

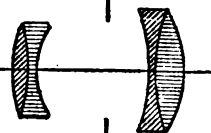

FIG. 58.—"Bis-Telar."

Captain Owen Wheeler proposed in 1907 a high-power telephoto arrangement, made by Messrs Staley, in which the negative attachment consists of three negative lenses, any single one of which can be used separately, giving magnifications of about 6, 9, and 13 diameters with a camera extension of 14 in. By combining the three a magnification of 30 diameters is attainable with the same short extension, which is a great advantage in many ways. In 1908 Messrs Zeiss issued their "Special Tele-objectives" in two sizes working at $f/10$, the larger with an aperture of 3.14 in. and 32 in. focal length fitted in a special "tele-camera" for plates 9 X 12 cm. with a monocular field glass magnifying four times as finder. The smaller one, with 18 in. focus, is adapted for hand cameras with 6 in. bellows extension. They consist of specially corrected positive and negative combination with a definite focal length and requiring a definite camera extension, and are especially suitable for balloon photography, instantaneous portraiture, &c. The theory, construction and use of telephoto lenses has been fully described by T. R. Dallmeyer in his *Telephotography*.

7. Achromatic Lenses.—For large portraiture a certain amount of softness and diffusion of the image has long been recognized by artists as desirable, and in 1895 the "Dallmeyer-Berghelm Lens" was constructed with this special object. It is composed of a single uncorrected positive meniscus front lens, with a diaphragm in front of it, and an uncorrected negative meniscus back lens, and in the larger sizes it has great range of focal length on the telephotographic principle. The spherical and chromatic aberration produced by the uncorrected single lenses gives the diffusion of focus which produces the peculiarly soft and delicate effect aimed at. It is most useful for large heads and life-size studies, the great depth of focus conducing to uniformity of definition. There is no distortion, and by stopping down to about one-third perfect definition can be obtained. It works with great brilliancy, both elements being single glasses. It was the first of the anachromatic portrait lenses. Since 1903 Messrs C. Puyo and L. de Pulligny have been experimenting with various combinations of uncorrected lenses for producing the same effect in portrait and landscape photography by the diffusion of focus produced by chromatic aberration, and suitable lenses of this kind have recently been brought out in Paris as *Les Objectifs d'artiste*. In their construction the principal points to be considered are spherical aberration, to be minimized in the form and arrangement of the lenses selected; distortion, corrected by using a symmetrical system; astigmatism, avoided by using combinations of low power. The lenses used by Puyo have been: (1) a plano-convex crown with convex side in front at $f/8$ or $f/9$, or even $f/5$ for heads; (2) a simple thin concavo-convex meniscus, with concave side in front, is better and suitable for full lengths at $f/10$; (3) a symmetrical system formed of two similar crown menisci, concave sides inwards, is generally useful when worked at $f/10$, or even $f/5$. Arrangements are made in mounting these lenses for automatically making the necessary correction for colour. Another form is the "Adjustable Landscape Lens," formed of an anterior plano-convex crown, 3 cm. diameter, and a posterior plano-concave crown, each of 10 cm. focus, and the same radii of curvature. In contact they have an infinite focus, but when slightly separated any focus can be obtained up to about 20 cm. In such a telephotographic system, properly stopped down, anastigmatism, flatness of field, and rectilinearity are secured over a fairly large field. These lenses are fully described in *Les Objectifs d'artiste*, by L. de Pulligny and C. Puyo (Paris, 1906), and various forms, portrait and landscape, have been made by Messrs Hermagis, Turillon & Morin (see Fabre, *T. E. P. Suppl.* D. 101).

Diaphragm Apertures.—In order to regulate the intensity of the illumination by the lens, to enlarge its field, and, in the case of the older forms of objectives, to extend the area of good marginal definition, diaphragms are used, usually with circular apertures. They are made in different ways: (1) as single metal plates, fitting into a slot in the lens tube (Waterhouse diaphragms); (2) Rotatory: a single plate revolving on a central axis and pierced with apertures cut to fit centrally in the opening of the lens; (3) Iris: a form of diaphragm now very generally used, and very convenient, because it can be easily adjusted as required for intermediate apertures. As a rule they are placed at the optical centre between the elements of a compound lens or in front of a single one.

In order to provide a uniform system of diaphragm apertures,

the Royal Photographic Society in 1881 drew up some rules, which were revised in 1891 and again in 1901. The former standard unit $f/4$, and the numerical notation used with it, have been abolished in favour of the unit $f/1$ established at the International Congress in Paris 1900. Intensity ratio is defined as dependent upon the effective aperture of a lens, and not upon the diameter of the diaphragm in relation to the focal length of a lens. The effective aperture of the lens is determined as follows: The lens must be focused for parallel rays. An opaque screen is then placed in the principal focal plane, and a pinhole is made in the centre of the plate (in the axis of the lens); an illuminant is placed immediately behind the pinhole itself, when the diameter of the beam emerging from the front surface of the lens may be measured. (It will be found that except in the case of the diaphragm being placed in front of the lens, the diameter of the diaphragm itself is seldom that of the effective aperture.) Every diaphragm is to be marked with its true intensity ratio as above defined, but the present intensity ratios are retained in their order of sequence: $f/1, f/1.4, f/2, f/2.8, f/4, f/5.6, f/8, f/11.3, f/16, f/22.6, f/32, f/45.2, f/64, &c.$, each diaphragm requiring double the exposure required by the preceding one. In other cases apertures are to be made in uniformity with the scale, with the exception of the highest intensity, e.g. a lens of $f/6.3$ would be marked for $f/6.3, f/8, &c.$ The corresponding numbers are known as f numbers, but are only applicable for a lens focused for distance. Other systems of notation are in use, but the above is generally adopted (see Fabre, *T.E.P. Suppl. C. 38*). Special diaphragms are in use for process work with ruled screens (see N.S. Amstutz, *Handbook of Photo-engraving*, 1907). Standards for the screws of photographic lens-flange fittings, and for the screws fitted to cameras for attachment to the stand or for fixing movable parts, have also been laid down (*Ph. Journ.* 1901, 25, p. 322).

Instantaneous Shutters.

The general use of rapid dry plates and hand cameras has rendered it necessary to have some mechanical means of regulating exposures in small fractions of a second, especially for objects in rapid motion, and this instantaneous shutter has become an essential part of modern photographic equipment in many forms and patterns, but practically three types are preferred—the between-lens shutter, the roller-blind shutters, used before or behind the lens, and the focal plane shutter, in front of and close to the plate and forming part of the back of the camera. The usual limit of rapidity of the two former is nominally about $\frac{1}{100}$ of a second, and for ordinary purposes higher speeds are seldom required, while with the latter speeds of $\frac{1}{1000}$ to $\frac{1}{2000}$ of a second may be attained.

Two important factors in the use of lens shutters are the *rapidity* or *speed*, measured by the total duration of exposure from opening to closing, and the *efficiency*, measured by the ratio of the time during which the shutter is fully open and the time occupied in opening and closing. Both factors are more or less variable, either with differences of construction, of diaphragm opening or of position of the shutter with regard to the plate and lens. In any case the *efficient* exposure is always less than the *actual*, and may be considerably so.

The rapidity required of a shutter in photographing moving objects is regulated by the minimum time necessary to produce a well-exposed image upon the plate, with a loss of definition, or blurring, by displacement not exceeding $\frac{1}{16}$, or preferably $\frac{1}{32}$ to $\frac{1}{64}$ of an inch, if enlargement is extended. This will depend on the state of the light and the illumination of the object, the relative intensity of the lens as measured by its effective aperture and focal length, the sensitiveness of the plate, and the amount of effective light passing through the shutter during the exposure. The amount of displacement to be guarded against depends upon the rate of movement of the object, the direction in which it is moving with reference to the axis of the lens, its distance from the camera, and the focal length of the lens. It will be proportionately less as the distance of the object increases, and as the rate of its motion and the focal length of the lens for a given distance decrease, and vice versa. It will be greatest when the object is moving at right angles to the axis of the lens, and least when the motion is directly towards it; but in that case there will be some increase in the apparent size of the object as it approaches the camera. For example: An object moving 1 m. an hour advances 17.6 in. per second. With a lens of 5 in. focus this would represent a displacement on the ground glass for an object 50 ft. away, amounting to $\frac{1}{146}$ in. per second, and it would require exposures between $\frac{1}{10}$ and $\frac{1}{20}$ of a second to give maximum or minimum displacements of the image between $\frac{1}{16}$ and $\frac{1}{32}$ of an inch. An object at the same distance moving ten times as fast would require 1-10 of the above exposures. If, however, the distance be increased, the possible exposure may also be increased in the same proportion, so that the object moving 10 m. an hour at 500 ft. distance would only require the original exposures of $\frac{1}{10}$ to $\frac{1}{20}$ of a second. On the other hand, the limits of exposure for an object moving 1 m. an hour within 10 ft. of the lens would be between $\frac{1}{10}$ and $\frac{1}{100}$ of a second. This is entirely independent of the sensitiveness of the plate, and only represents the maximum duration of exposure permissible in order to reduce the blurring of the image between certain limits. The sensitiveness of the plate, and the intensity and amount of light

acting upon it through the lens and shutter, must be adjusted so as to produce the desired photographic effect within that time. With a lens of 8 in. focal length the displacement would have increased in the first instance to $\frac{1}{23}$ in. per second, and the maximum exposure permissible would be from $\frac{1}{10}$ to $\frac{1}{20}$ of a second. This shows that there is an advantage in using short-focus lenses for very rapid exposures. In practice, most work of this kind is done upon quarter-plates ($\frac{1}{4} \times \frac{3}{4}$ in.) with lenses of $\frac{1}{4}$ to 5 in. focus. As the displacement will be greatest for an object moving at a right angle across the axis of the lens, an exposure sufficient for this case will be sufficient for any other. Sir William Abney has discussed this question practically in his *Instantaneous Photography*, and it is treated mathematically by W. B. Coventry in his *Technics of the Hand Camera*, in which will be found formulæ and tables for ascertaining the distances and limiting exposures for moving objects, allowing for a blur of $\frac{1}{100}$ of an inch. In foreign treatises the limit is usually calculated for a displacement of $\frac{1}{16}$ of a millimetre, or about $\frac{1}{64}$ of an inch.

An efficient shutter should fulfil the following conditions: It should be light and compact, simple in construction and action, strongly made, and not liable to get out of order; capable of being set without admitting light into the camera; easily released with a slight pressure of the finger if a pneumatic release is not fitted, and free from any tendency to shake the camera on release. It should open and close quickly, allowing the largest possible proportion of the exposure to be made with the full aperture, and it must not cut off any of the effective light passing through the lens, but should distribute it evenly all over the plate; though in landscape work it is an advantage to give the foreground more exposure than the sky. It should be adjustable for variable instantaneous and for prolonged or "time" exposures. With a good shutter there is less risk of shaking the camera in short "time" exposures, from $\frac{1}{10}$ to 1 second, than there is in taking off a cap. Shutters working between the lenses must permit of the use of diaphragms in the lenses, and of alterations of speed while set. Above all, a shutter must be constant in its action, giving short and variable exposures always correctly or relatively so, an important condition which cannot always be fulfilled, and the exposures marked on the indicator should be capable of being repeated with tolerable certainty. Shutters should also be adaptable for use with different lenses. Three methods of varying the speed of a shutter are in use: (1) by altering the length of the slot; (2) by the retarding action of a pneumatic brake; (3) by varying the tension of a spring. The latter is considered by W. B. Coventry as far the best. They are usually released by the pressure of the finger on the end of a lever holding the moving part in a state of tension; or better, by J. Cadett's system of pneumatic pressure, applied by means of a compressible rubber bulb and tube, which may drive a piston acting on the lever holding the shutter, or inflate a collapsible bulb on the other end of the tube and thus exert the necessary pressure on the lever. With W. Watson's "Antinous" release a flexible wire acts directly on the piston or trigger release of a cylinder shutter. It is also adapted for roller-blind, focal plane, flap, and various forms of between-lens shutters. It is durable, effective and convenient (see fig. 3). In many cases both methods can be used as desired, the mechanical release being preferable on account of its convenience and freedom from liability to shake the camera.

The following are the principal types of instantaneous shutter: (1) Flap, (2) drop, (3) combined drop and flap, (4) rotary, (5) roller blind, (6) focal plane, (7) moving blade central, (8) iris. They can be applied in four different positions: (a) in front of the lens; (b) centrally, near the diaphragm; (c) behind the lens (d) immediately in front of the sensitive plate. They all, however, come under two main classes: *Lateral*, including those in which the exposure commences and ends at the circumference of the lens aperture; and *Central*, those in which the exposure begins and ends at the centre of the aperture. Some of them are "lateral" in their single form and "central" when double. The form and position of the effective aperture of a shutter, relatively to the lens and plate, have a strong influence, either favourable or unfavourable, on the amount of effective light passing through the lens, and its even distribution over the plate. This is especially the case during the incomplete phases of opening and closing the aperture. It seems to be agreed that the best position for lens shutters of the lateral type is behind the objective, and for those of the central type, between the component lenses. In this latter position the whole of the plate is illuminated during the full period of exposure, with a gradually increasing intensity, until the full opening is reached, and then the illumination gradually falls off until the shutter is closed. The most effective shutter is one in which the first and third phases of incomplete illumination, during the opening and closing, are the shortest compared with the second phase of full opening.

With the focal plane shutters, however, different portions of the plate are exposed in succession, the lens working at its full aperture and efficiency throughout the exposure.

To secure successful results in using instantaneous shutters, the operator should make himself acquainted with the working of his shutter and its efficiency in various circumstances of exposure with the lenses, plates and developer he proposes to use; ascertaining the actual value of the various exposures marked on the indicator, and

what is more important, how far they can be depended on for regularity. There are many simple ways in which the actual time of exposure from opening to closing can be ascertained sufficiently closely for practical purposes. They depend upon the measurement of the trace left on a sensitive plate by the passage of a brightly illuminated object revolving at a known speed or falling vertically through a known distance, when photographed with different speeds of the shutter against a dark background. These, and the more elaborate methods for obtaining more accurate determinations of the shutter-exposure periods and of the corresponding effective exposures—i.e. showing the actual effect of the shutter through its different phases from opening to closing—have been described by Sir William Abney in the work already mentioned, by A. Londe in *La Photographie moderne* and *La Photographie instantanée*. An apparatus for testing shutters at the National Physical Laboratory was described by J. de Graaf Hunter in the *Optician*, 1906.

1. **Flap Shutters.**—The simple flap shutters consisting of a hinged flap opening upwards in front of the lens, though favourites in early days for landscape work, and still useful for intermittent exposures or as sky-shades for securing cloud effects or increasing foreground exposures, have been almost superseded by quicker and more compact forms. They are used with single and double flaps for portraiture and studio work, for which purpose they are made to act noiselessly and not attract the attention of the sitters. Guerry's (figs. 59 and 60) is a good example of the type. W. Watson's "Silent"



FIG. 59.—Guerry's Single-flap Shutter.



FIG. 60.—Guerry's Double-flap Shutter.

shutter is hemispherical in form and collapsible, the two wings opening out and folding together, when actuated by a special "Antinous" release, and R. & J. Beck's is another form, a single lifting flap with pneumatic release.

2. **Drop Shutters.**—The old simple drop shutter, in which a plate having an opening in it falls in front of the lens aperture, has been superseded by the more compact and quicker-working roller-blind shutters, which act on much the same principle. It had a theoretical interest in connexion with the effect of different forms of aperture—circular, square, or elongated—used with shutters of the lateral type, but it is now generally recognized that a more or less extended rectangular opening, of at least the full width of the lens aperture, is best for securing the even admission of light from all parts of the image with shutters of the rectilinear lateral type, to which this and similar shutters, in which a single opening passes across the lens aperture, belong. In Busch's "sky shade" shutter (1907), fitting on the front of the lens a single leaf moves vertically upwards and descends again, giving less exposure to the sky.

3. **Combined Drop and Flap Shutters.**—In early dry-plate days several forms of this kind of shutter were brought out, under the names of Phoenix, Phantom, &c., but are now little used. In these shutters, in addition to the drop slide, there was also a lifting flap, which on release opened from below, and having fully uncovered the aperture, released the drop slide, which fell and closed the shutter. They were useful and effective in the smaller sizes, but heavy and cumbersome in the larger. Speed could only be estimated very roughly by the use of india-rubber bands for giving tension.

4. **Rotary Shutters.**—These are of the lateral type, and consist of a circular metal disk revolving on an axis eccentric to the axis of the lens, and furnished with a radial sector-shaped opening, which passes laterally in front of the lens aperture when the tension of a spring is released (fig. 61). They are used in various patterns in cheap hand cameras, usually in front of the objective, though they may be placed behind it or between the component lenses. So long as the opening is at least equal to the size of the lens aperture, the illumination is sufficiently even, but the openings are usually elongated so as to give a longer period of full opening. Working by a spring they are more portable and convenient than drop shutters. Beck's



FIG. 61.—Rotary Shutter.

"Celverex" between-lens shutter (1906) is of this type, the disk being revolved by a spring and the variations of exposure obtained by altering the size of the opening passing over the lens aperture, and not the tension of the spring. It is speeded for exposures of $\frac{1}{10}$, $\frac{1}{20}$, $\frac{1}{30}$, $\frac{1}{40}$, $\frac{1}{50}$ sec.; also "bulb" and "time." It is fairly accurate and consistent in action, but loses efficiency at the highest speeds by the diminution of the opening.

5. **Roller-Blind Shutters.**—For general use the well-known roller-blind shutter of the single lateral type, as made by Thornton-Pickard and others, is undoubtedly one of the most popular and efficient. It possesses most of the qualities laid down as essential to a good shutter, gives good illumination, appears to be fairly regular in its action and can be used for time or instantaneous exposures. It consists of a light mahogany or aluminium box, arranged so that it can be fitted in front of or behind the objective. It is made in different sizes, and each size can be adjusted to smaller objectives (fig. 62). It is also made with a disappearing cord, and in an improved pattern, the "Royal," all the fittings are inside the box. By pulling the cord

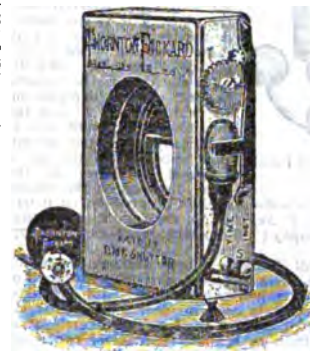

FIG. 62.—Thornton-Pickard Roller-Blind Shutter with automatic exposure apparatus.



FIG. 63.—Mechanism of the Thornton-Pickard Roller-Blind Shutter.

- A, Upper roller.
- B, Lower roller.
- C, Cord.
- D, Black curtain.
- H, Aperture in curtain.
- R, Rubber ring adapter.

an opaque black curtain with an elongated rectangular aperture is unrolled from the lower roller on to the upper one, and held by a coiled spring on the lower roller (fig. 63). Pressure on a pneumatic bulb inflates a second smaller bulb, raising a lever which releases the spring, and thus brings the blind down with a rapidity which can be adjusted by turning a handle actuating the spring, the corresponding speed being shown on an indicator. For time exposures, pressure on the bulb opens the shutter, and another pressure closes it, but an arrangement is now made by which time exposures of $\frac{1}{10}$, $\frac{1}{20}$, $\frac{1}{30}$, $\frac{1}{40}$, $\frac{1}{50}$ seconds can be given automatically, the pressure of the bulb opening the shutter, which closes of itself at the expiration of the exposure required. The theory of shutters of this type has been very fully discussed by Coventry (*op. cit.* p. 50), who shows that for any given tension of the spring the actual exposure decreases as the size of the lens aperture diminishes, while the effective exposure remains constant for all apertures. This is peculiar to the lateral shutter. He also shows that with plates of very different rapidities, though the exposure may be the same, the actual exposure effective is less with the rapid plate and a small stop than with the slow plate and a large stop; consequently the blur due to the movement of the object would be proportionately less on the rapid movement of the object would be proportionately less on the smaller plate than on the slow one. Also that for any given lens the smaller the shutter the more rapid the exposure can be made, though with the same lens a larger shutter is capable of giving a more efficient though less rapid exposure. It is better, therefore, for moderate exposures, to have a larger shutter than the size of the lens requires. Sir William Abney had given diagrams of the action of a shutter of this kind in his book referred to; they show clearly that the centre of the plate gets more exposure than the margins; but practically this is not very noticeable, and the action is very regular.

6. **Focal Plane Shutters.**—These are also roller-blind shutters with mechanism similar to the foregoing, but arranged so that the slit in the curtain may move rapidly close in front of the sensitive plate, exposing different portions of it in turn, the intensity of the exposure being regulated by the width of the slit, whether adjustable or not, and the rapidity with which it is moved by the unwinding of a spring. The advantages of these shutters are now being fully appreciated, the principal being that they are quite independent of the lens, so that one shutter will serve for different lenses, and any suitable lens may be used at its full intensity, without the loss of efficiency inherent in the ordinary forms of lens-shutters. They thus add effectively, if not actually, to the speed of a slow lens, or if a lens be stopped down there is less loss of efficiency, with a gain in increased depth and definition. They are particularly well adapted for the very short exposures required in photographing near and quickly moving objects, racing horses, divers, &c., and many reflex and other hand cameras are fitted with them. They are constructed in different forms, either for short exposures with high speeds alone, or for short and prolonged exposures; with a single slit of fixed or variable width moved at regulated speeds, or with a series of slits or openings varying in width, their speeds being adjusted by the

tensions of the springs. Thus the new Goerz-Anschütz shutter has ten tensions and nine curtain apertures, providing for ninety different speeds or exposures, ranging from $\frac{1}{100}$ of a second, besides automatic exposures from $\frac{1}{4}$ to 5 seconds and time exposures (fig. 64). Most of these shutters are now provided with a self-capping device for protecting the sensitive plate during the setting of the shutter. As the slit moves progressively over the plate, if it is too narrow or moving too slowly, it may cause distortion of the images of quickly-moving objects, especially if near the camera, but with due care in regulating the width of the slit and the duration of exposure this is practically not often perceptible, especially if the slit is arranged to move in the same direction as the object.

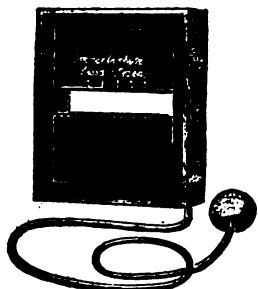

FIG. 64.—Goerz-Anschütz Focal Plane Shutter.

The theory of these shutters is discussed by Coventry (*op. cit.* p. 69), more fully by Fabre (*T. E. P. Suppl.*, C. p. 128), and their practical use in *Focal Plane Photography* ("Photo-Miniature Series," No. 77, 1907).

7. *Moving Blade Central Shutters*.—These shutters, in which two thin metal or ebonite plates or opaque curtains with round or rectangular apertures, or in other cases two curved blades, pass very quickly over each other in opposite directions, are largely used in many patterns fitted between the lenses of a combination or attached to them in front or behind. Formed of two single lateral shutters opening and closing in the centre of the lens aperture, they become central, the exposure taking place during the short period in which the openings are passing each other or the curved blades opening out and closing again. To obtain the greatest efficiency the size of the openings should correspond with the full aperture of the lens. If each plate moves as fast as a drop shutter the combination gives double the speed, corresponding to half the exposure. The sensitive plate will be most evenly and strongly illuminated when the leaves of the shutter work inside the lens near the diaphragm, as in Bausch and Lomb's "Unicum" and other similar between-lens shutters, in general use (fig. 65). This necessitates the fitting of the lens to the shutter, but with adapters



FIG. 65.—Bausch and Lomb's "Unicum" Shutter.



FIG. 66.—Lancaster's "See-Saw" Shutter.

it is possible to fit other lenses. Some forms are, however, suitable for use in front of the lens, such as the "Constant" and Lancaster's "See-Saw" (fig. 66), while those of the double roller-blind type can be used either in front of or behind the lens, though this position is not a favourable one. In these the rectangular form of aperture is the best, circular apertures cutting off a good deal of light, as in the case of drop shutters. W. B. Coventry (*op. cit.* p. 66) has discussed the action of the double roller-blind shutter as typical of the central class of shutters, and shows that while, under similar conditions, with the lateral shutter the effective exposure is constant and the actual exposure variable at all apertures, it is the reverse with the central shutters, and it will not be so easy to calculate exposures with different sized stops. A central shutter, acting as a diaphragm of variable aperture, gives a more efficient exposure than a lateral shutter of the same dimensions, as long as the opening is greater than the lens aperture, the coefficient of illumination of the lens varying as long as the shutter opening is smaller than that of the diaphragm used. It is desirable, therefore, to increase the speed and use as large an aperture as possible, so that the diaphragm used may be entirely uncovered during the greater part of the exposure.

8. *Iris Shutters*.—These are a further development of the double curved blade central shutters, and constructed on the principle of the "Iris" diaphragm, with several leaves opening out from the centre of the lens and closing again. They are usually fitted between the lenses of double objectives, and can be made very light and compact. Theoretically this central position of the shutter is the best, and the "Iris" is the best form for ensuring the most equal distribution of light over the plate, provided, as before, that the opening is equal to the full aperture of the lens. They are made so that the periods of opening and closing may be as short as possible compared with that of full opening. They require great care in construction and fitting to the lens, and so are expensive. They can, however, be used with convertible sets of lenses of different foci fitting the same mount. Several forms are made by British and foreign makers, with three, four or more leaves. Goerz's "Sector" shutter (fig. 67) may be taken as a type. Geogen's "Central" shutter is very light and smooth in working, and can be used in front of a lens for telephoto work. Further details regarding the different forms of shutters, theoretical and practical, will be found in the works by Abney, Coventry, Eder, Fabre and Londe.



FIG. 67.—Goerz's "Sector" Shutter.

Exposure Meters.

When gelatin dry plates came into general use, and were made of many different degrees of sensitiveness, the want of a guide to the proper exposure for the various makes of plates under different conditions of lighting began to be felt, and several methods were devised for meeting it. Some of them depend solely upon data derived from observations of the action of the principal factors affecting the result, namely: (1) the speed of the plate; (2) the actinic power of the sun's light for the time of year in a given latitude and its position at the particular time of day; (3) the effective diaphragm aperture of the lens; (4) the nature of the subject and its illumination as affected by local and atmospheric conditions. With others these data are supplemented by, and practically based upon, actinometric observations of the action of the light upon sensitive paper exposed near the camera or the subject at the time. Both methods are in many cases of undoubted use, but the information given by instruments of this kind can only be considered as approximate, and much is left to the judgment of the operator, whose surest guide will be an intelligent study of the principles on which these instruments are based, together with carefully-recorded observations of the combined working of his lenses, shutters, plates and methods of development under the varying conditions of practical work. Before using any of these instruments it is necessary to know approximately the relative sensitiveness or "speed" of the plate in use. In the early days of gelatin dry plates their rapidities were stated as so many times those of wet plates, or (as they are still) "ordinary," "instantaneous," "rapid" or "extra-rapid," terms which, though suitable for one make of plate, may not be so for others. This was improved upon by the adoption, in 1878, of Leon Warnerke's "Sensitometer," which was in use as a standard for some years. It consisted of a transparent scale of 25 squares of different intensities, marked with opaque numbers and arranged so that each third number indicated a doubled rapidity. This was placed in a frame in front of the sensitive plate, and exposed for thirty seconds to the constant light emitted by a phosphorescent tablet, supplied with the instrument, which was previously excited by burning one inch of magnesium ribbon in front of it. The exposed plate was then developed and fixed, and the highest number visible indicated the rapidity of the plate. In 1890 F. Hurter and V. C. Driffield introduced an entirely new system of calculating the sensitiveness of plates of different rapidities. They make a series of exposures in seconds on different parts of the plate in geometrical progression with a standard candle at one metre distance. After development for a certain fixed period with a standard developer, fixing, washing and drying, the "densities" or logarithms of the opacities of the different parts are measured by a special photometer and plotted on a skeleton diagram, producing a curve, one portion of which will practically be a straight line. The position of this line with reference to a scale of exposures given on the diagram decides the rapidity of the plate, while its length indicates the "capacity" of the plate for the truthful rendering of tone. The elaborate investigations by which these results were obtained are of great interest, and were published in the *Journal of the Society for Chemical Industry* (1890, 1891), and later ones in the *Photographic Journal* (1898). A complete account of the system by V. C. Driffield was published in 1903, as No. 56 of the "Photo Miniature Series." The sensitiveness shown on the H. & D. scale is directly proportional to the speed number given. The method has been adopted by several dry-plate makers in

denoting the sensitiveness of their different brands, and is more or less the basis on which the plate-speeds for the modern English dry-plate actinometers and exposure meters are calculated. Several systems of photometry and measurement of the speeds of dry plates have been discussed at the meetings of the *Congrès International de Photographie*, in 1889, 1891, 1900 and 1905, but no definite standard has been finally adopted. In Germany the use of J. Scheiner's sensitometer has been adopted, and appears to be extending. It is based on a system of photographing the graduated tints given by rotating sectors. A full account of the instrument, and of a system of sensitometry based on its use, is given by J. M. Eder in the *Photographische Correspondenz* (1898) p. 469, and (1900) p. 244. In 1901 Chapman Jones brought out a convenient plate-tester on the same principle as the Warnerke sensitometer, but extended by the addition of a colour sensitometer, which is useful for the comparison of orthochromatic dry plates, colour screens, light filters, &c. It consists of a screen plate, $4\frac{1}{2} \times 3\frac{1}{2}$ in., containing a series of twenty-five tints of graduated densities; a series of coloured squares, blue, green, yellow and red, and a strip of neutral grey, all five being of approximately equal luminosity; a series of four squares of special pure colours, each representing a definite portion of the spectrum; also a space of fine design, over which is superposed a half-tone negative. To use the instrument, a quarter-plate of the brand to be tested is exposed behind the screen for a few seconds to the light of a standard candle placed at the distance of a foot, developed, fixed and washed. An examination of the plate will show the sensitiveness, range of gradation, possible range of exposure, sensitiveness to colour, size of grain, amount of halation, and the most suitable light for development. It can be used for many other tests, and enables any brand of plates to be readily tested by the user and compared with any standard he may find convenient. In making these and similar tests, a standard developer should be allowed to act for a fixed period and at a uniform temperature (*Ph. Journ.*, 1901, 25, p. 246).

The next important factor is the actinic power of the light. It depends normally on the height of the sun for the latitude of the place at the time when the photograph is taken, and exposures in bright sunlight are found to vary approximately as the cosecant of the sun's altitude above the horizon. The light of the sun itself is practically the same at any given time and place year after year, but is liable to more or less local and temporary diminution by the amount of cloud, haze, dust, &c., present in the atmosphere at the time. It is also affected by the time of day, increasing from sunrise to noon, and then decreasing to sunset. The remaining factor is the effective diaphragm aperture of the lens in relation to its focal length. In most cases of ordinary outdoor exposures this can be taken at its normal value, but becomes smaller and increases exposure if the focal length is much increased for photographing near objects. Besides these principal factors, the nature and colour of the objects, their distance, and the amount of light received and reflected by them under various atmospheric conditions, have a great influence on the exposure required. W. B. Coventry has shown (*op. cit.* p. 75) how the "light coefficient L" for full sunlight, can be found, and has given a table of values of L for the latitude of London for every hour of the day in periods of ten days throughout the year, also the relative coefficients for "diffused light," "cloudy," "dull" and "very dull." Tables of exposures for different subjects under varying conditions of light have been published by W. K. Burton, A. S. Platts, F. W. Mills, Sir D. Salomons and others, and in preparing them Dr J. A. Scott's tables, showing monthly and daily variations of light for countries about N. lat. 53°, are generally used. The more modern tables, such as are published in the printed "exposure notebooks," also take into account the plate speeds, but unfortunately there is no uniform standard of plate speeds, owing to the difficulty of fixing a definite standard of light. The subject is fully treated in the *British Journal Almanac* (1901), p. 675, the *Watkins Manual*, H. Bour-sault's *Calcul du temps de pose en photographie*, and similar works by A. de la Baume Pluvinet, G. de C. d'Espinasoux and others.

Based on the same principle as these exposure tables, various portable exposure meters have been brought out, in which scales representing the coefficients for plate-speed, light and diaphragm are arranged as in a slide rule, so that, when properly set, the normal exposure required can be found by inspection, and increased or diminished according to circumstances. In Hurter and Driffield's "Actinograph" the light coefficient is given by a printed card showing the curves for every day in the year and for every hour of the day, the unit being the $\frac{1}{112}$ part of the brightest possible diffused daylight when the altitude of the sun is 90°. The "lens" scale shows the ratios of aperture to focal length in general use, and is calculated for single, double and triple systems of lenses. The "speed" scale is based on the exposure in seconds which with one actinograph degree of light will produce a perfect negative of an ordinary landscape. An additional scale is given for five different degrees of illumination—very bright, "bright," "mean," "dull," "very dull." A table of factors for "views," "portraiture," "interiors," "copying," is also given, and these regulate the figure to be taken for the exposure. The scales are engraved on boxwood, and there are two sliding pieces (fig. 68).

It is specially adapted for use with plates of speed numbers agreeing with the H. & D. scale, but can be used with any plate of which the relative speed number is known. Convenient exposure meters have been made since 1890 by A. Watkins, of Hereford, in different

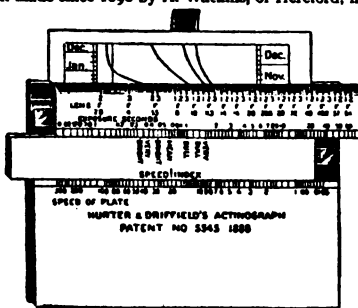

FIG. 68.—Hurter & Driffield's Actinograph.

forms based upon an actinometrical test of the light at the time of exposure. In the complete "Standard Meter" (1890) scales corresponding to "speed of plate," "diaphragm f numbers," "light," "subject" and "enlarging," marked P. D. A. S. and E., are arranged on rings adjustable round a cylinder. The plate-speeds are taken from a table and the "light coefficient," or "actinometer number," is ascertained at the time by exposing a piece of sensitive paper in the actinometer at the end of the instrument for the number of seconds required to match a fixed tint as shown by an attached pendulum. Many improvements have been made in it and the latest pattern (1908) is made in magnalium (fig. 69). The "Dial" meter (1901) is a simpler form in a circular metal case with four apertures marked "plate," "stop," "act" and "exp." above



FIG. 69.—Watkins's "Standard" Meter.

the corresponding scales, and an actinometer for testing the light. The numbers showing the speed of the plate in use, the f value of the diaphragm, and the actinometer exposure in seconds are brought into the respective apertures and the exposure required is read off in the "exposure" aperture. An "indoor meter" is also made, and a "hand camera calculator" for use with the "Standard" or "Bee" meters. The "Queen Bee" and "Bee" meters (1903) are later, smaller and more convenient patterns which have superseded the "Dial" meter and have the plate numbers and exposure marked round the case, and the scales of "f numbers" and "light" on a revolving glass plate. This is revolved till the f number on the right is opposite the speed number of the plate; opposite the "actinometer number" on the left, found as above, will be found the exposure in seconds (fig. 70). The "Queen Bee" meter is similar to the "Bee," but of better construction and fitted with a pendulum.



FIG. 70.—The Watkins's "Bee" Meter.

G. F. Wynne's "Infallible" exposure meter (1893) is also in dial form, but the sensitive paper is exposed directly, no pendulum is used, and the scales are open on the dial. In use, the glass carrying the movable scale is turned until the actinometer time in seconds upon the exposure scale is opposite the diaphragm number of the plate, as given in the list of plate speeds; the correct exposure will then be found against each stop given on the scale. There are practically only two scales: the scale of diaphragms representing the diaphragm apertures or f numbers, the speed of plate and the variation of exposure due to subject; and the time scale, representing the actinometer time and the exposure (fig. 71). The actinometer is protected by a yellow glass screen when not in use. In a smaller form the scales are on the



FIG. 71.—Wynne's "Infallible" Exposure Meter.

circumference of a locket, and the actinometer at the back. An "Infallible" Printmeter is also made for showing exposures in contact printing on sensitive papers, but can also be used for testing speeds of plates and papers. Beck's "Zambex" Exposure Meter gives the exposure and stop to be used, also the depth of focus to be obtained with different diaphragm apertures. The required exposure is set to the "speed" number on the next scale of the meter. The third scale corresponds to the times of darkening the sensitive paper in the actinometer attached to the meter, and shows the diaphragm aperture suitable for the given exposure. Other scales show the distances that will be in focus with the different stops used, arranged so that the focal depth of four different lenses can be found. Several other exposure meters are made on the principle of the slide rule, with scale corresponding to the factors of "plate speed," "diaphragm number," "light," "subject," "exposure," and the exposure is found by simple inspection without an actinometer. They are designed for use with particular brands of plates, but can be used for others of similar speeds.

Another class of exposure meters comprises those in which the intensity of the light is estimated visually by extinction through a semi-transparent medium of increasing intensity, such as J. Décodun's (1888), in which the exposure is judged by the disappearance of a series of small clear openings on a graduated scale of densities when laid on the most important part of the image as seen on the ground-glass. Its indications are not very definite, and the paper scale changes in density after a time. A better form is "E. Degen's Normal Photometer" (1903), consisting of two sliding violet glass prisms, one adjusted for the diaphragm apertures, the other for the actinic illumination of the object. They are mounted with their outer faces parallel. In use the upper slide with prism is drawn out so that the pointer coincides with the division indicating the diaphragm aperture to be used; the object to be photographed is then viewed directly through openings at one end of the instrument, and the lower slide is drawn out and pushed back slowly till the object viewed is almost obscured. The attached pointer will then indicate the exposure required, or, reversing the order, the diaphragm aperture for a given exposure can be found. Auxiliary scales are attached for very short or very long exposures. The principle of construction is that the logarithms of the times of exposure are proportional to the thickness of the coloured prisms. "G. Heyde's Actino-Photometer" (1906) is on a somewhat similar principle, and consists of a circular metal box with dark violet glass viewing screens in the centre of both sides, with an obscuring iris inside the case worked by revolving the back of the box. On the front of the instrument exposure tables are given for plates of every rapidity, and for diaphragm apertures from $f/3$ to $f/45$. Exposure meters of this type are specially applicable for open-air work where there is sufficient light for ready measurement. Other simple actinometers are in use for carbon and process printing, consisting generally of translucent graduated scales in different densities of paper, coloured gelatin, &c., or of a photographed scale, graduated by increasing exposures. The "Burton actinometer," for pigment printing, made on this principle, contains several small negatives of different densities, one of which is selected of equal depth to the one to be printed, and the progress of the printing is estimated by exposing a piece of sensitive paper under it and examining it from time to time.

SENSITIVE PLATES, FILMS AND PAPERS

Sensitive Dry Plates.—A special feature of modern photography is the use of trustworthy ready-prepared sensitive dry plates and films in different grades of sensitiveness, so that there is no necessity for the photographer to prepare his own plates, nor, indeed, could he do so with any advantage. The practice of outdoor and studio photography has thus been very greatly simplified; and although with wet collodion there was the advantage of seeing the results at once and retaking a picture if necessary, the uncertainties connected with the use of the silver bath and collodion, and the amount of cumbersome apparatus necessary for preparing and developing the plates, far outweighed it. There is also an enormous saving of time, in using dry plates as compared with wet, by deferring development. In tropical climates, also, dry plates can be used when work with wet plates would be impossible. On the other hand, the uncertainty of more or less random exposures on ready-prepared plates must not be overlooked. Besides their use in taking negatives, gelatin dry plates are also largely used for printing transparencies, lantern slides, enlargements, &c. For negative work they are prepared with an emulsion in gelatin of silver bromide, alone or with the addition of silver iodide or chloride, and are to be obtained in five or six degrees of rapidity: "slow," for photo-mechanical or "process" work; "ordinary," for general purposes when quick exposures are not required; "rapid," for landscape and portraits; "extra rapid," for instantaneous exposures; and "double extra rapid," for very quick snapshot work in dull weather or for special subjects. These latter kinds are exceedingly sensitive, and require great care in use to avoid fog. In order to prevent halation, or irregular action by reflection from the back surface of the glass, dry plates are coated with a non-actinic "backing," which can easily be removed before development.

Self-developing dry plates were introduced in 1906, in which the developing agent is mixed in the film itself, as in the Ilford "Amauto" plate, which only requires immersion in a solution of washing soda for development, or, as in the Wellington "Watalu" plates, applied on the back of the plate, plain water only being required for development, this application also preventing halation. The slow plates used for printing lantern slides and transparencies are usually prepared with an emulsion of silver chloride with or without free silver nitrate and other haloids.

The rendering of photographic plates isochromatic or sensitive to all colours by dyeing them with eosin, or other suitable dyes, has been greatly improved by the use of new dyes, especially those of the isocyanin group, prepared by Dr E. König of the Hoechst factory, and known as "orthochrom T," "dicyanin," "pinaverdol," "pinachrom" and "pinacyanol," the latter of which can confer on a silver bromide plate as high a degree of sensitiveness for red as erythroin does for yellow; also F. Bayer's "Homocool," Dr A. Miethe's "ethyl red," and other similar dyes (see *E. Jb.*, 1905, pp. 183, 336). Panchromatic plates are now largely manufactured and used for all photographic work in which a true rendering of the relative colour luminosities is essential, and more particularly for the various methods of colour reproduction in which plates are required to be sensitive to red, green and blue-violet. They are made in different degrees of general and colour sensitiveness, according to the purpose for which they are required, the ordinary "isochromatic" being most sensitive for yellow and green, and the "panchromatic" for red, orange and yellow, as well as for green, blue and violet. To obtain the best results from all these plates it is necessary to screen off the blue and violet rays with yellow or orange transparent screens, or colour filters, made of coloured glass, or glass coated with coloured gelatin, collodion, &c., or with glass cells containing solutions of suitable dyes or salts. For the various processes of three-colour reproduction panchromatic plates and special red, green and blue-violet filters have to be used for taking the three negatives, their intensities and absorptions being carefully adjusted to the particular plates in use; the same applies, but less strictly, to the yellow screens used with ordinary isochromatic plates. Dyes specially suitable for these colour-filters have been prepared by Dr E. König. Various kinds of colour screens for ordinary, microscopic and trichromatic work are made commercially, and Messrs Schott of Jena make a special yellow glass in three tints for the purpose.

Plates for Colour Photography.—In 1868 Louis Ducois du Haurois, among various trichromatic methods patented for photographically reproducing coloured objects in the colours of nature, described one in which the trichromatic principle, instead of being carried out on three separate plates, was to be combined in one plate by means of a transparent medium covered by a trichromatic screen divided into narrow juxtaposed lines or minute spaces, corresponding to the three primary colours, red, green and blue-violet, the transparent colour of each of these lines or spaces acting as a colour filter. A sensitive panchromatic plate was to be exposed in contact with this screen to produce a negative with lines or spaces corresponding to the relative strength of the three coloured lights passing through it, so that a dispositive print on glass properly registered with the tricolour screen would show the object in its proper colours. This method could not be carried out successfully for want of efficient panchromatic plates and other difficulties.

Between 1892 and 1898 several patents were taken out by J. W. McDonough and J. Joly for various methods of preparing trichromatic ruled screens (*Ph. Journ.*, 1900, p. 191). The Joly method was fairly successful in action, but had several disadvantages owing to the coarseness of the lines, the necessity for having two screens, one for taking and another for viewing, and the cost of making them (*B. J. A.*, 1899, p. 671). The "Florence" chromatic plate (1905), worked out in America by J. H. Powrie and Florence M. Warner, was an improvement on the Joly method, the colour screen being photographically printed on a glass plate, coated with panchromatic emulsion and exposed to the coloured object through the screen (*Pencross Pictorial Annual*, 1905-1906, p. 111). Some good results were produced, but it has not come into use.

After several years of laborious research, Messrs Lumière, of Lyons, adopting Ducois du Haurois's coloured grain method, succeeded where he had failed, and in 1907 brought out their "Autochrome" plates, in a very complete and practical form, making it possible to produce photographs in the colour of natural objects by one exposure instead of three, as in the ordinary three-colour processes. Glass plates are coated with an adhesive medium over which is spread a mixture of potato starch grains, of microscopic fineness, stained violet, green and orange, the interstices being filled in with fine carbon powder to form a tricolour screen, dark by reflected and of a pinkish, pearly appearance by transmitted light. This is varnished and coated with thin sensitive panchromatic emulsion of gelatin-silver bromide. The plates are exposed in the camera from the back, through the tricolour film, using also a special compensating orange-yellow screen, before or behind the lens, then developed as usual, producing a negative coloured image in the complementary colours, which is then treated and reversed so as to produce a positive coloured image by transmission, showing the picture in its proper colours. The results thus obtained

are remarkably good and practically solve the problem of direct colour photography in a simple and fairly inexpensive manner (see *Agenda Lumiera*, 1909).

In C. L. Finlay's "Thames" colour plate (1908) the tricolour screen is formed by rows of circular dots coloured alternately orange-red and green and the intermediate spaces blue. It is used alone, the coated surface being placed in contact with a panchromatic plate, the uncoated side towards the lens. It carries register marks for adjusting it to the finished picture after development and reversal of the image. These screens, being more transparent than the "Autochrome," require less exposure, but the colour rendering is not so perfect. In the Jouglu "Omnicolore" plate (1909) the tricolour screen and sensitive surface are combined on one plate as in the "Autochrome," but the screen is made up of a series of blue-violet parallel lines, with intermediate alternate broken lines of orange-red and yellowish-green at right angles to them, the red narrower than the green. The relative sizes of the coloured dots in the three plates are approximately:—

"Autochrome" starch grains	3/16 to 5/16 in.
"Thames" plate, dots, diameter	3/16 "
"Omnicolore" plates, blue line	3/16 "
" " " red square	3/16 "

E. Fenake's "Aurora" plate (1909) is a tricolour screen formed by coating a glass plate with a mixture of finely divided particles of gelatin, dyed orange-red, green and blue-violet, without any intervening spaces. The grain generally is coarser and more irregular than in the "Autochrome" plates, but optically corresponds more closely to them than the "Thames" or "Omnicolore" screens do. These plates are issued uncoated for use with any suitable panchromatic plate. A later process is due to Dufay. With the exception of the "Autochrome," these processes are still more or less in the experimental stage.

Celluloid Films.—In order to avoid the weight of glass plates, which may become burdensome on a tour, and also the risk of breakage of valuable records, thin films or sheets of celluloid coated with sensitive emulsions can be used, with great saving of bulk and weight and no loss of efficiency, though such films are sometimes liable to deterioration by long keeping before or after exposure. They are made in two thicknesses, stiff or flexible, the stiff being used exactly as plates, but held in a carrier or simply backed with a card or glass plate, while the flexible are made up in separate sheaths with cardboard backing, as in the "Kodoid" films, or in convenient packages of twelve or more in "film packs" of various patterns. Flexible films of this kind on celluloid have for many years past also been prepared in long strips of different widths suitable for use in hand cameras of the Kodak types and in roll-holders. In the early forms of roll-holders the films were used alone, and being unprotected had to be changed in the dark room, but, as already stated, they are now supplied on spools in cartridges which can be changed in daylight. C. Silvy seems to have been the first to employ this method in 1870. In these cartridges the film is attached to a much longer strip of black paper, and rolled up with it, so that several turns of the paper have to be unrolled before the film is ready for exposure, this point being marked on the outside paper for the successive exposures, with numbers visible through a red screen at the back of the holder. When all have been exposed, the black paper is rolled on for several turns, and when taken out of the holder the loose end is fastened up till the film is developed. As these films are principally used for landscape work, it is now usual to make them isochromatic, and they may be used with or without a yellow screen. They are also made "non-curling" by being coated with gelatin on both sides. Negatives taken on these thin films have the advantage that they can be printed from either side without perceptible loss of definition, which is useful in printing by the single transfer carbon process, and in some of the photo-mechanical printing methods. Flexible transparent films in sheets and rolls have also been prepared upon hardened gelatin, but it is difficult to retain the original dimensions of the film owing to expansion of the gelatin. Paper coated with sensitive emulsions has been successfully used for making negatives in the same way as the celluloid films, and is cheaper, but much more liable to deterioration from atmospheric action before and after exposure, and unless developed soon after exposure the impressed images may fade and become undevelopable. Such papers are, however, still used in meteorological and other self-recording instruments. Stripping films of thin celluloid upon a paper support were introduced by Messrs Wellington and Ward, and had advantages for printing from either side, but are not now made.

Photographic Printing Papers.—*Pari passu* with the supply of ready-prepared plates, all kinds of photographic printing papers can now be obtained ready for use, so that the photographer has nothing to do with the preparation of his sensitive plates or papers. The old albuminized papers have been generally superseded by ready-prepared sensitive papers coated by machinery with emulsions of silver haloids in gelatin, with or without citrate or other organic silver salts, the chloride being used for most of the "P.O.P." or "printing out papers," which contain more or less free silver nitrate, and in the "self-toning" papers some salt of gold. Some of these printing out papers are also made with emulsions of silver

chloride in collodion, and known as "C.C." or "collochloride." The basis of most of the developable bromide papers used for enlargements and direct copying, containing no free silver nitrate, and with which an invisible image is brought out by development, much in the same way as with dry plates, is silver bromide. These papers are made in great variety of tints and surfaces, "smooth" and "rough," "glossy" and "mat," for producing different effects. They are largely used for direct printing by artificial light or daylight, for enlargements; and for printing photographic post-cards, &c., in large numbers by machinery, the prints being made on a long band with an almost instantaneous exposure, and developed and fixed by being passed through the proper solutions on large rollers or otherwise. Papers for the platinotype processes, sensitized with salts of platinum and iron, are also manufactured for printing out entirely or for development with potassium oxalate. Prints on these papers have the advantage of being permanent.

Messrs York Schwartz and J. Mallabar's process of developing and toning prints made on a special sensitive paper prepared with an emulsion of silver phosphate was introduced by Messrs Houghton in 1908 under the name of "Ensyna." Very short exposures to day or artificial light are required, and with a special developer ("Ensynoid") permanent prints are obtained with a varied scale of tones similar to those given by toning with gold, the colour of the print being determined by the exposure, short exposures giving purple and long exposures brown or reddish tones. The process is a rapid one, the operations of printing, developing, fixing and washing being completed within about ten minutes or even less.

For the various methods of printing in permanent pigments ("Autotype," &c.) tissues are prepared coated with pigmented gelatin in various colours, and very successful results in colour photography have been obtained by printing from suitable negatives in three colours with specially prepared yellow, blue and pink tissues. Similar papers, prepared with pigmented gum instead of gelatin, are used in the "gum bichrome" process, and "single transfer" papers, coated with plain gelatin, are used in the pigment printing processes to receive the developed print, and are also useful for photo-lithography, the new "oil-printing" methods and in trichromatic printing on paper by the Sanger-Shepherd method and Dr König's "Pinatype." For Manly's "Onotype" and "Osobrome" processes special gelatinized and pigmented papers are made. "Cyanotype" and "Ferrogallic" papers are prepared for the use of architects, engineers, &c., in rolls of considerable width, for the direct reproduction of tracings and drawings as blue or black prints by these and similar methods.

Apparatus for Development.—The recognition of the fact that the two principal factors in the development of modern photographic dry plates with a suitable developer are time and temperature, and also that a prolonged immersion in dilute solutions is in many cases a more convenient and equally efficient method of development, has led to the construction of apparatus for enabling the operation to be carried out almost automatically and for timing its duration.

In 1894 A. Watkins brought out his factorial system of development based on the principle "that with a correct exposure on a given plate with a given developing agent, the time of development required for a given printing opacity has a fixed arithmetical ratio to the time of appearance of the high lights of the image, provided the developing power of the solution remains constant during development; and this rule holds good for all variations of strength, amount of alkali or bromide, and temperature within those limits which have been found safe in practice" (*Photo. News*, 1894, 38, pp. 115, 729; and further, *Ph. Journ.*, 1900, 24, p. 221). By a series of observations he ascertained the multiplying factors of most of the developers in ordinary use, and in 1905 brought out his "factorial calculator" and a "dark-room clock" for facilitating the working of the method. The former is made of aluminium, and consists of two circular disks, the upper smaller one rotating and carrying a pointer. The outer disk is marked with a scale of Watkins' factors for the different developers, as given in the "instructions" accompanying the instrument, and is used to denote the "time of development" in minutes. The scale on the inner



FIG. 72.—Watkins' Factorial Calculator.



FIG. 73.—Watkins' Dark-room Clock.

disk shows the "time of appearance" in seconds or minutes: In use the pointer is set to the factor for the developer in use, and against the "time of appearance" on the inner scale will be found the total number of minutes required for complete development (fig. 72);

The "calculator" can be used with any ordinary clock or watch, but the "dark-room clock" (fig. 73) has been specially constructed for the factorial system. It is an improvement on the earlier forms of Watkins' "Eikronometer," and has a 4 in. dial with 10 minute and 100 seconds divisions, very plain for dark rooms, centre seconds hand, stop action and outside indicator to mark the completed time. The seconds hand completes the revolution in 100 seconds, while the minute hand does so in 10 minutes, or sufficient for the longest ordinary development, though it runs on, if necessary, very much longer, both hands starting together always at 0.

In 1908 Watkins brought out another system of "thermo-development" by time dependent on the use of a standard "time developer," the duration of the development, at a given temperature, being modified according to the make and speed of the particular plate in use. The temperature variations are indicated by a movable scale, or "thermo-calculator," on the bottle of developer, the variations for development speed of various plates being given approximately on the "Watkins' Plate Speed List," which thus shows the "speed of plate" and "speed of development" with the standard developer at 60°. This method is well adapted for plates, films and stand development in tanks or machines, no observation of the plate being required, and the times are most conveniently observed with the "dark-room clock." Full details of these two distinct methods of development will be found in the 4th edition of the *Watkins' Manual of Exposure and Development*.

C. W. Piper's "photographer's stop clock" (1906) is a more elaborate clock, intended for use not only in "time development" but for all photographic operations in which accurate control in regard to time is of importance. It is fitted with a gong and arranged to work by "time" or "bulb." Once started, by pressure on a lever or on the bulb, it will continue to go until stopped, striking the gong at the completion of every minute, when the seconds hand reaches the zero point. A second pressure on the bulb stops the clock, so long as the pressure is continued, while pressure on a lever stops it permanently. It is thus useful for timing any intermittent operations, whilst the clock adds up the separate times and prevents the occurrence of errors difficult to avoid when timing with an ordinary watch. By an additional attachment a prolonged time exposure with the camera may be terminated, or an "instantaneous" or short "time" exposure given at any prearranged time. Messrs Houghton's "Ensign" clock for time development has a dial with 60 divisions, a single hand, and is fitted with a gong. It can be set to ring an alarm bell at the expiration of any period from one minute to one hour, can be started or stopped immediately and is easily read in the dark-room. It requires no winding up, the action of setting providing the tension for the recording movements. It can be stopped and started at will and the bell arranged to give a short or prolonged ring. S. Stanley's is another convenient form, with a 4½ in. dial, divided into 60 seconds and 60 minutes, the thick hand recording the seconds and the thin hand the minutes.

Several forms of developing tanks and machines have been constructed for developing a number of exposed plates, together with ordinary or dilute developers, with the aid of the factorial system or independently of it. The Kodak "Automatic Developing Tank" (1905) is a useful arrangement by which bands of exposed roll films can be developed in daylight, without any need of a dark-room (fig. 74). The exposed film is wound from the spool

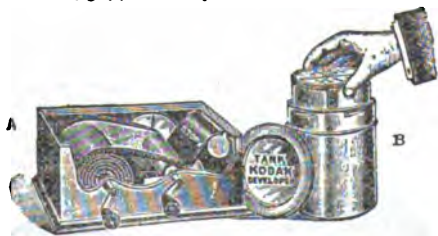

FIG. 74.—Kodak Developing Tank.

into a red celluloid apron contained in a box A, then placed in the tank B, where it is left in a dilute developer for about twenty minutes, and requires no attention. It gives very good results. For the "Brownie" films a special daylight developing box is made. With the Kodak "Eastman Plate-developing Tank" (1908) the exposed plates are removed in the dark-room, from the plate holders and placed, in pairs back to back, in a special framework holding six pairs, which is lowered into a metal tank containing the developer, and is fitted with a watertight lid so that it can be inverted during development. A clock face, with pointer, by which the period of development may be noted is fitted outside the tank. Another apparatus of the kind is made for developing celluloid films exposed in the "Premo Film Packs" (fig. 75).

Other forms are made, and in some the fixing and washing can also be effected. These tanks undoubtedly save much time and trouble in developing a large number of exposed plates or films, and have been found to work with efficiency and regularity. Eastman Kodak Co. brought out in 1907 a machine for developing paper prints on bromide or gaslight papers.



FIG. 75.—Premo Film Pack Tank (1908).

PHOTOGRAPHIC PRINTING APPARATUS

For ordinary printing purposes pressure frames, with or without glass fronts, are used for holding the negative and sensitive paper in close contact during exposure to light. They are fitted with hinged backs enabling the progress of the printing to be seen. The pressure is usually given with springs or with screws or wedges acting on the back. They are made in different kinds shown in the dealers' catalogues. For copying large tracings and engineers' drawings by the cyanotype and similar processes large glazed frames are used, mounted on a stand with axle, so that they may be easily turned over for refilling or fixed at a suitable angle to the light. The pressure is given by an elastic cushion or vacuum arrangement, by which air is pumped out from under an indiarubber sheet covering the back of the frame, thus securing a perfectly uniform pressure of about 14 lb to the square inch without strain on the front glass. Such frames are also useful for various photo-mechanical printing processes with large negatives or metal plates.

For rapid printing of post-card and other negatives up to 8½ X 6½ in. a handy and simple apparatus the "Rapide" has been brought out, consisting of a lantern fitted for oil, gas or electric light, with a sloping front, in which a special printing frame is fixed and arranged so that the prints can be rapidly exposed one after another (*B. J. A.* 1909, p. 691). In another form arrangements are made for exposing a large number of printing frames on a suitable stand, in one or two tiers round a central arc lamp, which may be provided, as in the "Westminster" revolving printing frame, with a shade to protect the eyes of the operator when examining the prints or changing the frames.

For printing tracings, &c., in long rolls, cylinder and rotatory machines of various types are used, so that the tracing and sensitive paper may be drawn together at a regulated speed in close contact round a glass cylindrical surface within which electric arc or mercury vapour lamps supply the source of light. Several machines of this kind are described in *Eder's Jahrbuch* for 1908, also in the patent records and photographic journals.

AUTHORITIES.—*Apparatus in general:* Sir W. de W. Abney, *Instruction in Photography* (11th ed., 1905); R. C. Bayley, *The Complete Photographer* (1906); Dr J. M. Eder, *Ausführliches Handbuch der Photographie* (2nd ed., pt. i. (2), 1892); *Jahrbücher für Photographie und Reproductions Technik* (E. Jb.), (1887-1908). Valuable for reference on all forms of apparatus: Dr C. Fabre, *Traité encyclopédique de photographie* (T. E. P.) (vol. I., 1889; *Supplément* s A, 1892; B, 1897; C, 1902; D, 1906), also gives much information about photographic apparatus and optics; Chapman Jones, *An Introduction to the Science and Practice of Photography* (4th ed., 1904); *British Journal Photographic Almanacs* to 1909 (*B. J. A.*); Patent Office, *Abridgments of Specifications*, class 98, "Photography"; *Photography Annals* (1891 to 1899); *Photographic Journal* (*Ph. Journ.*); *Year Books of Photography* to 1907.

Lenses and Optics: C. Beck and A. Andrews, *Photographic Lenses* (6th ed.); W. K. Burton, *Optics for Photographers* (1891); R. S. Cole, *A Treatise on Photographic Optics* (1899); T. R. Dallmeier, *Telephotography* (1899); I. A. Hodges, *Photographic Lenses* (1895); Captain Houdaille, *Sur une méthode d'essai scientifique et pratique des objectifs photographiques* (1894); G. L. Johnson, *Photographic Optics and Colour Photography* (1909); O. Lummer, *Contributions to Photographic Optics*, translated and augmented by Professor S. P. Thompson (1900); Dr A. Miethe, *Optique photographique sans développements mathématiques*, translation by A. Noaillon and V. Hauerdtter (1896); Lieut.-Colonel P. Moessard, *L'Optique photographique* (1898); *L'Objectif photographique* (1899); C. W. Piper, *A First Book of the Lens* (1901); Dr M. von Rohr, *Theorie und Geschichte des photographischen Objectivs* (1899), a most valuable theoretical and historical summary of photographic optics and its literature; Hans Schmidt, *Das Fern-Objectiv im Porträt- Architekt- und Landschaftsfache* (1898); Dr H. Schroeder, *Die Elemente*

der photographischen Optik (1891); J. T. Taylor, *The Optics of Photography and Photographic Lenses* (3rd ed., 1904); The "Photo-Miniature Series," No. 1 (1899), *Modern Lenses*, No. 26 (1901), *Telephotography*; No. 36 (1902), *Lens Facts and Helps*; No. 79 (1907), *The Choice and Use of Photographic Lenses*.

Hand Cameras, Shutters, Exposure Meters, &c.: Sir W. de W. Abney, *Instantaneous Photography* (1895); H. Couvroult, *Calcul du temps de pose en photographie* (1896); W. B. Coventry, *The Technique of the Hand Camera* (1901), the working principles of lenses, shutters, &c., for instantaneous exposures, are treated mathematically and practically; L. David, *Die Moment-Photographie* (1898); G. de Chapel d'Espinasoux, *Traité pratique de la détermination du temps de pose* (1899); Dr R. Krügener, *Die Hand Camera und ihre Anwendung für die Moment-Photographie* (1898); A. Londe, *La Photographie instantanée, théorie et pratique* (3rd ed., 1897); F. W. Pilditch, *Drop-Shutter-Photography* (1896); A. de la Baume Pluvinel, *Le Temps de pose* (1890); A. Watkins, *The Watkins Manual of Exposure and Development* (4th ed., 1908). *The Practical Photographer*, No. 8 (1904), "Hand Camera Work." The "Photo-Miniature Series," No. 3 (1899), *Hand Camera Work*; No. 37 (1902), *Film Photography*; No. 56 (1903), *The Hurler and Drifted System*; No. 76 (1906), *The Hand Camera*; No. 77 (1907), *Focal Plane Photography*.

Colour Photography: Agenda Lumière, *La Photographie des couleurs et les plaques autochromes* (1909); G. E. Brown and C. W. Piper, *Colour Photography with the Lumière Autochrome Plates* (1907); Baron A. von Hübl, *Three Colour Photography*, translated by H. O. Klein (1904); *Theorie und Praxis der Farben Photographie mit Autochrom Platten* (1908); G. L. Johnson, *Photographic Optics and Colour Photography* (1909); Dr E. König, *Natural Colour Photography* (trans. by E. J. Wall (1906); *Die Autochrom Photographie und die verwandten Dreifarbenraster-verfahren* (1908). (J. Wa.)

III.—PICTORIAL PHOTOGRAPHY

Pictorial photography differs from other branches of photographic practice in the motive by which it is prompted. Employing the same methods and tools, it seeks to use photographic processes as a means of personal artistic expression. Thus in the early days of Fox Talbot's calotype, about 1846, David Octavius Hill, a successful Scottish painter, took up this method of portrayal, and, guided by an artist's knowledge and taste, and unfettered by photographic convention, which indeed had then scarcely begun to grow, produced portraits which for genuine pictorial quality have perhaps never been surpassed, especially if some allowance be made for the necessary imperfections of the "Talbotype" (see Plate II). Whether they were in their day typical examples of Talbotype with all the latest improvements, Hill probably never cared. When, again, a few years later, Sir William J. Newton, the eminent miniature painter, read a paper before the newly formed Photographic Society of Great Britain (now the Royal Photographic Society), his recommendation to depart from the custom of defining everything with excessive sharpness caused his address to be almost epoch-making. "I do not conceive it to be necessary or desirable," he said, "for an artist to represent, or aim at, the attainment of every minute detail, but to endeavour at producing a broad and general effect. . . . I do not consider that the whole of the subject should be what is called 'in focus'; on the contrary, I have found in many instances that the object is better obtained by the whole subject being a little out of focus." The doctrine has been persistently repeated ever since, but only within the last decade of the 19th century was the suppression or diffusion of focus received by photographers generally with anything better than ridicule or contempt, because it was unorthodox. O. G. Rejlander, Mrs Julia Margaret Cameron, H. P. Robinson, and others, by precept or practice, strove against such photographic conventions as had arisen out of those technical exigencies to which pictorial qualities were so often sacrificed. As late as 1868, in the *Manual of Photographic Manipulation*, by Lake Price, the old advice to arrange a group of persons in crescent form, so as to adapt the subject to the curve of the field of the lens, was repeated with the additional recommendation of plotting out on the ground beforehand the "curve of the focus" as a guide. As a defiance of this dictum, Rejlander, in 1869, produced a group of the members of the Solar Club in which some of the chief figures were set widely out of the "curve of the focus." The mere technical difficulties of this performance with wet collodion plates, and in an ordinary upper room, need not be touched upon

here, but it is to be noted as one of those triumphant departures from convention which have marked the progressive stages of pictorial photography. At about the same period, Mrs Cameron, carrying the recommendation of "a little out of focus" rather further, regardless of how her lens was intended to be used by its maker, secured the rendering dictated by her own taste and judgment, with the result that many of her portraits, such as those of Tennyson, Carlyle, &c., are still in their way unsurpassed. Contemporaneously, Adam Salomon, a talented sculptor, "sunned" down the too garish lights of his photographic prints, and strengthened the high lights by working on the back of the negative.

But, during the concluding quarter of the 19th century, probably the most powerful influence in pictorial photography was that of H. P. Robinson, who died in February 1901, and, but for a brief period about the year 1875, was one of the most prolific "picture makers." Inspired by Rejlander, of whom he was a contemporary, Robinson will perhaps be best remembered by his earlier advocacy of combination printing. As early as 1855 Berwick and Annan exhibited a photograph which was the result of printing from more than one negative, a figure from one plate being cunningly introduced into a landscape print from another. Then came from Rejlander "The Two Ways of Life," in which, with wonderful ingenuity, thirty different negatives were combined. Robinson followed, and between 1858 and 1887 exhibited numerous examples of combination-printing, one of the most popular and fairly typical examples being "Carolling" (see Plate I), which received a medal in the exhibition of the Royal Photographic Society in 1887.

Though in this combination-printing one may perhaps perceive the germ of incentive towards the production of special effects not seen in the original, yet the practice was not destined to become very popular, for even in the most capable hands there remains the difficulty, if not impossibility, of fitting a portion of one negative into a print from another and still preserving true relative tonality, and even true proportion. Skillfully produced, eminently popular in character though "Carolling" may be, such errors are not absent. Of this combination-printing Dr P. H. Emerson has said: "Cloud printing is the simplest form of combination-printing, and the only one admissible when we are considering artistic work. Rejlander, however, in the early days of photography, tried to make pictures by combination-printing. This process is really what many of us practised in the nursery, that is, cutting out figures and pasting them into white spaces left for that purpose in the picture-book. With all the care in the world the very best artist living could not do this satisfactorily. Nature is so subtle that it is impossible to do this sort of patchwork and represent her. Even if the greater truths be registered, the lesser truths, still important, cannot be obtained, and the softness of outline is easily lost. The relation of the figure to the landscape can never be truly represented in this manner, for all subtle modelling of the contour of the figure is lost."

Pictorial photography received a large accession of votaries in consequence of the greater facilities offered by the introduction of the gelatino-bromide, or dry-plate, process, which, although dating from 1850, did not notably affect photographic communities until some years afterwards; and although improvement in appliances and instruments had little to do with the advance of the pictorial side of photography, yet, indirectly at least, the dry-plate and the platinotype printing process have had an undoubted effect. The former gave enormously increased facility, and dispensed with tedious manipulations and chemical knowledge, while its increased light-sensitiveness decreased the limitations as to subjects and effects. The platinotype process was discovered in 1874-1880 by W. Willis, who employed his chemical skill and knowledge to give the world a printing process more likely than the hitherto prevalent silver papers to satisfy artistic requirements.

Up to 1882 but few outdoor photographers had ventured to run counter to the general dictum that photographs should only be taken during sunshine or good bright light, and unquestioning

consent would have been given everywhere to the proposition that it would be absurd to work when anything like fog or atmospheric haze was present. Isochromatic plates, introduced for the purpose of equalizing the actinic power of various colour luminosities, and so rendering colours in correct relative value, were recommended by one writer, who applauded their supposed advantage of enabling the photographer to photograph distance without any suggestion of atmosphere. That evening or morning haze might enhance the beauty of a landscape, or that the mystery of half-concealment might itself be beautiful, does not seem to have occurred to the photographer, who had become infatuated by the exquisite clearness and sharpness which, with a minimum of labour, he was able to achieve. It is therefore interesting to note one of the first photographic successes which broke away from this convention, just as Rejlander's Solar Club group defied the formula of arranging human figures like the tiers of an amphitheatre. William M'Leish, of Darlington, a Scottish gardener who had taken to photography, and who seems to have been less under the influence, or it may have been that he was ignorant, of the old *dicla*, sent to the Royal Photographic Society's Exhibition in 1882 a photograph entitled "Misty Morning on the Wear," a very beautiful view of Durham Cathedral as seen through the mist from across the river. The judges, although they that year awarded eleven medals, passed this by; but appreciation came from outside, for newspaper critics, and practically all those who were not blinded by prejudice and conventionality, declared it to be the photograph of the year. The exhibitions immediately succeeding revealed numerous imitators of M'Leish, and both figure and landscape work began to be shown in which there was evidence of greater freedom and originality.

Meanwhile the Photographic Society of Great Britain had drifted away from its artistic starting-point, and had become chiefly absorbed in purely scientific and technical subjects. But the general apathy which existed in respect of the artistic aspirations of some workers was the forerunner of a period of renaissance which was to end in lifting the pictorial side of photography into a greatly improved position. In 1886 Dr P. H. Emerson read before the Camera Club a paper on "Naturalistic Photography," which served as an introduction to the publication (1887) of his book under that title. Unquestionably this book struck a powerful blow at the many conventionalities which had grown up in the practice of photography; the chief doctrines set forth being the differentiation of focus in different planes, a more complete recognition and truer rendering of "tone," a kind of truthful impressionism derived from a close study and general acquaintance of nature, and a generally higher and more intellectual standard. After the publication of a second edition in 1889 Dr Emerson publicly renounced the views he had published, by issuing in January of 1891 a bitterly worded, black-bordered pamphlet, entitled *The Death of Naturalistic Photography*. But the thoughts which the book had stirred were not to be stilled by its withdrawal. Towards the end of the same year the conflict which within the Photographic Society had become apparent as between the pictorial enthusiasts and the older school, culminated in connexion with some matters respecting the hanging of certain photographs at the exhibition of that year; and a number of prominent members resigned their membership as a protest against the lack of sympathy and the insufficient manner in which pictorial work was represented and encouraged. This secession was to prove the most important event in the history of that branch of photography. The secessionists being among the most popular contributors to the annual exhibition gathered round them numerous sympathizers. In the following year they formed themselves into a brotherhood called "The Linked Ring," and in 1893 held their first "Photographic Salon," at the Dudley Gallery, Piccadilly. The most noteworthy of the early adherents attracted to the new body was James Craig Annan, whose work was practically unknown until he exhibited it at the first Salon; and almost at once he, by general consent, took a position amongst pictorial photographers second to none (see Plate II).

Aroused into greater activity by these events, the Royal Photographic Society began to pay more attention to what had now become the more popular phase. At subsequent exhibitions the technical and scientific work was hung separately from the "Art Section," and a separate set of judges was elected for each section. It became the custom to allot by far the greater amount of space to the "artistic"; and later, artists were elected as judges, by way of encouraging those who were devoted to the pictorial side to send in for exhibition. In the autumn of 1900 the New Gallery was secured, and a comprehensive exhibition of all phases of photography was held.

It is interesting to note that as a distinct movement pictorial photography is essentially of British origin, and this is shown by the manner in which organized photographic bodies in Vienna, Brussels, Paris, St Petersburg, Florence and other European cities, as well as in Philadelphia, Chicago, &c., following the example of London, held exhibitions on exactly similar lines to those of the London Photographic Salon, and invited known British exhibitors to contribute. The international character of the "Linked Ring" encouraged an interchange of works between British and foreign exhibitors, with the result that the productions of certain French, Austrian and American photographers are perfectly familiar in Great Britain. This, in the year 1900, led to a very remarkable cult calling itself "The New American School," which had a powerful influence on contemporaries in Great Britain.

It may be well to glance at such improvements of process or apparatus as have not been direct and essential means to pictorial advance, but rather modifications and improvements made in response to the requirements of the artistic aspirant. Such improvements are of two orders—those which are devised with the aim of securing greater accuracy of delineation, the correction of distortion and of apparent exaggeration of perspective, and the more truthful rendering of relative values and tones; and those which seek to give the operator greater personal control over the finished result. While great advances have been made in photographic optics, it cannot be said that pictorial work has been thereby materially assisted, some of the most successful exponents preferring to use the simplest form of uncorrected objective, or even to dispense with the lens altogether, choosing rather to employ a minute aperture, technically called a "pinhole." This is but one example of many which might be quoted to bear out the statement that in photography the advance of anything in the nature of artistic qualities has not been correlative with mechanical improvements. The hand camera can only be said to have had an indirect influence: it has increased the photographer's facilities, and by removing the encumbrance of heavy tools has widened his sphere of operations; but it is perhaps in connexion with the plates and printing processes that more direct advantages have been gained. The fact that the actinic power of colours is not proportional to their luminosity was long regretted as an obstacle to correct representation; but by the introduction of orthochromatic or isochromatic plates in 1866 (when B. J. Edwards bought the Talfer and Clayton patent, under which he shortly brought out his orthochromatic plates) this original disability was removed; while with increased rapidity in the isochromatic plate colour values may still further be corrected by the use of coloured screens or light filters, without interfering with the practicability of making sufficiently rapid exposures for most subjects. Again, by a better knowledge of what is required in artistic representation, certain modifications in the formulated treatment of ordinary and uncorrected plates are found to do much towards removing the evil; hence, with an ordinary plate "backed" so as to counteract over-exposure of the higher lights, an exposure may, except in extreme cases, be given of length sufficient to secure the feeble rays of the less actinic colours, and by subsequent suitable development a result hardly distinguishable from that of a colour corrected plate may be secured. Chemical experiment has placed in the photographer's hands improved and easier means of entire, unequal and local intensification and reduction, but utility of these is restricted. By the artistic worker it is claimed that the lens and camera are but the tools, and the negative the preliminary sketch or study, the final print standing to him in the same relation as the finished painting does to the artist. In the production of the print various means of personally controlling the formation of the image have been resorted to. Thus the local development of platinumotype by means of glycerine has its champions, but it seems to have been little used, its resuscitation being chiefly due to two or three prominent workers in New York. Here should also be mentioned the revival in 1898 of rough-surface printing papers, chiefly those sensitized with silver, the roughest texture drawing paper being employed to break up the excessive sharpness of the photographic image, and by the superficial inequalities introducing the effect

of luminousness to over-dark shadows and variety to blank whites. The almost forgotten process of Poncey, and of Pottevin, now known as the gum bichromate process, was rehabilitated in 1894 by M. Rouille Ladevezze expressly to meet the needs of the celestial worker. Perhaps the best results that have been achieved by it are those of M. Robert Demachy of Paris, though many English workers have used it with remarkable success. In it paper of any kind may be selected as the support. The power of the operator to modify the printed image to almost any extent, even to introducing and eliminating lights and shadows, and in other ways to depart widely from the image given by the negative, depends upon the fact that the coating of gum and pigment (which, being bichromatized, becomes insoluble in proportion as it is acted upon by light) holds the pigment but imperfectly, and yields it up upon a vigorous application of water. According, therefore, to its application or retention, the operator can lighten or deepen in tone any portion. Numberless variations of other methods, such as brush development and local toning or stopping, have been suggested with the same object. Other workers have shown that by dexterously shutting off and admitting the light to various parts of the negative whilst printing, the disposition of the lights and shades in the print can be modified to so great an extent as to alter the general contour of the scene. Examples of an original unaltered print, and one which has been thus modified, are shown in the accompanying plate. Portions are shaded in by allowing the light to have access to the print, either through the negative—in which case the image with all its details, prints more deeply—or by removing the negative, when the action of the light is to flatten and suppress both detail and contrast. Lately some few have resorted to extensive working on the negative, both on the base and on the film; drawing by hand is practised on the film to render too prominent features less obtrusive, and objects in the background are merged by an intricacy of lines and cross-hatching. Many of the results are very pleasing, although one hesitates to justify the means, however good the end. On the other hand, to exclaim for purity of method and the exclusion of extraneous aids is very like setting up an arbitrary standard no less unreasonable than those conventions against which pictorial photography has so long striven.

AUTHORITIES.—P. H. Emerson, *Naturalistic Photography*; H. P. Robinson, *Picture-making by Photography*; *Art Photography*; *Pictorial Effect in Photography*; *Elements of a Pictorial Photograph*; A. H. Wall, *Artistic Landscape Photography* (1896); A. Horsley Hinton, *Practical Pictorial Photography* (1898), and subsequent editions; C. Puyo, *Notes sur la photographie artistique* (Paris).

(A. H. H.)

PHOTOGRAPHY, CELESTIAL. The requisites for celestial photography are best explained by a comparison with ordinary photography in several essential points.

a. Illumination.—In taking a portrait artificial light is used, being thrown on to the face of the sitter either directly or by reflection. If the day is dull a longer exposure is required, and artificial light may be used when the daylight fails. In photographing the stars there is no question of illuminating them by artificial light; for the strongest searchlight which we could throw in the direction of the heavenly bodies would have no sensible effect. The light used is their own, and its feebleness renders it necessary to make long exposures, the length increasing as we attempt to get images of fainter objects. The invention of the dry plate, by making it possible to give very long exposures, caused a revolution in celestial photography. With the wet plate, exposures were limited to the few minutes during which the film would remain wet; but the dry plate can remain in the telescope for days, weeks or even years if necessary. On the approach of daylight, the cap is put on the camera, or the plate removed into the dark room; but when night returns the plate is put back in the telescope, which is accurately pointed to the same stars, the cap is removed, and the exposure is resumed without any loss from the interruption.

b. Magnification.—In taking a portrait we can obtain a large or small size by placing the camera near the sitter or far away. But this method is not available for the heavenly bodies, since we cannot sensibly approach them. To magnify an image we must lengthen the focus of the camera, either directly or indirectly. The *direct* method is to construct a lens or mirror of long focus; the camera becomes similar in length to a telescope; and indeed resembles a telescope in other respects, except that we take away the eye-piece and put in a photographic plate instead. If, however, we already have a lens of short focus which we wish to use, we may lengthen the focus *indirectly* by using a secondary magnifier, that is by putting in another lens near the focus of the first. In either case the profitable magnification

is limited, not only by the imperfections of the optical apparatus but by disturbances in the atmosphere. Air currents, either outside or inside the telescope, act as irregular lenses of varying shape, and produce such defects in the image that we gain nothing by enlarging it beyond a certain point. Such air disturbances do not trouble the ordinary photographer at all, or scarcely at all: he is only concerned with a few feet of air, whereas the celestial photographer cannot escape from the necessity of looking through many miles of it.

c. Steadiness.—In taking a portrait the photographer is only concerned to fix his camera firmly and to induce his sitter to remain still. The heavenly bodies are in constant motion, though their real and apparent movements are fortunately smooth, except for air disturbances above mentioned. If, therefore, it were possible to devise perfectly smooth clockwork, we could keep the camera or telescope continually pointed to the required star or stars. But human workmanship has not yet made clockwork of sufficient strength and accuracy to keep a large telescope satisfactorily pointed. The clockwork which had been found good enough for use with visual telescopes was soon found to be quite inadequate for photography. The first method adopted was to bind two telescopes, one visual and the other photographic, firmly together; and by looking through the visual one to keep some object steadily on the crosswires by using the slow motion screws; meanwhile the other telescope was kept properly pointed for taking a photograph. As it was sometimes found that extremely fine movements were required, electrical arrangements were devised, whereby the observer, on simply pressing a button, could accelerate or retard the rate of the clockwork by a minute amount, instead of actually turning the screws by hand. And about the same time the idea arose of making these corrections automatically. This automatic correction is based on the principle that a freely swinging pendulum, which has no work to do, will naturally keep much better time than the clockwork which has to drive a heavy telescope; and if such a pendulum is therefore arranged to send a current every second through certain electro-magnets, apparatus can be devised to detect whether the clockwork is going properly; and to correct it in the right direction, if it is not. One or more of these three methods, which may be called hand-guiding, electrical control, and automatic electric control, are used in taking all celestial photographs.

The Photographic Image.—The image of a star on the plate should be, theoretically, merely a point; but in practice it is a small patch on the plate which grows in size as the exposure is lengthened, while at the same time it becomes darker in the middle. One reason for this is that light is many-coloured, and when we attempt to focus it by a lens, we can only get a very few colours into even approximate focus; the other colours are not brought to focus at all, and form concentric patches of fainter light on the plate, which increase in size with the error of focus. Thus at best our focusing is only a compromise. When the exposure is short, those colours which have most nearly been brought to focus have an effect, while the faint light of the others may produce no sensible impression. It is natural to select for the colours to be brought most sharply to focus those which are most important photographically, viz. those at the violet end of the spectrum. As the exposure proceeds the faint light of the other colours affects the plate by accumulation, and hence the image spreads, while at the same time, the central part naturally becomes blacker.

A reflecting telescope brings all colours to the same focus; and it might appear, therefore, that images formed with it will not spread in this way. There is, however, another cause of spreading besides that due to colour; neither the reflecting telescope nor the lens can focus all the light received by them for more than one particular star. It is just theoretically possible to construct a mirror which would focus all the light from a star seen in the direction of its axis, but the light from another star seen in a slightly different direction would not be truly focused, since directly we leave the axis, some parts of the mirror have a focus slightly different from other parts; and if the image

produced is magnified, it is seen to have a shape like that of a kite. As the exposure is prolonged the small kite-shaped figure gradually increases in size from the point towards the head, and this defect is the more pronounced the farther we depart from the centre of the plate. The result is, speaking generally, that the images near the centre of a plate may be fairly small and circular, but at a certain distance from the centre they become distorted and large. It is a practical problem of great importance to have this distance as great as possible, so that the field of good definition may be large. Estimating in terms of angular distance from the centre of the field, the reflecting telescope has a good field of not more than $40'$; a telescope with one compound lens (the ordinary refractor) a field of about $1'$, while if two compound lenses are used (as is the case in portrait photography) the field may be very greatly extended, $10''$ or $15''$ having been successfully covered. This is naturally a very great advantage of the "doublet" over other forms of telescope, an advantage which has only recently been fully realized. But there is a compensating drawback; to get a large field we must either use a large plate, which is liable to bend or to have a permanent curvature; or if we use a small plate the picture will be on a small scale, so that we lose accuracy in another way.

Star Charts may thus be made by photography with any desired combination of these advantages. The Cape Photographic *Durchmusterung* is a photographic survey of the southern hemisphere by means of 250 plates each covering $5^\circ \times 5^\circ$ taken at the Royal Observatory, Cape of Good Hope; the plates being afterwards measured at Groningen in Holland by Professor J. C. Kapteyn who recorded the places to O'' and $O'.L$. A much higher degree of accuracy is aimed at in the international scheme for a map of the whole sky undertaken jointly by eighteen observatories in 1887. The plates are only $2'' \times 2''$, and each of the eighteen observatories must take about 600 to cover its zone of the sky once, 1200 to cover it twice. Exposures of 6 min., 3 min., and 20 sec. are given, the telescope being pointed in a slightly different direction for each exposure; so that each star to about the 9th magnitude shows 3 images, and stars to the 11th or 12th magnitude show 2; which has the incidental advantage of distinguishing stars from dust-specks. A *réseau* of lines accurately ruled at distances of 5 mm. apart in two directions at right angles is impressed on the plate by artificial light and developed along with the star images; and by use of these reference lines the places of all stars shown with 3 min. exposure are measured with a probable error which, by a resolution of the executive committee, is not to exceed $\pm 0.20''$. An additional scheme for a series of charts enlarged from similar plates with much longer exposure has proved too costly, and only a few observatories have attempted it. Meanwhile Professor E. C. Pickering of Harvard, by using double lenses which cover a much larger field at once, has photographed the whole sky many times over. The plates have not been measured, and would not in any case yield results of quite the same accuracy as those of the international scheme; but being systematically stored at the Harvard Observatory they form an invaluable reference library, from which the history of remarkable objects can be read backwards when once attention is drawn to them. Thus the history of the asteroid Eros, discovered in 1898, was traced back to 1894 from these plates; new stars have been found on plates taken previous to the time of discovery, and the epoch of their blazing up recovered within narrow limits; and the history of many variable stars greatly extended. The value of this collection of photographs will steadily increase with time and growth.

Spectroscopic Star Charts.—By placing a glass prism in front of the object glass of a telescope the light from each star can be extended into a spectrum; and a chart can thus be obtained showing not only the relative positions, but the character of the light of the stars. This method has been used with great effect at Harvard; and from inspection of the plates many discoveries have been made, notably those of several novae.

The Geometry of the Star Chart.—Let OS in the figure be the object glass with which the photograph is taken, and let its optical centre be C. Let PL be the plate, and draw CN perpendicular to the sur-

face of the plate. The point N is of fundamental importance in the geometry of the star chart and it is natural to call it the plate centre;

but it must be carefully distinguished from two other points which should theoretically, but may not in practice, coincide with it. The first is the centre of the material plate, as placed in position in the telescope. In the figure NL is purposely drawn larger than PN, and this material centre would be to the right of N. The second point is that where the optical axis of the object glass (CG in the figure) cuts the plate. The object glass is drawn with an exaggerated tilt so that CG falls to the right of CN. To secure adjustment, the object glass should be "squared on" to the tube by a familiar operation, so that the tube is parallel to CG; and then the plate should be set normal to the tube and therefore to CG. This is done by observing reflected images, combined with rotation of the plate in its plane.

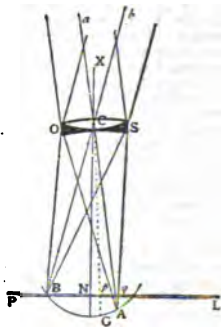

The field of the object glass will in general be curved: so that the points of best focus for different stars lie on a surface such as A'B (purposely exaggerated). The best practical results for focus will thus be obtained by compromise, placing the plate so that some stars, as A, are focused beyond the plate, and others, as B, nearer the object glass; exact focus will thus be possible for a particular ring on the plate. The star A will thus be represented by a small patch of light, ρ on the plate, which will grow in size as above explained. When we measure the position of its image we select the centre as best we can; and in practice it is important that the point selected should be that where the line Ca drawn from the star to the optical centre cuts the plate. If this can be done, then the chart represents the geometrical projection of the heavens from the point C on to the plane PL. The stars are usually conceived as lying on the celestial sphere, with an arbitrary radius; and centre at the observer, which is in this case the object glass; describing such a sphere with C as centre and CN as radius, the lines δCB and αCA project the spherical surface on to a tangent plane at the point N, which we call the plate centre. If we point the telescope to a different part of the sky, we select a different tangent plane on which to project. It is a fundamental property of projections that a straight line projects into a straight line; and in the present instance we may add that every straight line corresponds to a great circle on the celestial sphere. Hence if we measure any rectilinear co-ordinates (x, y) of a series of stars on one plate, and co-ordinates (X, Y) of the same stars on another plate, and (x, y) are connected by a linear relation, so must (X, Y) be. This property leads at once to the equations

$$X = (ax + by + c)/(1 - kx - ly), \quad Y = (dx + ey + f)/(1 - kx - ly), \quad (1)$$

the numerators being any linear functions of (x, y) but the denominators being the same linear function. When $x = 0, y = 0$, then $X = c$ and $Y = f$, which are thus the co-ordinates of the origin of (xy) on plate (XY) . The co-ordinate of the origin of (XY) on plate (xy) can be shown to be (k, l) if proper units of length be chosen.

As a particular case the co-ordinates

$$x = \cot \delta \cos \alpha, \quad y = \tan \delta \sin \alpha \quad (2)$$

represent the rectangular co-ordinates of a star of RA and declination α and δ , projected on the tangent plane at the north pole. If the same star be projected on the tangent plane at the point (A, D) , then its rectangular co-ordinates (ξ, η) will be

$$\xi = \tan \alpha (a - A) \sin q \sec (q - D), \quad \eta = \tan (q - D), \quad (3)$$

where $\tan q = \tan \delta \sec (a - A)$,

the axis of η being directed towards the pole. It can readily be verified that (ξ, η) can be expressed in terms of (x, y) by relations of the form (1). The co-ordinates (ξ, η) have been named "standard co-ordinates" and represent star positions on an ideal plate free from the effects of refraction and aberration. For plates of not too large a field, differential refraction and aberration are so small that their product by squares of the co-ordinates may be neglected, and the actual star positions (x, y) are connected with (ξ, η) by linear relations. The linearity of these relations is obviously not disturbed by the choice of origin of axes and of orientation; in which the effects of procession and mutation for any epoch may be included. Hence to obtain the standard co-ordinates (ξ, η) of any object on a plate it is only necessary to know the position of the plate centre (the point N in fig. 1) and the six constants in the relations

$$\xi = Ax + By + C, \quad \eta = Dx + Ey + F, \quad (4)$$

where (x, y) are rectilinear co-ordinates referred to any axes. The constants can theoretically be determined when there are three stars on the plate for which ξ, η are known; but in practice it is better to use as many "known" stars as possible. These equations

are well adapted to solution by least squares or any equivalent device.

Photography of Nebulae and Clusters.—Some of the earliest and most striking successes in celestial photography were the pictures of nebulae. Dr A. A. Common (1841-1903), F.R.S., of Ealing, led the way in 1883 with a successful picture of the great nebula in Orion, taken with a 3 ft. concave mirror by Calver. Dr Isaac Roberts (1829-1904) was the first to show the real structure of the great nebula in Andromeda, by a photograph also taken with a reflector. In the clear atmosphere of the Lick Observatory in California, small nebulae were photographed in great numbers by Professor J. E. Keeler (1857-1900); and it was shown that a large percentage were spiral in form. Prof. G. W. Ritchey, at the Yerkes Observatory, has followed up these successes with a 2-ft. reflector, and is constructing a 5-ft., to be erected on Mt Wilson (Cal.); but he has also shown that pictures of clusters are best taken with a telescope of long focus, such as the great Yerkes refractor, and incidentally that this telescope, although intended for visual work, can be adapted to photography by using a "colour screen" just in front of the plate, which sifts out the rays not brought to focus.

Photography of the Moon.—G. W. Ritchey has used the same device of a colour screen for the moon, and obtained even better pictures than those obtained at Paris, which were previously the best. The positions of a large number of craters and other points have been measured by Dr J. H. G. Franz and S. A. Saunder on photographs, and a new epoch in lunat photography has thereby been created.

Photography of the Planets.—Some striking successes have been obtained at the Lowell Observatory, Flagstaff, Arizona: by cutting down the aperture of the object-glass some of the delicate markings, called canals, on the planet Mars have been photographed; but even these do not approach what can be seen by the eye.

Photography of Comets.—Some wonderful pictures have been obtained of comets by Professor E. E. Barnard and others. Here, as in the case of nebulae, the photograph is superior to the eye in detecting faint luminosity, and delicate details of the tail structure have been photographed which could never be seen. In several pictures the tails have an appearance of violent shattering, and if successive pictures can be obtained at such times we may learn something of the nature of such disturbances.

Solar Photography.—The light of the sun is so intense that the chief difficulty is to obtain a short enough exposure. When successfully taken, photographs of the surface show the well-known spots and the mottling of the surface. The image sensibly falls off in intensity towards the limb, owing to the absorption of light by the solar atmosphere; and the bright faculae (which are thus inferred to lie above the main absorbing layer) are seen near the limb. But an immense advance in solar photography was made about a dozen years ago by the invention of the spectroheliograph, which is an instrument for photographing in the light of one very definite colour—say a single hydrogen line. The faculous appearances can be photographed with this instrument all over the sun's disk, instead of merely near the limb. The appearance presented varies enormously with the line selected, or (in the case of the wide "lines" in the spectrum, such as the H and K lines) with the particular part of the same line selected. But for a full account of such matters reference must be made to the articles SUN and SPECTROHELIOGRAPH.

AUTHORITIES.—Various papers in the *Monthly Notices of the Royal Astronomical Society* and in the *Astrophysical Journal*. Also the bulletins and circulars of the Harvard, Lick and Yerkes Observatories; and of the Executive Committee for the *Astrophotographic Catalogue* (published by Gauthier Villars for the Paris Académie des Sciences). See also more especially a paper by G. W. Ritchey in the *Decennial Papers of the University of Chicago*, reprinted in vol. ii. (1903) of the *Yerkes Observatory Publications*. (H. H. T.)

PHOTOMETRY (from Gr. *φῶς*, *phōs*, light, *μέτρον*, a measure), the art and science of comparing the intensities or illuminating powers of two or more sources of light. As in all scientific

measurements, its methods are attempts to give quantitative accuracy to the crude comparisons made by the eye itself. The necessity for this accuracy in practical affairs of life has arisen because of the great development of artificial lighting in recent times. The eye soon learns to associate with any particular source of light a quality of brightness or power of illumination which diminishes with increase of distance of the source from the eye or from the surface illuminated. This quality depends upon an intrinsic property of the source of light itself, generally known as its "candle power." The aim of photometry is to measure this candle power; and whatever be the experimental means adopted the eye must in all cases be the final judge.

In the photometric comparison of artificial lights, which frequently vary both in size and colour, direct observation of the sources themselves does not yield satisfactory results. It is found to be much better to compare the illuminations produced on dead white surfaces from which no regular reflection takes place, or through colourless translucent material uniformly illuminated by the light placed on the further side. By such processes there is always loss of light, and we must be certain that the various coloured constituents of the light are reduced in the same proportion. This necessary condition is practically satisfied by the use of white diffusing screens.

Two principles of radiation underlie many photometric applications, namely, the inverse square distance law, and J. H. Lambert's "cosine law." Both can be established on theoretical grounds, certain conditions being fulfilled. But as these conditions are never absolutely satisfied, the applicability of the two laws must in the end be tested by experiment. Since we find that within the errors of observation four candles, placed together at a distance of 2 ft. from a diffusing screen, produce the same illumination as one candle at a distance of 1 ft., we may regard the inverse square distance law as satisfied. Thus if two lights of intensities A and B produce equal illuminations on a screen when their distances from the screen are respectively a and b, we at once write down the relation between the two intensities in the form $A : B = a^2 : b^2$. The theoretical basis of the law follows at once from the universally accepted view that light is energy radiating outwards in all directions from the source. If we assume that there is no loss of energy in the transmitting medium, then the whole amount of radiant energy passing in one second across any closed surface completely surrounding the source of light must be the same whatever the size or form of the surface. Imagine for simplicity a point source of light, or its equivalent, a uniformly radiating spherical surface with the point at its centre, and draw round this point a spherical surface of unit radius. Across this surface there will pass a definite amount of radiant energy, in other words a definite total luminous flux, E, which will be the same for all concentric spherical surfaces. Since the area of a spherical surface of radius r is $4\pi r^2$, the flux which crosses unit area is $E/4\pi r^2$. This quantity is the "illumination." It is measured in terms of the unit called the lux, which is defined as the illumination produced by a light of unit intensity on a perfectly white surface at a distance of 1 ft. In the great majority of photometers the illuminations are compared, and the intensities are deduced by applying the law of the squared distances.

Lambert's cosine law has to do with the way in which a luminous surface sends off its radiations in various directions. It is a matter of common observation that the disk of the sun appears equally bright all over the surface. Careful measurements show that this is not strictly true; but it is sufficiently near the truth to suggest that under certain definable conditions the law would hold accurately. Again, when a glowing surface is viewed through a small hole in an opaque plate, the brightness is very approximately independent of the angular position of the incandescent surface. This is the same phenomenon as the first mentioned, and shows that the more oblique, and therefore larger, element of surface sends the same amount of radiation through the hole. Hence the amount per unit surface sent off

*Inverse
Square
Distance
Law.*

*Lambert's
Cosine
Law.*

at a given angle with the normal must be less than that sent off in the direction of the normal in the inverse ratio of the areas of the corresponding normal and oblique elements, that is, as the cosine of the given angle to unity. For most practical purposes, and so long as the obliquity is not great, Lambert's law may be assumed to hold.

In almost all accurate methods of photometry the aim is to bring the illuminating powers of the two sources to equality. This may be effected by altering the distance of either light from the illuminated surface. Or we may use polarized light and diminish the intensity of the stronger beam by suitable rotation of a Nicol prism, a method particularly useful in spectrophotometers. The same result may also be effected by interposing absorbent disks, the precise absorbing powers of which must, however, be known with great accuracy. Another useful

method is that first described by H. Fox Talbot in 1834, and used with effect by Professor William Swan (1849), and more recently by Sir W. de W. Abney. Talbot's law is thus enunciated by H. von Helmholtz: "When any part of the retina is excited by regularly periodic intermittent light, and when the period is sufficiently short, the resulting impression will be continuous, and will be the same as that which would be produced if the whole light were distributed uniformly throughout the whole period." Talbot deduced the principle from the well-known experiment in which a continuous luminous line is produced by rapid rotation of a luminous point. If the principle be granted, it is obvious that any mechanism by which a ray of light is obstructed in a regularly rhythmic manner during definite intervals t' , separated by intervals t , during which the light is allowed to pass, will have the effect of reducing the apparent brightness of the ray in the ratio $t/(t + t')$. This is frequently accomplished by placing in the ray a rotating disk perforated by radial sectors, the so-called Talbot disk.

If photometric results are to be of general value it is essential to have a unit in which to express all other intensities. For example, electric lights are classified according to their "candle-power." The candle, in terms of whose brightness the brightness of other sources of light is to be expressed, must, of course, fulfil the conditions demanded of all standards. It must give under definite and easily realizable conditions a definite and constant luminous effect, and it must be easily reproducible. The earlier attempts to get a candle of constant brightness were not very satisfactory. The British standard is a sperm candle which weighs $\frac{1}{4}$ lb, and loses in burning 120 grains per hour. It is found that these conditions are not sufficient to determine the luminous power of the candle, since the length and shape of the wick, the height of the flame, and the composition, temperature and humidity of the atmosphere all have an effect upon its brightness. The same is true of other similar sources of light—for example, the German standard candle, which is made of paraffin, has a diameter of 2 cm., and has its wick cut until the flame is 5 cm. high, but which with all precautions suffers continual alterations in brightness. For ordinary practical purposes, however, these candles are steady enough. Other kinds of flame have also been used as a standard source of light. The oldest of these is the French Carcel lamp, which is provided with a cylindrical Argand burner, and gives the standard brightness

when 42 grammes of colza oil are consumed per hour. The supply and draught are regulated by clockwork. A. G. Vernon-Harcourt's pentane standard, in which a mixture of gaseous pentane and air is burnt so as to maintain a flame 2.5 in. high at ordinary barometric pressure, gives good results, and is readily adjustable to suit varied conditions. Several forms of this standard have been constructed, one of the most important being the 10-candle-power pentane lamp, in which air saturated with pentane vapour is burnt in a specially-designed burner resembling an Argand burner. For photometric purposes a definite length of the lower part of the flame is used, the upper part being hidden within an opaque tube. The amyl-acetate lamp designed by H. von Helmer-Altenack has

been elaborately studied by the German authorities, and at present is probably more used than any other flame for photometry. It is of simple construction, and gives the standard brightness when it burns with a flame 4 cms. in height in still air of humidity 0.88% and free of carbon dioxide. The presence of carbon dioxide and increase in the humidity have a marked effect in diminishing the brilliancy of the flame. If the vapour pressure is e and the barometric pressure p , the strength of the flame, when all other conditions are fulfilled, is given by the formula

$$1.049 - 5e/(p - e)$$

One disadvantage for photometric purposes is the reddish colour of the flame as compared with the whiter artificial lights in general use.

For an interesting account of the various experimental investigations into the properties of the Heifer flame see E. L. Nichols, "Standards of Light," *Transactions of the International Electrical Congress*, vol. II. (St. Louis, 1904). Angstrom's determination of the radiation of the flame in absolute energy units is also of special interest.

Attempts have been made, but hitherto with limited success, to construct a convenient standard with acetylene flame. Could a satisfactory burner be devised, so that a steady brilliancy could be easily maintained, acetylene would, because of its intense white light, soon displace all other flames as standards.

J. Violle has proposed to use as standard the light emitted by a square centimetre of surface of platinum at its melting-point, but there are obvious practical difficulties in the way of realizing this suggested standard. J. E. Petavel, who carefully examined the necessary conditions for producing it (*Proc. Roy. Soc.* 1899), finds that the platinum must be chemically pure, that the crucible must be made of pure lime, that the fusion must be by means of the oxy-hydrogen blow-pipe, that the gases must be thoroughly mixed in the proportion of 4 volumes of hydrogen to 3 of oxygen, and that the hydrogen must contain no hydro-carbons. Under these conditions the variation in the light emitted by the molten platinum would probably not exceed 1%. O. Lummer and F. Kurlbaum have proposed as a standard a strip of platinum foil 25 mm. wide and .015 mm. thick brought to incandescence by an electric current of about 80 amperes. The temperature is gradually increased until $\frac{1}{10}$ th of the total radiation is transmitted through a water trough 1 cm. in width. This ratio is determined by means of a bolometer, and so long as it is adjusted to $\frac{1}{10}$ th the light is practically constant.

For comparative photometric work the incandescent electric light is very convenient, having the one great advantage over candles and flames that it is not affected by atmospheric changes. But it does not satisfy the requirements of a primary standard. It ages with use, and when run at constant voltage gradually loses in brilliancy, partly because of changes in the filament itself, partly because of the deposit of carbon on the interior of the bulb. Professor J. A. Fleming has shown that very good results can be obtained if carbon filaments carefully selected and run in ordinary bulbs for a definite time at a little above their normal voltage are remounted in large clear glass bulbs 6 or 8 in. in diameter. If used sparingly, and never above their marked voltage, these large incandescent bulbs have been found to remain constant for years, and therefore to be eminently suitable as secondary standards. In his *Handbook for the Electrical Laboratory and Testing Room* (vol. ii.) Fleming concludes that the best primary standards are the Violle incandescent platinum and the Vernon-Harcourt pentane one-candle flame; and that the most convenient practical standards are the Heifer lamp, the ten-candle pentane lamp, and the Fleming large bulb incandescent electric lamp. Comparisons of the intensities of these various standards do not give quite concordant results. Thus three different authorities have estimated the 10-candle pentane lamp as being equal to 10.75, 11.0, 11.4 Heifer lamps.

A specially constructed instrument or piece of apparatus for comparing light intensities or illuminations is called a

photometer. The earlier forms of photometers were very simple and not capable of giving very precise results. The principles of construction are, however, the same in all the recognized forms down to the most elaborate of recent inventions. Two of the earliest forms were described by P. Bouguer and W. Ritchie. The Ritchie wedge constitutes the basis of many varieties of type. The two lights to be compared illuminate the sides of the wedge, which is placed between them, so that the eye set in front of the wedge sees the two sides illuminated each by one of the lights. The edge should be as sharp as possible so that the two illuminated surfaces are in close contact. The illuminations are made equal either by shifting the wedge along the line joining the lights or by moving one of the lights nearer to or farther from the wedge as may be required. The lights given out by the sources are then as the squares of the distances from

Photo-meters.

Ritchie's Wedge.

Rumford's Photo-meter. suggested the comparison of the intensity of the shadows of the same object thrown side by side on a screen by the two lights to be compared. In this case the shadow due to one source is lit up by the other alone; and here again the amounts of light given out by the sources are as the squares of their distances from the screen when the shadows are equally intense. The shadow-casting object should be near the screen, so as to avoid penumbra as much as possible; yet not too near, so that the shadows may not overlap.

R. Bunsen suggested the very simple expedient of making a grease-spot on white paper for photometric purposes. When the paper is equally illuminated from both sides the grease-spot cannot be seen except by very close inspection. In using this photometer, the sources are placed in one line with the grease-spot, which lies between them and can be moved towards one or other. To make the most accurate determinations with this arrangement the adjustment should first be made from the side on which one source lies, then the screen turned round and the adjustment made from the side of the other source—in both cases, therefore, from the same side of the paper screen. Take the mean of these positions (which are usually very close together), and the amounts of light are as the squares of the distances of the sources from this point. The efficiency of the Bunsen photometer has been improved by using two inclined mirrors so that the eye views both sides of the paper simultaneously.

Sir Charles Wheatstone suggested a hollow glass bead, silvered internally, and made to describe very rapidly a closed path, for use as a photometer. When it is placed between two sources we see two parallel curves of reflected light, one due to each source. Make these, by trial, equally bright; and the amounts of light from the sources are, again, as the squares of the distances.

William Swan's prism photometer, invented in 1859, is a beautiful application of the principle embodied in Bunsen's grease-spot photometer (see *Trans. Roy. Soc. Ed. vol. xxi.*). The essential part of the instrument is fundamentally the same as that described by O. Lummer and E. Brodhun in 1859.

It consists of two equal right-angled isosceles glass prisms placed with their diagonal faces together so as to form a cube

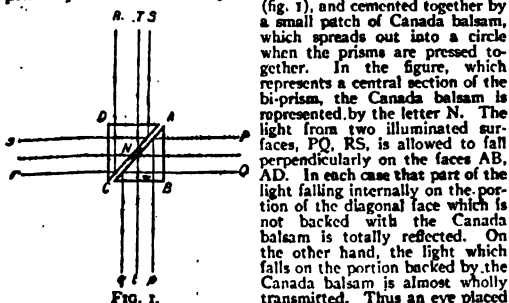

in the position of receives light from both sources; the surface RS supplying nearly all the light that seems to come from the patch N, and the surface PQ supplying all the light which seems to come from the region immediately surrounding N. The patch N will in general be visible; but it will quite disappear when the luminosity of the ray *T*, which traverses the Canada balsam, is exactly equal to the luminosity of the rays *Pp, Qq*, which have come after total reflection from the surface PQ. This condition of invisibility of N is arrived at by adjusting the positions of the sources of light which illuminate the surfaces PQ, RS. The brightnesses of the two sources will then be as the squares of their distances from their respective screens.

The essential part of Lummer and Brodhun's photometer is a combination of prisms very similar to Swan's. In its most improved form the bi-prism or "optical cube" has one of its component prisms cut in a peculiar manner. The diagonal face is partly cut away, so that the central part only of this face can be brought into contact with the diagonal face of the other prism. The Canada balsam is dispensed with, the surfaces being pressed closely together so that no layer of air is left between them. In order to make the instrument convenient for use with an optical bench, Lummer and Brodhun make the illuminated surfaces which are to be compared the opposite sides of an opaque screen set in the continuation of the diagonal (CA) of the bi-prism, the rays being brought by reflection from symmetrically situated mirrors so as to enter the sides AB and AD perpendicularly. An important modification, due also to Lummer and Brodhun, is the following: By means of a sand-blast a portion, which may be called *r*, is removed from one half of the diagonal face of the one prism, and from the other half of the same prism there is removed in like manner all but a part *l* corresponding to the part *r*. The portions which have not been removed are pressed close to the diagonal face of the other prism, and become the parts through which light is freely transmitted. On the other hand, the light which enters the second prism and falls on the portions of surface backed by the layers of air filling the cut-out parts is totally reflected. The general result is the production of two similar luminous patches *l* and *r*, each of which is surrounded by a field of the same intensity as the other patch. When the photometric match is made the whole region will be uniformly bright. But, by insertion of strips of glass so as to weaken equally the intensity in the surrounding fields, the match will be obtained when these fields are made of equal intensity and when at the same time the two patches differ equally in intensity from them. Under these conditions the eye is able to judge more certainly as to the equality of intensity of the two patches, and an untrained observer is able to effect a comparison with an accuracy which is impossible with most forms of photometer.

J. Joly's diffusion photometer consists of two equal rectangular parallelepipeds of a translucent substance like paraffin separated by a thin opaque disk. It is set between the sources of light to be compared in such a way that each paraffin block is illuminated by one only of the sources, and is adjusted until the two blocks appear to be of the same brightness. The method is made more sensitive by mounting the photometer on an elastic vibrator so as to render it capable of a slight to-and-fro oscillation about a mean position.

A form of photometer which is well adapted for measuring the illumination in a region is that due to L. Weber. It consists of a horizontal tube across one end of which is fitted another tube at right angles. This second tube can be rotated into any position perpendicular to the horizontal tube.

Where the axes of the two tubes meet is placed in the later forms of the instrument one of Lummer and Brodhun's modified Swan cubes. At the other end of the horizontal tube a standard flame is set illuminating a piece of ground glass which may be moved to any convenient position in the tube. The eye looks along the cross tube, at the farther end of which is placed another piece of ground glass illuminated from the outside. The illuminations of the two pieces of ground glass as viewed through the photometer double prism are brought to equality, either by shift of the ground glass to or from the standard light, or by means of two Nicol prisms placed in the cross tube. One advantage of the instrument is its portability.

The photometry of incandescent electric lamps has led to several special modifications and devices. The candle power varies distinctly in different horizontal directions, and one measurement in any particular direction is not sufficient. Sometimes the lamp is rotated about three times a second about a vertical axis and an average value thus obtained. But there is always a risk of the filament breaking; and in all cases the effect of centrifugal force must alter the form of the filament and therefore the distances of the different parts from the screen. Accuracy demands either the measurement of the radiation intensity in a number of directions all round the lamp, or one combined

measurement of as many rays as can be conveniently combined. One of the best methods of effecting this is by means of *Matthew's* C. P. Matthews's integrating photometer. By the use of twelve mirrors arranged in a semicircle whose diameter coincides with the axis of the lamp, twelve rays are caught and reflected outward to a second set of twelve mirrors which throw the rays on to the surface of a photometric screen. This combined effect is balanced by the illumination produced by a standard lamp on the other side of the screen (see *Trans. Amer. Inst. Elect. Eng.*, 1902, vol. xix.).

So long as the lights to be compared are of the same or nearly the same tint, the photometric match obtained by different observers is practically the same. If, however, they are of distinctly different colours, not only do different observers obtain different results but those obtained by the same observer at different times are not always in agreement. Helmholtz was of opinion that photometric comparison of the intensities of different coloured lights possessed no real intrinsic value. There can be little doubt that in a rigorous sense this is true. Nevertheless it is possible under certain conditions to effect a comparison which has some practical value. For example, when the intensities of two differently coloured lights differ considerably there is no difficulty in judging which is the stronger. By making the one light pass through a fairly large range of brightness we may easily assign limits outside which the intensities are undoubtedly different. After some experience these limits get close; and many experimenters find it possible, by taking proper precautions, not only to effect a match, but to effect practically the same match time after time. According to *Abney's Experiments*, whose memoirs on colour photometry (*Phil. Trans.*, 1886, 1892) form a most important contribution to the subject, the observer in making his judgment as to the equality of luminosity of two patches of colour placed side by side must not begin to think about it, but must let the eye act as unconsciously as possible. His method was to compare the coloured patch with white light given by a particular standard and cut down to the proper intensity by use of a Talbot's rotating sector, which could be adjusted by means of a suitable mechanism while it was rotating.

At the same time, although the eye may be able to effect a definite matching of two patches of colour of a particular luminosity, it has been long known that a change in the luminosity will destroy the apparent equality. This depends upon a physiological property of the retina discovered by J. E. Purkinje in 1825 (see below, *Celestial Photometry*). In virtue of this property the blue and violet end of the spectrum is more stimulating to the eye than the red end when the general luminosity is low, whereas at high luminosities the red gains relatively in brightness until it becomes more stimulating than the blue. Unless therefore account is taken in some definite measurable manner of the absolute brightness, there must always be some uncertainty in the photometric comparison of the intensities of differently coloured sources of light.

Instead, however, of trying to effect a photometric match in any of the ways which have been found sufficient when the sources are of the same or nearly the same tint, we may effect important practical comparisons in what is called heterochromatic photometry by an appeal to other physiological properties of the eye. For example, the power of clearly discriminating patterns in differently coloured lights of various intensities is obviously of great practical importance; and this power of detailed discrimination may be made the basis of a method of photometry. According to this method two lights

are arranged so as to illuminate two exactly similar patterns of lines drawn, for example, on the sides of a Ritchie wedge, and their distances are adjusted until the patterns are seen equally distinct on the two sides. Application of the usual distance law will then give the relation between the two lights. A discrimination photometer constructed on this principle has been designed by J. A. Fleming. Its results do not agree with the indications of an ordinary

luminosity photometer; for it is found that the eye can discriminate detail better with yellow than with blue light of the same apparent luminous intensity.

Another and very promising method of photometry depends upon the duration of luminous impressions on the retina. J. A. F. Plateau observed in 1829 that the blending into a homogeneous impression of a pattern of alternate sectors of black and some other colour marked on a disk when that disk was rotated occurred for rates of rotation which depended on the colour used. A form of experiment suggested in Professor O. N. Rood's *Modern Chromatics* seems to have been first carried out by E. L. Nichols (*Amer. Journ. of Science*, 1881). A black disk with four narrow open sectors was rotated in front of the slit of a spectroscope. When the rotation was not too quick the yellow part of the spectrum appeared as a succession of flashes of light separated by intervals of darkness of appreciable length, whereas towards both the red and violet ends no apparent interruption in the steady luminosity could be observed. As the rate of rotation increased the part of the spectrum in which flickering appeared contracted to a smaller length extending on each side of the yellow, and finally with sufficiently rapid alternation the yellow itself became steady. This seems to show that the retinal image persists for a shorter time with yellow light than with light of any other colour; for with it the intervals of darkness must be shorter before a continuous impression can be obtained. Now yellow is the most luminous part of the spectrum as it affects the normal human eye; and E. S. Ferry (*Amer. Journ. of Science*, 1892) has shown that the duration of luminous impression is mostly, if not entirely, determined by the luminosity of the ray. Hence the determination of the minimum rate of intermittence at which a particular colour of light becomes continuous may be regarded as a measure of the luminosity, the slower rate corresponding to the lower luminosity. Although in the experiment just described the red part of the ordinary solar spectrum becomes continuous for a slower rate of intermittence than the yellow part, yet we have simply to make a red ray as luminous as the yellow ray to find that they become continuous for the same rate of intermittence. It is, however, highly improbable that the duration of impression depends only on the luminosity of the light and not to some extent upon the wave-length. There are indeed phenomena which require for their explanation the assumption that the duration of luminous impression does depend on the colour as well as on the brightness.

Nevertheless the luminosity is by far the more important factor, as shown by Ogden N. Rood's experiments. He found (*Amer. Journ. of Science*, 1893) that, when a disk whose halves differ in tint but not in luminosity is rotated rather slowly, the eye of the observer sees no flickering such as is at once apparent when the halves differ slightly in luminosity. Rood himself suggested various forms of photometer based on this principle. In his latest form (*Amer. Journ. of Science*, Sept. 1899) the differently coloured beams of light which are to be compared photometrically are made to illuminate the two surfaces of a Ritchie wedge set facing the eye. Between the wedge and the eye is placed a cylindrical concave lens, which can be set in oscillation by means of a motor in such a way that first the one illuminated surface of the wedge and then the other is presented to the eye in sufficiently rapid alternation. The one source of light is kept fixed, while the other is moved about until the sensation of flicker disappears. From work with this form of instrument Rood concluded that "the accuracy attainable with the flicker photometer, as at present constructed, and using light of different colours almost spectral in hue, is about the same as with ordinary photometers using plain white light, or light of exactly the same colour."

Various modifications of Rood's forms have been constructed from time to time by different experimenters. The *Stimmes* and *Abney* flicker photometer is an ingenious and yet mechanically simple method by which (as it were) the wedge itself is made to oscillate so as to throw on the eye in rapid succession; first the one side and then the other. The rim of a wheel of white material is bevelled

in a peculiar manner. The sharp edge, which passes slightly obliquely across the rim from one side of the wheel to the other and back again, is the meeting of two exactly similar conical surfaces facing different ways and having their axes parallel to, but on opposite sides of, the axis of rotation of the wheel. As the wheel rotates with its rim facing the eye, the intersection of the two surfaces crosses and recrosses the line of vision during each revolution. Hence first the one illuminated side and then the other are presented to the eye in rapid alternation. The inventors of this instrument claim that their instrument can gauge accurately and easily the relative intensities of two lights, whether of the same or of different colour (*Phil. Mag.*, 1904). There is no doubt that results obtained by different observers with a flicker photometer are in better agreement than with any other form of photometer. The comparative ease with which the balance is obtained even when the tints are markedly different shows that its action depends upon a visual distinction which the eye can readily appreciate, and this distinction is mainly one of brightness.

The spectrophotometer is an instrument which enables us to make photometric comparisons between the similarly coloured portions of the spectra of two different sources of light, or of two parts of the same original source after they have passed through different absorbing media. When it is desired to compare the intensities of the spectra from two different sources a convenient form is the one described by E. L. Nichols. A direct vision spectroscopic mounted upon a carriage travels along a track between the two sources. In front of the slit two right-angled triangular prisms are set so that the light from each source enters the one side of one prism perpendicularly and is totally reflected into the spectroscope. The two spectra are then seen side by side. Attention being fixed on some chosen narrow portion, say, in the green, the instrument is moved along the track between the sources until the two portions appear of the same intensity. The process is then repeated until the whole spectrum has been explored.

In Lummer and Brodhun's form of spectrophotometer the rays to be compared pass in perpendicular lines through the modified Swan double prism, and then together side by side through a spectroscope. By means of a simple modification in the form of the two prisms, Professor D. B. Brace (*Phil. Mag.*, 1899) made the combined prism serve to produce the spectra as well as to effect the desired comparison. In this arrangement the compound prism ABC

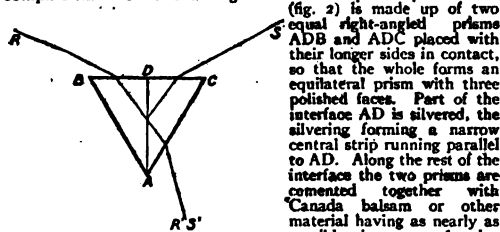

FIG. 2.

is made up of two equal right-angled prisms ADB and ADC placed with their longer sides in contact, so that the whole forms an equilateral prism with three polished faces. Part of the interface AD is silvered, the silvering forming a narrow central strip running parallel to AD. Along the rest of the interface the two prisms are cemented together with Canada balsam or other material having as nearly as possible the same refractive index as the glass. When two rays R S enter symmetrically from opposite sides of the base of the compound prism as shown in the diagram, the ray R will pass through the prism except where the silver strip intercepts it, and will form a part of a spectrum visible to the eye placed at R', while to the same eye there will be visible the similarly dispersed ray SS' reflected from the silvered surface. Thus two systems of incident parallel rays of white light will form on emergence two spectra with corresponding rays exactly parallel. With these and other forms of instrument the aim of the experimenter is to make the two spectra of equal intensity by a method which enables him to compare the original intensities of the sources. In most cases the relative intensities of the portions of the spectra being compared cannot conveniently be altered by varying the distances of the sources. Recourse is therefore generally had to one of the other methods already mentioned, such as the use of polarizing prisms or of rotating sectors. Under certain conditions K. Vierorid's method of allowing the two rays to pass through slits of different width leads to good results, but too great confidence cannot be placed upon it.

In other types of spectrophotometer, such as those associated with the names of H. Traunin, A. Crova, H. Wild, G. Hüfner, J. Königberger, A. König, F. F. Martens and others, the equalization in brightness of two rays is effected by using polarized light, which can be cut down at pleasure by rotation of a Nicol prism. For example, in the König-Martens instrument the two rays which are to be compared enter the upper and lower halves of a

divided slit. After passing through a lens they pass in succession through (1) a dispersing prism, (2) a Wollaston prism, (3) a bi-prism, and are finally focused where the eight spectra so produced can be viewed by the eye. Of these only two are made use of, the others being cut out. These two are polarized in perpendicular planes, so that if between the spectrum images and the eye a Nicol prism is introduced the intensities of any two narrow corresponding portions of the two spectra can be readily equalized. In terms of the angle of rotation of the Nicol the relative intensities of the original rays can be calculated. An important application of the spectrophotometer is to measure the absorptive powers and extinction coefficients of transparent substances for the differently coloured rays of light. By appropriate means the intensities of chosen corresponding parts of the two contiguous spectra are made equal—in other words, a match is established. Into the path of the rays of one of the spectra the absorbent substance is then introduced, and a match is again established. A measure of the loss of luminosity due to the interposition of the absorbent substance is thus obtained.

To facilitate experiments of this nature Dr J. R. Milne has devised a spectrophotometer which presents some novelties of construction (see *Proceedings of the Optical Convention*, 1905, vol. I). The light from a bright flame is suitably projected by a lens so as to illuminate a small hole in the end of the collimator. The rays from this point-source are made parallel by the collimator, and then pass, partly through the absorbing medium, partly through the space above it. These two parts of the original beam are transmitted through a dispersing prism and then fall upon a screen with two similar rectangular openings, the upper one allowing the unabsorbed part of the beam to pass, the lower that part which has been transmitted through the absorbing medium. The objective of the observing telescope converges the rays suitably upon a Wollaston prism, so that two spectra are seen side by side, having their light polarized in perpendicular planes. A Nicol prism is placed between the Wollaston prism and the eye-piece of the telescope, and by its rotation in the manner already described the intensities of any two corresponding portions of the two spectra can be brought to equality. By careful attention to all necessary details Milne shows that his instrument satisfies the requirements of a good spectrophotometer; for (1) the rays through the absorbing medium can be made strictly parallel; (2) the two spectra can be brought with ease accurately edge to edge without any diffraction effects; (3) the plane of the delimiting screen can be made conjugate to the retina of the observer's eye; (4) not only do the two spectra touch accurately along their common edge, but the two fans of rays which proceed from every point of the common edge lie in one and the same plane; (5) the eye is called upon to judge the relative intensities not of two narrow slits but of two broad uniformly illuminated areas. Milne also points out that this instrument can be used as a spectrocalorimeter.

E. L. Nichols considers that spectrophotometers which depend for their action upon the properties of polarized light are necessarily open to serious objections, such as; selective absorption in the calc spar, altering the relative intensities of the constituents in the original rays; selective losses by reflection of polarized rays at the various optical surfaces; and the necessarily imperfect performance of all forms of polarizing media. To eliminate these defects as far as possible great care in construction and arrangement is needed, otherwise corrections must be applied.

It is evident that if the successive parts of two spectra are compared photometrically we may by a process of summation obtain a comparison of the total luminosities of the lights which form the spectra. This process is far too tedious to be of any practical value, but sufficiently accurate results may in certain cases be obtained by comparison of two or more particular parts of the spectra, for example, strips in the red, green and blue. Similar in principle is the method suggested by J. Macé de Lepinay, who matches his lights by looking first through a red glass of a particular tint and then through a chosen green. If R and G represent the corresponding ratios of the intensities, the required comparison is calculated from the formula

$$I = \frac{R}{1 + 0.208(1 - GR)}$$

A. Crova, one of the earliest workers in this subject, effects the photometric comparison of differently coloured lights by matching those monochromatic rays from the two sources which have the same ratio of intensities as the whole collected rays that make up the lights. Careful experiment alone can determine this particular ray, but were it once ascertained for the various sources of light in use the method would have the merits of rapidity and accuracy sufficient for

practical needs. Spectrophotometric observations are necessary to determine the position in the spectrum of the particular monochromatic ray, but when it has been determined a coloured glass may be made which allows light in the neighbourhood of this ray to pass, and the photometric comparison may then be effected by looking through this glass.

This article has been confined strictly to the methods of visual photometry, with very little reference to the results. Comparison of intensities of radiation by photographic means or by methods depending on the effects of heat introduces considerations quite distinct from those which lie at the basis of photometry in its usual signification. (C. G. K.)

CELESTIAL, OR STELLAR, PHOTOMETRY

The earliest records that have come down to us regarding the relative positions of the stars in the heavens have always been accompanied with estimations of their relative brightness. With this brightness was naturally associated the thought of the relative magnitudes of the luminous bodies from whence the light was assumed to proceed. Hence in the grand catalogue of stars published by Ptolemy (c. 150 A.D.), but which had probably been formed three hundred years before his day by Hipparchus, the 1200 stars readily visible to the naked eye at Alexandria were divided into six classes according to their lustre, though instead of that term he uses the word *μέγεθος* or "magnitude"; the brightest he designates as being of the first magnitude, and so downwards till he comes to the *minimum visible*, to which he assigns the sixth. These magnitudes he still further divides each into three. To those stars which, though not ranged in any particular order of brightness, nevertheless exceed the average of that order in lustre he attaches the letter μ , the initial letter in *μείζων* (greater), and to those in the same order which exhibit a lustre inferior to that of the average he affixes the letter ϵ , the initial letter of *ἐλάσσων*. With this sort of subdivision he passes through all the six orders of magnitude. He does not, indeed, tell us the precise process by which these divisions were estimated, but the principle involved is obvious. It is one of the many remarkable instances of the acuteness and precision of the Greek mind that for upwards of 1500 years no real improvement was made in these estimations of lustre. J. Flamsteed extended the estimation of magnitude of stars visible only by the telescope, and he improved Ptolemy's notation by writing 4.3 instead of δ, μ —indicating thereby an order of magnitude brighter than the average of a fourth, but inferior to that of a third—and 3.4 for δ, ϵ , and so on; but it was not till the year 1796 that any real advance was made in stellar photometry. Sir W. Herschel, instead of assigning a particular magnitude to stars, arranged them in small groups of three or four or five, indicating the order in which they differed from each other in lustre at the time of observation. This method was admirably adapted to the discovery of any variations in brightness which might occur in the lapse of time among the members of the group. Sir William observed in this way some 1400 stars, published in four catalogues in the *Philosophical Transactions* from 1796 to 1799; and two additional catalogues were discovered among his papers in 1883 by Professor E. C. Pickering of Harvard (see *Harvard Annals*, xiv. 345), and have recently been published by Colonel J. Herschel (*Phil. Trans.*, 1906). These researches of the elder Herschel were in due time followed by those of his son, Sir John, about the year 1836 at the Cape of Good Hope. He both extended and improved the methods adopted by his father at Slough, and by a method of estimated sequences of magnitude he hoped to arrange all the stars visible to the naked eye at the Cape or in England in the order of their relative lustre, and then to reduce his results into the equivalent magnitudes adopted by the universal consent of astronomers. Sir John, however, like his father, left this important labour incomplete. Not only is the work one of great and continuous effort, but the effects of ever-varying meteorological conditions greatly impede it. Moreover, there is an unsatisfactory indefiniteness attending all estimations made by the unaided eye; numerical or quantitative comparisons are out of the question, and hence we find

Sir John, in the very midst of establishing his "sequences," adopting also an instrumental method which might lead him to more definite results.

In the year when Sir John Herschel concluded his photometric work at the Cape (1838) Dr F. W. A. Argelander commenced, and in 1843 completed, his *Uranometria nova*, in which the magnitudes of all stars visible to the unaided eye in central Europe are catalogued with a precision and completeness previously unknown. It contains 3256 stars, and although it will probably be superseded by instrumental photometry it must ever remain a monument of intelligent patience. Argelander's labours were not confined to stars visible to the naked eye; by the aid of his assistants, Dr E. Schönfeld and Dr A. Krüger, three catalogues of magnitudes and celestial co-ordinates were ultimately published (1859-1862) as the *Bonn Durchmusterung*, including the enormous number of 324,788 stars, and an additional volume containing 133,659 stars south of the equator was published in 1886.

Dr B. A. Gould (1824-1896), in his *Uranometria argentina* (1879), has done similar work for 7756 stars visible only in the southern hemisphere, and his successor at Córdoba, J. M. Thome, has published (1904) three volumes of the Argentine (Córdoba) *Durchmusterung* containing 489,662 stars between declination -22° to -52° . There have been other worthy labourers in the same field, each of whom has rendered efficient service, such as Dr E. Heis and M. J. C. Houzeau.

It is to Sir John Herschel that we are indebted for the first successful attempt at stellar photometry by what may be termed "artificial" means. He deflected the light of the moon (by means of the internal reflection of a rectangular prism) through a small lens 0.12 in. in diameter and of very short focus (0.23 in.) so as to form a sort of artificial star in its focus. With strings and a wooden pole he could move this artificial star of comparison so as to be in the same line of sight with any actual star whose light he proposed to measure. Other strings enabled him to remove it to such a distance from the eye that its light was adjudged to be sensibly the same as that of the star compared; and the distance was measured by a graduated tape. While he was thus busy at the Cape of Good Hope, K. A. Steinheil at Munich had completed for Dr P. L. Seidel an instrument nearly the same in principle but more manageable in form. He divided the small object-glass of a telescope into two halves, one of which was movable in the direction of its axis. The images of two stars whose light he desired to compare were formed by prismatic reflection, nearly in the same line of sight, and one of the lenses was then moved until the light of the two images seemed equal. The distance through which it was necessary to bring the movable lens furnished the data for comparing the relative lustre of the two stars in question. More recently other photometers have been devised, and descriptions of three of them, with which considerable researches have been conducted will now be given. With the first mentioned below Professor Pickering of Harvard has made more than a million measures with his own eyes. The results of his observations, and of those of his assistants, will be found in the *Harvard Annals* especially in vol. xiv. published in 1901, which contains a general catalogue of about 24,000 stars brighter than magnitude 7.5, north of declination -40° . With the Zöllner photometer Drs Gustav Müller and P. Kempf of Potsdam have recently completed a similar piece of work, their catalogue of stars north of the equator brighter than 7.5 containing 14,199 stars (*Potsdam Publications*, 1907, vol. xvii.). The catalogue of Professor C. Pritchard was smaller, containing 2784 stars brighter than magnitude about 6.5 and north of declination -10° ; but it was published in 1886, when very little had yet been done towards the systematic measurement of the brightness of the stars (*Uranometria nova oxoniensis*, vol. ii. of the Oxford University Observatory publications).

Pickering's meridian photometer (*Ann. Astron. Obs. Harv.* vols. xiv. and xxiii.) consists of two telescopes placed side by side pointing due east, the light from the stars on the meridian being reflected into them by two mirrors inclined at an angle of 45° to this direction. If there were a star exactly at the Pole, one of these mirrors

would be absolutely fixed and would constantly reflect the light of this star down the axis of its telescope; in practice a slight motion can be given to the mirror so as to keep in view

Pickering's Meridian Photometer. The polar star selected, whether Polaris, with which the brighter stars were compared, or λ Ursae Minoris, which was used for fainter stars. The second mirror (which projects a little beyond the first so as to get an unobstructed view of the meridian) can be rotated round the axis of the telescope by means of a toothed-wheel gearing, and can thus be made to reflect any star on the meridian down the second telescope; it is also provided with a small motion in the perpendicular direction, so as to command a degree or two on each side of the meridian. Near the common eyepiece of the telescopes there is a double image prism which separates the light received from each into two pencils; the pencil of ordinary rays from one object-glass is made to coincide with that of extraordinary rays from the other; and the two remaining pencils are excluded by a stop. The two coincident pencils then pass through a Nicol prism to the eye of the observer, who by rotating the Nicol round its axis can equalize them at a definite reading depending on their relative intensities. This reading gives in fact the difference of magnitude between the two stars selected for comparison. It may be remarked that the position of the double image prism is important. It should be just *within*, not *at*, the common focus: this position prevents any noticeable colour in the images, and gives the ordinary and extraordinary pencils a sufficient separation at the eye-stop to permit the entire exclusion of one without the loss of any part of the other. If the prism were exactly at the focus, and any part of the superfluous images were admitted, the resulting secondary images would coincide with the others and thus lead to errors in observing. But in the actual construction of the instrument the secondary images would appear, if at all, only as additional stars near those under observation, and too faint to produce any inconvenience. It is worthy of note that Professor Pickering has extended his survey into the southern hemisphere, so that the Harvard photometry is the most complete of all. Each observation consists of four comparisons; after the first two the observer reverses the position of the star images in the field, and also reverses the double-image prism. The former precaution is necessary in order to eliminate a curious error depending on the relative position of the images, which may amount to several tenths of a magnitude. Errors of this kind affect all estimations of the relative brightness of two stars in the same field, as has been repeatedly shown; a striking instance is given by A. W. Roberts, of Lovedale, South Africa (*Mon. Not. R.A.S.* April 1897), who found that his eye-estimations of the brightness of variable stars required a correction depending on the position-angle of the comparison star ranging over nearly two magnitudes.

In Zöllner's instrument an artificial star is taken as the standard of comparison. There is only one telescope, and inside the tube near the eye end is a plate of glass placed at an angle of 45° with the axis, so that the rays from a lamp which enter the tube from the side are reflected down the tube to the eyepiece, while the light from the star passes through the plate unobstructed. The lamplight passes through a Nicol prism and a plate of rock crystal, which give control over the colour; through two Nicols which can be rotated round the axis of the beam to definite positions round on a graduated circle; and then through a convex lens which forms an image reflected by the glass plate to focus alongside the star. The whole of this apparatus is carried in a compact form on the eye end of the telescope, it being arranged that the lamp shall always stand upright. The measures are made by rotating the Nicols until the brightness of the artificial star is equal to that of the star viewed through the object glass, and reading the graduated circle.

Professor Pritchard's (1808-1893) wedge photometer is constructed on the principle that the absorption of light in passing through a uniform medium depends, *ceteris paribus*, on the thickness. On this principle a thin wedge of homogeneous and nearly neutral tinted glass, through which the images of stars formed in the focus of a telescope are viewed. Simple means are contrived for measuring with great exactness the several thicknesses at which the light of these telescopic star-images is extinguished. In this way the light of any star can be readily compared with that of Polaris (or any other selected star) at the moment of observation, and thus a catalogue of star-magnitudes can be formed. Two material improvements suggested by Dr E. J. Spitta are worthy of notice. The first (*Proc. Roy. Soc.*, 1890, 47, 15) corrects a slight defect in the form of the instrument. If a pencil of rays passes through a thin wedge of tinted glass, the rays do not all pass through the same thickness of glass. Dr Spitta proposes to substitute a pair of wedges with their thicknesses increasing in opposite directions. By sliding one over the other we obtain a parallel plate of glass of varying thickness, and a uniform beam of light of sensible dimensions can then be extinguished satisfactorily. He has also pointed out a source of error in the method of "evaluating" the wedge and shown how to correct it. The scale value was determined by Professor Pritchard by the use of a doubly refracting prism of quartz and a Nicol prism. Using this method subsequently,

Dr Spitta found that internal reflections within the Nicol prism interfered with the accuracy of the result, but that this error could be eliminated by using a suitable diaphragm (*Mon. Not. R.A.S.* March 1890; Abney, *ibid.*, June 1890).

Since 1885 systematic catalogues of stellar brightness have been constructed with all these instruments, and it has been of great interest to compare the results. The comparison has in general shown a satisfactory agreement, but there are small differences which are almost certainly systematic, due to the difference of method and instrument. One cause of such differences, the reality of which is undoubted, but the effects of which have as yet not been perhaps fully worked out, is the "Purkinje phenomenon" (*Pflügers Archiv*, lxx. 297). If a blue source of light and a red source appear equally bright to the eye, and if the intensity of each be diminished in the same ratio, they will no longer appear equally bright, the blue now appearing the brighter; in more general terms, the equalizing of two differently coloured lights by the eye depends upon their intensity. It is clear that this phenomenon must affect all photometric work unless the stars are all exactly of the same colour, which we know they are not. For let us suppose that both the comparison star of the meridian photometer and the artificial star of the Zöllner photometer were equalized with a bright star A, and that they could be also compared *inter se* and found equally bright. Then when a faint star B comes under observation and the intensities of the comparison stars are both reduced to equality with B, they will no longer appear equal to one another unless they are exactly the same in colour. In other words, the observed ratio of intensities of A and B will vary with the colour of the comparison star, and similarly it will also vary with the aperture of the telescope employed. Now it is one of the merits of the Potsdam catalogue above mentioned that it gives estimates of the colours of the stars as well as of their magnitudes—so that we now for the first time have this systematic information. In a most interesting section of their introduction it is shown that two of the Harvard photometric catalogues show systematic differences, due to colour, and amounting to nearly half a magnitude, and that the Purkinje phenomenon is a satisfactory explanation of these differences. This is the first instance in which the effect of this phenomenon has been measured in the case of the stars, though it was known to be sensible. But there is a set of numerical results obtained in the laboratory which is of importance for all such works, viz. those obtained by Sir W. Abney (*Proc. Roy. Soc.* May 1891; and *Mon. Not. R.A.S.* April 1892), giving the limiting intensity at which each pure colour vanishes. If we start with lights C D E F G of the colours usually denoted by these letters in the spectrum, and each so bright that it appears to the eye as bright as an amyl-acetate lamp at 1 ft., and if then the intensity of each be gradually diminished, the C light will disappear when the original intensity has been reduced to 22,000 ten-millionths of the original value. The other colours will disappear at the following intensities, all expressed in ten-millionths of the original: D at 350, E at 35, F at 17, and G at 15. If then we had a mixture of two lights, one of C colour as bright as before, and the other of G colour 1000 times fainter (a combination in which the eye would be unable to distinguish the G light at all), and if we continually reduced the combined intensity, the luminosity of the C light would diminish so much more rapidly than that of the G that the latter would begin to assert itself, and when the combined intensities were reduced to 22,000 ten-millionths of the original value, the C light would have all disappeared, while the G light would not. Hence the colour of the light would appear pure violet, though it was originally deep red. This extreme case shows that the "last ray to disappear" when a light is gradually extinguished may be very different in colour from that of the original light, and when more usual light-mixtures are considered, such as those of sunlight and starlight, which appear nearly white to the eye, the "last ray to disappear" is found to be in the green, very near E in the spectrum. This result has two important bearings on the use of the wedge photometer. In the first place,

either the wedge itself should be of a greenish hue, or green light should be used in finding the scale-value (the constant B in the formula $m = A + Bw$). In the second, star magnitudes obtained by extinction with the wedge will agree better with those obtained by photography than those obtained with other visual photometers, since photographic action is chiefly produced by rays from E to G in the spectrum, and the E light of ultimate importance with the wedge photometer is nearer this light in character than the D light with which other photometers are chiefly concerned. It would also appear that results obtained with the wedge photometer are independent of the aperture of telescope employed, which is not the case with other photometers.

Passing now to the consideration of photographic methods, it is found that when a plate is exposed to the stars, the images

Photo-graphic Photo-metry. of the brighter stars are larger and blacker than those of the fainter ones, and as the exposure is prolonged the increase in size and blackness continues. Much of the light is brought to an accurate focus, but, owing to the impossibility of perfect achromatism in the case of refractors, and to uncorrected aberration, diffraction, and possibly a slight diffusion in both refractors and reflectors, there are rays which do not come to accurate focus, grouped in rings of intensity gradually diminishing outwards from the focus. As the brightness of the star increases, or as the time of exposure is prolonged, outer and fainter rings make their impression on the plate, while the impression on the inner rings becomes deeper. Hence the increase in both diameter and blackness of the star disks. As these increase concurrently, we can estimate the magnitude of the star by noting either the increase in diameter or in blackness, or in both. There is consequently a variety in the methods proposed for determining star magnitudes by photography. But before considering these different methods, there is one point affecting them all which is of fundamental importance. In photography a new variable comes in which does not affect eye-observations, viz., the time of exposure, and it is necessary to consider how to make due allowance for it. There is a simple law which is true in the case of bright lights and rapid plates, that by doubling the exposure the same photographic effect is produced as by increasing the intensity of a source of light twofold, and so far as this law holds it gives us a simple method of comparing magnitudes. Unfortunately this law breaks down for faint lights. Sir W. Abney, who had been a vigorous advocate for the complete accuracy of this law up till 1803, in that year read a paper to the Royal Society on the failure of the law, finding that it fails when exposures to an amyl-acetate lamp at 1 ft. are reduced to $0^{\circ}001$, and "signally fails" for feeble intensities of light; indeed, it seems possible that there is a limiting intensity beyond which no length of exposure would produce any sensible effect. This was bad news for astronomers who have to deal with faint lights, for a simple law of this kind would have been of great value in the complex department of photometry. But it seems possible that a certain modification or equivalent of the law may be used in practice. Professor H. H. Turner found that for plates taken at Greenwich, when the time of exposure is prolonged in the ratio of five star magnitudes the photographic gain is four magnitudes (*Mon. Not. R.A.S.* lxx. 775), and a closely similar result has been obtained by Dr Schwarzschild using the method presently to be mentioned.

Stars of different magnitudes impress on the plate images differing both in size and blackness. To determine the magnitude from the character of the image, the easiest quantity to measure is the diameter of the image, and when measurements of position are being made with a micrometer, it is a simple matter to record the diameter as well, in spite of the indefiniteness of the border. Accordingly we find that various laws have been proposed for representing the magnitude of a star by the diameter of its image, though these have usually been expressed, as a preliminary, as relations between the diameter and time of exposure. Thus G. P. Bond found the diameter to increase as the square of

the exposure, Turner as the cube, Pritchard as the fourth power, while W. H. M. Christie has found the law that the diameter varies as the square of the logarithm of the exposure within certain limits. There is clearly no universal law—it varies with the instrument and the plate—but for a given instrument and plate an empirical law may be deduced. Or, without deducing any law at all, a series of images may be produced of stars of known brightness and known exposures, and, using this as a scale of reference, the magnitudes of other images may be inferred by interpolation. A most important piece of systematic work has been carried out by the measurement of diameters in the Cape Photographic *Durchmusterung* (*Ann. Cape Obser.* vols. iii., iv. and v.) of stars to the tenth magnitude in the southern hemisphere. The measurements were made by Professor J. C. Kapteyn of Groningen, on photographs taken at the Cape of Good Hope Observatory; he adopts as his purely empirical formula

$$\text{magnitude} = B/(\text{diameter} + C),$$

where B and C are obtained independently for every plate, from comparison with visual magnitudes. C varies from 10 to 28, and B from 90 to 260. The part of the sky photographed was found to have an important bearing on the value of these constants, and it was in the course of this work that Kapteyn found a systematic difference between stars near the Milky Way and those far from it, which may be briefly expressed in the law, *the stars of the Milky Way are in general bluer than the stars in other regions of the sky.* It is intended, however, in the present article to discuss methods rather than results, and we cannot here further notice this most interesting discovery.

Of methods which choose the blackness of the image rather than the diameter for measurement, the most interesting is that initiated independently by Pickering at Harvard and C. Schwarzschild at Vienna, which consists *Images out of Focus.* in taking star images considerably out of focus. The result is that these images no longer vary appreciably in size, but only in blackness or density; and that this gradation of density is recognizable through a wide range of magnitudes. On a plate taken in good focus in the ordinary way there is a gradation of the same kind for the faintest stars; the smallest images are all of approximately the same size, but vary in tone from grey to black. But once the image becomes black it increases in size, and the change in density is not easy to follow. The images-out-of-focus method seems very promising, to judge by the published results of Dr Schwarzschild, who used a prepared comparison scale of densities, and interpolated for any given star from it. The most satisfactory photographic method would certainly be to take account of both size and blackness, i.e. to measure the total deposit in the film; as, for instance, by interposing the whole image in a given beam of light, and measuring the diminution of the beam caused by the obstruction. But no considerable piece of work has as yet been attempted on these lines.

Even in a rapid sketch of so extensive a subject some notice must be taken of the application of photometry to the determination of the relative amount of light received on the *Light of the earth from the sun, the moon and the planets. Sun, Moon and Planets.* earth from the sun, the moon and the planets. The methods by which these ratios have been obtained are as simple as they are ingenious; and for them we are mainly indebted to the labours of P. Bouguer and W. C. Bond (1789-1859). The former compared the light received from the sun with that from the moon in the following fashion in 1725. A hole one-twelfth of a Paris inch was made in the shutter of a darkened room; close to it was placed a concave lens, and in this way an image of the sun 9 in. in diameter was received on a screen. Bouguer found that this light was equal to that of a candle viewed at 16 in. from his eye. A similar experiment was repeated with the light of the full moon. The image now formed was only two-thirds of an inch in diameter, and he found that the light of this image was comparable with that of the same candle viewed at a distance of 50 ft. From these data and a very simple calculation it followed that the light of the sun was about 256,289 times that

of the moon. Other experiments followed, and the average of all the results was that the light of the sun was about 300,000 times the average light of a full moon, both being viewed in the heavens at the same altitudes. The details will be found in Bouguer's *Traité d'optique*. W. H. Wollaston in 1829 tried a series of experiments in which the ratio 801.072 was obtained; but the omission of certain necessary precautions vitiates the result (*Phil. Trans.* 1829). Bond (*Mem. Amer. Acad.* 1861, p. 295) adopted a different process. He formed the image of the sun on a silvered globe of some 10 in. diameter; the light of this image was reflected on to a small mercurial thermometer bulb; and then this second image was compared with a Bengal light so moved that the lights appeared to be equal. The same process was adopted with the full moon instead of with the sun. The result was that the sun's light was 470,980 times that of the moon. Seidel long before this date had compared the light of the mean full moon with that of Jupiter in mean opposition; his result is 6430. So also this light of Jupiter was found to be .4864 times that of Venus at her brightest; and Jupiter was found to give 8.2 times the light of a Lyrae. If, then, these numbers could be accepted with confidence, we should have the means of comparing the light received from the sun with that received from any of the stars. Adopting these precarious numbers on the authorities of Bond and Seidel we have the following results:—

Sun's light =	470,980	that of the full moon.
"	622,600,000	" Venus at her brightest.
"	302,835,000	" Jupiter at mean opposition.
"	5,970,500,000	" Sirius.

Lastly, Bouguer, by comparing the light of the full moon viewed at different altitudes with an artificial light, found that the atmosphere absorbs .1877 of the light incident on it at the zenith of any place. Professor Pritchard, from photometric measures taken at Cairo, found this number to be .157. At Oxford it was .209. Thus Bouguer's determination indicates an absorptive capacity in the atmosphere of Brittany just midway between those of Oxford and Cairo. Seidel at Munich expresses "surprise" at finding his own results so nearly accordant with Bouguer's. Although rather outside the domain of photometry in the strict sense, a word or two may be said here about recent attempts to measure the heat received from the stars, the first being made with the "radio-micrometer" of C. V. Boys. (*Proc. Roy. Soc.* 1890). This is an extremely delicate instrument for measuring radiant heat, and consists of a very light thermo-electric circuit (two tiny bars of antimony and bismuth soldered together at one edge, the outer edges being connected by a hoop of copper wire) suspended by a quartz fibre (a torsion fibre of the very greatest sensitiveness) in a strong magnetic field. A minute quantity of radiant heat falling on one of the junctions of the circuit sets up a current in the circuit, which thus rotates in the magnetic field until brought to rest by the torsion of the fibre. For use on the heavenly bodies the radiant heat is collected to focus by a reflecting telescope (an object-glass would absorb it), and when the telescope is pointed to the moon the varying radiation from different parts of the disk is beautifully shown. No heat comes from the unlit portion, and of the illuminated portion the maximum is obtained from near the limb. But when pointed to the brightest stars no indications were obtained, although the instrument is sensitive enough to detect the heat from a candle more than a mile off. It seems certain that indications of heat from the stars obtained by previous observers must be spurious. It is also manifest that to obtain satisfactory results even more sensitive apparatus must be devised, and by using a radiometer and the powerful resources of the Yerkes Observatory E. F. Nichols succeeded in 1808 and 1900 in obtaining indications of heat from Arcturus and Vega, as well as from Jupiter and Saturn (*Astrophysical Journ.* xiii., 101), the heat received being comparable with that from a candle 6 m. away. We may place alongside this result that obtained by W. J. Diddin (*Proc. Roy. Soc.* April 1892), who compared candle-light with twenty-one stars ranging to the sixth magnitude,

and found the light of a second magnitude star equal to that of a candle at 1260 ft. (H. H. T.)

PHRAATES (PHRAATES; Pers. *Frakht*, modern *Ferhät*), the name of five Parthian kings.

1. PHRAATES I., son of Priapatius, reigned c. 175-170 B.C. He subdued the Mardi, a mountainous tribe in the Elburz (Justin xli. 5; Isid. Charac. 7). He died young, and appointed as his successor not one of his sons, but his brother Mithradates I. (Justin xli. 5).

2. PHRAATES II., son of Mithradates I., the conqueror of Babylonia, reigned 138-127. He was attacked in 130 by Antiochus VII. Sidetes, who, however, in 129 was defeated and killed in a great battle in Media, which ended the Seleucid rule east of the Euphrates (see SELEUCID DYNASTY). Meanwhile the kingdom was invaded by the Scythians (the Tochari of Bactria), who had helped Antiochus. Phraates marched against them, but was defeated and killed (Justin xlii. 1; Johannes Antioch, *fr.* 66).

3. PHRAATES III., "the God" (Phlegon, *fr.* 12 *op.* Pothius *cod.* 97 and on some of his coins), succeeded his father, Sanatruces, in 70 B.C., at the time when Lucullus was preparing to attack Tigranes of Armenia, who was supreme in western Asia and had wrested Mesopotamia and several vassal states from the Parthian kingdom. Naturally, Phraates declined to assist Mithradates of Pontus and Tigranes against the Romans (see TIGRANES). He supported his son-in-law, the younger Tigranes, when he rebelled against his father, and invaded Armenia (65 B.C.) in alliance with Pompey, who abandoned Mesopotamia to the Parthians (Dio. Cass. xxxvi. 45, 51; Appian, *Mithr.* 104; Liv. *Epit.* 100). But Pompey soon overrode the treaty; he acknowledged the elder Tigranes, took his son prisoner, occupied the vassal states Gordyene and Osroëne for the Romans, and denied the title of "king of kings," which Phraates had adopted again, to the Parthian king (Plut. *Pomp.* 33, 38; Dio. Cass. xxxvii. 5 seq.). About 57 Phraates was murdered by his two sons, Orodes I. and Mithradates III.

4. PHRAATES IV., son of Orodes I., by whom he was appointed successor in 37 B.C., after the death of Pacorus. He soon murdered his father and all his thirty brothers (Justin xlii. 5; Plut. *Crass.* 33; Dio. Cass. xlix. 23). He was attacked in 36 by Antonius (Mark Antony), who marched through Armenia into Media Atropatene, and was defeated and lost the greater part of his army. Believing himself betrayed by Artavasdes, king of Armenia, he invaded his kingdom in 34, took him prisoner, and concluded a treaty with another Artavasdes, king of Atropatene. But when the war with Octavianus Augustus broke out, he could not maintain his conquests; Phraates recovered Atropatene and drove Artaxes, the son of Artavasdes, back into Armenia (Dio. Cass. xlix. 24 sqq., 39 seq., 44; cf. li. 16; Plut. *Antonius*, 37 seq.). But by his many cruelties Phraates had roused the indignation of his subjects, who raised Tridates II. to the throne in 32. Phraates was restored by the Scythians, and Tridates fled into Syria. The Romans hoped that Augustus would avenge the defeat of Crassus on the Parthians, but he contented himself with a treaty, by which Phraates gave back the prisoners and the conquered eagles (20 B.C., *Mon. Anc.* 5, 40 sqq.; Justin xlii. 5); the kingdom of Armenia also was recognized as a Roman dependency. Soon afterwards Phraates, whose greatest enemies were his own family, sent five of his sons as hostages to Augustus, thus acknowledging his dependence on Rome. This plan he adopted on the advice of an Italian concubine whom he made his legitimate wife under the name of "the goddess Musa"; her son Phraates, commonly called Phraataces (a diminutive form), he appointed successor. About 4 B.C. he was murdered by Musa and her son (Joseph. *Ant.* xviii. 2, 4).

5. PHRAATES V., OF PHRAATACES, the younger son of Phraates IV. and the "goddess Musa," with whom he is associated on his coins. Under him a war threatened to break out with Rome about the supremacy in Armenia and Media. But when Augustus sent his adopted son Gaius Caesar into the east in order to invade Parthia, the Parthians preferred to conclude a

treaty (A.D. 1), by which once again Armenia was recognized as in the Roman sphere (Dio. Cass. iv. 10; Velleius ii. 102). Soon after Phraortes and his mother were slain by the Parthians, about A.D. 5 (Joseph. *Ant.* xviii. 2, 4). (Ed. M.)

PHRANTZA, GEORGE [GEORGIOS PHRANTZES] (1401-c. 1477), the last Byzantine historian, was born in Constantinople. At an early age he became secretary to Manuel II. Palaeologus, in 1432 protovestiarius (great chamberlain), in 1446 praefect of Sparta, and subsequently great logothete (chancellor). At the capture of Constantinople by the Turks (1453) he fell into their hands, but managed to escape to Peloponnesus, where he obtained protection at the court of Thomas Palaeologus, despot of Achaëa. After the downfall of the Peloponnesian princes (1460) Phrantza retired to the monastery of Tarchaniotes in Corfu. Here he wrote his *Chronicle*, containing the history of the house of the Palaeologi from 1258-1476. It is a most valuable authority for the events of his own times.

Editions by I. Bekker (1838) in the *Corpus scriptorum hist. byz.*, and in J. P. Migne, *Patrologia graeca*, clvi; see also C. Krumbacher, *Geschichte der byzantinischen Literatur* (1897).

PHRAORTES, the Greek form of *Fravartish*, king of Media. According to Herodotus (i. 102) he was the son of Deioceus, and began the Median conquests. He first subjugated the Persians, and then a great many other peoples of Asia, till at last he attacked the Assyrians, but was defeated and killed in a battle, after a reign of twenty-two years (about 646-625 B.C.; but perhaps, as G. Rawlinson supposes, the fifty-three years of Deioceus ought in reality to be transferred to him). From other sources we obtain no information whatever about Phraortes; but the data of the Assyrian inscriptions prove that Assur-banipal (see BABYLONIA AND ASSYRIA), at least during the greater part of his reign, maintained the Assyrian supremacy in Western Asia, and that in 645 he conquered Susa. The Medians too were subject to him as far as the Elburz and the central Iranian desert.

When after the assassination of Smerdis all the Iranian tribes, the Babylonians and the Armenians rebelled against Darius and the Persian rule, "a man of the name of Fravartish (i.e. Phraortes), a Mede, rebelled in Media and spoke to the people thus: I am Khshathrita, of the family of Uvakhshatra (Cyzaxares)." He reigned for a short time, but was defeated by Hydarnes, and afterwards by Darius himself, taken prisoner in Rhagae (Rai), and executed in Ecbatana (520 B.C.; see inscription of Darius at Behistun). (Ed. M.)

PHRENOLOGY, (from Gr. *φρήν*, mind, and *λόγος*, discourse), the name given by Thomas Ignatius Forster to the empirical system of psychology formulated by F. J. Gall, and developed by his followers, especially by J. K. Spurzheim and G. Combe, by whom it was named "cranioscopy," "craniology," "physiognomy" or "zoonomy." The principles upon which it is based are five: (1) the brain is the organ of the mind; (2) the mental powers of man can be analysed into a definite number of independent faculties; (3) these faculties are innate, and each has its seat in a definite region of the surface of the brain; (4) the size of each such region is the measure of the degree to which the faculty seated in it forms a constituent element in the character of the individual; (5) the correspondence between the outer surface of the skull and the contour of the brain-surface beneath is sufficiently close to enable the observer to recognize the relative sizes of these several organs by the examination of the outer surface of the head. It professes primarily to be a system of psychology, but its second and more popular claim is that it affords a method whereby the disposition and character of the subject may be ascertained.

History.—That the phenomena of mind are in some measure connected with the action of the brain has been recognized from a very early age of philosophy. It is true that Aristotle¹ describes the brain as the coldest and most bloodless of bodily organs, of the nature of water and earth, whose chief purpose is to temper the excessive heat of the heart, as the cooler regions of the firmament condense the vapours rising from the earth.

¹ *De partibus animalium*, ii. c. 7 (Paris, 1629, p. 986).

In his view, as in that of most of the earlier writers of other nations of antiquity, the heart is the seat of life; to it, not to the brain, the Hebrew writers refer thoughts and affections, while they considered judgment as seated sometimes in the head, sometimes in the kidneys.² This was likewise the teaching of the ancient Egyptian philosophy; and hence, while many rites were practised and prayers offered for the preservation of the heart of the deceased, there were none for the conservation of the brain.³ We learn from Diogenes Laertius⁴ that Pythagoras held more accurate physiological views, as he taught that the mind and the intellect have their seat in the brain. The theory of Hippocrates was Pythagorean rather than Aristotelian, for, although in one passage in his work *De cordis* he expresses himself doubtfully, yet elsewhere he clearly states that he considers the brain to be the index and messenger of the intellect.⁵ The cerebral seat of sense-perception is also taught by Plato,⁶ who puts into the mouth of Socrates the theory that the brain is the organ affected by the senses, whereby memory and opinion arise, and from whence knowledge springs. The classic poets also notice this dependence of mind on brain; for example, in the *Clouds* (v. 1276) Strepsiadæ accuses Amynias of not being in his right mind, and, on being asked why, responds, "You seem to me as if you had had a concussion of the brain."

The two founders of anatomical science, Erasistratus and Herophilus, who lived in the days of Ptolemy Soter, taught not only that the brain was the seat of sensation and of intellect, but also that there was therein a certain degree of localization of function. Erasistratus believed that the sensory nerves arose from the brain-membranes, the motor from the cerebral substance. Herophilus was apparently the first who held that the vital forces resided in and circulated from the ventricles of the brain, at least so we gather from Celsus and the other authors who have preserved his views. By the influence of the writings of Galen,⁷ which directly teach that the brain is the seat of soul and intellect the Pythagorean doctrine prevailed among the later philosophers. According to the Galenical theory the animal spirits have their origin in the ventricles of the brain, and pass into the heart from which they are conveyed by the arteries through the body. Galen in one place (viii. 150) refers their origin to the brain-substance, but the ventricular theory was that adopted by his followers, some of whom suggested that there was some relation between the shape of the head and the character and disposition of the mind.⁸ The Arabian physicians Averroës⁹ and Rhazes¹⁰ adopted the Galenical doctrine and developed the hypothesis of a fourfold ventricular localization of faculties, which the Greeks had originated. Avicenna¹¹ added to these a fifth region. Such of the early Christian authors as referred in

² In the Chaldee portion of Daniel (ii. 28, iv. 5, vii. 1) visions and thoughts are referred to the head. For other particulars as to early views see Nasse on the psychical relations of the heart in *Zeitschr. f. psychische Aerzt.* (1818), vol. i. A few of the later medical writers express similar views; see Santa Cruz, *Opuscula medica*, Madrid (1624).

³ *Book of the Dead*, ch. xxvi-xxx.

⁴ viii. 30; ed. Cobet, Paris (1850), p. 211.—*φρήνας δὲ καὶ νοῦν, τὰ ἐν τῷ ἐγκεφάλῳ.*

⁵ *De morbo sacro*, in *Opp.* ed. Kühn, ii. 672 seq.; also *Epist.* iii. 824. Among later writers Licetus of Genoa taught the co-extension of soul and body, upon which subject he wrote two books (Padua, 1616). In this connexion may be noted a curious work by Schlegel, *Dialogus de animae principatu, Aristotelis et Galeni rationes praefertens quibus ille cordi, hic cerebro, principatum attribuit* (Tübingen, 1542).

⁶ *Phaedo*, Valpy's ed. 1833, ch. xlv. p. 128. See also Haller's *Bibl. anat.*, i. 30.

⁷ *De usu partium*, ed. Kühn, iii. 700.—*τὰς ψυχῆς ἐπιβολὰς τῷ τῷ λογιστικῷ ψυχῆς ὀφείλει ἐν τῷ ἐγκεφάλῳ, καὶ τῷ τῷ ψυχῆς ἐν αὐτῷ περιχρῆσθαι κέντρον.* See also v. 288, viii. 150, xv. 360. In his *Definitiones medicae* (467, xix. 459) he says that the brain has a *ψυχῆς ὄργανον*, but does not specify in what part the power inheres.

⁸ See Paulus Aegineta, Stephen's ed. 1567, cap. 62, col. 363, also Actuarius, *De actionibus et affectibus spiritus animalis* (Paris, 1556), p. 22, c. 7.

⁹ *Comment. in Arist.*; Latin tr. (Venice, 1550), vi. 73.

¹⁰ *Imaginatio quidem in duobus ventriculis anterioribus perfitur. Cogitatio vero in medio expletur. Memoria autem posteriorem possidet ventriculam.* *De re medica*, Gérard's trans. (Basel, 1554), i. 9.

¹¹ *Lib. canonis* (1507), p. 19, and *De naturalibus*, c. 6.

their writings to the relation of soul to body naturally adopted the teaching of Galen which they accommodated to their theology, thereby conferring on it an importance which rendered correction difficult. Tertullian¹ in a sense expresses his belief in a theory of localization as also at a later period does Thomas Aquinas.²

Early in the 13th century Albertus Magnus³ gave a detailed description of the distribution of mental and psychical faculties in the head. The anterior region he assigned to judgment, the middle to imagination, and the posterior to memory. A somewhat similar allocation was made by Gordon, professor of medicine in Montpellier (1206),⁴ who assigned common sensation and the reception of impressions to the anterior cornua of the lateral ventricles, *phantasia* to the posterior, this power being two-fold (*imaginativa* and *cogitativa*), judgment or *astimative* to the third ventricle, and memory to the fourth.⁵ Figures of a similar division were given by Petrus Montagnanus⁶ and Lodovico Dolce⁷ still later by Ghiradelli of Bologna⁸ and by Theodore Gall of Antwerp.⁹ That the "vital spirits" resided in the ventricles was doubted by many, and denied by a few of the anatomists of the 17th century. G. Bauhin in 1621¹⁰ attacked the old view, and Hoffmann of Altorf showed that, as the ventricles were closed cavities, they could not transmit any material fluid. That these spirits existed at all was doubted by Alexander Benedictus,¹¹ Plater,¹² and a few others; but they were believed in by the great majority of 17th and even of 18th century medical writers, many of whom, conceived that the ventricles were *semper pleni spiritibus animalibus flammulis similibus, quorum beneficis intelligimus, sentimus, et movemur*,¹³ and the opponents of this view were strongly assailed by J. Riolan and others as revolutionary. Columbus¹⁴ ridiculed the idea that the convoluted surface can have anything to do with intellect, as the ass, a proverbially stupid animal, has a convoluted cerebrum. According to his view, the convolutions are for the purpose of lightening the brain and facilitating its movements. The grey matter of the surface of the cerebrum was recognized as the true dynamic element by M. Malpighi¹⁵ and T. Willis.¹⁶

¹ *De anima*, civ. (ed. Franeker, 1597), p. 268.

² *Summa theologiae*, ed. Migne, l. 1094, 1106-7. Prochaska and his translator, Laycock (*Mind and Brain*, ii, 163), charge Duns Scotus with holding this view; probably he did, but he does not express it, as he simply specifies the cerebrum and its root, the spinal cord, as the source of the nerves along which sensory impulses travel. *Comment. de anim.* i, 515 (Leiden, 1637).

³ *Opera*, iii, 124, vi, 20 (Leiden, 1651).

⁴ *Latinum medicinae*, 101 (Venice, 1494).

⁵ Avicenna's fifth region is interposed between *imaginativa* and *astimativa* (*De naturalibus*, c. vi.). Thomas Aquinas combines the last two, which he says are possessed by the same eminence. On the other hand, he says of *ratio particularis*, "medici assignant determinatum organum, scilicet mediam partem capitis" (l. 1106).

⁶ *Physiognomia* (Padua, 1491).

⁷ *Dialogo nel quale si ragiona del modo di accrescere e conservar la memoria*, 27 (Venice, 1562).

⁸ *Physiognomia*, 1670.

⁹ *Tabulae element. scientiae* (Rome, 1632).

¹⁰ *Theatr. anat.* (Basel, 1621, iii, 314); Caspar Hoffmann, *De usu cerebri* (Leipzig, 1619). See also Spiegelius, *De corp. humani fabrica*, 296 (Amsterdam, 1645); Varolius (1591), p. 61 Wepler, *Historiarum apoplecticarum potissimum anatomiae subjeclorum anatomicarum* (Amsterdam, 1681). See also many of the anatomical works of this age, such as those of Fernel, Cabrol, Argenterius, Rolinck, &c.

¹¹ Alexander Benedictus, *Anatomica*, vol. iii. (Basel, 1527). Quercetanus is said by Laycock (following Prochaska) to have assailed this doctrine of spirits; on what ground is not apparent, as he certainly expresses himself as a believer in the old view; see *Tetras gravis. latus capitis affect.* x, 89 (Marburg, 1606). Possibly Prochaska may allude to an obscure passage in the work of the other Quercetanus (Eustachius), *Acroamator in librum Hippocraticis*, p. 14 (Basel, 1549), not to the better-known Josephus Armeanus; but he gives no reference.

¹² *Opera*, col. 22, 89 (Basel, 1623).

¹³ *Joelis opera medica*, 22 (Amsterdam, 1663).

¹⁴ *De re anatomica*, p. 350 (Frankfort, 1591).

¹⁵ "Epist. de cerebro et cort. cereb. ad Fracasatum," in *Opp.*, vol. ii. (Geneva, 1685).

¹⁶ *De anima brutorum*, p. 71 (Oxford, 1677). "hae particulae subtilissimae, spiritus animales dictae, partium istarum substantias corticales primo subeunte, exinde in striisque medullaria," &c.; also p. 76 seq.

The latter regarded the convoluted surface of the cerebrum as the seat of the memory and the will, the convolutions being intended to retain the animal spirits for the various acts of imagination and memory. Imagination he described as seated in the corpus callosum, sense-perception in the corpus striatum, and *impetus et perturbatio* in the basal parts of the cerebrum above the crura. The thalami he regarded as the centres of sight and the cerebellum of involuntary acts. Succeeding anatomists simply varied these localizations according to their respective fancies. G. M. Lancisi placed sense-perception in the corpus callosum, R. Vieussens in the centrum ovale majus. R. Descartes supposed the soul to be seated in the pineal gland, others in the brain-commissures especially the pons Varolii.¹⁷ Meyer considered abstract ideas to arise in the cerebellum, and memory to have its seat at the roots of the nerves.¹⁸

Of later writers three deserve special notice, as having largely prepared the way for the more modern school of phrenology. J. A. Unzer, of Halle, in his work on physiology extended the pre-existing theories of localization. Metzger,¹⁹ twenty years before the publication of Prochaska's work, had proposed to make a series of observations on the anatomical characters of the brains of persons of marked intellectual peculiarity; but apparently he did not carry this into effect. In a more special manner Prochaska of Vienna may be looked upon as the father of phrenology, as in his work on the nervous system, published in Vienna in 1784, are to be found the germs of the later views which were propounded in that city twelve years later.²⁰

The system formulated by Gall (*q.s.*) is thus a modern expansion of an old empirical philosophy, and its immediate parentage is easily traced, although, according to Gall's account, it was with him the result of independent observations. These, he tells us, he began to make at an early age, by learning to correlate the outward appearances and mental qualities of his school-fellows. Gall's first published paper was a letter in the *Deutscher Merkur* of December 1798, but his principal expositions were oral, and attracted much popular attention, which increased when, in 1802, he was commanded by the Austrian government, at the instance of the ecclesiastical authorities, to discontinue his public lectures. In 1804 he obtained the co-operation of Spurzheim (1776-1832), a native of Longwich, near Treves, who became his pupil in 1800, and proved a powerful ally in promulgating the system. Master and pupil at first taught in harmony, but they found it advisable to separate in 1813; and we find Spurzheim, several years after their parting, declaring that Gall had not introduced any improvements into his system since their separation (notes to Chenevix, p. 99). "My philosophical views," he also says, "widely differ from those of Gall."

In Paris, where he settled in 1807, Gall made many influential converts to his system. F. J. V. Broussais, H. M. D. de Blainville, H. Cloquet, G. Andral, E. Geoffroy St-Hilaire, Vimont and others adopted it and countenanced its progress. Gall visited Great Britain, but the diffusion of phrenology here was chiefly due to Spurzheim, who lectured through the country and through America, and with the aid of his pupil, George Combe, attracted a large popular following. His most influential disciples were J. Elliotson, Andrew Combe, Sir G. S. Mackenzie, R. Macnish, T. Laycock and Archbishop R. Whately, and in America Caldwell and J. Godman. On the opposite side many influential men took up a strongly antagonistic position, prominent among whom were J. Barclay the anatomist, P. M. Roget, Sir Charles Bell, Sir W. Hamilton, F. Jeffrey, H. P. Brougham, T. Brown and Sir B. Brodie. The nature of the system rendered it eminently fitted to catch public attention, and it rapidly attained to so great a

¹⁷ Fechner, *Elemente der Psychophysik*, ii, 396.

¹⁸ Some of the medieval views were very fanciful, thus Shabbethai b. Abraham, the earliest Jewish writer on medicine (d. A.D. 959), thought that the spirit of life has its seat in the brain-membrane; expanded over the brain and subarachnoid fluid, as the Shelkinah in the heavens arched over the earth and waters. See *Der Mensch als Gottes Ebenbild*, ed. Jellinek (Leipzig, 1854), and Castelli, *Commento* (Florence, 1880).

¹⁹ *Vermischte medicinische Schriften* (1764), i, 58.

²⁰ See Laycock's trans. in *Sydenh. Society's Pub.* (1851).

degree of popularity that in 1832 there were twenty-nine phrenological societies in Great Britain, and several journals devoted to phrenology in Britain and America; of these the *Phrenological Journal*, a quarterly, edited chiefly by George Combe with aid from others of the Edinburgh confraternity, notably Sir George Mackenzie and Macnish, "the modern Pythagorean," lived from 1823 to 1847, through twenty volumes. The controversy in many places was heated and often personal, and this largely increased the popular interest. In the *Edinburgh Review* the theory was severely criticized by Thomas Brown, and afterwards in a still more trenchant manner by Jeffrey. In *Blackwood* it was ridiculed by Professor John Wilson. Being a subject which lent itself easily to burlesque, it was parodied cleverly in a long rhyme by two authors, "The Craniad," 87 pages long, published in 1817, while, on the other hand, verse was pressed into its service in the rhyme "Phrenology in Edinburgh" in 1824.¹ The best defence of the system was that by Chenevix in the third number of the *Foreign Quarterly*, afterwards reprinted with notes by Spurzheim.

The Faculties and their Localities.—The system of Gall was constructed by a method of pure empiricism, and his so-called organs were for the most part identified on slender grounds. Having selected the place of a faculty, he examined the heads of his friends and casts of persons with that peculiarity in common, and in them he sought for the distinctive feature of their characteristic trait. Some of his earlier studies were made among low associates, in gaols and in lunatic asylums, and some of the qualities located by him were such as tend to become perverted to crime. These he named after their excessive manifestations, mapping out organs of murder, theft, &c.; but as this cast some discredit on the system the names were changed by Spurzheim, who claimed as his the moral and religious considerations associated with it. Gall marked out on his model of the head the places of twenty-six organs as round enclosures with vacant interspaces. Spurzheim and Combe divided the whole scalp into oblong and continuous patches (see the accompanying figures). Other methods of division and other names have been suggested by succeeding authors, especially by Cox, Sidney Smith (not Sydney), Toulmin Smith, K. G. Carus of Dresden, Don Mariano Cubi i Solar, W. B. Powell of Kentucky, J. R. Buchanan of Cincinnati, Hittel of New York. Some, like the brothers Fowler, raise the number of organs to forty-three; but the system of Spurzheim and Combe is that which has always been most popular in Britain.

Spurzheim separated the component faculties of the human mind into two great groups and subdivided these as follows:—

- I. Feelings, divided into—
 1. Propensities, internal impulses inviting only to certain actions.
 2. Sentiments, impulses which prompt to emotion as well as to action.
 - A. Lower—those common to man and the lower animals.
 - B. Higher—those proper to man.
- II. Intellectual faculties.
 1. Perceptive faculties.
 2. Reflective faculties.

In the following list the locality and the circumstances of the first recognition of the organ are appended to the names, which are mostly the inventions of Spurzheim. Gall's names are placed in brackets.²

Propensities.

1. Amativeness (*Instinct de la génération*), median, below the inion; first determined by Gall from its heat in an hysterical widow, supposed to be confirmed by many observations, and referred to the cerebellum.³

¹ Other burlesque and satirical writings were published at this time, notably *The Phrenologists*, a farce by Wade (1830); *The Head-piece*, or *Phrenology opposed to Divine Revelation*, by James the Less; and *A Helmsl for the Head-piece, or Phrenology incompatible with Reason*, by Daniel the Seer.

² For topographical purposes Broca's names are adopted as the most convenient for localities on the head.

³ Apollonius Rhodius speaking of the love of Medea for Jason (*Argonautica*, iii. 760-765) says, δάκρυ δ' ἐστ' ἀφ' ἀλγῶν βίω· ἰσχυρὸν δ' αἰὲν ἴσ' ὄδον εὐχόμενα δὴ χροῖο, ἀπὸ λήθης ἴσως καὶ κεφαλῆς, ὅτ' ἔταρον ἴσως ἄγχι.

2. Philoprogenitiveness (*Amour de la progéniture*), median, on the squama occipitis, and selected as the organ for the love of children because this part of the skull is usually more prominent in apes and in women, in whom the love of children is supposed to be stronger than in men.

3. Concentrativeness, below the obelion and over the lambda. This is a region of uncertain function, unnoticed by Gall, but described as Inhabitiveness by Spurzheim, because he found it large in cats and in a clergyman fond of his home. It has since been considered by Combe to be the seat of the power of concentration, whereof he believed Inhabitiveness to be a special case.

4. Adhesiveness (*Amitié*), over the lateral area of the lambdoidal suture. This region was prominent in a lady introduced to Gall as a model of friendship, and is said by him to be the region where persons who are closely attached put their heads together.

5. Combativeness (*Instinct de la défense*), above the asterion; it was found by Gall by examining the heads of the most quarrelsome of his low companions whom he had beforehand stimulated by alcohol. It was verified by comparing this region with the same part of the head of a quarrelsome young lady.

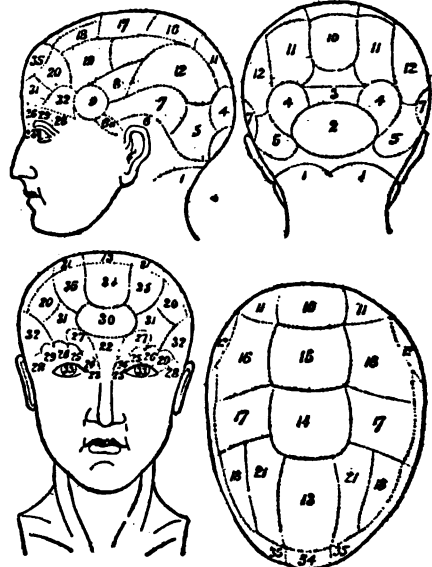

6. Destructiveness (*Instinct carnassier*), above the ear meatus. This is the widest part of the skulls of carnivorous animals, and was found large in the head of a student so fond of torturing animals that he became a surgeon, also large in the head of an apothecary who became an executioner.

6a. Alimentiveness, over the temporal muscle and above the ear. Hoppe describes it as being large in a gourmand acquaintance, and he therefore supposes it to be the origin of selecting food.

7. Secretiveness (*Ruse, Finesse*), the posterior part of the squamous suture.

8. Acquisitiveness (*Sentiment de la propriété*), on the upper edge of the front half of the squamous suture. This part of the head Gall noticed to be prominent in the pickpockets of his acquaintance.

9. Constructiveness (*Sens de mécanique*), on the stephanion; detected by its prominence on the heads of persons of mechanical genius. It was found large on the head of a milliner of uncommon taste and on a skull reputed to be that of Raphael.

The organ of Vitativeness, or love of life, is supposed by Combe to be seated at the base of the skull. To this locality Herophilus referred most of the intellectual powers.

Lower Sentiments.

10. Self-esteem (*Orgueil, fierté*), at and immediately over the obelion; found by Gall in a beggar who excused his poverty on account of his pride. This was confirmed by the observation that proud persons held their heads backwards in the line of the organ.

11. Love of Approbation (*Vainité*), outside the obelion; the region in which Gall saw a protuberance on the head of a hussar who fancied herself queen of France.

12. Cautiousness (*Circonspection*), on the parietal eminence; placed here because an ecclesiastic of hesitating disposition and a vacillating councillor of state had both large parietal eminences.

Superior Sentiments.

- 13. Benevolence (*Bonité*), on the middle of the frontal bone in front of the coronal suture; here Gall noticed a rising on the head of the highly commended servant of a friend, as well as on a benevolent schoolmate who nursed his brothers and sisters when they were ill. To this spot Xenocrates referred the intellectual powers.
- 14. Veneration (*Sentiment religieux*), median at the bregma. Gall noted when visiting churches that those who prayed with the greatest fervour were prominent in this region, and it was also prominent in a pious brother.
- 15. Conscientiousness, Believingness (Forster) unknown to Gall; recognized by Spurzheim usually from its deficiency, and placed between the last and the parietal eminence.
- 16. Firmness (*Fermeté*), median, on the sagittal suture from behind the bregma to the front of the obelion. Lavater first pointed out that persons of determination had lofty heads.
- 17. Hope, not regarded as primary by Gall, who believed hope to be *akia* to desire and a function of every faculty which desires and left this territory unallocated.
- 18. Wonder, said to be large in vision-seers and many psychic researchers. A second similar organ placed between this and the next is called *Mysteriaingness* by Forster, and is said to be the seat of belief in ghosts and in the supernatural.
- 19. Ideality (*Poésie*), noted by Gall from its prominence in the busts of poets; said to be the part touched by the hand when composing poetry.
- 20. Wit (*Esprit caustique*), the frontal eminence, the organ of the sense of the ludicrous, prominent in F. Rabelais and J. Swift.
- 21. Imitation (*Faculté d'imiter*), disposition to mimicry; placed between Benevolence and Wonder.

Perceptive Faculties.

- 22. Individuality, over the frontal sinus in the middle line; the capacity of recognizing external objects and forming ideas therefrom; said to have been large in Michelangelo, and small in the Scots.
- 23. Form (*Mémoire des personnes*), capacity of recognizing faces; gives a wide interval between the eyes; found by Gall in a squinting girl with a good memory for faces.
- 24. Size, over the trochlea at the orbital edge; described by Spurzheim and Vimont as the capacity of estimating space and distance.
- 25. Weight, outside the last on the orbital edge and, like it, over the frontal sinus. The prominence of ridge here is due to large sinus or a projecting bone. Certain old writers, such as Strato Physicus, located the whole intellect in this ridge.
- 26. Colour, also on the orbital edge external to the last.
- 27. Locality (*Sens de localité*), placed above Individuality on each side, and corresponding to the upper part of the frontal sinus and to the region immediately above it.
- 28. Number, on the external angular process of the frontal bone, large in a calculating boy in Vienna.
- 29. Order, internal to the last, first noted by Spurzheim in an orderly idiot.
- 30. Eventuality (*Mémoire des choses*), the median projection above the glabella, supposed to be the seat of the memory of events.
- 31. Time, below the frontal eminence and a little in front of the temporal crest.
- 32. Tune (*Sens des rapports des tons*), on the foremost part of the temporal muscle, where Gall noticed a bulge on the head of a musical prodigy of five.
- 33. Language (*Sens des mots*), behind the eye. This was the first organ noticed by Gall, as a clever schoolfellow, quick at languages, had prominent eyes. Old authors had noted the connexion between prominent eyeballs and mental development; thus Gazzali and Syrensis Medicus Cyprius place the intellect and soul behind the eyeballs.

Reflective Faculties.

- 34. Comparison (*Sagacité comparative*), median, at the top of the bare region of the forehead, where a savant friend of Gall's, fond of analogies, had a prominent boss.
 - 35. Causality (*Esprit métaphysique*), the eminence on each side of Comparison, noticed on the head of Fichte and on a bust of Kant; the seat of the faculty of correlating causes and effects.
- The first identification of each organ was made by an induction from very limited data, but the founders and exponents of the system have collected all available instances wherein enlargements of each of these regions coexisted with increased powers of the faculty supposed to reside therein, and in some cases they have discovered coincidences of a surprising nature. When, however, such do not exist, a convenient excuse is found by reference to the indefinite article of temperament, or by a supposed explanation of the faculty in question as not simple but produced by the co-operation of other influences. Thus, as Sheridan's bump of wit was small, he is said not to have been truly witty; but to have had comparison and memory strongly developed. The girl Labrosse (described in Féruasac's *Bulletin* for October 1831), who exhibited strong amativeness but had a rudimentary cerebellum, is said to have obliterated

it by over-use. Thurtell, a cold-blooded murderer, whose organ of benevolence was large, is said to have been generous, as he once gave half-a-guinea to a friend, &c.

The method whereby the sizes of organs are estimated is arbitrary and the boundaries of the regions indefinite. The attempts of Nicol, Straton and Wight to devise mechanical and accurate modes of measurement have not been very successful and have not found favour with the professional phrenologist.

Anatomical Aspect of Phrenology.—The phrenological controversy served the useful purpose of stimulating research into the anatomy of the brain; but we owe very little of solid progress to the advocates of the system. Gall is the only writer of his creed in whose works original observations of value are to be found, and Dr B. Holländer has cited many interesting and carefully recorded anatomical and clinical facts in his writings. Although the study of the surface of the cerebrum is of the essence of phrenology, yet nowhere in the circle of phrenological literature are the convolutions of the brain accurately described; our knowledge of their order and disposition comes from the morphologist, not from the phrenologist. The first real step towards their systematic description was made by L. Rolando,¹ who in 1830 described the fissure to which his name is attached, and very little advance was made until the publication in 1856 of L. P. Gratiolet's² and Huschke's³ memoirs. These works for the first time placed the description of the surface of the brain, imperfectly attempted by L. A. Desmoullins in 1825,⁴ on a satisfactory basis.

A description of the anatomy of the brain is given under the heading BRAIN, so it is necessary here only to refer to points not included in that account.

1. Any psychological theory which correlates brain-action and mental phenomena requires a correspondence between brain-size and mental power; and, speaking generally, the brains of those whose capacities are above the average are larger than those of the general run of their fellow-men.

2. Direct measurements of the relative developments of different portions of brains are difficult and troublesome to make; but their importance to phrenologists is so great that it is remarkable that no attempts to obtain any such were made by them. The series given by R. Wagner of the relative sizes of the cerebral lobes of four brains is almost the only record of importance in this direction, and is appended.

Brain of	Surface of Frontal Lobe	Surface of Parietal Lobe	Surface of Occipital Lobe	Surface of Temporo-Sphenoidal	Relation of Frontal Lobe (Perceptive and Reflective Organs) to whole Surface = 1.	Relation of Parietal Lobe (Sentiments) to Surface = 1.	Relation of Remaining Surface (Propensities) to Surface = 1.	Extent of Free Surface.	Extent of Surface of Involutions.	Total Extent of Surface.	Weight in Grammes.
Fuchs, clinical teacher . . .	143'4	60'5	50	67'5	410	203	340	1107	231'3	342	1500
Gauss, mathematician . . .	139	70'6	50'4	68'4	407	307	374	1128	228'3	341	1402
Workman . . .	113'2	69'3	50'3	62	385	214	385	97'4	103'0	291	1173
Woman . . .	130	65	51	66'8	400	304	360	107'5	200'0	317'4	1185

From this it appears that the woman exceeded Gauss in perceptive and reflective organs, exceeded Fuchs in sentiment, and fell below the workman in propensities. It must be said, however, that the phrenological divisions do not accurately coincide with the anatomical. It would furnish important physiological data if the brains of men distinguished for special qualities were examined in this or some comparable way.

3. It is important in relation to phrenology to ascertain the constancy of the convolutions. Many varieties in the detail of the surface-patterns have been recorded by Tenchini, Poggi, Giacomini, N. Rüdinger, Cunningham and Serrow,⁵ but the general plan is fairly uniform. A still more important question has been recently raised by J. N. Langley, viz. how far identical spots on

¹ *Della Struttura degli emisferi cerebrali* (Turin, 1830).

² *Mémoire sur les plis cérébraux de l'homme et des primates* (Paris, 1856).

³ *Schädel, Hirn, und Seele* (Jena, 1856).

⁴ Magendie and Desmoullins, *Anat. du syst. nerveux* (Paris, 1825).

⁵ *Rivista sperimentale di freniatria* (1883), ii. 193; *ibid.* iv. 403; *Archiv für Anthropologie* (1879), xi. 289.

individual convolutions in different brains consist of nerve-cells with precisely the same connexions. The convoluted arrangement results from growth of brain-surface under constraint, hence as the different tracts of surface undergo proportional overgrowth they may fold along different lines. The occurrence of small differences in the rate of overgrowth, testified to by the varieties of the resulting pattern, can hardly fail to cause considerable alteration in the place of definite territories of grey cells. Some method for the determination of the limits of these shiftings of place is required before comparisons can be of value as phrenological data.

4. The comparison of the rate of growth of brain with the development of mental faculties is important not only to the phrenologist but to the psychologist. No observations on this point were made by phrenological writers, who only refer to the first and rather crude observations of the earlier anatomists. We have, however, recently learned from the researches of T. L. W. von Bischoff, Tuzzeo, Cunningham, and S. Exner¹ many particulars as to the rate and progress of brain-growth. At birth the brain weighs one-tenth of the weight of the body, and averages about 11 oz. For the first year brain-growth and consequently expansion of the skull proceed with great rapidity, the growth during a large part of this period averaging one cubic centimetre daily. This enormous increase is chiefly due to the rapid development of medullated nerve-fibres, which are deficient in the foetal brain. During the second and third years growth takes place more slowly, the occipital and parietal lobes increasing more than the frontal or temporo-sphenoidal. During these and the four succeeding years the base elongates commensurately with the increasing depth of the face. In the sixth and seventh years the frontal lobes grow faster than the parietals, and at seven the average brain has attained the weight of 1340 grammes, being the weight of the body as 1:20. In the period between seven years and puberty growth is slight, but at puberty the whole brain grows actively, especially the frontal lobes. This activity lasts until about eighteen years of age, then diminishes; but the average brain does not reach its maximum size until about thirty, from a little after which period the brain tends to diminish towards senility.²

5. The estimation of the relative development of grey and white matter in the several lobes is important to any theory of cerebral dynamics which allocates functions specifically diverse to each separate part of the brain-surface; but no attempt has been made by the phrenologist to obtain precise results in this direction, nor even to determine the physical constants of the two forms of brain-matter. The recently introduced method of Bourgoin and B. Danilewski, based upon the differing specific gravities of grey and white matter, promises to give definite information as to the relative amounts of these forms of brain-matter; but further experiments are needed to perfect the method.³

6. The relations, if any, between the alterations which take place in the shape and position of the head and alterations in brain-surface have been speculated on by the phrenologist. Broussais is reported to have said that his organ of causality had enlarged with increasing use, and a list of cases of similar alterations of head-shape is given by Deville (*Phren. Journ.* xv. 32), most of which are simply age-changes, of the kind described by Professor J. Cleland (*Phil. Trans.*, 1870). There are no exact measurements recorded which indicate the occurrence of topical increases of a normal brain in special directions coincident with the cultivation of definite faculties. All the so-called cases are given vaguely, with no measurements, and the careful measurements of George Combe in such cases as were available to him showed no appreciable alterations in adult heads even at long intervals of time (see also Andrew Combe, *Phren. Journ.* x. 414).

7. The phrenological want of knowledge of the topography of the brain-surface was necessarily correlated with ignorance of the exact relations of the convolutions to the interior of the cranial bones; these have been carefully worked out by E. Huschke, Heffler, W. A. Turner, Cunningham and Reid. Some latitude, however, must be allowed in topography, as the exact relation of convolution of skull varies with the shape of the skull. Giacomini showed that the fissure of Rolando is perceptibly farther back from the coronal suture in dolichocephalic than in brachycephalic skulls, and it is still farther back in the extreme boat-shaped form of long-headedness. Passet shows that there is a slight topographical difference in the two sexes (*Arch. f. Anatrop.*, 1882, xiv. 89), and in the heads of those with a symmetrically-shaped skull there is often a want of lateral symmetry of convolution. Artificial deformations likewise alter the topographical relations of convolutions, and have served not a little to puzzle the phrenologist. Thus, the artificial dolichocephaly of the Caribs having bulged the squama occipitis, they decided that these people must be amiable lovers of children,⁴ &c.

¹ *Neurologisches Centralblatt* (1883), p. 457.

² Weisbach, *Med. Jahrbuch. der k. Gesellschaft, der Aerzte*, xvii. 133 (Vienna, 1869); Merkel, *Beiträge z. post-embryonalen Entwicklung des menschl. Schädel* (Bonn, 1882); Calori, *Mem. de l'Acad. di Bologna* (1871), x. 35. Cunningham, *Cunningham Memoir*, Royal Irish Academy.

³ *Centralblatt* (1880), No. 14; *Beiträge zur Biologie* (Stuttgart 1882).

⁴ Martius tells us that the Caribs castrate their own children.

8. The existence of structural differences between different areas of cerebral surface is important to any theory of cerebral localization, but no phrenologist has given us any original information on this point. Since the investigation of J. G. F. Baillarger⁵ and Bevan-Lewis it has been shown that some local differentiations of structure do really exist. Thus in the convolutions around the fissure of Rolando the ganglion-cells of the fourth layer are of large size (giant-cells of Betz), and in the convolutions of the temporo-sphenoidal lobe a layer of small angular cells (granule-cells) is interposed between the larger pyramidal and the ganglion-cells, so that, while in the parts of the brain above the fissure of Sylvius the grey cortex is for the most part five-layered, below and behind that fissure it is six-layered. There is no abrupt passage from the one to the other, the only sudden transition of structure of the grey cortex being at the hippocampal sulcus; and giant-cells, although of smaller size, and less like those of the anterior cornu of the spinal cord, are scattered over other parts of the cerebral grey matter.⁶

Other local variations in structure have been described by Elliot Smith and other histologists.

The teaching of anatomy with regard to phrenology may be summarized thus: (1) the rate of growth of brain is concurrent with the rate of development of mental faculty; (2) there is some degree of structural differentiation as there are varying rates of development of different parts of the cerebral surface; (3) there is no accordance between the regions of Gall and Spurzheim and definite areas of cerebral surface.

Physiological Aspect.—The theory of some of the older metaphysicians, that the mind, in feeling and reflection, makes use of no material instrument is not now accepted by psychologists. It was advanced by Brougham and Jeffrey as against the theory of phrenology; but the doctrine that the brain is the organ of the mind is now universally received. While it is probable that certain molecular changes in the grey matter are antecedents or concomitants of mental phenomena, the precise nature of these processes, to what extent they take place, or how they vary among themselves have not as yet been determined experimentally; the occurrence of the change can only be demonstrated by some such coarse method as the altered pulsation of the carotid arteries,⁷ the increase of the temperature of the head,⁸ the abstraction, during brain-action, of blood from other organs as shown by the plethysmograph, or the formation of lecithin and other products of metabolism in brain-substance. As yet no light has been shed on the connexion between the molecular changes in the nerve-cell and the phenomena of thought and feeling. While our knowledge of the anatomy of the brain, especially of the grey nuclei and of the white bands uniting them, has in recent years become much more accurate (see articles BRAIN and MUSCLE AND NERVE), our knowledge of the physiology of the nerve-centres is still indefinite and fragmentary, even when the utmost allowance is made for the experimental work of C. S. Sherrington, A.S.F. Grünbaum, F. Goltz and others; and the hypotheses relating to the division of labour in the nerve-centres is chiefly based on anatomical structure. Certain masses of grey nerve-matter situated in the spinal cord and medulla oblongata are so linked by nerve-cords to organs outside the nervous system which are set apart for the discharge of separate functions that they obviously form parts of the mechanism for the fulfilment of such functions. In cases where these can be subjected to experiment we learn that they are nervous centres presiding over the discharge of such functions; and it has been determined by experiment, or else deduced from anatomical structure, that in those lower parts of the nervous centres which are more directly connected with the segmental elements of the body there is a certain localization of function; hence the centres of pelvic actions, of respiration, cardiac action, and inhibition of vaso-motor influence, deglutition, secretions, &c., can be mapped out in ascending series. As certain of these centres are united by bands of fibres to the larger

fatten and eat them, an abuse of the organ of philoprogenitiveness; see also Garcilaso de la Vega, *Hist. des Incas*, l. 12.

⁵ *Mém. de l'Acad. de médecine* (1840), viii. 149.

⁶ For further particulars of structure, in addition to the authors quoted at l. 878, see Bevan-Lewis and Clark, *P.R.S.*, (1878), and *Phil. Trans.* (1880 and 1882).

⁷ See Eugene Gley, "Sur les conditions physiologiques de la pensée," in *Archives de physiologie* (1881), p. 742.

⁸ J. S. Lombard, *N. Y. Med. Journal* (June 1869), and *Experimental Researches on the Regional Temperature of the Head* (London, 1872).

and higher-lying grey portions of the nervous centres there is an a priori presumption in favour of the extension of this principle of localization. This has been premised on metaphysical as well as on anatomical grounds. A. B. Bonnet long ago believed each portion of the brain to have a specifically separate function, and Herbert Spencer has said that "no physiologist can long resist the conviction that different parts of the cerebrum subserve different kinds of mental action. Localization of function is the law of all organization; separateness of duty is universally accompanied with separateness of structure, and it would be marvellous were an exception to exist in the cerebral hemispheres. Let it be granted that the cerebral hemispheres are the seats of the higher psychical activities; let it be granted that among these higher psychical activities there are distinctions of kind which, though not definite, are yet practically recognizable, and it cannot be denied, without going in direct opposition to established physiological principles, that these more or less distinct kinds of psychical activity must be carried on in more or less distinct parts of the cerebral hemisphere."

For a masterly review of the old and the new association and localization theories, see W. Wundt's *Grundsätze der physiologischen Psychologie*, i. 289 sqq.; also the same author's *Essays*, Leipzig (1888), pp. 109 sqq.

There is a large weight of evidence in favour of the existence of some form of localization of function. So little is known of the physical changes which underlie psychical phenomena, or indeed of the succession of the psychical processes themselves, that we cannot as yet judge as to the nature of the mechanism of these centres. So much of the psychic work of the individual life consists in the interpretation of sensations and the translation of these into motions that there are strong a priori grounds for expecting to find that much of the material of the nerve-centres is occupied with this kind of work, but in the present conflict of experimental evidence it is safer to suspend judgment. That these local areas are not centres in the sense of being indispensable parts of their respective motor apparatuses is clear, as the function abolished by ablation of a part returns, though tardily, so that whatever superintendence the removed region exercised apparently becomes assumed by another part of the brain.¹ Experimental physiology and pathology, by suggesting other functions for parts of the brain-surface, are thus directly subversive of many details of the phrenology of Gall and Spurzheim.

Psychological Aspect.—The fundamental hypothesis which underlies phrenology as a system of mental science is that mental phenomena are resolvable into the manifestations of a group of separate faculties. A faculty is defined as "a convenient expression for the particular states into which the mind enters when influenced by particular organs; it is applied to the feelings as well as to the intellect, thus the faculty of benevolence means every mode of benevolence induced by the organ of benevolence" (Combe). In another work the same author says it is "used to denote a particular power of feeling, thinking, perceiving, connected with a particular part of the brain." The assumption is contained in the definition that the exercise of a faculty is the physical outcome of the activity of the organ, and in several of the standard works this is illustrated by misleading analogies between these and other organs; thus the organs of benevolence and of firmness are said to be as distinct as the liver and pancreas. The mind, according to another author, consists of the sum of all the faculties. In this view the unity of consciousness is somewhat difficult to explain, and consequently there is assumed by others a single unifying substratum, and on this the organs are supposed to act; thus thoughts are defined as "relations of the simple substance, mind, to certain portions of the encephalon" (Welsh, *Phren. Journ.* i. 206). Gall himself believed that there was but a single principle which saw, felt, tasted, heard, touched, thought and willed (*Fonctions du cerveau*, i. 243); and the American exponent of phrenology, Caldwell, says "the mind is as single in its power as it is in its substance;

¹ For cases, see Rochefontaine, *Archives de Physiologie* (1883), 28; Bianchi, *La Psichiatria*, i. 97.

it is a quickening and operating principle, essential to all the mental faculties, but does not, by any means, possess them itself" (*Elements*, p. 16). It is not easy to understand the supposed relation of this hypothetical substratum to the separate faculties acting on it. It must be both immaterial and unconnected with the brain, as the whole two thousand million cells supposed to exist in the cerebral hemispheres are all parcelled out among the faculties, and none are left for the unifying *now*.

Each organ is considered as engaged, either independently in bringing forth its own product, or collectively with others in elaborating compound mental states, and according to their several degrees of development and activity they are considered capable of perceiving, conceiving, recollecting, judging or imagining each its own subject. This mechanical conception of the division of labour in the production of the phenomena of mind has the charm of simplicity, but is attended with the difficulty that arises in discriminating the operations of the different organs one from the other. Phrenologists are apt to be vague respecting the limits of the several faculties, as about the boundaries of the separate organs. It was pointed out by Jeffrey that the lines of demarcation between benevolence, adhesiveness and philoprogenitiveness were indeterminate, although the organs are not very close, and the same applies to other organs.

It is unfortunate for the clearness of the definition that, although historically the faculties were the first phenomena noted, independent of and previous to their localization, yet in the definition the faculties are defined in terms of their localities.

The following arguments are adduced in favour of the fundamental separateness of the faculties: (1) analogy—elsewhere in the animal economy division of labour is the rule; (2) the variety of mental endowment observed among children before they are influenced by education, and the inequalities in the mental endowments of individuals; (3) the phenomena of insanity, especially of monomania; (4) the varying periods at which individual faculties attain their maximum development; (5) the phenomena of dreams, and the awakening of a limited number of faculties during them; (6) pain being felt in an organ when it is overtaxed.²

Such faculties are supposed to be primary—(1) as exist in some animals and not in others, (2) as vary in their development in the sexes, (3) as are developed in varying proportions with regard to other faculties, (4) as may act separately from other faculties, (5) as are not necessarily simultaneous with other faculties in action, (6) as are hereditary, and (7) as may be singly diseased.

According to the development of their powers mankind may be divided into six classes: (1) those in whom the highest qualities are largely developed and the animal qualities feeble; (2) those with the reversed conditions developed, with large animal and feeble intellectual and moral faculties; (3) those in whom good and evil are in constant war, with active animal and strong intellectual faculties and sentiments; (4) those partial geniuses in whom a few qualities are unusually developed, while the rest are at or below the mediocre standard; (5) those men of moderate endowment in whom some faculties are nearly or quite deficient; (6) those with an unvarying standard of undistinguished mediocrity in all their faculties.

It is perhaps unfortunate that the word "faculty" has been used in this sense of original power by phrenologists. It would have been better to employ, as Mr Lewes suggests, the term

² It is interesting in this connexion to note that in a case published by Professor Hamilton in *Breain* (April 1884), where a tumour existed on the occipital lobe, the pain was persistently referred to the forehead. Many similar cases are to be noticed among the records of localized brain-lesions. Bearing on this point also it is worth noting, once for all, that in nothing is the purely hypothetical nature of phrenological description better realized than in the accounts of what these authors call the "natural language of the faculties,"—that poets are supposed to touch ideality when composing, musicians to press on tone and time, and painters on form and colour, when in the exercise of their arts! Yet we are grately taught this in the standard works on the subject.

"function" for the native activity of an organ, and to leave "faculty" for the expression of an acquired activity. "Faculty is properly limited to active power, and therefore is abusively applied to the mere passive affections of the mind" (Hamilton, *Lectures*, i. 177).

An attempt has been recently made by Dr Bernard Holländer to correlate the doctrines of phrenology with the modern physiological and pathological observations which bear upon the localization of function. In his works *The Mental Functions of the Brain*, under the sub-title "The Revival of Phrenology" (1901), and in *Scientific Phrenology* (1902), the author endeavours to bring Gall's clinical and pathological instances into line with more modern observations. He deprecates the craniology of Gall, as far as it deals with mere "bumps," and honours him, with justice, as the recorder of many facts worth saving out of the wreck of his system; and he endeavours, though with doubtful success, to establish an unbroken connexion between phrenology, in the Greek sense, and our present knowledge of cerebral localization.

The substance of Holländer's first work is of two kinds. The one kind is a tabulated statement of many hundred cases of different forms of mania, with injury or disease limited to one portion of the brain; the other kind is a tabulated statement of cases of injury or disease of the brain, followed by perversion, or exaltation, or loss of some definite instinct or faculty of consciousness.

He divides the tabulated cases of mania into three groups: (i) Melancholia; (ii) Irascible Insanity, "Mania furiosa"; (iii) Mania with suspicion and delusions of persecution. For these three groups of cases he lays down the following rules: (i) Melancholia is especially associated with injury or disease of the parietal lobe of the brain, more particularly with injury or disease of the convolutions underlying the parietal eminences of the skull, i.e. the supramarginal and angular convolutions. (ii) Mania furiosa is especially associated with injury or disease of the central portion of the temporal lobe. (iii) Mania with suspicion and delusions of persecution is especially associated with injury or disease of the posterior portion of the temporal lobe.

The second kind of cases, where injury or disease of the brain, strictly localized to one part or another of its grey matter, was followed by perversion, exaltation or loss of some one instinct, habit or faculty, includes cases of kleptomania, cases of voracious hunger and thirst, cases of sexual desire exalted or lost, and cases of loss of certain special memories, as of words, tunes, numbers and the like.

These two collections of recorded cases, taken from a vast mass of clinical and pathological literature accumulated during the past century, have been arranged by Dr Holländer with great industry; so as to extend the limits of the study of cerebral localization, and to advance it from the observation of the motor areas and the special sense centres to the observation of the higher acts and states of consciousness. Modern physiology, from its objective point of view, is engaged over finer and finer issues of microscopic and experimental work; and, from its subjective point of view, is becoming more and more psychological, seeking a higher level of interpretation, and a statement of the departmental life of the brain in terms of ever-increasing complexity. The motor centres, governing the voluntary purposeful movements of the body, are considered to be not simply motor, but "psycho-motor"; the speech-centres are not homogeneous, but are on experimental grounds differentiated into sub-centres for the utterance of words, the recognition of words and the understanding of words; the visual centres are in like manner subdivided according to the consciousness involved in the complete act of vision. There is room, therefore, for a "higher phrenology," if it can show clear evidence in favour of the localization, in determinate regions of the brain, of the physical changes accompanying certain states of consciousness.

Of the two kinds of cases that Dr Holländer has tabulated, it cannot be said that the cases of mania are convincing. Some of them are altogether beside the mark; e.g. he quotes two cases of melancholia, after an injury over the left parietal bone, which were cured by an operation limited to the scalp (excision of a painful scar, removal of a small nerve-tumour of the scalp); in neither case was anything done to the skull or to the brain, but both patients were cured of their melancholy. Again, the acceptance of these rules as to the localization of these insane thoughts involves the localization of sane thoughts in the same areas of the brain, and this in turn involves assumptions that are wholly unwarranted by our present knowledge. Moreover, cases of mania are so common that it might be possible to find an equal number of cases to controvert his rules: we want *consecutive*, not *picked* cases. If 5000 consecutive fatal cases of these different kinds of mania, with the post mortem record of each case, were tabulated, we should then begin to stand on surer ground. Again, though Dr Holländer seems to argue well, where he says that the facial and other movements, induced by direct electrical stimulation of certain convolutions are such as express the mental states which he attributes to those

convolutions, yet this argument is insecure, partly because Sherrington's recent work, on the motor area of the anthropoid apes, has rendered it necessary to reconsider the present localization of the motor area in man, and partly because the interpretation of facial and muscular movements as representing this or that state of the emotions is always precarious.

The second kind of cases, where injury or disease limited to one portion of the brain is followed by perversion, exaltation or loss of some special instinct or habit, is more valuable and more convincing; especially the cases of voracious hunger and thirst, those of true kleptomania, and those of the loss of certain special memories. It is not so easy to believe that the cerebellum is in any primary way associated with sexual desire: its position, its structure and its proved association with the co-ordination of muscular movements seem clearly to indicate that its work is wholly subordinate and complementary to the work of the cerebral hemispheres; and the evidence adduced in favour of its being the "seat" of the sexual impulses hardly amounts to more than a probability that it may transmit or co-ordinate the performance of the sexual act.

Practical Application.—"Die Schädellehre ist allerdings nicht so sehr Irrthum in der Idee als Charlatanerie in der Ausführung," says one of its most acute critics. Even though no fault could be found with the physiology and psychology of phrenology, it would not necessarily follow that the theory could be utilized as a practical method of reading character; for, although the inner surface of the skull is moulded on the brain, and the outer surface approximates to parallelism thereto, yet the correspondence is sufficiently variable to render conclusions therefrom uncertain. The spongy layer or diploe which separates the two compact tables may vary conspicuously in amount in different parts of the same skull, as in the cases described by Professor Humphry (*Journ. of Anat.* viii. 137). The frontal sinus, that *opprobrium phrenologicum*, is a reality, not unfrequently of large size, and may wholly occupy the regions of five organs. The centres of ossification of the frontal and parietal bones, the muscular crests of these and of the occipital bones also, differ in their prominence in different skulls. Premature synostoses of sutures mould the brain without doing much injury to its parts. In such cases there are compensatory dilatations in other directions modifying sometimes to an extreme degree the relation of brain-surface to skull-surface. The writer has found such displacements in extremely scaphocephalic skulls; the same is true of accidental deformations due to pressure on the infantile skull before it consolidates. Artificial malformations alter the apparent skull shape considerably while they affect the relative development of the parts of the brain cortex but little. All these and other cogent reasons of a like kind, whose force can be estimated by those accustomed to deal with the component soft parts of the head, should lead phrenologists to be careful in predicating relative brain-development from skull-shape. Psychology, physiology and experience alike contribute to discredit the practical working of the system and to show how worthless the so-called diagnoses of character really are. Its application by those who are its votaries is seldom worse than amusing, but it is capable of doing positive social harm, as in its proposed application to the discrimination or selection of servants and other subordinate officials. It has even been proposed to use it for the purposes of the guarantee society and for the selection of parliamentary representatives. The sarcastic suggestion which originated with Christopher North of moulding children's heads so as to suppress the evil and foster the good was actually repeated in good faith by a writer on phrenology, but experience of the effects of malformation leads one to be sceptical as to the feasibility of this mode of producing a social Utopia.

BIBLIOGRAPHY.—Prochaska, *Functions of the Nervous System* (tr. by Laycock, in Sydenham Society's series, 1851); Gall, *Recherches sur le système nerveux*, &c. (Paris, 1809); *Anatomie et physiologie du système nerveux*, &c. (Paris, 1810-1819); *Traité des dispositions innées de l'âme et de l'esprit* (Paris, 1811) and *Sur les fonctions du cerveau* (6 vols., 1825); Boryk, *Bemerkungen u. Zweifel über die Schädellehre des Dr. Gall* (Leipzig, 1803); Marton, *Zwölftausend Darstellung der Gehirn- und Schädellehre* (Leipzig, 1803); Metzger, *Ueber den menschlichen Kopf* (Königsberg, 1803); Walther, *Neue Untersuchungen der Gall'schen Gehirn- und Schädellehre* (Münster, 1804); Kessler, *Prüfung des Gall'schen Systems* (Jena, 1805); Wischhoff, *Darstellung der Gall'schen Gehirn- und Schädellehre*, &c. (Berlin, 1805); Ackermann, *Die Gall'sche Gehirnlehre widerlegt* (Heidelberg, 1806);

Himly, *Erörterung der Gall'schen Lehre* (Halle, 1806); Thomas I. M. Forster, "Sketch of the New Anatomy and Physiology of the Brain," in *Famphlet* (1815, vol. v, pt. ix., No. 10, reprinted with additions, 1817); Spurzheim, *The Physiological System of Gall and Spurzheim* (London, 1815); *Phrenology, or the Doctrine of the Mind* (1825), and *The Anatomy of the Human Brain* (1826), Gordon, *Observations on the Structure of the Brain, comprising an estimate of the Claims of Gall and Spurzheim*, 8c. (1817); *Three Familiar Lectures on Crassological Phrenology*, anonymous and satirical (London, Wilson, 1816); G. Combe, *Essays on Phrenology* (Edinburgh, 1819), *Elements of Phrenology* (1822), *System of Phrenology* (1825), *Constitution of Man* (1827), *Lectures on Phrenology by Boardman* (1839), and *Outlines of Phrenology* (1847); Dewhurst, *Guide to Human and Comparative Phrenology* (London, 1831); Otto, *Phrenologien eller Galls og Spurzheims Hjerne- og Organlære* (Copenhagen, 1825), Broussais, *Cours de phrénologie* (Paris, 1836); Vimont, *Traité de Phrénologie humaine et comparée* (1836); Noël, *Grundzüge der Phrénologie* (Leipzig, 1836 and 1856), and *Die materielle Grundlage des Seelenlebens* (Leipzig, 1874); Macnish, *Introduction to Phrenology* (Glasgow, 1836); Capen, *Phrenological Library* (Boston, 1836); Ferrarese, *Memorie riguardanti la dottrina frenologica* (1836-1838); Watson, *Statistics of Phrenology* (1836); Azais, *Traité de la phrénologie* (Paris, 1839); Sidney Smith, *Principles of Phrenology* (Edinburgh, 1838); Joshua T. Smith, *Synopsis of Phrenology*; Forchon, *Le Matérialisme et la phrénologie comparée* (Paris, 1840); K. G. Carus, *Grundsätze einer neuen und wissenschaftlich begründeten Kränkschöpfe* (Stuttgart, 1841), and *Atlas der Kränkschöpfe* (1864); Casile, *Die Phrénologie* (Stuttgart, 1845); Struve, *Geschichte der Phrénologie* (Heidelberg, 1843); Ijijee, *Cours de phrénologie* (Paris, 1847); Flourbès, *Essais de la phrénologie* (Paris, 1842), *De la Phrénologie* (1863); Serrurier, *Phrénologie morale* (Paris, 1840), Mariano Cubi i Soler, *Leçons de phrénologie* (Paris, 1857); Morgan, *Phrenology*; Donovan, *Phrenology*; Struve and Hirschfeld, *Zeitschrift für Phrenologie* (Heidelberg, 1843-1845); *Phrenological Journal* (20 vols., 1823-1847); Lelut, *Qu'est ce que la phrénologie?* (1836), and *Rejet de l'organologie phrénologique* (1843); Scheve, *Katechismus der Phrénologie* (Leipzig, 1896); Tupper, *Enquiry into Dr Gall's System* (1819); Wayte, *Anti-phrenology* (1829); Stone, *Observations on the Phrenological Development of Murderers* (Edinburgh, 1829); Epps, *Horae Phrenologicae* (1829); Crook, *Compendium of Phrenology* (1878); Aken, *Phrenological Bijou* (1839); Hall, *Phreno-Magnet* (1843); Holländer, *The Mental Functions of the Brain* (1901), *Scientific Phrenology* (1902). (A. M.A.)

PHRYGIA, the name of a large country in Asia Minor, inhabited by a race which the Greeks called *Ἰφρυγες, freemen*.¹ Roughly speaking, Phrygia comprised the western part of the great central plateau of Anatolia, extending as far east as the river Halys; but its boundaries were vague,² and varied so much at different periods that a sketch of its history must precede any account of the geography. According to unvarying Greek tradition the Phrygians were most closely akin to certain tribes of Macedonia and Thrace; and their near relationship to the Hellenic stock is proved by all that is known of their language and art, and is accepted by almost every modern authority. The country named Phrygia in the better known period of history lies inland, separated from the sea by Paphlagonia, Bithynia, Mysia and Lydia. Yet we hear of a Phrygian "thalassocracy" at the beginning of the 9th century B.C. The Troad and the district round Mt Sipylus are frequently called Phrygian, as also is the seaport Sinope; and a district on the coast between Sestos and the river Cius was regularly named Little Phrygia; names like Mygdones, Doliones and Phryges or Briges, &c., were widely current both in Asia Minor and in Europe. The inference has been generally drawn that the Phrygians belonged to a stock widespread in the countries which lie round the Aegean Sea. There is, however, no conclusive evidence whether this stock came from the east over Armenia, or was European in origin and crossed the Hellespont into Asia Minor; but modern opinion inclines decidedly to the latter view.

According to Greek tradition there existed in early time a Phrygian kingdom in the Sangarius valley, ruled by kings among whom the names Gordius and Midas were common. It was known to the ancient Greeks of Ionia and the Troad as something great and half-divine. When the goddess appeared to her favourite Anchises she represented herself as daughter of the king of Phrygia; the Phrygians were said to be the oldest people,

¹ The meaning is given in Hesych., s.v. "Ἰφρυγες."

² The difficulty of specifying the limits gave rise to a proverb—*ἄπειρος τὰ Ἰφρυγῶν*.

and their language the original speech of mankind; the Phrygian kings were familiar associates of the gods, and the heroes of the land tried their skill against the gods themselves, we hear of the well-walled cities of Phrygia and of the riches of its kings. Tradition is completely corroborated by archaeological evidence. In the mountainous region on the upper waters of the Sangarius, between Kutaiah Ezki Shehr and Afium (Afom) Kara Hissar, there exist numerous monuments of great antiquity, showing a style of marked individuality, and implying a high degree of artistic skill among the people who produced them. On two of these monuments are engraved the names of "Midas the King" and of the goddess "Kybile the Mother." Even the title "king" (*βασιλεύς*) appears to have been borrowed by Greek from Phrygian.

It is impossible to fix a date for the beginning of the Phrygian kingdom. It appears to have arisen on the ruins of an older civilization, whose existence is revealed to us only by the few monuments which it has left. These monuments, which are found in Lydia, Phrygia, Cappadocia and Lycæonia, as well as in north and central Syria, point to the existence of a homogeneous civilization over those countries; they show a singularly marked style of art, and are frequently inscribed with a peculiar kind of hieroglyphics, engraved *baustrophodon*; and they originated probably from a great Hittite kingdom, whose kings ruled the countries from Lydia to the borders of Egypt. There can be traced in Asia Minor an ancient road-system, to which belongs the "royal road" from Sardis to the Persian capital, Susa (Herod. v. 55). The royal road followed a route so difficult and circuitous that it is quite unintelligible as the direct path from any centre in Persia, Assyria or Syria to the west of Asia Minor. It can be understood only by reference to an imperial centre far in the north. The old trade-route from Cappadocia to Sinope, which had passed out of use centuries before the time of Strabo (pp. 540, 546), fixes this centre with precision. It must be far enough west to explain why trade tended to the distant Sinope,³ hardly accessible behind lofty and rugged mountains, and not to Amisus by the short and easy route which was used in the Græco-Roman period. This road-system, then, points distinctly to a centre in northern Cappadocia near the Halys. Here must have stood the capital of some great empire connected with its extremities, Sardis or Ephesus on the west, Sinope on the north, the Euphrates on the east, the Cilician Gates on the south, by roads so well made as to continue in use for a long time after the centre of power had changed to Assyria, and the old road-system had become circuitous and unsuitable.⁴ The precise spot on which the city stood is marked by the great ruins of Boghas Keui, probably the ancient Pteria, of which the wide circuit, powerful walls and wonderful rock-sculptures make the site indisputably the most remarkable in Asia Minor. On this site Winckler found in 1907 the records of the Hittite kings who fought against Egypt and Assyria.

The ancient road from Pteria to Sardis crossed the upper Sangarius valley, and its course may be traced by the monuments of this early period. Close to its track, on a lofty plateau which overhangs the Phrygian monument inscribed with the name of "Midas the King," is a great city, inferior indeed to Pteria in extent, but surrounded by rock-sculptures quite as remarkable as those of the Cappadocian city. The plateau is 2 m. in circumference, and presents on all sides a perpendicular face of rock 50 to 200 ft. in height. This natural defence was crowned by a wall partly Cyclopean, partly built of large squared stones.⁵ This city was evidently the centre of the old Phrygian kingdom

³ *Ἰφρυγία* on the Midas tomb. It is expressly recorded that *Ἰφρυγία* is a Lydian word. *Bescher* resists all attempts to explain it as a purely Greek formation, and the termination assimilates it to certain Phrygian words.

⁴ Sinope was made a Greek colony in 751 B.C., but it is said to have existed long before that time.

⁵ When the Persians conquered Lydia they retained, at least for a time, this route, which they found in existence.

⁶ The stones have all fallen, but the line where they were fitted on the rock can be traced by any careful explorer. The small fortress Fishmish Kalessi is a miniature of the great city beside it. (See Perrot, *Explor. Archéol.* p. 169 and pl. viii.)

of the Sangarus valley, but at least one of the monuments in it seems to belong to the older period of Cappadocian supremacy, and to prove that the city already existed in that earlier time. The Phrygian kingdom and art therefore took the place of an older civilization. It is probable that the tradition of battles between the Phrygians and the Amazons on the banks of the Sangarus preserves the memory of a struggle between the two races and the victory of the Phryges.

Of the monuments that exist around this city two classes may be confidently referred to the period of Phrygian greatness. That which is inscribed with the name of "Midas the King" is the most remarkable example of one class, in which a large perpendicular surface of rock is covered with a geometrical pattern of squares, crosses and meanders, surmounted by a pediment supported in the centre by a pilaster in low relief. In some cases a floral pattern occupies part of the surface, and in one case the two sides of the pediment are filled by two sphinxes of archaic type.¹ In some of these monuments a doorway is carved in the lower part; the door is usually closed, but in one case, viz. the sphinx monument just alluded to, the valves of the door are thrown wide open and give access to a little chamber, on the back of which is sculptured in relief a rude image of the Mother-goddess Cybele, having on each side of her a lion which rests its forepaws on her shoulder and places its head against hers. Sometimes a grave has been found hidden behind the carved front; in other cases no grave can be detected, but it is probable that they are all sepulchral.² The imitation of woodwork is obvious on several monuments of this kind. The second class is marked by the heraldic type of two animals, usually lions rampant, facing one another, but divided by a pillar or some other device. This type is occasionally found conjoined with the preceding; and various details common to both classes show that there was no great difference in time between them. The heraldic type is used on the monuments which appear to be the older, and the geometrical pattern is often employed on the inscribed monuments, which are obviously later than the earliest uninscribed. Monuments of this class are carved on the front of a sepulchral chamber, the entrance to which is a small doorway placed high and inaccessible in the rocks. There are also many rock monuments of the Roman time.

Early Phrygian art stands in close relationship with the art of Cappadocia. The monuments of the type of the Midas tomb are obviously imitated from patterns which were employed in cloth and carpets and probably also in the tilework on the inside of chambers varying slightly according to the material. Such patterns were used in Cappadocia, and the priest in the rock-sculpture at Ibriz wears an embroidered robe strikingly similar in style to the pattern on the Midas tomb; but the idea of using the pattern as the Phrygians did seems peculiar to themselves. The heraldic type of the second class is found also in the art of Assyria, and was undoubtedly adopted by the Phrygians from earlier art; but it is used so frequently in Phrygia as to be specially characteristic of that country.³ While Phrygian art is distinctly non-Oriental in spirit, its resemblance to archaic Greek art is a fact of the greatest importance. It is not merely that certain types are employed both in Phrygia and in Greece, but several favourite types in early Greek art can be traced in Phrygia, employed in similar spirit and for similar purposes. The heraldic type of the two lions is the device over the principal gateway of Mycenae, and stamps this, the oldest great monument on Greek soil, with a distinctly Phrygian character. Mycenae was the city of the Pelopidae, whom Greek tradition unhesitatingly declares to be Phrygian immigrants. A study of the topography of the Argive plain suggests the conclusion that Mycenae,

¹ Published in *Journ. Hell. Stud.* (1884).

² The monuments of Phrygia fall into two groups, which probably mark the sites of two cities about 16 m. distant from each other, Metropolis and Conni. One group lies round the villages of Yazili-Kaya, Kumbet, Yapuldak and Bakahish; the other beside Liyen, Bei Keui, Demirli and Ayazin.

³ The heraldic type continues on gravestones down to the latest period of paganism. Carpets with geometrical patterns of the Midas-tomb style are occasionally found at the present time in the houses of the peasantry of the district.

Midea and Thyrs form a group of cities founded by an immigrant people in opposition to Argos, the natural capital of the plain and the stronghold of the native race. Midea appears to be the city of Midas, and the name is one more link in the chain that binds Mycenae and Phrygia. This connexion, whatever may have been its character, belongs to the remote period when the Phrygians inhabited the Aegean coasts. In the 8th and probably in the 9th century B.C. communication with Phrygia seems to have been maintained especially by the Greeks of Cyme, Phocaea and Smyrna. About the end of the 8th century Midas, king of Phrygia, married Damodice, daughter of Agamemnon, the last king of Cyme. Gyges, the first Mermnad king of Lydia (687-653), had a Phrygian-mother. The worship of Cybele spread over Phocaea to the west as far as Massilia: rock monuments in the Phrygian style and votive reliefs of an Anatolian type are found near Phocaea. Smyrna was devoted to the Phrygian Meter Sipyrene. It is then natural that the Homeric poems refer to Phrygia in the terms above described, and make Priam's wife a Phrygian woman. After the foundation of the Greek colony at Sinope in 751 there can be no doubt that it formed the link of connexion between Greece and Phrygia. Phrygian and Cappadocian traders brought their goods, no doubt on camels, to Sinope, and the Greek sailors, the *ἀσπυρίαι* of Miletus, carried home the works of Oriental and Phrygian artisans. The Greek alphabet was carried to Phrygia and Pteria, either from Sinope or more probably direct east from Cyme, in the latter part of the 8th century. The immense importance of Sinope in early times is abundantly attested, and we need not doubt that very intimate relations existed at this port between the Ionic colonists and the natives. The effects of this commerce on the development of Greece were very great. It affected Ionia in the first place, and the mainland of Greece indirectly; the art of Ionia at this period is almost unknown, but it was probably closely allied to that of Phrygia.⁴ A striking fact in this connexion is the use of a very simple kind of Ionic capital in one early Phrygian monument, suggesting that the "proto-Ionic" column came to Greece over Phrygia. It is obvious that the revolution which took place in the relations between Phrygians and Greeks must be due to some great movement of races which disturbed the old paths of communication. Abel is probably correct in placing the inroads of the barbarous European tribes, Bkhyrnians, Thyni, Mariandyni, &c., into Asia Minor about the beginning of the 9th century B.C. The Phrygian element on the coast was weakened and in many places annihilated; that in the interior was strengthened; and we may suppose that the kingdom of the Sangarus valley now sprang into greatness. The kingdom of Lydia appears to have become important about the end of the 8th century, and to have completely barred the path between Phrygia and Cyme or Smyrna. Ionian maritime enterprise opened a new way over Sinope.⁵

The downfall of the Phrygian monarchy can be dated with comparative accuracy. Between 680 and 670 the Cimmerians in their destructive progress over Asia Minor overran Phrygia; the king Midas in despair put an end to his own life; and from henceforth the history of Phrygia is a story of slavery, degradation and decay, which contrasts strangely with the earlier legends. The catastrophe seems to have deeply impressed the Greek mind, and the memory of it was preserved. The date of the Cimmerian invasion is fixed by the concurrent testimony of the contemporary poets Archilochus and Callinus, of the late chronologists Eusebius, &c., and of the inscriptions of the Assyrian king Esar-haddon. The Cimmerians were finally expelled from Asia Minor by Alyattes before his war with the Medes under Cyaxares (590-585 B.C.). The Cimmerians, therefore, were ravaging Asia Minor, and presumably held possession of Phrygia, the only country where they achieved

⁴ See Furtwängler, *Goldfund von Velletri*, *Winckelmann. Progr.* (1884); Hogarth, &c., *The Archaic Remains* (British Museum, 1898). The closest analogies of old Phrygian art are to be found in the earliest Greek bronze work in Olympia, Italy and the northern lands.

⁵ Hipponax, fr. 36 [49], proves that a trade-route from Phrygia down the Maeander to Miletus was used in the 6th century.

complete success, till some time between 610 and 590 Phrygia then fell under the Lydian power, and by the treaty of 585 the Halys was definitely fixed as the boundary between Lydia and Media (see *LYDIA* and *PERSIA*). The period from 675 to 585 must therefore be considered as one of great disturbance and probably of complete paralysis in Phrygia. After 585 the country was ruled again by its own princes under subjection to Lydian supremacy. To judge from the monuments, it appears to have recovered some of its old prosperity; but the art of this later period has to a great extent lost the strongly marked individuality of its earlier bloom. The later sepulchral monuments belong to a class which is widely spread over Asia Minor from Lycia to Pontus. The graves are made inside a chamber excavated in the rock, and the front of the chamber imitates a house or temple. No attempt is made to conceal the entrance or to render it inaccessible. The architectural details are in some cases unmistakably copied, without intentional modification, from the architecture of Greek temples; others point perhaps to Persian influence, while several—which are perhaps among the early works of this period—show the old freedom and power of employing in new and original ways details partly learned from abroad. This style continued in use under the Persians, under whose rule the Phrygians passed when Cyrus defeated Croesus in 546, and lasted till the Roman period. One monument appears to presuppose a development of Greek plastic art later than the time of Alexander¹ and is almost certainly of the Roman time. It would, however, be wrong to suppose that the influence of truly Hellenic art on Phrygia began with the conquest of Alexander. Under the later Mermaid kings the Lydian empire was penetrated with Greek influence, and Xanthus, the early Lydian historian, wrote his history in Greek. Under the Persian rule perhaps it was more difficult for Greek manners to spread far east; but we need not think that European influence was absolutely unfelt even in Phrygia. The probability is that Alexander found in all the large cities a party favourable to Greek manners and trade. Very little is to be learned from the ancient writers with regard to the state of Phrygia from 585 to 300. The slave-trade flourished: Phrygian slaves were common in the Greek market, and the Phrygian names Midas and Manes were stock-names for slaves. Herodotus (i. 14) records that a king Midas of Phrygia dedicated his own chair at Delphi; the chair stood in the treasury of Cypselus, and cannot have been deposited there before 680 to 660 B.C. It is not improbable that the event belongs to the time of Alyattes or Croesus, when Greek influence was favoured throughout the Lydian empire; and it is easy to understand how the offering of a king Midas should be considered, in the time of Herodotus, as the earliest made by a foreign prince to a Greek god. The Phrygian troops in the army of Xerxes were armed like the Armenians and led by the same commander.

It is to be presumed that the cities of the Sangarius valley gradually lost importance in the Persian period. The final catastrophe was the invasion of the Gauls about 270 to 250; and, though the circumstances of this invasion are almost unknown, yet we may safely reckon among them the complete devastation of northern Phrygia. At last Attalus I. settled the Gauls permanently in eastern Phrygia, and a large part of the country was henceforth known as Galatia. Strabo mentions that the great cities of ancient Phrygia were in his time either deserted or marked by mere villages. The great city over the tomb of Midas has remained uninhabited down to the present day. About 5 m. west of it, near the modern Kumbet, stood Metropolis, a bishopric in the Byzantine time, but never mentioned under the Roman empire.

Alexander the Great placed Phrygia under the command of Antigonus, who retained it when the empire was broken up. When Antigonus was defeated and slain, at the decisive battle of Ipsus, Phrygia came under the sway of Seleucus. As the Pergamian kings grew powerful, and at last confined the Gauls in eastern Phrygia, the western half of the country was

incorporated in the kingdom of Pergamum. Under the Roman empire Phrygia had no political existence under a separate government, but formed part of the vast province of Asia. In autumn 85 B.C. the pacification of the province was completed by Sulla, and throughout the imperial time it was common for the Phrygians to date from this era. The imperial rule was highly favourable to the spread of Hellenistic civilization, which under the Greek kings had affected only a few of the great cities, leaving the mass of the country purely Phrygian. A good deal of local self-government was permitted; the cities struck their own bronze coins, inscribed on them the names of their own magistrates,² and probably administered their own laws in matters purely local. The western part of the country was pervaded by Graeco-Roman civilization very much sooner than the central, and in the country districts the Phrygian language³ continued in common use at least as late as the third century after Christ.

When the Roman empire was reorganized by Diocletian at the end of the 3rd century Phrygia was divided into two provinces, distinguished at first as Prima and Secunda, or Great and Little, for which the names Pacatiana and Salutaris soon came into general use. Pacatiana comprised the western half, which had long been completely pervaded by Graeco-Roman manners, and Salutaris the eastern, in which the native manners and language were still not extinct. Each province was governed by a *praeses* or *ὑψηλὸς* about A.D. 412, but shortly after this date an officer of consular rank was sent to each province (Hierocles, *Synecd.*). About 535 Justinian made some changes in the provincial administration: the governor of Pacatiana was henceforth a *comes*, while Salutaris was still ruled by a *consularis*. When the provinces of the Eastern empire were reorganized and divided into *themata* the two Phrygias were broken up between the Anatolic, Opsician and Thracian themes, and the name Phrygia finally disappeared. Almost the whole of Byzantine Phrygia is now included in the vilayet of Brusa, with the exception of a small part of Parorius and the district about Themisonium (Karayuk Bazar) and Ceretapa (Kayadibi), which belong to the vilayet of Konia, and the district of Laodicea and Hierapolis, which belongs to Aidin. The principal modern cities are Kutayah (Cotyaeum), Eski Shehir (Dorylaeum), Afium Kara Hissar (near Prynnessus), and Ushak (Trajanopolis).

It is impossible to say anything definite about the boundaries of Phrygia before the 5th century. Under the Persians Great Phrygia extended on the east to the Halys and the Salt Desert; Xenophon (*Anab.* i. 2, 19) includes Iconium on the south-east within the province, whereas Strabo makes Tyriaeum the boundary in this direction. The southern frontier is unknown: the language of Lévy (xxxviii. 15) implies that the southern Metropolis (in the Tchul Ova) belonged to Pisidia; but Strabo (p. 629) includes it in Phrygia. Celaenae, beside the later city of Apamea (Dineir), and the entire valley of the Lycus, were Phrygian. The Maeander above its junction with the Lycus formed for a little way the boundary between Phrygia and Lydia. The great plateau now called the Banaz Ova was entirely or in great part Phrygian. Mt Dindymus (Murad Dagh) marked the frontier of Mysia, and the entire valley of the Tembrogius or Tembris (Porsuk Su) was certainly included in Phrygia. The boundaries of the two Byzantine Phrygias were not always the same.

Taking Hierocles as authority, the extent of the two provinces at the beginning of the 6th century will be readily gathered from the accompanying list, in which those towns which coined money under the Roman empire are italicized and the name of the nearest modern village is appended.

1. PACATINA.—(1) *Laodicea* (Eski Hissar); (2) *Hierapolis* (Pamuk Kaleesi); (3) *Mosyna* (Geveze); (4) *Motelopolis*, only in *Notitiae*

¹ This liberty was not granted to the cities of any other province in Anatolia.

² A number of inscriptions in a language presumably Phrygian have been discovered in the centre and east of the country; they belong generally to the end of the 2nd and to the 3rd century.

³ A gorgoneum of Roman period, on a tomb engraved in *Journ. Hell. Stud.* (Pl. xxvi.).

Episcop. (Medele); (5) *Attuda* (Assar); (6) *Trapezopolis* (Bolo S. from Serai Keui); (7) *Colossae* (near Chonas); (8) *Cerata Dioicaesarea* (Kayadidi); (9) *Themisonium* (Karayuk Bazar); (10) *Tacina* (Yarishli); (11) *Sanaus* (Sari Kavak, in Daz Kiri); (12) *Dionysopolis* (Orta Keui); (13) *Anastasiopolis*, originally a village of the Hylaegia (Uteh Kuyular); (14) *Attanasus* (Eski Aidan); (15) *Lunda* (Eski Seid); (16) *Pelae* (Karayaahlar); (17) *Eumenea* (Ishekkli); (18) *Sibia* (Homa); (19) *Peputa* (Duman or Suretli); (20) *Bria* (Bourgas); (21) *Sebaste* (Sivashi); (22) *Eluza* or *Aludra* (Hadjimlar); (23) *Aconia* (Ahat Keui); (24) *Alia* (Kirkla); (25) *Stocharas* (Oturak); (26) *Dioclea* (Dola); (27) *Aristium* (Kapia Euren, in Sitchanli Ova); (28) *Cidyessus* (Geukche Eyuk); (29) *Arja* (Abia); (30) *Cotyaem* (Kutaiah); (31) *Aezani* (Tchavdir Hissar); (32) *Tiberiopolis* (Amcd); (33) *Cador* (Gediz); (34) *Ancyra* (Kilisse Keui); (35) *Synaus* (Simav); (36) *Flatiopolis Temenothys* (Ushak); (37) *Trajanopolis Origenothysae* (Glaour Euren, near Orta Keui); (38) *Bianodus* (Suleimankli) (Kotch Hissar); (39) *Oroua* (Tchor Hissar); (4) *Hieropolis* (Mentesh); (5) *Brianus* (Kara Sandykch); (6) *Bendus* (Aghi Kara); (7) *Augustopolis*, formerly *Anabura* (Surmeneh); (8) *Siddanda* (Baljik Hissar); (9) *Lysias* (Oinan); (10) *Synnada* (Tchifti Casaba); (11) *Prymnessus* (Seulan); (12) *Ipsus*, afterwards *Julia* (near Sakly); (13) *Polybotus* (Bolawadun); (14) *Docimium* (Istcha Kara Hissar); (15) *Metropolis* (Kumbet), including *Conni* (B. Thorgia) and *Ambasus* (Ambanaz); (16) *Merus* (Doghan Arslan); (17) *Nacolea* (Seidi Ghazi); (18) *Dorylaeum* (Eski Sheher); (19) *Midaeum* (Kara Euuk); (20) *Lycraes* (Kalejik); (21) *Aulocra* (in Dombai Ova); (22) *Amadassus* (unknown, perhaps corrupt; it should include *Kinnaborion* near Geneli); (23) *Præpennissus* (Altyntash). In later times the important fortress (and bishopric) of *Acrocrus* was founded on the site of the present *Abous Kara Hissar*.

Besides these, certain cities beyond the bounds of the Byzantine Phrygia belonged under the Roman empire to the province of Asia and are usually considered Phrygian: (1) in Byzantine Pisidia, *Philomeisium* (Ak Shehr), *Hadrianoopolis*; (2) in Byzantine Galatia, *Amorium* (Assar near Hamza Hadji), *Oricius* (Alikel or Alekian), *Tricomia* or *Trocmada* or *Trocnada* (Kaimaz); (3) in Byzantine Lycia, *Cibyra* (Horzum).

Phrygia contains several well-marked geographical districts. (1) *PARORIUS*, the long level, elevated valley stretching north-west to south-east between the Sultan Dagh and the Emir Dagh from Holmi (about Tchai) to Tyriaem (Ilghin); its waters collect within the valley, in three lakes, which probably supply the great fountains in the Axylon and through them the Sangarius. (2) *AXYLON*, the vast treeless plains on the upper Sangarius; there burst forth at various points great perennial springs, the Sakaria fountains (Strabo p. 543), *Ilije Bashi*, *Bunar Bashi*, *Geuk Bunar*, *Uzuk Bashi*, &c., which feed the Sangarius. Great part of the Axylon was assigned to Galatia. (3) The rest of Phrygia is mountainous (except the great plateau, *Banax Ova*), consisting of hill-country intersected by rivers, each of which flows through a fertile valley of varying breadth. The northern half is drained by rivers which run to the Black Sea; of these the eastern ones, *Porsuk Su* (Tembris or Tembrogius), *Seidi Su* (Parthenius), *Bardakchi Tchai* (Xerabates), and *Bayat Tchai* (Alandrus), join the Sangarius, while the western, *Taushanly Tchai* (Rhyndacus) and *Simav Tchai* (Macestus), meet and flow into the Propontis. The *Hermus* drains a small district included in the Byzantine Phrygia, but in earlier times assigned to Lydia and Mysia. Great part of southern and western Phrygia is drained by the Maeander with its tributaries, *Sandykly Tchai* (*Glaucus*), *Banax Tchai*, *Kopli Su* (*Hippurius*), and *Tchuruk Su* (*Lycus*); moreover, some upland plains on the south, especially the *Dombai Ova* (*Aulocra*), communicate by underground channels with the Maeander. Finally, the *Karayuk Ova* in the extreme south-west drains through the *Kazanes*, a tributary of the *Ildus*, to the Lycian Sea. Phrygia *Parorius* and all the river-valleys are exceedingly fertile, and agriculture was the chief occupation of the ancient inhabitants; according to the myth, *Gordius* was called from the plough to the throne. The high-lying plains and parts of the vast *Axylon* furnish good pasture, which formerly nourished countless flocks of sheep. The Romans also obtained fine horses from Phrygia. Grapes, which still grow abundantly in various parts, were much cultivated in ancient times. Other fruits are rare, except in a few small districts. Figs cannot be grown in the country, and the ancient references to Phrygian figs are either erroneous or due to a loose use of the term Phrygia.¹ Trees are exceedingly scarce in the country; and the pine-woods on the western tributaries of the Sangarius and the valonia oaks in parts of the *Banax Ova* and a few other districts form exceptions. The underground wealth is not known to be great. Iron was worked in the district of *Cibyra*, and the marble of *Synnada*, or more correctly of *Docimium*, was largely used by the Romans. Copper and quicksilver were mined in the *Zizima* district, north of *Icomium*. The scenery is generally monotonous; even the mountainous districts rarely show striking features

or boldness of character; where the landscape has beauty it is of a subdued melancholy character. The water-supply is rarely abundant, and agriculture is more or less dependent on an uncertain rainfall. The circumstances of the country are well calculated to impress the inhabitants with a sense of the overwhelming power of nature and of their complete dependence on it. Their mythology so far as we know it, has a melancholy and mystic tone, and their religion partakes of the same character. The two chief deities were *Cybele*, the Mother, the reproductive and nourishing power of Earth, and *Sabazius*, the Son, the life of nature, dying and reviving every year (see GREAT MOTHER OF THE GODS). The annual vicissitudes of the life of *Sabazius*, the Greek *Dionysus*, were accompanied by the mimic rites of his worshippers, who mourned with his sufferings and rejoiced with his joy. They enacted the story of his birth and life and death; the Earth, the Mother, is fertilised only by an act of violence by her own child; the representative of the god was probably slain each year by a cruel death, just as the god himself died. The rites were characterised by a frenzy of devotion, unrestrained enthusiasm, wild orgiastic dances and wanderings in the forests, and were accompanied by the music of the flute, cymbal, and tambourine.⁴ At an early time this worship was affected by Oriental influence, coming over Syria from Babylonia. *Sabazius* was identified with *Adonis* or *Attus* (*Atys*), *Cybele* with the Syrian goddess; and many of the coarsest rites of the Phrygian worship, the mutilation of the priests, the prostitution at the shrine,⁵ came from the countries of the south-east. But one point of Semitic religion never penetrated west of the Haly; the pig was always unclean and abhorred among the Semites, whereas it was the animal regularly used in purification by the Phrygians, Lydians, Lycians and Greeks. The Phrygian religion exercised a very strong influence on Greece. In the archaic period the *Dionysiac* rites and orgies spread from Thrace into Greece, in spite of opposition which has left many traces in tradition, and the worship of *Demeter* at *Eleusia* was modified by Cretan influence ultimately traceable to *Asia Minor*. *Pindar* erected a shrine of the Mother of the gods beside his house, and the Athenians were directed by the *Delphic oracle* to atone for the execution of a priest of *Cybele* during the *Peloponnesian War* by building the *Metreon*. In these and other cases the Phrygian character was more or less Hellenised; but waves after wave of religious influences from *Asia Minor* introduced into Greece the unmodified "barbarian" ritual of Phrygia. The rites spread first among the common people and those engaged in foreign trade. The comic poets satirized them, and *Plato* and *Demosthenes* inveighed against them; but they continued to spread, with all their fervid enthusiasm, their superstition and their obscene practices, wide among the people, whose religious cravings were not satisfied with the purely external religions of Hellenism. The orgies or mysteries were open to all, freemen or slaves, who had duly performed the preliminary purifications, and secured to the participants salvation and remission of sins. Under *MYSTERIES* (q.v.) a distinction of character has been pointed out between the true Hellenic mysteries, such as the *Eleusian* and the Phrygian; but there certainly existed much similarity between the two rituals. In the first centuries after Christ only the Phrygian and the Egyptian rites retained much real hold on the Graeco-Roman world. Phrygia itself, however, was very early converted to Christianity. Christian inscriptions in the country begin in the 2nd and are abundant in the 3rd century. There is every appearance that the great mass of the people were Christians before 300, and *Eusebius* (*H. E.* v. 16) is probably correct in his statement that in the time of *Diocletian* there was a Phrygian city in which every living soul was Christian. The great Phrygian saint of the 2nd century was named *Avircicus Marcellus* (*Abercius*); the mass of legends and miracles in the late biography of him long brought his very existence into dispute, but a fragment of his gravestone, discovered in 1883, and now preserved in the *Lateran Museum* in Rome, has proved that he was a real person, and makes it probable that the wide-reaching conversion of the people attributed to him did actually take place. The strange enthusiastic character of the old Phrygian religion was not wholly lost when the country became Christian, but is clearly traced in the various heresies that arose in central Anatolia. Especially the wild ecstatic character and the prophecies of the *Montanists* recall the old type of religion. *Montanus* (see *MONTANISM*) was born on the borders of Phrygia and Mysia (probably south-east from *Philadelphia*), and was vehemently opposed by *Abercius*.

Of the old Phrygian language very little is known; a few words are preserved in *Hezychius* and other writers. *Plato* mentions that the Phrygian words for "dog," "fire," &c., were the same as the Greek; and to these we may add from inscriptions the words for "mother," "king," &c. A few inscriptions of the ancient period are known, and a larger number of the Roman period have been published in the *Oesterreichische Jahreshefte* (1905).

Owing to the scantiness of published material about Phrygia frequent reference has been made in this article to unpublished

¹ Nos. 1-5 were called the Phrygian "Pentapolis."

² This district was according to the Greek view part of Mysia.

³ In *Strabo*, p. 577, *Δαυδύριον* must be wrong; *Αυροδύριον* is true to fact, and is probably the right reading. Olives cannot now grow on these uplands, which are over 3000 ft. above sea-level.

⁴ The influence which was exerted on Greek music and lyric poetry by the Phrygian music was great; see *MARSYAS*; *OLYMPUS*.

⁵ There is no direct evidence that this was practised in the worship of *Cybele*, but analogy and indirect arguments make it pretty certain.

monuments. Besides the works already quoted of Abel and Perrot, see Ritter's "Kleinasiens," in his *Erkunde von Asien*; Leake, *Asia Minor* (1824); Kiepert appendix to *Fünf Inschr. u. fünf Städt Kleinasiens* (1840); Haase, in Ersch and Gruber's *Encyclop. art.* "Phrygen"; Hamilton, *Travels in Asia Minor* (1842); Hirschfeld "Reisebericht," in the *Berl. Monatsber.* (1879); Tenax, *Asia menore* (1862); Steuart, *Ancient Monuments of Lydia and Phrygia*, besides the special chapters in the geographical treatises of Cramer, Vivien St. Martin, Forbiger, &c.; numerous articles by recent travellers; J. G. C. Anderson in *Journal of Hellenic Studies* (1898, &c.); D. G. Hogarth, *ibid.*; Körte in *Mithel. Inst. Athens*, &c.; and his book *Gordius* (1904); Humann and Judeich, *Hierapolis* (1898); Radet in his work *Es Phrygie*; Ramsay in addition to articles in *Mithel. Instil. Athen.* (1882 sqq.), *Bulletin de corresp. hellén.* (1883 sqq.), *Journal of Hellenic Studies* (1882, sqq.), *American Journal of Archaeology, Rome des études grecques*, *Cities and Bishoprics of Phrygia*, vols. i. ii. (1895 sqq.); *Studies in the History and Art of the Eastern Provinces* (1906); *Pauline and other Studies* (1906); *Historical Commentary on Galatians*, &c. (1899); *Cities of St Paul* (1907); see also T. Eisele, "Die Phrygischen Kulte" in *Neue Jahrb. f. das klass. Altertum* (Sept. 1909). (W. M. RA.)

PHRYNE, Greek courtesan, lived in the 4th century B.C. Her real name was Mnesarete, but owing to her complexion she was called Phryne (toad), a name given to other courtesans. She was born at Thespie in Boeotia, but seems to have lived at Athens. She acquired so much wealth by her extraordinary beauty that she offered to rebuild the walls of Thebes, which had been destroyed by Alexander the Great (336), on condition that the words "Destroyed by Alexander, restored by Phryne the courtesan," were inscribed upon them. On the occasion of a festival of Poseidon at Eleusis she laid aside her garments, let down her hair, and stepped into the sea in the sight of the people, thus suggesting to the painter Apelles his great picture of Aphrodite Anadyomene, for which Phryne sat as model. She was also (according to some) the model for the statue of the Caidian Aphrodite by Praxiteles. When accused of profaning the Eleusinian mysteries, she was defended by the orator Hyperides, one of her lovers. When it seemed as if the verdict would be unfavourable, he rent her robe and displayed her lovely bosom, which so moved her judges that they acquitted her. According to others, she herself thus displayed her charms. She is said to have made an attempt on the virtue of the philosopher Xenocrates. A statue of Phryne, the work of Praxiteles, was placed in a temple at Thespie by the side of a statue of Aphrodite by the same artist.

See Athenaeus, pp. 558, 567, 583, 585, 590, 591; *Adian. Var. Hist.* ix. 32; Pliny, *Nat. Hist.* xxiv. 71.

PHRYNICHUS—1. Son of Polyphradmon and pupil of Thespie, one of the earliest of the Greek tragedians. Some of the ancients, indeed, regarded him as the real founder of tragedy. He gained his first poetical victory in 511 B.C. His famous play, the *Capture of Miletus*, was probably composed shortly after the conquest of that city by the Persians. The audience was moved to tears, the poet was fined for reminding the Athenians of their misfortunes, and it was decreed that no play on the subject should be produced again. In 476 Phrynichus was successful with the *Phoenissae*, so called from the Phoenician women who formed the chorus, which celebrated the defeat of Xerxes at Salamis (480). Themistocles acted as choragus, and one of the objects of the play was to remind the Athenians of his great deeds. The *Persians* of Aeschylus (472) was an imitation of the *Phoenissae*. Phrynichus is said to have died in Sicily. Some of the titles of his plays, *Danaides*, *Actaeon*, *Alcatis*, *Tantalus*, show that he treated mythological as well as contemporary subjects. He introduced a separate actor as distinct from the leader of the chorus, and thus laid the foundation of dialogue. But in his plays, as in the early tragedies generally, the dramatic element was subordinate to the lyric element as represented by the chorus and the dance. According to Suidas, Phrynichus first introduced female characters on the stage (played by men in masks), and made special use of the trochaic tetrameter.

Fragments in A. Nauck, *Tragicorum graecorum fragmenta* (1887).

2 A poet of the Old Attic comedy and a contemporary of Aristophanes. His first comedy was exhibited in 429 B.C. He

composed ten plays, of which the *Solitary* (*Μορβροσος*) was exhibited in 414 along with the *Birds* of Aristophanes and gained the third prize. The *Muses* carried off the second prize in 405, Aristophanes being first with the *Frogs*, in which he accuses Phrynichus of employing vulgar tricks to raise a laugh, of plagiarism and bad versification.

Fragments in T. Koock, *Comicorum atticorum fragmenta* (1880).

3. **PHRYNICHUS ARABUS**, a grammarian of Bithynia, lived in the 2nd century A.D. According to Suidas he was the author of (1) an *Atticist*, or *On Attic Words*, in two books; (2) *Τὸ ἀμείνων συναγωγή*, a collection of subjects for discussion; (3) *Σοφιστικὴν ὑπερσυστήσιν*, or *Sophistical Equipment*, in forty-seven (or seventy-four) books. As models of Attic style Phrynichus assigned the highest place to Plato, Demosthenes and Aeschines the Socratic. The work was learned, but prolix and garrulous. A fragment contained in a Paris MS. was published by B. de Montfaucon, and by I. Bekker in his *Anecdota graeca* (1814). Another work of Phrynichus, not mentioned by Photius, but perhaps identical with the *Atticist* mentioned by Suidas, the *Selection* (*Ἐκλογή*) of *Attic Words and Phrases*, is extant. It is dedicated to Cornelianus, a man of literary tastes, and one of the imperial secretaries, who had invited the author to undertake the work. It is a collection of current words and forms which deviated from the Old Attic standard, the true Attic equivalents being given side by side. The work is thus a lexicon anti-barbarum, and is interesting as illustrating the changes through which the Greek language had passed between the 4th century B.C. and the 2nd century A.D.

Editions of the *Ἐκλογή*, with valuable notes, have been published by C. A. Lobeck (1820) and W. G. Rutherford (1881); Lobeck devotes his attention chiefly to the later, Rutherford to the earlier usages noticed by Phrynichus. See also J. Brenous, *De Phrynico Atticista* (1895).

4. An Athenian general in the Peloponnesian War. He took a leading part in establishing the oligarchy of the Four Hundred at Athens in 411 B.C., and was assassinated in the same year (Thucydides viii.).

PHTHALAZINES (benzo-orthodiazines or benzopyridazines), in organic chemistry a group of heterocyclic compounds containing the ring complex shown in formula I. They are isomeric with the cinnolines (q.v.). The parent substance of the group, phthalazine, C₈H₆N₂, is best obtained from the condensation of *o*-tetrabromorthoxylylene with hydrazine (D. Gabriel, *Ber.*, 1893, 26, p. 2210, or by the reduction of chlorphthalazine with phosphorus and hydriodic acid (*Ber.*, 1897, p. 3024). It possesses basic properties and forms addition products with alkyl iodides. On oxidation with alkaline potassium permanganate it yields pyridazine dicarboxylic acid. Zinc and hydrochloric acid decompose it with formation of orthoxylylene diamine.

The keto-hydro derivative *phthalazone*, C₈H₆ON₂, (formula II.), is obtained by condensing hydrazine with orthophthalaldehyde-acid. On treatment with phosphorus oxychloride it yields a chlor-phthalazine which with zinc and hydrochloric acid gives isindole, C₈H₇N, and with tin and hydrochloric acid phthalimidine, C₈H₇ON, the second nitrogen atom being eliminated as ammonia.



I. Phthalazine.



II. Phthalazone.

PHTHALIC ACIDS, or **BENZENE DICARBOXYLIC ACIDS**, C₈H₆(CO₂H)₂. There are three isomers: (1) ortho, or phthalic acid; (2) meta, or isophthalic acid; (3) para, or terephthalic acid.

Phthalic acid was obtained by Laurent in 1836 by oxidizing naphthalene tetrachloride, and, believing it to be a naphthalene derivative, he named it naphthalenic acid; Margnac determined its formula and showed Laurent's supposition to be incorrect, upon which Laurent gave it its present name. It is manufactured by oxidizing naphthalene tetrachloride (prepared from naphthalene, potassium, chlorate and hydrochloric acid) with nitric acid, or, better, by oxidizing the hydrocarbon with fuming sulphuric acid, using mercury or mercuric sulphate as a catalyst (German pat. 91, 202). It also results on the oxidation of ortho-

diderivatives of benzene. It forms white crystals, melting at 213° with decomposition into water and phthalic anhydride; the latter forms long white needles, melting at 128° and boiling at 284° . Heated with an excess of lime it gives benzene; calcium benzoate results when calcium phthalate is heated with one molecule of lime to 330° – 350° . The acid (and anhydride) are largely used in the colour industry (see FLUORESCIN; PERNOL-PTHALALEIN).

Phthalyl chloride, $C_6H_4(COCl)_2$ or $C_6H_4(CCl_2)(CO)O$, formed by heating the anhydride with phosphorus chloride, is an oil which solidifies at 0° and boils at 275° . In some reactions it behaves as having the first formula, in others as having the second. Phthalyl chloride with phosphorus pentachloride gives two phthalylene tetrachlorides, one melting at 88° and the other at 47° . They cannot be changed into one another, and have been given the formulas $C_6H_4(CCl_2)(COCl)$ and $C_6H_4(CCl_2)_2$. Phthalimide, $C_6H_4(CO)_2NH$, is formed by heating phthalic anhydride or chloride in ammonia gas or by molecular rearrangement of ortho-cyanbenzoic acid. It forms N-metallic and alkyl salts. Bromine and potash give anthranilic acid, $C_6H_4(NH_2)(CO_2H)$. (See INDIGO.)

Isophthalic acid is obtained by oxidizing meta-xylene with chromic acid, or by fusing potassium meta-sulphobenzoate, or meta-bromobenzoate with potassium formate (terephthalic acid is also formed in the last case). It melts above 300° , and dissolves in 7800 parts of cold water and in 460 of boiling. The barium salt ($-6H_2O$) is very soluble (a distinction between phthalic and terephthalic acids). **Uvic acid**, 5-methyl isophthalic acid, is obtained by oxidizing mesitylene or by condensing pyroacetic acid with baryta water.

Terephthalic acid, formed by oxidizing para-diderivatives of benzene, or best by oxidizing caraway oil, a mixture of cymene and cuminal, with chromic acid, as almost insoluble in water, alcohol and ether; it sublimes without melting when heated.

For the reduced phthalic acids see POLYMETHYLENES.

PHTHISIS (Gr. *phthois* "wasting"), a term formerly applied (like "Consumption") to the disease of the lung now known as Tuberculosis (q.v.).

PHYLACTERY (*φυλακτήριον*), a Greek word meaning "guard" (sc. against misfortune), i.e. an amulet. It is applied in the New Testament to the *tefillin* or "prayer-thongs" worn by orthodox Jews daily at morning-prayer (whether at home or in the synagogue). The title employed in Hebrew, *tefillin*, seems really to be derived from an Aramaic term meaning "attachments," "ornaments"; it corresponds to the Biblical Hebrew word rendered "frontlets" (*tsafith*). The *tefillin* or phylacteries are worn, one on the left arm (the "hand-tefilla"), and the other on the head (the "head-tefilla"). In each case the leather thongs support a small satchel which is fastened to the arm and the forehead respectively, and contains certain passages of the Law written (in Hebrew) on parchment, viz. Exod. xiii. 1-10 and 11-16; Deut. vi. 4-9 and xi. 13-21. The custom of wearing phylacteries seems to have been derived in the first instance from the Pharisees. By the Sadducees and the generality of the people in the time of Christ it seems not to have been practised. Later it became—not without protest—one of the badges of orthodox Judaism. It is significant that the custom is entirely unknown to the Samaritan community.

The phylacteries, together with the "fringe" (*tsitzith*) and door-post symbol (*mezuzah*)—which latter consists of a piece of parchment, containing the Hebrew text of Deut. vi. 4-9 and xi. 13-21 enclosed in a glass or metal tube, and fixed upon the right hand post of the door of each dwelling-room in a house—form the three sets of visible signs by which the Israelite is constantly reminded of his duty to God (cf. Num. xv. 39-40; Deut. vi. 9; xi. 20). The "fringe" (or "tassels") was originally attached to the common outer garment—a large square wrap—the loose end of which hung over the left shoulder. This garment with tassels is mentioned in the New Testament (cf. Matt. ix. 20; xiv. 36; xxiii. 5 and parallels). Among modern Jews it has survived in two forms: (1) the fringed praying shawl called *talith* worn by every male orthodox Jew at the synagogue morning service; and (2) an under-garment, shaped like a chest-protector,

one part covering the chest, the other the back, which is worn continuously by male orthodox Jews. It is called *Arba Kanfoth* (i.e. "Four Corners," Deut. xxii. 12) or "little Talith," and is, of course, "fringed." Both phylactery and mezuzah were supposed to keep off hurtful demons (Targ. on Cant. viii. 3).

See Surenhusius, *Mischna*, l. 9 seq.; and Bodenschatz, *Kirk. Verf. d. heiligen Juden*, iv. 9 seq. (W. R. S., G. H. Bo.)

PHYLARCHUS, a Greek historian, who flourished during the time of Aratus, the strategus of the Achaean League, in the 3rd century B.C. His birthplace is variously given as Athens, Naucratis, or Sicyon. He was probably a native of Naucratis, and subsequently migrated to Athens. He was the author of a history in 28 books, covering the period from the expedition of Pyrrhus king of Epirus to Peloponnesus (272) to the death of the Spartan king Cleomenes (220) after his defeat by Antigonus Doson. Polybius (ii. 56-63) charges him with undue partiality for Cleomenes and unfairness towards Aratus; Plutarch (*Aratus*, 38), who is of the same opinion, did not hesitate to use him freely in his own biographies of Agis and Cleomenes.

Fragments and life in C. W. Müller, *Fragmenta historicorum graecorum*, vol. I. (1841), monographs by J. F. Lucht (1836) and C. A. F. Brückner (1839), C. Wachsmuth, *Ermittlung zu das Studium der alten Geschichte* (1895).

PHYLE, a mountain fortress, on a pass leading from Athens to Boeotia and Thebes, and commanding a fine view of the Attic plain. It is situated on the south-west end of Mt. Parnes. It is chiefly famous for its occupation by Thrasybulus at the head of the Athenian exiles during the rule of the Thirty Tyrants in 404 B.C. After defending himself from attack, with the help of a snowstorm, he succeeded by a venturesome night march in seizing Munychia. Close to Phyle is the cliff called Harma, over which the Pythian lightning were watched for from Athens.

PHYLLITE (Gr. *phyllos*, a leaf, probably because they yield leaf-like plates, owing to their fissility), in petrology, a group of rocks which are in practically all cases metamorphosed argillaceous sediments, consisting essentially of quartz, chlorite and muscovite, and possessing a well-marked parallel arrangement or schistosity. They form an intermediate term in the series of altered clays or shaly deposits between clay slates and mica-schists. The clay-slates have a very similar mineral constitution to the phyllites, but are finer grained and are distinguished also by a very much better cleavage. In the phyllites also white mica (muscovite or sericite) is more abundant as a rule than in slate, and its crystalline plates are larger; the abundance of mica gives these rocks a glossy sheen on the smooth planes of fissility. Many of the best Welsh slates are rich in small scales of white mica, which polarize brightly between crossed nicols. The Cornish slates are still more micaceous and rather coarser grained, so that they might be called mica-slates or even phyllites.

A microscopical section of a typical phyllite shows green chlorite and colourless mica both in irregular plates disposed in parallel order, with a greater or smaller amount of quartz which forms small lenticular grains elongated parallel to the foliation. Grains of iron oxide (magnetite and hematite) and black graphitic dust are very commonly present. Feldspar is absent or scarce, but some phyllites are characterized by the development of small rounded grains of albite, often in considerable numbers. The minute needles of rutile, so often seen in clay-slates, are not often met with in phyllites, but this mineral forms small prisms which may be intergrown with black magnetite; at other times it occurs as networks of gangue. Other phyllites contain carbonates (usually calcite but sometimes dolomite) in flat or spindle-shaped crystals, which often give evidence of crushing. Very tiny blue needles of tourmaline are by no means rare in phyllites, though readily overlooked. Garnet occurs sometimes, a good example of garnetiferous phyllite being furnished by the whetstones of the Ardennean, in which there are many small isotropic crystals of magnesian garnet. Hornblende, often in branching feathery crystals, is a less frequent accessory. In some phyllites a mineral of the chloritoid group makes its appearance; this may be oretillite, isomondine or other varieties of chloritoid, and occurs in large sub-hexagonal plates showing complex twinning, and lying across the foliation planes of the rock, so that they seem to have developed after the movements and pressures which gave rise to the foliation had ceased.

The structural variations presented by the phyllites are comparatively few. The most finely crystalline specimens have generally the most perfect parallel arrangement of their constituents. The foliation is generally flat or linear, but in some rocks is undulose or crumpled. From the imperfection of their cleavage phyllites are rarely suitable for roofing materials; their softness renders them valueless as road stones, but they are not uncommonly employed as inferior building materials. They are exceedingly common in all parts of the world where metamorphic rocks occur; as in the Scottish Highlands, Cornwall, Anglesey, north-west Ireland, the Ardennes, the Harz Mountains, Saxony, the Alps, Norway, the Appalachians, the Great Lakes district in America, &c. (J. S. F.)

PHYLLOXERA (Gr. φύλλος, leaf, and ξηρός, dry), a genus of insects belonging to the family of Aphidae, or Plant-lice, in the Homopterous section of the order Hemiptera. It is chiefly known from the causal relation of one of its species to the most serious of vine-diseases. The name was first given in 1834 to a plant-louse which was observed to "dry up the leaves" of oaks in Provence. About twenty-seven species are now known, all characterized by length not exceeding .06 of an inch, flat wings, three articulations in the antennae, one or two articulations in the tarses, with digitules, but without cornicles on the abdomen.

The following full description of the only species which attacks the vine, the *Phylloxera vastatrix*, or grape-louse, is reprinted from the article *VINE* in the 9th edition of this encyclopaedia.

"The symptoms of the disease, by means of which an infected spot may be readily recognized, are as follows. The vines are stunted and bear few leaves, and these small ones. When the disease reaches an advanced stage the leaves are discoloured, yellow or reddish, with their edges turned back, and withered. The grapes are arrested in their growth and their skin is wrinkled. If the roots are examined numerous fusiform swellings are found upon the smaller rootlets. These are at first yellowish in colour and fleshy; but as they grow older they become rotten and assume a brown or black colour. If the roots on which these swellings occur be examined with a lens, a number of minute insects of a yellowish-brown colour are observed; these are the root-forms (radicola) of *Phylloxera* (fig. 1); they are about .8 mm. long, of an oval outline and with a swollen body. No distinction between head, thorax and abdomen can be observed. The head bears small red eyes and a pair of three-jointed antennae, the first two joints being short and thick, the third more elongated, with the end cut off obliquely and slightly hollowed out. Underneath, between the legs, lies the rostrum, which reaches back to the abdomen. The insect is fixed by this rostrum, which is inserted into the root of the vine for the purpose of sucking the sap. The abdomen consists of seven segments, and these as well as the anterior segments bear four rows of small tubercles on their dorsal surface. These root-dwelling insects are females, which lay parthenogenetic eggs. The insect is fixed by its proboscis, but moves its abdomen about and lays thirty to forty yellow eggs in small clusters. After the lapse of six, eight or twelve days, according to the temperature, the larvae hatch out of the eggs. These are light yellow in colour and in appearance resemble their mother, but with relatively larger appendages. They move actively about for a few days and then, having selected a convenient place on the young roots, insert their proboscis and become stationary. They moult five times, becoming with each change of skin darker in colour; in about three weeks they become adult and capable of laying parthenogenetic eggs. In this way the insect increases with appalling rapidity: it has been calculated that a single mother which dies after laying her eggs in March would have over 25,000,000 descendants by October. If, however, the insect were content with this method of reproduction the disease could be isolated by surrounding the infected patches with a deep ditch full of some such substance as coal-tar, which would prevent the insects spreading on to the roots of healthy vines. The fertility of the parthenogenetically produced insects would also diminish after a certain number of generations had been produced.

As the summer wears on a second form of insect appears amongst the root-dwellers, though hatched from the same eggs as the form described above. These are the nymphs, destined to acquire wings; their body is more slender in outline, and at first they bear well-marked tubercles. After several moults the rudiments of two pairs of wings appear, and then the insect creeps up to the surface of the earth, and on to the vine. Here it undergoes its fifth and last moult, and appears as a winged female, capable of reproducing parthenogenetically. The winged form has a slender body with distinct head (fig. 2). The eyes are well developed,

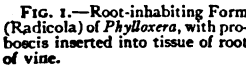

FIG. 1.—Root-inhabiting Form (Radicola) of *Phylloxera*, with proboscis inserted into tissue of root of vine.

with numerous facets; the antennae have three joints, the terminal one shaped like that of the root-dwellers. The wings are transparent, with few nervures, and are well adapted for flight. The anterior pair reach far beyond the end of the abdomen; the posterior are narrower and not so long. These winged forms are about 1 mm. long. They fly about from July till October, living upon the sap of the vine, which is sucked up by the rostrum from the leaves or buds. They lay their parthenogenetically produced eggs in the angles of the veins of the leaves, in the buds, or, if the season is already far advanced, in the bark. In very damp or cold weather the insect remains in the ground near the surface, and deposits its eggs there. The eggs are very few in number and of two sizes, small and large (fig. 3, b and c). From the larger a female (fig. 4) is hatched in eight or ten days, and simultaneously, for the first time in the life-history of the *Phylloxera*, a male (fig. 3) appears from the smaller egg. Neither male nor female has wings; the rostrum is replaced by a functionless tubercle; and there is no alimentary canal. The female is larger than the male and differs from it and the other forms in the last joint of the antennae. The life of these sexual forms lasts but a few days, and is entirely taken up with reproduction. The female is fertilized by the male and three or four days later lays a single egg—the winter egg—and then dies. This egg is laid in the crevices of the bark of the vine, and as it is protectively coloured it is almost impossible to find it. Here the winter eggs remain undeveloped during the cold months; but in the following spring, as a rule in the month of April, they give

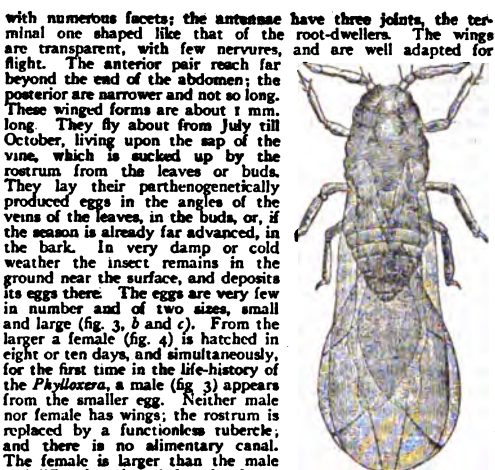

FIG. 2.—*Phylloxera*. Winged Female which lives on leaves and buds of vine, and lays parthenogenetically eggs of two kinds, one developing into a wingless female, the other into a male.

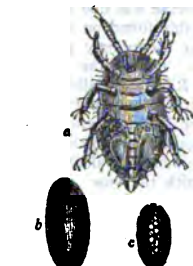
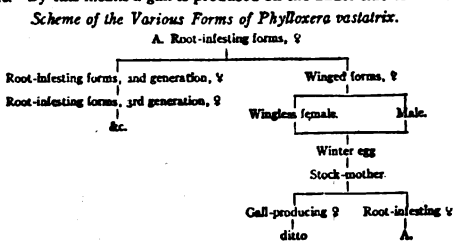

FIG. 3.—a, Male produced from small egg; b, large egg; c, small egg.



FIG. 4.—Wingless Female produced from large egg (fig. 3, b), laid by winged female (fig. 2).

birth to a female insect without wings, which resembles the root-dwelling forms, but has pointed antennae. These forms are termed the stock-mothers; they creep into the buds of the vine, and, as these develop into the young leaves, insert their proboscis into the upper side. By this means a gall is produced on the under side of the leaf.



The gall is cup-shaped, and its outer surface is crumpled and covered with small warts and hairs. The opening upon the upper surface

of the leaf is protected by similar structures. Within this gall the stock-mother lives and surrounds herself with numerous parthenogenetically produced eggs—sometimes as many as two hundred in a single gall; these eggs give birth after six or eight days to a numerous progeny (gallincola), some of which form new galls and multiply in the leaves, whilst others descend to the roots and become the root-dwelling forms already described. The galls and the gall-producing form are much commoner in America than in the Old World.

The particular species of phylloxera which attacks the vine is a native of the United States, probably originating among the wild vines of the Colorado district. It was first observed in 1856 by Asa Fitch (1809–1878), who did not suspect its mischief, and called it *Pemphigus vitifoliae*. In 1863 it was independently discovered by Westwood in an English vineyard at Hammersmith; he was ignorant of Fitch's observation, and called it *Perilymbia vitisana*. From 1858 to 1863 there were many importations of American vines for grafting purposes to Bordeaux, Roquemaure and other parts of France, England, Ireland, Germany, Portugal, &c. It is practically certain that the deadly phylloxera was imported on these plants. A year or two later certain vine-growers in the South of France began to complain of the new vine-disease. M. Delorme, of Arles, in 1865, appears to have been the first who recognized its novelty and had a presentiment of disaster. The disease steadily spread outwards in concentric circles from its first place of lodgment near Roquemaure. Within two or three years whole departments were infested. In 1866 a second centre of infection made its appearance near Bordeaux. The vine-growers were at their wits' end to account for this new plague, which threatened to be even more costly than the oidium. The completeness of the ruin which threatened them may be illustrated by the statistics for a single commune, that of Graveson, whose average annual production of wine in the years 1865–1867 was about 220,000 gallons. In 1868 this fell to 121,000 gallons, in 1869 to 48,400 gallons, in 1870 to 8800 gallons, and by 1873 to 1100 gallons.

In 1868 Planchon proved that the disease was due to a new species of phylloxera, which was invariably found on the roots of the affected vines, and to which he accordingly gave the prophetic name of *Phylloxera vastatrix*. During the next ten years a series of students, of whom only Riley and Balbiani need be mentioned here, worked out the natural history of *Phylloxera vastatrix*, and proved its identity with the American grape-louse. Its devastations rapidly assumed gigantic proportions. In France, where the disease was by far the most prevalent—owing in great part to the obstinacy with which the vine-growers at first refused to take any reasonable precautions against its spread—M. Lalande, president of the chamber of commerce at Bordeaux, in 1888 calculated the direct loss to the country by the phylloxera at 10 milliards (£400,000,000), or double the indemnity which had been paid to Germany in 1871!

The phylloxera has made its appearance in almost every vine-growing country in the world. Thus it appeared in Austria-Hungary in 1868; in Italy, in spite of the frantic efforts made—as in other countries—to keep it out by strict legislation against the import of vines, in 1879; in Russia in 1880; in Germany, on the Rhine and Moselle, and in Switzerland in 1879; in Madeira, Spain and Portugal, about 1876. The pest even crossed the oceans, and appeared in Australia, at Geelong, about 1880; it has since twice broken out in Victoria, and has ravaged the vineyards of South Australia and New South Wales. At the Cape, in spite of a long endeavour to prohibit the import of the phylloxera, it appeared about 1884. In 1885 it crossed the Mediterranean to Algeria. There was only one country where its ravages were long unimportant; that was its home in the United States, where the native vines had become, by the operation of natural selection, immune to its attacks. Yet no imported vine has ever lived there more than five years, and in 1890 the phylloxera crossed the Rocky Mountains, and seriously damaged the vineyards of California, where it had previously been unknown.

Three different methods of fighting the pest have been successfully adopted. One is to kill the phylloxera itself; another, to destroy it along with the infested vines, and plant fresh and healthy plants; the third, to adapt the secular therapeutics of nature, and to introduce American vines which a long acquaintance with the phylloxera has made immune to its ravages. Insecticides, of which the bisulphide of carbon (CS₂) and the

sulpho-carbonate of potassium (KSCS₂) remain in use, were injected into the earth to kill the phylloxera on the roots of the vine. These methods were chiefly advocated in vineyards of the first class, where it was worth while to spend a good deal of money and labour to preserve the old and famous vines: the Château Leoville Poyferré and Clos Vougeot are instances. Some good judges attribute the peculiar and not unpleasant flavour of certain clarets of 1888 to means thus adopted to kill the phylloxera. The second plan was largely adopted in Switzerland and on the Rhine, where measures resembling those taken with cattle suspected of anthrax were applied to all diseased vineyards. The third plan, which consists in replanting the affected vineyard with American vines—such as the *Vitis labrusca*, *V. riparia*, *V. rupestris* or *V. monticola*—has proved the most generally successful.

A very good bibliography will be found in *Les Insectes de la vigne*, by Professor Majet of Montpellier (1890), which is the best book on the subject. Reference may also be made to the classic memoirs of Planchon, culminating in *Les Mœurs de la phylloxera de la vigne* (1877); Dreyfus, *Über Phylloxeren* (1880); Lichtenstein, *Histoire des phylloxera*; the *Rapports annuels à la commission supérieure des phylloxera*; and the excellent *Report on Phylloxera* drawn up by the Hon. J. W. Taverner (Victoria, 1890, No. 68). (W. E. G. F.)

PHYSHARMONICA, a keyboard instrument fitted with free-reeds, a kind of harmonium much used in Germany. The physharmonica resembles a small harmonium, but is differentiated from it by having no stops; being without percussion action, it does not speak readily or clearly. As in the harmonium, the bellows are worked by the feet by an alternate movement, which also affords a means of varying the dynamic force of the tone according as more or less energetic pedalling increases or decreases the pressure of the wind supply. The physharmonica was invented in 1818 by Anton Häckel, of Vienna; in the original instrument the bellows were placed right and left immediately under the shallow wind-chest, and were worked by means of pedals connected by stout wire. A specimen, having a compass of four octaves and a very sweet tone, is preserved in the collection of Paul de Wit, formerly in Leipzig, now transferred to Cologne. (K. S.)

PHYSICAL PHENOMENA, in the terminology of spiritualism and psychical research, molar or molecular phenomena in the physical world not traceable to ordinary causes and referred to the action of spirits or of mediums in abnormal psychical states. Among the phenomena or alleged phenomena are: materialization, levitation or elongation of the medium; passage of matter through matter, alteration of weight in a balance, tying of knots in an endless cord, apports (objects brought from a distance) and movements of objects (telekinesis); the production of writing, imprints of plaster or other objects; raps, voices and other sounds, including music; spirit photographs; lights and perfumes. To these may be added immunity against the effects of fire and the untying of ropes.

Analogous phenomena are found in many parts of the world (see POLTERGEIST; FIREWALKING); spectral lights are associated with the tombs of Mahomedan saints, with Buddhist shrines, with religious revivals, with Red Indian and other magicians, &c., and as sporadic phenomena in the Highlands and Norway. Levitation is asserted of Australian wizards, the rope-trick of Eskimo angekoks; glyphs and direct writing are found in Mexican and Tibetan cults.

See F. Podmore, *Modern Spiritualism*; F. W. H. Myers, *Human Personality*, ii. 506; *Journal S. P. R.*, vi. 309 sq. (N. W. T.)

PHYSIOCRATIC SCHOOL, the name given to a group of French economists and philosophers. The heads of the school were François Quesnay (q.v.) and Jean Claude Marie Vincent, sieur de Gournay (1712–1759). The principles of the school had been put forward in 1755 by R. Cantillon, a French merchant of Irish extraction (*Essai sur la nature du commerce en général*), whose biography W. S. Jevons has elucidated, and whom he regards as the true founder of political economy; but it was in the hands of Quesnay and Gournay that they acquired a systematic form, and became the creed of a united group of thinkers

and practical men, bent on carrying them into action. The members of the group called themselves *les économistes*, but it is more convenient, because unambiguous, to designate them by the name *physiocrates* (Gr. *physis*, nature, and *kratos*, to rule), invented by P. S. Dupont de Nemours (1730-1817), who was one of their number. In this name, intended to express the fundamental idea of the school, much more is implied than the subjection of the phenomena of the social, and in particular the economic, world to fixed relations of coexistence and succession. This is the positive doctrine which lies at the bottom of all true science. But the law of nature referred to in the title of the sect was something quite different. The theological dogma which represented all the movements of the universe as directed by divine wisdom and benevolence to the production of the greatest possible sum of happiness had been transformed in the hands of the metaphysicians into the conception of a *ius naturae*, a harmonious and beneficial code established by the favourite entity of these thinkers, nature, antecedent to human institutions, and furnishing the model to which they should be made to conform.

The general political doctrine is as follows: Society is composed of a number of individuals, all having the same natural rights. If all do not possess (as some members of the negative school maintained) equal capacities, each can at least best understand his own interest, and is led by nature to follow it. The social union is really a contract between these individuals, the object of which is the limitation of the natural freedom of each just so far as it is inconsistent with the rights of the others. Government, though necessary, is a necessary evil; and the governing power appointed by consent should be limited to the amount of interference absolutely required to secure the fulfilment of the contract. In the economic sphere this implies the right of the individual to such natural enjoyments as he can acquire by his labour. That labour, therefore, should be undisturbed and unfettered, and its fruits should be guaranteed to the possessor; in other words, property should be sacred. Each citizen must be allowed to make the most of his labour; and therefore freedom of exchange should be ensured, and competition in the market should be unrestricted, no monopolies or privileges being permitted to exist.

The physiocrats then proceed with the economic analysis as follows: Only those labours are truly "productive" which add to the quantity of raw materials available for the purposes of man; and the real annual addition to the wealth of the community consists of the excess of the mass of agricultural products (including, of course, metals) over their cost of production. On the amount of this *produit net* depends the well-being of the community and the possibility of its advance in civilization. The manufacturer merely gives a new form to the materials extracted from the earth; the higher value of the object, after it has passed through his hands, only represents the quantity of provisions and other materials used and consumed in its elaboration. Commerce does nothing more than transfer the wealth already existing from one hand to another; what the trading classes gain thereby is acquired at the cost of the nation, and it is desirable that its amount should be as small as possible. The occupations of the manufacturer and merchant, as well as the liberal professions, and every kind of personal service, are "useful" indeed, but they are "sterile," drawing their income, not from any fund which they themselves create, but from the superfluous earnings of the agriculturist. The revenue of the state, which must be derived altogether from this net product, ought to be raised in the most direct and simplest way—namely, by a single impost of the nature of a land tax.

The special doctrine relating to the exclusive productiveness of agriculture arose out of a confusion between "value" on the one hand and "matter and energy" on the other. A. Smith and others have shown that the attempt to fix the character of "sterility" on manufactures and commerce was founded in error. And the proposal of a single *impôt territorial* falls to the ground with the doctrine on which it was based. But such influence as the school exerted depended little, if at all, on these

peculiar tenets, which indeed some of its members did not hold. The effective result of its teaching was mainly destructive. It continued in a more systematic form the efforts in favour of the freedom of industry already begun in England and France. It was to be expected that the reformers should, in the spirit of the negative philosophy, exaggerate the vices of established systems; and there can be no doubt that they condemned too absolutely the economic action of the state, both in principle and in its historic manifestations, and pushed the *laissez-faire* doctrine beyond its just limits. But this was a necessary incident of their connexion with the revolutionary movement; of which they really formed one wing. In the course of that movement, the primitive social contract, the sovereignty of the people and other dogmas now seen to be untenable, were habitually invoked in the region of politics proper, and had a transitory utility as ready and effective instruments of warfare. And so also in the economic sphere the doctrines of natural rights of buying and selling, of the sufficiency of enlightened selfishness as a guide in mutual dealings, of the certainty that each member of the society will understand and follow his true interests, and of the coincidence of those interests with the public welfare, though they will not bear a dispassionate examination, were temporarily useful as convenient and servicable weapons for the overthrow of the established order.

These conclusions as to the revolutionary tendencies of the school are not at all affected by the fact that the form of government preferred by Quesnay and some of his chief followers was what they called a legal despotism, which should embrace within itself both the legislative and the executive function. The reason for this preference was that an enlightened central power could more promptly and efficaciously introduce the policy they advocated than an assembly representing divergent opinions and fettered by constitutional checks and limitations. Turgot used the absolute power of the Crown to carry into effect some of his measures for the liberation of industry, though he ultimately failed because unsupported by the requisite force of character in Louis XVI. But what the physiocratic idea with respect to the normal method of government was appears from Quesnay's advice to the dauphin, that when he became king he should "do nothing, but let the laws rule," the laws having been, of course, first brought into conformity with the *ius naturae*. The partiality of the school for agriculture was in harmony with the sentiment in favour of "nature" and primitive simplicity which then showed itself in so many forms in France, especially in combination with the revolutionary spirit, and of which Rousseau was the most eloquent exponent. The members of the physiocratic group were undoubtedly men of thorough uprightness, and inspired with a sincere desire for the public good, especially for the material and moral elevation of the working classes. Quesnay was physician to Louis XV, and resided in the palace at Versailles; but in the midst of that corrupt court he maintained his integrity, and spoke with manly frankness what he believed to be the truth. And never did any statesman devote himself with greater singleness of purpose or more earnest endeavour to the service of his country than Turgot, who was the principal practical representative of the school.

The physiocratic school never obtained much direct popular influence, even in its native country, though it strongly attracted many of the more gifted and earnest minds. Its members, writing on dry subjects in an austere and often heavy style, did not find acceptance with a public which demanded before all things charm of manner in those who addressed it. The physiocratic tenets, which were in fact partly erroneous, were regarded by many as chimerical, and were ridiculed in the contemporary literature; as, for example, the *impôt unique* by Voltaire in his *L'Homme aux quarante écus*, which was directed in particular against P. P. Mercier-Larivière (1720-1794). It was justly objected to the group that they were too absolute in their view of things; they supposed, as Smith remarks in speaking of Quesnay, that the body politic could thrive only under one precise régime—that, namely, which they recommended—and

thought their doctrines universally and immediately applicable in practice. They did not, as theorists, sufficiently take into account national diversities or different stages in social development; nor did they, as politicians, adequately estimate the impediments which ignorance, prejudice and interested opposition present to enlightened statesmanship.

The physiocratic system, after guiding in some degree the policy of the Constituent Assembly, and awakening a few echoes here and there in foreign countries, soon ceased to exist as a living power; but the good elements it comprised were not lost to mankind, being incorporated into the more complete construction of Adam Smith.

See the article on *QUESTNAY*, with bibliography appended thereto, also the articles on *MIRABEAU* and *TURCOT*. Most French histories contain an account of the school; see especially Toqueville, *L'Ancien régime et la révolution*, ch. iii.; Taine, *Les Origines de la France contemporaine*, vol. i.; R. Stourm, *Les Finances de l'ancien régime et de la révolution* (1885); Droz, *Histoire du règne de Louis XVI.*; also L. de Lavergne, *Économistes français du XVIII^e siècle*; H. Higgs, *The Physiocrats* (London, 1897; with authorities).

PHYSIOGNOMY, the English form of the middle Greek *φυσιογνωμία*, a contraction of the classical *φυσιογνωμονία* (from *φύσις*, nature, and *γνώμων*, an interpreter), (1) a term which denotes a supposed science for the "discovery of the disposition of the mind by the lineaments of the body" (Bacon); (2) is also used colloquially as a synonym for the face or outward appearance, being variously spelled by the old writers: *fyseonomy* by Lydgate, *phisonomi* in Udall's translation of Erasmus on Mark iv., *physnomie* in Bale's *English Volaries* (i. 2. p. 44), and *fsnomie* in *All's well that ends well*, iv. 5 (first folio).

Physiognomy was regarded by those who cultivated it as a twofold science: (1) a mode of discriminating character by the outward appearance, and (2) a method of divination from form and feature. On account of the abuses of the latter aspect of the subject its practice was forbidden by the English law. By the act of parliament 17 George II. c. 5 (1743) all persons pretending to have skill in physiognomy were deemed rogues and vagabonds, and were liable to be publicly whipped, or sent to the house of correction until next sessions.¹ The pursuit thus stigmatized as unlawful is one of great antiquity, and one which in ancient and mediæval times had an extensive though now almost forgotten literature. It was very early noticed that the good and evil passions by their continual exercise stamp their impress on the face, and that each particular passion has its own expression. Thus far physiognomy is a branch of physiology. But in its second aspect it touched divination and astrology, of which Galea² says that the physiognomical part is the greater, and this aspect of the subject bulked largely in the fanciful literature of the middle ages. There is evidence in the earliest classical literature that physiognomy formed part of the most ancient practical philosophy. Homer was a close observer of expression and of appearance as correlated with character, as is shown by his description of Thersites³ and elsewhere. Hippocrates, writing about 450 B.C., expresses his belief in the influence of environment in determining disposition, and in the reaction of these upon feature,⁴ a view in which he is supported later by Trogas. Galen, in his work *Περὶ τῶν τῆς ψυχῆς φάσεων*, having discussed the nature and immortality of the soul, proceeds in ch. vii. to a brief study of physiognomy (ed. Kuhn iv. 795). In this passage he deprecates current physiognomical speculations, saying that he might criticize them but feared to waste time and become tedious over them. In chapter viii. he quotes with approbation the Hippocratic doctrine referred to above; and

¹ The Act 39 Elizabeth c. 4 (1597-1598) declared "all persons faying to have knowledge of Physiognomy or like Fausticall ymaginacions" liable to "be stripped naked from the middle upwards and openly whipped until his body be bloudy." This was modified by 13 Anne c. 26 (1713), still further by 17 George II. c. 5, which was re-enacted by the Vagrancy Act 1824. This last act only specifies palmistry.

² Galen, *Περὶ καταλλήλων προγνωστικῶν* (ed. Kühn xix. 530).

³ *Iliad*, ii. 214. See also Blackwell's *Inquiry*, (2nd ed. 1736), p. 330. A physiognomical study of the Homeric heroes is given by Malalae, *Chronogr.* ed. Dindorf, v. 105.

⁴ *Περὶ ἀρίων, ἰσθμῶν, τόνων* (ed. Kühn, i. 547).

in a later work, *Περὶ καταλλήλων προγνωστικῶν*, he speaks of the advantage of a knowledge of physiognomy to the physician.⁵ We learn both from Iamblichus⁶ and Porphyry⁷ that Pythagoras practised the diagnosis of the characters of candidates for pupilage before admitting them, although he seems to have discredited the current physiognomy of the schools, as he rejected Cyo, the Crotonian, on account of his professing these doctrines, and thereby was brought into some trouble.⁸ Plato also tells us that Socrates predicted the promotion of Alcibiades from his appearance; and Apuleius⁹ speaks of Socrates recognizing the abilities of Plato at first view. On the other hand, it has been recorded by Cicero¹⁰ that a certain physiognomist, Zopyrus, who professed to know the habits and manners of men from their bodies, eyes, face and forehead, characterized Socrates as stupid, sensual and dull (*bardus*), "in quo Alcibiades cachinum dicitur sustulisse." Alexander Aphrodisiensis adds that when his disciples laughed at the judgment, Socrates said it was true, for such had been his nature before the study of philosophy had modified it. Zopyrus is also referred to by Maximus Tyrius¹¹ as making his recognitions "intuitu solo."

That one's occupation stamps its impress on the outward appearance was also noticed at an early period. In the curious poem in the Sallier papyrus (II.), written about 1800 B.C., Dana, son of Khertu, expatiates on the effects of divers handicrafts on the workmen as compared with the elevating influences of a literary life.¹² Josephus tells us that Caesar detected the pretence of the spurious Alexander by his rough hands and surface.¹³

The first systematic treatise which has come down to us is that attributed to Aristotle,¹⁴ in which he devotes six chapters to the consideration of the method of study, the general signs of character, the particular appearances characteristic of the dispositions, of strength and weakness, of genius and stupidity, of timidity, impudence, anger, and their opposites, &c. Then he studies the physiognomy of the sexes, and the characters derived from the different features, and from colour, hair, body, limbs, gait and voice. He compares the varieties of mankind to animals, the male to the lion, the female to the leopard. The general character of the work may be gathered from the following specimen. While discussing noses, he says that those with thick bulbous ends belong to persons who are insensitive, swinish; sharp-tipped belong to the frascible, those easily provoked, like dogs; rounded, large, obtuse noses to the magnanimous, the lion-like; slender hooked noses to the eagle-like the noble but grasping; round-tipped retroussé noses to the luxurious, like barndoor fowl; noses with a very slight notch at the root belong to the impudent, the crow-like; while snub noses belong to persons of luxurious habits, whom he compares to deer; open nostrils are signs of passion, &c.

The practice of physiognomy is alluded to in many of the Greek classics.¹⁵ Apion speaks of the metoposcopists, who judge by the appearance of the face, and Cleanthes the Stoic says it is

⁵ *Op. cit.*, xix. 530.

⁶ *Περὶ βίω Πυθαγορικῶν λόγων*, i. 17, 59 (Amsterdam, 1707).

⁷ *De vita Pythagorae*, p. 16 (Amsterdam, 1707). This author tells us that he applied the same rule to his friends. See also Aulus Gellius, i. 12.

⁸ *Iamblichus*, p. 49.

⁹ *De dogmate Platonicis*, i. 567, p. 34 (Leiden, 1714).

¹⁰ *Tascul. quaestionum*, iv. 37. *De fato*, v.

¹¹ *Diog.*, xv. 157 (Cambridge, 1703).

¹² *Selact Papyrus*, Pl. xv., xix., and (Anastasi) *ibid.*, cxxviii., cxxxiii.

¹³ *Ant.*, xvii. 12, 2.

¹⁴ Authors differ in their views as to its authenticity, but Diogenes Laërtius (v. 22) and Stobaeus (*Serm.* clxxxix.) both believe it to be genuine. The chief difficulty is the reference to a certain sophist, Dionysius, but this is probably an interpolation. There are physiognomical references in other writings of Aristotle (cf. *Anal. pr.*, i. c. 30; *Hist. anim.*, i. 8, &c.) sufficient to justify the attribution of the treatise to him. On this, see Franz, *Preface*, p. vi. seq., of his *Scriptores physiognomiae veteres* (Leipzig, 1780).

¹⁵ See an interesting paper on "Stretching and Yawning as Signs of Madness," by Professor Ridgeway (*Trans. Camb. Phil. Soc.*, i. 201), which refers to Aristotle, *Wasps*, 642, with which he compares Plautus, *Menaechmi*, 279. Other references exist to physiognomy in Cassiodorus, Isidorus, Meletius and Nemesius, but none of any great importance.

possible to tell habits from the aspect (cf. *Ecclus.* xix. 29, 30). Polemon (c. A.D. 150) compiled a treatise (published 1534, in Latin) on the subject, similar in character to that of Aristotle; but he excels in graphic descriptions of different dispositions, and differs only from Aristotle in some of his animal comparisons. A more important work was written by a converted Jew, Adamantius, about A.D. 415. This is in two books, the first on the expression of the eye, the second on physiognomy in general, mostly Aristotelian in character.

Among the Latin classical authors Juvenal, Suetonius and Pliny in well-known passages refer to the practice of physiognomy, and numerous allusions occur in the works of the Christian Fathers, especially Clement of Alexandria and Origen (for example, the familiar passage in his work against Celsus, i. 33).¹

While the earlier classical physiognomy was chiefly descriptive, the later medieval authors particularly developed the predictive and astrological side, their treatises often digressing into chiromancy, onychomancy, clidomancy, podoscopy, spasmatomancy, and other branches of prophetic folk-lore and magic.

Along with the medical science of the period the Arabians contributed to the literature of physiognomy; 'Alī b. Ragel wrote a book on *naevi*; Rhazes (1040) devoted several chapters to it; and Averroes (1165) made many references to it in his *De sensitate*, p. 82 (Leiden, 1537). Avicenna also makes some acute physiognomical remarks in his *De animalibus*, which was translated by Michael Scot about 1270. Among medieval writers Albertus Magnus (born 1205) devotes much of the second section of his *De animalibus* to physiognomy; but this chiefly consists of extracts from Aristotle, Polemon and Loxus. He does not enter into the animal comparisons of his predecessors, but occupies himself chiefly with simple descriptive physiognomy as indicative of character; and the same is true of the scattered references in the writings of Duns Scotus and Thomas Aquinas. The famous sage of Balwearie, Michael Scot, while court astrologer to the emperor Frederick II., wrote his treatise *De hominis physiognomia*, much of which is physiological and of curious interest. It was probably composed about 1272, but not printed until 1477. This was the first printed work on the subject. Physiognomy also forms the third part of his work *De secretis naturae*. In 1335 Pietro d'Abano of Padua delivered in Paris a course of lectures on this subject (afterwards edited by Blondus, 1544), a few years before he was burned for heresy.

The 16th century was rich in publications on physiognomy. The works of the classical authors before mentioned were printed, and other treatises were published by John de Indagine, Cocles, Andreas Corvus, Michael Blondus, Janus Cornaro, Anselm Douxciel, Pompeius Ronneus, Gratarolus, Lucas Gauricus, Tricassus, Cardanus, Taisnierus, Magnus Hund, Rothman, Johannes Padovanus, and, greatest of all, Giambattista della Porta. The earliest English works were anonymous: *On the Art of Foretelling Future Events by Inspection of the Hand* (1504), and *A Pleasant Introduction to the Art of Chiromancy and Physiognomy* (1588). Dr Thomas Hill's work, *The Contemplation of Mankynde, containing a singular Discourse after the Art of Physiognomy*, published in 1571, is a quaintly written adaptation from the Italian authors of the day. The undated book on moles and naevi by "Merlin Britannicus," after the model of 'Alī ibn Ragel, is of about the same date.

The development of a more accurate anatomy in the 17th century seems to have diminished the interest in physiognomy, by substituting fact for fiction; and consequently the literature, though as great in quantity, became less valuable in quality. The principal writers of this age were T. Campanella, R. Coclenius, Clement, Timpler, J. E. Gallimard, Moldomarius, Septalius, Saunders, C. Lebrun (a precursor of Charles Bell), Elsholz, de la Bellière, J. Evelyn (in the appendix to *Nomisastata*), Baldus, Bulwer (in his *Palmomyotomia*), Fuchs, Spontoni, Ghiradelli,

Chiaramonti, A. Ingegneri, Fhella, De la Chambre, Zaaardus, R. Fludd, and others of less importance.

The 18th century shows a still greater decline of interest in physiognomy. Historians of philosophy, like J. Meursius and Franz, re-edited some of the classical works, and G. G. Fülleborn reviewed the relation of physiognomy to philosophy. Indeed, the only name worthy of note is that of J. K. Lavater (q.v.). The other authors of this century are Puschel, Spon, Schutz, Wegelin, J. Pernetti, Girtanner, Grohmann, and several anonymous writers, and from the anatomical side G. M. Lancisi, J. Parsons and Peter Camper. The popular style, good illustrations and pious spirit pervading the writings of Lavater have given to them a popularity they little deserved, as there is no system in his work, which chiefly consists of rhapsodical comments upon the several portraits. Having a happy knack of estimating character, especially when acquainted with the histories of the persons in question, the good pastor contrived to write a graphic and readable book, but one much inferior to Porta's or Aristotle's as a systematic treatise. The treatises of Nicolai and of Lichtenberg were written to refute his theory. With Lavater the descriptive school of physiognomists may be said to have ended, as the astrological physiognomy expired with de la Bellière. The few works which have since appeared, before the rise of the physiological school of Sir Charles Bell and Charles Darwin, are undeserving of notice, the development of phrenology having given to pure physiognomy the *coup de grâce* by taking into itself whatever was likely to live of the older science. The writers of the 19th century are Hörstig, Maas, Rainer, Thoné, A. Stöhr, Sehler, Dr Rubels, Polli, Cardona, Mastriani, Diez, Carus, Piderit, Burgess and P. Gratialet.

The physiological school of physiognomy was foreshadowed by Parsons and founded by Sir Charles Bell, whose *Essay on the Anatomy of the Expression*, published in 1806, was the first scientific study of the physical manifestation of emotions in the terms of the muscles which produce these manifestations. In the later editions of this essay the thesis is elaborated with greater detail. Moreau's edition of Lavater, in 1807, was somewhat along the same lines. In 1817 Dr Cross of Glasgow wrote his defence of a scientific physiognomy based on general physiological principles. The experiments of G. B. A. Duchenne (*Mécanisme de la physiognomie humaine*, Paris, 1862) showed that by the use of electricity the action of the separate muscles could be studied and by the aid of photography accurately represented. These observations confirmed by experimental demonstration the hypothetical conclusions of Bell. The machinery of expression having thus been indicated, the connexion of the physical actions and the psychological state was made the subject of speculation by Herbert Spencer (*Psychology*, 1855). These speculations were reduced to a system by Darwin (*Expression of Emotions*, 1872), who formulated and illustrated the following as fundamental physiognomical principles:—

(1) Certain complex acts are of direct or indirect service, under certain conditions of the mind, in order to relieve or gratify certain sensations or desires; and whenever the same states of mind are induced the same sets of actions tend to be performed, even when they have ceased to be of use. (2) When a directly opposite state of mind is induced to one with which a definite action is correlated, there is a strong and involuntary tendency to perform a reverse action. (3) When the sensorium is strongly excited nerve-force is generated in excess, and is transmitted in definite directions, depending on the connexions of nerve-cells and on habit.

The last of these propositions is adversely criticized by P. Mantegazza as a truism, but it may be allowed to stand with the qualification that we are ignorant concerning the nature of the influence called "nerve-force." It follows from these propositions that the expression of emotion is, for the most part, not under control of the will, and that those striped muscles are the most expressive which are the least voluntary. To the foregoing may be added the following three additional propositions, so as to form a more complete expression of a physiognomical philosophy:—

(4) Certain muscles concerned in producing these skin-folds become strengthened by habitual action, and when the skin diminishes

¹ For Scriptural allusions to physiognomy see Vecchiusi, *Observationes in din. script.* (Naples, 1641). Other classical references are contained in the *Prooemium* to the 1593 edition of the works of Baptistista Porta.

in elasticity and fulness with advancing age, the wrinkles at right angles to the course of the muscular fibres become permanent. (5) To some extent habitual muscular action of this kind may, by affecting local nutrition, alter the contour of such bones and cartilages as are related to the muscles of expression. (6) If the mental disposition and proneness to action are inherited by children from their parents, it may be that the facility in, and disposition towards, certain forms of expression are in like manner matters of heredity.

Illustrations of these theoretic propositions are to be found in the works of Bell, Duchenne and Darwin, and in the later publications of Theodor Fiderit, *Mimiké und Physiognomik* (1886) and Mantegazza, *Physiognomy and Expression* (1890), to which the student may be referred for further information.

For information on artistic anatomy as applied to physiognomy see the catalogue of sixty-two authors by Ludwig Choulant, *Geschichte und Bibliographie der anatomischen Abbildung*, &c. (Leipzig, 1852), and the works of the authors enumerated above, especially those of Aristotle, Franz, Porta, Cardan, Corvus and Bulwer. For physiognomy of disease, besides the usual medical handbooks, see Cabuchet, *Essai sur l'expression de la face dans les maladies* (Paris, 1801); Mantegazza, *Physiology of Pain* (1893), and Polli, *Saggio di fisiognomica e potognomica* (1837). For ethnological physiognomy, see amongst older authors Gratarolus, and amongst moderns the writers cited in the various textbooks on anthropology, especially Schadow, *Physiognomies nationales* (1835) and Park Harrison, *Journ. Anthropol. Inst.* (1883). The study of the physical characteristics of criminals is discussed at great length by Lombroso, *L'Uomo delinquente* (1897); Ferri, *L'Omiciolo* (1895); von Baer, *Der Verbrecher* (1893); Laurent, *Les Habitudes des prisons* (1890); and Havelock Ellis, *The Criminal* (1901).

PHYSIOLOGUS, the title usually given to a collection of some fifty Christian allegories much read in the middle ages, and still existing in several forms and in about a dozen Eastern and Western languages. As nearly all its imagery is taken from the animal world, it is also known as the *Bestiary*. There can be hardly a doubt about the time and general circumstances of its origin. Christian teachers, especially those who had a leaning towards Gnostic speculations, took an interest in natural history, partly because of certain passages of Scripture that they wanted to explain, and partly on account of the divine revelation in the book of nature, of which also it was man's sacred duty to take proper advantage. Both lines of study were readily combined by applying to the interpretation of descriptions of natural objects the allegorical method adopted for the interpretation of Biblical texts. Now the early Christian centuries were anything but a period of scientific research. Rhetorical accomplishments were considered to be the chief object of a liberal education, and to this end every kind of learning was made subservient. Instead of reading Aristotle and other naturalists, people went for information to commonplace books like those of Aelian, in which scraps of folk-lore, travellers' tales and fragments of misapprehended science were set forth in an elegant style. Theological writers were not in the least prepared to question the worth of the marvellous descriptions of creatures that were current in the schools on the faith of authorities vaguely known as "the history of animals," "the naturalists," and "the naturalist" in the singular number (*φυσιολόγος*).¹ So they took their notions of strange beasts and other marvels of the visible world on trust and did their best to make them available for religious instruction. In some measure we find this practice adopted by more than one of the Fathers, but it was the Alexandrian school, with its pronounced taste for symbolism, that made the most of it. Clement himself had declared that natural lore, as taught in the course of higher Christian education according to the canon of truth, ought to proceed from "cosmogony" to "the theological idea,"² and even in the little that is left of the works of Origen we find two instances of the proceeding in question. And yet the fact that these reappear in the *Physiologus* would not suffice to stamp the work as a series of extracts from Alexandrian writings, as parallels of the same kind can be adduced

¹ Origen, *Sol. in Jerem.* xvii. 11, *ἡ τῆς τοῦ ζῴου ἰστορίας*; Epiphanius, *Adv. Hæres.* i. 3, p. 274 (ed. D. Petav.), *ὅτι φασὶν οὐ φυσιολόγος*; Origen, *Hom.* xviii., in Gen. xlii. 9, "nam physiologus de catulo leonis scribit."

² *Strom.* iv. p. 564 (ed. Potter), *ἡ γὰρ κατὰ τὸν ἥτις ἀληθὴς κἀνθε ἡμετέρας ἐπαύσεως φυσιολόγια, μέλλουσι εἰ ἰσχυροῦν, ἡ τῶν τοῦ παντογνοῦντος ἑστῆρας λόγων, ἐν τῷδε ἀσφαλτοῦσιν ἐπὶ τὸ θεολογικὸν εἶδος.*

from Epiphanius (*loc. cit.*) and Ephraem Syrus (*Opp. Syr. B.* 17, 130). Father Cahier would even trace the book to Tatian, and it is true that that heresiarch mentions a writing of his own upon animals. Still, the context in which the quotation occurs makes it evident that the subject-matter was not the nature of particular species nor the spiritual lessons to be drawn therefrom, but rather the place occupied by animal beings in the system of creation. On the other hand, the opinion of Cardinal Pitru, who referred the *Physiologus* to the more orthodox though somewhat peculiar teaching of the Alexandrians, is fully borne out by a close examination of the irregularities of doctrine pointed out in the *Physiologus* by Cahier, all of which are to be met with in Origen. The technical words by which the process of allegorizing is designated in the *Physiologus*, like *ἑρμηνεία*, *θεωρία*, *ἀναγωγή*, *ἀλληγορία*, are familiar to the students of Alexandrian exegesis. It has, moreover, been remarked that almost all the animals mentioned were at home in the Egypt of those days, or at least, like the elephant, were to be seen there occasionally, whereas the structure of the hedgehog, for instance, is explained by a reference to the sea-porcupine, better known to fish-buyers on the Mediterranean. The fables of the phoenix and of the conduct of the wild ass and the ape at the time of the equinox owe their origin to astronomical symbols belonging to the Nile country.³ In both chapters an Egyptian month is named, and elsewhere the antelope bears its Coptic name of "antholops."

That the substance of the *Physiologus* was borrowed from commentaries on Scripture⁴ is confirmed by many of the sections opening with a text, followed up by some such formula as "but the Physiologus says." When zoological records failed, Egypto-Hellenic ingenuity was never at a loss for a fanciful invention distilled from the text itself, but which to succeeding copyists appeared as part of the teaching of the original *Physiologus*. As a typical instance we may take the chapter on the ant-lion—not the insect, but an imaginary creature suggested by Job. iv. 11. The exceptional Hebrew for a lion (*layish*) appeared to the Septuagint translators to call for a special rendering, and as there was said to exist on the Arabian coast a lion-like animal called "myrmex" (see Strabo xvi. 774; Aelian, *N.A.*, vii. 47) they ventured to give the compound noun "myrmekoleon." After so many years the commentators had lost the key to this unusual term, and only knew that in common Greek "myrmex" meant an ant. So the text "the myrmekoleon hath perished for that he had no nourishment" set them pondering, and others reproduced their meditations, with the following result: "The *Physiologus* relates about the ant-lion: his father hath the shape of a lion, his mother that of an ant; the father liveth upon flesh, and the mother upon herbs. And these bring forth the ant-lion, a compound of both, and in part like to either, for his fore part is that of a lion, and his hind part like that of an ant. Being thus composed, he is neither able to eat flesh like his father, nor herbs like his mother; therefore he perisheth from inanition"; the moral follows.

At a later period, when the Church had learnt to look with suspicion upon devotional books likely to provoke the scoffing of some and lead others into heresy, a work of this kind could hardly meet with her approval. A synod of Pope Gelasius, held in 496, passed censure, among others, on the "Liber Physiologus, qui ab hæreticis conscriptus est et B. Ambrosii nomine signatus, apocryphus," and evidence has even been offered that a similar sentence was pronounced a century before. Still, in spite of such measures, the *Physiologus*, like the *Church History* of Eusebius or the *Pastor of Hermas*, continued to be read with general interest, and even Gregory the Great did not disdain to allude to it on occasion. Yet the Oriental versions, which had certainly nothing to do with the Church of Rome, show that there was no systematic revision made according to the catholic

³ Cp. Leemans on Horapollo i. 16, 34.

⁴ Including the Apocrypha. See the Icelandic account of the elephant, also a decidedly Alexandrian fragment upon the *phægan*, founded upon 4 Macc. i. 3, which has got into the scholia upon the *Odyssey* xviii. 2 (ii. 533, ed. Dindorf, Oxford, 1855).

standard of doctrine. The book remained essentially the same, albeit great liberties were taken with its details and outward form. There must have been many imperfect copies in circulation, from which people transcribed such sections as they found or chose, and afterwards completed their MS. as occasion served. Some even rearranged the contents according to the alphabet or to zoological affinity. So little was the collection considered as a literary work with a definite text that every one assumed a right to abridge or enlarge, to insert ideas of his own, or fresh scriptural quotations; nor were the scribes and translators by any means scrupulous about the names of natural objects, and even the passages from Holy Writ. *Physiologus* had been abandoned by scholars, and left to take its chance among the tales and traditions of the uneducated mass. Nevertheless, or rather for this very reason, its symbols found their way into the rising literature of the vulgar tongues, and helped to quicken the fancy of the artists employed upon church buildings and furniture.

The history of the *Physiologus* has become entwined from the beginning with that of the commentaries on the account of creation in Genesis. The principal production of this kind in our possession is the *Hexameron* of Basil, which contains several passages very like those of the *Physiologus*. For instance, in the seventh homily the fable of the nuptials of the viper and the conger-eel, known already to Aelian and Oppian, and proceeding from a curious misreading of Aristotle (*Hist. An.* v. 4, 540 b, Bekk.), serves to point more than one moral. Notwithstanding the difference in theology, passages of this kind could not but be welcome to the admirers of the Alexandrian allegories. In fact a medley from both Basil and the *Physiologus* exists under the title of the *Hexameron* of Eustathius; some copies of the first bear as a title *Περὶ φυσιολογίας*, and in a Milan MS. the "morals" of the *Physiologus* are ascribed to Basil. The Leyden Syriac is supplemented with literal extracts from the latter, and the whole is presented as his work. Other copies give the names of Gregory Theologus, Epiphanius, Chrysostom and Isidore.

As far as can be judged, the emblems of the original *Physiologus* were the following: (1) the lion (footprints rubbed out with tail; sleeps with eyes open; cubs receive life only three days after birth by their father's breath); (2) the sun-lizard (restores its sight by looking at the sun); (3) the charadrius (*Deut.* xiv. 16; presages recovery or death of patients); (4) the pelican (recalls its young to life by its own blood); (5) the owl (or nyktikorax; loves darkness and solitude); (6) the eagle (renews its youth by sunlight and bathing in a fountain); (7) the phoenix (revives from fire); (8) the hoopoe (redeems its parents from the ills of old age); (9) the wild ass (suffers no male besides itself); (10) the viper (born at the cost of both its parents' death); (11) the serpent (sheds his skin; puts aside its venom before drinking; is afraid of man in a state of nudity; hides its head and abandons the rest of its body); (12) the ant (orderly and laborious; prevents stored grain from germinating; distinguishes wheat from barley on the stalk); (13) the sirens and onocentaurs (*Isa.* xiii. 21, 22; compound creatures); (14) the hedgehog (pricks grapes upon its quills); (15) the fox (catches birds by simulating death); (16) the panther (spotted skin; enmity to the dragon; sleeps for three days after meals; allures its prey by sweet odour); (17) the sea-tortoise (or aspidochelone; mistaken by sailors for an island); (18) the partridge (hatches eggs of other birds); (19) the vulture (assisted in birth by a stone with loose kernel); (20) the ant-lion (able neither to take the one food nor to digest the other); (21) the weasel (conceives by the mouth and brings forth by the ear); (22) the unicorn (caught only by a virgin); (23) the beaver (gives up its testes when pursued); (24) the hyaena (a hermaphrodite); (25) the otter (enhydris; enters the crocodile's mouth to kill it); (26) the ichneumon (covers itself with mud to kill the dragon; another version of No. 25); (27) the crow (takes but one consort in its life); (28) the turtle-dove (same nature as No. 27); (29) the frog (either living on land and killed by rain, or in the water without ever seeing the sun); (30) the stag (destroys its enemy the serpent); (31) the salamander (quenches fire);

(32) the diamond (powerful against all danger); (33) the swallow (brings forth but once; misreading of Aristotle, *Hist. An.* v. 13); (34) the tree called peridexion (protects pigeons from the serpent by its shadow); (35) the pigeons (of several colours; led by one of them, which is of a purple or golden colour); (36) the antelope (or hydrrippus; caught by its horns in the thicket); (37) the fire-flints (of two sexes; combine to produce fire); (38) the magnet (adheres to iron); (39) the saw-fish (sails in company with ships); (40) the ibis (fishes only along the shore); (41) the ibex (descries a hunter from afar); (42) the diamond again (read "carbuncle"; found only by night); (43) the elephant (conceives after partaking of mandrake; brings forth in the water; the young protected from the serpent by the father; when fallen is lifted up only by a certain small individual of its own kind); (44) the agate (employed in pearl-fishing); (45) the wild ass and ape (mark the equinox); (46) the Indian stone (relieves patients of the dropsy); (47) the heron (touches no dead body, and keeps to one dwelling-place); (48) the sycamore (or wild fig; grubs living inside the fruit and coming out); (49) the ostrich (devours all sorts of things; forgetful of its own eggs). Besides these, or part of them, certain copies contain sections of unknown origin about the bee, the stork, the tiger, the woodpecker, the spider and the wild boar.

The Greek text of the *Physiologus* exists only in late MSS., and has to be corrected from the translations. In Syriac we have a full copy in a 12th-century Leyden MS., published in J. P. N. Land's *Anecdota syriaca*; thirty-two chapters with the "morals" left out in a very late Vatican copy, published by Tychsen; and about the same number in a late MS. of the British Museum (*Add.* 25878). In Armenian Pitra gave some thirty-two chapters from a Paris MS. (13th century). The Aethiopic exists both in London and Paris, and was printed at Leipzig by Dr Hommel in 1877. In Arabic we have fragments at Paris, of which Renan translated a specimen for the *Spicilegium solesmense*, and another version of thirty-seven chapters at Leiden, probably the work of a monk at Jerusalem, which Land translated and printed with the Syriac. The Latin MSS. of Bern are, after the Vatican glossary of Anselmus, the oldest of which we know; there are others in several libraries, and printed editions by Mai, Heider and Cahier. Besides these, a few fragments of an old abridgment occur in Vallara's edition of Jerome's works (vol. xi. col. 218). A metrical *Physiologus* of but twelve chapters is the work of Theobaldus, probably abbot of Monte Cassino (A.D. 1022-1035). From this was imitated the Old-English fragment printed by Th. Wright, and afterwards by Maetzner; also the Old-French *Sensuel le bestiaire d'amours*. The prose *Physiologus* was done into Old High German before 1000, and afterwards into rhyme in the same idiom; since Von der Hagen (1824) its various forms have found careful editors among the leading Germanists. The Icelandic, in a Copenhagen MS. of the 13th century, was printed by Professor Th. Möbius in his *Anecdota norroena* (2nd ed., 1877); at the same time he gave it in German in Dr Hommel's Aethiopic publication. Some Anglo-Saxon metrical fragments are to be found in Grein's *Bibliothek*, vol. I. The Provençal (c. 1250), published in Bartsch's *Chrestomathie provençale*, omits the "morals," but is remarkable for its peculiarities of form. Before this there had been translations into French dialects, as by Philippe de Thau (1121), by Guillaume, "clerc de Normandie," also, about the same period, by Pierre, a clegymann of Picardy. All the Old-French materials have not yet been thoroughly examined, and it is far from improbable that some versions of the book either remain to be detected or are now lost past recovery. A full account of the history of the *Physiologus* should also embrace the subjects taken from it in the productions of Christian art, the parodies suggested by the original work, e.g. the *Bestiaire d'amour* by Richard de Fournival, and finally the traces left by it upon the encyclopaedical and literary work of the later middle ages.

Nearly all the information now obtainable is to be found in the following works and such as are there quoted: S. Epiphanius ad *physiologum*, ed. Ponce de Leon (with woodcuts) (Rome, 1587); another edition, with copper-plates (Antwerp, 1588); S. Eustathii in *hexameron commentarius*, ed. Leo Allatius (Lyons, 1629; cf. H. van Herwerden, *Exercit. Crit.*, pp. 180-182, Hague, 1862); *Physiologus syriacus*, ed. O. G. Tychsen (Rostock, 1795); *Classici auctores*, ed. Mai, vii. 585-596 (Rome, 1835); G. Heider, in *Archiv für Kunde österreich. Geschichtsquellen* ii. 545 seq. (Vienna, 1850); Cahier and Martin, *Mélanges d'archéologie*, &c. ii. 85 seq. (Paris, 1851), iii. 203 seq. (1853), iv. 55 seq. (1856); Cahier, *Nouveaux mélanges* (1874), p. 106 seq.; J. B. Pitra, *Spicilegium solesmense* iii. xviii. seq., 338 seq., 416, 533 (Paris, 1855); Maetzner, *Altengl. Sprachproben* (Berlin, 1867), vol. i. pt. i. p. 55 seq.; J. Victor Carus, *Gesch. der Zoologie* (Munich, 1872), p. 109 seq.; J. P. N. Land, *Anecdota syriaca* (Leiden, 1874), iv. 31 seq., 115 seq., and in *Verslagen en Mededeelingen der kon. Acad. van Wetenschappen*, 2d series, vol. iv. (Amsterdam, 1874); Möbius and Hommel in their

publications quoted above. See also Lauchert, *Geschichte des Physiologus* (Strassburg, 1889) and E. Peters, *Der griechische Physiologus und seine orientalischen Übersetzungen* (Berlin, 1898).

PHYSIOLOGY (from Gr. *physis*, nature, and *logos*, discourse), the science or theory of the properties, processes and functions of living organisms. Physiology is distinguished from anatomy as dealing specifically with the functions of an organism, rather than its structure. The two main branches of the science are animal and plant (vegetable) physiology, and in animal physiology that of man stands out as primarily associated with the word.

Ever since men began to take a scientific interest in the problems of life two distinct rival explanatory principles of vital phenomena have claimed attention: a natural and a mystical principle. The first outcome of the scientific attempt to explain vital phenomena after the natural method and by a unitary principle was the doctrine of the *Pneuma*, held by the followers of Hippocrates, which found its clearest expression in Galen's system. According to this doctrine, the origin of all vital phenomena was a very fine substance, the *Pneuma*, which was supposed to exist in atmospheric air, to be inhaled into the lungs of man, and thus through the blood to reach all the parts of the body, where it produced vital phenomena. This doctrine—an attempt to explain the phenomena of life which was not altogether natural, but even materialistic—was accepted by the middle ages together with Galen's system. With its translation into the Latin *spiritus*, however, the conception of the *Pneuma* lost its original force. The *spiritus animales* of the middle ages developed ere long into mystical powers, the result being the explanation of vital phenomena by a supernatural theory. Not until the scientific renaissance of the 16th and 17th centuries did views again undergo a change. After the establishment of a scientific method in physiology by William Harvey, and the development of Descartes' mechanical system of regarding living bodies, the natural explanation of vital phenomena once more universally found favour. Two schools arose, which endeavoured by dissimilar methods to find a mechanical explanation of vital phenomena: the *iatrophysical*, originating with the gifted and versatile Borelli, and the *iatrochemical*, founded by the Dutchman, F. de la Boë (Sylvius). But when both chemical and physical methods of explanation failed at such problems as, for instance, irritability and evolution, another change in opinion took place. By degrees there emerged once more the tendency to explain vital phenomena by mystical means, finding expression in the *Animism* of Stahl, to quote an example; and in the second half of the 18th century *Vitalism*, originating in France, began its victorious march throughout the whole scientific world. Again the opinion came to be entertained that the cause of vital phenomena was a mystical power (*force hypermécanique*)—that "vital force" which, neither physical nor chemical in its nature, was held to be active in living organisms only. Vitalism continued to be the ruling idea in physiology until about the middle of the 19th century, and its supremacy was only gradually overthrown by the great discoveries in natural science of that century. The chemical discoveries resulting from Wöhler's synthesis of urea first showed that typical products of the animal body, the production of which had hitherto been supposed to be solely the result of the operation of vital force, could be obtained artificially by purely chemical methods. Then above all came the discovery of the law of the Conservation of Energy by Robert Mayer (1814-1878) and Hermann von Helmholtz (1821-1894), and its application to the living organism by Mayer, Helmholtz, Pierre Louis Dulong (1785-1838), Edward Frankland, Max Rubner and others, to prove that the manifestations of energy by the organism are simply the result of the quantity of potential energy received into the body by means of food. Finally, the stupendous results arrived at by Darwin and the establishment of the fundamental law of "biogenesis" by Ernst Haeckel, prepared the way for a natural explanation of the enigma of evolution and structure of organisms. Thus by the second half of the 19th century the doctrine of vital force was definitely

and finally overthrown to make way for the triumph of the natural method of explaining vital phenomena, which down to the present time has continued to spread and flourish with an unparalleled fertility. It would, it is true, appear as if in our day, after the lapse of half a century, mystical tendencies were again disposed to crop up in the investigation of life. Here and there is heard once more the watchword of Vitalism. But all the so-called *neo-vitalistic* efforts—such as those of Alexander von Bunge (1803-1890), Georg Evon Rindfleisch (b. 1835), Johannes Reinke (b. 1849) and others—have nothing to do with the old vitalism. They originate solely in a widespread confusion with regard to the boundaries of natural science, their principal tendency being to amalgamate psychological and speculative questions with problems of purely natural science. In the face of all these efforts, which by their unfortunate designations of Vitalism and Neo-vitalism give rise to entirely false conceptions, and which by their intermingling of psychological questions and questions of natural science have led to mere confusion in research, it is essential that natural philosophy should be called upon to realize its own limits, and above all clearly to understand that the sole concern of physical science is the investigation of the phenomena of the material world. Physiology, as the doctrine of life, must therefore confine itself to the material vital phenomena of organisms. It is self-evident, however, that only such laws as govern the material world will be found governing material vital phenomena—the laws, that is, which have hitherto been brought to their most exact and most logical development by physics and chemistry, or, more generally speaking, by mechanics. The explanatory principles of vital phenomena must therefore be identical with those of inorganic nature—that is, with the principles of mechanics.

The investigation of vital phenomena in this sense requires, in the first place, an exact knowledge of the substratum in which these phenomena are manifested, just as in chemistry ^{Ultimate} and physics a thorough knowledge of the composition ^{Elements} of the material world is a necessary premise to the ^{Life} investigation of the phenomena of inorganic nature. The knowledge of the composition and structure of organisms has in the course of the scientific development of anatomy attained to an ever-increasing minuteness of detail, without having as yet reached a definite limit. The last important step in this direction was the discovery by Matthias Jakob Schleiden (1804-1881) and Theodor Schwann (1810-1882) that all organisms are built up of elementary living structural components, namely of cells (see *CYTOLOGY*). The details of the anatomical construction of organisms are described under various appropriate headings, and a general guide to these will be found under *ANATOMY* and *ZOOLOGY*. We would here merely point out that a cell is the simplest particle of living substance which appears to be permanently capable of life. Different elements are essential, however, to the existence of the cell—two, at least, so far as has hitherto been discovered—the protoplasm and the nucleus. It must at present be regarded as at least very doubtful whether the *centrosome*, which in recent times it has been possible to demonstrate as existing in very many cells, and which appears sometimes in the protoplasm, sometimes in the nucleus, is a general and third independent cell-constituent. On the other hand, the number of special constituent parts which appear in various cell-forms is very large. A question which has long been discussed, and which has received special and animated attention, is that with regard to the finer structure of the cells—with regard, that is, to the protoplasm and the nucleus lying in it. Views on this subject have diverged very widely, and several totally diverse theories have been opposed to one another. One theory maintains that the living cell-substance has a reticular structure; another, that it is fibrillous. According to a third theory, the essence of the construction of the cell-substance lies in the granules which it contains; and according to a fourth, it lies in the ground-substance in which these granules are embedded. One view holds this ground substance to be homogeneous, another regards it as possessing a fine foam-structure. It may at present be regarded as

incontrovertible that living substance is more or less fluid, and that there does not exist any general structure for all cell-forms. But in some special cases all the theories which have been quoted are to a certain extent correct. In different cells there are reticular, fibrillous and granular differentiations respectively, and differentiations in foam-structure; in many cells, however, the protoplasm appears to be beyond doubt homogeneous and without a distinct structure, and only under certain conditions to assume changing structures. But the fact which is of most importance for the right understanding of vital phenomena is that the cell-substance is always more or less fluid, for only in a fluid substratum can such intense chemical processes be enacted as are to be found in every living cell.

Where the analytical powers of the microscope in anatomy can go no farther, chemical analysis of the composition of the cell steps in. By its means the discovery is made that there is no elementary difference between organic and inorganic nature, for only such chemical elements as are known to exist in the inorganic world are found in the organic. On the other hand, however, the living cell-substance possesses chemical compounds which find analogues nowhere in inorganic nature. The characteristic organic substances which are present in every cell are proteids and proteid-compounds. Besides these there occur, widely disseminated, carbohydrates, fats and other organic substances, which partly originate in the decomposition of proteids and their compounds, and are partly used for their construction. Lastly, there are in addition great quantities of water and some inorganic salts.

Such are the structure and composition of the substratum in which vital phenomena play their part. When we consider general vital phenomena themselves in the various living organisms—in protists, plants, animals, man—there appears an incalculable diversity of phenomena. Here, however, as in the case of the structure of organisms, we have to analyse and to penetrate ever farther and deeper till we reach the fundamental phenomena. We then find that the great variety of vital manifestations may be traced back to a few fundamental general groups, which are precisely the same groups of phenomena as those to be observed in inorganic nature. All the processes that take place in the organic world may be regarded from the three different standpoints of their changes in substance, in energy and in form; for substance, energy and form are all necessary to our conception of matter. Accordingly, the general elementary vital phenomena likewise fall into three groups—metabolism, the mechanism of energy, and the assumption of form. Every cell, so long as it is living, takes in certain substances from its environment, submits them to chemical transformation in its interior, and gives out other substances. This *metabolism* is manifested in several special functions—in nutrition and digestion, respiration and circulation, secretion and excretion. The essence of the whole process is the fact that while out of these ingested stuffs living substance is always again being formed by the living substance which already exists, it is itself continually undergoing decomposition, and the products of this decomposition are what the cell gives off again to the outside. With metabolism, however, there is inseparably associated a *transformation of energy*. These substances taken in by the cell contain a large quantity of potential energy, which is transformed into kinetic energy. This has for its result the manifold activities of the organism, more especially motion, heat, electricity and light. Finally, the chemical transformations in living substance may also manifest themselves outwardly in *changes of form*, as is the case generally in the matter of growth, reproduction and development. The three general elementary groups of vital phenomena are therefore in reality merely the expression of the various aspects of one and the same process—of the actual vital process itself. The ultimate object of all physiology is to discover what this vital process is—that is to say, what is the exact cause of these manifold vital phenomena—a goal from which it is at the present day still very remote.

As every physical and chemical phenomenon of inorganic nature occurs only under distinct conditions, so vital phenomena are also dependent upon certain conditions of life.

Every living body, every living cell, requires food, water, oxygen, and, further, a certain temperature, and a certain pressure in its environment. These are the *general conditions of life*. But the *special conditions* on which depends the continued existence of the individual forms of organism are as numerous as the forms of organisms themselves. Now, just as the physicist or chemist varies those conditions under which a phenomenon occurs in order to get at its causes, so does the physiologist try to experiment with vital phenomena, altering the vital conditions; and testing the changes which are thereby produced. The great importance of this method consists in the power it gives the experimenter of analysing vital phenomena systematically from definite points of view. Every change in its normal vital conditions which produces any effect whatsoever upon an organism is termed a *stimulus*. This is the only general definition we have for a conception which is of such vast importance to physiology. According to it, experimental physiology is entirely a physiology of stimuli. It further follows from this conception of stimulation that there must be an enormous multiplicity of stimuli, since each particular vital condition may be subjected to some change capable of acting upon it as a stimulus. But, besides this, other factors may be brought to bear upon organisms which have absolutely no place among their vital conditions: for instance, many chemical reagents and electric currents. These influences come under the general definition of stimulus, because they likewise imply a change in the conditions under which the organism lives. From their qualitative nature stimuli are distinguished as chemical, thermal, photic, mechanical and electrical. Each of these several varieties may, however, be applied quantitatively in various degrees of intensity, and may in consequence produce quite different results. This opens up to experimental physiology a vast field of research. But the physiology of stimulation is not only of the greatest value as a *means* of research: its importance is much increased by the fact that in nature itself stimuli are everywhere and constantly acting upon the organism and its parts. Hence the investigation of their action comes to be not merely a *means*, but a direct *end* of research.

Although it is not at present possible to define all the laws that govern stimulation, on the one hand because the number of stimulating effects known to us in the whole organic world is as yet too limited, and on the other because those already known have not yet been thoroughly analysed, yet it is within our power to classify stimulating effects according to their various characteristics, and to ascertain a few facts concerning their general and fundamental conformity to law. The first fact, apparent from a glance at a great many of the various forms of stimulation, is that all their effects are manifested in either a *quantitative* or a *qualitative* alteration of the characteristic vital phenomena of each living object. The quantitative is the usual mode of action of stimuli. It is generally found that a stimulus either increases or diminishes the intensity of vital phenomena. In the first case the effect is one of excitation; in the second of depression. It is the more important to bear in mind this twofold operation of stimuli, owing to the fact that in former times physiologists were very apt to conceive of excitation and stimulation as identical. It is now, however, an undisputed fact that depression may also occur as a typical effect of stimulation. This is most apparent in cases where the same stimulus that produces excitation may on being applied for a longer period and with greater intensity, produce depression. Thus narcotics (alcohol, ether, chloroform, morphia, &c.) on certain forms of living substance produce the phenomena of excitation when their action is weak, whereas when it is stronger they produce complete depression. Thus, likewise, temperature stimuli act differently upon vital phenomena according to the degree of temperature: very low temperatures depressing,

medium temperatures exciting with increasing intensity, and higher temperatures from a certain height upwards again depressing. The effects of stimulation are not, however, always manifested in merely quantitative changes of the normal vital phenomena. Sometimes, especially in the case of long uninterrupted and chronic stimuli, stimulation is found gradually to produce phenomena which are apparently quite foreign to the normal vital phenomena of the cell in question. Such *qualitative* alterations of normal vital phenomena are perceptible chiefly in chronic maladies in the cells of different organs (the heart, liver, kidneys, spleen, &c.), in which the vital conditions become gradually more and more modified by the cause of the malady. To this category pertain all the so-called chronic processes of degeneration which in pathology are known as fatty degeneration, mucous degeneration, amyloid degeneration, and so forth. The characteristic element in all these processes is that the normal metabolism is diverted into a wrong channel by the altered vital conditions of the cells of the organ affected, so that substances are formed and accumulated in the cell which are entirely foreign to its normal life. But this class of stimulation is still very obscure as regards causes and inner processes, and it is within the range of possibility that the ultimate cause of the qualitative changes in the normal metabolism is to be found simply in the processes of excitation and depression which chronic stimulation produces in separate parts of the metabolism. Thus, at least with regard to fat-metamorphosis (fatty degeneration), it is highly probable that fat is deposited in the protoplasm simply because, owing to an inadequate supply of oxygen, it cannot, when it originates, be oxidized in the same proportion as it is formed, whereas in the normal cell all fat which originates in metabolism is consumed as soon as it is produced. According to this conception, therefore, fatty degeneration is attributable primarily to a depression of the processes of oxidation in the cell. If we may accept this view as correct with regard to the other metamorphic processes also, the qualitative changes in vital phenomena under the influence of stimuli would after all depend simply upon the excitation or depression of the constituent parts of the vital process, and, according to such a view, all stimuli would act primarily only as exciting or as depressing agents upon the normal process of life.

In accordance with the three groups into which general vital phenomena are divided, it follows as a matter of course that the excitation or depression produced by a stimulus can manifest itself in the cell's metabolism, assumption of form, and manifestation of energy. The effects of excitation upon the production of energy are the most striking, and were therefore in former times frequently thought to have a claim *par excellence* to rank as stimulating effects. These reactions attract most attention in cases where the production of energy is proportionately very great—as with muscle, for instance, which is made to twitch and perform work by a feeble stimulus. Processes of discharge (Ablösungsvorgänge), however, lie at the bottom of cases like these. Potential chemical energy, which is stored up in a considerable quantity in living substance, is converted by the impulse of the stimulus into kinetic energy. Therefore the amount of the effect of stimulation—that is to say, the quantity of work performed—bears no proportion whatever to the amount of energy acting as a stimulus upon the muscle. The amount of energy thus acting may be very small as contrasted with an enormous production of energy on the part of the living substance. It will not do to make generalizations, however, with regard to this proportion, as was frequently done in former times. All processes of stimulation are not processes of discharge. The influence of many stimuli, as has been observed, consists far more in depression than in excitation, so that in certain circumstances a stimulus actually diminishes the normal liberation of energy. There is therefore no general law as to the proportion which the amount of energy acting as a stimulus upon living substance bears to the amount of energy liberated.

Among special varieties of stimulation there is one class of stimuli which has attracted particular attention—namely, those which act unilaterally upon free-moving organisms. It is

principally with the lowest forms of life that we have here to do—unicellular protista and free-living cells in the bodies of higher organisms (sperm-cells, leucocytes, &c.). When from one direction a stimulus—be it chemical, thermal, photic, electrical, or of any other kind—acts upon these organisms in their medium, they are impelled to move in a course bearing a definite relation to the source of the stimulus—either directly towards that source or directly away from it, more rarely in a course transverse to it. This directive action of stimulation is under such a fixed conformity to law, that it vividly recalls such purely physical processes as, for instance, the attraction and repulsion of iron particles by the poles of a magnet. For example, if light falls from one side upon a vessel full of water containing unicellular green algae, according to the intensity of the light these organisms swim either towards the illuminated side, where they form a compact mass on the edge of the vessel, or away from it, to cluster on the opposite edge. In the same way infusoria in water are observed to hasten towards or to flee from certain chemical substances, and leucocytes in our bodies act in the same manner towards the metabolic products of poisoning bacteria which have penetrated into an open wound. The suppuration of wounds is always accompanied by an amazing conglomeration of leucocytes at the seat of the lesion. Perhaps the most striking effects are those of the constant electric current upon unicellular organisms, since in this case the motion follows the cause with absolutely automatic regularity, certainty and rapidity. Thus, for example, after the establishment of the current many Infusoria (Paramaecium) accumulate at the negative pole with great celerity and without deviation, and turn round again with equal celerity as soon as the direction of the current is altered. As such cases of directive stimulation may occur among all varieties of stimuli whenever stimuli act unilaterally, they have been designated, according to the direction in which they occur in relation to the source of the stimulus, as positive or negative chemotaxis, phototaxis, thermotaxis, galvanotaxis, and so forth. The strange and perplexing element in these phenomena becomes clear to us as soon as we know the characteristic method of locomotion for each form of organism, and whether the stimulus in question in the given intensity exercises an effect of excitation or of depression upon the special form. The direction of motion is the essential mechanical result of unilateral stimulation of the organs of locomotion. Seeing that these reactions are exceedingly widely distributed throughout the whole organic world, and possess a deep biological significance for the existence and continuance of life, the interest they have awakened is thoroughly justified.

One of the most important physiological discoveries of the 19th century was that of the "Specific Energy of Sense-substances." Johannes Müller was the first to establish the fact that very different varieties of stimuli applied to one and the same organ of sense always produce one and the same variety of sensation, and that, conversely, the same stimulus applied to the different organs of sense produces a different sensation in each organ—the one, in fact, which is its specific attribute. Thus, for example, mechanical, electrical and photic stimuli applied to the optic nerve produce no other sensation than that of light; and, conversely, any one variety of stimulus—take the electrical, for example—produces sensations of light, hearing, taste or smell, according as it affects the optic, auditory, gustatory or olfactory nerves. This law of the "Specific Energy of Sense-substances," as Johannes Müller (1809-1875) called it, has come to have a highly important bearing upon scientific criticism, since it proves experimentally that the things of the outer world are in themselves in no way discernible by us, but that from one and the same outward object—the electric current, or a mechanical pressure, for instance—we receive altogether different sensations and form altogether different conceptions according to the sense-organ affected. But this law does not possess significance for psychology alone: as regards physiology also it has a much more general and more comprehensive force than Müller ever anticipated. It holds good, as demonstrated by Ewald Hering (b. 1834) and others,

not of sense-substances only, but of living substance generally. Each cell has its specific energy in Johannes Müller's sense, and in its extended form there is no more general law for all the operations of stimuli than this law of specific energy. To take examples, whether a muscle be stimulated by a chemical, mechanical, thermal or electrical stimulus the result is in each case the same—namely, a twitching of the muscle. Let a salivary gland be stimulated chemically, mechanically, electrically or in any other way, there always follows the same specific action—a secretion of saliva; no matter what be the kind of stimulus acting upon it, the liver-cell always reacts by producing bile, and so on. On the other hand, one and the same stimulus—the electric current, for example—gives in each form of living substance a specific result: twitching in the muscle secretion of saliva in the salivary gland, production of bile in the liver-cell, &c. That is, of course, with the proviso that the effect of the stimulus be exciting and not depressing. The following general formulation, however, of the law of specific energy brings the depressing stimuli also within its scope: "Different stimuli produce in each form of living substance an increase or a diminution of its specific activity." As already observed, it will probably be found that those weak chronic forms of stimulation which produce qualitative changes may also be comprised under this general law.

The knowledge thus far acquired from analysis of vital phenomena and their changes under the influence of stimuli affords but a very indefinite temporary basis for the theory of the actual vital process itself, of which vital phenomena are the outward manifestation. The conceptions to which physiological research has hitherto attained in this matter are of a more or less doubtful nature. The facts contained in them still require to be linked together by hypotheses if we are to obtain even a vague outline of what lies hidden behind the great riddle of life. Such hypotheses, serving as they do to link facts consistently together, are absolutely essential, however, to the further progress of research, and without their aid any systematic investigation would be impracticable. But at the same time it must never be forgotten that these hypotheses are merely provisional, and that whenever they are found to be no longer in harmony with the widening range of new experiences and ideas they must either be proved to be facts or be subjected to modification. This is the point of view from which we must deal with modern ideas concerning the nature of the actual vital process—the mechanism of life.

The fundamental fact of life is the metabolism of living substance which is continually and spontaneously undergoing decomposition, and building itself up anew with the help of the food-substances it takes in. These processes of decomposition and of reconstruction may be briefly designated as *dissimilation* (catabolism) and *assimilation* (anabolism) respectively. Now the question arises: How are we to understand this process of dissimilation and assimilation from a mechanical standpoint? It is quite evident that we have to do with some chemical occurrence; but *how* are the chemical transformations brought about? There are obviously two possibilities. It is conceivable that the decomposition of food-stuffs and the formation of excretion-products in the cell-body are caused by the repeated casual encounter of a great series of chemical combinations and by their repeatedly reacting upon one another in the same manner, bringing about transformations and forming waste products which are excreted, while at the same time certain chemical affinities are always taking in from without new chemical combinations (food-stuffs) and uniting them. This theory was in fact occasionally advanced in former times, particularly in its chemical aspect, and the belief was especially entertained that the enzymes in living substance might play an important part in these transformations. This assumption, however, leads to no clear and lucid image of what takes place, and, moreover, draws too largely upon auxiliary hypotheses. It has therefore met with but little acceptance. The other possible explanation of metabolism is that its whole process is confined

to one single class of chemical combinations whose tendency it is to be constantly undergoing spontaneous decomposition and regeneration. This latter theory was founded by Ludimar Hermann (b. 1838), Eduard Friedrich Pflüger (b. 1826) and others, and has met with universal recognition because of its naturalness, simplicity and clearness.

Starting with this hypothesis, the path of further research lies clear and well defined before us. In the first place, we are obviously met by the question: What conception are *Proteids*, we to form of these combinations on which hinges the whole vital process? Among the organic matters which compose living substance, proteids perform the most important part. Proteids and proteid-compounds form the only organic matter which is never absent from any cell. They form also the greater part of all the organic compounds of the cell, unless reserve-stuffs are accumulated to a considerable extent, and they are by far the most complicated of the compounds of living substance. While animal life is impossible without proteid food, there are, on the other hand, animals which can continue to subsist on proteid alone. This series of facts proves very conclusively that proteids and their compounds play by far the most important part of all organic matter in the processes of life. The idea thus naturally presents itself that the required hypothetical compound forming the central point of metabolism will be found to bear a very close relation to proteids. But another point must be here considered. The proteids and their compounds known to us are, comparatively speaking, stable compounds, which never undergo spontaneous decomposition so long as they are protected from outward injury, whereas the hypothetical combination which lies at the centre of organic metabolism is extraordinarily liable and continually undergoing spontaneous decomposition. Therefore we have to think not of ordinary proteids in this case, but of still more complicated combinations, the atoms in the molecule of which have a strong tendency to group themselves in new arrangements. Owing to their fundamental importance, these combinations have been termed "biogens." When we come to inquire how such labile biogen molecules are built up out of the proteids of food, we find our knowledge very much restricted. Doubtless the intramolecular addition of inspired oxygen has much to do with it; for living substance when deprived of oxygen loses its irritability—that is to say, its tendency to decomposition. The fact that the decomposition of living substance is always associated with the formation of carbonic acid—a circumstance obviously necessitating the aid of oxygen—also points to the absolute indispensableness of oxygen in the matter. Pflüger has further suggested that the molecule of living substance owes its lability and its tendency to form carbonic acid when joined by oxygen atoms principally to cyanogen groups which are contained in it. According to this view, the following is supposed to be the process of the formation of biogen molecules: It is assumed that the biogen molecules already present in living substance take out of the proteids of food certain groups of atoms, and dispose them so as to produce cyanogen-like compounds. The addition of oxygen atoms then brings the biogen molecule to the maximum of its power of decomposition, so that—partly spontaneously, but more especially when impelled by a stimulus—it breaks down somewhat explosively, causing the formation of carbonic acid. In this proceeding, according to the hypothesis which is the most widely accepted and the most fruitful in results, would lie the very germ of the vital process.

If we accept these views as far as their general principle is concerned, assimilation is the re-formation of biogen molecules by those already existing, aided by food-stuffs; *Mechanism of Cell-life* dissimilation, the decomposition of biogen molecules. To this primary process, however, is attached a whole series of secondary chemical processes, which serve partly to work upon the food so as to fit it for the building up of biogen molecules, and partly to form out of the direct decomposition-products of the biogen molecules the characteristic secretion-products of living substance (excretions and secretions). The various workings of matter in the cell are rendered very much more

complex by the circumstance that the living cell exhibits various morphological differentiations—above all, the differentiation in protoplasm and nucleus. Again, a transformation of energy is inseparably connected with metabolism. Along with food and oxygen potential chemical energy is continually being introduced into the cell, to be accumulated in the biogen molecules, and at their decomposition transformed into kinetic energy, which finds an outlet in the various manifestations of energy in the cell—motion, heat, and so forth. In the light of this hypothesis the operations of stimuli also become comprehensible. Seeing that there is an initial tendency to the occurrence of certain definite chemical processes, which are associated with the reconstruction and decomposition of biogen molecules, various stimuli will either further or hinder the course of this metabolic series. A cell which is exposed to no outward disturbance, and which continues always in the unvarying medium provided by an exact sufficiency of food, will be in "metabolic equilibrium"—that is to say, its assimilation and its dissimulation will be equal ($A = D$). When, however, the influence of external stimuli is brought to bear upon them—that is to say, any change in their environing vital conditions— A and D will either be altered in similar proportion, or their mutual equilibrium will be disturbed. In the former case the vital processes will merely be intensified in their course; in the latter and usual case the result will be determined according to the part of metabolism excited or depressed. When the effect of a stimulus is to excite D continuously in a high degree without correspondingly increasing A , the result is a dying off—an atrophy. In the contrary case, when A remains continuously greater than D , the result is growth, increase and

reproduction of the cell. Experience proves, however, that A and D stand in a certain relation of mutual dependence to each other, with the result that when D has been increased by a stimulus, for example, A correspondingly increases during the stimulation, and continues to do so after its cessation, till the loss in living substance produced by the stimulation of D is eventually made good, and metabolic equilibrium is restored. The muscle may be taken as an example of this self-regulation of metabolism common to all living substance (Hering's *Selbststeuerung des Stoffwechsels*). When a muscle has been fatigued by some stimulation causing an enormous increase of D , there is a corresponding spontaneous increase in A . After some time the muscle is observed to have recovered. It has once more become capable of performing work; its metabolism is again in equilibrium.

The vital phenomena of the cell may be derived mechanically from metabolism and the changes it undergoes under the influence of stimuli. Our ability to do this will increase more rapidly as we become better acquainted with the details of the metabolism of the cell itself. The foregoing outline must be regarded, of course, as embodying only a fragmentary hypothesis, which can serve as a guide for further research only so long as it does not clash with facts, and which must be amplified, specialized and developed with the widening of specific knowledge regarding the cell's metabolism. The relations already known are so exceedingly complex that only by slow degrees can we pursue the investigation of separate fragments of the entire metabolic series. The differentiation of nucleus and protoplasm in the living substance of the cell alone gives rise to an extraordinary complication in the metabolic process, for these two parts of the cell stand in the most complicated correlation with one another as well as with the environing medium—a

fact of which the experiments made by vivisection in various free-living cell-forms have furnished abundant evidence. The farther such knowledge advances, the more rounded, clear and free from hypotheses will become our conception of the cell's metabolism. But the cell is the elementary component part of all organisms, and from the life of individual cells is constructed the life of the separate tissues and various organs, and thus of the entire organism. Hence the cell is the only vital element which the organism possesses, and therefore the investigation of the vital processes in its separate cells leads

ultimately to a knowledge regarding the mechanism of life in the whole.

Vegetable physiology is dealt with in the article **PLANTS: Physiology**. For details of different parts of the animal body, see **ANIMAL HEAT; RESPIRATORY SYSTEM; VASCULAR SYSTEM; TOUCH; SMELL; TASTE; VISION; HEARING; VOICE; MUSCLE AND NERVE; SLEEP; HYPNOTISM; BRAIN; SPINAL CORD; SYMPATHETIC SYSTEM; BLOOD; LYMPH; PHAGOCYTOSIS; DIGESTIVE ORGANS; NUTRITION, &c.**

The principal modern English textbooks of animal physiology are those of Sir Michael Foster (1885), A. E. Schäfer (1898), Noll Paton (1908), Halliburton (1909), and Starling (1909). See, however, the bibliographical notes to the separate articles. (M. V.)

PIACENZA (Lat. *Placentia*), a town and episcopal see of Emilia, Italy, the capital of the province of Piacenza, 42½ m. S.E. of Milan and 91 m. N.W. of Bologna by rail. Pop. (1906), 30,786. It lies on the Lombard plain, 217 ft. above sea-level, near the right bank of the Po, which here is crossed by road and railway bridges, just below the confluence of the Trebia. It is still surrounded by walls with bastions and fosse in a circuit of 4 m. The cathedral was erected between 1122 and 1233, in the Lombard Romanesque style, under the direction of Santo da Sambuceto, on the site of a church of the 9th century which had been destroyed by earthquake. The west front has three doors with curious pillared porches. The campanile is a massive square brick tower 223 ft. high; the iron cage attached to one of its windows was put up in 1495 by Ludovico il Moro for the confinement of persons guilty of treason or sacrilege. The crypt is a large church supported by one hundred columns. The entire edifice has been restored since 1898, and the frescoes by Guercino and Caracci, which decorate parts of its roof, though good in themselves, are inappropriate to its severe style. Sant'Antonio, which was the cathedral church till 877, is supposed to have been founded by St. Victor, the first bishop of Piacenza, in the 4th century, and restored in 903; it was rebuilt in 1104, and altered in 1857. It was within its walls that the deputies of the Lombard League swore to the conditions of peace ratified in 1183 at Constance. The Gothic brick vestibule (Il Paradiso) on the north side is one of the older parts of the building. San Francesco, a spacious Gothic edifice begun by the Franciscans in 1278, was erected on the site of the palace of Ubertino Landi, a leader of the Ghibelline party. S. Savino, a fine Romanesque building of A.D. 903 (well restored in 1903), contains a mosaic pavement of this period with curious representations, including one of a game of chess. S. Sisto, which dates from 1499, and takes the place of the church founded in 874 by Angilberga (consort of the emperor Louis II.), lost its chief attraction when Raphael's Sistine Madonna (now in Dresden) was sold by the monks in 1754 to Frederick Augustus III. Its place, however, is occupied by a copy by Avanzini, and there are also several good intarsias by Bartolomeo da Busseto. S. Sepolcro and S. Maria della Campagna are both good early Renaissance churches; the latter is rich in frescoes by Fordenone. S. Anna, dating from 1334, was the church of the barefooted Carmelites. Of the secular buildings the most interesting is the Palazzo Comunale, begun in 1281, one of the finest buildings of its kind in Italy. The square in front is known as the Piazza dei Cavalli, from the two bronze equestrian statues of Ranuccio (1620) and his father Alexander, prince of Parma, governor of the Netherlands (1625). Both were designed by Francesco Mocchi. The Palazzo dei Tribunali and the Palazzo degli Scotti are fine early Renaissance brick buildings with terra-cotta decorations. The huge Farnese palace was begun after Vignola's designs by Margaret of Austria in 1558, but it was never completed, and since 1800 it has been used as barracks. Other buildings or institutions of note are the old and the new bishop's palace, the fine theatre designed by Lotario Tomba in 1803, the great hospital dating from 1471, the library presented to the commune in 1846 by the marquis Ferdinando Landi, and the Passerini library founded in 1685. The Museo Civico, formed in 1903, contains collections of antiquities (though many of the Roman antiquities of Piacenza have passed to the museum of Parma), some good Flemish tapestries and a few pictures. The castle erected by Antonio da Sangallo the younger has been demolished. Piacenza is the junction of the Milan and Bologna line with that from Voghera and Turin. From Codogno, 7 m.

to the north, a branch line runs to Cremona. By road Piacenza is 88 m. north-east of Genoa. The town has an arsenal, a technical and arts school, and various industries—iron and brass works, foundries, silk-throwing, printing works and flour-mills.

Piacenza was made a Roman colony in 218 B.C. While its walls were yet unfinished it had to repulse an attack by the Gauls; and in the latter part of 218 it afforded protection to the remains of the Roman army under Scipio which had been defeated in the great battle on the Trebia. In 205 it withstood a protracted siege by Hasdrubal. Five years later the Gauls burned the city; and in 190 it had to be recruited with three thousand families. In 187 it was connected with Ariminum and the south by the construction of the Via Aemilia. Later on it became a very important road centre; the continuation northwards of the Via Aemilia towards Milan, with a branch to Ticinum, crossed the Po there, and the Via Postumia from Cremona to Dertona and Genoa passed through it. Later still Augustus reconstructed the road from Dertona to Vade, and into Gallia Narbonensis, and gave it the name of Julia Augusta from Placentia onwards. The rectangular arrangement of the streets in the centre of the town, through which passes the Via Aemilia, is no doubt a survival from Roman times. Placentia is mentioned in connexion with its capture by Cinna and a defeat of the forces of Carbo in the neighbourhood (82 B.C.), a mutiny of Julius Caesar's garrison (50 B.C.), another mutiny under Augustus (40 B.C.), the defence of the city by Spurrina, Otho's general, against Caecina, Vitellius's general (A.D. 69), and the defeat of Aurelianus by the Marcomanni outside the walls (A.D. 271). In 546 Totila reduced Piacenza by famine. Between 997 and 1035 the city was governed by its bishops, who had received the title of count from Otho III. At Roncaglia, 5 m. to the east, the emperor Conrad II. held the diet which passed the Salic law. In the latter part of the 12th century it was one of the leading members of the Lombard League. For the most part it remained Guelph, though at times, as when it called in Galeazzo Visconti, it was glad to appeal to a powerful Ghibelline for aid against its domestic tyrants. In 1447 the city was captured and sacked by Francesco Sforza. Having been occupied by the papal forces in 1512, it was in 1545 united with Parma (q.v.) to form an hereditary duchy for Pierluigi Farnese, son of Paul III. In 1746 a battle between the Franco-Spanish forces and the Austrians was fought under the city walls, and in 1796 it was occupied by the French. In 1848 Piacenza was the first of the towns of Lombardy to join Piedmont; but it was reoccupied by the Austrians till 1859.

PIANOFORTE (Ital. *piano*, soft, and *forte*, loud). The group of keyed stringed musical instruments, among which the pianoforte is latest in order of time, has been invented and step by step developed with the modern art of music, which is based upon the simultaneous employment of different musical sounds. In the 10th century the "organum" arose, an elementary system of accompaniment to the voice, consisting of fourths and octaves below the melody and moving with it; and the organ (q.v.), the earliest keyed instrument, was, in the first instance, the rude embodiment of this idea and convenient means for its expression. There was as yet no keyboard of balanced key levers; sliders were drawn out like modern draw-stops, to admit the compressed air necessary to make the pipes sound. About the same time arose a large stringed instrument, the organistrum,¹ the parent of the now obsolete hurdy-gurdy; as the organ needed a blower as well as an organist, so the player of the organistrum required a handle-turner, by whose aid the three strings of the instrument were made to sound simultaneously upon a wheel, and, according to the well-known sculptured relief of St George de Boscherville, one string was manipulated by means of a

¹ An organistrum is shown in the lower right hand corner of the full page miniature of a fine 12th century psalter of English workmanship, forming part of the Hunterian collection in University Court Library, Glasgow. No. 31 in *Catalogue of the Exhibition of Illuminated MSS. at the Burlington Fine Arts Club* (1906).

row of stoppers or tangents pressed inwards to produce the notes. The other strings were drones, analogous to the drones of the bagpipes, but originally the three strings followed the changing organum.

In the 11th century, the epoch of Guido d'Arezzo, to whom the beginning of musical notation is attributed, the Pythagorean monochord, with its shifting bridge, was used in the singing schools to teach the intervals of the plain-song of the church. The practical necessity, not merely of demonstrating the proportionate relations of the intervals, but also of initiating pupils into the different gradations of the church tones, had soon after Guido's time brought into use quadruplex-fashioned monochords, which were constructed with scales, analogous to the modern practice with thermometers which are made to show both Réaumur and Centigrade, so that four lines indicated as many authentic and as many plagal ^{Monochord;} ^{Clavichord;} tones. This arrangement found great acceptance, for Aribo,² writing about fifty years after Guido, says that few monochords were to be found without it. Had the clavichord then been known, this makeshift contrivance would not have been used. Aribo strenuously endeavoured to improve it, and "by the grace of God" invented a monochord measure which, on account of the rapidity of the leaps he could make with it, he named a wild-goat (*caprea*). Jean de Muris (*Musica speculative*, 1323) teaches how true relations may be found by a single-stringed monochord, but recommends a four-stringed one, properly a tetrachord, to gain a knowledge of unfamiliar intervals. He describes the musical instruments known in his time, but does not mention the clavichord or monochord with keys, which could not have been then invented. Perhaps one of the earliest forms of such an instrument, in which stoppers or tangents had been adopted from the organistrum, is shown in fig. 1, from a wood carving of a vicar choral or organist, preserved in St Mary's church, Shrewsbury. The latest date to which this interesting figure may be



attributed is 1460, but the conventional representation shows that the instrument was then already of a past fashion, although perhaps still retained in use and familiar to the carver.

In the Weimar *Wunderbuch*,³ a MS. dated 1440, with pen and ink miniatures, is given a "clavichordium" having 8 short and apparently 16 long keys, the artist has drawn 12 strings in a rectangular case, but no tangents are visible. A keyboard of balanced keys existed in the little portable organ known as the regal, so often represented in old carvings, paintings and stained windows. Vitruvius, *De architectura*, lib. x. cap. xi., translated by Newton, describes a balanced keyboard; but the key apparatus is more particularly shown in *The Pneumatics of Hero of Alexandria*, translated by Bennet Woodcroft (London, 1851). In confirmation of this has been the remarkable recovery at Carthage⁴ of a terra-cotta model of a Hydraulikon or water organ, dating from the 2nd century A.D., in which a balanced keyboard of 18 or 19 keys is shown. It seems likely the balanced keyboard was lost, and afterwards reinvented. The name of

² See "Musica aribonis scholastici," printed by Martin Gerbert in *Scriptores ecclesiastici de musica sacra* (1784), ii. 197; and in J. P. Migne, *Patrologiae cursus completus*, vol. 150, col. 1307.

³ *Grossherzogliche Bibliothek*. See also Dr Alwin Schulz, *Deutsches Leben im xiv. and xv. Jahrhundert*, (Vienna, 1892), p. 58, fig. 322.

⁴ For an illustration of this important piece of evidence, see under ORGAN: *Ancient History*; and for description and illustration of balanced keys, see KEYBOARD.

regal was derived from the rule (*regula*) or graduated scale of keys, and its use was to give the singers in religious processions the note or pitch. The only instrument of this kind known to exist in the United Kingdom is at Blair Atholl, and it bears the very late date of 1630. The Brussels regal¹ may be as modern. These are instances of how long a some-time admired musical instrument may remain in use after its first intention is forgotten. We attribute the adaptation of the narrow regal keyboard to what was still called the monochord, but was now a complex of monochords over one resonance board, to the latter half of the 14th century; it was accomplished by the substitution of tangents fixed in the future ends of the balanced keys for the movable bridges of the monochord or such stoppers as are shown in the Shrewsbury carving. Thus the monochordium or "payre of monochordis" became the clavicordium or "payre of clavicordis"—pair being applied, in the old sense of a "pair of steps," to a series of degrees. This use of the word to imply gradation was common in England to all keyed instruments; thus we read, in the Tudor period and later, of a pair of regals, organs, or virginals. Ed. van der Straeten² reproduces a so-called clavicord of the 15th century from a MS. in the public library at Ghent. The treatise is anonymous, but other treatises in the same MS. bear dates 1503 and 1504. Van der Straeten is of opinion that the drawing may be assigned to the middle of the 15th century. The scribe calls the instrument a clavicimbalum, and this is undoubtedly correct; the 8 strings in the drawing are stretched from back to front over a long sound-board, the longest strings to the left; 8 keys, 4 long and 4 short with levers to which are attached the jacks, are seen in a horizontal line behind the keyboard, and behind them again are given the names of the notes a, b, c, d, e, f, g, h. In the Weimar *Wunderbuch* is a pen-and-ink sketch of the "clavicimbalum"³ placed upon a table, in which we recognize the familiar outline of the harpsichord, but on a smaller scale. The keyboard shows white and black notes—the latter short keys, one between each group of two white keys, precisely as in the instrument reproduced by Van der Straeten—but no mechanism is visible under the strings.

The earliest known record of the clavicord occurs in some rules of the minnesingers,⁴ dated 1404, preserved at Vienna. The monochord is named with it, showing a differentiation of these instruments, and of them from the clavicymbalum, the keyed cymbal, cembalo (Italian), or psaltery. From this we learn that a keyboard had been thus early adapted to that favourite medieval stringed instrument, the "cembalo" of Boccaccio, the "sautrie" of Chaucer. There were two forms of the psaltery: (1) the trapeze, one of the oldest representations of which is to be found in Orcagna's famous *Trionfo della Morte* in the Campo Santo at Pisa, and another by the same painter in the National Gallery, London; and (2) the contemporary "testa di porco," the pig's head, which was of triangular shape as the name suggests. The trapeze psaltery was strung horizontally, the "istromento di porco" either horizontally or vertically—the notes, as in the common dulcimer, being in groups of three or four unisons. In these differences of form and stringing we see the cause of the ultimate differentiation of the spinet and harpsichord. The compass of the psalteries was nearly that of Guido's scale; but according to Mersenne,⁵ the lowest interval was a fourth, G to C, which is worthy of notice as anticipating the later "short measure"⁶ of the spinet and organ.

The simplicity of the clavicord inclines us to place it, in order of time, before the clavicymbalum or clavicembalo; but we do not know how the sounds of the latter were at first excited. There is an indication as to its early form to be seen in the church of the Certosa near Pavia, which compares in probable date with

the Shrewsbury example. We quote the reference to it from Dr Ambros.⁷ He says a carving represents King David as holding an "istromento di porco" which has eight strings and as many keys lying parallel to them; inside the body of the instrument, which is open at the side nearest the right hand of King David, he touches the keys with the right hand and damps the strings with the left. The attribution of archaism applies with equal force to this carving as to the Shrewsbury one, for when the monastery of Certosa near Pavia was built by Ambrogio Fossano in 1472, chromatic keyboards, which imply a considerable advance, were already in use. There is an authentic representation of a chromatic keyboard, painted not later than 1426, in the St Cecilia panel (now at Berlin) of the famous Adoration of the Lamb by the Van Eycks. The instrument depicted is a positive

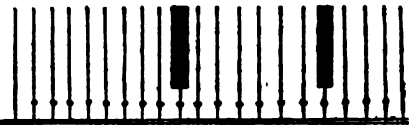

FIG. 2.—Diatonic Clavicord Keyboard (Guido's Scale) from Virdung. Before 1511.

organ, and it is interesting to notice in this realistic painting that the keys are evidently boxwood, as in the Italian spinets of later date, and that the angel plays a common chord—A with the right hand, F and C with the left. But diatonic organs with eight steps or keys in the octave, which included the B flat and the B natural, as in Guido's scale, were long preserved, for Praetorius speaks of them as still existing nearly two hundred years later. This diatonic keyboard, we learn from Sebastian Virdung (*Musica getuscht und aussengesogen*, Basel, 1511), was the keyboard of the early clavicord. We reproduce his diagram as the only authority we have for the disposition of the one short key.

The extent of this scale is exactly Guido's. Virdung's diagram of the chromatic is the same as our own familiar keyboard, and comprises three octaves and a note, from F below the bass staff to G above the treble. But Virdung tells us that even then clavicords were made longer than four octaves by repetition of the same order of keys. The introduction of the chromatic order he attributes to the study of Boetius, and the consequent endeavour to restore the three musical *genera* of the Greeks—the diatonic, chromatic and enharmonic. But the last-named had not been attained. Virdung gives woodcuts of the clavicordium, the virginal, the clavicymbalum and the clavictherium. We reproduce three of them (figs. 3, 6 and 12), omitting the virginal

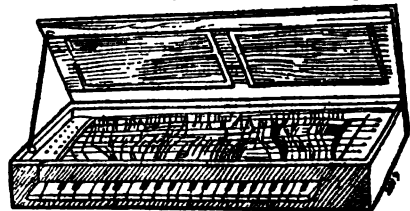

FIG. 3.—Virdung's Clavicordium, 1511; reversed facsimile.

as obviously incorrect. Writers on musical instruments have continually repeated these drawings without discerning that in the printing they are reversed, which puts the keyboards entirely wrong, and that in Luscinus's Latin translation of Virdung (*Musurgia, sive praxis musicae*, Strasburg, 1536), which has been hitherto chiefly followed, two of the engravings, the clavicymbalum and the clavictherium, are transposed, another cause of error. Martin Agricola (*Musica instrumentalis*, Wittenberg, 1529) has copied Virdung's illustrations with some differences of perspective, and the addition, here and there, of errors of his own.

¹ See Victor C. Mahillon, *Catalogue descriptif* (1880), I, p. 320, No. 454; regal with two bellows, end of XVI. C. Compass E to a².

² *La Musique aux Pays Bas*, i. 278.

³ See Dr Alwin Schulz, *op. cit.*, fig. 524.

⁴ V. 410 and 414. See Ambros, *Geschichte der Musik* (1892), ii. 226.

⁵ *L'Harmonie universelle* (Paris, 1636), livre III, p. 107.

⁶ A. J. Hipkins, *History of Pianoforte* (London, 1896), p. 51.

⁷ *Geschichte der Musik*, ii. 544-555.

Still vulgarly known as monochord, Virdung's clavichord was really a box of monochords, all the strings being of the same length. He derives the clavichord from Guido's monochord as he does the virginal from the psaltery, but, at the same time, confesses he does not know when, or by whom, either instrument was invented. We observe in this drawing the short sound-board, which always remained a peculiarity of the clavichord, and the straight sound-board bridge—necessarily so when all the strings were of one length. To gain an angle of incidence for the tangents against the strings the keys were made crooked, an expedient further rendered necessary by the "fretting"—three tangents, according to Virdung, being directed to stop as many notes from each single group of three strings tuned in unison; each tangent thus made a different vibrating length of string. In the drawing the strings are merely indicated. The German for fret is *Bund*, and such a clavichord, in that language, is known as a "gebundenes Clavichord" both fret (to rub) and *Bund* (from *binden*, to bind) having been taken over from the lute or viol. The French and Italians employ "touche" and "tasto," touch. Praetorius who wrote a hundred years later than Virdung, says two, three and four tangents were thus employed in stopping. There are extant small clavichords having three keys and tangents to one pair of strings and others have no more than two tangents to a note formed by a pair of strings, instead of three. Thus seven pairs of strings suffice for an octave of twelve keys, the open notes being F, G, A, B flat, C, D, E flat, and by an unexplained peculiarity, perhaps derived from some special estimation of the notes which was connected with the church modes, A and D are left throughout free from a second tangent. A corresponding value of these notes is shown by their independence of chromatic alteration in tuning the double Irish harp, as explained by Vincentio Galilei in his treatise on music (*Dialogo della musica*, Florence, 1581). Adlung, who died in 1762, speaks of another fretting, but it must have been an adaptation to the modern major scale, the "free" notes being E and B. Clavichords were made with double fretting up to about the year 1700—that is to say, to the epoch of J. S. Bach, who, taking advantage of its abolition and the consequent use of independent pairs of strings for each note, was enabled to tune in all keys equally, which had been impossible so long as the fretting was maintained. The modern scales having become established, Bach was now able to produce, in 1722, *Das wohltemperirte Clavier*, the first collection of preludes and fugues in all the twenty-four major and minor scales for a clavichord which was tuned, as to concordance and dissonance, fairly equal.

The oldest clavichord, here called manicordo (as French *manicorde*, from monochord), known to exist is that shown in fig. 4. It will be observed that the lowest octave is here already



FIG. 4.—Manicordo (Clavichord) d'Eleonora di Montalva, 1659; Kraus Museum, Florence.

"bundfrei" or fret-free. The strings are no longer of equal length, and there are three bridges, divisions of the one bridge, in different positions on the sound-board. Mersenne's "manicorde" (*Harmonie universelle*, Paris 1636, p. 115), shown in an engraving in that work, has the strings still nearly of equal length, but the sound-board bridge is divided into five. The fretted clavichords made in Germany in the last years of the 17th century have the curved sound-board bridge, like a spinet. In the clavichord the tangents always form the second

bridge, indispensable for the vibration, besides acting as the sound exciters (fig. 5). The common damper to all the strings

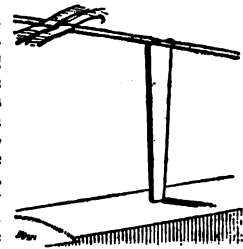

FIG. 5.—Clavichord Tangent.

is a list of cloth, interwoven behind the tangents. As the tangents quitted the strings the cloth immediately stopped all vibration. Too much cloth would diminish the tone of this already feeble instrument, which gained the name of "dumb spinet" from its use. In the clavichord in Rubens's St Cecilia (Dresden Gallery)—interesting as perhaps representing that painter's own instrument—the damping cloth is accurately painted. The number of keys there shown is three octaves and a third, F to A—the same extent as in Handel's clavichord now in the museum at Maidstone (an Italian instrument dated 1726, and not fretted), but with the peculiarity of a combined chromatic and short octave in the lowest notes, to which we shall have to refer when we arrive at the spinet; we pass it by as the only instance we have come across in the clavichord.

The clavichord must have gone out of favour in Great Britain and the Netherlands early in the 16th century, before its expressive power, which is of the most tender and intimate quality, could have been, from the nature of the music played, observed,—the more brilliant and elegant spinet being preferred to it. Like the other keyboard instruments it had no German name, and can hardly have been of German origin. Holbein, in his drawing of the family of Sir Thomas More, 1528, now at Basel, indicates the place for "Klavikordi und ander Seytynspill." But it remained longest in use in Germany—until even the beginning of the 19th century. It was the favourite "Klavier" of the Bachs. Besides that of Handel already noticed there are in existence clavichords the former possession of which is attributed to Mozart and Beethoven. The clavichord was obedient to a peculiarity of touch possible on no other keyboard instrument. This is described by C. P. Emmanuel Bach in his famous essay on playing and accompaniment, entitled *Versuch über die wahre Art das Klavier zu spielen* ("An Essay on the True Way to play Keyboard Instruments.") It is the *Bebung* (trembling), a vibration in a melody note of the same nature as the tremolo frequently employed by violin players to heighten the expressive effect; it was gained by a repeated movement of the fleshy end of the finger while the key was still held down. The *Bebung* was indicated in the notation by dots over the note to be affected by it, perhaps showing how many times the note should be repeated. According to the practice of the Bachs, as handed down to us in the above mentioned essay, great smoothness of touch was required to play the clavichord in tune. As with the monochord, the means taken to produce the sound disturbed the accuracy of the string measurement by increasing tension, so that a key touched too firmly in the clavichord, by unduly raising the string, sharpened the pitch, an error in playing deprecated by C. P. Emmanuel Bach. This answers the assertion which has been made that J. S. Bach could not have been nice about tuning when he played from preference on an instrument of uncertain intonation.

The next instrument described by Virdung is the virginal (*virginalis*, proper for a girl), a parallelogram in shape, having the same projecting keyboard and compass of keys the same as the clavichordium. Here we can trace derivation from the psaltery in the sound-board covering the entire inner surface of the instrument and in the triangular disposition of the strings. The virginal in Virdung's drawing has an impossible position with reference to the keyboard, which renders its reproduction as an illustration useless. But in the next drawing, the clavichordium, this is rectified, and the drawing, reversed on account of the keyboard, can be accepted as roughly representing the instrument so called (fig. 6). There would be

Clavichordium.

no difference between it and the virginal were it not for a peculiarity of keyboard compass, which emphatically refers itself to the Italian "spinetta," a name unnoticed by Virdung or by his countryman Arnold Schlick, who, in the same year 1511, published his *Spiegel der Orgelmacher* (Organ-builders' Mirror), and named the clavichordium and clavicimbalum as familiar instruments. In the first place, the keyboard, beginning apparently with B natural, instead of F, makes the clavicimbalum smaller than the virginal, the strings in this arrangement being shorter; in the next place it is almost certain that the Italian spinet compass, beginning apparently upon a semitone, is identical with a "short measure" or "short octave" organ compass, a very old keyboard arrangement, by which the lowest note, representing B, really sounded G and C sharp in like manner A. The origin of this may be deduced from the psaltery and many representations of the regal, and its object appears to have been to obtain dominant basses for cadences, harmonious closes having early been sought for as giving pleasure to the ear. Authority for this practice is to be found in Mersenne, who, in 1636, expressly describes it as occurring in his own spinet (*espinette*). He says the keyboards of the spinet and organ are the same. Now, in his Latin edition of the same work he renders

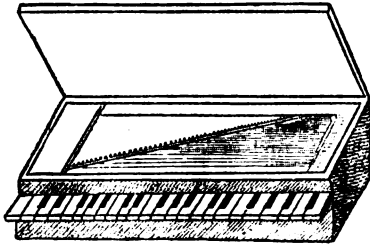

FIG. 6.—Virdung's Clavicimbalum (Spinet), 1511; reversed facsimile.

espinette by clavicimbalum. We read (*Harmonie Universelle*, Paris, 1636, liv. 3, p. 107—"Its longest string [his spinet's] is little more than a foot in length between the two bridges. It has only thirty-one keys [marches] in its keyboard, and as many strings over its sound-board [he now refers to the illustration], so that there are five keys hidden on account of the perspective—that is to say, three diatonic and two chromatic [scintles, same as the Latin *facti*], of which the first is cut into two [a divided sharp forming two keys]; but these sharps serve to go down to the third and fourth below the first step, C *sol* [tenor clef C], in order to go as far as the third octave, for the eighteen principal steps make but an eighteenth, that is to say, a fourth more than two octaves." The note we call F, he, on his engraving, letters as C, indicating the pitch of a spinet of the second size, which the one described is not. The third and fourth, reached by his divided sharp, are consequently the lower A and G; or, to complete, as he says, the third octave, the lowest note might be F, but for that he would want the diatonic semitone B, which his spinet, according to his description, did not possess.¹ Mersenne's statement sufficiently proves, first, the use in spinets as well as in organs of what we now call "short measure," and, secondly, the object of divided sharps at the lower end of the keyboard to gain lower notes. He speaks of one string only to each note; unlike the double and triple string clavichord, those instruments, clavicimbalum, spinet, or virginal, derived from the psaltery, could only present one string to the mechanical plectrum which twanged it. As regards the kind of plectra



FIG. 7.—Spinet Jack.

¹ A. J. Ellis (*History of Musical Pitch*, p. 318) sees the B in Mersenne's outline diagram.

earliest used we have no evidence. The little crow-quill points project from centred tongues in uprights of wood known as "jacks" (fig. 7), which also carry the dampers, and rising by the depression of the keys in front, the quills set the strings vibrating as they pluck them in passing, springs at first of steel, later of bristle, giving energy to the twang and governing their return. J. C. Scaliger in *Poetics libri septem* (1561, p. 51, c. 1.) states that the Clavicimbalum and Harpichordum of his boyhood are now called Spinets on account of those quill points (*ab illis mucronibus*), and attributes the introduction of the name "spinetta" to them (from *spina*, a thorn). We will leave harpichordum for the present, but the early identity of clavicimbalum and spinetta is certainly proved. Scaliger's etymology remained unquestioned until Signor Ponsicchi of Florence discovered another derivation. He found in a rare book entitled *Conclusioni nel suono dell'organo, di D. Adriano Banchieri* (Bologna, 1608), the following passage, which translated reads: "Spinetta was thus named from the inventor of that oblong form, who was one Maestro Giovanni Spinetti, a Venetian; and I have seen one of those instruments, in the possession of Francesco Stivori, organist of the magnificent community of Montagnana, within which was this inscription—*Joannes Spinets Venetus fecit, A.D. 1503.*" Scaliger's and Banchieri's statements may be combined, as there is no discrepancy of dates, or we may rely upon whichever seems to us to have the greater authority, always bearing in mind that neither invalidates the other. The introduction of crow-quill points, and adaptation to an oblong case of an instrument previously in a trapeze form, are synchronous; but we must accept 1503 as a late date for one of Spinetti's instruments, seeing that the altered form had already become common, as shown by Virdung, in another country as early as 1511. After this date there are frequent references to spinets in public records and other documents, and we have fortunately the instruments themselves to put in evidence, preserved in public museums and in private collections. A spinet dated 1490 was shown at Bologna in 1888; another old spinet in the Conservatoire, Paris, is a pentagonal instrument made by Francesco di Portalupis at Verona, 1523. The Milanese Rossi were famous spinet-makers, and have been accredited (*La Nobiltà di Milano*, 1595) with an improvement in the form which we believe was the recessing of the keyboard, a feature which had previously entirely projected; by the recessing a greater width was obtained for the sound-board. The spinets by Annibale Rosso at South Kensington, dated respectively 1555 (fig. 8) and 1577, show this

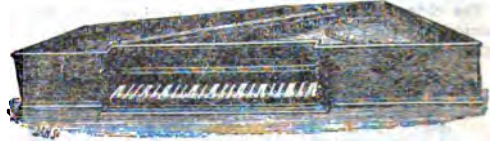

FIG. 8.—Milanese Spinetta, by Annibale Rosso, 1555; South Kensington Museum.

alteration, and may be compared with the older and purer form of one, dated 1568, by Marco Jadra (also known as Marco "dalle spinette," or "dai cembali"). Besides the pentagonal spinet, there was an heptagonal variety; they had neither covers nor stands, and were often withdrawn from decorated cases when required for performance. In other instances, as in the 1577 Rosso spinet, the case of the instrument itself was richly adorned. The apparent compass of the keyboard in Italy generally exceeded four octaves by a semitone, E to F; but we may regard the lowest natural key as usually C, and the lowest sharp key as usually D, in these instruments, according to "short measure."

The rectangular spinet, Virdung's "virginal," early assumed in Italy the fashion of the large "cassoni" or wedding chests. The oldest we know of in this style, and dated, is the fine specimen belonging to M. Terme which figures in *L'Art decoratif* (fig. 9). Virginal is not an Italian name;

the rectangular instrument in Italy is "spinetta tavola." In England, from Henry VII. to Charles II., all quilled instruments (*stromenti di penna*), without distinction as to form, were known as virginals. It was a common name, equivalent to the contemporary Italian *clavicordo* and Flemish *clavinsgel*. From the latter, by apocope, we arrive at the French *clavecin*—the French *clavier* (*clavis*, a key), a keyboard, being in its turn adopted by the Germans to denote any keyboard stringed instrument.



FIG. 9.—Spinetta Tavola (Virginal), 1568; Vict. and Albert Museum.

Mersenne (*op. cit.*, liv. iii., p. 158) gives three sizes for spinets—one $2\frac{1}{2}$ ft. wide, tuned to the octave of the "ton de chapelle" (in his day a half tone above the present English medium pitch), one of $3\frac{1}{2}$ ft. tuned to the fourth below, and one of 5 ft. tuned to the octave below the first, the last being therefore tuned in unison to the chapel pitch. He says his own spinet was one of the smallest it was customary to make, but from the lettering of the keys in his drawing it would have been of the second size, or the spinet tuned to the fourth. The octave spinet, of trapeze form, was known in Italy as "ottavina" or "spinetta di serenata." It had a less compass of keys than the larger instrument, being apparently three and two-third octaves, E to C— which by the "short measure" would be four octaves, C to C. We learn from Praetorius that these little spinets were placed upon the larger ones in performance; their use was to heighten the brilliant effect. In the double rectangular clavinsgel of the Netherlands, in which there was a movable octave instrument, we recognize a similar intention. There is a fine spinet of this



FIG. 10.—English Spinetta (Spinetta Traversa), by Carolus Haward. About 1668.

kind at Nuremberg. Praetorius illustrates the Italian spinet by a form known as the "spinetta traversa," an approach towards the long *clavicembalo* or *harpsichord*, the tuning pins being immediately over the keyboard. This transposed spinet, more powerful than the old trapeze one, became fashionable in England after the Restoration, Haward, Keene, Slade, Player, Baudin, the Hitchcocks, Mahoon, Haxby, the Harrir family, and others

having made such "spinets" during a period for which we have dates from 1664 to 1784. Pepys bought his "Espinette" from Charles Haward for £5, July 13, 1664.

The spinets of Keene and Player, made about 1700, have frequently two divided sharps at the bass end of the keyboard, as in the description by Mersenne, quoted above, of a spinet with short measure. Such divided sharps have been assumed to be quarter tones, but enharmonic intervals in the extreme bass can have no justification. From the tuning of Handel's Italian *clavicordo* already mentioned, which has this peculiarity, and from Praetorius we find the further halves of the two divided sharps were the chromatic semitones, and the nearer halves the major thirds below *i.e.* the dominant fourths to the next natural keys. Thomas Hitchcock (for whom there are dates 1664 and 1703 written on keys and jacks of spinets bearing Edward Blunt's name and having divided bass sharps) made a great advance in constructing spinets, giving them the wide compass of five octaves, from G to G, with very fine keyboards in which the sharps were inlaid with a slip of the ivory or ebony, as the case might be, of the naturals. Their instruments, always numbered, and not dated as has been sometimes supposed, became models for contemporary and subsequent English makers.

We have now to ask what was the difference between Scalgier's *harpsichordum* and his *clavicymbal*. Galilei, the father of the astronomer of that name (*Dialogo della musica antica e moderna*, Florence, 1581), says that the *harpsichord* was so named from having resembled an "arpa giacente," a prostrate or "couched" harp, proving that the *clavicymbal* was at first the trapeze-shaped spinet; and we should therefore ^{Harpsichord} ^{Clavicymbal} differentiate *harpsichord* and *clavicymbal* as, in form, suggested by or derived from the harp and psaltery, or from a "testa di porco" and an ordinary trapeze psaltery. We are inclined to prefer the latter. The Latin name "*clavicymbalum*," having early been replaced by *spinet* and *virginal*, was in Italy and France bestowed upon the long *harpsichord*, and was continued as *clavicembalo* (*gravecembalo*, or familiarly *cembalo* only) and *clavecin*. Much later, after the restoration of the Stuarts, the first name was accepted and naturalized in England as *harpsichord*, which we will define as the long instrument with quills, shaped like a modern grand piano, and resembling a wing, from which it has gained the German appellation "Flügel." We can point out no long instrument of this kind so old as the Roman *cembalo* at South Kensington (fig. 11). It was made by Geronimo of Bologna in 1521, two years before the Paris *Porta-lupis* spinet. The outer case is of finely tooled leather. It has a spinet keyboard with a compass of nearly four octaves, E to D. The natural keys are of boxwood, gracefully arched in front. The keyboard of the Italian *cembalo* was afterwards carried out to the normal four octaves. There is an existing example, dated 1626, with the bass keys carried out without sharps in long measure (unfortunately altered by a restorer). It is surprising to see with what steady persistence the Italians adhered to their original model in making the instrument. As late as the epoch of Cristofori,¹ and in his 1722 *cembalo* at Florence,² we still find the independent outer case, the single keyboard, the two unisons, without power to reduce to one by using stops. The Italians have been as conservative with their forms of spinet, and are to this day with their organs. The startling "piano e forte" of 1598, brought to light from the records of the house of D'Este by Count Valdrighi of Modena,³ after much consideration and a desire to find in it an anticipation of Cristofori's subsequent invention of the pianoforte, we are disposed to regard as an ordinary *cembalo* with power to shift, by a stop,

¹ In the *harpsichord* Cristofori made for Prince Ferdinand del Medici in 1702, recently acquired by Mr Stearns, of Detroit, and presented by him to the University of Michigan, U.S.A., there are three keyboards, thus arranged: 1st, highest keyboard, octave string only; 2nd, middle, octave and first unison; 3rd, lowest, both unisons. A *harpsichord* similarly designed with three keyboards, inscribed "Vincentius Sodi Florentinus Fecit, Anno Domini 1779," was presented by Mrs J. Crosby Brown to the Metropolitan Museum, New York.

² In the Kraus Museum Catalogue (1901), No. 559.

³ See Van der Straeten, vi. 122.

from two unisons (forte) to one string (piano), at that time a Flemish practice, and most likely brought to Italy by one of the Flemish musicians who founded the Italian school of composition. About the year 1600, when accompaniment was invented for monody, large cembali were made for the orchestras to bring out the bass part, the performer standing to play. Such an

"Two fair pair of new long Virginals made harp-fashion of Cipres, with keys of ivory, having the King's Arms crowned and supported by his Grace's beastes within a garter gilt, standing over the keys."

We are disposed to believe that we have here another double keyboard harpsichord. Rimbault saw in this an upright instrument, such as Virdung's clavicitherium (fig. 12). Having since seen the one in the Kraus Museum, Florence, it seems that Virdung's drawing should not have been reversed; but he has mistaken the wires acting upon the jacks for strings, and omitted the latter stretched horizontally across the soundboard (see CLAVICYTHERIUM). We read in an inventory of the furniture of Warwick Castle, 1584, "a faire paire of double virginals," and in the Hengrave inventory, 1603, "one great payre of double virginals." Hans Ruckers, the great clavisingsel maker of Antwerp, lived too late to have invented the double keyboard and stops, evident adaptations from the organ, and the octave string (the invention of which was so long attributed to him), which incorporated the octave spinet with the large instrument, to be henceforth playable without the co-operation of another performer, was already in use when he began his work. Until the last harpsichord was made by Joseph Kirkman, in 1798, scarcely an instrument of the kind was constructed, except in Italy, without the

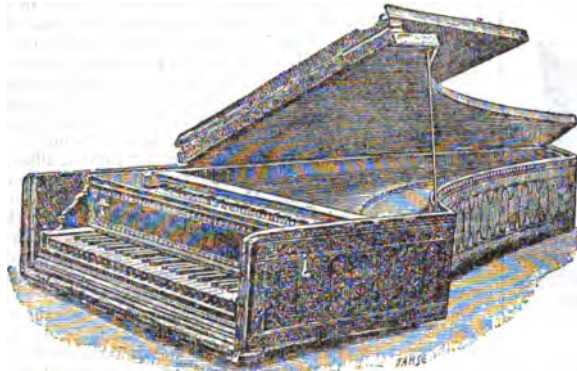

FIG. 11.—Roman Clavicembalo by Geronimo of Bologna, 1521; Vict. and Albert Museum.

instrument was called "archicembalo," a name also applied to a large cembalo, made by Vito Trasuntino, a Venetian, in 1606, intended by thirty-one keys in each of its four octaves—one hundred and twenty-five in all—to restore the three genera of the ancient Greeks. How many attempts have been made before and since Trasuntino to purify intonation in keyboard instruments by multiplying keys in the octave? Simultaneously with Father Smith's well-known experiment in the Temple organ, London, there were divided keys in an Italian harpsichord to gain a separate G sharp and A flat, and a separate D sharp and E flat.

Double keyboards and stops in the long cembalo or harpsichord came into use in the Netherlands early in the 16th century. We find them imported into England. The following citations, quoted by Rimbault in his *History of the Pianoforte*, but imperfectly understood by him, are from the privy purse expenses of King Henry VIII., as extracted by Sir Harris Nicolas in 1827.



FIG. 12.—Virdung's Clavicitherium (upright Harpsichord), 1511; (reversed facsimile).

"1530 (April). Item the vij daye pai'd to William Lewes for ii payer of virginals in one coffer with iiij stoppes brought to Grenewiche iii li. And for ii payer of virginals in one coffer brought to the More other iii li."

Now the second instrument may be explained, virginals meaning any quilled instrument, as a double spinet, like that at Nuremberg by Martin van der Beest, the octave division being movable. But the first cannot be so explained; the four stops can only belong to a harpsichord, and the two pair instrument to a double-keyed one, one keyboard being over, and not by the side of the other. Again from the inventory after the king's death (see Brit. Mus. Harl. MS. 1410) fol. 247—

octaves. The harpsichord as known throughout the 18th century, with piano upper and forte lower keyboard, was the invention of Hans Ruckers's grandson, Jean Ruckers's nephew, Jan Couchet, about 1640. Before that time the double keyboards in Flemish harpsichords were merely a transposing expedient, to change the pitch a fourth, from plagal to authentic and vice versa, while using the same groups of keys. Fortunately there is a harpsichord existing with double keyboards unaltered, date 1638, belonging to Sir Bernard Samuelson, formerly in the possession of Mr Spence, of Florence, made by Jean Ruckers, the keyboards being in their original position. It was not so much invention as beauty of tone which made the Ruckers's harpsichords famous. The Ruckers harpsichords in the 18th century were fetching such prices as Bologna lutes did in the 17th or Cremona violins do now. There are still many specimens existing in Belgium, France and England. Handel had a Ruckers harpsichord, now in Buckingham Palace; it completes the number of sixty-three existing Ruckers instruments catalogued in Grove's *Dictionary of Music and Musicians*.

After the Antwerp make declined, London became pre-eminent for harpsichords—the representative makers being Jacob Kirckmann and Burckhard Tschudi, pupils of a Flemish master, one Tabel, who had settled in London, and whose business Kirckmann continued through marriage with Tabel's widow. Tschudi was of a noble Swiss family belonging to the canton of Glarus. According to the custom with foreign names obtaining at that time, by which Haendel became Handel, and Schmidt Smith, Kirckmann dropped his final *n* and Tschudi became Shudi, but he resumed the full spelling in the facies of the splendid harpsichords he made in 1766 for Frederick the Great, which are still preserved in the New Palace, Potsdam. By these great makers the harpsichord became a larger, heavier-strung and more powerful instrument, and fancy stops were added to vary the tone effects. To the three shifting registers of jacks of the octave and first and second unisons were added the "lute," the charm of which was due to the favouring of high harmonics by plucking the strings close to the bridge, and the "harp," a surding or muting effect produced by impeding the vibration of the strings by contact of small pieces of buff leather. Two pedals were also used, the left-hand one a combination of a unison and lute. This pedal, with the "machine" stop, reduced the upper keyboard to the lute register, the plectra of which acted upon the strings near the wrest-plank bridge

¹ Invented by Nicola Vicentino; see *L'Antica musica ridotta alla moderna pratica* (Rome, 1555).

only; the lower keyboard to the second unison. Releasing the machine stop and quitting the pedal restores the first unison on both keyboards and the octave on the lower. The right-hand pedal was to raise a hinged portion of the top or cover and thus gain some power of "swell" or crescendo, an invention of Roger Plenius,¹ to whom also the harp stop may be rightly attributed. This ingenious harpsichord maker had been stimulated to gain these effects by the nascent pianoforte which, as we shall find, he was the first to make in England. The first idea of pedals for the harpsichord to act as stops appears to have been John Hayward's (Phaward) as early as 1676, as we learn from Mace's *Musick's Monument*, p. 235. The French makers preferred a kind of knee-pedal arrangement, known as the "genouillère," and sometimes a more complete muting by one long strip of buff leather, the "sourdine." As an improvement upon Plenius's clumsy swell, Shudi in 1769 patented the Venetian swell, a framing of louvres, like a Venetian blind, which opened by the movement of the pedal, and becoming in England a favourite addition to harpsichords, was early transferred to the organ, in which it replaced the rude "nag's-head" swell. A French harpsichord maker, Marius, whose name is remembered from a futile attempt to design a pianoforte action, invented a folding harpsichord, the "clavecin brisé," by which the instrument could be disposed of in a smaller space. One, which is preserved at Berlin, probably formed part of the camp baggage of Frederick the Great.

It was formerly a custom with kings, princes and nobles to keep large collections of musical instruments for actual playing purposes, in the domestic and festive music of their courts. There are records of their inventories, and it was to keep such a collection in playing order that Prince Ferdinand dei Medici engaged a Paduan harpsichord maker, Bartolommeo Cristofori, the man of genius who invented and produced the pianoforte.² We fortunately possess the record of this invention in a literary form from a well-known writer, the Marchese Scipione Maffei; his description appeared in the *Giornale dei letterati d'Italia*, a publication conducted by Apostolo Zeno. The date of Maffei's paper was 1711. Rimbault reproduced it, with a technically imperfect translation, in his *History of the Pianoforte*. We learn from it that in 1709 Cristofori had completed four "gravcembali col piano e forte"—keyed-psalteries with soft and loud—three of them being of the long or usual harpsichord form. A synonym in Italian for the original cembalo (or psaltery) is "salterio," and if it were struck with hammers it became a "salterio tedesco" (the German hackbrett, or chopping board), the latter being the common dulcimer. Now the first notion of a pianoforte is a dulcimer with keys, and we may perhaps not be wrong in supposing that there had been many attempts and failures to put a keyboard to a dulcimer or hammers to a harpsichord before Cristofori successfully solved the problem. The sketch of his action in Maffei's essay shows an incomplete stage in the invention, although the kernel of it—the principle of escapement or the controlled rebound of the hammer—is already there. He obtains it by a centred lever (*linguella mobile*) or hopper, working, when the key is depressed by the touch, in a small projection from the centred hammer-butt. The return, governed by a spring, must have been uncertain and incapable of further regulating than could be obtained by modifying the strength of the spring.

¹ Mace describes a primitive swell contrivance for an organ 65 years before Plenius took out his patent (1741).

² The invention of the piano by Cristofori, and him alone, is now past discussion. What is still required to satisfy curiosity would be the discovery of a Fort Bien or Frederici square piano, said to antedate by a year or two Zumpé's invention of the instrument in London. The name Fort Bien was derived, consciously or unconsciously, from the Saxon German peculiarity of interchanging B and P. Among Mozart's effects at the time of his death was a *Forle-Biano mit Pedal* (see *Verzehnter jährlicher Bericht des Mozarteum*, "Salzburg," Dec. 19, 1791). Also wanted is the "old movement" for the long or grand pianos, sometimes quoted in the Broadwood day-books of the last quarter of the 18th century with reference to the displacement by the Backers English action.

Moreover, the hammer had each time to be raised the entire distance of its fall. There are, however, two pianofortes by Cristofori, dated respectively 1720 and 1726, which show a much improved, we may even say a perfected, construction, for the whole of an essential piano movement is there. The earlier instrument (now in the Metropolitan Museum, New York) has undergone considerable restoration, the original hollow hammer-head having been replaced by a modern one, and the hammer-butt, instead of being centred by means of the holes provided by Cristofori himself for the purpose, having been lengthened by a leather hinge screwed to the block;³ but the 1726 one, which is in the Kraus Museum at Florence, retains the original leather hammer-heads. Both instruments possess alike a contrivance for determining the radius of the hopper, and both have been unexpectedly found to have the "check" (Ital. *paramartello*), which regulates the fall of the hammer according to the strength of the blow which has impelled it to the strings. After this discovery of the actual instruments of Cristofori there can be no longer doubt as to the attribution of the invention to him in its initiation and its practical completion with escapement and check. To Cristofori we are indebted, not only for the power of playing *piano* and *forte*, but for the infinite variations of tone, or *nuances*, which render the instrument so delightful.

But his problem was not solved by the devising of a working action; there was much more to be done to instal the pianoforte as a new musical instrument. The resonance, that most subtle

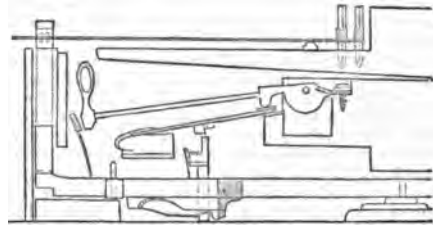

FIG. 13.—Cristofori's Escapement Action, 1720. Restored in 1875 by Cesare Fonacchi.

and yet all-embracing factor, had been experimentally developed to a certain perfection by many generations of spinet and harpsichord makers, but the resistance structure had to be thought out again. Thicker stringing, rendered indispensable to withstand even Cristofori's light hammers, demanded in its turn a stronger



FIG. 14.—Cristofori's Piano e Forte, 1726; Kraus Museum, Florence.

³ Communicated by Baron Alexander Kraus (May 1908).

equal distances (unlike the harpsichord), the dampers lying between the pairs of unisons.

Cristofori died in 1731. He had pupils,¹ but did not found a school of Italian pianoforte-making, perhaps from the peculiar Italian conservatism in musical instruments we have already remarked upon. The essay of Scipione Maffei was translated into German, in 1725, by König, the court poet at Dresden, and friend of Gottfried Silbermann, the renowned organ builder and harpsichord and clavichord maker.² Incited by this publication, and perhaps by having seen in Dresden one of Silbermann's pianofortes, Cristofori appears to have taken up the new instrument, and in 1726 to have manufactured two, which J. S. Bach, according to his pupil Agricola, pronounced failures. The trebles were too weak; the touch was too heavy. There has long been another version to this story, viz. that Silbermann borrowed the idea of his action from a very simple model contrived by a young musician named Schroeter, who had left it at the electoral court in 1721, and, quitting Saxony to travel, had not afterwards claimed it. It may be so; but Schroeter's letter, printed in Mitzler's *Bibliothek*, dated 1738, is not supported by any other evidence than the recent discovery of an altered German harpsichord, the hammer action of which, in its simplicity, may have been taken from Schroeter's diagram, and would sufficiently account for the condemnation of Silbermann's earliest pianofortes if he had made use of it. In either case it is easy to distinguish between the lines of Schroeter's interesting communications (to Mitzler, and later to Marpurg) the bitter disappointment he felt in being left out of the practical development of so important an instrument.

But, whatever Silbermann's first experiments were based upon, it was ascertained, by the investigations of A. J. Hipkins, that he, when successful, adopted Cristofori's pianoforte without further alteration than the compass and colour of the keys and the style of joinery of the case. In the Silbermann grand pianofortes, in the three palaces at Potsdam, known to have been Frederick the Great's, and to have been acquired by that monarch prior to J. S. Bach's visit to him in 1747, we find the Cristofori framing, stringing, inverted wrest-plank and action complete. Fig. 15 represents the instrument on which J. S. Bach played in the Town Palace, Potsdam.

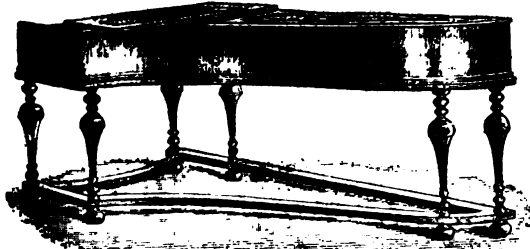

FIG. 15.—Silbermann Forte Piano; Stadtschloss, Potsdam, 1746.

It has been repeatedly stated in Germany that Frederici, of Gera in Saxony, an organ builder and musical instrument maker, invented the square or table-shaped piano, the "fort bien," as he is said to have called it, about 1758-1760. No square piano by this maker is forthcoming, though an "upright grand" piano, made by Domenico del Mela in 1739, with an action adapted from Cristofori's has been discovered by Signor Ponsicchi of Florence. Victor

¹ See Cesare Ponsicchi, *Il Pianoforte, sua origine e sviluppo* (Florence, 1876), p. 37.

² This translation, published at Hamburg and reproduced in *extenso*, may be read in Dr Oscar Paul's *Geschichte des Claviers* (Leipzig, 1868).

Mahillon of Brussels, however, acquired a Frederici "upright grand" piano, dated 1745 (fig. 16). In Frederici's upright grand action we have not to do with the ideas of either Cristofori or Schroeter; the movement is practically identical with the hammer action of a German clock, and has its counterpart in a piano at Nuremberg; a fact which needs further elucidation. We note here the earliest example of the leather hinge, afterwards so common in piano actions and only now going out of use. Where are we to look for Schroeter's copyist if not found in Silbermann, Frederici, or, as we shall presently see, perhaps J. G. Wagner? It might be in the harpsichord we have mentioned, which, made in 1712 by one Brock for the elector of Hanover (afterwards George I. of England), was by him presented to the Protestant pastor of Schulerberg, near Hanover, and has since been rudely altered into a pianoforte (fig. 17). There is an altered harpsichord in the museum at Basel which appears to have been no more successful. But an attempted combination of harpsichord and pianoforte appears as a very early intention. The English poet Mason, the friend of Gray, bought such an instrument at Hamburg in 1755, with "the cleverest mechanism imaginable."

It was only under date of 1763 that Schroeter³ published for the first time a diagram of his pro-



FIG. 16.—Frederici's Upright Grand Piano Action, 1745. In the museum of the Brussels Conservatoire.

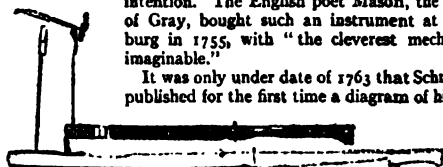

FIG. 17.—Hammer and Lifter of altered Harpsichord by Brock. Instrument in the collection of Mr Kendrick Pyne, Manchester.

posed invention, designed more than forty years before. It appeared in Marpurg's *Kritische Briefe* (Berlin, 1764). Now, immediately after, Johann Zumppe, a German in London, who had been one of Shudi's workmen, invented or introduced (for there is some tradition that Mason had to do with the invention of it)⁴ a square piano, which was to become the most popular domestic instrument. It would seem that Zumppe was in fact not the inventor of the square piano, which appears to have been well known in Germany before his date, a discovery made by Mr George Reese. In Paul de Wit's Musical Instrument Museum—formerly in Leipzig, now transferred to Cologne—there is a small square piano, 27 in. long, 10 in. wide and 4½ in. high, having a contracted keyboard of 3 octaves and 2 notes. The action of this small instrument is practically identical in every detail with that of the square pianofortes made much later by Zumppe (Paul de Wit, *Katalog des musikhistorischen Museums, Leipzig, 1903*, No. 55, illustration, p. 38). Inside is inscribed: "Friedrich Hildebrandt, Instrumentenmacher in Leipzig, Quergasse," with four figures

³ For arguments in favour of Schroeter's claim to the invention of the pianoforte see Dr Oscar Paul, *op. cit.*, pp. 85-104, who was answered by A. J. Hipkins in Grove's *Dict. of Music and Musicians*.

⁴ Mason really invented the "celestina" (known as Adam Walker's patent No. 1020), as we know from the correspondence of Mary Granville. Under date of the 11th of January 1775 she describes this invention as a short harpsichord 2 ft. long, but played with the right hand only. The left hand controlled a kind of viabow, which produced a charming *softissimo*, in character of tone between the violin tone and that of musical glasses.

almost fileable. Paul de Wit refers the instrument to the middle of the 18th century. It has all the appearance of being a reduced copy of a well-established type, differing very little from the later models, except that it has no dampers. It seems probable that this small instrument is a converted clavichord, and that the action may have been suggested by Schroeter's model, left in 1721 at the Electoral Court of Saxony. Burney tells us all about Zumpe; and his instruments still existing would fix the date of the first at about 1765. Fets narrates, however, that he began the study of the piano on a square piano made by Zumpe in 1762. In his simple "old man's head" action we have the nearest approach to a realization of Schroeter's simple idea. It will be observed that Schroeter's damper would stop all vibration at once. This defect is overcome by Zumpe's "mopstick" damper.

Another piano action had, however, come into use about that time or even earlier in Germany. The discovery of it in the simplest form is to be attributed to V. C. Mahillon, who found it in a square piano belonging to Henri Gosselin, painter, of Brussels. The principle of this action is that which was later perfected by the addition of a good escapement by Stein of Augsburg, and was again later experimented

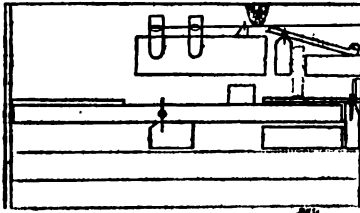

FIG. 18.—Schroeter's Model for an Action, 1721.

upon by Sebastian Erard. Its origin is perhaps due to the contrivance of a piano action that should suit the shallow clavichord and permit of its transformation into a square piano; a transformation, Schroeter tells us, had been going on when he

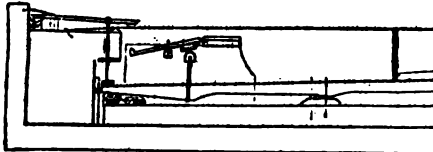

FIG. 19.—Zumpe's Square Piano Action, 1766.

wrote his complaint. It will be observed that the hammer is, as compared with other actions, reversed, and the axis rises with the key, necessitating a fixed means for raising the hammer, in this action effected by a rail against which the hammer



FIG. 20.—Old Piano Action on the German principle of Escapement. Square Piano belonging to M. Gosselin, Brussels.

is jerked up. It was Stein's merit to graft the hopper principle upon this simple action; and Mozart's approbation of the invention, when he met with it at Augsburg in 1777, is expressed in a well-known letter addressed to his mother. No more "blocking" of the hammer, destroying all vibration, was henceforth to vex his mind. He had found the instrument that for the rest of his short life replaced the harpsichord. V. C. Mahillon secured for his museum the only Johann Andreas Stein piano which

is known to remain. It is from Augsburg, dated 1780, and has Stein's escapement action, two unisons, and the knee pedal, then and later common in Germany.

Mozart's own grand piano, preserved at Salzburg, and the two grand pianos (the latest dated 1790) by Huhn of Berlin, preserved at Berlin and Charlottenburg, because they had

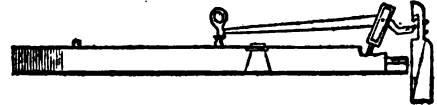

FIG. 21.—Stein's Action (the earliest so-called Viennese), 1780. belonged to Queen Luise of Prussia, follow Stein in all particulars. These instruments have three unisons upwards, and the muting movement known as *celeste*, which no doubt Stein had also. The wrest-plank is not inverted; nor is there any imitation of Cristofori. We may regard Stein, coming after the Seven Years' War which had devastated Saxony, as the German reinventor of the grand piano. Stein's instrument was accepted as a model, as we have seen, in Berlin as well as Vienna, to which city his business was transferred in 1794 by his daughter Nanette, known as an accomplished pianist and friend of Beethoven, who at that time used Stein's pianos. She had her brother in the business with her, and had already, in 1793, married J. A. Streicher, a pianist from Stuttgart, and distinguished as a personal friend of Schiller. In 1802, the brother and sister dissolving partnership, Streicher began himself to take his full share of the work, and on Stein's lines improved the Viennese instrument, so popular for many years and famous for its lightness of touch, which contributed to the special character of the Viennese school of pianoforte playing. Since 1862, when Steinway's example caused a complete revolution in German and Austrian piano-making, the old wooden cheap grand piano has died out. We will quit the early German piano with an illustration (fig. 22) of an early square piano

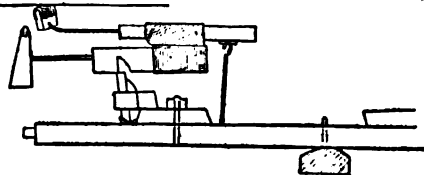

FIG. 22.—German Square Action, 1783. Piano by Wagner, Dresden.

action in an instrument made by Johann Gottlob Wagner of Dresden in 1783. This interesting discovery of Mahillon's introduces us to a rude imitation (in the principle) of Cristofori, and it appears to have no relation whatever to the clock-hammer motion seen in Frederici's.

Burney, who lived through the period of the displacement of the harpsichord by the pianoforte, is the only authority to whom we can refer as to the introduction of the latter instrument into England. He tells us,¹ in his gossiping way, *The Pianoforte in England*, that the first hammer harpsichord that came to England was made by an English monk at Rome, a Father Wood, for an English gentleman, Samuel Crisp of Chesington; the tone of this instrument was superior to that produced by quills, with the added power of the shades of *piano* and *forte*, so that, although the touch and mechanism were so imperfect that nothing quick could be executed upon it, yet in a slow movement like the "Dead March" in *Sauil* it excited wonder and delight. Fulke Greville afterwards bought this instrument for 100 guineas, and it remained unique in England for several years, until Plenius, the inventor of the lyrichord, made a pianoforte in imitation of it. In this instrument the touch was better, but the tone was inferior. We have no date for Father Wood. Plenius produced his lyrichord, a *sostenente*

¹ Rees's *New Cyclopaedia*, art. "Harpsichord."

harpsichord, in 1745. When Mason imported a pianoforte in 1755, Fulke Greville's could have been no longer unique. The Italian origin of Father Wood's piano points to a copy of Cristofori, but the description of its capabilities in no way confirms this supposition, unless we adopt the very possible theory that the instrument had arrived out of order and there was on one in London who could put it right, or would perhaps divine that it was wrong. Burney further tells us that the arrival in London of J. C. Bach in 1759 was the motive for several of the second-rate harpsichord makers trying to make pianofortes, but with no particular success. Of these Americus Backers (d. 1776), Backers, said to be a Dutchman, appears to have gained the first place. He was afterwards the inventor of the so-called English action, and as this action is based upon Cristofori's we may suppose he at first followed Silbermann in

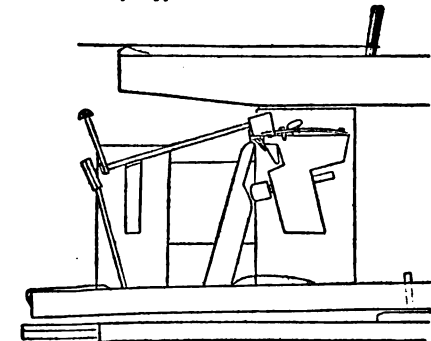

FIG. 23.—Grand Piano Action, 1776. The "English" action of Americus Backers.

copying the original inventor. There is an old play-bill of Covent Garden in Messrs Broadwood's possession dated the 16th of May 1767, which has the following announcement:—"End of Act 1. Miss Brickler will sing a favourite song from *Judith*, accompanied by Mr Dibdin on a new instrument call'd Piano Forte."

The mind at once reverts to Backers as the probable maker of this novelty. Backers's "Original Forte Piano" was played at the Thatched House in St James's Street, London, in 1773. Ponsicchi has found a Backers grand piano at Pistoria, dated that year. It was Backers who produced the action continued in the direct principle by the firm of Broadwood, or with the reversed lever and hammer-but introduced by the firm of Collard in 1835.

The escapement lever is suggested by Cristofori's first action, to which Backers has added a contrivance for regulating it by means of a button and screw. The check is from Broadwood-Stodart. Cristofori's second action. No more durable action has been constructed, and it has always been found equal, whether made in England or abroad, to the demands of the

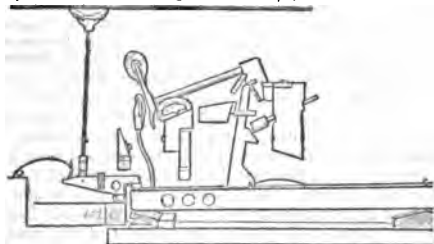

FIG. 24.—Broadwood's Grand Piano Action, 1884. English direct mechanism.

most advanced virtuosi. John Broadwood and Robert Stodart were friends, Stodart having been Broadwood's pupil; and they

were the assistants of Backers in the installation of his invention. On his deathbed he commended it to Broadwood's care, but Stodart appears to have been the first to advance it—Broadwood being probably held back by his partnership with his brother-in-law, the son of Shudi, in the harpsichord business. (The elder Shudi had died in 1773.) Stodart soon made a considerable reputation with his "grand" pianofortes, a designation he was the first to give them. In Stodart's grand piano we first find an adaptation from the lyrichord of Plenius, of steel arches between the

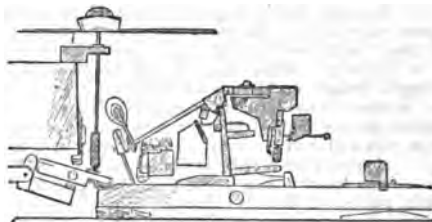

FIG. 25.—Collard's Grand Piano Action, 1884. English action, with reversed hopper and contrivance for repetition added.

wrest-plank and belly-rail, bridging the gap up which the hammers rise, in itself an important cause of weakness. These are not found in any contemporary German instruments, but may have been part of Backers's.

Imitation of the harpsichord by "octaving" was at this time an object with piano makers. Zumppe's small square piano had met with great success; he was soon enabled to retire, and his imitators, who were legion, continued his model with its hand stops for the dampers and sourdine, with little change but that which straightened the keys from the divergences inherited from the clavichord. John Broadwood took this domestic instrument first in hand to improve it, and in the year 1780 succeeded in entirely reconstructing it. He transferred the wrest-plank and pins from the right-hand side, as in the clavichord, to the back of the case, an improvement universally adopted after his patent, No. 1379 of 1783, expired. In this patent we first find the damper and piano pedals, since universally accepted, but at first in the grand pianofortes only. Zumppe's action remaining with an altered damper, another inventor, John Geib, patented (No. 1571 of 1786) the hopper with two separate escapements, one of which soon became adopted in the grasshopper of the square piano, it is believed by Geib himself; and Petzold, a Paris maker, appears to have taken later to the escapement effected upon the key. We may mention here that the square piano was developed and continued in England until about the year 1860, when it went out of fashion.

To return to John Broadwood—having launched his reconstructed square piano, he next turned his attention to the grand piano to continue the improvement of it from the point where Backers had left it. The grand piano was in framing and resonance entirely on the harpsichord principle, the sound-board bridge being still continued in one undivided length. The strings, which were of brass wire in the bass, descended in notes of three unisons to the lowest note of the scale. Tension was left to chance, and a reasonable striking line or place for the hammers was not thought of. Theory requires that the notes of octaves should be multiples in the ratio of 1 to 2, by which, taking the treble clef C at one foot, the lowest F of the five-octave scale would require a vibrating length between the bridges of 12 ft. As only half this length could be conveniently afforded, we see at once a reason for the above-mentioned deficiencies. Only the three octaves of the treble, which had lengths practically ideal, could be tolerably adjusted. Then the striking-line, which should be at an eighth or not less than a ninth or tenth of the vibrating length, and had never been cared for in the harpsichord, was in the lowest two octaves out of all proportion, with corresponding disadvantage to the tone. John Broadwood did not venture alone upon the path

but the instrument being poor in the tone failed to bring him pecuniary reward or the credit he deserved. Southwell appears to have been one of the first to profit by Hawkins's ideas by bringing out the high cabinet pianoforte, with hinged sticker action, in 1807. All that he could, however, patent in it was the simple damper action, turning on a pivot to relieve the dampers from the strings, which is still frequently used with such actions. The next steps for producing the lower or cottage upright piano were taken by Robert Wornum, who in 1811 produced a diagonally, and in 1813 a vertically, strung one. Wornum's perfected crank action (fig. 29) was not complete until 1826, when it was patented for a cabinet piano; but it was not really introduced until three years later, when Wornum applied it to his little "piccolo." The principle of this centred lever check action was introduced into Paris by Pleyel¹ and Pape, and thence into Germany and America.

It was not, however, from Hawkins's invention that iron became introduced as essential to the structure of a pianoforte. This was due to William Allen, a young Scotsman in the employ of the Stodarts. He devised a metal system of framing intended primarily for compensation, but soon to become, in other hands, a framing for resistance. His idea was to meet the divergence in tuning caused in brass and iron strings by atmospheric changes by compensating tubes and plates of the same metals, guaranteeing their stability by a cross batoning of stout wooden bars and a metal bar across the wrest-plank. Allen, being simply a tuner, had not the full practical knowledge for carrying out the idea. He had to ally himself with Stodart's foreman, Thom; and Allen and Thom patented the invention in January 1820. The firm of Stodart at once acquired the patent.

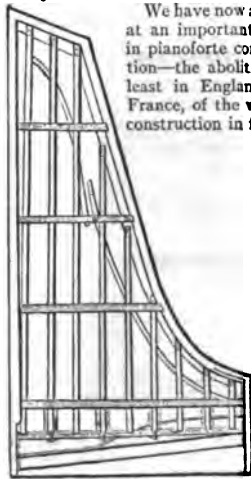

FIG. 30.—Allen's Compensating Grand Piano, 1820. The first complete metal framing system applied over the strings.

Hervé, which was in the first instance applied to one of the square pianos of that firm. The great advantage in the fixed plate was a more even solid counterpoise to the drawing or tension of the strings and the abolition of their undue length

¹ Pleyel exhibited a small upright piano in Paris in 1827. Pierre Erard did not turn his attention to upright pianos until 1831.



FIG. 29.—Wornum's Upright Action, 1826. The original of the now universal crank action in upright pianos.

We have now arrived at an important epoch in pianoforte construction—the abolition, at least in England and France, of the wooden construction in favour of a combined construction of iron and wood, the former material gradually asserting pre-eminence. Allen's design is shown in fig. 30. The long bars shown in the diagram are really tubes fixed at one end only; those of iron lie over the iron or steel wire, while those of brass lie over the brass wire, the metal plates to which they are attached being in the same correspondence. At once a great advance was made in the possibility of using heavier strings than could be stretched before, without danger to the durability of the case and frame. The next step was in 1821, to a fixed iron string-plate, the invention of one of Broadwood's workmen, Samuel

behind the bridge, a reduction which Isaac Carter² had tried some years before, but unsuccessfully, to accomplish with a plate of wood. So generally was attention now given to improved methods of resistance that it has not been found possible to determine who first practically introduced those long iron or steel resistance bars which are so familiar a feature in modern grand pianos. They were experimented on as substitutes for the wooden bracing by Joseph Smith in 1798; but to James Broadwood belongs the credit of trying them first above the sound-board in the treble part of the scale as long ago as 1808, and again in 1818; he did not succeed, however, in fixing them properly. The introduction of fixed resistance bars is really due to observation of Allen's compensating tubes, which were, at the same time, resisting. Sebastian and Pierre Erard seem to have been first in the field in 1823 with a complete system of nine resistance bars from treble to bass, with a simple mode of fastening them through the sound-board to the wooden beams beneath, but, although these bars appear in their patent of 1824, which chiefly concerned their repetition action, the Erards did not either in France or England claim them as of original invention, nor is there any string-plate combined with them in their patent. James Broadwood, by his patent of 1827, claimed the combination of string-plate and resistance bars, which was clearly the completion of the wood and metal instrument, differing from Allen's in the nature of the resistance being fixed. Broadwood, however, left the brass bars out, but added a fourth bar in the middle to the three in the treble he had previously used. It must be borne in mind that it was the trebles that gave way in the old wooden construction before the tenor and bass of the instrument. But the weight of the stringing was always increasing, and a heavy close overspinning of the bass strings had become general. The resistance bars were increased to five, six, seven, eight and, as we have seen, even nine, according to the ideas of the different English and French makers who used them in their pursuit of stability.

The next important addition to the grand piano in order of time was the harmonic bar of Pierre Erard, introduced in 1838. This was a gun-metal bar of alternate pressing and drawing power by means of screws which were tapped into the wrest-

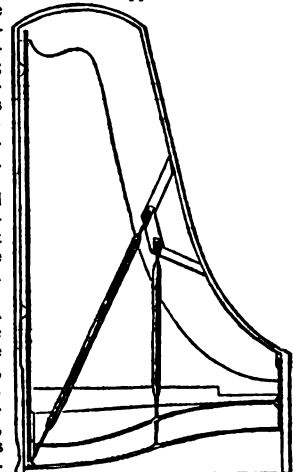

FIG. 31.—Broadwood's Iron Grand Piano, 1884. Complete iron frame with diagonal resistance bar.

invention was introduced in 1827. Between 1847 and 1849 ² Sometime foreman to the pianoforte maker Mott, who attracted much attention by a piano with *sostenente* effect, produced by a roller and silk attachments in 1817. But a *sostenente* piano, however perfect, is no longer a true piano such as Beethoven and Chopin wrote for.

Mr Henry Fowler Broadwood, son of James, and grandson of John Broadwood, and also great-grandson of Shudi (Tschudi), invented a grand pianoforte to depend practically upon iron, in which, to avoid the conspicuous inequalities caused by the breaking of the scale with resistance bars, there should be no bar parallel to the strings except a bass bar, while another flanged resistance bar, as an entirely novel feature, crossed over the strings from the bass corner of the wrest-plank to a point upon the string-plate where the greatest accumulation of tension strain was found. Broadwood did not continue, without some compromise, this extreme renunciation of ordinary resistance means. After the Great Exhibition of 1851 he employed an ordinary straight bar in the middle of his concert grand scale, his smaller grands having frequently two such as well as the long bass bar. After 1862 he covered his wrest-plank with a thick plate of iron into which the tuning pins screw as well as into the wood beneath, thus avoiding the crushing of the wood by the constant pressure of the pin across the pull of the string, an ultimate source of danger to durability.

The introduction of iron into pianoforte structure was differently and independently effected in America, the fundamental idea there being to use a single casting for the metal plate and bars, instead of forging or casting them in separate pieces.

Alphæus Babcock was the pioneer in this kind of metal construction. He also was bitten with the compensation notion, and had cast an iron ring for a square piano in 1825, which, although not a success, gave the clue to a single casting resistance framing, successfully accomplished by Conrad Meyer, in Philadelphia, in 1833, in a square piano which still exists, and was shown in the Paris Exhibition of 1878. Meyer's idea was improved upon by Jonas Chickering (1797-1853) of Boston, who applied it to the grand piano as well as to the square, and brought the principle up to a high degree of perfection—establishing by it the independent construction of the American pianoforte.

We have now to do with over- or cross-stringing, by which the bass division of the strings is made to cross *Over-stringing*, over the tenor part of the scale in a single, double or treble disposition at diverging angles—the object being in the first instance to get longer bass strings than are attainable in a parallel scale, and in the next to open out the scale and extend the area of bridge pressure on the sound-board. In the 18th century clavichords were sometimes overstrung in the lowest octave to get a clearer tone in that very indistinct

FIG. 32.—Meyer's Metal Frame for a Square Piano, 1833. In a single casting.

part of the instrument (strings tuned an octave higher being employed). The first suggestion for the overstringing in the piano was made by the celebrated lute-player and inventor Theobald Boehm, who carried it beyond theory in London, in 1831, by employing a small firm located in Cheapside, Gerock & Wolf, to make some overstrung pianos for him. Boehm expected to gain in tone; Pape, an ingenious mechanic in Paris, tried a like experiment to gain economy in dimensions, his notion being to supply the best piano possible with the least outlay of means. Tomkinson in London continued Pape's model, but neither Boehm's nor Pape's took permanent root. The Great Exhibition of 1851 contained a grand piano, made by Lichtenthal of St Petersburg, overstrung in order to gain symmetry by two angle sides to the case. This was regarded as a curiosity only. Later, in 1855, Henry Engelhard Steinway (originally Steinweg; *Steinway*, 1797-1871), who had emigrated from Brunswick to New York in 1849, and had established the firm of Steinway & Sons in 1853 in that city, effected the combination

of an overstrung scale with the American iron frame, which exhibited in grand and square instruments shown in London in the International Exhibition of 1862, excited the attention of European pianoforte makers, leading ultimately to important results. The Chickering firm claim to have anticipated the Steinways in this invention. They assert that Jonas Chickering had begun a square piano on this combined system in 1853, but, he died before it was completed, and it was brought out later. It is often difficult to adjudicate upon the claims of inventors, so rarely is an invention the product of one man's mind alone. However, the principle was taken up and generally adopted in America and Germany, and found followers elsewhere, not only in grand but in upright pianos, to the manufacture of which it gave, and particularly in Germany, a powerful impetus.

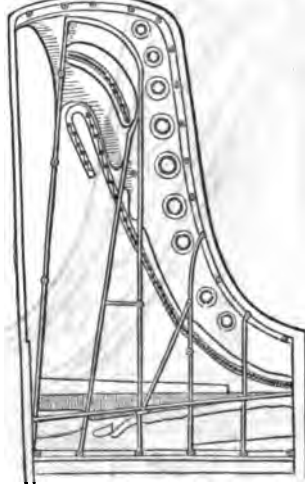

FIG. 33.—Steinway's Grand Piano, 1884. Metal framing in a single casting and overstrung.

Since 1885 the American system of a metal plate in one casting, and cross- or over-stringing by which the spun bass strings cross the longer steel diagonally, has become general. *Recent Structural Changes* in Europe with the exception of France, where musical taste has remained constant to the older wooden structure and parallel stringing throughout. The greater tenacity of the modern cast-steel wire favours a very much higher tension, and consequent easier production of the higher partials of the notes, permitting a *sostenuto* unknown to Beethoven, Schumann or Chopin. While in 1862 the highest tension of a concert grand piano worked out at sixteen tons, since 1885 thirty tons has been recorded. Generally speaking, the rise in tension may be expressed musically by the interval of a minor third, to the great advantage of the standing in tune. First shown by Henry Steinway in the London Exhibition of 1862, this altered construction attracted extraordinary attention at Paris in 1867, and determined the German direction of manufacture and a few years later the English. What is now particularly noticeable wherever pianos are made is the higher average of excellence attained in making, as well as in piano-playing. Naturally the artistic quality, the personal note, characterizes all first-class instruments, and permits that liberty of choice which appertains to a true conception of art.

Much attention has been given of late years to the touch of pianos, to make it less thirring for the modern performer, especially since, in 1885-1886, Anton Rubinstein went through the herculean feat of seven consecutive historical recitals, repeated in the capital cities and principal musical centres of Europe. For even this stupendous player a light touch was indispensable. In

the competition for power piano makers had been gradually increasing the weight of touch to be overcome by the finger, until, to obtain the faintest pianissimo from middle C, at the front edge of the key, from three to four ounces was a not uncommon weight. The Broadwood grand piano which Chopin used for his recitals in London and Manchester in 1848, an instrument that has never been repaired or altered, shows the resistance he required: the middle C sounds at two ounces and a half, and to that weight piano-makers have returned, regarding two ounces and three-quarters as a possible maximum. Owing to the greater substance of the hammers in the bass, the touch will

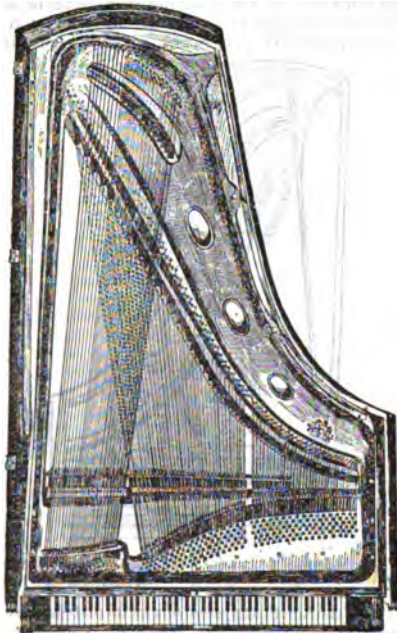

Fig. 34.—Broadwood Barless Grand.

always be heavier in that department, and lighter in the treble from the lesser weight. In balancing the keys, allowance has to be made for the shorter leverage of the black keys. When the player touches the keys farther back the leverage is proportionately shortened and the weight increased, and there is also an ascending scale in the weight of the player's blow or pressure from pianissimo to fortissimo. The sum of the aggregate force expended by a pianist in a recital of an hour and a half's duration, if calculated, would be astonishing.

The most important structural change in pianos in recent years has been the rejection of support given by metal bars or struts between the metal plate to which the strings are hitched and the wrest-plank wherein the tuning-pins are inserted. These bars formed part of William Allen's invention, brought forward by Stodart in 1820, and were first employed for rigidity in place of compensation by the Paris Erards two years later, Broadwood in London introducing about that time the fixed metal plate. The patent No. 1231, for the barless or open-scale piano, taken out in London in 1838 by H. J. Tschudi Broadwood, is remarkable for simplification of design as well as other qualities. Ten years elapsed after the taking out of the patent before the first *barless grand* was heard in public (January 1808 at St James's Hall). The metal frame, bolted in the usual manner to the bottom framing, is of fine cast steel entirely free from any transverse bars or struts, being instead turned up round the edges

to form a continuous flange, which enables the frame to bear the increased modern tension while providing additional elasticity and equality of vibration power throughout the scaling. The absence of barring and bracing tends to subdue the metallic quality of tone so often observable in pianofortes constructed with heavy iron frames, and the barless steel frame being so much more elastic than the latter, no loss in resonance is perceptible. The tone of the barless grand is of singular beauty and sonority and is even throughout the compass.

The problem of resonance—with stringed keyboard instruments, the reinforcement or amplification of sound—has, from the days of the lute- and spinet-makers, been ^{The} empirical. With lute, guitar, and viol or violin ^{Increase of} the sound-box comes in, combining in the instrument ^{Resonance.} the distinct properties of string and enclosed air or wind. With the spinet, harpsichord and piano we have to do chiefly with the plate of elastic wood, to amplify the initial sound of the strings; and the old plan of a thin plate of spruce, put in slightly convex and with an under-barring of wood for tension, has absorbed the attention of piano-makers. The violin belly, with its bass bar and sound post, has relation to it; but the recent invention of the Stroh violin has shown that the initial string vibrations may be passed through a bridge, be concentrated, and adequately transferred to an aluminium disk not much larger than half a crown. The piano, with its numerous strings, cannot be so reduced, but the reinforcement problem is open to another solution, tentative it is true, but a possible rival. The "Gladiator" soundboard is the invention of Albert Schulz, late director of the piano manufactory of Ritmüller and Söhne of Göttingen. Dr Moser's name has been associated with the inventor's in the English patent. In the "Gladiator" two slabs of wood, with grain of opposed direction to give the necessary tension, are glued together, and the whole system of belly bars is done away with. There is a thinning round the edge, to facilitate promptness of speech. As we are still feeling our way towards an accurate and comprehensive statement of resonance, this invention is one claiming scientific interest, as well as being of possible practical importance.

To return to the touch. The desirability of what is called repetition—that the jack or sticker, which from the depression of the key delivers the blow that raises the hammer to the strings, should never be far away from the notch or nose which receives the impulse—is as much an object of consideration with piano-makers now as it has been since Sebastian Erard began those experiments in 1808 which ended

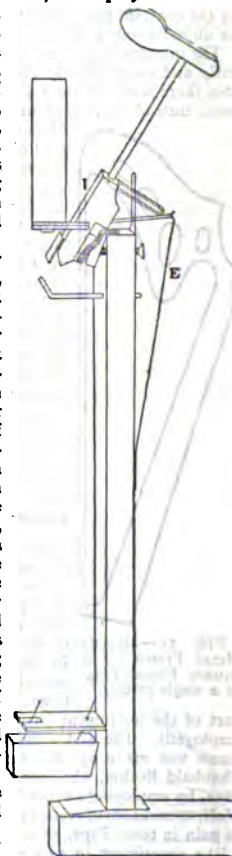

FIG. 35.—Cary's Repeating Action. I, the butt in which the hammer is glued. E, a spring attached to the butt by a link of silk cord passed through a wire guide. The object is that though the key may be still pressed down, the hammer returns but a short distance to ensure a quick response to the blow if repeated.

in his famous "double escapement" action. The principle of this grand action, like that of Wornum patented for upright pianos in 1826, has become general. But Joseph Henry Cary in 1853 (patent No. 2283) invented a simple contrivance for repetition in all pianos, neglected at the time, and subsequently repeated and disputed over by others, which has only been preserved in the records of the patent office, while the inventor has left no other mark. But the utility of the invention has come to light. It is increasingly used in the actions of upright pianos, and, in combination with the old English grand action, is successfully competing with the Erard action proper and the simplified Herz-Erard, of late years so very generally employed.

There has been a great change in the freer technique of piano-playing, partly favoured by the development of piano-making, but reacting and obliging the piano-makers to keep their attention incessantly alive to the aim and requirements of the players. It is true that the genius of Beethoven dominates a technique that has become obsolete, and so completely that the adequate performance of his piano works still gives to the sense as well as the intellect the highest pleasure, but his annotations to Cramer's *Studies*, as preserved by Schindler, betray the close touch of the clavichord-player and the student of C. P. E. Bach's *Essay on Clavichord-Playing*, as well as the

weakness as a musical instrument of the early piano. The inventor of a technique so original, and at the time (c. 1830) so extraordinary, as Chopin's, sat at the piano with his elbows immovable, using, for flexibility, neither wrist nor arm. With Chopin, to play loudly was anathema. The modern free style of playing comes from Czerny—whom Beethoven despised as having no legato (*Bindung*)—through Liszt to the Rubinsteins and to the splendidly equipped performers of our time, to whom the pedal has become indispensable for cantabile and effect.

The most expert performers are now rivalled technically by the recent extraordinary invasion of the American automatic piano-players—the Angelus, Pianola, Apollo, Cecilian, and other varieties of the same idea. The use of the perforated roll acts by means of the ingenious and indeed faultless application of pneumatic leverage to the ordinary piano, doing duty for the pianist's fingers; and it is made possible to play louder or softer, faster or slower, by mechanical arrangement. Such an instrument lacks the player's touch, which is as personal and indispensable for sympathy as the singer's voice or violinist's bow. Still, to a violinist, it is a benefit to have a correct condutor in a Beethoven or Brahms sonata with one of these handy companions, just as it is to a singer to have always at command the accompaniments to his or her repertory. The Apollo has the addition of a useful transposing apparatus—an aid, however, that, though often tried, has never yet been adopted; it is possibly too disturbing to the musician's ear. The mechanical tuning-pin is an analogous experiment which comes regularly under notice as the years go by, to be as persistently rejected. The most practical of these tuning inventions was the Alibert, shown in the Inventions Exhibition, 1885. Here, pressure upon the strings above the wrest-plank bridge modified their tension after a first rough adjustment to pitch had been effected.

The perforated music-sheet, a mechanism common to piano-playing attachments as well as self-playing pianos, first appears in a French patent, 1842. A United States patent for a keyboard piano-player was issued to E. D. Bootman (Dec. 18, 1860), and the first pneumatic keyboard piano-player was patented in France in 1863 by M. Fournieux. Between 1879 and 1902 a total of 55 patents had been issued in the States. The first complete automatic piano-player ready for performance was the Angeus (No. 24799, 1897). The specification is from a communication to the British patent office by Edward Hollingworth White, of Meriden, New Haven county, Conn., U.S.A. There is a pneumatic chest, fulcrum bar, finger levers, bellows and pedals. The whole apparatus is contained in a portable cabinet mounted upon castors, so as to be conveniently moved about a room. The finger levers or key strikers correspond with a considerable portion of the manual keys or clavier of a piano. Thus the automatic piano-player comprises a portable cabinet provided with bellows and operating pedals, a pneumatic actuating mechanism, a tracker adjusted for the use of a perforated music-sheet, a pneumatic motor and winding-roll mechanism to propel the music-sheet, and a series of finger levers operated by the pneumatic mechanism, so projecting as to overhang the piano keyboard and play upon it, with rockers or levers for depressing the piano pedals. Subsequently the apparatus was made capable of accelerating or retarding the tempo at the will of the operator. A roll of music, 12 in. wide and varying in length according to the composition, can be placed in position promptly, and when exhausted can be returned upon its original roll by a simple stop, altogether a triumph of mechanical adjustment. The Pianola followed in 1898, the Apollo 1900. The difference of all these clever contrivances is not conspicuous to the amateur.

While these allied inventions have had to do with a substitute for touch and the necessity for the persevering acquirement of a difficult technique, another, the Virgil Practice Clavier, so called after the inventor, Mr Almon Kincaid Virgil, an American music teacher, is intended to shorten the period of study by doing away with tone, so that the finger technique is acquired mechanically and unmusically, while value of tone, reading, expression, whatever we understand by musical production exciting our receptivity through the ear, is delayed until the player's hand is formed and considerably developed. The opinion of some of the very greatest pianists is brought forward as approving of the system; in the work, for instance, of Vladimir de Pachmann, whose technique was formed long before the Virgil Clavier came to Europe. Bearing in mind that the minimum weight of the touch of a concert piano is not likely to exceed three and a half ounces it is hardly likely that these skilled performers use this dumb keyboard with the graduated weight advised for advancing

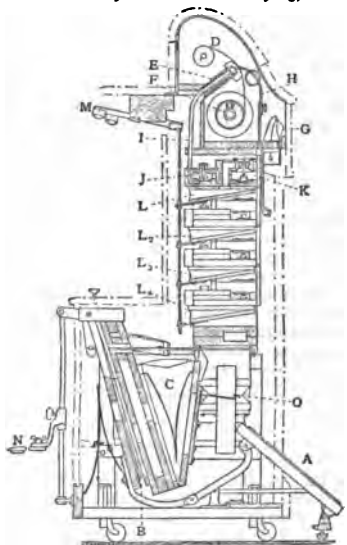

FIG. 36.—Modern Pianola.

A, Blowing pedals operated by feet of player connected by metal crank to feeder B, which exhausts air from bellows C, which in turn exhausts air from all working valves and bellows in Pianola.

D, is perforated roll passing over tracker bar E winding on to spool F operated by a pneumatic motor and controlled by lever G, which is connected to metrostyle pointer H. This is used in conjunction with a specially marked roll, giving correct interpretation of tempo.

I, is channel leading to primary pneumatic J operating secondary pneumatic K, which exhausts striking motor L, connected to key lever M to depress piano key.

The themodist device consists of two small holes, one at each end of tracker bar E, connecting with pneumatic valve, which increases power of suction instantaneously when melody notes are being played, by means of an extra perforation at each outside edge of music roll D; one hole for bass melody at left, and one at right edge for treble melody.

N, is metal arm or bracket connected to lever in front for purpose of depressing sustaining pedal of piano.

O, is the governing bellows of motor for operating music-roll and prevents pace of roll being accelerated or retarded by hard or soft pedalling, thus allowing great change of expression to be made without interfering with speed of roll.

pupils, namely, from five to eight ounces. It is allowed that the lightest possible touch may be used at first. One high recommendation certainly remains after all that may be said regarding Mr Virgil's invention: that it is practically silent, and almost noiseless, the up and down clicks that mark the duration of finger attachment being alone audible, a boon to the unwilling hearers of ordinary piano practice, scales and five-finger exercises. Mr Virgil's invention was produced in its elementary form in 1872, the more satisfactory Practice Clavier dates from the completion of the invention, about 1890. It was brought to England in 1895 by Mr Virgil.

BIBLIOGRAPHY.—A. Schlick, *Spiegel der Orgelmacher* (Mainz?, 1511; Berlin repr., 1899); S. Virdung, *Musica getusch und ausgezogen* (Basel, 1511; reprinted in facsimile, Berlin, 1882); M. Agricola, *Musica instrumentalis* (Wittenberg, 1520); O. Luscinus, *Musurgia sive praxis musicæ* (Strassburg, 1536); M. Praetorius, *Syntagma musicum*, vol. i. (Wittenberg, 1615); vols. ii. and iii., in German, Wolfenbüttel, 1619; M. Merseune, *Harmonicorum* (Paris, 1635), and *Harmonie universelle* (Paris, 1636); C. Huygens, *Correspondance*, (Jonkbloet et Laand, Leiden, 1882); T. Mace, *Musick's Monument* (London, 1676); J. S. Bach, *Das wohltemperirte Clavier* (Coethen, 1722); C. P. E. Bach, *Versuch über die wahre Art das Clavier zu spielen* (Berlin, 1753); J. Adlung, *Musica mechanica organoedii* (Berlin, 1768); C. Burney, *The Present State of Music in France and Italy* (London, 1771), and *The Present State of Music in Germany, the Netherlands, &c.* (London, 1772); W. A. Mozart, *Briefe* (Leipzig, 1878); D. Steibelt, *Three Sonatas, Op. 35*, preface (London, 1799), and *Méthode de piano forte* (Paris, 1805); F. J. Fétis, "Esquisse de l'Histoire du Piano," in the *Revue et gazette musicale* (Paris, 1830), partly translated in the *Harmonicon* (London, 1830-1831); "Exposition universelle de Londres," in *Gazette musicale* (Paris, 1851), *Exposition universelle de Paris, rapport du jury* (Paris, 1855), "Exposition internationale de Londres," in *Gazette musicale* (Paris, 1862), and *Exposition universelle de Paris, rapport du jury* (Paris, 1867); J. S. Broadwood, *Some Notes made in 1838*, with observations and elucidations by H. F. Broadwood (London, 1862); Kuetzing, *Das wissenschaftliche der Forlepiano Baukunst* (Bern, 1844); S. and P. Erard, *London Exhibition* (London, 1851); W. Pole, *Musical Instruments of the Great Exhibition*, "from *Newton's Patent Journal* (London, 1851), and in *Jurors' Reports, International Exhibition* (London, 1862); J. Fischhoff, *Versuch einer Geschichte des Clavierbaues* (Vienna, 1853); Anonymous, *Notes sur les travaux de M. M. Erard* (Paris, 1855); C. A. André, *Der Clavierbau*, Offenbach, 1855; H. Welcker von Gontershausen, *Der Flügel oder die Beschaffenheit des Pianos in allen Formen* (Frankfurt, 1856), and *Der Clavierbau in seiner Theorie, Technik und Geschichte* (Frankfurt, 1870); E. F. Rimbault, *The Pianoforte* (London, 1860); J. Broadwood & Sons *International Exhibition* (London, 1862); L. de Burbure, *Recherches sur les facteurs de clavecins d'Anvers* (Brussels, 1863); A. W. Ambros, *Geschichte der Musik*, vol. ii. (Breslau, 1864); O. Paul, *Geschichte des Claviers* (Leipzig, 1868), and *Musiklicher Bericht über die wiener Ausstellung im Jahre 1873* (Brunswick, 1874); G. F. Stevens, *Il Pianoforte guida pratica* (Naples, 1868); *Patents: Abridgments of Specifications relating to Musical Instruments* (London, 1871); F. Rombouts and T. Van Lierus, *De Liggeren der antwerpsche Sint Lucasgilde* (vol. i. Antwerp, 1872; and vol. ii., The Hague); C. Engel, *Musical Instruments in the South Kensington Museum* (London, 1874), and "Some Account of the Clavichord," in *Musical Times* (London: July, August, September, 1879); E. Van Der Straeten, *La Musique aux Pays-bas*, vol. iii., (Brussels, 1875); Chickering & Sons, *The Pianoforte* (Boston, 1874); C. Chouquet, *Le Musée du conservatoire national de musique* (Paris, 1875), and *Exposition universelle et internationale de Paris, rapport du jury* (Paris, 1880); L. Puliti, *Della Origine del pianoforte* (Florence, 1876); C. Meyer & Son, *On the Full Iron Plate Frame for Pianos* (Philadelphia, 1876); C. Ponsicchi, *Il Pianoforte, sua origine e sviluppo* (Florence, 1876); Bosanquet, *Elementary Treatise on Musical Intervals* (London, 1876); A. Kraus, *Catalogue des instruments de musique du musée Kraus* (Florence, 1878); V. Mahillon, *Annuaire du conservatoire royal de musique de Bruxelles* (Brussels, 1877 to 1883), and *Catalogue descriptif et analytique du musée instrumental du conservatoire royal de musique de Bruxelles* (Ghent, 1880-1881); L. F. Valdrighi, *Musurgiana* (Modena, 1879); E. Brinsmead, *History of the Pianoforte* (London, 1879); S. Blondel, *Histoire anecdotique du piano* (Paris, 1880); A. Reussmann, *Illustrirte Geschichte der deutschen Musik* (Leipzig, 1880-1881); A. J. Ellis, "History of Musical Pitch," with appendices, in *Journal of the Society of Arts* (London, 1880); A. J. Hiplins, various articles in *Grove's Dictionary of Music and Musicians*, "History of the Pianoforte," with appendix, in *Journal of the Society of Arts* (London, 1883), and "The Pianoforte and its Precursors, in the *English Illustrated Magazine* (London, 1884); O. Bie, *History of the Pianoforte* (London, 1889); J. Bluetner and H. Gretschel, *Der Pianofortebau* (3rd ed. Leipzig, 1909); S. Haning, *Das Pianoforte in seinen akustischen Anlagen* (Schwerin, 1910); F. A. Goehlinger, *Geschichte des Klavichords* (Basel, 1910). (A. J. H.; K. S.)

PIANOSA (anc. *Planasia*), an island of Italy, belonging to the province of Leghorn, and forming part of the commune

of Marciana (Elba), from which it is 7½ m. S.W. Pop. (1881), 774. As its name indicates, it is quite flat, and the highest point is only 95 ft. above sea-level. Its area is 6 sq. m. Augustus banished to it his grandson, Agrippa Postumus, and some ruins of baths near the harbour still bear his name. It changed hands more than once in the wars between Pisa and Genoa in the 12th and 13th centuries; from 1390 it belonged to the prince of Piombino, but was depopulated in 1553 by the Turkish fleet, and only resettled at the beginning of the 19th century. In 1857 a penal colony was established here.

PIARISTS, the popular name of a Catholic educational order, the "clerici regulares scholaram *piarum*," the Pauline Congregation of the Mother of God, founded by Joseph Calasanza (Josephus a Matre Dei) at Rome in the beginning of the 17th century. Calasanza, a native of Calasanz in the province of Huesca in Aragon, was born on September 11, 1556, studied at Lerida and Alcalá, and after his ordination to the priesthood removed to Rome (1592). Here he organized, in 1607, a brotherhood which ultimately, in 1617, became an independent Congregation, numbering at that time fifteen priests, under Calasanza as their head. To the three usual vows they added a fourth, that of devotion to the gratuitous instruction of youth. In 1622 the Congregation received a new constitution from Gregory XV., and had all the privileges of the mendicant orders conferred upon it, Calasanza being recognized as general. In 1643 the jealousy of the Jesuits led to his removal from office; owing to the same cause the Congregation was deprived of its privileges by Innocent X. in 1646. Calasanza, who died on August 22, 1648, was beatified in 1748, and canonized in 1767. The privileges of the Congregation were successively restored in 1660, 1669 and 1698. The Piarists, who are not numerous, are found chiefly in Italy, Spain, the West Indies, Germany, and especially in Austria-Hungary. Before the course of study was regulated by the state, a Piarist establishment contained nine classes: reading, writing, elementary mathematics, schola parva or Rudimentorum, schola Principiorum, Grammatica, Syntaxis, Humanitas or Poesis, Rhetorica. The general provost of the order is chosen by the general chapter, and with a general procurator and four assistants resides at Rome. The members are divided into professors, novices, and lay brethren. Their dress is very similar to that of the Jesuits; their motto "Ad majus pietatis incrementum!"

For Calasanza, see Timon-David, *Vie de St Joseph Calasance* (Marseilles, 1884); on the Piarists, F. Helyot, *Hist. des ordres religieux* (1715), iv. 281; J. A. Scyffert, *Ordensregeln der Piaristen* (Halle, 1783); J. Schaller, *Gedanken über die Ordensfassung der Piaristen* (Prague, 1805); A. Heimbucher, *Orden und Kongregationen* (1897) ii. 271; articles by O. Zückler in *Herzog-Haug's Real-encyclopädie für protestantische Theologie* (1904), vol. xv. and by C. Kniel in *Wetzer und Welte's Kirchenlexikon* (1895), vol. ix.

PIATRA (PEATRA), the capital of the department of Neamtzu, Rumania, situated on the left bank of the river Bistritza, where it cuts a way through the Carpathian foothills. Pop. (1900), 17,391. A branch railway passes through the town, and at Bacau meets the main line from Czernowitz in Bukowina to Galatz. The church of St John's (or the Prince's) monastery was founded in 1497 by Stephen the Great. There are saw-mills and textile factories in Piatra, which has a considerable trade in wine and timber. Neamtzu is one of the most densely forested regions in Moldavia. Lumber rafts are floated down the Bistritza to the Sereth, and so on to Galatz. There are several monasteries in the neighbourhood.

PIATTI, CARLO ALFREDO (1822-1901), Italian violoncellist, was born at Bergamo on the 8th of January 1822. He was the son of a violinist, and became a pupil at the conservatorio of Milan. From 1838 onwards he journeyed over Europe, playing with extraordinary success in all the important cities of the continent. In 1844 he appeared before the London public at a Philharmonic Concert; and in 1859, on the foundation of the Popular Concerts, he took up the work with which he was most intimately connected for thirty-nine seasons, retaining until 1897 the post of first violoncello at these famous chamber concerts, during the latter

half of each series. His purely classical style, his wide musical sympathies, and his general culture and charm, would have ensured him a high position even without his marvellously finished technical skill. In 1894 the fiftieth anniversary of his first appearance in London was celebrated by a reception given in honour of him and his lifelong friend Joachim. He retired from public life, owing to a severe illness, in 1897, and until his death at Bergamo on the 19th of July 1901 divided his time between his native town and Cadenabbia. As a composer he attained a wide popularity with some graceful and popular songs; he did excellent work as an editor; and he was an enthusiastic collector and musical antiquary.

PIAUHY, or **PIAUI**, a north-eastern state of Brazil, bounded N. and W. by Maranhão, E. by Ceará, Pernambuco and Bahia, and S. by Bahia. It has a few miles of Atlantic coast-line on the N., and the Rio Parnaíba forms the boundary line with Maranhão throughout its entire length. Area, 116,523 sq. m.; pop. (1900), 334,318. Part of the state on the Atlantic coast and along the lower Parnaíba is low, swampy and malarial. South of this the country rises gradually to a high plateau with open campos. This plateau region is watered by numerous tributaries of the Parnaíba, chief of which are the Urussuhy, the Canindé and its tributary the Piahy, the Gurgueia and its tributary the Parahim, which drains the large inland lake of Parnaúá, the Longa, and the Poty, which has its source in the state of Ceará. The Parnaíba is navigable for boats of 3 ft. draught up to Nova York, a few miles above the mouth of the Gurgueia, and could be made navigable up to the mouth of the Balsas. The climate is hot and humid in the lowlands and along the lower Parnaíba, but in the uplands it is dry with high sun temperatures and cool nights. The principal industry is stock-raising, which dates from the first settlement in 1674 by Domingos Afonso Mafense, who established here a large number of cattle ranges. A secondary industry is the raising of goats, which are able to stand neglect and a scanty food supply. Sheep have likewise been raised in Piahy, but there is no market for mutton and their wool is not utilized. The agricultural products are cotton, sugar and tobacco. Of food-stuffs the people do not produce enough for their own consumption. Forest products include rubber, carnauba wax and dyewoods. The exports include hides, skins, rubber, wax, tobacco and cotton. The capital is Therezina, on the right bank of the Parnaíba, 250 m. above Parnaíba (town), with which it is connected by a line of light-draught river boats. The town dates from 1852, is attractively situated, and is regularly laid out with broad, straight streets crossing each other at right angles. The population of the *município* in 1890 was 31,523, which includes a large rural district. Other towns, with their populations in 1890, are Ociras (19,858), founded in 1718 under the name of Moxa; Amarante (15,525); Valença (17,693); and Campo Maior (12,425), the figures given of population being those of the large districts (*municípios*) in which the towns are situated.

PIAZZA, properly an open square or place in an Italian town (Ital. *piazza*, from Lat. *platea*, broad space, Gr. *πλατὺς*, broad). These squares were usually surrounded with a colonnade or arcade, and thus the word has been loosely applied to a covered walk or arcade along the front of a building, and in America, to the veranda of a house.

PIAZZA ARMERINA, a city of Sicily, in the province of Caltanissetta, 39 m. by road E.S.E. from that town, and the same distance S. of the railway station of Assoro-Valguarnera, 43 m. W. of Catania, situated 2360 ft. above sea-level. Pop. (1901), 24,119. It has a 15th-century cathedral, with a fine campanile, and some of the houses show Norman or Gothic architecture. The foundation of the town dates from the 11th century, and the dialect is Lombard.

See Mauceri in *L'Arte* (1906), 14.

PIAZZI, GIUSEPPE (1746–1826), Italian astronomer, was born at Ponte, in the Valtellina, on the 16th of July 1746. He entered the Theatine Order in 1764, accepted the chair of mathematics in the academy of Palermo in 1780, and persuaded the viceroy, Prince Caramanico, to build an observatory there.

During a visit to England in 1788 he procured from Jesse Ramsden a five-foot altazimuth, with which he collected at Palermo, 1792–1813, the materials for two admirable star-catalogues, published in 1803 and 1814 respectively. While engaged on this work he discovered, on the 1st of January 1801, the first asteroid or minor planet, to which he gave the name of Ceres, the tutelary deity of Sicily. He died at Naples on the 22nd of July 1826.

See B. E. Mainieri, *L'Astronomo Giuseppe Piazzi* (Milan, 1871); R. Wolf, *Biographien*, Bd. iv. p. 275; *Monatliche Correspondenz* (1810; portrait), xxi. 46; *Astr. Jahrbuch*, liv. 218; *Bulletin des sciences* (1826), vi. 339; *Edin. Journal of Science* (1827), vi. 193; *Memoirs Roy. Astr. Soc.* iii. 119; R. Grant, *Hist. Phys. Astronomy*, pp. 238, 510, 549.

PIBRAC, GUY DU FAUR, SRIGNEUR DE (1529–1584), French jurist and poet, was born at Toulouse, of an old family of the magistracy. He studied law there with Jacques Cujas, and afterwards at Padua. In 1548 he was admitted to the bar at Toulouse, at once took high rank, and rose to be *juge-mage*, an office in Languedocian cities about equal to that of *président*. He was selected in 1562 as one of the three representatives of the king of France at the council of Trent. In 1565 he became general advocate to the parlement of Paris, and extended the renaissance in jurisprudence which was transforming French justice. In 1573 he was sent by Charles IX. to accompany as chancellor his brother Henry (afterwards Henry III.) to Poland, of which country Henry had been elected king. Pibrac's fluent Latin won much applause from the Poles, but his second visit to Poland in 1575, when sent back by Henry III. to try to save the Crown he had deserted, was not so successful. Then he was employed in negotiations with the so-called *politiques*, and he managed to keep them quiet for a while. In 1578 he became the chancellor of Marguerite of France, queen of Navarre. Although he was fifty, her beauty and intellectual gifts led him to aspire to win her affection; but he was rejected with disdain. He died in 1584. His oratorical style was too pedantic, but quotations from the classics had a fresher meaning in his day. He was the friend of Ronsard, de Thou and L'Hôpital, and left, among other literary remains, elegant and sententious *quatrains*.

PIBROCH, a form of music as played by the bagpipe. The word is derived from the Gaelic *piobaireachd*, the art of the bagpiper. This special form of bagpipe music, consisting of a series of variations founded on a theme, was called the *urlar*. These variations are generally of a martial or warlike character and include dirges and marches (see BAGPIPE).

PICA, the name of the European representative of a group of diminutive rodent mammals, also known as tailless hares, mouse-hares, or piping hares, constituting the family *Ocholonidae* with the single genus *Ochotona*. From the more typical hares and rabbits they differ by the short and rounded ears, the absence of a tail, and the relatively shorter hind-limbs, as well as by complete collar-bones. The soles of the feet are hairy, and the fur is usually soft and thick; while in some cases the last upper molar is absent. Picas are inhabitants of cold and desert regions. They dwell either in the chinks between rocks, or in burrows, although one Himalayan species frequents pine-forests. They are very active, and most of the species utter a piping or whistling cry. They store up a supply of grass for winter use; in Siberia it is stacked in small heaps. The Himalayan *Ochotona roylei* may be seen in the daytime, but most kinds are nocturnal. The Siberian species, *O. alpina*, ranges into eastern Europe, but Central Asia is the headquarters, although a few species range into Arctic America and the Rocky Mountains. In size picas may be compared to guinea-pigs. Till of late years the group has been generally known by the name of *Lagomys*. There are several extinct genera.

See **RODENTIA**; also J. L. Bouhote, "The Mouse-hares of the genus *Ochotona*," *Proc. Zool. Soc.* (London, 1905). (R. L.)

PICA, the Latin name of a genus of oscine passerine birds, the magpies. The Latin word, by interchange of initial *p* and *k*, is possibly the Gr. *κίσσα* (see **MAGPIE**), and probably the same word as *picus*, the woodpecker (*q.v.*). Another derivation would connect both *pica* and *picus* with the root *pic-* of *pingere*, to

paint, from the parti-coloured appearance of the bird. It is this "pied" or black and white look of the page that probably gave the name of *pica*, "pie" or "pye," to the ordinal printed in black-letter (see *Pix*), and thence to a size of type in printing coming next to "English" (see *TYPOGRAPHY*). The Gr. *πικρα* and Lat. *pica* were used of a perverted craving for unnatural foods; and the word has been adopted in this sense in modern medical terminology.

PICARD, LOUIS JOSEPH ERNEST (1821-1877), French politician, was born in Paris on the 24th of December 1821. After taking his doctorate in law in 1846 he joined the Parisian bar. Elected to the *corps législatif* in 1858, he joined the group of *Emile Ollivier*. But as *Ollivier* approximated to the government standpoint, *Picard*, one of the members of the group known as *Les Cinq*, veered more to the left. He founded in 1868 a weekly democratic journal, *L'Electeur libre*, and in 1869 was elected both for *Hérault* and Paris, electing to sit for the former. From the 4th of September 1870 he held the portfolio of finance in the government of National Defence. In January 1871 he accompanied *Jules Favre* to Versailles to arrange the capitulation of Paris, and in the next month he became minister of the interior in *Thiers's* cabinet. Attacked both by the Monarchist and the Republican press, he resigned in May. Later in the year he was sent as ambassador to Brussels, where he remained for two years. On his return to Paris he resumed his seat in the Left centre, and in 1875 became life senator. He died in Paris on the 13th of May 1877.

PICARDY (*La Picardie*), one of the old provinces of France, bounded on the N. by *Hainaut* and *Artois*, on the E. by *Champagne*, on the S. by the *Île de France*, and on the W. by *Normandy* and the *English Channel*. Its maritime frontier ran from the mouth of the *Aa* to the cliffs of *Caux*, and it included the whole of the basin of the *Somme* and part of that of the *Oise*. The chief towns of *Picardy* were *Amiens*, *Boulogne*, *Abbeville*, *Laon*, *Soissons*, *Montreuil*, *Péronne*, *Beauvais*, *Montdidier*, *St Quentin* and *Noyon*. Its principal rivers were the *Somme* and the *Oise*. *Picardy* formed part of the archdiocese of *Reims*, and its bishoprics were *Amiens*, *Beauvais*, *Senlis*, *Soissons*, *Noyon* and *Laon*. In 1789 the province of *Picardy* was covered by the three bishoprics of *Amiens*, *Noyon* and *Boulogne*. It was one of the provinces of the five great *fermes*, districts subject to the tariff of 1664, and in judicial matters was under the authority of the *parlement* of Paris. Its area now forms the department of the *Somme* and parts of the departments of *Pas de Calais*, *Aisne* and *Oise*.

The name of *Picardy* does not appear until the 13th century, but was employed by *Matthew Paris* and was in general use in the 14th century. In the 13th century the province was divided into the two bailliages of *Amiens* and *Vermandois*, but its regular organization as part of the kingdom of France only dates from the beginning of the 16th century. At this time it was divided into north and south *Picardy*. North *Picardy*, or *Picardy proper*, formed one of the great military governorships of the kingdom, while south *Picardy* was included in the *Île de France*. North *Picardy* was divided into upper and lower *Picardy*, the former being the interior part of the province and the latter the district along the coast. Upper *Picardy* comprised the districts of *Amiénois*, *Santerre*, *Vermandois* and *Thiérache*, and lower *Picardy* those of *Ponthieu*, *Vimeu*, *Boulonnais* and *Calaisis*, or the *Pays reconquis*; south *Picardy* included the districts of *Beauvaisis*, *Laonnais* and *Soissonais*.

Under the Romans *Picardy* was part of *Belgica secunda*; it was inhabited by the *Morini*, the *Ambiani*, the *Veromandui*, the *Bellovaci* and the *Suessiones*, whose names still appear in *Amiens*, *Vermandois*, *Beauvais* and *Soissons*. The Romans intersected the district with roads and built several castra to defend the valley of the *Somme*. In the 3rd century Christianity was preached here, and *St Quentin* and others were martyred. A little later abbeys were founded, among them *Corbie*, *St Valéry* and *St Riquier*. Early in the 5th century *Picardy* became the centre of Merovingian France, for, as the historian *Michelet* says, "l'histoire de l'antique France semble entassée

en Picardie." *Clovis* had his first capital at *Soissons*, *Charlemagne* had his at *Noyon*, and *Laon* was the capital and the refuge of the later and feebler Carolingian sovereigns.

During the later feudal period *Picardy* was the home of the counts of *Vermandois*, of *Clermont* and of *Ponthieu*, the sire of *Coucy* and others. The neighbouring dukes of *Burgundy* cast covetous eyes upon the province; in 1435, by the famous treaty of *Arras*, the royal towns and lands in the valley of the *Somme* were ceded by *King Charles VII.* to *Burgundy*. However, after the death of *Charles the Bold* in 1477 *Picardy* was finally united with the crown of France. The province was early an industrial district. *Flemish* immigrants brought with them the lucrative trade of weaving cloth, and the *Somme* towns were soon competing with those of *Flanders*. The *Picard* towns were noted for their love of independence, which often brought them into collision with the kings of France during the 13th century. At a later time the province received a number of Spanish immigrants. In the middle ages the *Picards* formed one of the four "nations" at the university of Paris. *Picardy* has a high place as a home of Gothic art, this being testified to by the superb cathedrals at *Amiens* and *Noyon*, while within its borders is the famous *château* of *Coucy*.

Picardy has a literature of its own, which was rich and popular in the 12th century. It suffered greatly from the ravages of the Normans, and later during the Hundred Years' War and the wars between France and Spain. Within it are the famous fields of *Crecy*, *Agincourt* and *St Quentin*, while it also includes places of conference like *Guines*, *Amiens* and *Picquigny*. The *Picard* had a high reputation as a soldier, being sometimes called the "Gascon of the North," and in 1558 *Henry II.* created the *régiment de Picardie*. Many anthropological remains have been found in the *Somme* valley.

See *Labourt*, *Essai sur l'origine des villes de Picardie* (*Amiens*, 1840); *Grenier*, *Introduction à l'histoire générale de la province de Picardie* (*Amiens*, 1856); and *H. Carnoy*, *Littérature orale de la Picardie* (1883).

PICARESQUE NOVEL, THE. This special form of the *roman d'aventures* may be defined as the prose autobiography of a real or fictitious personage who describes his experiences as a social parasite, and who satirizes the society which he has exploited. The picaresque, or rogue type, is represented by *Encolpos*, *Ascytos* and *Giton* in the *Satyricon* which tradition ascribes to *Petronius*; it persists in *Lucian*, in the *Roman de Renart*, in the *fabliaux*, and in other works popular during the middle ages; and it is incarnated in real life by such men of genius as the Archpriest of *Hita* and *François Villon*. But in its final form the picaresque novel may be regarded as a Spanish invention. The word *pícaro* is first used, apparently, in a letter written by *Eugenio de Salazar* at *Toledo* on the 15th of April 1560; the etymology which derives *pícaro* from *pícar* (to pick up) is unsatisfactory to philologists, but it suggests the picaresque's chief business in life. In the *Tesoro de la lengua castellana* (*Madrid*, 1611) *Sebastian Covarrubias* y *Orozco*, the best of Spanish lexicographers, describes a *pícaro* as a man of loose character engaged in menial work and—by extension—a rascal who attains his ends by skillful dissimulation; and the earliest application of the expression *pícaro* to a character in fiction occurs in *Mateo Alemán's Guzmán de Alfarache*, the first part of which was published in 1599. But a genuine *novela picaresca* existed in Spain before the word *pícaro* became generally current.

The earliest specimen of the kind is *La Vida de Lazarillo de Tormes y de sus fortunas y adversidades*, an anonymous tale long attributed, on insufficient grounds, to *Diego Hurtado de Mendoza* (q.v.). The authorship of this brilliant book and the circumstances of its publication are obscure; however, it was certainly issued not later than 1554, and was thrice reprinted before 1559, when it was placed on the Index. Imitations of so successful a story were inevitable, and so early as 1555 there appeared at *Antwerp* *La Segunda parte de Lazarillo de Tormes*, an anonymous sequel which completely misinterpreted the irreverent wit of the original. The first part had been prohibited because of its attacks on the

clergy; in the second part the hero is presented as a devout youth transformed into a tunny at the intercession of the Virgin Mary, who thus saved him from death; after many extravagant experiences in this form he is restored to human shape, and proposes to teach the submarine language at the university of Salamanca. This dull performance naturally failed to please and, meanwhile, many surreptitious copies of the first part were introduced into Spain; the Inquisition finally gave up the attempt to suppress it, and in 1573 an expurgated edition was authorized. With this mutilated version the Spanish public was forced to be content during the remaining fifteen years of Philip II.'s reign. Upon the death of this sombre monarch society relaxed its hypocritical pose of austerity, and in 1599 Mateo Alemán (q.v.) published the *Primera parte de Guzmán de Alfarache*. It is modelled upon *Lasarillo de Tormes*, being the autobiography of the son of a ruined Genoese money-lender; but the writer indulges in a tedious series of moralizings. This contrasts sharply with the laconic cynicism of *Lasarillo de Tormes*; but *Guzmán de Alfarache* is richer in invention, in variety of episode and in the presentation of character. Its extraordinary popularity tempted a Valencian lawyer named Juan José Martí to publish a *Segunda parte de la vida del pícaro Guzmán de Alfarache* (1602) under the pseudonym of Mateo Luján de Sayavedra. Though partly plagiarized from the manuscript of the genuine second part to which Martí had somehow obtained access, the continuation was coldly received; in 1604 Alemán brought out the true continuation, and revenged himself by introducing into the narrative a brother of Martí—a crazy picaroon of the lowest morality who ultimately commits suicide in disgust at his own turpitude. In *Lasarillo de Tormes*, and still more in *Guzmán de Alfarache*, it is difficult to distinguish between the invented episodes and the personal reminiscences of the authors. The *Viage entretenido* (1603) of Agustín de Rojas is a realistic account of the writer's experiences as a strolling actor and playwright, and, apart from its considerable literary merits, it is an invaluable contribution to the history of the Spanish stage as well as a graphic record of contemporary low life; the chief character in the book is called the *caballero del milagro*, an expression which recurs in Spanish literature as the equivalent of a *chevalier d'industrie*.

The next in chronological order of the Spanish picaresque tales is *La Pícara Justina* (1605), the history of a woman picaroon, which it has long been customary to ascribe to Andrés Pérez, a Dominican monk; there is, however, no good reason to suppose that the name of Francisco López de Úbeda on the title-page is a pseudonym. The *Pícara Justina* has wrongly acquired a reputation for indecency; its real defects are an affected diction and a want of originality. The writer frankly admits that he has taken material from the *Celestina*, from *Lasarillo de Tormes*, from Guevara, Timoneda and Alemán, and he boastfully asserts that "there is nothing good in ballad, play or Spanish poet, but that its quintessence is given here." Unluckily he has not the talent to utilize these stolen goods. The *Pícara Justina* was thrice reprinted during the seventeenth century; this is the only basis for the untenable theory that it is the source of the *culteranismo* which reaches its climax in Gracian's treatises. The *Pícara Justina* is now read solely by philologists in quest of verbal eccentricities. Ginés de Pasamonte, one of the secondary figures in *Don Quixote* (1605-1615), is a singularly vivid sketch of the Spanish rogue, and in the comedy entitled *Pedro de Urdemalas* Cervantes again presents a brilliant panorama of picaresque existence. He returns to the subject in *Rinconete y Cortadillo* and in the *Coloquio de los perros*, two of the best stories in the *Novelas ejemplares* (1613). The attraction of picaresque life was felt by pious and learned critics, and expounded in print. In the *Viage del mundo* (1614) the zealous missionary Pedro de Cevallos interpolates amusing tales of what befell him in the slums of Andalusia before he fled from justice to America, where he lived as a sinful soldier till his spiritual conversion was accomplished. Cristóbal Suárez de Figueroa, a caustic critic of his contemporaries and an arbiter of taste, did not think it beneath his dignity to show a disconcerting acquaintance with the ways of professional rogues, and in *El Pasajero* (1617) he

fills in the sketch of the knavish inn-keeper already outlined by Cervantes in *Don Quixote*. Evidence of the widely diffused taste for picaresque literature is found in *Enríques de Castro* (1617), an interminable story written in Spanish by a Frenchman named François Loubaysin de Lamarca, who brought out his book at Paris; two years previously Loubaysin had introduced some clever but risky picaresque episodes in his *Engaños deste siglo y historia sucedida en nuestros tiempos*. But his attempt to fill a larger canvas is a complete failure.

The roving instinct of Vicente Martínez Espinel (q.v.) had led him into strange and dangerous company before and after his ordination as a priest, and a great part of his *Relaciones de la vida del escudero Marcos de Obregón* (1618) is manifestly the confession of one who has regretfully outlived his pleasant vices. The baffling compound of fact with fiction and the lucid style of which Espinel was a master would suffice to win for *Marcos de Obregón* a permanent place in the history of Spanish literature; the fact that it was largely utilized by Le Sage in *Gil Blas* has won for it a place in the history of comparative literature. Within five months of its publication at Madrid a fragmentary French version by the Sieur d'Andiguier was issued at Paris, and at Paris also there appeared a Spanish picaresque story entitled *La Desordenada codicia de los bienes ajenos* (1619), ascribed conjecturally to a certain Dr Carlos García, who reports his conversation with a garrulous gnat-bird, and appends a glossary of slang terms used by the confraternity of thieves; he was not, however, the first worker in this field, for a key to their gross jargon had been given ten years previously by Juan Hidalgo in his *Romances de germanía* (1609), a series of gipsy ballads. Every kind of picaroon is portrayed with intelligent sympathy by Alonso Jerónimo de Salas Barbadillo, who is always described as a picaresque novelist; yet he so constantly neglects the recognized conventions of the Spanish school that his right to the title is disputable. Thus in *La Hija de Celestina* (1621) he abandons the autobiographical form, in *El Subtil cordobés Pedro de Urdemalas* (1620) he alternates between dialogue and verse, and in *El Necio bien afortunado* (1621) the chief character is rather a cunning god than a successful scoundrel. The pretence of warning newcomers against the innumerable occasions of sin in the capital is solemnly kept up by Antonio Litañ and Verdugo in his *Gata y avisos de forasteros que vienen à la corte* (1620), but in most of his tales there is more entertainment than decorum.

The profession of a serious moral purpose on the part of many picaresque writers is often a transparent excuse for the introduction of unsavoury incident. There is, however, no ground for doubting the sincerity of the physician Jerónimo de Alcalá Yañez y Ribera, who at one time thought of taking holy orders, and studied theology under St John of the Cross. An unusual gravity of intention is visible in *Alonso, mono de muchos amos* (1624-1626), in which the repentant *pícaro* Alonso, now a lay-brother, tells the story of his past life to the superior of the monastery in which he has taken refuge. It abounds with pointed anecdotes and with curious information concerning the Spanish gipsies, and this last characteristic explains George Borrow's hyperbolic praise of the work as competing with *Don Quixote* in grave humour, and as unequalled "for knowledge of the human mind and acute observation."

At about this time there lived in Spain an ex-nun named Catalina de Erauso, who fled from her convent, dressed herself in men's clothes, enlisted, was promoted ensign, and saw more of life than any other nun in history. Broadside relating the story of this picaresque amazon were circulated during her lifetime, and the details of her adventures arrested the attention of De Quincey, who would seem to have read them in a Spanish original which has been admirably translated since then by the French poet José María de Heredia. The Spanish original, in its existing form, was issued no earlier than 1829 by Joaquín María de Ferrer, whose character is not a satisfactory guarantee of the work's authenticity; but its interest is unquestionable. No such suspicion attaches to the *Vida* of Alonso de Contreras, first published in 1899; this out-at-elbows soldier faithfully records how he became a knight of the Order of Santiago, how he

broke all the Commandments, how he found himself stranded in Madrid, how his fine air captivated Lope de Vega, who housed him for eight months and dedicated to him a play entitled *Rey sin reino*, and how the ex-captain ended by "resolving to retire to a lonely spot and there serve God as a hermit." Every convention of the picaresque novel is faithfully observed, and the incidents are no doubt substantially true, though Contreras, like most converts, judges his own past with unnecessary harshness. This subtle form of vanity also pervades the *Comentarios de el desengañado de sí mismo* of Diego duque de Estrada, a rakish soldier and inferior dramatist whose autobiography (begun in 1614 and continued at intervals during many years) was not printed till 1860. A far higher order of talent distinguishes the *Capitulaciones de la vida de la corte y oficios entretenidas en ella*, a bitterly unsparring review of picaresque life written by the great satirist Francisco Gomez de Quevedo y Villegas (q.v.). These thumbnail sketches were the preparatory studies worked up into the more elaborate *Vida del buscón Don Pablos* (1626), the cleverest and most revolting book of its class. There is no attempt to scare the wicked by means of awful examples; the moral lesson is contemptuously thrown aside; the veil of romance is rent in twain, and the *pícaro*—the nephew of the public executioner—is revealed as he is, gloating in cruelty and revelling in the conscious enjoyment of crime. But though Quevedo detests mankind, his morose vision of existence rarely degenerates into caricature. In his repugnant, misanthropic masterpiece the sordid genius of the Spanish picaroon finds absolute expression. Nothing further remained to be done in the matter of realism; henceforth the taste for picaresque novels grew less keen, and later writers unconsciously began to humanize their personages.

The *Varia fortuna del soldado Pindaro* (1626) added nothing to the established reputation of Gonzalo Cispedes y Meneses. A clever anonymous story, *Don Raimundo el entretenido* (1627), missed fire, even though it was attributed to Quevedo; yet the author, Diego Tovar y Valderrama, compiled a sprightly diary of the events which make up a picaroon's crowded day, and failed solely because the interest in rogues was waning. Other writers of undoubted gifts were slow to see that the fashion had changed. Alonso de Castillo Solórzano (q.v.) tempted the public with three picaresque stories published in quick succession: *La Niña de los embustes*, *Teresa de Mamanares* (1634), the *Aventuras del Bachiller Trapasa* (1637) and a sequel to the latter entitled *La Gerduña de Sevilla* (1642). Clever as Castillo Solórzano's stories are, their tricky heroes and heroines were no longer welcomed with the old enthusiasm in Spain; the *Bachiller Trapasa* was destined to be continued by Mateo da Silva Cabral in Portugal and to be exploited by Le Sage in France, and to these two accidents it owes its survival. Le Sage likewise utilised in *Gil Blas* episodes taken from *El Siglo pitagórico* (1644), the work of Antonio Enríquez Gómez (q.v.); but most of *El Siglo pitagórico* is in verse, and as it was published at Paris by an exiled Portuguese Jew, its circulation in Spain must have been limited. The normal primitive rogue returns to the scene in *La Vida y hechos de Estebanillo González* (1646), which is no doubt the genuine autobiography that it purports to be. If he is still occasionally read by students he owes it to the fact that Le Sage drew upon him in the *Histoire d'Estevanille González*. By the general public he is completely forgotten, and the same may be said of many subsequent Spanish writers who adopted the picaresque formula. The *Buscón* is the last great book of its kind.

Meanwhile, the rogue had forced his way into other European literatures. The Antwerp continuation (1555) of *Lasarillo de Tormes* brought the original to the notice of northern readers, and this first part was translated into French by Jean Saugrain in 1561. A Dutch version was issued anonymously in 1579, and it seems extremely likely that the book had been translated into English before this date. This follows from a manuscript note written by Gabriel Harvey in a copy of the *Howleglass* given him by Edmund Spenser; Harvey here mentions that he had received the *Howleglass*, Skoggin, Skelton and *Lasarillo* from Spenser on the 20th of December 1578. The earliest known edition of David Rowland's version of *Lasarillo de Tormes* is dated 1586,

but as a licence to print a translation of (his tale was granted on the 22nd of July 1568/1569, it is probable that a 1576 edition which appears in the Harleian Catalogue really existed. Numerous reprints (1599, 1639, 1669-1670, 1672, 1677) go to prove that *Lasarillo de Tormes* was very popular, and that Shakespeare had read it seems to follow from an allusion in *Much Ado about Nothing* (Act. II., sc. I.): "Now you strike like the blind man; 't was the boy that stole your meat, and you will beat the post." To Thomas Nash belongs the credit, such as it is, of being the first to write a picaresque novel in English: *The Unfortunate Traveller; or the Life of Jack Wilton* (1594). Nash carefully points out that his work is a new experiment, "being a cleane different veine from other my former courses of writing"; the only possible Spanish model that he can have had was *Lasarillo de Tormes*, but he has nothing of his predecessor's sardonic brevity, and he anticipates later Spanish writers by his emphatic insistence on the pleasures of eating and drinking to repletion. Nash led the way, and a reference to "Spanish pickaroes" in Middleton's *Spanish Gipsie* indicates that the picaroon type had speedily become familiar enough for London playgoers to understand the reference. Interest in picaresque literature was kept alive in England by a translation (1622) of a sequel to *Lasarillo de Tormes* published at Paris two years earlier by Juan de Luna, who came to London to supervise the English rendering; by James Mabbe's admirable version (1622) of *Gusmán de Alfarache*; by *The Son of the Rogue or the Politick Thief* (1638), an anonymous translation, done through the French, of *La desordenada codicia*; and by another anonymous translation (1657), likewise done through the French, of Quevedo's *Buscón*. The result of this campaign was *The English Rogue described in the Life of Meriton Latroon, a witty Extravagant* (1665), by Richard Head and Francis Kirkman. The authors of this *larrago* insist on the English nationality of their chief character, and repudiate the idea that they are in any way indebted to Aleman and Quevedo. It is no exaggeration, however, to say that almost all the material in the text is taken from Spanish sources, and even the thieves' vocabulary is stolen from John Awdeley's *Fraternitye of Yacobodars* or Thomas Harman's *Caveat, or Warning for Common Curselors*. It is not till Defoe's time that the English picaresque novel acquires any real importance, and the picaresque intention informs much of his work that contravenes the accepted rules of composition. There is a female picaroon in *Moll Flanders*, and, as Defoe read Spanish, it is conceivable that Moll Flanders was suggested by the *Picara Justina*; but this resemblance does not make a picaresque novel of *Moll Flanders*. The satirical spirit which is lacking in *Moll Flanders* is abundantly present in *Colonel Jack*, which bravely aims at exhibiting "vice and all kinds of wickedness attended with misery." Henceforward the picaroon is naturalized in English literature, and is gloriously reincarnated in Fielding's *Jonathan Wild* and in Smollett's *Ferdinand, Count Fathom*. The classification of Sterne's *Tristram Shandy* and Morier's *Hajji Baba* as picaresque novels is not strictly accurate; like *Pickwick* and *Oliver Twist* and *Barry Lyndon*, they are rather varieties of the peripatetic novel, but many incidents in all five recall the pleasing wiles of the Spanish picaroons.

The Dutch translation of *Lasarillo de Tormes* (1579) did not enable the picaresque novel to strike root in Holland, yet from it is derived one of the best Dutch comedies, *De Spaensche Brabander Jorolimo* (1616) of Gerbrand Bredero. A German translation of *Gusmán de Alfarache* was published by Aegidius Albertinus in 1615; both *Lasarillo* and *Rinconete y Cortadillo* were translated by Niclas Ulenhart in 1716, and in 1627 there appeared an anonymous version of the *Picara Justina*. The Spanish tradition was followed by Martin Freuden in a continuation (1626) of *Gusmán de Alfarache*, but the only original picaresque novel of real value in German is Grimmelshausen's *Simplicissimus*. The attempt to acclimatize the picaresque novel in Italy failed completely. Barezzi Barezzi translated *Gusmán de Alfarache*, *Lasarillo de Tormes* and the *Picara Justina* in 1606, 1622 and 1624 respectively, and Giovanni Pietro Franco did the *Buscón* into Italian in 1634; but there was no important native

development. The same may be said of Portugal; for though Silva Cabral's continuation of the *Bachiller Trapaza* is called the most remarkable of Portuguese picaresque romances, it is significant that *O peralvillo de Cordova* remains in manuscript.

The case was very different in France, where pictures of low life had always found admirers. The first translation of *Lazarillo de Tormes* appeared, as already noted, at Paris in 1561; the first translation of the first part of *Guzmán de Alfarache* was issued there by Gabriel Chappuis in 1600, and the dictator Chapelain deigned to translate both parts in 1619-1620; the first translation of the *Novelas ejemplares* was published at Paris in 1618 by Rosset and d'Audiguiere; and French translations of *Marcos de Obregón*, of *La Desordenada codicia*, of the *Buscón* and of the *Picara Justina* were printed in 1618, 1621, 1633 and 1635 respectively. Before this series of translations was completed Charles Sorel recounted in *Francia* (1622) "the comic mishaps which befall evil-doers," invoking the common excuse that it is "lawful to find pleasure at their expense." Many of the episodes in *Francia* are picaresque in tone, but unfortunately Sorel wanders from his subject, and devotes no small part of his book to satirizing literary men who, though fribbles or paupers, are in no sense picaresques. The legitimate Spanish tradition is followed more closely and with much more ability by Paul Scarron in the *Roman comique* (1657), in which horseplay is predominant. The framework may have been suggested by Agustín de Rojas or Quevedo, both of whom introduced a strolling company, and such characters as Liandre, Angélique de l'Étoile and Ragotin might be found in any average *novela picaresca*. Scarron frankly mentions Castillo Solórzano's *Garcés de Sevilla* in his text, and his *Précaution inutile* and *Les Hypocrites* are convincing proofs of close study of Spanish picaresque stories: the *Précaution inutile* is taken from *Guzmán de Alfarache*, and *Les Hypocrites* is merely a translation of Salas Barbadillo's *Hija de Calesina*. The *Roman bourgeois* (1666) of Antoine Furetière is generally described as a picaresque novel, but this involves a new definition of the adjective; the *Roman bourgeois* includes some portraits and more satire which seem suggested by picaresque reading, but it is concerned with the foibles of the middle class rather than with the sly devices of common vagabonds.

The Spanish picaroon lives again in *Gil Blas*, where, with a dexterity almost rarer than original genius, a master of literary manipulation fuses materials unearthed from forgotten and seemingly worthless Spanish quarries. *Gil Blas* is a creation of the gentler, sunnier French spirit; like Beaumarchais' Figaro he is a Spaniard born, reared and humanized in Paris, and these two are the only picaroons whose relative refinement has not been gained at the cost of verisimilitude. But the old original scoundrel was not yet extinct: in the interval between the appearance of the *Barbier de Stolle* and the *Mariage de Figaro* Restif de la Bretonne produced a sequel (1776) to the *Buscón*—a sequel so dull as to be wellnigh unreadable. The untamed Spanish rogue had become impossible towards the end of the 18th century: in the 19th he was deliberately rejected when Théophile Gautier wrote his *Capitaine Fracasse*. Yet Gautier conscientiously provides a Spanish atmosphere; the personages have Spanish names; the knife has a Spanish inscription; the host speaks French with a Spanish accent; Vallombreuse parts from the marquis with a Spanish formula: "bese á vuestra merced la mano, caballero." *Capitaine Fracasse* is the last important book which continues the picaresque tradition. The possibilities of picaresque fiction can never be exhausted while human nature is unchanged. Pereda (q.v.) in *Pedro Sánchez* (1884) touches the old theme with the accent of modernity. It may be that instead of one continuous tale, interrupted by episodic digressions, the picaresque fiction of the future will take the form of short stories independent of one another; but this would be nothing more than a convenient mechanical device, a readjustment of means to ends.

BIBLIOGRAPHY.—Frank Wedleigh Chandler, *Romances of Roguery*, pt. 1. (New York, 1899); Fongar De Hann, *An Outline of the History of the Novela Picaresca in Spain* (The Hague-New York, 1903); W. Lauser, *Der erste Schelmenroman, Lazarillo von Tormes* (Stuttgart,

1889); H. Butler Clarke, "The Spanish Rogue-Story" in *Studies in European Literature* (Oxford, 1900); A. Schultheiss, *Der Schelmenroman der Spanier und seine Nachbildungen* (Hamburg, 1893); F. J. Garriga, *Estudio de la novela picaresca* (Madrid, 1891); F. M. Warren, *History of the Novel previous to the Seventeenth Century* (New York, 1895); H. Koerting, *Geschichte des französischen Romans im 17. Jahrhundert* (Oppeln and Leipzig, 1891); Arvéde Barine, "Les gueux d'Espagne" in *Revue des deux mondes*, vol. lxxvii. (Paris, 1888); A. Morel Fatio, *Études sur l'Espagne* (3 vols., Paris, 1888-1904). (J. F.-K.)

PICAYUNE, the name in Florida and Louisiana of the Spanish half-real, = $\frac{1}{4}$ of a dollar, 6¢ cents, and hence used of the United States 5 cent piece. The French *picayon*, from which the word was adapted in America, was an old copper coin of Piedmont. Its origin is doubtful, but is possibly related to the Italian *piccolo*, little, small. In America the word is used of anything trifling, petty, mean or contemptible.

PICCANINNY, or **PICKANINNY**, a word applied originally by the negroes of the West Indies to their babies. It is adapted either from Span. *pequeño*, small, or Port. *pequeno*, very small. The word spread with the slave trade to America, and has since been adopted in Australia and in South Africa.

PICCININO, **NICCOLÒ** (1386-1444), Italian *condottiere*, born at Perugia, was the son of a butcher. He began his military career in the service of Braccio da Montone, who at that time was waging war against Perugia on his own account, and at the death of his chief, shortly followed by that of the latter's son Oddo, Piccinino became leader of Braccio's *condotta*. After serving for a short period under the Florentine Republic, he went over to Filippo Maria Visconti, duke of Milan (1425), in whose service together with Niccolò Fortebraccio he fought in the wars against the league of Pope Eugenius IV., Venice and Florence. He defeated the papal forces at Castel Bolognese (1434), but another papal army under Francesco Sforza having defeated and killed Fortebraccio at Fioridimonte, Piccinino was left in sole command, and in a series of campaigns against Sforza he seized a number of cities in Romagna by treachery. In 1439 he again fought in Lombardy with varying success against Sforza, who had now entered the Venetian service. Piccinino then induced the duke of Milan to send him to Umbria, where he hoped, like so many other *condottieri*, to carve out a dominion for himself. He was defeated by Sforza at Anghiari (1440), but although a number of his men were taken prisoners they were at once liberated, as was usually done in wars waged by soldiers of fortune. Again the war shifted to Lombardy, and Piccinino, having defeated and surrounded Sforza at Martinengo, demanded of the visconti the lordship of Piacenza as the price of Sforza's capture. The duke by way of reply concluded a truce with Sforza; but the latter, who, while professing to defend the Papal States, had established his own power in the Marche, aroused the fears of the pope and the king of Naples, as well as of the visconti, who gave the command of their joint forces to Piccinino. Sforza was driven from the Marche, but defeated Piccinino at Montelauro, and while the latter was preparing for a desperate effort against Sforza he was suddenly recalled to Milan, his army was beaten in his absence, and he died of grief and of his wounds in 1444. Short of stature, lame and in weak health, he was brave to the point of foolhardiness, wonderfully resourceful, and never overwhelmed by defeat. He was cruel and treacherous, and had no aim beyond his own aggrandizement. Piccinino left two sons, Jacopo and Francesco, both distinguished *condottieri*.

A good account of Piccinino is contained in vol. iii. of E. Ricotti's *Storia della compagnia di ventura* (Turin, 1845); G. B. Poggio, *Vita di N. Piccinino* (Venice, 1572); see also the general histories of the period.

PICCINNI, **NICCOLA** (1728-1800), Italian musical composer, was born at Bari on the 16th of January 1728. He was educated under Leo and Durante, at the Conservatorio di Sant' Onofrio in Naples. For this Piccinni had to thank the intervention of the bishop of Bari, his father, although himself a musician, being opposed to his son's following a musical career. His first opera, *Le Donne dispettose*, was produced in 1755, and in 1760 he composed, at Rome, the *chef d'œuvre* of his early life, *La Ciccina, ossia la buona*

Figliuola, an opera buffa which attained a European success. Six years after this Piccinni was invited by Queen Marie Antoinette to Paris. He had married in 1756 his pupil Vincenza Sibilla, a singer, whom he never allowed after her marriage to appear on the stage. All his next works were successful; but, unhappily, the directors of the Grand Opéra conceived the mad idea of deliberately opposing him to Gluck, by persuading the two composers to treat the same subject—*Iphigénie en Tauroïde*—simultaneously. The Parisian public now divided itself into two rival parties, which, under the names of Gluckists and Piccinnists, carried on an unworthy and disgraceful war. Gluck's masterly *Iphigénie* was first produced on the 18th of May 1779. Piccinni's *Iphigénie* followed on the 23rd of January 1781, and, though performed seventeen times, was afterwards consigned to oblivion. The fury of the rival parties continued unabated, even after Gluck's departure from Paris in 1780; and an attempt was afterwards made to inaugurate a new rivalry with Sacchini. Still, Piccinni held a good position, and on the death of Gluck, in 1787, proposed that a public monument should be erected to his memory—a suggestion which the Gluckists themselves declined to support. In 1784 Piccinni was professor at the Royal School of Music, one of the institutions from which the Conservatoire was formed in 1794. On the breaking out of the Revolution in 1789 Piccinni returned to Naples, where he was at first well received by King Ferdinand IV.; but the marriage of his daughter to a French democrat brought him into irretrievable disgrace. For nine years after this he maintained a precarious existence in Venice, Naples and Rome; but he returned in 1798 to Paris, where the fickle public received him with enthusiasm, but left him to starve. He died at Passy, near Paris, on the 7th of May 1800. After his death a memorial tablet was set up in the house in which he was born at Bari.

The most complete list of his works is that given in the *Rivista musicale italiana*, viii. 75. He produced over eighty operas, but although his later work shows the influence of the French and German stage, he belongs to the conventional Italian school of the 18th century.

See also P. L. Ginguené, *Notice sur la vie et les ouvrages de Niccolò Piccinni* (Paris, 1801); E. Demoiesterres, *La Musique française au 18^e siècle* Gluck et Piccinni 1774-1800 (Paris, 1872).

PICCOLO (Fr. *petite flûte octave*; Ger. *Pickelflöte*; Ital. *flauto piccolo* or *ottavino*), a small flute of less than half the dimensions of the large concert flute and pitched an octave higher. The principles of construction and the acoustic properties are the same for the piccolo as for the flute, with the exception that the piccolo does not contain the additional tail-piece with the extra low keys, which give the flute its extended compass. As the pitch of the piccolo is so high, the highest of all orchestral instruments with the exception of a few harmonics on the violin, the music for it is written an octave lower than the real sounds in order to avoid the ledger lines. The piccolo has been used with good effect in imitating the whistling of the wind in storms, as in Beethoven's *Pastoral Symphony*, Wagner's *Flying Dutchman*, and in conjunction with the violins in *tremolo* to depict the rustling of the leaves in the breeze, as in the "Waldweben" in *Siegfried*. Verdi employed it to advantage in *Falstaff* as a comic agent in humorous situations. The piccolo is generally in D, sometimes in E♭ or F.

(K. S.)

PICCOLOMINI, the name of an Italian noble family, which was prominent in Siena (q.v.) from the beginning of the 13th century onwards. In 1220 Enghelberto d'Ugo Piccolomini received the fief of Montetari in Val d'Orcia from the emperor Frederick II. as a reward for services rendered. The family acquired houses and towers in Siena and outposts in the republic's territory, including Montone and Castiglione, the latter they sold to the commune in 1321. They obtained great wealth through trade, and established counting-houses in Genoa, Venice, Aquileia, Trieste, and in various cities of France and Germany. Supporters of the Guelph cause in the civil broils by which Siena was torn, they were driven from the city in the time of Manfred and their houses demolished; they returned in triumph after the Angevin victories, were expelled once more during the brief

reign of Conradin, and again returned to Siena with the help of Charles of Anjou. But through their riotous political activity the Piccolomini lost their commercial influence, which passed into the hands of the Florentines, although they retained their palaces, castles and about twenty fiefs, some of which were in the territory of Amalfi and of great extent. Many members of the house were distinguished ecclesiastics, generals and statesmen in Siena and elsewhere; two of them were popes, viz. Aeneas Silvius Piccolomini (Pius II., q.v.) and Francesco Piccolomini (Pius III., q.v.).

See Richter, *Die Piccolomini* (Berlin, 1874); A. Lisini and A. Liberati, *Albero della famiglia Piccolomini* (Siena, 1899); and articles by A. Lisini in the *Miscellanea storica senese*, 3rd series 12, and 4th series, 17 and 189.

PICCOLOMINI, OCTAVIO, PRINCE (1590-1656), duke of Amalfi, Austrian general, was born on the 11th of November 1599 in Florence, and carried a pike in the Spanish service at the age of sixteen. Two years later, on the outbreak of the Thirty Years' War in Bohemia, he was appointed a captain in a cavalry regiment sent by the grand duke of Tuscany to the emperor's army, and he fought with some distinction under Bucquoy at the Weisser Berg and in Hungary. In 1624 he served for a short time in the Spanish army and then as lieutenant-colonel of Pappenheim's cuirassier regiment in the war in the Milanese. In 1627 he re-entered the Imperial service as colonel and captain of the lifeguard of Wallenstein, duke of Friedland. In this capacity he soon fell into disgrace for practising extortion at Stargard in Pomerania, but his adroitness secured him, after no long interval, the rank of "colonel of horse and foot." About this time the appointment of his younger brother to the archbishopric of Siena secured him a position of influence in the diplomatic world. Diplomatic talent was indeed almost the birthright of a member of an Italian family, that had seen two of its members occupying the papal chair, and Wallenstein freely made use of his subordinate's capacity for negotiation and intrigue. In the events of the Mantuan War Piccolomini took a prominent part in the dual rôle of the subtle diplomatist and the plundering soldier of fortune. At this moment came the invasion of Ferrara by Gustavus Adolphus. Piccolomini was interned at Ferrara as a hostage for the ratification of a treaty, but he added his voice to the general call for Wallenstein's reappointment as commander-in-chief. He was not, however, included in the list of promotions that followed the duke's reappearance, and he served under General Holk, an officer brought in from the Danish service, in the preliminary operations and in the battle of Lützen. His ambition was gratified when, on reading the official report of the battle, the emperor made him a *generalfeldwachtmeister*. At the same time, however, Holk was created a field marshal at Wallenstein's instance, much to his rival's chagrin. In the campaign of 1633 Piccolomini held the command of an important detachment posted at Königgrätz to bar the enemy's advance from Silesia into Bohemia. History repeated itself on the same ground in 1756, 1778 and 1866; in the first of these cases it was a Piccolomini, grand-nephew of Octavio, who commanded the Austrians; in the last the victorious Prussians passed over the estate of Nachod, which after 1635 was a hereditary possession of the family. In May Wallenstein entered Silesia with the main army with the unavowed object of compelling or persuading the electors of Brandenburg and Saxony to make common cause with the emperor against the Swedes. Piccolomini was with him, and, disapproving of the duke's policy, joined in a military conspiracy, out of which grew the drama that ended with the murder of Wallenstein on the 25th of February 1634. Piccolomini's own part in the tragedy has been set forth for all time in the pages of Schiller's *Wallenstein*. His reward was his marshal's bâton, 100,000 gulden and the beautiful estate of Nachod in the Riesengebirge.

He was Wallenstein's pupil as well as his slayer, and had learned the art of war from that master. On the 5th-6th of September in the same year he distinguished himself amongst the foremost in the great victory of Nördlingen. He soon saw the necessity for following out the lines of military policy laid

down by the duke, but neither he nor Gallas, the new lieutenant-general of the emperor, possessed the capacity for carrying it out, and the war dragged on year after year. Piccolomini was in 1635 allied with a Spanish army, and bitterly complained that their sloth and caution marred every scheme that he formed. In 1638 he was made a count of the empire, and in 1639, having been fortunate enough to win a great victory over the French (relief of Thionville, July 7, 1639), he was rewarded with the office of privy councillor from the emperor and with the dukedom of Amalfi from the king of Spain. But instead of being appointed, as he hoped, Gallas's successor, he was called in to act as *ad latus* to the Archduke Leopold Wilhelm, with whom he was defeated in the second battle of Breitenfeld in 1642. After this he spent some years in the Spanish service and received as his reward the title of grandee and the order of the Golden Fleece. Some years later, having re-entered the Imperial army, he was again disappointed of the chief command by the selection of the brave veteran Peter Melander, Count Holzapfel. But when in 1648 Melander fell in battle at Zusmarshausen, Piccolomini was at last appointed lieutenant-general of the emperor, and thus conducted as generalissimo the final campaign of the weary and desultory Thirty Years' War. Three days after the commission for executing the peace had finished its labours, the emperor addressed a letter of thanks "to the Prince Piccolomini," and awarded him a gift of 114,566 gulden. Piccolomini died on the 11th of August 1656. He left no children (his only son Josef Silvio, the "Max" of Schiller's *Wallenstein*, was murdered by the Swedes after the battle of Jankau in 1645), and his titles and estates passed to his brother's son. With the death of the latter's nephew Octavio Aeneas Josef in 1757, the line became extinct.

PICENE. $C_{12}H_{14}$, a hydrocarbon found in the pitchy residue obtained in the distillation of peat-tar and of petroleum. This is distilled to dryness and the distillate repeatedly recrystallized from cymene. It may be synthetically prepared by the action of anhydrous aluminium chloride on a mixture of naphthalene and ethylene dibromide (R. Lespieau, *Bull. soc. chim.*, 1891, (3), 6, p. 238), or by distilling α -dinaphthostilbene (T. Hirn, *Ber.*, 1899, 32, p. 3341). It crystallizes in large colourless plates which possess a blue fluorescence. It is soluble in concentrated sulphuric acid with a green colour. Chromic acid in glacial acetic acid solution oxidizes it to picene-quinone, picene-quinone carboxylic acid, and finally to phthalic acid. When heated with hydriodic acid and phosphorus it forms hydrides of composition $C_{12}H_{14}$ and $C_{12}H_{16}$ (see E. Bamberger and F. D. Chattaway, *Ann.*, 1895, 284, p. 61).

PICENUM, a district of ancient Italy, situated between the Apennines and the Adriatic, bounded N. by the Senones and S. by the Vestini. The inhabitants were, according to tradition, an offshoot of the Sabines. Strabo (v. 4, 1) gives the story of their migration, led by a woodpecker (*picus*), a bird sacred to Mars, from which they derived their name Picentini (cf. Dion Hal. l. 14, 5), just as the Hirpini derived theirs from *hirpus*, a wolf. The district was conquered by the Romans early in the 3rd century B.C. and the whole territory was divided up among Latin-speaking settlers by the Lex Flaminia in 232 B.C. Hence we have very scanty records of any non-Latin language that may have been spoken in the district before the 3rd century. Besides the problematic inscriptions from Belmonte, Nereto and Cupra Maritima (see SABELLIĆ), we have one or two Latin inscriptions (probably of the 2nd or even the 1st century B.C.) which contain certain forms showing a distinct affinity with the dialect of Iguvium (cf. the name *Paśid*=Latin *Pacidi*). Hence there seems some ground for believing that the population which the Romans dispossessed, or held in subjection, really spoke a dialect very much like that of their neighbours in Umbria.

For inscriptions, see R. S. Conway, *The Italic Dialects*, p. 449, where the place-names and personal names of the district will also be found; see further, Livy, *Epit.* xv.; B. V. Head, *Historia nummorum*, p. 19.

It was in Picenum, at Asculum, that the Social War broke out in 90 B.C. At the end of the war the district became connected with Pompeius Strabo, and his son Pompey the Great threw into

the scale on the side of Sulla, in 83 B.C., all the influence he possessed there, and hoped to make it a base against Caesar's legions in 49 B.C. Under Augustus it formed the fifth region of Italy, and included twenty-three independent communities, of which five, Ancona, Firmum, Asculum, Hadria and Interamna, were *coloniae*. It was reached from Rome by the Via Salaria, and its branch the Via Caecilia. It was also on a branch leading from the Via Flaminia at Nuceria Camellaria to Septempeda. There were also communications from north to south; a road led from Asculum to Urbs Salvia and Ancona, another from Asculum and Firmum and the coast, another from Urbs Salvia to Potentia, while finally along the whole line of the coast there ran a prolongation of the Via Flaminia, the name of which is not known to us.

At the end of the 2nd century A.D. the north-eastern portion of Umbria was divided from the rest and acquired the name Flaminia, from the high road. For the time it remained united with Umbria for administrative purposes, but passed to Picenum at latest in the time of Constantine, and acquired the name of *Flaminia et Picenum Annonarium*, the main portion of Picenum being distinguished as *Suburbicarium*. In an inscription of A.D. 390 Ravenna is actually spoken of as the chief town of Picenum. When the exarchate of Ravenna was founded the part of Picenum Annonarium near the sea became the Pentapolis Maritima, which included the five cities of Ariminum, Pisaurum, Fanum Fortunae, Sena Gallica and Ancona. The exarchate was seized by Luitprand in 727, and Ravenna itself was taken by Aistulf in 752. In the next year, however, the Emperor Pippin took it from him and handed it over to the pope, a grant confirmed by his son Charlemagne. (T. AS.)

PICHEGRU, CHARLES (1761-1804), French general, was born at Arbois, or, according to Charles Nodier, at Les Planches, near Lons-le-Saunier, on the 16th of February 1761. His father was a labourer, but the friars of Arbois gave the boy a good education, and one of his masters, the Pere Partault, took him to the military school of Brienne. In 1783 he entered the first regiment of artillery, where he rapidly rose to the rank of adjutant-sub-lieutenant. When the Revolution began he became leader of the Jacobin party in Besançon, and when a regiment of volunteers of the department of the Gard marched through the city he was elected lieutenant-colonel. The fine condition of his regiment was soon remarked in the army of the Rhine, and his organizing ability was made use of by an appointment on the staff, and finally by his promotion to the rank of general of brigade. In 1793 Carnot and Saint Just were sent to find *roturier* generals who could be successful, Carnot discovered Jourdan, and Saint Just discovered Hoche and Pichegru. In co-operation with Hoche and the army of the Moselle, Pichegru, now general of division and in command of the army of the Rhine, had to reconquer Alsace and to reorganize the disheartened troops of the republic. They succeeded, Pichegru made use of the *élan* of his soldiers to win innumerable small engagements, and with Hoche forced the lines of Haguenau and relieved Landau. In December 1793 Hoche was arrested, it is said owing in part to his colleague's machinations, and Pichegru became commander-in-chief of the army of the Rhine-and-Moselle, whence he was summoned to succeed Jourdan in the army of the North in February 1794. It was now that he fought his three great campaigns of one year. The English and Austrians held a strong position along the Sambre to the sea. After vainly attempting to break the Austrian centre, Pichegru suddenly turned their left, and defeated Clerfayt at Cassel, Menin and Courtrai, while Moreau, his second in command, defeated Coburg at Tourcoing in May 1794; then after a pause, during which Pichegru feigned to besiege Ypres, he again dashed at Clerfayt and defeated him at Rouselaer and Hoogdele, while Jourdan came up with the new army of the Sambre-and-Meuse, and utterly routed the Austrians at Fleurus on the 27th of June 1794. Pichegru began his second campaign by crossing the Meuse on the 18th of October, and after taking Nijmegen drove the Austrians beyond the Rhine. Then, instead of going into winter-quarters, he prepared his army for a winter

campaign. On the 28th of December he crossed the Meuse on the ice, and stormed the island of Bommel, then crossed the Waal in the same manner, and, driving the English before him, entered Utrecht on the 19th of January, and Amsterdam on the 20th of January, and soon occupied the whole of Holland. This grand feat of arms was marked by many points of interest, such as the capture of the Dutch ships, which were frozen in the Helder, by the French hussars, and the splendid discipline of the ragged battalions in Amsterdam, who, with the richest city of the continent to sack, yet behaved with a self-restraint which few revolutionary and Napoleonic armies attained. The former friend of Saint Just now offered his services to the Thermidorians, and after receiving from the Convention the title of "Sauveur de la Patrie," subdued the *sans-culottes* of Paris, when they rose in insurrection against the Convention on 12 Germinal (April 1). Pichegru then took command of the armies of the North, the Sambre-and-Meuse, and the Rhine, and crossing the Rhine in force took Mannheim in May 1795. When his fame was at its height he allowed his colleague Jourdan to be beaten, betrayed all his plans to the enemy, and took part in organizing a conspiracy for the return of Louis XVIII., in which he was to play, for his own aggrandizement, the part that Monk played from higher motives in the English revolution. His intrigues were suspected, and when he offered his resignation to the Directory in October 1795 it was to his surprise promptly accepted. He retired in disgrace, but hoped to serve the royalist cause by securing his election to the Council of Five Hundred in May 1797. He was there the royalist leader, and planned a *coup d'état*, but on the 18th Fructidor he was arrested, and with fourteen others deported to Cayenne in 1797. Escaping, he reached London in 1798, and served on General Korsakov's staff in the campaign of 1799. He went to Paris in August 1803 with Georges Cadoudal to head a royalist rising against Napoleon; but, betrayed by a friend, he was arrested on the 28th of February 1804, and on the 15th of April was found strangled in prison. It has often been asserted that he was murdered by the orders of Napoleon, but there is no foundation for the story.

Pichegru's campaigns of 1794 are marked by traits of an audacious genius which would not have disgraced Napoleon. His tremendous physical strength, the personal ascendancy he gained by this and by his powers of command made him a peculiarly formidable opponent, and thus enabled him to maintain a discipline which guaranteed the punctual execution of his orders. He had also, strangely enough, the power of captivating honest men like Moreau. He flattered in turn Saint Just and the Terrorists, the Thermidorians and the Directors, and played always for his own hand—a strange egoist who rose to fame as the leader of an idealist and sentimental crusade.

There is no really good life of Pichegru, perhaps the best is J. M. Cassier's *Vie du général Pichegru* (Paris, 1815). For his treason, trial and death, consult Montgaillard's *Mémoires concernant la trahison de Pichegru* (1804); Fauche-Borel's *Mémoires*; Savary, *Mémoires sur la mort de Pichegru* (Paris, 1825); and G. Pierret, *Pichegru, son procès et sa mort* (1826).

PICHLER, KAROLINE (1769-1843), Austrian novelist, was born at Vienna on the 7th of September 1769, the daughter of Hofrat Franz von Greiner, and married, in 1796, Andreas Pichler, a government official. For many years her salon was the centre of the literary life in the Austrian capital, where she died on the 9th of July 1843. Her early works, *Oliver*, first published anonymously (1802), *Idyllen* (1803) and *Ruth* (1805), though displaying considerable talent, were immature. She made her mark in historical romance, and the first of her novels of this class, *Agathocles* (1808), an answer to Gibbon's attack on that hero in the *Decline and Fall of the Roman Empire*, attained great popularity. Among her other novels may be mentioned *Die Belagerung Wiens* (1824); *Die Schweden in Prag* (1827); *Die Wiedereroberung Ojens* (1829) and *Henriette von England* (1832). Her last work was *Zeitsbilder* (1840).

The edition of Karoline Pichler's *Sämmtliche Werke* (1820-1845) comprises no less than 60 volumes. Her *Denkwürdigkeiten aus meinem Leben* (4 vols.) was published posthumously in 1844. A

selection of her narratives, *Ausgewählte Erzählungen*, appeared in 4 vols. in 1894.

PICKENS, ANDREW (1739-1817), American soldier in the War of Independence, was born in Paxton, Bucks county, Pennsylvania, on the 19th of September 1739. His family settled at the Waxhaws (in what is now Lancaster county), South Carolina, in 1752. He fought against the Cherokees in 1761 as a lieutenant. In the War of Independence he rose to brigadier-general (after Cowpens) in the South Carolina militia. He was a captain among the American troops which surrendered at Ninety Six in November 1775. On the 14th of February 1779, with 300-400 men, he surprised and defeated about 700 Loyalists under Colonel Boyd on Kettle Creek, Wilkes county, Georgia; on the 20th of June he fought at Stono Ferry, and later in the same year at Tomassce defeated the Cherokees, who were allied with the British. Upon the surrender of Charleston (May 1780) he became a prisoner on parole, which he observed rigidly until, contrary to the promises made to him, Major James Dunlap plundered his plantation, he then returned to active service. His command (about 150 men) joined General Daniel Morgan immediately before the battle of Cowpens, in which Pickens commanded an advance guard (270-350 men from Georgia and North Carolina) and twice rallied the broken American militia; for his services Congress gave him a sword. With Colonel Henry Lee he harassed Lieut.-Colonel Banastre Tarleton, who was attempting to gather a Loyalist force just before the battle of Guilford Court House; and with Lee and others, he captured Augusta (June 5, 1781) after a siege. At Eutaw Springs (Sept. 8, 1781) he commanded the left wing and was wounded. In 1782 he defeated the Cherokees again and forced them to surrender all lands south of the Savannah and east of the Chattahoochee. After the war he was a member of the South Carolina House of Representatives for a number of years, of the state Constitutional Convention in 1790, and of the National House of Representatives in 1793-1795. He died in Pendleton district, South Carolina, on the 17th of August 1817. He had married in 1765 Rebecca Calhoun, an aunt of John C. Calhoun. Their son, ANDREW PICKENS (1779-1838), served as a lieutenant-colonel in the War of 1812, and was governor of South Carolina in 1816-1818.

PICKENS, FRANCIS WILKINSON (1805-1869), American politician, was born in Togodoo, St Paul's parish, South Carolina, on the 7th of April 1805, son of Andrew Pickens (1779-1838) and grandson of General Andrew Pickens (1739-1817). He was educated at Franklin College, Athens, Georgia, and at South Carolina College, Columbia, and was admitted to the bar in 1829. In 1832 he was elected to the state House of Representatives, where, as chairman of a sub-committee, he submitted a report denying the right of Congress to exercise any control over the states. He was a Democratic member of the National House of Representatives in 1834-1843, served in the South Carolina Senate in 1844-1845, was a delegate to the Nashville Southern Convention (see NASHVILLE, TENNESSEE) in 1850, was United States minister to Russia in 1858-1860, and in 1860-1862 was governor of South Carolina. He strongly advocated the secession of the Southern states; signed the South Carolina ordinance of secession; protested against Major Robert Anderson's removal from Fort Moultrie to Fort Sumter; sanctioned the firing upon the "Star of the West" (Jan. 9, 1861), which was bringing supplies to Anderson, and the bombardment of Fort Sumter; and was a zealous supporter of the Confederate cause. At the close of his term he retired to his home at Edgefield, South Carolina, where he died on the 25th of January 1869.

PICKERING, EDWARD CHARLES (1846-), American physicist and astronomer, was born in Boston on the 19th of July 1846. He graduated in 1865 at the Lawrence Scientific School of Harvard, where for the next two years he was a teacher of mathematics. Subsequently he became professor of physics at the Massachusetts Institute of Technology, and in 1876 he was appointed professor of astronomy and director of the Harvard College observatory. In 1877 he decided to

devote one of the telescopes of the observatory to stellar photometry, and after an exhaustive trial of various forms of photometers, he devised the meridian photometer (see PHOTOMETRY, STELLAR), which seemed to be free from most of the sources of error. With the first instrument of this kind, having objectives of 1.5 inch aperture, he measured the brightness of 4260 stars, including all stars down to the 6th magnitude between the North Pole and -30° declination. With the object of reaching fainter stars, Professor Pickering constructed another instrument of larger dimensions, and with this more than a million observations have been made. The first important work undertaken with it was a revision of the magnitudes given in the Bonn *Durchmusterung*. On the completion of this, Professor Pickering decided to undertake the survey of the southern hemisphere. An expedition, under the direction of Prof. S. I. Bailey, was accordingly despatched (1889), and the meridian photometer erected successively in three different positions on the slopes of the Andes. The third of these was Arequipa, at which a permanent branch of the Harvard Observatory is now located. The magnitudes of nearly 8000 southern stars were determined, including 1428 stars of the 6th magnitude and brighter. The instrument was then returned to Cambridge (U.S.A.), where the survey extended so as to include all stars of magnitude 7.5 down to -40° declination, after which it was once more sent back to Arequipa. In 1886 the widow of Henry Draper, one of the pioneers of stellar spectroscopy, made a liberal provision for carrying on spectroscopic investigations at Harvard College in memory of her husband. With Professor Pickering's usual comprehensiveness, the inquiry was so arranged as to cover the whole sky, and with four telescopes—two at Cambridge for the northern hemisphere, and two at Arequipa in Peru for the southern—to which a fine 24-in. photographic telescope was afterwards added, no fewer than 75,000 photographs had been obtained up to the beginning of 1901. These investigations have yielded many important discoveries, not only of new stars, and of large numbers of variable stars, but also of a wholly new class of double stars whose binary character is only revealed by peculiarities in their spectra. The important conclusion has been already derived that the majority of the stars in the Milky Way belong to one special type.

PICKERING, TIMOTHY (1745-1829), American politician, was born at Salem, Massachusetts, on the 17th of July 1745. He graduated from Harvard College in 1763 and was admitted to the bar in 1768. In the pre-revolutionary controversies he identified himself with the American Whigs; in 1773 he prepared for Salem a paper entitled *State of the Rights of the Colonists*; in 1775 he drafted a memorial protesting against the Boston Port Bill; and in 1776 he was a representative from Salem in the General Court of Massachusetts. In 1766 he had been commissioned lieutenant and in 1769 captain in the Essex county militia; early in 1775 he published *An Easy Plan of Discipline for a Militia*, adopted in May 1776 by the General Court for use by the militia of Massachusetts, and he was elected colonel of his regiment. In the same year he became judge of the court of common pleas for Essex county, and sole judge of the maritime court for the counties of Suffolk, Essex and Middlesex. In the winter of 1776-1777 he led an Essex regiment of volunteers to New York, and he subsequently served as adjutant-general (June 1777-Jan. 1778) and later as quartermaster-general (1780-1785); he was also a member of the board of war from the 7th of November 1777 until its abolition. With the aid of some officers he drew up, in April 1783, a plan for the settlement of the North-West territory, which provided for the exclusion of slavery. In 1785 he became a commission merchant in Philadelphia; but in October 1786, soon after the legislature of Pennsylvania had passed a bill for erecting Wyoming district into the county of Luzerne, he was appointed prothonotary and a judge of the court of common pleas and clerk of the court of sessions and orphans' court for the new county, and was commissioned to organize the county. He offered to purchase for himself the Connecticut title to a farm, and in the following year he was appointed a member of a commission to settle claims

according to the terms of an act, of which he was the author, confirming the Connecticut titles (see WYOMING VALLEY and WILKES-BARRÉ). Pickering was a member of the Pennsylvania convention of 1787 which ratified the Federal constitution, and of the Pennsylvania constitutional convention of 1789-1790. In November 1790 he negotiated a peace with the Seneca Indians, and he concluded treaties with the Six Nations in July 1791, in March 1792 and in November 1794. Under Washington he was postmaster-general (1791-1795), secretary of war (1795), and after December 1795 secretary of state, to which position he was reappointed (1797) by Adams. In 1783, while he was quartermaster-general, he had presented a plan for a military academy at West Point, and now, as secretary of war, he supervised the West Point military post with a view to its conversion into a military academy. As head of the state department he soon came into conflict with Adams. His hatred of France made it impossible for him to sympathize with the president's efforts to settle the differences with that country on a peaceable basis. He used all his influence to hamper the president and to advance the political interests of Alexander Hamilton, until he was dismissed, after refusing to resign, in May 1800. Returning to Massachusetts, he served as chief justice of the court of common pleas of Essex county in 1802-1803. He was a United States senator in 1803-1811 and a member of the Federal House of Representatives in 1813-1817. As an ultra Federalist—he was a prominent member of the group known as the Essex Junto—he strongly opposed the purchase of Louisiana and the War of 1812. He died at Salem, Massachusetts, on the 20th of January 1829.

The standard biography is that by his son, Octavius Pickering (1791-1868), and C. W. Upham, *The Life of Timothy Pickering* (4 vols., Boston, 1867-1873). In the library of the Massachusetts Historical Society at Boston, there are sixty-two manuscript volumes of the Pickering papers, an index to which was published in the *Collectors of the society*, 6th series, vol. viii. (Boston, 1896).

His son, JOHN PICKERING (1777-1846), graduated at Harvard in 1796, studied law and was private secretary to William Smith, United States minister to Portugal, in 1797-1799, and to Rufus King, minister to Great Britain, in 1799-1801. He practised law in Salem and (after 1827) in Boston, where he was city solicitor in 1827-1846, and wrote much on law and especially on the languages of the North-American Indians. He was a founder of the American Oriental Society, and published an excellent *Comprehensive Dictionary of the Greek Language* (1826).

See Mary O. Pickering (his daughter), *Life of John Pickering* (Boston, 1887).

Timothy Pickering's grandson, CHARLES PICKERING (1805-1878), graduated at Harvard College in 1823 and at the Harvard Medical School in 1826, practised medicine in Philadelphia, was naturalist to the Wilkes exploring expedition of 1838-1842, and in 1843-1845 travelled in East Africa and India. He wrote *The Races of Man and their Geographical Distribution* (1848), *Geographical Distribution of Animals and Man* (1854), *Geographical Distribution of Plants* (1861) and *Chronological History of Plants* (1879).

PICKERING, a market town in the Whitby parliamentary division of the North Riding of Yorkshire, England, 32 m. N.E. by N. from York by the North Eastern railway, the junction of several branch lines. Pop. of urban district (1901), 3491. The church of St Peter is Norman and transitional Norman, with later additions including a Decorated spire. It contains a remarkable series of mural paintings of the 15th century. The castle, on a hill to the north, is a picturesque ruin, the fragmentary keep and several towers remaining. The work is in part Norman, but the principal portions are of the 14th century. One of the towers is connected in name and story with Fair Rosamond. The castle was held by Earl Morcar shortly before the Conquest; it then came into the hands of the Crown, and subsequently passed to the duchy of Lancaster. It was the prison of Richard II. before his confinement at Pontefract. During the civil wars of the 17th century the castle was held by the Royalists, and suffered greatly in siege. The district

surrounding Pickering is agricultural, and the town is a centre of the trade. Agricultural implements are manufactured, and limestone and freestone are quarried in the vicinity.

PICKET, PIQUET or PICQUET (Fr. *piquet*, a pointed stake or peg, from *piquer*, to point or pierce), a military term, signifying an outpost or guard, supposed to have originated in the French army about 1690, from the circumstance that an infantry company on outpost duty dispersed its musketeers to watch, the small group of pikemen called *piquet* remaining in reserve. Thus at the present day the word "picquet" is, in Great Britain at any rate, restricted to an infantry post on the outpost line, from which the sentries or "groups" of watchers are sent out. In the United States a "picket" is synonymous with a sentry, and the "picket-line" is the extreme advanced line of observation of an army. In the French army picquets are called "grand' gardes," and the phrase "grand guard" is often met with in English military works of the 17th and 18th centuries. A body of soldiers held in readiness for military or police duties within the limits of a camp or barracks is also called a picquet or "inlying picquet." These special uses of the word in English are apparently quite modern (after about 1750). "Picket" in its ordinary meaning of a peg or stake, has always been in common military use, being applied variously to the picketing pegs in horse-lines, to long pointed stakes employed in palisades or stockades, to straight thin rods used for marking out the line of fire for guns, &c. Of the various spellings "picquet" is officially adopted in Great Britain and "picket" in the United States, but the latter is now invariably used when a peg or stake is meant.

Two obsolete meanings of the word should also be mentioned. The "picket" was a form of military punishment in vogue in the 16th and 17th centuries, which consisted in the offender being forced to stand on the narrow flat top of a peg for a period of time. The punishment died out in the 18th century and was so far unfamiliar by 1800 that Sir Thomas Picton, who ordered a mulatto woman to be so punished, was accused by public opinion in England of inflicting a torture akin to impalement. It was thought, in fact, that the prisoner was forced to stand on the head of a pointed stake, and this error is repeated in the *New English Dictionary*. In the middle of the 19th century, when elongated rifle bullets were a novelty, they were often, and especially in America, called pickets. The ordinary military use of the word gives rise to compound forms such as "picket boat" or "picket launch," large steam launch or pinnace fitted with guns and torpedoes, and employed for watching the waters of harbours, &c. For picketing in strikes, &c., see below.

PICKETING, a term used to describe a practice resorted to by workmen engaged in trade disputes, of placing one or more men near the works of the employer with whom the dispute is pending, with the object of drawing off his hands or acquiring information useful for the purposes of the dispute. In England, under the Conspiracy and Protection of Property Act 1875, it is an offence wrongfully and without legal authority to watch or beset the house or place where another resides or works, or carries on business or happens to be, or the approach to such house or place, if the object of the watching, &c., is to compel the person watched, &c., to abstain from doing or to do an act which he is legally entitled to do or to abstain from doing (§ 7). The definition of the offence was qualified by a proviso excluding from punishment those who attend at or near a house or place merely to obtain or communicate information, in other words what is termed peaceful picketing, without intimidation, molestation or direct efforts to influence the course of a trade dispute. This enactment led to a great deal of litigation between trade unions and employers; and trade unions were in some instances restrained by injunction from picketing the works of employers. The decisions of the courts upon this subject met with severe criticism from the leaders of trade unions, and by the Trades Disputes Act 1906 the proviso above quoted was repealed, and it was declared lawful for one or more persons acting for themselves or for a trade union or for an individual employer to attend at or near a house, &c., "if the attendance is merely for the

purpose of peacefully obtaining or communicating information or of peacefully persuading any person to work or abstain from working." The exact effect of this change in the law has not yet been determined by the courts, but during the Belfast carters' strike of 1907 serious riots ensued upon the efforts of the authorities to counteract the interference with lawful business caused by free use of picketing. The change in the law is supplemented by provisions forbidding actions against trade unions in respect of any tortious acts alleged to have been committed by or on behalf of the union.

PICKLE. In the wider sense the term "pickle" is applied to any saline or acid preservative solution; in the narrower to vegetables preserved in vinegar. The word appears to be an adaptation of Dutch *pekel*, brine, pickle; cf. Ger. *Pökel*. The ultimate origin is unknown; connexions with a supposed inventor's name, such as *Benckeler* or *Böckel* are mere inventions. A solution of copper or zinc sulphate is used as a "pickle" for railway-sleepers or other wood, a brine containing salt and saltpetre as a preservative for meat, lime-water as "pickle" for eggs. Domestic pickles are made from small cucumbers, onions, cauliflowers, cabbages, mangoes and unripe walnuts, by either steeping or boiling them in salt-brine and vinegar. On account of the large proportion of water natural to these vegetables, only the strongest vinegar, containing from 5 to 6% of acetic acid, can be used. For the better kinds vinegar made from malted or unmalted barley is as a rule employed, for cheaper varieties simply dilute acetic acid obtained from acetate of lime. Sauces such as Worcestershire sauce, or Yorkshire relish, consist of fluid pickles, that is of salted and variously spiced vinegar solutions or emulsions containing tissue of vegetables (tomatoes, mushrooms, &c.), or of fish (sardines or anchovies).

PICKNELL, WILLIAM LAMB (1854-1897), American landscape-painter, was born at Hinesburg, Vermont, on the 23rd of October 1854. He was a pupil of George Inness in Rome for two years, and of J. L. Gérôme in the *École des Beaux Arts*, Paris. With Robert Wylie he worked for several years in Brittany, at Pont Aven and Concarneau, where he painted his "Route de Concarneau" (Cotocorn Art Gallery, Washington, D.C.). His "Morning on the Loing" received a gold medal at the Paris Salon of 1895. In 1880 he became a member of the Society of American Artists, and in 1891 an associate of the National Academy of Design. He died at Marblehead, Massachusetts, on the 8th of August 1897.

PICNIC, a form of entertainment in which the guests are invited to join an excursion to some place where a meal can be taken in the open air. During the first half of the 19th century the essential of a picnic was that the guests should each bring with them a contribution of provisions. At the beginning of the 19th century a society was formed in London called the "Picnic Society," the members of which supped at the Pantheon in Oxford Street, and drew lots as to what part of the meal each should supply (see L. Melville, *The Beaux of the Regency*, 1908, i. 222). The French form *pique-nique* is said to be of recent introduction in 1692 (*Ménage, Dict. etym.*). It is doubtful whether picnic is merely a rhyming word, or can be referred to *pique*, pick, and *nique*, small coin.

PICO, an island in the Atlantic Ocean, belonging to Portugal, and forming part of the Azores archipelago. Pop. (1900), 24,028; area 175 sq. m. Pico is a conical mountain, rising to the height of 7612 ft. The soil consists entirely of pulverized lava. The so-called Fayal wine, though named after an adjacent island, was formerly produced here, and largely exported to Europe. But in 1852 the vines were attacked by the *Oidium* fungus and completely destroyed, while the orange-trees suffered almost as much from the *Coccus hesperidum*. The people were consequently forced to emigrate in great numbers, till the planting of fig-trees and apricots alleviated the evil. Pico also produces a species of wood resembling mahogany, and equal in quality to it. Its chief town is Lagens do Pico. Pop. (1975).

PICO DELLA MIRANDOLA, GIOVANNI, COUNT (1463-1494), Italian philosopher and writer, the youngest son of Giovanni

Francesco Pico, prince of Mirandola, a small territory about 30 Italian miles west of Ferrara, afterwards absorbed in the duchy of Modena, was born on the 24th of February 1463. The family was illustrious and wealthy, and claimed descent from Constantine. In his fourteenth year Pico went to Bologna, where he studied for two years, and was much occupied with the Decretals. The traditional studies of the place, however, disgusted him; and he spent seven years wandering through all the schools of Italy and France and collecting a precious library. Besides Greek and Latin he knew Hebrew, Chaldee and Arabic; and his Hebrew teachers (Elijah del Medigo, Leo Abarbanel and Jochanan Aleman—see *L. Geiger Johann Reuchlin* (1871), p. 167) introduced him to the Kabbalah, which had great fascinations for one who loved all mystic and theosophic speculation. His learned wanderings ended (1486) at Rome, where he set forth for public disputation a list of nine hundred questions and conclusions in all branches of philosophy and theology. He remained a year in Rome, but the disputation he proposed was never held. The pope prohibited the little book in which they were contained, and Pico had to defend the impugned theses (*De omni re scibili*) in an elaborate *Apologia*. His personal orthodoxy was, however, subsequently vindicated by a brief of Alexander VI., dated 18th June 1493. The suspected theses included such points as the following: that Christ descended *ad inferos* not in His real presence but *quoad effectum*; that no image or cross should receive *latreia* even in the sense allowed by Thomas; that it is more reasonable to regard Origen as saved than as damned; that it is not in a man's free will to believe or disbelieve an article of faith as he pleases. But perhaps the most startling thesis was that no science gives surer conviction of the divinity of Christ than "magia" (*i.e.* the knowledge of the secrets of the heavenly bodies) and Kabbalah. Pico was the first to seek in the Kabbalah a proof of the Christian mysteries and it was by him that Reuchlin was led into the same delusive path.

Pico had been up to this time a gay Italian nobleman; he was tall, handsome, fair-complexioned, with keen grey eyes and yellow hair, and a great favourite with women. But his troubles led him to more serious thoughts; and he published, in his 28th year, the *Heptaplus*, a mystical exposition of the creation. Next he planned a great seven-fold work against the enemies of the Church, of which only the section directed against astrology was completed. After leaving Rome he again lived a wandering life, often visiting Florence, to which he was drawn by his friends Politian and Marsilius Ficinus, and where also he came under the influence of Savonarola. It was at Florence that he died on the 17th of November 1494. Three years before his death he parted with his share of the ancestral principality, and designed, when certain literary plans were completed, to give away all he had and wander barefoot through the world preaching Christ. But these plans were cut short by a fever which carried him off just at the time when Charles VIII. was at Florence.

Pico's works cannot now be read with much interest, but the man himself is still interesting, partly from his influence on Reuchlin and partly from the spectacle of a truly devout mind in the brilliant circle of half-pagan scholars of the Florentine renaissance.

His works were published at Bologna in 1496 by his nephew, Giov. Fran. Pico, with a biography, which was translated by Sir Thomas More as *Life of John Pico, Earl of Mirandola*, in 1510. See the essay in Walter Pater's *Renaissance* (1878); and the study by J. Rigg, prefixed to the reprint of *More's Life* in the Tudor Library (London, 1890).

PICRIC ACID, or TRINITROPHENOL, $C_6H_2(OH)(NO_2)_3$ [1.2.4.6], an explosive and dyestuff formed by the action of concentrated nitric acid on indigo, aniline, resins, silk, wool, leather, &c. It is the final product of the direct nitration of phenol, and is usually prepared by the nitration of the mixture of phenol sulphonic acids obtained by heating phenol with concentrated sulphuric acid (E. Eisenmann and A. Arche, Eng. pat., 4539 (1880)). It may also be obtained by oxidizing the symmetrical trinitrobenzene with potassium

ferricyanide in alkaline solution (P. Hepp, *Ann.* 1882, 215, p. 352). It crystallizes from water in yellow plates melting at 122.5° C., which sublime on careful heating, but explode when rapidly heated. It is poisonous and possesses a bitter taste, hence its name from the Greek *ρυχρός*, bitter. It has a strongly acid reaction, being almost comparable with the carboxylic acids. By the action of bleaching powder it is converted into chlorpicrin, CCl_3NO_2 . Phosphorus pentachloride converts it into picryl chloride, $C_6H_2Cl(NO_2)_3$, which is a true acid chloride, being decomposed by water with the regeneration of picric acid and the formation of hydrochloric acid; with ammonia it yields *picramide*, $C_6H_7NH_2(NO_2)_3$. Silver picrate and methyl iodide yield the methyl ester, which gives with ammonia picramide. Picric acid forms many well-defined salts, of a yellow or red-brown colour. It also yields crystalline compounds with many aromatic hydrocarbons and bases. It imparts a yellow colour to wool and silk. The chief application of picric acid and its salts is in the manufacture of explosives. When ignited, picric acid burns quietly with a smoky flame, and it is very difficult to detonate by percussion; its salts, however, are more readily detonated. The more important picric powders are *melinite*, believed to be a mixture of fused picric acid and gun-cotton; *lyddite*, the British service explosive, and *shimose*, the Japanese powder, both supposed to be identical with the original melinite; *Brugère's powder*, a mixture of 54 parts of ammonium picrate and 45 parts of saltpetre; *Designolle's powder*, composed of potassium picrate, saltpetre and charcoal; and *emmensite*, invented by Stephen Emmens, of the United States.

It may be detected by the addition of an aqueous solution of potassium cyanide, with which it gives a violet-red coloration, due to the formation of isopurpuric acid. R. Anschutz (*Ber.*, 1884, 17, p. 435) estimates picric acid by precipitation with acridine.

PICRITE (from Gr. *ρυχρός*, bitter, because these rocks are rich in magnesia, a base which forms bitter salts), a rock belonging to the ultrabasic group, and consisting mainly of olivine and augite often with hornblende and biotite and a greater or less amount of plagioclase feldspar. The picrites are of "hypabyssal" origin and in their natural occurrence are connected with dolerites (diabases and teschenites). The distinction between them and the peridotites, which have an essentially similar composition, is not easy to define, but the peridotites accompany the true plutonic rocks, such as gabbro, norite and pyroxenite, are often very coarsely crystalline, and form large bosses and laccolites, while the picrites usually are found in sills or intrusive sheets.

In hand specimens the picrites are dark green to black; the absence or scarcity of lath-shaped plagioclase feldspars distinguishes them from diabases and they rarely have the lustre-mottling which is a characteristic of the peridotites. Since they contain much olivine they readily decompose, passing into deep green and brown incoherent masses in which are embedded rounded lumps of harder consistency. They have a high specific gravity (about 3.0) and may be distinctly magnetic, because they are rich in iron ores. Porphyritic structure is rare though occurring sometimes in the rocks known as picrite-porphyrates; the phenocrysts are olivine and augite. There is seldom any fine-grained or glassy groundmass, and the typical microstructure is holocrystalline, moderately fine grained and somewhat poikilitic. Olivine is abundant in rounded pale green crystals. It may form one half of the rock but rarely more than this. The augite is generally brown or reddish-brown, sometimes violet, and tends to enclose the olivine, yielding poecilitic aggregates. Brown hornblende often occurs as marginal growths around the pyroxene, and may be so abundant as to replace augite to a large extent; rocks of this class are known as hornblende-picrites. Bright green or pale-green hornblende are less frequently present, and in many cases are really of secondary origin. Deep brown biotite is a frequent accessory mineral and both biotite and hornblende sometimes enclose olivine. A small amount of basic plagioclase occurs in many picrites; apatite, iron oxides, chromite and spinels are minor ingredients seldom altogether absent.

The minerals of picrites are very frequently decomposed. Serpentine partly or wholly replaces olivine, forming radiate fibrous masses which are green, yellow or red in microscopic sections. Sometimes hornblende (pilitite), talc, chlorite and mica appear as secondary products after olivine. The augite passes into chlorite or into green fibrous or platy amphibole. Hornblende and biotite are often fresh when the other components are much altered. The feldspar is rarely in good preservation but yields epidote, prehnite, sericite, kaolin, calcite and analcite are abundant in some weathered picrites.

Rocks of this type are well represented in Great Britain. In the central valley of Scotland several masses of picrite have been discovered, always in close association with olivine-diabase and tescenite. One of these forms the island of Inchcolm in the Firth of Forth, another lies near Bathgate (in Lunlithgowshire), and there are others at Aberdour (Fife), Ardrossan and Barnton (Midlothian). They belong to the great series of Carboniferous eruptive rocks of the Scottish midland valley. These picrites are not known to be represented in England, but, on the other hand, there are Devonian picrites in Devon and Cornwall as basic members of the diabase and proterobase series of these counties. Some of them contain much augite like the picrite (often called palaeopicrite as being of palaeozoic age) at Menheniot Station in Cornwall and the picrite of Highweek near Newton Abbot in Devonshire. Others are hornblende-picrites like that of Cartuther near St Germans, Cornwall. Hornblende-picrite occurs also in the island of Sark and several beautiful examples have been described from Anglesey and from Penarllynnydd in North Wales and from Wicklow in Ireland. Picrites occur in several parts of Germany, notably in the Devonian rocks of the Fichtelgebirge and Nassau, where they accompany diabases and proterobases like those of Cornwall and Devonshire. In Silesia and Moravia picrites are found with tescenites like those of Central Scotland. In some of the continental picrites enstatite is present but is rare. In North America picrites occur among the igneous rocks on the Hudson river and in Alabama and Montana.

(J. S. F.)

PICROTOXIN, a neutral principle obtained from the *Cocculus indicus*, which is the fruit of the *Anamirta paniculata*. It is used in medicine externally as an antiparasitic. Internally it has been successfully used to check the night-sweats of phthisis. In large doses it is a powerful poison, causing unconsciousness, delirium, convulsions, gastro-enteritis and stimulation of the respiratory centre followed by paralysis, from which death sometimes results. Formerly low class publicans sometimes added *Cocculus indicus* berries to beer to increase the intoxicating effects. Its chemical formula is $C_{23}H_{11}O_6 \cdot H_2O$.

PICTET DE LA RIVE, FRANÇOIS JULES (1809-1872), Swiss zoologist and palaeontologist, was born in Geneva on the 27th of September 1809. He graduated B. ès Sc. at Geneva in 1829, and pursued his studies for a short time at Paris, where under the influence of Cuvier, de Blainville and others, he worked at natural history and comparative anatomy. On his return to Geneva in 1830 he assisted A. P. de Candolle by giving demonstrations in comparative anatomy. Five years later, when de Candolle retired, Pictet was appointed professor of zoology and comparative anatomy. In 1846 his duties were restricted to certain branches of zoology, including geology and palaeontology, and these he continued to teach until 1859, when he retired to devote his energies to the museum of natural history and to special palaeontological work. He was rector of the academy from 1847 to 1850, and again from 1866 to 1868. He was for many years a member of the Representative Council of Geneva, and in 1862 President of the Constituent Assembly. His earlier published work related chiefly to entomology, and included *Recherches pour servir à l'histoire et à l'anatomie des Phryganides* (1834) and two parts of *Histoire naturelle, générale et particulière des insectes Neuroptères* (1842-1845). Feeling the want of a hand-book, he prepared his *Traité élémentaire de paléontologie* (4 vols. 1844-1846). In the first edition Pictet, while adopting the hypothesis of successive creations of species, admitted that some may have originated through the modification of pre-existing forms. In his second edition (1853-1857) he enters further into the probable transformation of some species, and discusses the independence of certain faunas, which did not appear to have originated from the types which locally preceded them. He now directed his attention to the fossils of his native country, more especially to those of the Cretaceous and Jurassic

strata, and in 1854 he commenced the publication of his great work, *Matériaux pour la paléontologie suisse*, a series of quarto memoirs, of which six were published (1854-1873). In this work Pictet was aided by E. Renevier, G. Campiche, P. de Loriol and others. Pictet also brought out *Mélanges paléontologiques* (1863-1868). He died at Geneva on the 15th of March 1872.

Obituary by W. S. Dallas, *Quart. Journ. Geol. Soc.* (1873), vol. xxix.

PICTON, SIR THOMAS (1758-1815), British general, was the younger son of Thomas Picton, of Poyston, Pembrokeshire, where he was born in August 1758. In 1771 he obtained an ensign's commission in the 12th regiment of foot, but he did not join until two years afterwards. The regiment was then stationed at Gibraltar, where he remained until he was made captain in the 75th in January 1778, when he returned to England. The regiment was disbanded five years later. On the occasion of its disbandment Picton quelled a mutiny amongst the men by his prompt personal action and courage, and was promised a majority in reward for his conduct. This, however, he did not receive, and after living in retirement on his father's estate for nearly twelve years, he went out to the West Indies in 1794 on the strength of a slight acquaintance with Sir John Vaughan, the commander-in-chief, who made him his aide-de-camp and gave him a captaincy in the 17th foot. Shortly afterwards he was promoted major. Under Sir Ralph Abercromby, who succeeded Vaughan in 1795, he took part in the capture of St Lucia (for which he was promoted lieutenant-colonel) and in that of St Vincent. After the reduction of Trinidad Abercromby made him governor of the island. He administered the island with such success that the inhabitants petitioned against the retrocession of the island to Spain, and their protest, with Picton's and Abercromby's representations, ensured the retention of Trinidad as a British possession. In October 1801 he was gazetted brigadier-general. But by this time the rigour of his government, as reported by his enemies, had led to a demand by humanitarians at home for his removal. Colonel William Fullarton (1754-1808) procured the appointment of a commission to govern the island, of which he himself was the senior member, Captain (afterwards Admiral Sir Samuel) Hood the second, and Picton himself the junior. Picton thereupon tendered his resignation, and Hood, as soon as the nature of Fullarton's proceedings became obvious, followed his example (1803). On his way home Picton took part with great credit in military operations in St Lucia and Tobago. Realizing, however, that the attacks upon him were increasing in virulence, he quickly returned to England, and in December 1803 he was arrested by order of the privy council. He was tried in the court of king's bench before Lord Ellenborough in 1806 on a charge of unlawfully applying torture to extort a confession from Luise Calderon, a mulatto woman of loose character who was charged, along with a man, with robbery. The torture consisted in compelling the woman to stand on one leg on a flat-headed peg for one hour. The punishment was ordered under Spanish law (which in default of a fresh code Picton had been appointed to administer in 1801) by the local alcalde, and approved by Picton. On these grounds the court returned a merely technical verdict of guilty, which was superseded in 1808 by a special verdict on retrial. It should be mentioned that the inhabitants of the island, who had already given him a sword of honour, and had petitioned the king not to accept his resignation, subscribed £4000 towards his legal expenses, which sum Picton contributed in return to the relief of the suffering caused by a widespread fire in Port of Spain. He had meanwhile been promoted major-general, and in 1809 he had been governor of Flushing during the Walcheren expedition. In 1810, at Wellington's request, he was appointed to command a division in Spain. For the remaining years of the Peninsular War, Picton was one of Wellington's principal subordinates. The commander-in-chief, it is true, never reposed in him the confidence that he gave to Beresford Hill and Craufurd. But in the resolute, thorough and punctual execution of a well-defined task Picton had no superior in the army. His début,

owing partly to his naturally stern and now embittered temper, and partly to the difficult position in which he was placed, was unfortunate. On the Coa in July 1810 Craufurd's division became involved in an action, and Picton, his nearest neighbour, refused to support him, as Wellington's direct orders were to avoid an engagement. Details of the incident will be found in Oman, *Peninsular War*, vol. iii. Shortly after this, however, at Busaco, Picton found and used his first great opportunity for distinction. Here he had a plain duty, that of repulsing the French attack, and he performed that duty with a skill and resolution which indicated his great powers as a troop-leader. After the winter in the lines of Torres Vedras, he added to his reputation and to that of his division, the 3rd, at Fuentes d'Onor. In September he was given the local rank of lieutenant-general, and in the same month the division won great glory by its rapid and orderly retirement under severe pressure from the French cavalry at El Bodon. In October Picton was appointed to the colonelcy of the 77th regiment. In the first operations of 1812 Picton and Craufurd, side by side for the last time, stormed the two breaches of Ciudad Rodrigo, Craufurd and Picton's second in command, Major-General Mackinnon, being mortally wounded. At Badajoz, a month later, the successful storming of the fortress was due to his daring self-reliance and penetration in converting the secondary attack on the castle, delivered by the 3rd division, into a real one. He was himself wounded in this terrible engagement, but would not leave the ramparts, and the day after, having recently inherited a fortune, he gave every survivor of his command a guinea. His wound, and an attack of fever, compelled him to return to England to recruit his health, but he reappeared at the front in April 1813. While in England he was invested with the collar and badge of a K.B. by the prince regent, and in June he was made a lieutenant-general in the army. The conduct of the 3rd division under his leadership at the battle of Vittoria and in the engagements in the Pyrenees raised his reputation as a resolute and skilful fighting general to a still higher point. Early in 1814 he was offered, but after consulting Wellington declined, the command of the British forces operating on the side of Catalonia. He thus bore his share in the Orthez campaign and in the final victory before Toulouse.

On the break-up of the division the officers presented Picton with a valuable service of plate, and on the 24th of June 1814 he received for the seventh time the thanks of the House of Commons for his great services. Somewhat to his disappointment he was not included amongst the generals who were raised to the peerage, but early in 1815 he was made a G.C.B. When Napoleon returned from Elba, Picton, at Wellington's request, accepted a high command in the Anglo-Dutch army. He was severely wounded at Quatre Bras on the 16th of June, but concealed his wound and retained command of his troops, and at Waterloo on the 18th, while repulsing with impetuous valour "one of the most serious attacks made by the enemy on our position," he was shot through the head by a musket ball. His body was brought home to London, and buried in the family vault at St George's, Hanover Square. A public monument was erected to his memory in St Paul's Cathedral, by order of parliament, and in 1823 another was erected at Carmarthen by subscription, the king contributing a hundred guineas thereto.

See Robinson's *Life of Sir Thomas Picton* (London, 1836), with which, however, compare Napier's and Oman's histories of the Peninsular War as to controversial points.

PICTOU, a seaport, port of entry, and capital of Pictou county, Nova Scotia, 90 m. N.E. by N. of Halifax, on a branch of the Intercolonial railway. Pop. (1901), 3235. It has several valuable industries, and is the shipping port for the adjacent coal-mines. The Academy, founded in 1818, played an important part in the early educational history of the province, and still enjoys a high reputation.

PICUS, in Roman mythology, originally the woodpecker, the favourite bird and symbol of Mars as the god of both nature and war. He appears later as a spirit of the forests, endowed with the gift of prophecy, haunting springs and streams, with

a special sanctuary in a grove on the Aventine. As a god of agriculture, especially connected with manuring the soil, he is called the son of Stercutus (from *stercus*, dung, a name of Saturn). Again, Picus is the first king of Latium, son of Saturn and father of Faunus. Virgil (*Aen.* vii. 170) describes the reception of the ambassadors of Aeneas by Latinus in an ancient temple or palace, containing figures of his divine ancestors, amongst them Picus, famous as an augur and soothsayer. According to Ovid (*Metam.* xiv., 320), Circe, while gathering herbs in the forest, saw the youthful hero out hunting, and immediately fell in love with him. Picus rejected her advances, and the goddess in her anger changed him into a woodpecker, which pecks impotently at the branches of trees, but still retains prophetic powers. The purple cloak which Picus wore fastened by a golden clasp is preserved in the plumage of the bird. In the simplest form of art, he was represented by a wooden pillar surmounted by a woodpecker; later, as a young man with the bird upon his head.

PICOMNUS is merely another form of **PICUS**, and with him is associated his brother and double **PILUMNUS**. Picumnus, a rustic deity (like Picus) and husband of Pomona, is specially concerned with the manuring of the soil and hence called *Sterquilinus*, while Pilumnus is the inventor of the pounding of grain, so named from the pestle (*pilum*) used by bakers. Under a different aspect, the pair were regarded as the guardians of women in childbed and of new-born children. Before the child was taken up and formally recognised by the father, a couch was set out for them in the atrium, where their presence guarded it from all evil. Augustine (*De civitate dei*, vi. 9) mentions a curious custom: to protect a woman in childbed from possible violence on the part of Silvanus, the assistance of three deities was invoked—*Intercidona* (the brewer), **Pilumnus** (the pounder) and *Deverra* (the sweeper). These deities were symbolically represented by three men who went round the house by night. One smote the threshold with an axe, another with a pestle, the third swept it with a broom—three symbols of culture (for trees were hewn down with the axe, grain pounded with the pestle, and the fruits of the field swept up with the broom) which Silvanus could not endure.

PIDGIN [or **PIGEOIN**] **ENGLISH**, the *lingua franca* of the seaports of China, the Straits Settlements in the Far East, consisting in a jargon of corrupted English words with some intermixture of Portuguese and Malay, following Chinese idiomatic usage. It is employed as a means of communication between foreigners and the native Chinese. The word "pidgin" is the Chinese corruption of "business."

PIE. (1) The name of the bird more generally known as the magpie (*q.v.*). The word comes through the French from Lat. *pica* (*q.v.*). It is probably from the black and white or spotted appearance of the bird that the name "pie" or "pye" (Lat. *pica*) was given to the ordinal, a table or calendar which supplemented that which gave the services for the fixed festivals, &c., and pointed out the effect on them of the festivals rendered movable by the changing date of Easter. An English act of 1549 (3 & 4 Edw. VI. c. 10) abolished "pies" with manuals, legends, primers and other service books. The parti-coloured appearance of the magpie also gives rise to the term "piebald," applied to an animal, more particularly a horse, which is marked with large irregular patches of white and black; where the colour is white and some colour other than black, the more appropriate word is "skew-bald," i.e. marked with "skew" or irregular patches. (2) A dish made of meat, fish or other ingredients, also of vegetables or fruit, baked in a covering of pastry; in English usage, where "fruit" is the ingredient, the dish is generally called a "tart," except in the case of "apple-pie." The word appears early in the 14th century of meat or fish pies. The expression "to eat humble-pie," i.e. to make an apology, to retract or recant, is a facetious adaptation of "umbles" (O. Fr. *nomblez*, connected with Lat. *lumbus*, loin or *umbilicus*, navel), the inner parts of a deer, to "humble" (Lat. *humilis*, lowly). An "umble-pie," made of the inner parts of a deer or other animal, was once a favourite dish. "Printers' pie," i.e. a mass of confused type, is a transferred sense of "pie," the dish, or of "pie," the ordinal, from the difficulty of decipherment.

PIEDMONT (Ital. *Piemonte*; Low Lat. *Pedemontis* and *Pedemontium*), a territorial division (*compartimento*) of northern

Italy, bounded N. by Switzerland, W. by France, S. by Liguria and E. by Lombardy. Physically it may be briefly described as the upper gathering-ground and valley of the river Po, enclosed on all sides except towards the Lombard plain by the vast semicircle of the Pennine, Graian, Cottian, Maritime and Ligurian Alps. In 1850 it was divided into the four provinces of Alessandria, Cuneo, Novara and Torino (Turin). It has an area of 11,340 sq. m. The people are chiefly engaged in agriculture—growing wheat, maize and rice, chestnuts, wine and hemp; in the reeling and throwing of silk and in the manufacture of cotton, woollens and clothing; there are also considerable manufactures at Turin, Savigliano, &c. The Piedmontese dialect has been rather strongly influenced by French. The chief towns in the several provinces are as follows, with their communal populations in 1901: Alessandria (72,109), Asti (39,251), Casale Monferrato (31,370), Novi Ligure (17,868), Tortona (17,410), Acqui (13,040), Valenza (10,956), Ovada (10,284), total of province 825,745; number of communes 343; Cuneo (26,879), Mondovì (18,982), Fossano (18,175), Savigliano (17,340), Saluzzo (16,028), Brà (15,821), Alba (13,637), Boves (10,137), total of province 670,504; number of communes 263; Novara (44,249), Vercelli (30,470), Biella (10,267) Trino (12,138), Borgomanero (10,131), total of province 763,830; number of communes, 437; Turin (320,691), Pinerolo (18,039), Carmagnola (11,721), Ivrea (11,696), Moncalieri (11,467); total of province 1,147,414; number of communes, 442. The total population of Piedmont was 2,738,814 in 1859, and in 1901 3,407,403. The large number of communes is noticeable, as in Lombardy, and points to a village life which, owing to greater insecurity and the character of the country, is not to be found in central and southern Italy as a whole. There are numerous summer resorts in the Alpine valleys. The chief railway centres are Turin, communicating with the Mont Cenis line, and with the Riviera by the railway over the Col di Tenda (in process of construction), Novara, Vercelli, Asti, Alessandria, Novi. The communications with Liguria are difficult owing to the approach of the mountains to the coast, and the existing lines from Genoa to Turin and Milan are hardly sufficient to cope with the traffic.

Piedmont in Roman times until 49 B.C. formed a part of Gallia Transpadana, and in Augustus' division of Italy formed with what was later known as Lombardy the 11th region. It formed part of the Lombard kingdom, and it was not till about A.D. 1000 that the house of Savoy (*g.n.*) arose. The subsequent history of Piedmont is that of its dynasty.

PIENZA, a town of Tuscany, Italy, in the province of Siena, 9 m. west of the town of Montepulciano by road, 1611 ft. above sea-level. Pop. (1901), 2730 (town); 3836 (commune). The place was originally called Corsignano and owes its present name to Aeneas Silvius Piccolomini, Pope Pius II. (*g.n.*) who was born here in 1405. The buildings which he caused to be erected by Bernardo Rossellino in 1460–1463 form a noble group of early Renaissance architecture round the Piazza del Duomo. The latter retains Gothic details in the interior, but the façade is simple Renaissance work. The other three sides are occupied by the episcopal and municipal palaces, and the Palazzo Piccolomini; the last, resembling the Palazzo Rucellai at Florence, is the finest, and in front of it is a beautiful fountain. The episcopal palace contains a museum with some fine ecclesiastical vestments, enamels and other works of art.

PIER (older forms *per* or *pere*, from Med. Lat. *pera*; the word is of obscure origin, and the connexion with Fr. *pierre*, Lat. *petra*, stone, is doubtful; equivalents are Fr. *piédroit*, *pilier*, *traverse*; Ital. *pila*; Ger. *Pfeiler*), the term given in architecture to a vertical support in masonry or brickwork, usually rectangular on plan, which carries an arch or superstructure. The term is also sometimes given to the great circular columns which in some English cathedrals and churches carry the nave arches. In early Christian churches, when antique columns, such as abounded in Rome, were not procurable, square piers took the place of columns and sometimes alternated with them. The introduction of vaulting, however, in the 11th century, necessitated a support of much greater dimensions than those which

had been deemed sufficient when the roof was of timber only, and led to the development of the compound or clustered pier. To give extra support to the subordinate arches of the nave arcade, semicircular shafts or pilasters were added, carried up to the transverse and diagonal ribs of the main vault. In Romanesque work the pier was generally square on plan with semicircular shafts attached, the angles of the pier being worked with smaller shafts. As the rings or orders of the nave arches increased in number, additional shafts were added to carry them, and the pilaster facing the nave had central and side shafts rising to carry the transverse and diagonal ribs of the vault; this development of the compound pier obtains throughout Europe in all vaulted structures. In the Early English period the piers become loftier and lighter, and in most important buildings a series of clustered columns, frequently of marble, are placed side by side, sometimes set at intervals round a circular centre, and sometimes almost touching each other. These shafts are often wholly detached from the central pier, though grouped round it, in which case they are almost always of Purbeck or Betherden marbles. In Decorated work the shafts on plan are very often placed round a square set angle-wise, or a lozenge, the long way down the nave; the centre or core itself is often worked into hollows or other mouldings, to show between the shafts, and to form part of the composition. In this and the latter part of the previous style there is generally a fillet on the outer part of the shaft, forming what has been called a "keel moulding" (*g.n.*). They are also often tied together by bands, formed of rings of stone and sometimes of metal. About this period, too, these intermediate mouldings run up into and form part of the arch moulds, there being no impost. This arrangement became much more frequent in the Perpendicular period; in fact it was almost universal, the commonest section being a lozenge set with the long side from the nave to the aisle, and not towards the other arches, as in the Decorated period, with four shafts at the angles, between which were shallow mouldings, one of which was in general a wide hollow, sometimes with wave moulds. The small columns at the jambs of doors and windows, and in arcades, and also those attached to piers or standing detached, are generally called "shafts" (*g.n.*).

The term pier is sometimes applied to the solid parts of a wall between windows or voids, and also to the isolated masses of brickwork or masonry to which gates are hung. (R. P. S.)

Piers of Bridges.—The piers of bridges and viaducts on land are constructed of masonry or brickwork and occasionally, in the case of high piers, of open braced ironwork, as exemplified by the old Crumlin viaduct in Wales and the Pecos viaduct in Texas. These piers, besides being proportioned in cross-section to the weight they have to support, are widened out at their base, so as to distribute the load over a sufficient area for it to be borne by the stratum on which it rests without risk of settlement. Special provisions have to be made for the foundations of piers where the ground is soft for some depth, or loose water-bearing strata are encountered, and especially where the piers of large bridges crossing rivers have to be constructed under water. In soft ground, bearing piles driven down to a firm stratum, and surmounted by a planked floor or a layer of concrete, provide a convenient foundation for a pier; and in places where timber is abundant, wooden cribs filled with rubble stone or concrete have been used in the United States for raising the foundations for piers out of water. For river piers, where a firm, watertight stratum is found at a moderate depth below the river-bed, the site is often enclosed within a coffer-dam or a plate iron caisson carried down into the stratum and raised out of water; and then, after the water has been pumped out and the surface layers removed, the pier is readily built within the enclosure in the open air. When, however, a river-bed consists of silt, sand or other soft materials extending down to a considerable depth, brickwork wells are gradually sunk to a firm stratum by removing the material within them with grabs, and on them the piers are built out of water; or bottomless caissons are carried down by excavating their interiors under compressed air, and the piers are built on top of them within a plate-iron enclosure, a system

adopted for the piers of the Brooklyn, St Louis, Forth and other large bridges, and essential for forming foundations on sloping rock, such as was encountered in places under the Firth of Forth.

The methods indicated above as employed for the foundations of the piers of bridges under favourable conditions belong equally to the foundations of other structures (see FOUNDATIONS), but there are some methods which, by combining bridge piers and their foundations in a single structure, appertain entirely to piers. Thus iron screw piles, sunk by turning into

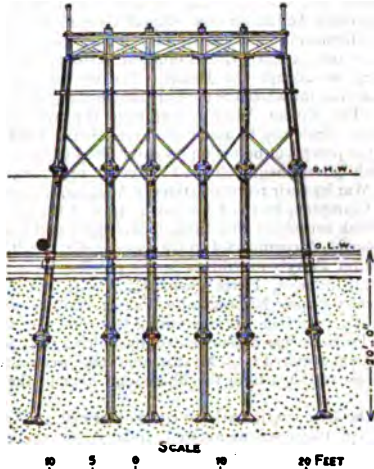

FIG. 1.—Pier with Disk Piles.

the soft bed of a river till they reach a firm stratum or one sufficiently consolidated by the superincumbent layers to enable it to support the wide blades of the screws with the weight imposed on them, were formerly often arranged in converging clusters joined together at the top, so as to serve as the piers of bridges having several comparatively small spans, and intended for carrying lightly constructed railways across rivers in India and elsewhere. Hollow, cast-iron, cylindrical piles also, with a broad circular disk at the bottom to increase their bearing surface, have been used for piers founded in sandy or silty strata

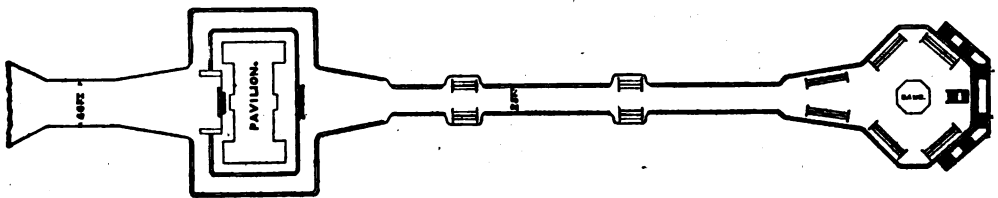
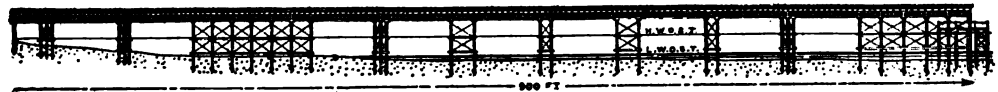

FIG. 3.—Promenade Pier.

of considerable thickness; they are sunk to the requisite depth by lowering a pipe down the inside of the pile to the bottom and emitting a powerful jet of water which, stirring up the soft material and scouring it away from under the disk, causes the pile to descend. This system was first adopted for the piers of a railway viaduct crossing the wide, sandy Kent and Leven estuaries opening into Morecambe Bay (fig. 1). Cast-iron cylinders, consisting of a series of rings formed of segments all

bolted together with a specially strong bottom ring, sometimes made of wrought iron and having a cutting edge, have been often employed for the construction of the river piers of bridges, being gradually carried down to a watertight stratum by excavating inside, and subsequently filled up solid with concrete and brickwork, the piers of the Charing Cross and Cannon Street bridges across the Thames are notable instances of the adoption of this method, which is well illustrated by the piers of the bridges across the River Chittavrati in India (fig. 2). Sometimes, instead of two or more independent cylinders being sunk, the whole site of a pier is enclosed within a wrought-iron caisson, usually divided into sections by vertical partitions, which is sunk and filled up solid in the same way as cylinders, a system adopted, for instance, for the piers of the bridge across the Hawkesbury River in New South Wales.

Promenade Piers.—The term pier is often applied to works sheltering harbours, such as the Tynemouth piers, which are strictly breakwaters. Landing stages also, whether solid or open, have for a long time been called piers, as the Admiralty Pier and the Prince of Wales's Pier at Dover; but the open promenade piers which form a common feature at seaside resorts are the type of pier best known to the general public. These piers are supported upon open pilework of timber or iron, and consequently expose little surface to waves in storms and do not interfere with the drift of shingle or sand along the coast (fig. 3).¹ Timber piles are best suited for withstanding the shocks of vessels at landing stages, at which places they are generally used; but since they are subject to the attacks of the teredo, and expose a considerable surface to the waves, iron piles are generally adopted for the main portion of these piers.

The pioneer of these piers was the old chain pier at Brighton, which was erected in 1822-1823. It was founded upon oak piles, was 1136 ft. long, and had a timber landing-stage at the end. It consisted of four spans suspended from chains on the model of the Menai Suspension Bridge, then in course of construction, and was destroyed by a gale in December 1896. A wider and more modern type of pier was erected at the west end of Brighton in 1865-1866,

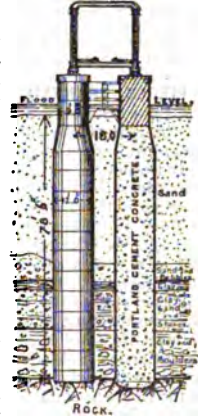

FIG. 2.—Cylindrical Piers for River Bridges.

and subsequently extended; whilst a new pier was completed in 1900 near the site of the old chain pier, 1700 ft. long. The Southport Pier, erected in 1850-1860 and afterwards prolonged, furnishes an example of an iron pier supported on disk piles sunk in sand as described above (fig. 1); whilst the much more commonly used iron screw piles, adopted as early as 1847 for an open landing-pier on the Irish coast at Courtown, which was exposed to a great littoral drift of sand, are shown as the mode of support for the pier

¹ *The Engineer* (1888), i. 380, 381 and 384.

at St Leonards (fig. 3). The length given to these promenade piers depends mainly on the slope of the foreshore, which determines the distance from the shore at which a sufficient depth is reached for steamers of moderate draught to come alongside the end of the pier. Thus, whereas a length of 900 ft. has sufficed for the St Leonards pier on a somewhat steep, shingly beach, the pier at Ryde, constituting the principal landing-place for the Isle of Wight passengers, has had to be carried out about half a mile across a flat alluvial foreshore to reach water deep enough for the access of the steamboats crossing the Solent. The vast sands, moreover, at the outlet of the Ribble estuary, stretching two or three miles in front of Southport at low water of spring tides, have necessitated the construction of a pier 4395 ft. long merely to get out to an old flood-tide channel, which is now completely severed by the sands at low water from all connexion with the river.

(L. F. V.-H.)

PIERCE, FRANKLIN (1804-1869), fourteenth president of the United States, was born at Hillsborough, New Hampshire, on the 23rd of November 1804. His father, Benjamin Pierce (1757-1839), served in the American army throughout the War of Independence, was a Democratic member of the New Hampshire House of Representatives from 1789 to 1803, and was governor of the state in 1827-1829. The son graduated in 1824 at Bowdoin College, at Brunswick, Maine, where he formed a friendship with Nathaniel Hawthorne. Pierce then studied law, and in 1827 was admitted to the bar and began to practise at Hillsborough. He at once took a lively interest in politics, and from 1829 to 1833 served in the state House of Representatives, for the last two years as Speaker. In 1833 he entered the national House of Representatives, and although he achieved no distinction in debate he was a hard worker, and a loyal supporter of the policies of President Jackson. After four years in the House he entered the Senate, being its youngest member. In 1842, before the expiration of his term, he resigned his seat, and at Concord, New Hampshire, began his career at the bar in earnest, though still retaining an interest in politics. In 1845 he declined the Democratic nomination for governor, and also an appointment to the seat in the United States Senate made vacant by the resignation of Judge Levi Woodbury. He accepted, however, an appointment as Federal District Attorney for New Hampshire, as the duties of this office, which he held in 1845-1847, were closely related to those of his profession. In 1846 he again declined public honours, when President Polk invited him to enter the cabinet as attorney-general. Soon after the outbreak of the war with Mexico, in 1846, Pierce enlisted as a private at Concord, but soon (in February 1847) became colonel of the Ninth Regiment (which joined General Winfield Scott at Pueblo on the 6th of August 1847), and later (March, 1847) became a brigadier-general of volunteers. At the battle of Contreras, on the 19th of August 1847, he was thrown from his horse and received severe injuries. At the end of the war he resigned his commission and returned to Concord. In 1850 Pierce became president of a convention assembled at Concord to revise the constitution of his state, and used his influence to secure the removal of those provisions of the constitution of 1793 which declared that only Protestants should be eligible for higher state offices. This amendment passed the convention in April 1852, but was rejected by the electorate of the state; a similar amendment was adopted by popular vote in 1877. In January 1852 the legislature of New Hampshire proposed him as a candidate for the presidency, and when the Democratic national convention met at Baltimore in the following June the Virginia delegation brought forward his name on the thirty-fifth ballot. Although both parties had declared the Compromise of 1850 a finality, the Democrats alone were thoroughly united in support of this declaration, and therefore seemed to offer the greater prospect of peace. This fact, combined with the colourless record of their candidate, enabled them to sweep the country at the November election. Pierce received 254 electoral votes, and General Winfield Scott, his Whig opponent, only 42. The Democrats carried every state except Massachusetts, Vermont, Kentucky and Tennessee. No president since James Monroe had received such a vote.

Pierce was the youngest man who had as yet been elevated to the presidency. For his cabinet he chose William L. Marcy

of New York, secretary of state, Jefferson Davis of Mississippi, secretary of war, James Guthrie (1792-1869) of Kentucky, secretary of the treasury; James C. Dobbin (1814-1857) of North Carolina, secretary of the navy; Robert McClelland (1807-1880) of Michigan, secretary of the interior; James Campbell (1813-1893) of Pennsylvania, postmaster-general; and Caleb Cushing of Massachusetts, attorney-general. This was an able body of men, and is the only cabinet in American history that has continued unbroken throughout an entire administration. Although Pierce during his term in the Senate had severely criticized the Whigs for their removals of Democrats from office, he himself now adopted the policy of replacing Whigs by Democrats, and the country acquiesced. Pierce had no scruples against slavery, and opposed anti-slavery agitation as tending to disrupt the Union. The conduct of foreign relations was on the whole the most creditable part of his administration. The *Kosztá* Affair (1853) gave the government an opportunity vigorously to assert the protection it would afford those in the process of becoming its naturalized citizens. When the British government refused to prevent recruiting for the Crimean War by their representatives in America, their minister, John F. Crampton, received his passports, and the exequats of the British consuls at New York, Philadelphia and Cincinnati were revoked. A commercial treaty was negotiated with Japan in 1854 after Perry's expedition in the previous year. As an avowed expansionist, Pierce sympathized with the filibuster government set up in Nicaragua by William Walker, and finally accorded it recognition. It was during this term also that the Gadsden Purchase was consummated, by which 45,535 sq. m. of territory were acquired from Mexico, and that three routes were surveyed for railways from the Mississippi river to the Pacific coast.

When the Democratic national convention met at Cincinnati in June 1856, Pierce was an avowed candidate for renomination, but as his attitude on the slavery question, and especially his subserviency to the South in supporting the pro-slavery party in the Territory of Kansas, had lost him the support of the Northern wing of his party, the nomination went to James Buchanan. After retiring from the presidency Pierce returned to Concord, and soon afterwards went abroad for a three years' tour in Europe. Many Southern leaders desired his renomination by the Democratic party in 1860, but he received such suggestions with disfavour. After his return to America he remained in retirement at Concord until the day of his death, the 8th of October 1869.

Pierce was not a great statesman, and his fame has been overshadowed by that of Benton, Calhoun, Clay and Webster. But he was an able lawyer, an orator of no mean reputation, and a brave soldier. He was a man of fine appearance and courtly manners, and he possessed personal magnetism and the ability to make friends, two qualities that contributed in great measure to his success.

A portion of Pierce's correspondence has been published in the *American Historical Review*, x. 170-177, 339-370. D. W. Bartlett's *Franklin Pierce* (Auburn, New York, 1852), and Nathaniel Hawthorne's *Franklin Pierce* (Boston, 1852), are two "campaign" biographies, and are very eulogistic. J. R. Ireland's *History of the Life, Administration and Times of Franklin Pierce* (Chicago, 1886), being vol. xiv. of his *Republic*, is a more critical work, but inaccurate as to details. J. E. Cooley's *Review of the Administration of General Pierce* (New York, 1854) and Anna E. Carroll's *Review of Pierce's Administration* (Boston, 1856) are hostile anti-administration tracts. The best accounts of Pierce's administration are to be found in James Schouler's *History of the United States*, vol. v. (new ed., New York, 1894); J. F. Rhodes's *History of the United States*, vols. i. and ii. (New York, 1893-1894); and J. W. Burgess's *Middle Period* (New York, 1900).

PIERO DI COSIMO (1462-1521), the name by which the Florentine painter Pietro di Lorenzo is generally known. He was born in Florence about 1462, and worked in the *bottega* of Cosimo Rosselli (from whom he derived his popular name). Other influences that can be traced in his work are those of Filippino Lippi, Luca Signorelli, and Leonardo da Vinci, and, as has been recently suggested by Professor R. Muther, that of Hugo van der Goes, whose Portinari altar-piece (now at the

Spedale of S. Maria Novella in Florence) helped to lead the whole of Florentine painting into new channels. From him, most probably, he acquired the love of landscape and the intimate knowledge of the growth of flowers and of animal life. The influence of Hugo van der Goes is especially apparent in the "Adoration of the Shepherds," at the Berlin Museum. He had the gift of a fertile fantastic imagination, which, as a result of a journey to Rome in 1482 with his master, Rosselli, became directed towards the myths of classic antiquity. He proves himself a true child of the Renaissance in such pictures as the "Death of Procris," at the National Gallery, the "Mars and Venus," at the Berlin Gallery, the "Perseus and Andromeda" series, at the Uffizi in Florence, and the "Hylas and the Nymphs" belonging to Mr Benson. If, as we are told by Vasari, he spent the last years of his life in gloomy retirement, the change was probably due to Savonarola, under whose influence he turned his attention once more to religious art. The "Immaculate Conception," at the Uffizi, and the "Holy Family," at Dresden, best illustrate the religious fervour to which he was stimulated by the stern preacher.

With the exception of the landscape background in Rosselli's fresco of the "Sermon on the Mount," in the Sistine Chapel, we have no record of any fresco work from his brush. On the other hand, he enjoyed a great reputation as a portrait painter, though the only known examples that can be definitely ascribed to him are the portrait of a warrior, at the National Gallery, (No. 895), the so-called "Bella Simonetta," at Chantilly, the portraits of Giuliano di San Gallo and his father, at the Hague, and a head of a youth, at Dulwich. Vasari relates that Piero excelled in designing pageants and triumphal processions for the pleasure-loving youths of Florence, and gives a vivid description of one such procession at the end of the carnival of 1507, which illustrated the triumph of death. Piero di Cosimo exercised considerable influence upon his fellow pupils Albertinelli and Bartolommeo della Porta and was the master of Andrea del Sarto. Examples of his work are also to be found at the Louvre in Paris, the Harrach and Liechtenstein collections in Vienna, the Borghese Gallery in Rome, the Spedale degli Innocenti in Florence, and in the collections of Mr John Burke and Colonel Cornwallis West in London. A "Magdalen" from his brush was added to the National Gallery of Rome in 1907.

See *Piero di Cosimo*, by F. Knapp (Halle, 1899); *Piero di Cosimo*, by H. Haberfeld (Breslau, 1901).

PIERRE, the capital of South Dakota, U.S.A., and the county-seat of Hughes county, situated on the east bank of the Missouri river, opposite the mouth of the Bad river, about 285 m. N.W. of Yankton. Pop. (1905) 2794; (1910) 3656. Pierre is served by the Chicago & North-Western railway; the Missouri is navigable here, but river traffic has been practically abandoned. Among the principal buildings are the state capitol (1909) and the post office building. Pierre has a public library, and is the seat of the Pierre Industrial School (co-educational, opened in 1890), a government boarding school (non-reservation) for Indian children. The city has a large trade in livestock, and is a centre for the mining districts of the Black Hills and for a grain-growing country. Natural gas is used for lighting, heating and power. A fur-trading post, Fort La Framboise, was built in 1817 by a French fur-trader (from whom it took its name) at the mouth of the Teton or Little Missouri river (now called the Bad River), on or near the site of the present village of Fort Pierre (pop. in 1910, 792). In 1822 Fort Tecumseh was built about 2 m. up-stream by the Columbia Fur Company, which turned it over in 1827 to the American Fur Company. The washing away of the river bank caused the abandonment of this post and the erection about a mile farther up-stream, and a short distance west of the river, of Fort Pierre Chouteau (later called Fort Pierre), occupied in 1832, and named in honour of Pierre Chouteau, jun. (1789-1865).¹ For twenty

¹ Pierre Chouteau in 1804 succeeded his father, one of the founders of St Louis, in the Missouri Fur Company; and about 1834 Pratt, Chouteau & Company, of which he was the leading member, bought the entire western department of the American Fur Company, and in 1838 reorganized under the name of Pierre Chouteau, jun., &

years thereafter Fort Pierre was the chief fur-trading depot of the Upper Missouri country. In 1855 the United States government bought the post building and other property for \$45,000, and laid out around them a military reservation of about 270 sq. m. The fort was the headquarters of General William S. Harney (1800-1880) in his expedition against the Sioux in 1856, and in March of that year an important council between General Harney and the chiefs of all the Sioux bands, except the Blackfeet, was held here. The fort was abandoned in 1857. Pierre was laid out in 1880, was incorporated as a village in 1883, and was chartered as a city in 1900.

See Major Frederick T. Wilson, "Fort Pierre and Its Neighbors," in *South Dakota Historical Collections*, vol. i. (Aberdeen, S.D., 1902); and Hiram M. Chittenden, *The American Fur Trade of the Far West* (3 vols., New York, 1902).

PIERRE DE CASTELNAU (d. 1208), French ecclesiastic, was born in the diocese of Montpellier. In 1199 he was archdeacon of Maguelonne, and was appointed by Pope Innocent III. as one of the legates for the suppression of heresy in Languedoc. In 1202, when a monk in the Cistercian abbey of Fonfroide, Narbonne, he was designated to similar work, first in Toulouse, and afterwards at Viviers and Montpellier. In 1207 he was in the Rhone valley and in Provence, where he became involved in the strife between the count of Baux and Raymond, count of Toulouse, by one of whose agents he was assassinated on the 15th of January 1208. He was beatified in the year of his death by Pope Innocent III.

See De la Boullerie, *Le Bienheureux Pierre de Castelnau et les Albigeois au XIII. siècle* (Paris, 1866).

PIERREFONDS, a town of northern France, in the department of Oise, 9 m. S.E. of Compiègne by road. Pop. (1906), 1482. It is celebrated for its feudal stronghold, a masterpiece of modern restoration. The building is rectangular in shape, with a tower at each corner and at the centre of each of the walls, which are strengthened by crenellation and machicolation. A lofty keep defends the principal entrances on the south-west. The interior buildings are chiefly modern, but the exterior reproduces faithfully that of the medieval fortress. Pierrefonds has a church dating from various periods from the 11th to the 16th century, and its mineral springs are in some repute. The château was begun in the last decade of the 14th century by Louis d'Orléans, to whom the domain was given by Charles VI., and finished early in the 15th century. It was subsequently held by the Burgundians, the English and the adherents of the League, from whom it passed to Henry IV. It was dismantled in 1622. The ruins, bought by Napoleon I., were restored, by order of Napoleon III., from 1858 to 1895, under the direction, first of Viollet-le-Duc and afterwards of E. Boeswillwald.

PIERREPONT, WILLIAM (c. 1607-1678), English politician, was the second son of Robert Pierrepont, 1st earl of Kingston. Returned to the Long Parliament in 1640 as member for Great Wenlock, he threw his influence on the side of peace and took part for the parliament in the negotiations with Charles I. at Oxford in 1643. Pierrepont was a member of the committee of both kingdoms, and represented the parliamentary party during the deliberations at Uxbridge in 1645; but from that time, according to Clarendon, he forsook his moderate attitude, and "contracted more bitterness and sourness than formerly." This statement, however, is perhaps somewhat exaggerated, as Pierrepont favoured the resumption of negotiations with the king in 1647, and in the following year his efforts on behalf of peace at Newport, where again he represented the parliamentarians, brought upon him some slight censure from Cromwell. For his services at Newport he was thanked by parliament; but he retired from active political life soon afterwards, as he disliked the "purging" of the House of Commons by Colonel Pride and the proceedings against the king. In spite of his Company. Chouteau built (in 1830-1831) the "Yellowstone," which went up the river to the present site of Pierre in 1831, and was the first steamboat to navigate the upper waters of the Missouri. Chouteau lived for some years in New York City, and while living in St Louis was a member of the convention (1820) which drafted the first constitution of Missouri.

moderate views Pierrepoint enjoyed the personal friendship of Cromwell; but, although elected, he would not sit in the parliament of 1656, nor would he take the place offered to him in the Protector's House of Lords. When Richard Cromwell succeeded his father, Pierrepoint was an unobtrusive but powerful influence in directing the policy of the government, and after a short period of retirement on Richard's fall he was chosen, early in 1666, a member of the council of state. He represented Nottinghamshire in the Convention Parliament of 1660, and probably was instrumental in saving the lives of some of the parliamentary leaders. At the general election of 1661 he was defeated, and, spending the remainder of his life in retirement, he died in 1678. Pierrepoint married Elizabeth, daughter of Sir Thomas Harris, Bart., of Tong Castle, Shropshire, by whom he had five sons and five daughters. His eldest son, Robert (d. 1666), was the father of Robert, 3rd earl, William, 4th earl, and Evelyn, 1st duke of Kingston; and his third son, Gervase (1649-1715), was created in 1714 baron Pierrepoint of Hanslope, a title which became extinct on his death.

PIERROT (Ital. *Pedrolino*), the name given to the leading character in the French pantomime plays since the 18th century; transferred from the Italian stage, and revived especially in recent times. He is always in white, both face and costume, with a loose and daintily clownish garb, and is represented as of a freakish disposition. Modern pierrot plays have converted the pierrot into a romantic and even pathetic figure.

PIERSON, HENRY HUGO [properly HENRY HUGH PEARSON], (1815-1873), English composer, was the son of the Rev. Dr Pearson of St John's College, Oxford, where he was born in 1815; his father afterwards became dean of Salisbury. Pierson was educated at Harrow and Trinity College, Cambridge, and was at first intended for the career of medicine. His musical powers were too strong to be repressed, and after receiving instruction from Attwood and A. T. Corfe he went in 1839 to Germany to study under C. H. Rink, Tomaschek and Reissiger. He was elected Reid Professor of Music in Edinburgh in 1844, but, owing to a disagreement with the authorities, he resigned in the following year, and definitely adopted Germany as his country about the same time, making the change in his names noted above. His two operas, *Leila* (Hamburg, 1848) and *Contarini* (Hamburg, 1872), have not retained their hold upon the German public as his music to *Faust* has done, a work which until quite recently was frequently associated with Goethe's drama. He was never recognized in England as he was in Germany, for most of his career fell in the period of the Mendelssohn fashion. His most important work was the oratorio *Jerusalem*, produced at the Norwich Festival of 1852, and subsequently given in London (Sacred Harmonic Society, 1853) and Würzburg (1862). For the Norwich Festival (at one of the meetings a selection from his *Faust* music was given with success) he began an oratorio, *Hesekiah*, in 1860; it was not finished, but was given in a fragmentary condition at the festival of that year. These two large works and a number of Pierson's songs, as well as the three overtures played at the Crystal Palace, reveal undeniable originality and a wealth of melodic ideas. He was weak in contrapuntal skill, and his music was wanting in outline and coherence; but in more fortunate conditions his great gifts might have been turned to better account. He died at Leipzig on the 28th of January 1873, and was buried at Sonning, Berks., of which parish his brother, Canon Pearson, was rector.

PIETAS, in Roman mythology, the personification of the sense of duty towards God and man and the fatherland. According to a well-known story, a young woman in humble circumstances, whose father (or mother) was lying in prison under sentence of death, without food, managed to gain admittance, and fed her parent with milk from her breast. To commemorate her filial affection a temple was dedicated (181 B.C.) by Manius Aclius Glabrio to Pietas in the Forum Holitorium at Rome, on the spot where the young woman had formerly lived. The temple was probably originally vowed by the elder Glabrio out of gratitude for the pietas shown during

the engagement by his son, who may have saved his life, as the elder Africanus that of his father at the battle of Ticinus (Livy xxi. 46); the legend of the young woman (borrowed from the Greek story of Mycon and Pero, Val. Max. v. 4, ext. 1) was then connected with the temple by the identification of its site with that of the prison. There was another temple of Pietas near the Circus Flaminius, which is connected by Amatucci (*Rivista di storia antica*, 1903) with the story of the pietas of C. Flaminius (Val. Max. v. 4, 5), and regarded by him as the real seat of the cult of the goddess, the Pietas of the sanctuary dedicated by Glabrio being a Greek goddess. Pietas is represented on coins as a matron throwing incense on an altar, her attribute being a stork. Typical examples of "piety" are Aeneas and Antoninus Pius, who founded games called Eusebeia at Puteoli in honour of Hadrian.

See Val. Max. v. 4, 7; Pliny, *Nat. Hist.* vii. 121; Livy xl. 34; Festus, s.v.; C. Wissowa, *Religion und Kultus der Römer* (1902); F. Kuntze, "Die Legende von der guten Tochter," in *Jahrbücher für das klassische Altertum* (1904), xiii. 280.

PIETERMARITZBURG, the capital of Natal, situated in 29° 46' S., 30° 13' E., 45 m. in a direct line (71 by rail) W.N.W. of Durban. It lies, 2200 ft. above the sea, north of the river Umsunduzi, and is surrounded by wooded hills. Of these the Town Hill, flat-topped, rises 1600 ft. above the town. Pop. (1904), 31,110, of whom 15,087 were whites, 10,752 Kaffirs, and 5280 Indians. The town is laid out on the usual Dutch South African plan—in rectangular blocks with a central market square. The public buildings include the legislative council chambers and the legislative assembly buildings, government house, the government offices, college, post office and market buildings. The town-hall, a fine building in a modified Renaissance style (characteristic of the majority of the other public buildings), has a lofty tower. It was completed in 1901, and replaces a building destroyed by fire in 1898. St Saviour's is the cathedral church of the Anglican community. The headquarters of the Dutch Reformed Church are also in the town. There are monuments of Queen Victoria and Sir Theophilus Shepstone, and various war memorials—one commemorating those who fell in Zululand in 1879, and another those who lost their lives in the Boer War 1899-1902. A large park and botanical gardens add to the attractions of the town. A favourite mode of conveyance is by rickshaw. The climate is healthy and agreeable, the mean annual temperature being 65° F. (55° in June, 71° in February). The rainfall is about 38 in. a year, chiefly in the summer months (Oct.-Mar.), when the heat is tempered by violent thunderstorms.

Pietermaritzburg was founded early in 1839 by the newly-arrived Dutch settlers in Natal, and its name commemorates two of their leaders—Piet Retief and Gerrit Maritz. From the time of its establishment it was the seat of the Volksraad of the Natal Boers, and on the submission of the Boers to the British in 1842 Maritzburg (as it is usually called) became the capital of the country. It was given a municipal board in 1848, and in 1854 was incorporated as a borough. Railway connexion with Durban was made in 1880, and in 1895 the line was extended to Johannesburg. The borough covers 44 sq. m. and includes numerous attractive suburbs. The rateable value is about £4,000,000. Various industries are carried on, including brick-making, tanning, brewing, and cart and wagon building.

See J. F. Ingram, *The Story of an African City* (Maritzburg, 1898).

PIETERSBURG, a town of the Transvaal, capital of the Zoutpansberg district, and 177 m. N.N.E. of Pretoria by rail. Pop. (1904), 3276, of whom 1620 were whites. The town is pleasantly situated, at an elevation of 4200 ft., on a small tributary of the Zand river affluent of the Limpopo, and is the place of most importance in the province north of Pretoria. From it roads run to Klein Letaba and other gold-mining centres in the neighbourhood, and through it passes the old route to Mashonaland, which crosses the Limpopo at Rhodes Drift. The Zoutpansberg district contains a comparatively dense Kaffir population, and a native newspaper is published at Pietersburg.

PIG

PLATE I.

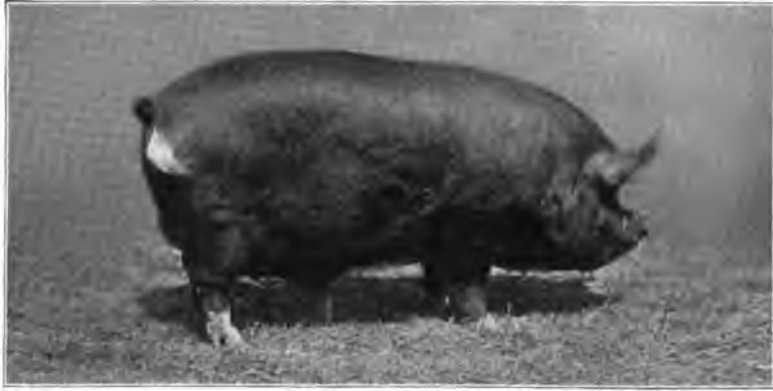

Berkshire Boar.



Middle White Boar.

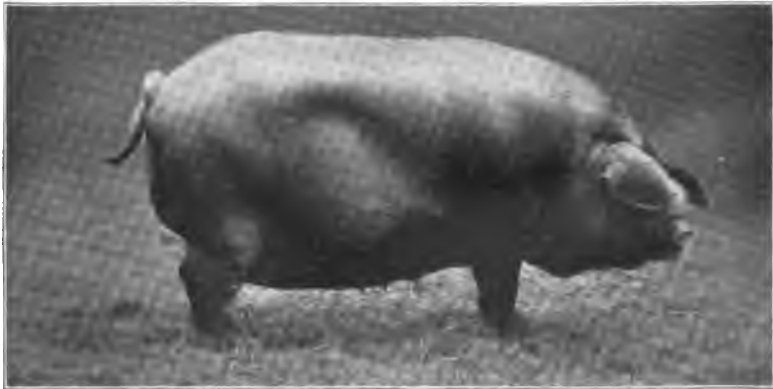

Large Black Sow.

English Breeds of Pig, from photographs of F. Babbage.

PIG



Large White Sow.



Small White Boar.



Tamworth Boar.

English Breeds of Pig, from photographs of F. Babbage.

PIETISM, a movement in the Lutheran Church, which arose towards the end of the 17th and continued during the first half of the following century. The name of Pietists was given to the adherents of the movement by its enemies as a term of ridicule, like that of "Methodists" somewhat later in England. The Lutheran Church had, in continuing Melancthon's attempt to construct the evangelical faith as a doctrinal system, by the 17th century become a creed-bound theological and sacramentarian institution, which orthodox theologians like Johann Gerhard of Jena (d. 1637) ruled with almost the absolutism of the papacy. Christian faith had been dismissed from its seat in the heart, where Luther had placed it, to the cold regions of the intellect. The dogmatic formularies of the Lutheran Church had usurped the position which Luther himself had assigned to the Bible alone, and as a consequence only they were studied and preached, while the Bible was neglected in the family, the study, the pulpit and the university. Instead of advocating the priesthood of all believers, the Lutheran pastors had made themselves a despotic hierarchy, while they neglected their practical pastoral work. In the Reformed Church, on the other hand, the influence of Calvin had made less for doctrine than the practical formation of Christian life. The presbyterian constitution gave the people a share in church life which the Lutherans lacked, but it involved a dogmatic legalism which imperilled Christian freedom and fostered self-righteousness.

As forerunners of the Pietists in the strict sense, not a few earnest and powerful voices had been heard bewailing the shortcomings of the Church and advocating a revival of practical and devout Christianity. Amongst them were Jakob Boehme (Behmen), the theosophic mystic; Johann Arndt, whose work on *True Christianity* became widely known and appreciated; Heinrich Müller, who described the font, the pulpit, the confessional and the altar as the four dumb idols of the Lutheran Church; the theologian, Johann Valentin Andrea, the court chaplain of the landgrave of Hesse; Schuppis, who sought to restore to the Bible its place in the pulpit; and Theophilus Grossgebauer (d. 1661) of Rostock, who from his pulpit and by his writings raised "the alarm cry of a watchman in Sion." The direct originator of the movement was Philip Jacob Spener, who combined the Lutheran emphasis on Biblical doctrine with the Reformed tendency to vigorous Christian life. Born at Rappoltswiler, in Alsace on the 13th of January 1635, trained by a devout godmother, who used books of devotion like Arndt's *True Christianity*, accustomed to hear the sermons of a pastor who preached the Bible more than the Lutheran creeds, Spener was early convinced of the necessity of a moral and religious reformation of the German Church. He studied theology, with a view to the Christian ministry, at Strassburg, where the professors at the time (and especially Sebastian Schmidt) were more inclined to practical Christianity than to theological disputation. He afterwards spent a year in Geneva, and was powerfully influenced by the strict moral life and rigid ecclesiastical discipline prevalent there, and also by the preaching and the piety of the Waldensian professor, Antoine Leger, and the converted Jesuit preacher, Jean de Labadie.¹ During a stay in Tübingen he read Grossgebauer's *Alarm Cry*, and in 1666 he entered upon his first pastoral charge at Frankfort-on-the-Main, profoundly impressed with a sense of the danger of the Christian life being sacrificed to zeal for rigid orthodoxy. Pietism, as a distinct movement in the German Church, was then originated by Spener by religious meetings at his house (*collegia pietatis*), at which he repeated his sermons, expounded passages of the New Testament, and induced those present to join in conversation on religious questions that arose. They gave rise to the name "Pietists." In 1675 Spener published his *Pia desideria*, or *Earnest Desires for a Reform of the True Evangelical Church*. In this publication he made six proposals as the best means of restoring the life of the Church: (1) the earnest and thorough study of the Bible in private meetings, *collegiæ pietatis* in ecclesiæ;

(2) the Christian priesthood being universal, the laity should share in the spiritual government of the Church; (3) a knowledge of Christianity must be attended by the practice of it as its indispensable sign and supplement; (4) instead of merely didactic, and often bitter, attacks on the heterodox and unbelievers, a sympathetic and kindly treatment of them; (5) a reorganization of the theological training of the universities, giving more prominence to the devotional life; and (6) a different style of preaching, namely, in the place of pleasing rhetoric, the implanting of Christianity in the inner or new man, the soul of which is faith, and its effects the fruits of life. This work produced a great impression throughout Germany, and although large numbers of the orthodox Lutheran theologians and pastors were deeply offended by Spener's book, its complaints and its demands were both too well justified to admit of their being point-blank denied. A large number of pastors at once practically adopted Spener's proposals. In Paul Gerhardt the movement found a singer whose hymns are genuine folk poetry. In 1686 Spener accepted an appointment to the court-chaplaincy at Dresden, which opened to him a wider though more difficult sphere of labour. In Leipzig a society of young theologians was formed under his influence for the learned study and devout application of the Bible. Three *magistri* belonging to that society, one of whom was August Hermann Francke, subsequently the founder of the famous orphanage at Halle (1695), commenced courses of expository lectures on the Scriptures of a practical and devotional character, and in the German language, which were zealously frequented by both students and townsmen. The lectures aroused, however, the ill-will of the other theologians and pastors of Leipzig, and Francke and his friends left the city, and with the aid of Christian Thomasius and Spener founded the new university of Halle. The theological chairs in the new university were filled in complete conformity with Spener's proposals. The main difference between the new Pietistic school and the orthodox Lutherans arose from the conception of Christianity as chiefly consisting in a change of heart and consequent holiness of life, while the orthodox Lutherans of the time made it to consist mainly in correctness of doctrine.

Spener died in 1705; but the movement, guided by Francke, fertilized from Halle the whole of Middle and North Germany. Among its greatest achievements, apart from the philanthropic institutions founded at Halle, were the organization of the Moravian Church in 1727 by Count von Zinzendorf, Spener's godson and a pupil in the Halle Orphanage, and the establishment of the great Protestant missions, Ziegenbalg and others being the pioneers of an enterprise which until this time Protestantism had strangely neglected.

Pietism, of course, had its weaknesses. The very earnestness with which Spener had insisted on the necessity of a new birth, and on a separation of Christians from the world, led to exaggeration and fanaticism among followers less distinguished than himself for wisdom and moderation. Many Pietists soon maintained that the new birth must always be preceded by agonies of repentance, and that only a regenerated theologian could teach theology, while the whole school shunned all common worldly amusements, such as dancing, the theatre, and public games. There thus arose a new form of justification by works. Its *ecclesiolæ in ecclesiâ* also weakened the power and meaning of church organization. Through these extravagances a reactionary movement arose at the beginning of the 18th century, one of the most distinguished leaders of which was Loescher, superintendent at Dresden.

As a distinct movement Pietism had run its course before the middle of the 18th century; by its very individualism it had helped to prepare the way for another great movement, the Illumination (*Aufklärung*), which was now to lead the world into new paths. Yet Pietism could claim to have contributed largely to the revival of Biblical studies in Germany, and to have made religion once more an affair of the heart and the life, and not merely of the intellect. It likewise vindicated afresh the rights of the Christian laity in regard to their own beliefs and

¹ Labadie had formed the ascetic and mystic sect of "The Regenerati" in the Church of Holland (c. 1660), and then in other parts of the Reformed Church.

the work of the Church, against the assumptions and despotism of an arrogant clergy. "It was," says Rudolf Sohm, "the last great surge of the waves of the ecclesiastical movement begun by the Reformation; it was the completion and the final form of the Protestantism created by the Reformation. Then came a time when another intellectual power took possession of the minds of men."

Some writers on the history of Pietism—e.g. Heppé and Ritschl—have included under it nearly all religious tendencies amongst Protestants of the last three centuries in the direction of a more serious cultivation of personal piety than that prevalent in the various established churches. Ritschl, too, treats Pietism as a retrograde movement of Christian life towards Catholicism. Some historians also speak of a later or modern Pietism, characterizing thereby a party in the German Church which was probably at first influenced by some remains of Spener's Pietism in Westphalia, on the Rhine, in Württemberg, and at Halle and Berlin. The party was chiefly distinguished by its opposition to an independent scientific study of theology, its principal theological leader being Hengstenberg, and its chief literary organ the *Evangelische Kirchenzeitung*. The party originated at the close of the wars with Napoleon I.

Amongst older works on Pietism are J. G. Waleh, *Historische und theologische Einleitung in die Religionsstreitigkeiten der evangelisch-Lutherischen Kirche* (1730); A. Tholuck, *Geschichte des Pietismus und des ersten Stadiums der Aufklärung* (1865); H. Schmid, *Die Geschichte des Pietismus* (1863); M. Goebel, *Geschichte des christlichen Lebens in der Rheinisch-Westfälischen Kirche* (3 vols., 1849-1860); and the subject is dealt with at length in J. A. Dorner's and W. Gass's *Histories of Protestant theology*. More recent are Heppé's *Geschichte des Pietismus und der Mystik in der reformierten Kirche* (1879), which is sympathetic; A. Ritschl's *Geschichte des Pietismus* (3 vols., 1880-1886), which is hostile; and C. Sachsse, *Ursprung und Wesen des Pietismus* (1884). See also Fr. Nippold's article in *Theol. Stud. und Kritiken* (1882), pp. 347-392; H. von Schubert, *Outlines of Church History*, ch. xv. (Eng. trans., 1907); and Carl Mirbt's article, "Pietismus," in Herzog-Hauck's *Realencyclopädie für prot. Theologie u. Kirche*, end of vol. xv.

PIETRO DELLA VIGNA, OF PIER DELLE VIGNE [Petrus de Vineas or de Vineis] (c. 1100-1249), chancellor and secretary to the emperor Frederick II., was born at Capua in humble circumstances. He studied law at Padua, and through his classical education, his ability to speak Latin and his poetic gifts, he gained the favour of Frederick II., who made him his secretary, and afterwards *judex magnæ curiæ*, councillor, governor of Apulia, prothonotary and chancellor. The emperor, "of whose heart he held the keys," as Dante says, sent him to Rome in 1232 and 1237 to negotiate with the pope, to Padua in 1239 to induce the citizens to accept imperial protection, to England in 1234-1235 to arrange a marriage between Frederick and Isabella, sister of King Henry III. He proved a skillful and trustworthy diplomat, and he persistently defended the emperor against his traducers and against the pope's menaces. But at the Council of Lyons, which had been summoned by Pope Innocent IV., Pietro della Vigna entrusted the defence of his master to the celebrated jurist Taddeo di Suessa, who failed to prevent his condemnation. Frederick, whose suspicions had been awakened by the slanders of the envious, had him imprisoned and blinded without giving him a chance to rebut his accusers. Unable to bear his disgrace, he committed suicide in his prison at Pisa in 1249. The exact date, place and manner of his death are, however, subject to controversy, and Flaminio del Borgo states that it occurred in the church of S. Andrea, at Pisa, in 1256. The tragic fate of this man gave rise to many legends. The Guelphic tradition accuses Pietro della Vigna, as well as the emperor and the court, of heresy; it was even stated, probably without any foundation, that they were the authors of the famous work, *De tribus impostoribus*, wherein Moses, Christ and Mahomet are blasphemed.

Pietro della Vigna was a man of great culture; he encouraged science and the fine arts, and contributed much to the welfare of Italy by wise legislative reforms. He was the author of some delicate verse in the vernacular tongue, of which two *canzoni* and a sonnet are still extant. His letters, mostly written in the name of the emperor and published by Iselin (*Epistolarum*

libri vi., 2 vols., Basel, 1740), contain much valuable information on the history and culture of the 13th century. A collection of the laws of Sicily, a *Tractatus de potestate imperiali*, and another treatise, "On Consolation," in the style of Boethius, are also attributed to him.

See Huillard-Bréholles, *Vie et correspondance de Pierre de la Vigne* (Paris, 1864); Presta, *Pier delle Vigne* (Milan, 1880); Capasso and Ianelli, *Pier delle Vigne* (Caserta, 1882); also FREDERICK II.

PIG (a word of obscure origin, connected with the Low Ger. and Dut. word of the same meaning, *bigge*), a common name given to the domesticated swine of agricultural use. (For the zoology, see SWINE.)

British breeds of pigs are classified as black, white and red: In some places, notably Wales and Gloucester, a remnant of a spotted breed lingers; and a large proportion of common pigs, often parti-coloured, are mongrels. The white breeds are liable to sun-scald, and black pigs (like black men) are much better adapted than white to exposure in strong sunlight, conforming to the rule that animals in the tropics have black skins.

The *Large Whites* may have in the skiff a few blue spots which grow white hair. The head is long, light in the jowl, and wide between the eyes, with long thin ears inclined slightly forward and fringed with long fine hair. The neck is long, but not coarse, the ribs are deep, the loin wide and level, the tail set high, and the legs straight and set well outside the carcass. The whole body, including the back of the neck, is covered with straight silky hair, which denotes quality and lean meat. Pigs of this breed are very prolific, and they may be grown to enormous weights—over 11 cwt. alive.

The *Middle Whites* are built on a smaller scale than the *Large Whites*. They are shorter in the heads and legs, and fuller at the jowl, thicker and more compact in the body. The sows are quite as prolific as those of the *Large White* breed, and, as their produce matures earlier, they are much in demand for breeding porkers.

The *Small White* pigs are beautifully proportioned. The head and legs are very short, and the body short, thick and wide; the jowl is heavy, the ears pricked, and the thin skin laden with long silky, wavy, but not curly, hair, whilst the tail is very fine. A deficiency of lean meat is a common characteristic of the breed, which is almost extinct.

The above three breeds were designated Yorkshire Whites, and are still so named at times. The *Middle White*, formed by crossing the large and the small breeds, is not so symmetrical as the parent stocks, and the type is not uniform.

The *Lincolnshire Curly Coated* or *Boston* pig is a local breed of great size and capacity for producing pork. It is very hardy and prolific, but somewhat coarse in the bone. It has an abundance of long curly hair, a short face and a straight nose, and the ears, not too long and heavy, fall over the face. It crosses well with the *Large White*, the *Large Black* and the *Berkshire*.

The *Large Black* breed, which vies with the *Large White* breed for size, and is probably its superior as a bacon pig, has only since 1900 received national show-yard recognition; but there is ample evidence that, with its characteristic whole black colour with a mealy hue, length, fine hair and lop ear, the *Large Black* existed in the south of England for generations. It has been continuously and carefully bred in Cornwall, Devon, Essex and Suffolk, and from these centres it has rapidly spread all over the country. *Large Blacks* are exceedingly docile, and the ears, hanging well forward over the eyes, contribute materially to a quietness of habit which renders them peculiarly adapted to field grazing. On account of their hardness and disposition to early maturity they have proved valuable for crossing purposes. The *Large Black Pig Society* was incorporated in 1890.

The *Berkshire* is a black pig with a pinkish skin, and a little white on the nose, forehead, pasterns, and tip to the tail. It has a moderately short head with heavy jowl, a deep, compact carcass, and wide, low and well-developed hind-quarters, with heavy hams. The skin carries an abundance of fine hair. The *Berkshire* is an early-maturity breed which has been somewhat

inbred, and is not so hardy and prolific as most breeds. The boars cross well with common stock. It merits the most credit in raising the quality of Irish pigs. In America it is in the front rank for numbers and quality as a lard-hog. There it often grows to be a larger and finer animal than it is in England.

The *Small Black* or *Black Suffolk* was produced from the old Essex pig by crossing with the Neapolitan. It resembles the Small White, except that the skin is coal-black in colour, and the coat of hair is not usually profuse. The Small Black, moreover, is rather longer, and stands somewhat higher, whilst it yields more lean meat than the Small White. It matures early and is quick to fatten.

The *Tamworth* is one of the oldest breeds of pigs. It is hardy, active and prolific, and nearly related to the wild boar. The colour is red or chestnut, with at times darkish spots on the skin. The head, body and legs are long, and the ribs deep and flat. Originally a local breed in the districts around the Staffordshire town from which it takes its name, it is now extensively bred, and highly valued as a bacon pig. (W. Fr.; R. W.)

In America nearly all the breeds may be classified as lard-hogs. Bacon-pigs fed on Indian corn degenerate into lard-hogs, run down in size and become too small in the bone and less prolific by inbreeding.

The *Poland-China*, the most popular breed in the United States, is thus degenerating. It is a black pig like the Berkshire, but has short lop-ears, a more pointed, straight nose, a more compact body, and more white markings. It is a breed of mixed blood, and is believed to have originated from the "Big China" pig—a large white hog with sandy spots, taken to Ohio in 1816, and blended with Irish graziers in 1839, and with a breed known as Bayfields, as well as with Berkshires. In Iowa the Berkshire is a combined lard and bacon pig in high favour.

The *Duroc Jersey* or *Duroc*, of a red or cherry-red colour—not sandy or dark—is the most popular pig in Nebraska and equal to any other in Iowa. It is a large prolific lard-hog, easily making 300 lb in eight months. It has gained rapidly in popularity since the beginning of this century, and is spreading to other centres.

The *Chester White*, named from Chester county, Pennsylvania, is one of the four leading breeds of lard-hogs in America. It is of mixed origin and bears a strong family resemblance to the Lincolnshire curly-coated pig. The early English ancestors, the breed of which is not on record in America, were most probably of Lincoln origin. The sow is a prolific breeder and good mother, weighing, when mature but not fat, 450 lb—the boar averaging 600 lb, and barrows at six to eight months 350 lb. At Vermont Station, in a 127 days' test, Chester Whites made an average gain of 1.36 lb and dressed 84.5% carcase, and they can gain fully 1 lb of live weight for 3 lb of grain consumed.

Management.—The brood sow should be lengthy and of a prolific strain, known to milk well. She is moderately fed and put to a boar of her own age when large enough, i.e. seven to eight months old. She remains in a state of oestrus for about three days, and if not pregnant comes in heat again in three weeks. Breeding swine, male and female, run most of their time at pasture and receive a liberal allowance of green food or raw roots. The period of gestation is sixteen weeks. Six to eight pigs are reared of the first litter, and ten to twelve afterwards. Many brood sows are fattened to greatest profit after the second or third litter. Two litters are produced in one year, as pigs are usually weaned at two months old, and the sow will take the boar at from three days to a week after the pigs are removed, according to condition. A convenient sty to hold five or six pigs has a southern aspect, and consists of a covered compartment and outer court, each 10 ft. square. When the animals are fed outside the inner court is kept clean and dry, and there the pigs lie. The labouring man's pig is his bank, and is fed on scraps, small potatoes and waste products. In connexion with these dairies pigs are largely fed on sour whey thickened with mixed meal produced from any or all of the grains or pulses, the choice depending upon the market price. Food may with advantage be cooked for very young pigs; but, with the exception of potatoes, which should never be given raw, roots and meals are best given uncooked. Meal mixed with pulped roots for a few hours improves in digestibility, and a sprinkling of salt is an improvement. Meal derived from leguminous seeds makes the flesh firm and improves the quality. Fattening pigs are fed

three-times a day and supplied with coal-ashes or a few handfuls of earth. Of the fatted live weight of a pig 83% is butcher's carcase, and 91% of the increase from 100 to 200 lb is carcase. From 3 to 5 lb of meal consumed results in an increase of 1 lb of live weight in a pig, which is the most economical meat producer on a farm. Concentrated and digestible foods give best results, a pig has a small stomach. Fjord's Danish experiments show that for fattening pigs 1 lb of rye- or barley-meal is equivalent to 6 lb of skim-milk or 12 lb of whey, and 1 lb of meal equivalent to 8 lb of mangolds or 4 lb of potatoes.

LITERATURE.—J. Coleman, *Pigs of Great Britain* (1877); Sanders Spencer, *Pigs: Breeds and Management* (1905); G. M. Rommel, *The Hog Industry* (1904); Bull. No. 47, U.S.A. Bureau of Animal Industry; J. Long, *The Book of the Pig* (1906); F. D. Coburn, *Swine Husbandry* (1904); R. Wallace, *Farm Live Stock of Great Britain* (4th ed., 1907); *Douglas Encyclopædia* (1906); C. S. Plumb, *Types and Breeds of Farm Animals* (1906) the *Herd Books of the Breed Societies*, and *Reports of the Agricultural Departments of Great Britain, Canada and the United States.* (R. W.)

PIGALLE, JEAN BAPTISTE (1714-1785), French sculptor, was born in Paris on the 26th of January 1714. He was the seventh child of a carpenter. Although he failed to obtain the *grand prix*, after a severe struggle he entered the Academy and became one of the most popular sculptors of his day. His earlier work, such as "Child with Cage" (model at Sèvres) and "Mercury Fastening his Sandals" (Berlin, and lead cast in Louvre), is less commonplace than that of his maturer years, but his nude statue of Voltaire, dated 1776 (Institut), and his tombs of Comte d'Harcourt (c. 1764) (Notre Dame) and of Marshal Saxe, completed in 1777 (Lutheran church, Strassburg), are good specimens of French sculpture in the 18th century. He died on the 28th of August 1785.

See P. Tarbé, *Vie et œuv. de Pigalle* (1859); Suard, *Éloge de Pigalle; Mélanges de littérature.*

PIGAULT-LEBRUN (PIGAULT DE L'ÉPINOY), **CHARLES ANTOINE GUILLAUME** (1753-1835), French novelist, was born at Calais (he is said to have traced his pedigree on the mother's side to Eustache de St Pierre) on the 8th of April 1753. His youth was stormy. He twice carried off young ladies of some position, and was in consequence twice imprisoned by *lettre de cachet*. The first, a Miss Crawford, the daughter of an English merchant whose office Pigault had entered, died almost immediately after her elopement; the second, Mlle de Salens, he married. He became a soldier in the Queen's Guards, then a very unsuccessful actor, and a teacher of French. At the breaking out of the great war he re-enlisted and fought at Valmy. He wrote more than twenty plays, and a large number of novels, the first of which appeared in 1787. In his old age he took to graver work, and executed an abridgement of French history in eight volumes, besides some other work. His *Œuvres complètes* were published in twenty volumes between 1822 and 1824, but much of his work is subsequent to this collection. He died on the 24th of July 1835. The style of Pigault's novels is insignificant, and their morality very far from severe. As almost the father of a kind of literature which later developed enormously, Pigault-Lebrun deserves a certain place in literary history. Among the most celebrated of his novels may be mentioned *L'Enfant du Carnaval* (1792) and *Angélique et Jeanne-ton de la place Maubert* (1799). His *Citateur* (2 vols., 1803), a collection of quotations against Christianity, was forbidden and yet several times reprinted.

PIGEON (Fr. *pigeon*, Ital. *piccione* and *pipione*, Lat. *pipio*, literally a nestling-bird that pipes or cries out, a "piper"—the very name now in use among some pigeon-fanciers, though "squeaker" in the more usual term). The name pigeon, doubtless of Norman introduction as a polite term, seems to bear much the same relation to dove, the word of Anglo-Saxon origin, that mutton has to sheep, beef to ox, veal to calf, and pork to bacon; no sharp zoological distinction can be drawn (see DOVE) between dove and pigeon, and the collective members of the group *Columbæ* are by ornithologists ordinarily called pigeons. Perhaps the best-known species to which the latter name is exclusively given in common speech is the wild pigeon. It may be observed that the "rock-pigeons" of Anglo-Indians are Sand-grouse (q.v.), and the "Cape pigeon" of sailors is a petrel (q.v.).

or passenger pigeon of North America, *Ectopistes migrarius*, which is still found in many parts of Canada and the United States, though now almost extinct and never appearing in the countless numbers that it did of old, when a flock seen by A. Wilson was estimated to consist of more than 2,300 millions. The often-quoted descriptions given by him and J. J. Audubon of pigeon-haunts in the then "backwoods" of Kentucky, Ohio and Indiana need not here be reproduced. That of the latter was declared by C. Waterton to be a gross exaggeration; but the critic would certainly have changed his tone had he known that, some hundred and fifty years earlier, passenger-pigeons so swarmed and ravaged the colonists' crops near Montreal that a bishop of his own church was constrained to exorcise them with holy water, as if they had been demons.¹ The passenger-pigeon is about the size of a common turtle-dove, but with a long, wedge-shaped tail. The male is of a dark slate-colour above, and purplish-bay beneath, the sides of the neck being enlivened by violet, green and gold. The female is drab-coloured above and dull white beneath, with only a slight trace of the brilliant neck-markings.² (See plate illustration under Dove.)

Among the multitudinous forms of pigeons very few can here be noticed. A species which might possibly repay the trouble of domestication is the wonga-wonga or white-fleshed pigeon of Australia, *Leucosarcia picata*, a bird larger than the ring-dove, of a slaty-blue colour above and white beneath, streaked on the flanks with black. It is known to breed, though not very freely, in captivity, and is said to be excellent for the table. As regards flavour, the fruit-pigeons of the genus *Trogon* (or *Vinago* of some authors) and its allies surpass all birds. These inhabit tropical Africa, India, and especially the Malay Archipelago; but the probability of domesticating any of them is very remote. Hardly less esteemed are the pigeons of the genus *Ptilopus* and its kindred forms, which have their headquarters in the Pacific Islands, though some occur far to the westward and also in Australia. There may be mentioned the strange Nicobar pigeon, *Caloenas* (see plate illustration under Dove), an inhabitant of the Indian Archipelago, not less remarkable for the long lustrous hackles with which its neck is clothed than for the structure of its gizzard, which has been described by Sir W. H. Flower (*Proc. Zool. Soc.*, 1860, p. 330), though this peculiarity is matched or even surpassed by that of the same organ in the *Phaenorrhina goliath* of New Caledonia (*Rev. de zoologie*, 1862, p. 138) and in the *Carpophaga latrans* of Fiji. In this last the surface of the epithelial lining is beset by horny conical processes, adapted, it is believed, for crushing the very hard fruits of *Onocarpus vitiensis* on which the bird feeds (*Proc. Zool. Soc.*, 1878, p. 102). The modern giants of the group, consisting of about half a dozen species of the genus *Goura* and known as crowned pigeons (see plate illustration under Dove), belong to New Guinea and the neighbouring islands, and are conspicuous by their large size, beautiful filmy fan-shaped crest, and the reticulated instead of scutellated covering of their "tarsi."

A very distinct type of pigeon is that represented by *Didunculus strigirostris*, the "Manu-mea" of Samoa, still believed by some to be the next of kin to the Dodo (*q.v.*), but really presenting only a superficial resemblance in the shape of its bill to that extinct form, from which it differs osteologically quite as much as do other pigeons (*Phil. Trans.*, 1869, p. 349). It remains to be seen whether the Papuan genus *Otidiphaps*, of which several species are now known, may not belong rather to the Didunculidae than to the true Columbidae.

Pigeons are now regarded as belonging to the Charadriiform or plover-like birds (see BIRDS) and are placed in the sub-order

Columbæ, near the sand-grouse (*q.v.*). They are divided into three families, Dididae, which includes the Dodo (*q.v.*) and *Saltator*, the Columbidae, which includes the doves and pigeons, and the Didunculidae, of which the curious tooth-billed pigeon, of Samoa is the only example. The body is always compact, and the bill has a soft skin or cere covering the nostrils. The pigeons are chiefly vegetable feeders and have a hard gizzard, and all drink much water; they perch, and have a note of the nature of a "coo." The nest is a rough platform or is in holes on the ground or in rocks. The eggs are two or three and white, and the young, which are helpless when hatched, are fed by a secretion from the crop of the parents. (A. N.)

PIGEON-FLYING, the sport of racing homing-pigeons bred and trained for the purpose. It is of very recent date, although the use of birds as a means of carrying messages (see Pigeons Post) is of great antiquity. Belgium may be considered as *par excellence* the home of the sport, the first birds flown there probably coming from Holland. Long-distance flying began in 1818, with a match of 100 m., while in 1820 there was a race from Paris to Liège, and three years later the first race from London to Belgium. The sport is now a favourite one in Great Britain, the United States, France, and, to a less degree, in some other countries, although nowhere attaining the general popularity which it enjoys in Belgium, where nearly every village has its *Société colombophile*, millions of pigeons being sent over the French border to be raced back. The annual Belgian *concours national*, a race of about 500 m. from Toulon to Brussels, was inaugurated in 1881, in which year the first regular races in Great Britain, from Exeter, Plymouth and Penzance to London, took place. The velocity attained at that time was about 1,250 yds. per minute, but this was soon surpassed in the races of the London Columbarian Society, one of the winners in which attained a speed of 1,836 yds. per minute.

The sport was introduced into the United States about the year 1875, although regular racing did not begin until 1878. Since then it has gained widespread popularity, the American record for old birds at 300 m. being 1,848 yds. per minute and for young birds (yearlings) 1,665 yds., while the distance record is 1,004 m. The American "blue ribbon" championships are held at 100, 200, 300, 400, 500 and 600 m. The speed of homing-pigeons depends very greatly upon the state of the atmosphere. In the race from Montargis to Brussels in 1876 in bright and clear weather, all the prize-winners made the distance of 270 m. within three and one-quarter hours, while in the same race in 1877, on a thick and stormy day, thirty hours passed before the first bird arrived.

Training.—The loft should be on a commanding site. It is best made in the shape of a large room, suitably subdivided, protected from vermin, and provided with drinking troughs, rock salt, and crushed mortar for the birds' use. It should be fitted with a sufficient number of nests about 2 ft. long, 20 in. in breadth and height. Arrangements should be made for allowing the pigeons to fly out daily for exercise; and they should be trained to re-enter the loft through bolting wires, which open inwards only, into a small chamber, to which an electric arrangement may be fitted so as to sound a bell and warn the owner of the arrival of a bird. The food of birds in training consists of vetch, beans, maize, peas, broken rice and millet, in various proportions, according to the country, climate and season of the year, the daily allowance for each bird being about 40 grammes weight. Young birds may be fed on rice in the husk and bread. They are called "squealers" for a week or two after birth, and then "squealers" until about three months old. Each brood consists of two eggs, on which both parents sit in turn, the cock only for a few hours in the middle of the day. When the young are being brought up, only one of the parent birds is taken out at a time. One meal per day, given before the birds are let out in the morning, is sufficient. Training should commence in warm weather, when the bird is about four months old, and it consists in taking it out in a closed wicker basket and liberating it "tossing" it at gradually increasing distances from its loft, with several days interval of rest between the flights. The usual preliminary distances are 1, 2, 5, 10 and 15 or 20 m. These tosses should all be made on the same line between the loft and, say, some neighbouring city, in order that a bird may always have to fly in the same general direction during the season. About 100 m. may be expected of birds the first season; they reach their full distances only about the fifth year. It is considered better to

¹ *Voyages du Baron de La Hontan dans l'Amérique septentrionale*, t. 93, 94 (2nd ed., Amsterdam, 1705). In the first edition, published at the Hague in 1703, the passage, less explicit in details but to the same effect, is at p. 80. The author's letter, describing the circumstance, is dated May 1687.

² There are several records of the occurrence in Britain of this pigeon, but in most cases the birds noticed cannot be supposed to have found their own way hither. One, which was shot in Fife in 1825, may, however, have crossed the Atlantic unassisted by man.

train the young homers alone, so that they may become independent of the older birds. When thoroughly trained they may be flown over long distances about once a week. The Belgian fanciers generally divide their birds into two classes, one for breeding and the other for racing, though the latter are allowed to breed within certain limits. Some fanciers always choose birds with chicks in the nest for long journeys, claiming that they return faster with this incentive. A seamless metal ring marked with the owner's name is slipped over the foot of the pigeon when only a few days old, and during its racing career the longer wing-feathers are stamped with the bird's records. At the start of a race the competing birds are tossed together by a starter who takes the time. Upon being released the homer ascends rapidly in spirals until, apparently describing some familiar landmark on the horizon, it will fly straight and swiftly towards it. As the birds enter their home-lofts the time is taken by the owner. A bird is not considered to have got "home" until it has actually passed through the door of its loft.

PIGEON POST. The use of homing pigeons to carry messages is as old as Solomon, and the ancient Greeks, to whom the art of training the birds came probably from the Persians, conveyed the names of Olympic victors to their various cities by this means. Before the electric telegraph this method of communication had a considerable vogue amongst stockbrokers and financiers. The Dutch government established a civil and military pigeon system in Java and Samatra early in the 19th century, the birds being obtained from Bagdad. Details of the employment of pigeons during the siege of Paris in 1870-71 will be found in the article POST AND POSTAL SERVICE: France. This led to a revival in the training of pigeons for military purposes. Numerous private societies were established for keeping pigeons of this class in all important European countries; and, in time, various governments established systems of communication for military purposes by pigeon post. When the possibility of using the birds between military fortresses had been thoroughly tested attention was turned to their use for naval purposes, to send messages between coast stations and ships at sea. They are also found of great use by news agencies and private individuals. Governments have in several countries established lofts of their own. Laws have been passed making the destruction of such pigeons a serious offence; premiums to stimulate efficiency have been offered to private societies, and rewards given for destruction of birds of prey. Pigeons have been used by newspapers to report yacht races, and some yachts have actually been fitted with lofts. It has also been found of great importance to establish registration of all birds. In order to hinder the efficiency of the systems of foreign countries, difficulties have been placed in the way of the importation of their birds for training, and in a few cases falcons have been specially trained to interrupt the service in war-time, the Germans having set the example by employing hawks against the Paris pigeons in 1870-71. No satisfactory method of protecting the weaker birds seems to have been evolved, though the Chinese formerly provided their pigeons with whistles and bells to scare away birds of prey.

In view of the development of wireless telegraphy the modern tendency is to consider fortress warfare as the only sphere in which homing pigeons can be expected to render really valuable services. Consequently, the British Admiralty has discontinued its pigeon service, which had attained a high standard of efficiency, and other powers will no doubt follow the example. Nevertheless, large numbers of birds are, and will presumably continue to be, kept at the great inland fortresses of France, Germany and Russia.

See L. du Puy de Podio, *Die Briefstaube in der Kriegskunst* (Leipzig, 1872); Brinckmeier, *Anzucht, Pflege, und Dressur der Briefstauben* (Hilmenau, 1891).

PIGEON-SHOOTING, a form of sport consisting of shooting at five pigeons released from traps. The number of traps, which are six-sided boxes, falling flat open at the release of a spring, is usually five; these are arranged 5 yds. apart on the arc of a circle with the shooter forms the centre. The distance (maximum) is 31 yds., handicapping being determined by shortening the distance. The five traps are each connected by wires with a case ("the puller"); a single string pulled by a man stationed at the side of the shooter works an

arrangement of springs and cog-wheels in the "puller," and lets fall one of the traps; it is impossible to know beforehand which trap will be released. At a fixed distance from the centre of the traps is a boundary within which the birds hit must fall if they are to count to the shooter. This line varies in distance in the various clubs; the National Gun Club boundary being 65 yds., that of the Monaco Club being only 20 yds. The charge of shot allowed must not exceed 1½ oz. The best type of pigeon is the blue rock. From the start of the Hurlingham Club at Fulham in 1867 pigeon-shooting was a favourite sport there; it was, however, stopped in 1906. The principal pigeon-shooting centre in England is now at the National Gun Club grounds at Hendon. The great international competitions and sweepstakes take place at Monaco. An artificial bird of clay, now more usually of a composition of pitch, is often substituted for the live pigeon. These clay birds are also sprung from traps. This sport originated in the United States, where, under the name of "trap-shooting," or inanimate bird shooting, it is extremely popular. At first the traps invented threw the birds with too great regularity of curve; now the traps throw the birds at different and unknown angles, and the skill required is great. In clay-bird shooting the traps usually number fifteen, and are out of sight of the shooter. The Inanimate Bird Shooting Association in England was started in 1893.

PIGMENTS (Lat. *pigmentum*, from *pingere*, to paint). It is convenient to distinguish between pigments and paints, the latter being prepared from the former by the addition of a vehicle or medium. Nor are pigments and dyes identical, although there are cases in which the same colouring matter which yields a dye or stain may give rise to a pigment. A pigment is, in fact, a substance which is insoluble in the vehicle with which it is mixed to make a paint, while a dye is soluble. Pigments exhibit various degrees of transparency and opacity, and ought to possess such qualities as these: ease in working, chemical indifference to each other and, generally, to the vehicles employed, also stability under exposure to light and air. As a rule, it is desirable that pigments should not be seriously affected in hue by the vehicle; at all events, whatever change does occur ought to admit of calculation. In the case of oil colours it should be remembered that a thorough drying of the paint is preferable to the formation of a surface-skin, and that a few pigments, notably white lead, possess properties conducing to this desirable result. It is scarcely necessary to add to these general observations concerning pigments that their artistic value depends primarily upon the nature and amount of the optical sensation which they are competent to produce.

Although the number of available pigments is great, the number of chemical elements which enter into their composition is not large. Very many richly-coloured compounds cannot be employed because they lack the properties of insolubility, inertness and stability. Pigments are drawn from various sources. Some are natural, some artificial; some are inorganic, some organic, some are elements, some mixtures, some compounds. It is not unusual to arrange them into two groups, *substantive* and *adjective*. Amongst the members of the former group such a pigment as vermilion, where each particle is homogeneous, may be cited as an example. Amongst the adjective pigments rose-madder may be named, for each particle consists of a colourless base on which a colouring matter (alizarin) has been thrown. Most of the inorganic pigments, whether natural or artificial, belong to the substantive group; while there are many organic pigments, notably those of artificial origin, which are of adjective character. The following table presents a summary classification of pigments according to their source or origin:—

Mineral pigments	{ Natural; as terre verte. Artificial; as aureolin.
Organic pigments	{ Animal; as carmine. Vegetable; as madder-lake. Artificial; as alizarin-orange.

A variety of processes are in use in order to fit natural coloured substances for employment as pigments. The first step is,

in many cases, to select, or "pick over," the raw material, rejecting whatever impurities may weaken or injure the characteristic hue of the product. It is occasionally

Preparation.

necessary to treat the finely-ground substance with water by the method of elutriation or washing-over; the wash-waters will then deposit, on standing, various grades of the coloured body required. With rare exceptions native pigments need careful grinding, either by means of a muller on a slab or by edge rollers, or horizontal mill-stones, or special machines. The substance is usually ground in spirits of turpentine, or alcohol, or water; oil-paints are of course finally ground in a drying-oil, such as linseed oil or poppy oil, water-colours require gum-water, or gum-water and glycerin if they are to be "moist" paints. In the case of all pigments, whether mineral or organic, whether natural or artificial, it is of the highest importance to make sure that they are free from saline matters soluble in water. Such salts are removed by thorough washing with distilled water. A treatment of this kind is essential in the case of a large number of pigments formed by chemical reactions in the "wet way." Characteristic examples are furnished by Prussian blue, viridian and lakes. Sometimes it is necessary to remove dangerous impurities by solvents other than water, such as carbon bisulphide, which is used to extract free sulphur from cadmium yellow. Mention may here be made of another kind of preparative treatment which is adopted with some pigments: they are subjected to the action of heat—moderate in some cases, strong in others. Thus, a few substances, such as ivory black and yellow ochre, which in ordinary circumstances contain much non-essential moisture, before they are ground in oil may with advantage be gently dried at a temperature not above that of boiling water. Again, there are pigments, such as Prussian brown, light red and burnt sienna, which owe their hues to a process of actual calcination, the first of these being thus made from Prussian blue, the second from yellow ochre, and the third from raw sienna. The pigments known as burnt carmine and burnt madder are prepared at a much lower temperature, and ought to be described as roasted rather than as burnt.

The substitution of one pigment for another is rarely practised, but it is not so unusual to find that a costly substance has received an admixture of something cheaper, and that an inferior grade of a genuine pigment has had its hue exalted or enhanced by some unlawful or dangerous addition. In fact, these two kinds of sophistication are often associated. Thus vermilion is adulterated with red lead, with red antimony sulphide, or with baryta white and lead sulphate, and then the hue of the mixture is restored to the proper pitch by the introduction of the powerful but fugitive colouring matter eosin. Amongst other adulterations which may be named here are the addition of chrome-yellow (lead chromate) to yellow ochre, of green ultramarine to terre verte, and of indigo to ivory black; this last mixture being a substitute for vine-black, the natural blue-black. The detection of the above-named sophistications is by no means difficult even in the hands of persons unacquainted with chemical manipulation, but it needs a trained analyst when quantitative results are required. If we are dealing with an oil-colour, the first step is to remove the oil by means of a solvent, such, for example, as ether. The residual pigment is then allowed to dry, and the dry powder submitted to the appropriate physical and chemical tests. Thus a suspected vermilion, having been freed from oil, is heated in a small hard glass bulb-tube: it should prove practically volatile, leaving a mere trace of residue. In this particular case the presence of a red hue in the ether-extract affords evidence of adulteration with an organic colouring matter, such as eosin. Then, again, we may detect the presence in yellow ochre of lead chromate by pouring a little sulphuretted hydrogen water and dilute hydrochloric acid upon one portion of the dry pigment, and boiling another portion with dilute sulphuric acid and some alcohol: in the former experiment blackening will occur, in the latter the liquid part of the mixture will acquire a greenish tint. So also green ultramarine may be

recognized in adulterated terre verte by the addition of dilute hydrochloric acid, which destroys the colour of the adulterant and causes an abundant evolution of the evil-smelling sulphuretted hydrogen. Moreover, nothing is easier than the recognition of indigo in vine or charcoal-black, for the dry powder, heated in a glass tube, gives off purple vapours of indigo, which condense in the cooler part of the tube into a blackish sublimate.

A word must be said here as to the adulteration of white lead, and the examination of this most important pigment. The best variety of white lead or flake white contains two molecules of lead carbonate to one of lead hydrate, and is wholly soluble in dilute nitric acid, while barium sulphate, its most frequent adulterant, is wholly insoluble. China-clay and lead sulphate will also remain undissolved; but whitening or chalk cannot be detected in this way—indeed, the thorough examination of white lead, not only for sophistications but also for correspondence with the best type in composition, cannot be carried out save by a skilled chemist.

Pigments may be classified on two systems: (1) based on the chemical composition; (2) based on the colour. On the first system pigments fall into nine groups, seven of which are fairly well defined, but the eighth and ninth have a somewhat miscellaneous character.

Classification.

The groups of elements, oxides, sulphides, hydrates, carbonates and silicates present this characteristic, namely, that each member of any one group is without action upon the other members of the group; any two or more may therefore be mixed together without fear of mutual injury. The same statement may be made with reference to the various inorganic salts of Group VIII. and to the organic compounds of Group IX., although in this large final group there are two pigments containing copper (verdigris and emerald green) which must be regarded with suspicion. The inertness of the members of the same group towards each other may be explained in the majority of cases by the following consideration. An oxide does not act upon an oxide, nor does a sulphide affect a sulphide, because all the pigment oxides have taken up their full complement of oxygen, and can neither give nor lose this element to similar oxides; so also with sulphur in the sulphides. A few details regarding the several members of the nine groups are now offered:—

GROUP I. Elements.—All the black pigments in ordinary use—ivory black, lamp black, charcoal black, Indian ink, and graphite, less correctly termed black-lead and plumbago—consist of or contain carbon, an element not liable to change. The metallic pigments, gold, silver, aluminium and platinum, belong here, of these, silver alone is easily susceptible of change, tarnishing by combination with sulphur.

GROUP II. Oxides.—The oxides have generally been formed at a high temperature and are not easily amenable to physical or chemical change; they are, moreover, not liable to affect other pigments, being practically inert. red lead only being an exception. The oxides include zinc white, green chromium oxide, burnt madder (a mixture of iron and manganese oxide), cobalt green (CoO, ZnO), cobalt blue ($\text{CoO}, \text{Al}_2\text{O}_3$), ceruleum (CoO, SnO_2), Venetian red, light red, Indian red and burnt sienna (all chiefly composed of ferric oxide), and red lead (Pb_2O_3).

GROUP III. Sulphides.—Some of the members of this group are liable to contain free sulphur, and some may give up this element to the metallic bases of other pigments. Thus cadmium yellow blackens emerald green, producing copper sulphide. Another pigment of this group, vermilion, is prone to a molecular change whereby the red form passes into the black variety. This change, frequent in water-colour drawings, is scarcely observable in works painted in oil. The sulphides comprise cadmium yellow (CdS), king's yellow (As_2S_3), realgar (As_2S_5), antimony red (Sb_2S_3) and vermilion (HgS). It is convenient to give places in the same group to the various kinds of ultramarine, blue, green, red, violet and native, for in all of them a part of the sulphur present occurs in the form of a sulphide. It may be stated that the sulphides of arsenic and antimony just named are dangerous and changeable pigments not suited for artistic painting.

GROUP IV. Hydrates or Hydroxides.—Several native earths belong here, notably yellow ochre, raw umber, raw sienna and Cappagh brown. These substances owe their colours mainly to hydrates and oxides of iron and of manganese, but the presence of a colourless body such as white clay or barium sulphate is usual with the paler pigments. A false yellow ochre from Cyprus is really a basic ferric sulphate, and does not properly belong to this

group. Besides the yellow and brown pigments, there is a magnificent deep green pigment in this group, known as emerald oxide of chromium or viridian. The blue copper preparation which goes under the name of *bleu lumière* and mountain blue, a very unstable pigment, is also essentially a hydrate, though by no means pure. It should be stated that all the earthy or native hydrates belonging to this group contain water in two states, namely, hygroscopic or loosely-attached and constitutional. Before grinding them in oil, the reduction in the amount of the hygroscopic moisture by means of a current of dry air or a gentle warmth often improves the hue and working quality of these pigments.

GROUP V. Carbonates.—There is but one really important member of this group, namely, the old and typical variety of white lead (2PbCO_3 , PbH_2O_2). Like green verditer (2CuCO_3 , CuH_2O_2) and blue verditer (CuCO_3 , CuH_2O_2), it is a basic carbonate. Purified chalk or whiting (CaCO_3) belongs here also.

GROUP VI. Silicates.—*Terre verte*, which is a natural green ochre containing a silicate of iron, potassium and magnesium, and one other silicate, smalt, an artificial glass containing a silicate of cobalt and potassium, constitute this small group. However, some of the ochreous earths contain silicates of iron, manganese and aluminium, as well as hydrates of the two former metals, and so have some claim to be ranked with the silicates.

GROUP VII. Chromates.—These salts are rich in oxygen. When in contact with some of the more alterable organic pigments belonging to Group IX, the chromates may lose oxygen, acquiring a somewhat greenish or greyish hue, owing to the formation of the lower or green oxide of chromium. The chromates cannot be trusted as pigments. The yellow chromates, those of barium, strontium, zinc and lead, are represented by the general formula $\text{M}''\text{CrO}_4$; chrome red is basic, and is Pb_2CrO_4 .

GROUP VIII. Various Inorganic Salts.—This group is intended to receive a number of pigments which are solitary, or almost solitary, examples of various classes of salts. There is one cobaltinitrite, aureolin ($\text{K}_2\text{Co}(\text{NO})_6$), associated with one or more molecules of water, called sometimes cobalt yellow; one antimonate, that of lead, the true Naples yellow; one tungstate, that of chromium, known as tungsten green; a metaphosphate of manganese, which goes under the name of Nürnberg or manganese violet; and several mixed cobalt compounds containing arsenates and phosphates of that metal, and represented by cobalt violet and Thénard's blue. Two sulphates also belong here, namely, baryta white (BaSO_4) and lead sulphate (PbSO_4); also Schweinfurt green, a basic copper arsenite. It is obvious that of the members of so miscellaneous a group of pigments no general characteristics can be predicated. But it may be stated that the two sulphates, the tungstate and the cobalt compounds are practically inert and unalterable, while the copper arsenite and the lead antimonate are sensitive to the action of sulphur and of sulphides. The cobaltinitrite, aureolin, cannot be safely mixed with some of the organic pigments belonging to the next and last group.

GROUP IX. Organic Compounds.—Most of the members of this large and unwieldy group of pigments possess this character in common, proneness to oxidation and consequent deterioration in the presence of light, moisture and air. Such oxidation is accelerated by the action of some highly oxidized pigments belonging to other groups, such as the chromates of Group VII, and aureolin of Group VIII., this action being particularly marked in the case of the yellow lakes, the cochineal lakes and indigo. There are two pigments consisting of copper salts in this group. They are verdigris—both the blue-green and the green varieties being basic copper acetates—and the pigment known in England as emerald-green, which is a basic cupric aceto-arsenite. These copper pigments present the usual sensitiveness to the attack of sulphur which distinguishes compounds of this metal, and cannot therefore be safely mixed with the members of Group III., and more particularly with the cadmium colours. About nine members of Group IX. may be regarded as substantive pigments. These include Indian yellow (mainly magnesium and calcium exanthates), gamboge, sap green, indigo, Prussian blue, bitumen or asphalt, bistre, sepia, and the bituminous variety of Vandyck brown. The adjective pigments include a great variety of lakes where different kinds of colouring matters of more or less acid character have been thrown upon a base, generally of colourless aluminium hydrate, aluminium phosphate, stannous hydrate, stannic oxide, baryta or lime; sometimes coloured bases containing such metals as copper, chromium, manganese or iron are introduced in small quantities. The colouring matters used are both natural and artificial. Amongst the former may be named Indian lake, from the resinous exudation produced in certain trees by the attacks of *Coccus lacca*, carmine, crimson and purple lake, from the colouring matter obtained from the cochineal insect, *Coccus cacti*; rose-madder and the madder-lakes, from the alizarin and allied bodies derived from the root of the ordinary madder plant *Rubia tinctorum*; and yellow lakes, from quercitron bark (*Quercus tinctoria*), and from Persian and Avignon berries (species of *Rhus* or *Buckthorn*). The lakes derived from alkanet root, archil, Brazil wood, and red sanders wood are of very small interest and value. The same judgment may be pronounced upon the large number of artificial lakes which owe their colours to coal-tar derivatives, with the single exception of

the important class of pigments obtained from artificial alizarin, and from its congeners and derivatives. Of these, alizarin (*q.v.*) itself, in its purest state and associated with alumina and a little lime, yields those pigments which possess a pink or rosy hue. When purpurin and its isomers, anthrapurpurin and flavopurpurin, are present, the red hue is more pronounced, and may even tend towards a golden colour, or, when some copper or iron or manganese is introduced, may become decidedly brown. Many of the alizarin crimson sold as paints are not made from alizarin itself, but from the sulphonic acids of alizarin. These lakes present a wide range of hues. Another derivative of alizarin, known as β -nitro-alizarin, yields a rich orange lake, to which such names as pure orange, orange madder and marigold have been applied.

Stability.—Some notion of the relative stability of pigments will have been derived from the remarks already made under "Classification." But as permanence is of no less importance than chromatic quality in the case of pigments used in the fine art of painting, to which the present article is mainly devoted, further particulars concerning certain selected pigments may profitably be given here. Beginning with white pigments, these three may be named as useful: white lead, Freeman's white, zinc white. As an oil-colour, white lead of the old type is generally the best to use, but among water-colours its place must be taken by zinc white in the condensed form known as Chinese white. Zinc white, in spite of the qualities which recommend its use in oil, namely, the fact of its being not only unaffected by sulphur, but odourless and non-poisonous, lacks toughness as an oil-paint, and has a tendency to scale. Freeman's white, which consists essentially of lead sulphite, is the best substitute for white lead yet devised. The small percentages of zinc white and baryta white which it contains are not to be regarded as adulterations, for they greatly increase its body, and though of less specific gravity than lead sulphate, actually raise the weight per cubic foot of the dry pigment. Out of a dozen or more familiar yellow paints, a selection may be made of these six: yellow ochre, raw sienna, mars orange, cadmium yellow, aureolin and baryta yellow. Concerning two of these, cadmium yellow and aureolin, the following observations may be set down. Cadmium sulphide, CdS , exists in two forms, which in some measure correspond to the two modifications of mercuric and antimonious sulphides. One of these forms is yellow and the other reddish orange. When sulphuretted hydrogen is sent into a weak, cold, and neutral solution of cadmium salt, the sulphide which separates is pale and yellow—the orange variety is obtained from a strong, hot, and acid solution. The pale variety is more prone to change than the darker one; but as oil colours both forms are sufficiently stable for use, provided they are pure. The value of aureolin as a pigment depends much upon its mode of preparation. A new variety of bright yellow hue was described by Adie and Wood in 1900, and is represented by the formula $\text{K}_2\text{NaCo}(\text{NO})_6$, H_2O . Of red pigments, six claim special mention. These are vermilion, light red, Venetian red, Indian red, red ochre, and the red lakes derived from madder or alizarin. Vermilion is stable in oils, but as water-colour paint is prone to change, under exposure to strong light, into the black modification of mercuric sulphide. The iron-reds named above, whether natural or artificial, are quite permanent, but so much cannot be said of the various madder-paints. They are of far greater stability under exposure to light than any other red organic pigments, and are absolutely necessary to the artist. It must be noted that those madder and alizarin lakes which contain an element of yellow and brown are less stable than those of a crimson hue. Five green pigments may be recommended, namely, viridian, or the emerald oxide of chromium, the ordinary green oxide, cobalt green, green ultramarine, and terre verte. Except for minor decorative work, where permanence is of secondary moment, one is obliged to exclude from the palette emerald green, green verditer, verdigris, sap-green, and the numerous preparations which owe their colour to mixtures of Prussian blue and chrome yellow, and are sold under the names of green vermilion, chrome green, Brunswick green, and so on. All these pigments usually contain much barium sulphate. Similarly, amongst blue pigments, ultramarine, cobalt blue and coeruleum may be retained, while smalt, indigo and all

copper blues should be rejected. Prussian blue, or the mixture of this pigment with a white base which is usually called Antwerp blue, can scarcely be spared, but care should be taken to choose a sample containing no potassium compounds. Coeruleum, which may be described as cobalt stannate presents the peculiarity of appearing a greenish blue in artificial light, not a purplish blue like that of ordinary cobalt blue. Cobalt violet is a sound pigment, while manganese metaphosphate or Nürnberg violet is said not to be safe in oil. Mars violet, an artificially prepared ferric oxide, is dull in hue but permanent. Passing on to brown pigments, it is matter for regret that there are no permanent colours possessing the artistic capacities of asphalt, madder brown, and the old bituminous Vandyke brown. Cappagh brown, burnt sienna, and raw and burnt umber may be employed safely. Little need be said as to the selection of black pigments, for all are permanent. The soot from burning acetylene, which has recently been introduced, forms a black pigment of remarkable intensity.

Uses.—Hitherto pigments have been considered chiefly in relation to the requirements of the painter of pictures. In many merely decorative arts, such as the manufacture of wall-papers and the painting of woodwork and of iron, the pigments available are in one direction, that of cost, more restricted, but, on the other hand, many alterable or weak pigments are commonly employed. In paints intended for the protection of iron-work, the nature of the pigment introduced is a matter of great moment, for red lead, zinc white and white lead are found to exert a strong protective influence, which is not observed in the case of the vast-majority of pigments. There are a number of other uses besides those just named for which special pigments, or, more precisely, special paints, are employed. Amongst such preparations may be named luminous paints, anti-fouling paints, metallic paints, damp-proof paints, and asbestos and other fire-proof paints.

AUTHORITIES.—J. Bersch, *Manufacture of Pigments*, translated from the 2nd German edition by A. C. Wright (London, 1900); Cennino Cennini, *The Book of the Art*, translated by Mrs Herringham (London, 1899); Sir A. H. Church, *Chemistry of Paints and Painting* (London, 1901); G. H. Hurst, *Painters' Colours, Oils and Varnishes* (London, 1901); S. Mierzinski, *Handbuch der Farbwerke* (Vienna, 1898); Riffault (and others) *Fabreant de couleurs* (Paris, 1884). (A. H. C.)

PIGOT, GEORGE, BARON (1719-1777), English governor of Madras, was born on the 4th of March 1719 and entered the service of the East India Company in 1736; after nineteen years he became governor and commander-in-chief of Madras in 1755. Having defended this place against the French in 1758-59 and occupied Pondicherry on behalf of the company, he resigned his office in November 1763 and returned to England, being made a baronet in 1764. In the following year he obtained a seat in parliament, and this he retained until his death; in 1766 he was created an Irish peer as Baron Pigot. Returning to India in 1775 to occupy his former position at Madras, Pigot was at once involved in a fierce quarrel with the majority of his council, which arose out of the proposed restoration of the rajah of Tanjore. The governor was arrested by order of his opponents, and was still a prisoner when he died on the 11th of May 1777. Meanwhile the conduct of Pigot was censured by the court of directors in England and the order for his restoration was followed immediately by another for his recall. This happened about a month after his death, but before the news had reached England. In 1779 the matter was discussed in parliament, and four of those who were responsible for his arrest were tried and were fined £1000 each. Pigot, who left several illegitimate children, was never married, and his barony became extinct.

Two of the governor's brothers were men of repute. **SIR ROBERT PIGOT (1720-1796)**, who succeeded to the baronetcy, commanded his regiment (the 39th) at the battles of Lexington and Bunker Hill during the War of American Independence. He became a lieutenant-general in 1782. The other brother, **HUGH PIGOT (c. 1721-1792)**, was a sailor. After some years of service he became an admiral and commander-in-chief in the West Indies in 1782. One of his sons was General **SIR HENRY PIGOT (1750-1840)**, and another was **HUGH PIGOT (1769-1797)**, a captain in the navy, who was murdered

during a mutiny in September 1797 while in command of the "Hermione."

PIG-STICKING, or **HOO-HUNTING**, the chase of the wild boar, as a sport, on horseback with the spear. The chase on foot was common among ancient peoples, and in central Europe has lasted to the present day, although, on account of the introduction of fire-arms, the spear has gradually become an auxiliary weapon, used to give the *coup de grâce* to a wounded animal. The modern sport is the direct descendant of bear-spearing which was popular in Bengal until the beginning of the 19th century, when the bears had become so scarce that wild pigs were substituted as the quarry. The weapon used by the Bengalese was a short, heavy, broad-bladed javelin. British officers introduced the spear or lance and this has become the recognized method of hunting wild pigs in India. The season for hunting in northern India, the present headquarters of the sport, is from February to July. The best horses should be quick and not too big. Two kinds of weapon are used. The long, or underhand, spear, weighing from two to three pounds, has a light, tough bamboo shaft, from seven to eight feet long, armed with a small steel head of varying shape. This spear is held in the hand about two-thirds the distance from the point, with the knuckles turned down and the thumb along the shaft. The short, or jobbing, spear is from six to six and a half feet long, and somewhat heavier than the longer weapon. It is grasped near the butt, with the thumb up. Although easier to handle in the jungle, it permits the nearer approach of the boar and is therefore more dangerous to man and mount.

Having arrived at the bush-grown or marshland haunt of the pigs, the quarry is "reared," i.e. chased out of its cover, by a long line of beaters, usually under the command of a mounted *shikari*. Sometimes dogs and guns loaded with small shot are used to induce an animal to break cover. The mounted sportsmen, placed on the edge of the cover, attack the pig as soon as it appears, the honour of "first spear," or "spear of honour," i.e. the thrust that first draws blood, being much coveted. As a startled or angry wild boar is a fast runner and a desperate fighter the pig-sticker must possess a good eye, a steady hand, a firm seat, a cool head and a courageous heart. For these reasons the military authorities encourage the sport, which is for the most part carried on by the tent clubs of the larger Indian stations.

The following technical terms are used. "Frank," a boar enclosure. "Jhow," the tamarisk, a common cover for boars. "Jink" (of the boar), to turn sharply to one side. "Nullak," a dry water-course. "To pig," to hunt the boar. "Pug," the boar's footprint. "Paging," tracking the boar. "Ride to hog," to hunt the boar. "Rootings," marks of the pig's snout in the ground. "Sangler" (or "singular"), a boar that has separated from the "soulder." "Soulder," a family of wild swine. "Squeaker," a pig under three years. "Tusker," a full-grown boar.

See *Pig-Sticking or Hog-Hunting*, by R. S. S. Baden-Powell (London, 1889).

PIKE, ZEBULON MONTGOMERY (1779-1813), American explorer and soldier, was born in Lambertton (now a part of Trenton), New Jersey, on the 5th of January 1779, son of Zebulon Pike (1751-1834), an officer in the American army. He entered his father's company as a cadet about 1794, and became an ensign (or second lieutenant) in 1799 and first lieutenant in the same year. On the 9th of August 1805 he started with twenty men from St Louis to explore the head-waters of the Mississippi. At Prairie du Chien he met some Chippewa chiefs and induced them to expel the whisky-traders among them and to make peace with the Sioux; at the Falls of St Anthony (Sept. 23) he bought a tract of m. square at the mouth of the St Croix for a fort; and at Little Falls (in the middle of October) he built a stockade, where he left seven men. He reached Leech Lake ("Lake La Sang Sue"), which he called "the main source of the Mississippi," on the 1st of February 1806; went 30 m. farther to Cass Lake ("Red Cedar"); and, after working against British influences among the Indians, turned back, and went down the Mississippi from Dean Creek to St Louis, arriving on the 30th of April. In 1806 he was

ordered to restore to their homes 50 Osages, redeemed by the United States government from Potawatami, and to explore the country. He started on the 15th of July; and went north along the Missouri and the Osage into the present state of Kansas and probably to the Republican river in the south of the present Nebraska, where on the 29th of September he held a grand council of the Pawnees. Then (early in October), turning nearly south, he marched to the Arkansas river, which he reached on the 14th of October, and up which (after the 28th with only 16 men) he went to the Royal Gorge (Dec. 7), having first seen the mountain called in his honour Pike's Peak on the 23rd of November; and then went north-west, probably up Oil Creek from Cañon City. In searching for the Red river he came to the South Platte, marched through South Park, left it by Trout Creek pass, struck over to the Arkansas, which he thought was the Red River for which he was searching, and, going south and south-west, came to the Rio Grande del Norte (about where Alamosa, Conejos county, Colorado, is now) on the 30th of January 1807. There on the 26th of February he and a small number of his men were taken prisoners by Spanish authorities, who sent him first to Santa Fé, then to Chihuahua to General Salcedo, and by a roundabout way to the American frontier, where he was released on the 1st of July 1807. He was promoted captain (August 1806), major (May 1808), lieutenant-colonel (Dec. 1809) and colonel (July 1812). In 1808 he tried in vain to get an appropriation from Congress for himself and his men. He was military agent in New Orleans in 1809-1810, was deputy quartermaster-general in April-July 1812, and was in active service in the War of 1812 as adjutant and inspector-general in the campaign against York (now Toronto), Canada, and in the attack on York on the 27th of April 1813 was in immediate command of the troops in action and was killed by a piece of rock which fell on him when the British garrison in its retreat set fire to the magazine.

His *Account of an Expedition to the Sources of the Mississippi and through the Western Parts of Louisiana . . . and a Tour through the Interior Parts of New Spain* was published at Philadelphia in 1810; was reprinted and rearranged in London in 1811; and was published in a French version in Paris in 1812, and a Dutch version at Amsterdam in 1812-1813. The standard edition with memoir and notes by Elliott Coues was published in three volumes in New York in 1895. Some of Pike's papers taken from him in Mexico are now in the Mexican archives (Seccion de Asuntos Internacionales caja 1817-1824), and the more important were published by H. E. Bolton in the *American Historical Review*, (1907-1908), xiii, 798-827. See the sketch by Henry Whiting in vol. v., series 2, of Jared Sparks's *Library of American Biography*.

PIKE, fresh-water fishes generally distributed over the rivers and lakes of Europe, northern Asia, and North America, and forming a small family (*Esocidae*) of soft-rayed fishes. They are readily recognized by their elongate compressed body covered

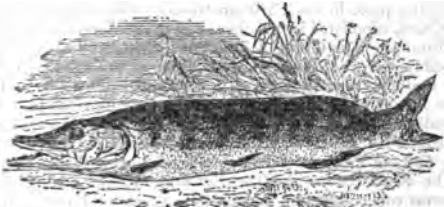

European Pike (*Esox lucius*).

with small scales, a long head, long and spatulate snout, and very large mouth armed with strong and long teeth in the jaws and broad bands of smaller teeth on the palate and tongue. The teeth point backwards or can be depressed so as to offer no obstruction to any object entering the gape, but prevent its withdrawal in the opposite direction. The dorsal and anal fins are placed far back on the tail, thus greatly increasing the propelling power of the fish, and, although pike are bad swimmers and lead rather a sedentary than a roving life, they are excelled by no other fresh-water fish in rapidity of motion when,

by a single stroke of the tail, they dash upon their prey or dart out of reach of danger. In the Old World one species only is known (*Esox lucius*), which prefers lakes and sluggish reaches of rivers to strong currents or agitated waters. Its eastward range in northern Asia is not known; it extends into Lapland in the north and into central Italy and the vicinity of Constantinople in the south, but is absent in the Iberian Peninsula. The European species occurs also in North America, and is common in the eastern United States southwards to northern Ohio. But North America is tenanted by other species of pike besides, of which the largest is the muskellunge or maskinonge of the Great Lakes (*Esox nobilior*); it commonly attains to the large size which is exceptionally recorded of *Esox lucius*. The other American pike are of smaller size, and generally named "pickerel"; but opinions as to the distinction of the species differ widely among American ichthyologists. The European pike, like its brethren, is the most voracious of fresh-water fishes; it probably exceeds the shark, to which it has been compared by many writers, in the relative quantity of food it consumes. Large specimens will seize rats or water-voles, and are said to attack even foxes and small dogs. Individuals of from 40 lb to 50 lb are not scarce, but captures of much larger ones are on record. Pike are wholesome food, and much esteemed in inland countries—the smaller (of 20 to 24 in. in length) being preferred to the larger individuals. They are prolific, and not easily exterminated in a water in which they have been once allowed to spawn. According to season and climate they spawn in April or May, and sometimes as early as February.

PIKE, a word which, with its collateral forms "pick" and "peak," has as its basic meaning that of anything pointed or tapering to a point. The ultimate etymology is much disputed, and the interrelation of the collaterals is very confused. In Old English there are two forms (*pic*), one with a long and the other with a short vowel, which give "pike" and "pick" respectively. The first form gave in the 15th century the variant "peak," first with reference to the peaked shoes then fashionable, *pekyd schons*. In Romanic languages are found Fr. *pic*, Span. *pico*, Ital. *piccare*, to pierce, &c. There are also similar words in Welsh, Cornish and Breton. The Scandinavian forms, e.g. Swed. and Nor. *piå*, are probably taken from English. While some authorities take the Celtic as the original, others look to Latin for the source. Here the woodpecker, *picus*, is referred to, or more probably the root seen in *spica*, ear of corn, and *spina*, prickle (English spike, spine). The current differentiation in meanings attached to pike, pick and peak are more or less clearly marked, though in dialects they may vary. (1) **Pike**: Apart from the use as the name of the fish (see above), probably a shortened form of pike-fish, from its sharp, pointed beak, the common uses of the word are for a long hafted weapon with sharply pointed head of iron or steel, the common weapon of the foot-soldier till the introduction of the bayonet (see **SPEAR** and **BAYONET**), and for a hill with a pointed summit, appearing chiefly in the names of such hills in Cumberland, Westmorland and North West Lancashire. It may be noticed that the proverbial expression "plain as a pike-staff" is aptly original as "plain as a pack-staff," the flat plain sided staff on which a pedlar carried and rested his pack. The use of "pike" for a highway, a toll-gate, &c., is merely short for "turnpike." (2) **Pick**: As a substantive this form is chiefly used of the common tool of the navy and the miner, consisting of a curved double-ended head set at right angles to the handle, one end being squared with a chisel edge, the other pointed, and used for loosening and breaking hard masses of earth, coal, &c. (see **TOOLS**). The other name for this tool, "pickaxe" is a corruption of the earlier *pickox*, Fr. *picois*, M. Lat. *picorium*, formed from Fr. *pic*, the termination being adapted to the familiar English "axe." The sense-development of the verb "to pick" is not very clear, but the following meanings give the probable line: to dig into anything like a bird with its beak, in order to extract or remove something, to gather, pluck, hence to select, choose. (3) **Peak**: The chief uses are for the front of a cap or hat projecting sharply over the eyes, for the part of a ship's

hold where it narrows towards the bows, the fore-peak; or towards the stern, the after-peak, for the top corner of a sail extended by a gaff, or for the projecting end of the gaff itself, and for a pointed or conical top of a hill or mountain. The name of the high table-land district in Derbyshire is not to be connected with this word, but probably retains the name of an old English demon, *Peac* (see *PEAK*, *THE*).

PIKE-PERCH (*Lucioperca*), fresh-water fishes closely allied to the perch, but with strong canine teeth standing between the smaller teeth of the jaws and palate. They resemble the pike in their elongate body and head, and they are also most dangerous enemies to other fresh-water fishes, though they compensate for their destructiveness by the excellent flavour of their flesh. In Europe two species occur, the more celebrated being the "Zander" of North Germany or "Schiel" of the Danube (*Lucioperca sandra*); strange to say, it is absent in the system of the Rhine. It prefers the quiet waters of large rivers and clear deep lakes, in which it reaches a weight of 25 lb or 30 lb. The second (*Lucioperca wolgensis*) is limited to rivers in southern Russia and Hungary. In North America several pike-perches have been described, but in the most recent works only two are distinguished, viz. *Lucioperca americana*, which grows to a weight of 20 lb, and the much smaller *Lucioperca canadensis*; both are abundant in the Canadian lakes and upper Mississippi, and the latter also in the Ohio.

PIKE'S PEAK, a famous peak of the Rampart range of the Rocky Mountains in El Paso county, Colorado, U.S.A., about 6 m. W. of Colorado Springs. Though surpassed in altitude (14,108 ft.) by many summits in the state, no other is so well known. The commanding appearance of the peak is very fine. To the south are Cameron Cone (10,685 ft.), Mt Sackett, Mt Bald (13,074), Mt Rosa (11,427), and Mt Cheyenne (9,407). From the summit the magnificent Sangre de Cristo range is in the foreground, while on a clear day not only its southernmost summit, Blanca Peak (14,300 ft.) is visible, but also the Spanish Peaks (12,708 and 13,623 ft.) 100 m. to the south, and Long's Peak 100 m. to the north, and between them Mt Lincoln, Gray's Peak and other giants. At the base of the mountain are Manitou and Colorado Springs, whence tourists can make the ascent of the peak (in summer safe and relatively simple) on horseback or by a cog-railway, 8.75 m. long (opened in 1891), which makes a total ascent of 8100 ft. (maximum gradient 1 in 4) to the summit. In 1905 a powerful searchlight was erected on the summit.

Pike's Peak was discovered in November 1806 by Lieut. Zebulon M. Pike. He attempted to scale it, but took the wrong path and found himself at the summit of Cheyenne Mountain. He pronounced the mountain unclimbable. In 1819 it was successfully climbed by the exploring party of Major S. H. Long.

PILASTER (Fr. *pilastre*, med. Lat. *pilastrum*, from *pila*, a pillar), in architecture, an engaged pier projecting slightly from the wall, and employed to divide up and decorate a wall surface or to serve as respond to a column. One of the earliest examples (c. 100 B.C.) exists in the propylæa at Priene in Asia Minor, where it tapers towards the top. Pilasters have bases and capitals and are frequently fluted like columns. The Romans would seem to have preferred semi-detached columns, but for their amphitheatres sometimes pilasters are employed, as in the upper story of the Colosseum. In the revival of Classic architecture, and especially in Italy, architects seem to have considered that no building was complete without a network of pilasters on every storey, and France and England followed their example; and not only externally but inside the great cathedrals and churches the pilaster is adopted as the simplest and best way of dividing the bays.

PILATE, PONTIUS, the Roman governor of Judæa under whom Jesus Christ suffered crucifixion. Of equestrian rank, his name Pontius suggests a Samnite origin, and his cognomen in the gospels, *pilateus* (if derived from the *pileus* or cap of liberty), descent from a freedman. In any case he came in A.D. 26 from the household of Tiberius, through the influence

of Sejanus, to be procurator over part of the imperial province of Syria, viz. Judæa, Samaria and Idumæa. He ruled ten years, quarrelled almost continually with the Jews—whom Sejanus, diverging from the Caesar tradition, is said to have disliked—and in A.D. 36 was recalled. Before he arrived Tiberius died, and Pilate disappears from history. Eusebius relates (*Hist. eccl. li. 7*)—but three centuries later and on the authority of earlier writers unnamed—that he was exiled to Gaul and committed suicide at Vienne.

Pilate kept the Roman peace in Palestine but with little understanding of the people. Sometimes he had to yield; as when he had sent the standards, by night, into the Holy City, and was besieged for five days by suppliants who had rushed to Caesarea (Jos. *Ant. 31*; B. J. ii. ix. 2, 3); and again when he hung up inscribed shields in Jerusalem, and was ordered by Tiberius to remove them to the other city (*Philo ad Gaium 38*). Sometimes he struck more promptly; as when the mob protested against his using the temple treasure to build an aqueduct for Jerusalem, and he disguised his soldiers to disperse them with clubs (Jos. *Ant. xviii. 3, 2*); or when he "mingled the blood" of some unknown Galileans "with their sacrifices" (Luke xiii. 1); or slew the Samaritans who came to Mt Gerizim to dig up sacred vessels hidden by Moses there (Jos. *Ant. xviii. 4, 1*)—an incident which led to his recall. Philo, who tells how any suggestion of appeal by the Jews to Tiberius enraged him, sums up their view of Pilate in Agrippa's words, as a man "inflexible, merciless, obstinate."

A more discriminating light is thrown upon him by the New Testament narratives of the trial of Jesus. They illustrate the right of review or *recognitio* which the Romans retained, at least in capital causes; the charge brought in this case of acting *adversus majestatem populi romani*; the claim made by Jesus to be a king; and the result that his judge became convinced that the claimant was opposed neither to the public peace nor to the civil supremacy of Rome. The result is explained only by the dialogue, recorded exclusively in John, which shows the accused and the Roman meeting on the highest levels of the thought and conscience of the time. "I am come to bear witness unto the truth. . . . Pilate answered, What is truth?" Estimates of Pilate's attitude at this point have varied infinitely, from Tertullian's, that he was "already in conviction a Christian"—*jam pro sua conscientia Christianus*—to Bacon's "jesting Pilate," who would not stay for a reply. We know only that to his persistent attempts thereafter to get his proposed verdict accepted by the people, came their fatal answer, "Thou art not Caesar's friend," and that at last he unwillingly ascended the *beta* (in this case a portable judgment-seat, brought for the day outside the Praetorium), and in such words as *Ihs ad crucem* "delivered Him to be crucified."

Pilate's place in the Christian tragedy, and perhaps also in the Creed, stimulated legend about him in two directions, equally unhistorical. The *Gospel of Nicodemus*, written by a Christian (possibly as early, Tischendorf thought, as the middle of the 2nd century), repeats the trial in a dull and diluted way; but adds not only alleged evidence of the Resurrection, but the splendid vision of the *descensus ad inferos*—the whole professing to be recorded in the *Acta Pilati* or official records of the governor. The *Epistola Pilati* gives Pilate's supposed account to Tiberius of the Resurrection; and the *Paradosis Pilati* relates how Tiberius condemned him and his wife Procla or Proculla, both Christian converts. All this culminates in Pilate being canonized in the Abyssinian Church (June 25), and his wife in the Greek (Oct. 27). On the other hand the *Mors Pilati* tells how when condemned by the emperor he committed suicide; and his body, thrown first into the Tiber and then the Rhone, disturbed both waters, and was driven north into "Lusania," where it was plunged in the gulf near Lucerne and below Mt Pilatus (originally no doubt *Pileatus* or cloud-capped), from whence it is raised every Good Friday to sit and wash unavailing hands.

BIBLIOGRAPHY.—For legends see Tischendorf's *Evangelia apocrypha* (1863) and *Apocryphal Gospels*, Ante-Nicene Lib. (1880).

The earlier Pilate literature, to the extent of 110 treatises, chiefly of the 17th and 18th centuries, is enumerated in G. A. Müller's *Pontius Pilatus der fünfte Prokurator von Judäa* (Stuttgart, 1888). See *in loco* in the following English or translated histories of the life or time of Jesus, Theodor Keim, E. Schröder, A. Edersheim, J. P. Lange, Bernhard Weiss and F. W. Farrar; *Expositor* (1884) p. 107 and (1900) p. 59; also H. Peter, "Pontius Pilatus, der römische Landpfleger in Judäa," in *Neue Jahrb. f. d. kl. Altertum* (1907). Sir James Fitzjames Stephen, in his *Liberty, Equality and Fraternity* (1873), p. 87, starts the question, "Was Pilate right in crucifying Christ?" his somewhat paradoxical answer is criticised in *The Trial of Jesus Christ, a legal monograph*, by A. Taylor Innes (1899). (A. T. I.)

PILATUS, LEO, or LEONTIUS [LEONZIO PILATO] (d. 1366), one of the earliest promoters of Greek studies in western Europe, was a native of Thessalonica. According to Petrarch, he was a Calabrian, who posed as a Greek in Italy and as an Italian abroad. In 1360 he went to Florence at the invitation of Boccaccio, by whose influence he was appointed to a lectureship in Greek at the Studio, the first appointment of the kind in the west. After three years he accompanied Boccaccio to Venice on a visit to Petrarch, whom he had already met at Padua. Petrarch, disgusted with his manners and habits, despatched him to Constantinople to purchase MSS. of classical authors. Pilatus soon tired of his mission and, although Petrarch refused to receive him again, set sail for Venice. Just outside the Adriatic Gulf he was struck dead by lightning. His chief importance lies in his connexion with Petrarch and Boccaccio. He made a bald and almost word for word translation of Homer into Latin prose for Boccaccio, subsequently sent to Petrarch, who owed his introduction to the poet to Pilatus and was anxious to obtain a complete translation. Pilatus also furnished Boccaccio with the material for his genealogy of the gods, in which he made an ostentatious display of Greek learning.

See Gibbon, *Decline and Fall*, ch. 66; G. Voigt, *Die Wiederbelebung des klassischen Alterthums* (1893); H. Hody, *De Graecis illustribus* (1742); G. Tiraboschi, *Storia della letteratura italiana*, v. 691.

PILAU, a favourite Eastern dish, consisting essentially of rice, boiled with mutton or other meat, fowl or fish, and flavoured with spices, raisins, &c. The word appears in Persian, Turkish and Urdu, and has been adopted in European languages. The form *pilaff*, showing the Turkish pronunciation, is also common.

PILCHARD (in earlier 16th century forms *pylcher, pilchar*; of unknown origin; the Fr. *pileur* is adapted from Eng.), *Clupea pilchardus*, a fish of the herring family (*Clupeidae*), abundant in the Mediterranean and on the Atlantic coasts of Europe, north to the English Channel. Sardine is another name for the same fish, which on the coast of Brittany and Normandy is also called *célan* or *céléren*. It is readily distinguished from the other European species of *Clupea*. The operculum is sculptured with ridges radiating and descending towards the suboperculum; the scales are large, about thirty along the lateral line, deciduous; the ventral fins are inserted below, or nearly below, the middle of the base of the dorsal fin; the dorsal fin has seventeen or eighteen, the anal from nineteen to twenty-one rays. A small blackish spot in the scapular region is very constant, and sometimes succeeded by other similar marks. There are no teeth on the palate; pyloric appendages exist in great numbers; the vertebrae number fifty-three. The pilchard is one of the most important fishes of the English Channel. It spawns at a distance from the shore, and its eggs are buoyant, like those of many other marine fishes and unlike those of the herring, which are adhesive and demersal, *i.e.* develop under water. The egg of the pilchard is very easily distinguished from other pelagic eggs by the unusually large space separating the vitelline membrane from the contained ovum. Spawning takes place in summer, the season extending from June to October. When commencing their migrations towards the land the shoals consist of countless numbers, but they break up into smaller companies near the shore. Pilchards feed on minute crustaceans and other pelagic animals and require two or three years before they attain their full size, which is about 10 in. in length. The sardines of the west coast of France, which are tinned in oil for export, are immature fish of the same stock as those taken

on the coasts of Cornwall; they are 5 to 7½ in. in length, and though such fish occur also on the Cornish coast it is only in small numbers and for brief periods. In the Mediterranean the sardine does not exceed 7½ in. in length when mature. On the Pacific coast of America, in New Zealand and in Japan a pilchard occurs (*Clupea sagax*) which in its characters and habits is so similar to the European pilchard that its general utilization is deserving of attention. Immense shoals are reported to visit the east coast of Otago every year in February and March. *Clupea scombrina* is the "oil sardine" of the east coast of India. (J. T. C.)

PILE, an homonymous word, of which the main branches are (1) a heap, through Fr. from *pila*, pillar; (2) a heavy beam used in making foundations, literally a pointed stake, an adaptation of Lat. *pilum*, javelin; (3) the nap on cloth, Lat. *pilus*, hair. In the first branch the Lat. *pila* (for *pigla*, from root of *pingere*, to fasten) meant also a pier or mole of stone, hence any mass of masonry, as in Fr. *pile*. In English usage the word chiefly means a "heap" or "mass" of objects laid one on the top of the other, such as the heap of faggots or other combustible material on which a dead body is cremated, "funeral pile," or on which a living person is burnt as a punishment. It also is applied to a large and lofty building, and specifically, to a stand of arms, "piled" in military fashion, and to the series of plates, "galvanic" or "voltaic piles," in an electric battery. The modern "head and tail" of a coin was formerly "cross and pile," Fr. *croix et pile*, in modern Fr. *face et pile*. In the older apparatus for minting the die for the reverse was placed on a small upright pillar, *pile*, the other on a puncheon known as a "trussell" (Fr. *trousseau*). The common name of the disease of haemorrhoids (*q.v.*) or "piles" is probably an extension of this word, in the sense of mass, swelling, but may be referred to the Lat. *pila*, ball. The name of the *pilum*, or heavy javelin (lit. pounder, pestle, from *pisere*, *pisere*, to beat), the chief weapon of the ancient Roman infantry, was adopted into many Teutonic languages in the sense of dart or arrow, cf. Germ. *Pfeil*; in English it was chiefly used of a heavy stake with one end sharpened, and driven into swampy ground or in the bed of a river to form the first foundations for a building; the primitive lake-dwellings built on "piles" are also known as "pile-dwellings." For the use of piles in building see FOUNDATIONS and BRIDGES. In heraldry a charge represented by two lines meeting in the form of an arrow head is known as a "pile," a direct adaptation probably of the Lat. *pilum*. The division of this intricate word, followed here, is that adopted by the *New English Dictionary*; other etymologists (*e.g.* Skeat, *Etym. Dict.*, 1898) arrange the words and their Latin originals somewhat differently.

PILGRIM, a wanderer, traveller, particularly to a holy place (see PILGRIMAGE). The earliest English forms are *pilegrim* or *pelegrim*, through Fr. *pèlerin* (the original O. Fr. *pelegrin* is not found), from Lat. *peregrinus*, a stranger, foreigner, particularly a resident alien in Rome (see PRAETOR, and ROMAN LAW). The Lat. *pereger*, from which *peregrinus* is formed, meant "from abroad," "travelled through many lands" (*p̄er*, through, and *ager*, country).

It was customary for pilgrims to bring back as proof of their pilgrimage to a particular shrine or holy place a badge, usually made of lead or pewter, bearing some figure or device identifying it with the name or place. These "pilgrim signs" are frequently alluded to in literature—notably in the *Canterbury Tales* and in *Piers Plowman*. The British Museum and the Musée Cluny in Paris have fine collections of them, mainly dredged from the Thames and the Seine. The badges were generally worn fastened to the pilgrim's hat or cape. Among the best known are those of the cockle or scallop shell of St. James of Compostella in Spain; the "vernicle," a representation of the miraculous head of Christ; the *vera icon*, true image, on St. Veronica's handkerchief, at Rome, or of the Abgar portrait at Genoa, of "a vernicle hadde he sowed on his cappe" (*Canst. Tales*, "Prol," 685); the Aiens badge of the head of John the Baptist on the charger, the cathedral claiming the custody of the relic from 1206 (fig. 1); and the palm branches or cross of palm leaf, the

badge of the "Palmer's" pilgrimage to the Holy Land. The most common of the English pilgrims' signs are those of the shrine of Thomas Becket at Canterbury, the greatest centre of pilgrimage in England. These take a variety of forms,



(From Andrews' Church Treasury.)
FIG. 1.—Pilgrim's Sign, from
the cathedral at Amiens.



(From Andrews' Church Treasury.)
FIG. 2.—Pilgrim's Sign, from
Canterbury.

sometimes a simple T, sometimes a bell marked *campana Thome*, the Canterbury bell, most often a figure of the saint, sometimes seated, sometimes riding on a horse, and carrying his episcopal cross, and with hand uplifted in benediction (fig. 2). Sometimes the badges took the shape of small *ampullae*, or vases, as in the case of the badges of the shrine of Our Lady of Walsingham, which were marked with a W and crown.

See W. Andrews, *Church Treasury* (1898), article "Pilgrims' Signs," by Rev. G. S. Tyack; and *Guide to Medieval Room, British Museum*, p. 69.

The English "Pilgrims' Way."—From Winchester, in Hampshire, to Canterbury, in Kent, runs a road or way which can still be traced, now on the present made roads, now as a lane, bridle path, or cart track, now only by a line of ancient yews, hollies or oaks which once bordered it. To this old track the name of "pilgrims' way" has been given, for along it passed the stream of pilgrims coming through Winchester from the south and west of England and from the continent of Europe by way of Southampton to Canterbury Cathedral to view the place of the martyrdom of Thomas Becket, in the north transept, to the relics in the crypt where he was first buried after his murder, in 1170, and the shrine in the Trinity Chapel which rose above his tomb after the translation of the body in 1220. There were two festivals for the pilgrimage, on the 29th of December, the day of the martyrdom, and on the 7th of July, the day of the translation. The summer pilgrimage naturally became the most popular. In 1538 the shrine was destroyed and the relics of the saint scattered, but the great days of the pilgrimage had then passed. Erasmus gives a vivid picture of the glories of the shrine and of all that was shown to the pilgrims on his visit with Colet to Canterbury in 1514.

The principal villages, towns and places near or through which the way passed are as follow: Winchester, Alresford, Ropley, Alton, Farnham (here the way follows the present main road), Seale, Puttenham, by the ruined chapel of St Catherine, outside Guildford, near where the road crosses the Wey above Shalford, and by the chapel of St Martha, properly of "the martyr," now restored and used as a church, Albury, Shere, Gomshall, Dorking (near here the Mole is crossed), along the southern slope of Boxhill to Reigate, then through Gatton Park, Merstham, Otford, Wrotham, after which the Medway was crossed, Burham, past the megalithic monument Kit's Coty House, and the site of Boxley Abbey, the oldest after Waverley Abbey of Cistercian houses in England, and famous for its miraculous image of the infant saint Rumbold, and the still more famous winking rood or crucifix. The road passes next by Hollingbourne, Lenham and Charing. At Otford, Wrotham and Charing were manor-houses or rather palaces of the archbishops of Canterbury; at Hollingbourne was a manor of the priors of Christchurch. After

¹ Shalford Fair, the chapels on the two hills and the Surrey hills are probably the scene of Bunyan's *Pilgrim's Progress*, see E. Renouard James, *Notes on the Pilgrim's Way in West Surrey* (1871).

Hollingbourne come Westwell, Eastwell, Boughton Aluph, Godmersham, Chilham Castle, and then at Harbledown, where are the remains of the Hospice of St Nicholas, the road joins Watling Street, by which came the main stream of pilgrims from London, the North and the Midlands.

This road, although its name of the Pilgrims' Way has for long confined it to the road by which the pilgrims came to Canterbury from Winchester, follows a far older track. Right back into British and even older times the main direction which commerce and travellers followed across southern and western England to the Straits of Dover and the Continent lay from Canterbury along the southern chalk slope of the North Downs to near Guildford, then by the Hog's Back to Farnham. At this point the oldest track went across Salisbury Plain towards Stonehenge and so on to Cornwall. From Farnham westward the only portion of this the oldest track that can now be traced is a small portion that still bears the name of the Harrow (i.e. hoary, old) road. It was in early times abandoned for the road from Winchester to which the stream of travel and commerce from the Continent and the south and south-west of England was diverted.

The "pilgrims' way" has been traced fully in Mrs Ady's book *The Pilgrims' Way* (1893), and the older track in the fullest detail in Hilaire Belloc's *The Old Road* (1904).

The American "Pilgrim Fathers."—In American history the name "Pilgrims" is applied to the earliest settlers of the colony of Plymouth, Massachusetts, and more specifically to the first company of emigrants, who sailed in the "Mayflower" in 1620. They were from the beginning Separatists from the Church of England; they had established Independent (Congregational) churches at Scrooby and Gainsborough early in the 17th century, and some of them had fled to Amsterdam in 1608 to avoid persecution, and had removed to Leiden in the following year. They sailed from Delftshaven late in July 1620, from Southampton on the 5th of August, from Plymouth on the 6th of September, and late in December 1620 founded the colony of Plymouth, Massachusetts. See MASSACHUSETTS; PLYMOUTH, and MAYFLOWER.

PILGRIMAGE (Fr. *pèlerinage*, Lat. *peregrinatio*), a journey undertaken, from religious motives, to some place reputed as sacred. These journeys play an important rôle in most pre-Christian and extra-Christian religions: in the Catholic Church their acceptance dates from the 3rd and 4th centuries.

I. The Pilgrimage in pre-Christian and non-Christian Religions.—To the Germanic religions the pilgrimage is unknown. On the other hand, it is an indigenous element, not only in the creeds of Asia, but in those of the ancient seats of civilization on the Mediterranean. The fundamental conception is always that the Deity resides—or exercises a peculiarly powerful influence—in some definite locality; and to this locality the devout repair, either in reverence of their god, or in quest of his assistance and bounty. Thus, as the cult of a particular divinity spreads farther and farther, so the circle expands from which are drawn those who visit his sanctuary.

One of the oldest homes of the pilgrimage is India. There the army of devotees tends more especially to the Ganges—the hallowed river of Hindu belief. On the Ganges lies Benares, the holy city of Brahminism: and to look on Benares, to visit its temples, and to be washed clean in the purifying river, is the yearning of every pious Indian. Even Buddhism—originally destitute of ceremonial—has adopted the pilgrimage; and the secondary tradition makes Buddha himself determine its goals: the place where he was born, where he first preached, where the highest insight dawned on him, and where he sank into Nirvana. The four ancient sacred resorts are Kapilavastu, Gaya, Benares and Kusinagara.

In Syria, the temple of Atargatis in Hierapolis was an immemorial resort of pilgrims. In Phœnicia, a similar significance was enjoyed by the shrine of Astarte, on the richly-watered source of the river Adonis, till, as late as the 4th century after Christ, it was destroyed by Constantine the Great. In Egypt, the great annual and monthly festivals of the indigenous gods

gave rise to all manner of religious expeditions. Even among the Israelites, the visitation of certain cult-centres prevailed from remote antiquity; but, when the restriction of Yahweh-worship to Jerusalem had doomed the old shrines, the Jewish pilgrimages were directed solely to the sanctuary on Mt. Moria.

Among the Greeks the habit was no less deeply rooted. Just as the inhabitants of each town honoured their tutelary deity by solemn processions to his temple, so, at the period of the Olympic games, the temple of Zeus at Olympia formed the goal of multitudes from every Hellenic country. No less powerful was the attraction exercised by the shrines of the oracular divinities, though the influx of pilgrims was not limited to certain days, but, year in and year out, a stream of private persons, or embassies from the city-states, came flowing to the temple of Zeus in Dodona or the shrine of Apollo at Delphi.

The unification of the peoples of antiquity in the Roman Empire, and the resultant amalgam of religions, gave a powerful impetus to the custom. For, as East and West still met at the old sanctuaries of Greece, so—and yet more—Greece and Rome repaired to the temples of the southern and eastern deities. In the shrine of Isis at Philae, Europeans set up votive inscriptions on behalf of their kindred far away at home, and it may be surmised that even among the festival crowds at Jerusalem a few Greeks found place (John xii. 20).

The pilgrimage, however, attained its zenith under Islam. For Mahomet proclaimed it the duty of every Mussulman, once at least in his life, to visit Mecca; the result being that the birth-place of the Prophet is now the religious centre of the whole Mahomedan world (see MAHOMEDAN RELIGION; CARAVAN; MECCA).

II. *The Pilgrimage under Christianity.*—The pilgrimages of Christianity presuppose the existence of those of paganism; but it would be an error to maintain that the former

Origin were a direct development of the latter. For primitive Christianity was devoid of any point by which these journeys of devotion might naturally have been suggested. It was a religion without temples, without sanctuaries, and without ceremonial. The saying of the Johannine Gospel—that God is to be adored neither in Jerusalem nor on Gerizim, but that His true worshipper must worship Him in spirit and in truth—is in complete harmony with the old Christian piety. And, accordingly, in the ancient Christian literature, we find no trace of a conception that the believer should visit a definite place in order to pay homage to his Master. The evolution of the Christian pilgrimage moved on other lines.

Cicero finely observes that, in Athens, the glorious architecture caused him less pleasure than did the thought of the great men whose work was done in its midst—"how here one had lived, and there fallen asleep; how here another had disputed, and there lay buried" (*De Legg.* ii. 2). This feeling was not weakened by the advent of Christianity, in fact, we may say that it was appreciably strengthened. Cicero had already compared the sites consecrated by the memory of some illustrious name with those hallowed by recollections of a loved one. But with the Christian, when his Redeemer was in question, both motives coincided: for there the greatest was also the dearest.

In this devotion to the memory of Jesus, we find the key to the origin of the Christian pilgrimage: the faithful repaired to those places which were invested with memories of their Lord's earthly life. And these journeys must certainly date from the 2nd century. For Origen (d. 254) mentions that in Bethlehem the cave was shown where Christ was born, and in it the manger in which Mary made the bed of her child. The site must have been much visited long before this, since Origen remarks that it was common knowledge, even among the infidels, that there was the birthplace of that Jesus whom the Christians worshipped (*Contr. Cels.* i. 51). But those who visited Bethlehem must certainly have visited Jerusalem and the places there, so rich in memorials of their Master. And the sympathy of Christendom soon led them beyond this immediate circle. The anonymous author of the *Cohortatio ad Græcos*, a work of the 2nd century, visited the remnants of those cells, in which—so legend related—

the seventy interpreters laboured on their version of the Old Testament: nor, when he came to Cumæ in Campania, did he fail to have shown him the old shrine of the Sibyl (*Coh. ad Gr.* 13 and 37). Soon we begin to hear the names of the pilgrims. In the course of the 3rd century, as Jerome relates, Firmilian, bishop of Caesarea in Cappadocia, travelled to Palestine to view the sacred places (*De Vir. ill.* 54); while, according to Eusebius, a second bishop from Cappadocia, Alexander by name, visited Jerusalem in order to pray and acquaint himself with the holy sites, and was there invited by the community to remain with them and assume the episcopate of the aged Narcissus (*Hist. eccl.* vi. 11). With regard to his own times—the early years of the 4th century—the same authority recounts that believers kept streaming to Palestine from all regions, there to offer their prayers at a cavern shown on the Mount of Olives (*Demonstr. evang.* vi. 18).

This statement, that the Christians of the 3rd and 4th centuries were in the habit of visiting Jerusalem for prayer, proves that the non-Christian conception of the religious pilgrimage had already entered the sphere of Christian thought. That men travelled for purposes of prayer implies acceptance of the heathen theory of sanctuaries which it is an act of piety to visit. We may regret the fact, for it sullied the purity of primitive Christian thought. Nevertheless, it is clear that the development was inevitable. As soon as the non-Christian ideas of priests, sacrifices, houses of the god, and so forth, were naturalized in the Christianity of the 3rd century, it was but a short step to the belief in holy places.

III. *The Pilgrimage in the Ancient Church.*—In the passages cited above, Bethlehem and the Mount of Olives figure as the main goal of the pilgrim; and on the Mount of *The East*, Olives the mind must naturally turn to the Garden

of Gethsemane and the scene of the Ascension. It may seem surprising that there is no mention of Golgotha and the Sepulchre. But the visitation of these sites was rendered impossible to the Christians by the destruction of Jerusalem and the erection of the town of Aelia Capitolina. They had not forgotten them; but the grave was concealed under a mound of earth and stones—a profanation probably dating from the siege of the city and Titus's attack on the second wall. On the summit of this mound there stood, in the days of Eusebius, a sanctuary of Venus (*Eus. Vit. Const.* iii. 26, 30). The Sepulchre and the Hill of the Crucifixion were lost to the Christian pilgrim; and, consequently, before the era of Constantine, the one holy site in the town of Jerusalem was the so-called *Coenaculum*, which received its name in later years. It lay south of the city, near the outer wall, and, if Epiphanius is to be believed, was already in existence when Hadrian (130-131) visited Jerusalem (*De mens.* 14). It was regarded as the house, in which—according to the Acts of the Apostles (xii. 12 sqq.)—Mary, the mother of John Mark, lived; and the belief was that there the Lord held the Last Supper, and that there the eleven assembled after the Ascension. It was there, also, that the scene of the Pentecostal effusion of the Spirit was laid (cf. Cyril. *Hierus. Cat.* xvi. 4).

The pilgrimage to Palestine received a powerful impetus from the erection of the memorial churches on the holy sites, under Constantine the Great, as described by Eusebius in his biography of the emperor (iii. 25 sqq.). At the order of Constantine, the shrine of Venus above mentioned was destroyed, and the accumulated rubbish removed, till the ancient rock-foundation was reached. There the cave was discovered in which Joseph of Arimathea had laid the body of Jesus; and above this cave and the Hill of the Crucifixion the imposing church of the Holy Sepulchre was built (A.D. 326-336). The churches in Bethlehem and on the Mount of Olives were erected by Helena, the mother of Constantine, who herself undertook the pilgrimage to the Holy Land. These churches were then endowed with new sanctuaries of miraculous powers; and relics of Christ were found in the shape of the Cross and the nails. Eusebius, the contemporary of Constantine, is silent on this point. To his continuators, on the other hand, it is an established fact that Helena brought all three crosses to light, and ascertained

the genuine Cross by the instrumentality of a miracle, in addition to discovering the nails of the Crucifixion (Rufin. i. 7; Socr. i. 17; Sozomen. ii. 1; Theod. i. 17). It is impossible to fix the date at which the supposititious relics were introduced into the church of the Sepulchre: it is certain, however, that in the 5th century the Cross was there preserved with scrupulous reverence, and accounted the highest treasure of the sanctuary.

After the 4th century, monks and nuns begin to form no inconsiderable part of the pilgrimages—a fact which is especially manifest from the numerous notices to be found in Jerome, and the narratives of Theodoret in the *Historia religiosa*. In fact, many were inclined to regard a journey to Jerusalem as the bounden duty of every monk—an exaggerated view which led to energetic protests, especially from Gregory of Nyssa, who composed a monograph on the pilgrimages (*De iis qui adveniunt Hierosol.*). Jerome, like Gregory, insists on the point that residence in Jerusalem has in itself no religious value: it is not locality, but character, that avails, and the gates of Heaven are as open in Britain as in Jerusalem (*Ep.* 58, 3). These utterances, however, must not be misinterpreted. They are not directed against the pilgrimage in itself, nor even against the belief that prayer possesses special efficacy on sacred ground, but solely against the exaggerated developments of the system.

The theologians of the 4th and 5th centuries were at one with the masses in recognizing the religious uses of the pilgrimages. Jerome in particular considered it an act of faith for a man to offer his prayers where the feet of the Lord had stood, and the traces of the Birth, of the Cross, and of the Passion were still to be seen (*Ep.* 47, 2).

We may gain some impression of the mood in which the pilgrims completed their journey, when we read how Paula, the friend of Jerome, expresses herself on her visit to the church of the Sepulchre: "As oft as we enter its precincts we see the Saviour laid in the shroud, and the angel seated at the feet of the dead!" (Hieron. *Ep.* 46, 2). She assured Jerome that, in the church of the Nativity at Bethlehem, she beheld, with the eye of faith, the Christ-child wrapped in swaddling clothes (*Ep.* 208, 10). But with these thoughts, others of an entirely different stamp were frequently blended. Pilgrimages were conceived as means to ensure an answer to particular prayers. So, for example, Eudocia, the wife of Theodosius II., vowed to undertake a pilgrimage to Jerusalem, if she should see her daughter married. (Socr. *Hist. eccl.* vii. 47). And, closely as this approaches to pagan ideas, the distinction between paganism and Christianity is completely obliterated when we find the hermit Julian and his companions travelling to Sinai in order to worship the Deity there resident (Theod. *Hist. rel.* 2).

With the number of the pilgrims the number of pilgrim-resorts also increased. Of Jerusalem alone Jerome relates that the places of prayer were so numerous that it was impossible to visit them all in one day (*Ep.* 46, 9). In the Holy Land the list was still longer: the natives were ready to show everything for which the foreigners inquired, and the pilgrim was eager to credit everything. In her expedition to the East, the Paula mentioned above visited, among other places, Sarepta and Caesarea. In the first-named place she was shown the tower of Elijah; in the second, the house of Cornelius, that of Philip, and finally the grave of the four virgins. At Bethlehem she saw, in addition to the church of the Nativity, the grave of Rachel; at Hebron the hut of Sarah, in which the swaddling clothes of Isaac and the remains of Abraham's oak were on view (Hieron. *Ep.* 108). A similar picture is given in the *Travels* of the so-called Silvia Aquitana, who seems, in reality, to have been a Spanish nun, named Etheria or Eucheria. She went as a pilgrim to Jerusalem (c. 380), and from there traversed the whole of Palestine, in order to visit every site which was consecrated by memories of the Lord's earthly life. Nor did she neglect the scenes of patriarchal history. Of greater antiquity is the concise account of his travels by an anonymous

pilgrim, who, in A.D. 333, undertook the journey from Borsacrus to Palestine. The *Itinerary* of the African Theodosius who visited the East between A.D. 520 and A.D. 530 is of later date (P. Geyer, *Itin. hierosol. sacc.* iv-viii.).

While pilgrim-resorts were thus filling the East, their counterparts began to emerge in the West. And here the starting-point is to be found in the veneration of martyrs. Care for the tombs of martyrs was sanctioned by immemorial custom of the Church; but, in this case also, a later age failed to preserve the primitive conception in its purity; and Augustine himself was obliged to defend the usage of the Church from the imputation that it implied a transference of heathen ceremonial to the sphere of Christianity (*Contr. Faust.* xx. 21). The martyrs were the local heroes of particular communities; but there were men whose life and death were of significance for the whole of Christendom—the apostles. Of these Peter and Paul had suffered martyrdom in Rome, and it was inevitable, from the nature of the case, that their graves should soon become a resort, not only of Romans born, but of strangers also. True, the presbyter Caius (c. 200) who first mentions the situation of the apostolic tombs on the Vatican and the road to Ostia, and refers to the memorials there erected, has nothing to say of foreign Christians journeying to Rome in order to visit them. And though Origen travelled to Rome, it was not to view the graves of dead men, but to establish relations with the living flock (Euseb. *Hist. eccl.* ii. 25, 7; vi. 14, 10); still, it is certain that the Roman cemeteries were visited by numerous pilgrims even in the 3rd century: for the earliest *grafitti* in the papal crypt of the Coemeterium Callisti must date from this period (De Rossi, *Roma sotter.* i. 253 sqq.; Kraus, *Rom. Solt.* 148 sqq.). And if the tombs of the popes were thus visited, so much more must this hold of the tombs of the apostles. After these, the most frequented resort at Rome in the 4th century was the grave of Hippolytus. The poet Prudentius describes how, on the day of the martyr's death, an innumerable multitude of pilgrims flocked round the site. Even on ordinary days arrivals and departures were almost incessant—foreigners being everywhere seen mingled with the native Latins. They poured balsam on the sepulchre of the saint, washed it with their tears, and covered it with their kisses, in the belief that they were thus assuring themselves of his intercession or testifying their gratitude for his assistance. Prudentius says of himself, that whenever he was sick in soul or body, and prayed there, he found help and returned in cheerfulness: for God had vouchsafed His saint the power to answer all entreaties (*Perist.* xi. 175 sqq.). Paulinus of Nola (d. 431) concurs—his custom being to visit Ostia each year, and Rome on the apostolic anniversaries (*Ep.* 20, 2; 45, 1). Next to Rome the most popular religious resort was the tomb of Felix of Nola (*August. Ep.* 78, 3); while in Gaul the grave of St Martin at Tours drew pilgrims from all quarters (Paul. Nol. *Ep.* 17, 4). Africa possessed no sanctuary to compete with these; but we learn from Sulpicius Severus (c. 400) that the tomb of Cyprian seems to have been visited even by a Gaul (*Dial.* i. 3).

The motive that drew the pilgrims to the graves of the saints is to be found in the conviction, expressed by Prudentius, that there divine succour was certain; and hence came the belief in a never-ending series of miracles there performed (cf., e.g. Ennod. *Ticin. Lib. pro syn.* p. 315). Doubt was unknown. St Augustine observes that, though Africa was full of martyrs' tombs, no miracle had been wrought at them so far as his knowledge extended. This, however, did not lead him to doubt the truth of those reported by others—a fact that is somewhat surprising when we reflect that the phenomenon caused him much disquiet and perplexity. Who, he asks, can fathom the design of God in ordaining that this should happen at one place and not at another? And eventually he acquiesces in the conclusion that God, who gives every man his individual gift at pleasure, has not willed that the same powers should have efficacy at every sepulchre of the saints (*Ep.* 78, 3).

IV. *The Pilgrimage in the Middle Ages.*—The medieval Church

adopted the custom of the pilgrimage from the ancient Church. The young Germanic and Romance nations did precisely as the Greek and Romans had done before them, and the ^{New} motives of these devotional journeys—now much more difficult of execution in the general decay of the great world-system of commerce—remained much the same. They were undertaken to the honour of God (*Pipp. Cap. 754-755, c. 4*), for purposes of prayer (*Ann. Hild. 902*), or in quest of assistance, especially health (*Vita Galli, ii. 37; Vita Liudg. iii. 10*). But the old causes were reinforced by others of at least equal potency. The medieval Church was even more profoundly convinced than its predecessor that the miraculous power of Deity attached to the bodies of saints and their relics. But the younger nations—French, English and German—were scantily endowed with saints; while, on the other hand, the belief obtained that the home-countries of Christianity, especially Rome and Jerusalem, possessed an inexhaustible supply of these sanctified bodies. Pilgrimages were consequently undertaken with the intention of securing relics. At first it was enough to acquire some object which had enjoyed at least a mediate connexion with the hallowed corpse. Gregory of Tours (d. 594) mentions one of his deacons who made a pilgrimage into the East, in order to collect relics of the Oriental saints; and, on his return, visited the grave of the bishop Nicetius (St Nizier, d. 573) in Lyons, where he still further increased his store. His testimony showed how relics came to be distributed among the populace: one enthusiast took a little wax dropped from the taper; another, a portion of the dust which lay on the grave; a third, a thread from the cloth covering the sarcophagus; and he himself plucked the flowers which visitors had planted above the tomb. Such were the memorials with which he returned; but the universal belief was that something of the miraculous virtue of the saint had passed into these objects (*Vit. patr. 8, 6*). Before long, however, these humble trophies failed to content the pilgrims, and they began to devote their efforts to acquiring the actual bodies, or portions of them—frequently by honest means, still oftener by trickery. One of the most attractive works of early medievalism—Einhard's little book, *Translatio Marcellini et Petri*—gives a vivid description of the methods by which the bodies of the two saints were acquired and transported from Rome to Seligenstadt on the Main.

Far more important consequences, however, resulted from the fact that the medieval mind associated the pilgrimage with the forgiveness of sins. This conception of the pilgrimage, as a means of expiation or a source of pardon for wrong, was foreign to the ancient Church. It is quite in accordance with the keener consciousness of sin, which prevailed in the middle ages, that the expiatory pilgrimage took its place side by side with the pilgrimage to the glory of God. The pilgrimage became an act of obedience; and, in the books of penance (*Poenitentia*) which date from the early middle ages, it is enjoined—whether for a definite period (e.g. *Poen. Valicell. i. c. 19; Theod. Cant. i. 2, 16*) or for life (*Poen. Cummeant, vii. 12; Casin. 24*)—as an expiation for many of the more serious sins, especially murder or the less venial forms of unchastity. The place to be visited was not specified; but the pilgrim, who was bound by an open letter of his bishop to disclose himself as a penitent, lay under the obligation, wherever he went, to repair to the churches and—more especially—the tombs of the saints, and there offer his prayers. On occasion, a chain or ring was fastened about his body, that his condition might be obvious to all; and soon all manner of fables gained currency: how, here or there, the iron had sprung apart by a miracle, in token that the sinner was thereby absolved by God. For instance, the *Vita Liudgeri* recounts the history of a fratricide who was condemned to this form of pilgrimage by Jonas, bishop of Orleans (d. 843); he wore three iron rings round his body and arms, and travelled bare-footed, fasting, and devoid of linen, from church to church till he found pardon, the first ring breaking by the tomb of St Gertrude at Nivelles, the second in the crypt of St Peter, and the third by the grave of Liudger. The pilgrim-

age with a predetermined goal was not recognized by the books of penance; but, in 1059, Peter Damiani imposed a pilgrimage to Rome or Tours on the clerics of Milan, whom he had absolved (*Acta mediæ. patrol. lat. 145, p. 98*).

As the system of indulgences developed, a new motive came to the fore which rapidly overshadowed all others: pilgrimages were now undertaken to some sacred spot, simply in order to obtain the indulgence which was vested in the respective church or chapel. In the 11th century the indulgence consisted in a remission of part of the penance imposed in the confessional, in return for the discharge of some obligation voluntarily assumed by the penitent. Among these obligations, a visit to a particular church, and the bestowal of pious gifts upon it, held a prominent place. The earliest instance of the indulgent privilege conferred on a church is that granted in 1016 by Pontius, archbishop of Arles, to the Benedictine abbey of Montmajour (Mons Major) in Provence (d'Achery, *Spicil. iii. 383 seq.*) But these dispensations, which at first lay chiefly in the gift of the bishops, then almost exclusively in that of the popes, soon increased in an incessant stream, till at the close of the middle ages there were thousands of churches in every western country, by visiting which it was possible to obtain an almost indefinite number of indulgences. But, at the same time, the character of the indulgence was modified. From a remission of penance it was extended, in the 13th century, to a release from the temporal punishment exacted by God, whether in this life or in purgatory, from the repentant sinner. And, from an absolution from the consequences of guilt, it became, in the 14th and 15th centuries, a negation or the guilt itself; while simultaneously the opportunity was offered of acquiring an indulgence for the souls of those already in purgatory. Consequently, during the whole period of medievalism, the number of pilgrims was perpetually on the increase.

So long as the number of pilgrims remained comparatively small, and the difficulties in their path proportionately great, they obtained open letters of recommendation from their bishops to the clergy and laity, which ensured ^{The Pilgrim's Passport.} them lodging in convents and charitable foundations, in addition to the protection of public officials. An instance is preserved in Markulf's formulary (ii. 49). To receive the pilgrim and supply him with alms was always considered the duty of every Christian: Charlemagne, indeed, made it a legal obligation to withhold neither roof, hearth, nor fire from them (*Admon. gen. 780, c. 75; Cap. Miss. 802, c. 27*).

The most important places of resort both for voluntary and involuntary pilgrimages, were still Palestine and Rome. On the analogy of the old *Itineraria*, the abbot Adamnan of Iona (d. 704) now composed his monograph *De locis sanctis*, which served as the basis of a similar book by the Venerable Bede (d. 735)—both works being edited in the *Itin. hierosol.* His authority was a Frankish bishop named Arculf, who resided for nine months as a pilgrim in Jerusalem, and visited the remaining holy sites of Palestine in addition to Alexandria and Constantinople. Of the later itineraries the *Descriptio terræ sanctæ*, by the Dominican Burchardus de Monte Sion, enjoyed the widest vogue. This was written between the years 1285 and 1295; but books of travel in the modern tongues had already begun to make their appearance. The initiative was taken by the French in the 12th and 13th centuries, and the Germans followed in the 14th and 15th; while the *Book of Ways to Jerusalem* of John de Maundeville (c. 1336) attained extreme popularity, and was translated into almost all the vernacular languages. Most pilgrims, probably, contented themselves with the brief guide-books which seem to have originated in the catalogues of indulgences. In later periods, that of Romberch a Kyrspé, printed at Venice (1519), stood high in favour.

A long list might be compiled of men of distinction who performed the pilgrimage to Palestine. In the 8th century one of the most famous is the Anglo-Saxon Willibald, who died in 781 as bishop of the Frankish diocese of Eichstätt. He left his home in the spring of 720, accompanied by his father and brother. The pilgrims traversed France and Italy, visiting

every religious resort; in Lucca the father died, and the brother remained behind in Rome. Early in 722 Willibald began his expedition to the Holy Land alone, except for the presence of two companions. He travelled past Naples to Syracuse, then on shipboard by Cos and Samos to Ephesus, and thence through Asia Minor to Damascus and Jerusalem. On St Martin's day, in 724, he arrived in the Holy City. After a prolonged stay in the town and its environs, Willibald proceeded (727) to Constantinople, and in 729 returned to Italy. Such is the account given by the nun of Heidenheim in her biography of Willibald; and her version is probably based on notes by the pilgrim himself (*Mon. Germ. hist. scr. xv. 80 sqq.*). In the 9th century the French monk Bernard visited Palestine with two companions, and afterwards wrote a simple and trustworthy account of his journey (*Patrol. lat. 121, 569 sqq.*). In the 10th century Conrad, bishop of Constance (934-976), performed the pilgrimage to Jerusalem three times (*Vita Chuonr. 7*); and to the same period belong the first women-pilgrims to Jerusalem of whom we have any cognisance—Hidda, mother of Gero, archbishop of Cologne (Thietm. *Chron. ii. 16*), and the countess Hademod of Ebersberg (*Chron. ebersb.*). The leaders, moreover, of the monkish reform movement in the 10th and 11th centuries, Richard of St Vanne in Verdun and Poppo, abbot of Stavelot (978-1048), had seen the Holy Land with their own eyes (*Vita Rich. 17; Vita Popp. 3*). In the year 1028 Archbishop Poppo of Trier (d. 1047) undertook a pilgrimage which led him past Jerusalem to the banks of the Euphrates, his return taking place in 1030 (*Gesta Trevir. Cont. i. 4 sqq.*). But the most celebrated devotional expedition before the Crusades was that of the four bishops—Sigfrid of Mainz, Gunther of Bamberg, William of Utrecht, and Otto of Regensburg. They set out in 1064, with a company whose numbers exceeded seven thousand. The major portion, however, fell in battle against the Mahomedans, or succumbed to the privations of the journey, and only some two thousand saw their homes again (*Annal. Allah., Lamb., Disib., Marian. Scot. &c.*). Among the followers of the bishops were two clerics of Bamberg, Ezzo and Wille, who composed on the way the beautiful song on the miracles of Christ—one of the oldest hymns in the German language. The text was due to Ezzo, the tune to Wille (Müllenhoff and Scherer, *Denkmäler*, i. p. 78, No. 31). A few years later Count Dietrich of Trier began a pilgrimage to Jerusalem with 113 companions, in atonement for the murder of Archbishop Kuno. The ship, however, which conveyed them went down with all hands in a storm (Berth. *Ann. 1073*).

As a result of this steady increase in the number of pilgrims, the old arrangements for their accommodation were found deficient. Consequently hospices arose which were designed exclusively for the pilgrim. Those on the Alpine passes are common knowledge. The oldest, that on the Septimer pass, dates from the Carolingian period, though it was restored in 1120 by the bishop Wido of Chur: that on the Great St Bernard was founded in the 10th century, and reorganized in the 13th. To this century may also be assigned the hospice on the Simplon; to the 14th those on the St Gothard and the Lukmanier. Similarly, the Mediterranean towns, and Jerusalem in particular, had their pilgrim-refuges. Service in the hospices was regularly performed by the hospital-fraternities—that is to say, by lay associations working under the authorization of the Church. The most important of these was the fraternity of the *Hospitale hierosolymitanum*, founded between 1065 and 1075; for hence arose the order of St John, the earliest of the orders of knighthood. In addition to the hospital of Jerusalem, numerous others were under its charge in Acre, Cyprus, Rhodes, Malta, &c. Associations were formed to assist pilgrims bound for the East; one being the *Confrérie des pèlerins de Terre-Sainte* in Paris, founded in 1325 by Louis de Bourbon, count of Clermont (afterwards first duke of Bourbon). Its church was in the rue des Cordeliers. Similar institutions existed also in Amsterdam, Utrecht, Antwerp and elsewhere in the Netherlands.

But since, in the middle ages, the Holy Land was no longer held by a Christian Power, the protection of the pilgrims was

no less necessary than their sustenance. This fact, after the close of the 11th century, led to the Crusades (*q.v.*), which in many respects are to be regarded as armed pilgrimages. For the old dream of the pilgrim, to view the country where God had walked as man, lived on in the Crusades—a fact which is demonstrated by the letters of Bernard of Clairvaux, with the songs of Walther von der Vogelweide and other Crusaders. And, since the strongest motive in the pilgrimage was the acquisition of indulgences, unnumbered thousands were moved to assume the Cross, when, in 1095, Urban II. promised them plenary indulgence (*Conc. Claram. c. 2*). The conquest of Jerusalem, and the erection of a Christian empire in Palestine, naturally welled the influx of pilgrims. And though in 1187 the Holy City again fell into the hands of the infidel, while in 1291 the loss of Acre eliminated the last Christian possession in Palestine, the pilgrimages still proceeded. True, after the fall of the city and the loss of Acre, they were forbidden by the Church; but the veto was impracticable. In the 12th century these religious expeditions were still so common that, every Sunday, prayers were offered in church for the pilgrims (Honor. Aug. *Spor. eccl. p. 828*). In the 13th century the annual number of those who visited Palestine amounted to many thousands: in the 14th and 15th it had hardly shrunk. In fact, between the years 1300 and 1600, no fewer than 1400 men of distinction can be enumerated from Germany alone who travelled to the Holy Land (Röhrich and Meissner, *Deutsche Pilgerreisen*, pp. 465-546). It was not till the Reformation, the wars of the 16th century, and the loss of Rhodes, Candia and Cyprus to the Turks, that any appreciable alteration was effected. When Ignatius de Loyola (*q.v.*) set sail in 1523 from Venice to Palestine, only some thirteen souls could be mustered on the pilgrim-ship, while eight or nine others sailed with the Venetian state-vessel as far as Cyprus. A considerable number had abandoned their pilgrimage and returned home: the news of the fall of Rhodes (Dec. 25, 1522: see *Acta sanct. Jul. vii. 642 sqq.*).

For pilgrimage overseas, as it was styled, the permission of the Church was still requisite. The pilgrims made their journey in grey cowls fastened by a broad belt. On the cowl they wore a red cross; and a broad-brimmed hat, a staff, sack and gourd completed their equipment. During their travels the beard was allowed to grow, and they prepared for departure by confession and communion. Of their hymns many are yet extant ("Jerusalem mirabilis," "In gottes namen faren wir," &c.). The embarkation took place either in France or Italy. In France, Marseilles was the main harbour for the pilgrims. From these ships belonging to the knights of St John and the knights templars conducted the commerce with Palestine, and carried annually some 6000 passengers. In the Italian ports the number of shipments was still greater—especially in Venice, whence the regular *passagium* started twice a year. The Venetian pilgrim ships, moreover, carried as many as 1500 souls. The pilgrims formed themselves into unions, elected a "master" and concluded their agreements, as to the outward voyage and return, in common. After Venice, Genoa and Pisa occupied the most prominent position. The voyage lasted from six to eight weeks, the stay in Jerusalem averaging ten days. The visitation of the holy places was conducted in processions headed by the Franciscans of the Convent of Zion.

The expenses of the journey to Palestine were no light matter. In the 12th century they may be estimated at 100 marks of silver (£200) for the ordinary pilgrim. This was the amount raised in 1147 by one Goswin von Randerath to defray the expenses of his pilgrimage (*Niederrhein. Urk. Buch. i. No. 361*). Later the cost was put at 280-300 ducats (£140-£150). In the 13th century a knight with two squires, one groom, and the requisite horses, had to disburse 8½ marks of silver for his passage, while for a single pilgrim the rate was rather less than 1 mark. In the 16th century Ignatius de Loyola calculated the cost of the voyage from Venice to Jaffa at some 6 or 7 gold florins (£3). The expenses of the princes and lords were, of course, much heavier. Duke William of Saxony, who was in Jerusalem in 1461, spent no less than £10,000 on his journey (see *Prutz*,

Kulturgeschichte der Kreuzzüge, pp. 106 sqq.; Röhrich, *Deutsche Pilgerreisen*, p. 42).

Great as was the number of pilgrims overseas, it was yet far exceeded by that of the visitants to the "threshold of the apostles," i.e. Rome. As was the case with Jerusalem, guide-books to the city of the apostles were now composed. The oldest is the *Notitia ecclesiarum urbis Romae*, which was probably compiled under Honorius I. (625-638). The monograph *De locis s. marlyrum* is of somewhat later date. Both are to be found in De Rossi, *Roma sotterranea*, i. 138 sqq.). The *Itinerarium Einsidense* (ed. G. Hänel, *Archiv. f. Philologie*, v. 119) belongs to the second half of the 8th century. Its composer would seem to have been a disciple of Walahfrid; for his interests are not confined to the churches, their reliquaries, and the ecclesiastical ceremonial of saint-days, but he takes a pleasure in transcribing ancient inscriptions. William of Malmesbury, again, when relating the crusade of Count Robert of Normandy (1066), transfers into his *Gesta regum anglorum* (iv. § 351) an old description of Rome, originally intended for the use of pilgrims. This may have dated from the 7th century.

The pilgrimages to Rome received their greatest impetus through the inauguration of the so-called Year of Jubilee (q.v.). On the 22nd of February 1300 the bull of Boniface VIII., *Antiquorum habet fidem*, promised plenary indulgence to every Roman who should visit the churches of the apostles Peter and Paul on thirty days during the year, and to every foreigner who should perform the same act on fifteen days. At the close of the Jubilee this dispensation was extended to all who had expired on the way to Rome. This placed the pilgrimage to Rome on a level with the crusades—the only mode of obtaining a plenary indulgence. The success of the papal bull was indescribable. It is computed that, in the Year of Jubilee, on an average, 200,000 strangers were present in the city during the day. The greatest number of the pilgrims came from southern France, England sending comparatively few on that occasion (see Gregorovius, *Gesch. d. Stadt Rom*, v. 546 sqq.). The Jubilee dispensation according to the edict of Boniface VIII. was to be repeated each century; but this period was greatly abridged by succeeding popes (see JUBILEE, YEAR OF), so that in the years 1350, 1390, 1423, 1450, 1475, 1500, the troops of pilgrims again came streaming into Rome to obtain the cherished dispensation.

Of the other pilgrim-resorts, we shall only emphasize the most important. Priority of mention is due to St James of Compostella (Santiago, in the Spanish province of Galicia). Here the attraction for the pilgrim was the supposed possession of the body of James the son of Zebedee. The apostle was executed (A.D. 44) by command of Herod Agrippa (Acts xii. 1); and at the beginning of the mediæval period it was believed that his corpse was laid in Palestine (*Venant. Fortun. carm.* v. 144, viii. 3). The first connexion of the apostle with Spain is to be traced in the *Poema de aris b. Mar. et xii. apost. dedic.*, which is ascribed to Aldhelm (d. 709) and contains a story of his preaching in that country. The earliest account of the transference of his relics to the Peninsula is found in Notker Balbulus (d. 912, *Martyrol. in Jul. xxv.*). But in Spain belief in this cherished possession was universal; and, step by step, the theory won credence throughout the West. In 1059, Archbishop Wido of Milan journeyed to St James (Damiani, *Acta mediol.* p. 98); and a little later we hear of bands of pilgrims from Germany and France. In England, indeed, the shrine of St James of Compostella became practically the most favoured devotional resort; and in the 12th century its visitation had attained such popularity that a pilgrimage thither was ranked on a level with one to Rome or Jerusalem (Honor. August. *Spec. ecel.* p. 828). In Paris, after 1419, there existed a special hospice for the "fraternity of St James," in which from 60 to 80 pilgrims were received each day, fed, and presented with a quarter of a denarius (Dulaure, *Hist. de Paris* (1842), i. 531). Even in the period of the Reformation the "Song of St James" was sung in Germany (Wackernagel, *Kirchenhist.*, ii. No. 1246); and in 1478 pilgrimages to that shrine were placed by Sixtus IV. on official equality with those to Rome and Jerusalem (*Extrav. comm. c. 5; De poenit.* v. 9).

In France St Martin remained the chief goal of the pilgrim; while Notre Dame de Sous-Terre in Chartres (with a portrait of the "black Virgin"), Le Puy-en-Velay (dep. Haute Loire), and others, also enjoyed considerable celebrity. In England pilgrimages were made to the tomb of the murdered archbishop, Thomas Becket, in Canterbury Cathedral. The setting of Chaucer's *Canterbury Tales* gives a vivid idea of the motley company of pilgrims; but it seems probable that Germany also sent a contingent (Gervas. *Canuar. chr.* ann. 1184; Ralph de Diceto, *Ymag. hist.* ann. 1184). In addition, Walsingham, Peterborough, St Davids, Holywell, and St Andrews in Scotland were much frequented. In lower Germany, Cologne and Aix-la-Chapelle, in Switzerland Einsiedeln, were the principal resorts.

In Italy the church of the Archangel on Mt Gargano was one of the most ancient centres of the pilgrimage, being visited even by the monk Bernard (*vide supra*). Later the Portiuncula church at Assisi displaced all other religious resorts, with the exception of Rome; but in the 15th century it was overshadowed in turn by the "Holy House" at Loretto on the Adriatic. According to an extravagant legend, the house of Joseph and Mary in Nazareth was transported by angels, on the night of the 6th-10th of May 1291 to Dalmatia, then brought to the Italian coast opposite (Dec. 10, 1294), till, on the 7th of September 1295 it found rest on its present site. The pilgrimage thither must have attained great importance as early as the 15th century; for the popes of the Renaissance found themselves constrained to erect an imposing pilgrim church above the "Holy House."

The significance of the pilgrimage for the religious life of later mediævalism cannot be adequately estimated. The possession of an extraordinary relic, a bloody Host, or the like, was everywhere considered a sufficient claim for the privileges of indulgences; and wherever this privilege existed, there the pilgrims were gathered together. All these pilgrimages, great and small, were approved and encouraged by the Church. And yet, during the whole of the middle ages, the voice of suspicion in their regard was never entirely stilled. Earnest men could not disguise from themselves the moral dangers almost inevitably consequent upon them; they recognized, moreover, that many pilgrims were actuated by extremely dubious motives; and they distrusted the exaggerated value set on outward works. The Roman papacy had no more zealous adherent than Boniface; yet he absolutely rejected the idea that Englishwomen should make the journey to Rome, and would willingly have seen the princes and bishops veto these pilgrimages altogether (*Ep.* 78). The theologians who surrounded Charlemagne held similar views. When the abbess Ethelburga of Fladbury (Worcestershire) found her projected pilgrimage impracticable, Alcuin wrote to her, saying that it was no great loss, and that God had better designs for her: "Expend the sum thou hast gathered for the journey on the support of the poor; and if thou givest as thou canst, thou shalt reap as thou wilt" (*Ep.* 300). Bishop Theodulf of Orleans (d. 821) made an energetic protest against the delusion that to go to Rome availed more than to live an upright life (*Carm.* 67). To the same effect, the synod of Chalon-sur-Saône (813) reprobated the superstition which was wedded to the pilgrimage (c. 13); and it would be easy to collect similar judgments, delivered in every centre of mediævalism. But, fundamentally, pilgrimages in themselves were rejected by a mere handful: the protest was not against the thing, but against its excrescences. Thus Fridank, for instance, in spite of his emphatic declaration that most pilgrims returned worse than they went, himself participated in the crusade of Frederick II.

V. *The Modern Pilgrimage*.—The Reformation eradicated the belief in the religious value of visits to a particular locality. It is only pious memory that draws the Protestant to the sites consecrated by ecclesiastical history. On the other hand, while in the Eastern Church things have undergone little change,—the pilgrims, in addition to the Holy Land, visiting Mt Athos and Kiev—the developments in the Roman Church show important divergences. The Year of Jubilee, in 1525, was unprecedented in its scant attendance, but the jubilees of 1575 and 1600 again saw great armies of pilgrims marching to Rome.

Fresh pilgrim resorts now began to spring up, and medieval shrines, which had fallen on evil days, to emerge from their obscurity. In the 16th century we must mention the pilgrimages to the "Holy Mount" at Görz on the Austrian coast, and to Montserrat in the Spanish province of Barcelona; in the 17th century, those to Luxemburg, Kevelaar (Gelderland), Notre Dame de Fourvière in Lyons, Heiligenberg in Bohemia, Roermond in the Netherlands, &c. The 18th century, which witnessed the religious *Aufklärung*, was not favourable to the pilgrimage. Enlightened bishops and princes prohibited it altogether: so, for instance, Joseph II. of Austria. Archbishop Clement Wenceslaus of Trier forbade, in 1777, the much-frequented, medieval "leaping-procession" of Echternach (duchy of Luxemburg). The progressive theologians and clergy, moreover, assumed a hostile attitude, and, in 1800, even the Curia omitted the Year of Jubilee. The 19th century, on the other hand, led to an extraordinary revival of the pilgrimage. Not only did new resorts spring into existence—e.g. La Salette in Dauphiné (1846), and more particularly Lourdes (1858) in the department of Hautes Pyrénées—but the numbers once more attained a height which enables them to compete with the medieval figures. It is computed that 60,000 pilgrims were present in La Salette on the 20th of September 1847, the first anniversary of the appearance of Mary which gave rise to the shrine. The dedication of the church of Lourdes, in 1876, took place in the presence of 30 bishops, 3,000 priests and 100,000 pilgrims. In 1877 the number rose to 250,000; and similar statistics are given of the German and Austrian devotional resorts. The sanctuaries of Aix-la-Chapelle are said to have been visited by 65,000 pilgrims on the 15th of July 1860; and on the following Sunday by 52,000. From 25,000 to 30,000 persons take part each year in the resuscitated "leaping-procession" at Echternach; and the annual visitants to the "Holy Mount" at Görz are estimated at 50,000. No new motives for the pilgrimage emerged in the 19th century, unless the ever-increasing cultus of the Virgin Mary may be classed as such, all of the new devotional sites being dedicated to the Virgin. For the rest, the desire of acquiring indulgences maintains its influence: but doubting voices are no more heard within the pale of the Roman Catholic Church.

BIBLIOGRAPHY.—*Itinera hierosolymitana saec. IV.-VIII.*, rec. P. Geyer (Vienna, 1898); *Itin. hierosol. et descr. terrae sanctae*, ed. T. Toller and A. Molinier (Geneva, 1879-1885); H. Michelant and G. Raynaud, *Itinéraires à Jérusalem rédigés en français au XI^e, XII^e, XIII^e siècles* (Geneva, 1882); R. Röhrich and H. Meisner, *Deutsche Pilgerreisen nach dem heiligen Land* (Berlin, 1882, new ed., Innsbruck, 1900); L. Conradi, *Vier rheinische Palästina-Pilgerchriften des XIV., XV., XVI. Jahrhunderts* (Wiesbaden, 1882); G. B. de Rossi, *Roma sotterranea*, i. 128 sqq. (Rome, 1864); J. Marx, *Das Wallfahrten in der katholischen Kirche* (Trier, 1842); W. E. Scudamore, *Dict. of Christ. Antiquities*, vol. ii. (London, 1880).

(A. H.)*

PILIBHIT, a town and district of British India, in the Bareilly division of the United Provinces. The town—pop. (1901), 33,400—contains the mosque of Hafiz Rahmat Khan, the Rohilla chieftain, built in the second half of the 18th century. Trade is mainly in agricultural produce, and in the products of the neighbouring Himalayan territory and Nepal.

The DISTRICT OF PILIBHIT has an area of 1350 sq. m.; pop. (1901), 470,330, showing a decrease of 3% in the decade. Though so near the Himalayas it is entirely a plain. In its midst is the Mala swamp. The east is forest-clad, poor and unhealthy; on the other side of the Mala the land becomes more fertile. The chief river is the Sarda, and the Gumti rises in the east. The principal crops are rice, pulses, wheat and sugar-cane. Sugar-refining is carried on, and sugar, wheat, rice and hemp are exported. The Lucknow-Bareilly section of the Oudh & Rohilkhand railway runs through the district, a portion of which is watered by the Rohilkhand canals.

PILLAR (O. Fr. *pilar*, Mod. *pilier*, Late Lat. *pilare*, from *pila*, column), an isolated upright structure, of narrow width in relation to its height, which is either employed as a support for a superincumbent load of some sort or is set up for commemorative or ornamental purposes. In the first sense the word has many common applications, as to columns supporting the girders of a

warehouse floor or the deckbeams of a ship, to the single central support or pedestal of a table, machine-tool, &c., and to the masses of coal which the miner leaves in certain methods of working as supports to the roof (see COAL); it is also used figuratively of persons in such phrases as a "pillar of the state." In architecture it has strictly the second sense. The column erected in honour of Diocletian at Alexandria is known as Pompey's pillar, and the so-called columns of Trajan and Antoninus are in reality pillars, performing no structural function beyond that of carrying a statue. In India the only example is the iron pillar at Delhi, which is an extraordinary specimen of the iron-worker's art considering the remote date at which it was made. Up to the middle of the 19th century the term "pillar" was employed to designate the masses of masonry in a church, which carry the arcades, but now the term "pier" is invariably adopted in preference.

PILLAU, a seaport and watering-place of Germany, in the Prussian province of East Prussia, on the spit of sand (*Nehrung*) which separates the Frische Haff from the Baltic, on the north of the entrance channel, and 29 m. by rail from Königsberg. Pop. (1905), 7374. It is fortified and has a harbour, which serves as the outer port of Königsberg, and to some extent also of Elbing and Braunsberg. A new navigable channel was in 1900-1901 constructed across the Frische Haff from Pillau to Königsberg. Pillau has a school of navigation, and is a well-known pilot station. Ship-building, sail-making, fishing and the working of amber are carried on.

Pillau is memorable as the place where Gustavus Adolphus of Sweden landed in 1626. It did not obtain civic privileges until 1725, but was fortified shortly after that date. In 1807 it offered a stout resistance to the French. By a treaty of the 24th of February 1812 it was ceded to Napoleon, but on the 6th of February in the following year it was restored to Prussia.

PILLION, a light saddle without pommel or bow, especially a pad fastened to the back of an ordinary saddle, as a seat for another person, generally a woman. Pillions were also used to support baggage. They were in common use from the 16th to the 18th centuries. The word appears to have been adapted into English from the Irish *pillín*, cushion, formed from Lat. *pellis*, skin. In the sense of a hat worn by a priest or doctor of divinity, "pillon" or "plylon" occurs in the 15th and 16th centuries. This is probably from Lat. *pileus*, a conical felt hat or cap, Gr. *πίλος*.

PILLNITZ, a village in the kingdom of Saxony, situated on the right bank of the Elbe, 5 m. above Dresden. Pop. (1905), 770. The new palace of the king of Saxony was built in 1818 on the site of a building which was destroyed by fire. The place became a residence of the electors of Saxony about 1700, and the different parts of the palace were erected at various times during the 18th century. By the convention of Pillnitz in August 1791 the emperor Leopold II. and Frederick William II., king of Prussia, agreed to take common action against any attack on the part of France; this compact may be regarded as the basis of the first coalition against that country.

See A. von Minchwitz, *Geschichte von Pillnitz* (Dresden, 1893).

PILLORY (O. Fr. *pilori*, Prov. *espillori*, from Lat. *speculatorium*, a place of observation or "peep-hole"), an instrument of punishment which consisted of a wooden post and frame fixed on a platform raised several feet from the ground, behind which the culprit stood, his head and his hands being thrust through holes in the frame (as are the feet in the stocks) so as to be held fast, exposed in front of it. This frame in the more complicated forms of the instrument consisted of a perforated iron circle, which secured the heads and hands of several persons at the same time, but it was commonly capable of holding only one.

In the statutes of Edward I. it is enacted that every pillory or "stretch-neck" should be made of convenient strength so that execution might be done on offenders without peril of their bodies. It was customary to shave the heads wholly or partially, and the beards of men, and to cut off the hair and even in extreme cases to shave the heads of female culprits. Some of the offences punished in England by the pillory will be found enumerated in

a statute of Henry III. (1266). By this "Statute of the Pillory" it was ordered as the penalty for "forestallers and regrators, users of deceitful weights, perjurers and forgers." Stow, describing Cornhill pillory, says: "On the top of the cage (a strong prison of timber) was placed a pillory for the punishment of bakers offending in the assize of bread, for millers stealing corn at the mill, for bawds, scolds and other offenders." Until 1637 the pillory was reserved for such offenders. In that year an attack was made on the Press, and the pillory became the recognized punishment of those who published books without a licence or libelled the government. Alexander Leighton, John Lilburn, Frynne and Daniel Defoe were among those who suffered. These were popular favourites, and their exposures in the pillory were converted into public triumphs. Titus Oates, however, was put in the pillory in 1695; and nearly killed. In 1816 the pillory was abolished except for perjury and subornation, and the perjurer Peter James Bossy was the last to stand in the pillory at the Old Bailey for one hour on the 22nd of June 1830. It was finally abolished in 1837 at the end of William IV.'s reign. In France the pillory, called *carcan*, was employed till 1832. In Germany it was known as *pranger*. The pillory was used in the American colonies, and provisions as to its infliction existed in the United States statute books until 1839; it survived in the state of Delaware until 1905.

Finger-pillories were at one time in common use as instruments of domestic punishment. Two stout pieces of oak, the top being hinged to the bottom or fixed piece, formed when closed a number of holes sufficiently deep to admit the finger to the second joint, holding the hand imprisoned. A finger-pillory is preserved in the parish church of Ashby-de-la-Zouch, Leicestershire, and there is one, still in its original situation against the wall, at Littlecote Hall, Wilts.

PILLOW (O. Eng. *pylu*; Lat. *pulvinus*, a cushion), a support for the head during sleep or rest. The pillow of Western nations is a cushion of linen or other material, stuffed with feathers, down, hair or wool. In the East it is a framework made of bamboo or rattan with a depression in the top to receive the neck; similarly blocks of wood with a concave-shaped top are used by the natives of other countries. The word is found in various technical uses for a block or support, as for a brass bearing for the journal of a shaft, and the like. In architecture the term "pillowed," or "pulvinated," is given to the frieze of an order which bulges out in the centre and is convex in section. It is found in friezes of some of the later works of the Roman school and is common in Italian practice.

PILLOCARPINE, $C_{11}H_{16}N_2O_2$, an alkaloid found, together with isopilocarpine and other related compounds, in the leaves of jaborandi (*Pilocarpus pennatifolius*). It was first isolated by E. Hardy in 1875 (*Ber.*, 8, p. 1594), and is a crystalline, very hygroscopic solid. It is a strong poison. It has the properties of a monacid base and contains the methylamino group, $\cdot NCH_3$. When heated with hydrochloric acid it gives isopilocarpine. Isopilocarpine was isolated in 1900 by H. A. D. Jowett (*Journ. Chem. Soc.* 77, p. 473), and is a colourless oil which boils at 261° C. (20 mm.). It is a monacid base which is readily soluble in solutions of the caustic alkalis. Jowett is of the opinion that pilocarpine and isopilocarpine are stereo-isomers of the structure:—

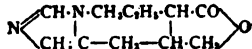

PILLOÑA, a town of northern Spain, in the province of Oviedo; between the right bank of the river Piloña, a left-hand tributary of the Sella, and the Sierra de Abes (3268 ft.). Pop. (1900), 28,228. Though officially classed as a town, Piloña is rather a densely populated mining and agricultural district. It is served by the railway from Infesto, on the river Piloña, to Oviedo and Gijón.

PILOT, the name applied either to a particular officer serving on board a ship during the course of a voyage and having the charge of the helm and the ship's route, or to a person taken on board at a particular place for the purpose of conducting a ship through a river, road or channel, or from or into a port. The

latter kind is the only one to which the term is now applied either in British or foreign countries. The word "pilot" is not the early name for the man who guides or steers a ship. In Old English the name is *laddman*, i.e. the man who leads the way. "Pilot" does not appear in English till the 16th century. The origin of the word has been much debated. Many etymologists find it in the Dutch *pijloot* (Hexham's *Dictionary*, 1658). This has been identified with *pellwood*, *pell-toth*, sounding lead, cf. German *peilen*, to sound; the last part of these words is the same as English "lead," the metal; the first part, *peilen*, is for *pegele*, to mark with pegs or points for measuring, cf. *pegel*, gauge. The *New English Dictionary*, on the other hand, finds that the Dutch *pijloot*, the earlier form, is taken from the French. The source is, therefore, to be looked for in Romance languages. Du Cange (*Gloss. Med. et Inf. Lat.*) gives *Pedotae*, defined as *quorum est scire intrare et exire portus*, a gloss on *pedate e timonieri* in F. Ubaldini's edition, 1640, of *I documenti d'amore* by Francesco da Barberino (1264-1348). It is therefore conjectured that the Italian *pilota* is a popular conception of *pedotia*, and a possible source may be found in the Greek $\pi\acute{\iota}\lambda\omicron\varsigma$, oar.

In England, formerly, pilots were subject to the jurisdiction of the lord high admiral; and in the 16th century there are many instances of the admiralty court dealing with pilots disciplinarily as well as civilly, holding them liable in damages to owners of ships lost or damaged by their negligence. For some considerable time throughout the United Kingdom the appointment and control of pilots have been in the hands of numerous societies or corporations established at the various ports by charter or act of Parliament, such as the Trinity Houses of Deptford Strond (London), Kingston-upon-Hull, Newcastle-on-Tyne, and Leith, and the Society of Cinque Ports Pilots and Court of Lodemanage (now extinct). These societies had jurisdiction over the pilots exercising their employment within the limits of such ports, and in many cases made it compulsory for ships resorting thither to employ them. By degrees the London Trinity House acquired a leading position, which was confirmed and extended by the general Pilotage Acts passed in the 18th and 19th centuries, with the object of introducing a uniform system throughout the realm. At the present day the United Kingdom is divided into districts for the purpose of pilotage jurisdiction. The (London) Trinity House has jurisdiction over the London district, which extends from Orfordness to Dungeness, and comprises the Thames and Medway up to London and Rochester bridges; the English Channel district, comprising the sea between Dungeness and the Isle of Wight; and the Trinity outport districts, which include any pilotage districts for the appointment of pilots within which no particular provision is made by act of Parliament or charter, and the number of which is 40, all English and Welsh. There are 66 other districts, within which other pilotage authorities have jurisdiction.

The present general pilotage law is contained in the Merchant Shipping Acts 1894 to 1906. Pilotage authorities are defined as bodies or persons authorized to appoint or license pilots, or to fix and alter rates of pilotage or to exercise any jurisdiction in respect of pilotage. They are subject to the control of the Board of Trade as the supreme mercantile marine authority. Those bodies, however, which existed at the time of the passing of the act retain their powers and jurisdiction, so far as is consistent with it. The board has power to appoint a new pilotage authority in any area where there is none, and to include a new area where there is none within an already existing one (but in either case pilotage cannot be made compulsory), or to transfer pilotage jurisdiction over a port other than that where the pilotage authority for that port resides, from that pilotage authority to the harbour or other local authority for that port, or to the Trinity House, or to a new authority; and the board has all powers necessary to effectuate such transfer and constitutes the new authority. The board may also, by provisional order (which requires parliamentary confirmation), provide for the representation of pilots or shipowners on the pilotage authority

of any district, and the exemption of ships from compulsory pilotage in any district. Where pilotage is not compulsory, and the power of obtaining pilotage licences unrestricted, the board can in the same way give the pilotage authority powers with respect to licences, amount of pilotage rates, and the like. Pilotage authorities may, by by-laws under the act (which require confirmation by order in council), exempt wholly or partly any ships or classes of ships from compulsory pilotage, and regulate the means of obtaining licences, and the amount of pilotage rates, subject to a maximum limit. They must make yearly returns to the Board of Trade of their by-laws, the names, ages and services of their licensed pilots, the rates of pilotage, the amounts received for pilotage and their receipts and expenditure; and if they fail to do so, the board may suspend their authority, which is then exercised by the Trinity House.

The statutes also provide generally for the qualifications of pilots. A "qualified" pilot is one duly licensed by a pilotage authority to conduct ships to which he does not belong.

On his appointment he receives a licence, which is registered with the chief officer of customs at the nearest place to the pilot's residence, and must be delivered up by the pilot whenever required by the licensing pilotage authority. On his death this licence must be returned to that authority. By an act of 1906 no pilotage certificate shall be granted to the master or mate of a British ship unless he is a British subject; this does not, however, refer to the renewal of a certificate granted before 1906 to one not a British subject. Pilotage dues are recoverable summarily from the owner, master, or consignees of the ship, after a written demand for them has been made. A pilot may not be taken beyond the limits of his district without his consent, and if so taken he is entitled to a fixed daily sum in addition to the dues; if he cannot board the ship, and leads her from his boat, he is entitled to the same dues as if he were on board; and he must be truly informed of the ship's draught of water. An unqualified pilot may in any pilotage district take charge of a ship without subjecting himself or his employer to any penalty, where no qualified pilot has offered himself, or where a ship is in distress, or in circumstances where the master must take the best assistance he can, or for the purpose of changing the moorings of any ship in port on docking or undocking her; but after a qualified pilot has offered himself any unqualified pilot continuing in charge, or any master continuing him in charge of the ship, is liable to a penalty. A qualified pilot may not be directly or indirectly interested in licensed premises or in the selling of dutiable goods, or in the unnecessary supply of gear or stores to a ship for his personal gain or for the gain of any other person. He can be punished for quitting a ship before the completion of his duty without the consent of the master, refusing or delaying to perform his duty without reasonable cause when required by lawful authority, lending his licence, acting as pilot when suspended or when intoxicated, and any pilot who through wilful breach or neglect of duty, or by reason of his drunkenness, endangers ship, life or limb, is guilty of a misdemeanour and liable to suspension or dismissal; but the pilot has an appeal in cases of fines over £2, of suspension or dismissal, suspension or revocation of his licence, or the application of a pilotage fund to which he has contributed. This appeal lies in England to a county court judge having jurisdiction over the port where he is licensed, or a metropolitan police magistrate or stipendiary magistrate with the like power; in Scotland, to a sheriff; in Ireland, to a county court judge, chairman of quarter sessions, recorder, or magistrate. Pilotage certificates may also be granted by pilotage authorities, available within their districts, to masters and mates of ships; and the holder of such a certificate may pilot any ship in respect of which it is available without incurring any penalty for not employing a qualified pilot.

The statute further makes special regulation for Trinity House pilots. Every such pilot, on his appointment, must execute a bond for £100 conditioned for due observance of the Trinity House regulations and by-laws, and thereupon he is not liable for neglect or want of skill to anybody beyond the penalty of the

bond and the amount payable to him for pilotage on the voyage on which he was engaged at the time of his so becoming liable. The licence may be revoked or suspended by the Trinity House when it thinks fit; it only continues in force for a year, and the Trinity House has absolute discretion whether it shall be renewed or not.

A pilot boat is approved and licensed by the district pilotage authority who appoints or removes the master thereof. In order to be easily recognized, she has printed on her stern in legible white letters the name of her owner and her port, and on her bows the number of her licence; the remainder of the boat is usually black. The pilot flag is a red and white horizontal flag of a comparatively large size, and is flown from a conspicuous position. When the flag is flown from a merchant vessel, it indicates that a licensed pilot is on board or that the master or mate holds a certificate entitling him to pilot the ship. By order in council of 1900, on and after the 1st day of January 1901 the signals for a pilot displayed together or separately are: In daytime, there is (1) hoisted at the fore the pilot jack (Union Jack having round it a white border, one-fifth of the breadth of the flag); (2) the international code pilotage signal indicated by P.T.; (3) the international code flag S. (white with small blue square centre), with or without the code pennant; (4) the distant signal consisting of a cone point upwards, having above it two balls or shapes resembling balls. By night, (1) the pyrotechnic light commonly known as a blue light, every fifteen seconds; (2) a bright white light, flashed or shown at short or frequent intervals just above the bulwarks, for about a minute at a time.

Pilotage in British waters may be either compulsory or free for all or certain classes of ships. From parliamentary pilotage returns, it appears that it is compulsory in about 64 districts of the United Kingdom (of which two-thirds are the Trinity House districts), free in 32, free and compulsory in 8, while in 3 cases (Berwick, Dingwall and Coleraine) no particulars are given. British war-ships in British waters are not compelled to employ a pilot, the navigating officer becoming the pilot under the direction of the captain. If a pilot be employed, the captain and navigating officer are not relieved from responsibility. They supervise the pilot and should, if necessary, remove him from the ship. In the majority of foreign ports British war-ships are exempted from employing pilots, but the Suez Canal and the ports of France are exceptions. The Merchant Shipping Act 1894 continues the compulsory employment of pilots in all districts where it was already compulsory, and also the already existing exemptions; and there is no power in any pilotage authority or the Board of Trade to increase the area of compulsory pilotage, though there is to diminish it. Compulsion is enforced by a provision in the act, that within a district where compulsory pilotage exists, the master of an unexempted ship who pilots her himself without holding the necessary certificate, after a qualified pilot has offered or signalled to take charge of the ship, shall be liable for each offence to a fine of double the amount of the pilotage dues demandable for the conduct of the ship. The exemptions from compulsory pilotage still existing in British territorial waters are as follows: Ships or vessels with British registers trading to Norway or the Cattegat or the Baltic (except vessels on voyages between any port in Sweden or Norway and the port of London), or round the North Cape, or into the White Sea on their inward or outward voyages, whether coming up by North or South Channels; any constant British traders inwards from ports between Boulogne inclusive and the Baltic coming up by North Channel, and any British ships or vessels trading to ports between the same limits on their outward passages and when coming up by the South Channels; Irish traders using the navigation of the Thames and Medway; ships engaged in the regular coasting trade of the kingdom; ships or vessels wholly laden with stone produced in the Channel Islands and Isle of Man and brought thence; ships or vessels not exceeding 60 tons, whether British or belonging to a foreign country specified by order in council; ships within the limits of the port or place to which they belong, if

this is not a place particularly provided for by act of Parliament or charter as regards the appointment of pilots; ships passing through the limits of any pilotage district in their voyages from one port to another port, and not being bound to any port or place within such limits or anchoring therein, but not including ships loading or discharging at any place situate within the district, or at any place situate above the district on the same river or its tributaries. Ships whose masters or mates are owners or part-owners of them, and living at Dover, Deal, or the Isle of Thanet, may be piloted by them from any of these places up and down the Thames or Medway, or into or out of any place or port within the jurisdiction of the Cinque Ports. The following ships in the London district and Trinity output districts are also exempt when not carrying passengers, namely: Ships employed in the coasting trade of the United Kingdom; ships of not more than 60 tons burden; ships trading to or from any port in Great Britain within the above districts to or from the port of Brest in France, and any port in Europe (which does not include the United Kingdom) north and east of Brest, or to the Channel Islands or Isle of Man; and ships navigating within the limits of the port to which they belong. The port to or from which the ship must be "trading" in this provision has been interpreted by the decisions to mean the port where the cargo is substantially discharged or loaded respectively; and the word "coaster" similarly has been held to apply only to a vessel carrying to one port of the United Kingdom a cargo which has been taken in at another. Every ship carrying passengers between any place in the British Islands and any other place so situate must carry a compulsory pilot, unless her master or mate have a pilotage certificate. The effect in law of the ship (British or foreign) being in charge of a compulsory pilot under the act is that her owner and master are not answerable to any person whatever for any loss or damage occasioned by the fault or incapacity of any qualified pilot acting in charge of such ship within any district where the employment of such pilot is compulsory by law. In order to take advantage of this privilege, the shipowner must show (1) that a properly qualified pilot was acting in charge of the ship; there are, however, various kinds of qualified pilots—the qualified pilot who is always capable of acting, and the qualified pilot who is liable to be superseded if a better can be obtained; (2) that that charge was compulsory; the pilot, however, need not be compulsorily employed at the place where the accident happened, so long as he is compulsorily employed within the district where it happens; (3) that it was solely the pilot's fault or incapacity which caused the damage. Similarly, under the Harbours, Piers and Docks Clauses Act, the owner of a vessel is not liable for damage done thereby to docks or piers when she is in charge of a duly licensed pilot.

This statutory exemption of a ship in charge of a compulsory pilot from any liability for her negligent navigation by that pilot, is only declaratory of the common law of England, and is based on the principle that the pilot is a state official put in charge of a ship, and is not the servant of the shipowner so as to make him liable for his negligence; and a British court gives the same effect to any foreign or colonial law which makes it compulsory on shipowners to put a pilot in charge of their ship when within their jurisdiction. Most foreign codes, however, while agreeing with English law in making the presence of a pilot on board compulsory, differ from it in not putting him in charge of the ship; and in this case the defence of compulsory pilotage cannot be pleaded successfully in British courts. Judicial decisions have established that French, Suez Canal, Danube and Dutch pilots are not compulsory pilots in the British sense of the word, being only advisers of the master, or "living charts." But if the pilot is put in charge by the foreign or colonial law, although that law expressly provides that in spite of the owner surrendering the charge of the ship to him the owner shall still remain liable, a British court will hold the owner free from liability, on the ground that to make any person liable for a tort committed abroad, the act complained of must be wrongful not only according to the foreign law, but also by English law. This consequence which English law attaches to the employment

of a compulsory pilot has been much criticised in recent times, and it would seem that the foreign view is much more satisfactory in regarding the pilot merely as the adviser and not the superior of the master. Moreover, the adoption of the foreign law on this point would restore the old general maritime law. The policy of the law was at one time inclined to extend this principle of compulsory pilotage, on the ground that it was for the benefit of commerce and the safety of seamen's lives, but it now restricts it within as narrow limits as possible, e.g. the presence of a compulsory pilot on board a tow who is directing the navigation of a tug does not protect the tug-owner from liability for negligent navigation. As already pointed out, pilotage authorities have no power to extend its scope.

A pilot who is compulsorily in charge of a ship under English law has supreme control over her navigation, superseding the master for the time being; and if she is a tow he has also control of the navigation of her tug. The judicial decisions establish that it is within his province to decide whether the ship shall get under way, the proper time and place for her to anchor, the way of carrying her anchor, the proper orders for the helm, her rate of speed, and whether the statutory rules of navigation shall be complied with; and the master and crew must not interfere with his control, and only remain liable for the proper execution of the pilot's orders and the trim and general efficiency as to look-out, &c., of the ship. The master, however, is bound to supersede the pilot in case of his intoxication or manifest incapacity, and to interfere if there is a clear and plain prospect of danger to the ship in following the pilot's directions, e.g. getting under way in a thick fog. The pilot is entitled to receive from the master assistance in having his attention called to anything which a competent mariner would see that he ought to know. A pilot taken voluntarily, and not by compulsion of law, is considered as the servant of the shipowner, and as such renders him liable for his acts of negligence towards third parties. He does not, it seems, supersede the master in the control of the ship, but only advises him. The Admiralty and the Board of Trade and the Trinity House all take the view that the captain or master is bound to keep a vigilant eye on the navigation of the vessel by the pilot, and insist on all proper precautions being taken. For the purposes of a policy of marine insurance a ship is not seaworthy without a pilot in compulsory pilotage waters; and where there is no legal compulsion to have one, but the locality requires navigation by a person having local knowledge, it has been said that a ship must take a pilot, certainly when leaving a port, and probably on entering a port if a pilot is available.

A pilot can sue for his pilotage fee at common law or in Admiralty (*q.v.*), in the latter case provided that the contract was made and the work done not within the body of a county; but he has a summary remedy by statute which is of easier application. He cannot be sued in Admiralty for damage done by a collision caused by his negligence (e.g. on the Admiralty side of a county court having Admiralty jurisdiction); but he can be made liable at common law or in the Admiralty Division of the High Court, although in the case of a Trinity House pilot his liability is limited to the amount of his bond and pilotage fee then being earned (see above); but the court has refused to join him as a defendant to an action *in rem* brought against the ship of which he had the charge. A pilotage authority cannot be made liable for the negligent navigation of a ship by a pilot which it has licensed, for he is not its servant, though it has been held liable for the negligence of a person not licensed by it as a pilot, but employed by it for wages to pilot ships into a harbour under its jurisdiction, itself taking the pilotage dues and applying them for harbour purposes. A pilot is not in common employment with the master and crew of a ship, and can recover for any injury done him by their negligence. He may be entitled to claim salvage from a ship of which he has charge, if the services he renders are beyond the scope of his pilotage contract, either from the outset or owing to supervening circumstances, but not otherwise, whether he is on board her or leading her from his boat. (See SALVAGE.)

In the United States pilotage laws are regulated by the respective

states. If the waters are the boundary between two states a duly licensed pilot of either state may be employed, but no discrimination can be made in the rates of pilotage between vessels of different states. In the *German Empire* the pilotage laws are very complicated. In the majority of the maritime states each one has its own regulations and laws. In *Prussia* there are government pilots who enter the service as apprentices, and are placed under a department of state. In *France* the general organization of pilots is regulated by the Statute on Pilots of the 12th of December 1806, and the pilotage regulations for each port are made by the minister of marine at the request of his local representative and the Chamber of Commerce. French pilots are exempt from military service.

See Abbott, *Shipping* (London, 1901); Maude and Pollock, *Shipping* (London, 1881); Marsden, *Collisions at Sea* (London, 1910); *Select Pleas of the Admiralty* (Selden Society, London, 1892 and 1897); Temperley, *Merchant Shipping Acts* (1907); Twiss, *Black Book of Admiralty* (London, 1871). (G. G. F.; J. W. D.)

PILOT-FISH (*Nasrates ductor*), a pelagic fish of the family of horse-mackerels or *Carangidae*, well known to sailors from its peculiar habit of keeping company with ships and large fishes, especially sharks. It occurs in all tropical and sub-tropical seas, and is common in the Mediterranean, but becomes scarcer in higher latitudes. In summer pilots will accompany ships as far north as the south coast of England into port. This habit was known to the ancients, who describe the *Pompilus* as



Pilot-fish.

a fish which points out the way to dubious or embarrassed sailors, and by its sudden disappearance indicates to them the vicinity of land; the ancient seamen of the Mediterranean regarded it, therefore, as a sacred fish. That the pilot accompanies sharks is an observation which first appears in works of travel of the 17th century, the writers asserting that it is of great use to its big companion in conducting it and showing it the way to its food. It is, however, extremely doubtful whether the pilot's connexion with a shark serves a more special purpose than its temporary attachment to a ship. It accompanies both on account of the supply of food which it derives from them. The pilot, therefore, stands to both in the relation of a so-called "commensal," like the *Echemis* or sucking-fish. All observers, however, agree that neither the pilot nor the sucker is ever attacked by the shark. The pilot attains to a length of about 12 in. In the shape of its body it resembles a mackerel, but is rather shorter, especially in the head, and covered with small scales. A sharp keel runs along the middle of each side of the tail. The first dorsal fin consists of a few short spines not connected by a membrane; the second dorsal and the anal are composed of numerous rays. The teeth, which occupy the jaws, vomer and palatine bones, are all small, in villiform bands. The coloration of the pilot renders it conspicuous at a distance; on a bluish ground-colour from five to seven dark-blue or violet cross-bands traverse the body from the back to the belly. The pilot-fish spawns in the open sea, and its fry is constantly caught in the tow-net. But young pilot-fish differ considerably from the adult, having the spines of the first dorsal connected by a membrane, and some bones of the head armed with projecting spines. These little fishes were therefore long considered to be a distinct genus, *Nauclerus*.

PILOTY, KARL VON (1826-1886), German painter, was born at Munich, on the 1st of October 1826. His father, Ferdinand Piloty (d. 1844), enjoyed a great reputation as a lithographer. In 1840 he was admitted as a student of the Munich Academy, under the artists Schorn and Schnorr. After a journey to Belgium, France and England, he commenced work as a painter of genre pictures, and in 1853 produced a work, *Die Amme* ("The Wet Nurse"), which, on account of its originality of style,

caused a considerable sensation in Germany at the time. But he soon forsook this branch of painting in favour of historical subjects, and produced in 1854 for King Maximilian II. "The Adhesion of Maximilian I. to the Catholic League in 1609." It was succeeded by "Seni at the Dead Body of Wallenstein" (1855), which gained for the young painter the membership of the Munich Academy, where he succeeded Schorn (his brother-in-law) as professor. Among other well-known works by Piloty are the "Battle of the White Mountain near Prague," "Nero Dancing upon the Ruins of Rome" (1861), "Godfrey of Bouillon on a Pilgrimage to the Holy Land" (1861), "Galileo in Prison" (1864), and "The Death of Alexander the Great" (unfinished), his last great work. He also executed a number of mural paintings for the royal palace in Munich. For Baron von Schach he painted the justly celebrated "Discovery of America." In 1874 he was appointed keeper of the Munich Academy, being afterwards ennobled by the king of Bavaria. Piloty was the foremost representative of the realistic school in Germany. He was a most successful teacher, and among his more famous pupils may be mentioned Makart, Lenbach, Defregger, Max and Grützner. He died at Munich on the 21st of July 1886.

PILSEN (Czech, *Piseň*), a town of Bohemia, Austria, 68 m. W.S.W. of Prague by rail. Pop. (1900), 68,292, of which 94% are Czech. It is the second town of Bohemia, and lies at the confluence of the Raddusa and the Mies. It consists of the town proper, which is regularly built and surrounded with promenades on the site of the old ramparts, and of three suburbs. The most prominent buildings are the Gothic church of St Bartholomew, said to date from 1292, whose tower (135 ft.) is the highest in Bohemia, and the fine Renaissance town hall dating from the 16th century. The staple article of manufacture and commerce is beer, which is exported to all parts of the world. Other industrial products are machinery, enamelled tinware, leather, alum, paper, earthenware, stoves and spirits, while a tolerably brisk trade is carried on in wool, feathers, cattle and horses. In the neighbourhood are several coal-pits, iron-works and glass-works, as well as large deposits of kaolin.

Pilsen first appears in history in 976, as the scene of a battle in the war between Prince Boleslaus and the emperor Otto II, and it became a town in 1272. During the Hussite wars it was the centre of Catholic resistance to the Hussites; it was three times unsuccessfully besieged by Prokop the Great, and it took part in the league of the Romanist lords against King George of Podebrad. During the Thirty Years' War the town was taken by Mansfield in 1618 and not recaptured by the Imperialists till 1621. Wallenstein made it his winter-quarters in 1633, and it was in the great hall of the *Rathaus* that his generals took the oath of fidelity to him (January 1634). The town was unsuccessfully besieged by the Swedes in 1637 and 1648. The first Bohemian printing press was established here in 1468.

PIMA, a tribe and stock of North American Indians. Their range was southern Arizona and northern Mexico. The ruined Pima village, known to the Spanish as Casa Grande on the south bank of the Gila, is an example of their early civilization and skill in building. Driven out of their homes by neighbouring tribes, they lived a more or less nomadic life. They were always good farmers, showing much skill in irrigation. At first submitting to the Spaniards, they revolted in 1751, destroying all the missions. The war lasted two years, but since then the Pima Indians have been friendly with the settlers. As a race they are brave, honest and hard working. They number some 5000 on two reservations in Arizona. The Piman stock includes such tribes as the Papago, Huichol, Opata, Tarumari, and numbers upwards of a hundred thousand.

PIMENTO, also called **ALLSPICE** (from a supposed combination of various flavours) and **JAMAICA PEPPER**, the dried immature fruit of *Eugenia pimenta* or *Pimenta officinalis*, an evergreen tree about 30 ft. high, belonging to the natural order *Myrsinaceae*. It is indigenous in the West India Islands, growing on limestone hills near the sea, and is especially grown in Jamaica. The spice derives its name from the Portuguese *pimenta*, Spanish *pimienta*, pepper, which was given to it from its resemblance to

pepper-corns. The berries are gathered in July and August, when of full size, but still unripe—the small branches bearing fruit being broken off and dried in the sun and air for some days, when the stalks are removed and the berries are ready for packing. These owe their aromatic properties to an essential oil present to the extent of 3 to 4½% and consisting largely of eugenol or allyl guaiacol, $\text{HO}(\text{CH}_2\text{O})\text{C}_6\text{H}_3\text{C}_2\text{H}_4$. The chief use of pimento is as a spice. The oil, the action of which resembles that of cloves, is occasionally used in medicine, and is also employed in perfuming soaps. The "bay rum" used as a toilet article is a tincture scented with the oil of the leaves of an allied species, *Pimenta acris*, commonly known as the bayberry tree.

PIN (a doublet with "pen" from Lat. *pinna*, feather, pinnacle, which is said to contain the same root as *strus*, pine tree, and properly to mean a sharp point or end), a small peg or bolt of metal or wood, not necessarily pointed, employed as a fastening to connect together different parts of an article, as a stop to limit the motion of some moving piece in a machine, as a support on which a small wheel may turn, &c., but most commonly a small metal spike, used for fastening portions of fabrics together, having one end pointed and at the other a bulbed head, or some other arrangement for preventing the spike from passing entirely through the cloth or other material with which it is employed. In one form or another pins of this last kind are of the highest antiquity, the earliest form doubtless being a natural thorn. Pins of bronze, and bronze brooches in which the pin is the essential feature, are of common occurrence among the remains of the bronze age. The ordinary domestic pin had become in the 15th century an article of sufficient importance in England to warrant legislative notice, as in 1483 the importation of pins was prohibited by statute. In 1540 Queen Catherine received pins from France, and again in 1543 an act was passed providing that "no person shall put to sale any pinnes but only such as shall be double headed, and have the heads soldered fast to the shank of the pinnes, well smoothed, the shank well shapen, the points well and round filed, canted and sharpened." At that time pins of good quality were made of brass; but a large proportion of those against which the legislative enactment was directed were made of iron wire blanché and passed as brass pins. To a large extent the supply of pins in England was received from France till about 1626, in which year the manufacture was introduced into Gloucestershire by John Tilsby. His business flourished so well that he soon gave employment to 1500 persons, and Stroud pins attained a high reputation. In 1636 the pinmakers of London formed a corporation, and the manufacture was subsequently established at Bristol and Birmingham, the latter town ultimately becoming the principal centre of the industry. So early as 1775 the attention of the enterprising colonists in Carolina was drawn to the manufacture by the offer of prizes for the first native-made pins and needles. At a later date several pin-making machines were invented in the United States. During the war of 1812, when the price of pins rose enormously, the manufacture was actually started, but the industry was not fairly successful till about the year 1836 when the Howe Manufacturing Company was formed at Birmingham, Connecticut. Previous to this an American, Lemuel W. Wright, had in 1824 secured in England a patent for a machine to make solid-headed pins, which established the industry on its present basis.

The old form of pin consisted of a shank with a separate head of fine wire twisted round and secured to it. Fine wire for heads was first wound on a lathe round a spit the exact circumference of the pin shank to be headed. In this way a long elastic spiral was produced which had next to be cut into heads, each consisting of two complete turns of the spiral. These heads were softened by annealing and made into a heap for the heading boy, whose duty was to thrust a number of shanks into the heap and let as many as might be fit themselves with heads. Such shanks as came out thus headed were passed to the header, who with a falling block and die arrangement compressed together shank and head of such a number as his die-block was fitted for. All the other operations of straightening the wire, cutting, pointing, &c. were separately performed, and these numerous details connected with the production of a common pin were seized on by Adam Smith as one of the most remarkable illustrations of the advantages of the division of labour.

The beautiful automatic machinery by which pins are now made of single pieces of wire is an invention of the 19th century. In 1817 a communication was made at the Patent Office by Seth Hunt, describing a machine for making pins with "head, shaft and point in one entire piece." By this machine a suitable length of wire was cut off and held in a die till a globular bead was formed on one end by compression, and the other end was pointed by the revolution around it of a roughened steel wheel. This machine does not appear to have come into use; but in 1824 Wright patented the pin-making apparatus above referred to as the parent form of the machinery now employed. A factory equipped with his machines was established in London, but the company which owned it was not successful. The plant passed into the hands of Daniel Footcote-Taylor of Birmingham, who obtained an extension of Wright's patent for five years from 1838, and his firm was the first to carry on the production of machine-made solid-headed pins on a commercial basis. In a modern pin-making machine wire of suitable gauge running off a reel is drawn in and straightened by passing between straightening pins or studs set in a table. When a pin length has entered it is caught by lateral jaws, beyond which enough of the end projects to form a pin-head. Against this end a steel punch advances and compresses the metal by a die arrangement into the form of a bead. The pin length is immediately cut off and the headed piece drops into a slit sufficiently wide to pass the wire through but retain the head. The pins are consequently suspended by the head while their projecting extremities are held against a revolving cutter, by which they are pointed. They are next cleaned by being boiled in weak beer, and then arranged in a copper pan in layers alternating with layers of grained tin. The contents of the pan are covered with water over which a quantity of argol (bitartrate of potash) is sprinkled, and after boiling for several hours the brass pins are coated with a thin deposit of tin, which gives them their silvery appearance. They are then washed in clean water, and dried and polished by being revolved in a barrel, mixed with dry bran or fine sawdust, from which they are winnowed finished pins. A large proportion of the pins sold are stuck into paper by an automatic machine not less ingenious than the pin-making machine itself. Mourning pins are made of iron wire, finished by immersing in black japan and drying in a stove. A considerable variety of pins, including the ingeniously coiled, bent and twisted nursery safety pin, ladies' hairpins, &c., are also made by automatic machinery. The sizes of ordinary pins range from the 3½-in. stout blanket pin down to the finest slender gilt pin used by entomologists, 4500 of which weigh about an ounce.

PINA, RUY DE (1440-1521), Portuguese chronicler, was a native of Guarda. He acted as secretary of the embassy sent by King John II. to Castile in the spring of 1482, and in the following September returned there as sole envoy. He was present at the execution of the duke of Braganza at Evora in 1483, and in 1484 went to Rome as secretary of an embassy to Pope Innocent VII. On his return, the king charged him to write a history of his reign and gave him a pension for his support. Following the arrival of Columbus from his first voyage in 1493, Pina was one of the commissaries despatched to Barcelona by John II. to negotiate with the Catholic sovereigns respecting the limits of their respective jurisdictions. In September 1495 he attested the will of John II. in his capacity as a notary public, and on the 27th of October of the same year he was present at his master's death at Alvor and opened and read his testament. King Manoel confirmed his pension and appointed him in 1497 chronicler of the kingdom, keeper of the archives and royal librarian, with a suitable salary. By 1504 Pina had completed his chronicles of Alphonso V. and John II. King John III. charged him with a history of his father, Manoel, and at his death Pina had carried it down to the capture of Azamor, as we know from Damão de Goes, who used it in preparing his own chronicle of that monarch.

It is probable that the chronicles of the early kings of Portugal from Sancho I. to Alphonso IV. which were published under Pina's name in the 18th century were written by Fernão Lopes and edited by Pina, while that of King Duarte seems to have been the joint production of Lopes and Azurara, with Pina again as the editor only. Pina was a favourite of fortune during his life, for, apart from royal benefactions, he received presents from public men who wished to figure well in his books, and after his death he obtained the credit for work that was not his. His authority as an historian is considerable, and his frankness is said to have provoked remark from contemporaries.

Pina's chronicle of King Alphonso IV. was first published in Lisbon in 1853; those of King Duarte and King Alphonso V. in vol. i. of the *Collaço de livros inéditos da historia portuguez*

(Lisbon, 1790), and his chronicle of John II. in vol. II. of the same collection (Lisbon, 1792). The introduction to the chronicle of King Duarte contains the fullest account of Pina's life. (E. Pr.)

PINACOTHECA, a picture-gallery (Gr. *πινακόθηκη*, from *πίναξ*, a tablet or picture). The name is especially given to the building containing pictures which formed the left wing of the Propylaea on the Acropolis at Athens. Though Pausanias (Bk. II., xxii. 6) speaks of the pictures "which time had not effaced," which seems to point to fresco painting, the fact that there is no trace of any preparation for stucco on the walls rather shows that the paintings were easel pictures (J. G. Frazer, *Pausanias's Description of Greece*, 1898, ii. 252). The Romans adopted the term for the room in a private house containing pictures, statues, and other works of art. It is used for a public gallery on the continent of Europe, as at Bologna and Turin. At Munich there are two galleries known as the Old and New Pinakothek.

PINAR DEL RIO, capital of Pinar del Rio Province, Cuba, about 107 m. S.W. by railway from Havana. Pop. (1907), 10,634. The city is in the fertile valley of the Guama. It is the centre of the tobacco industry of the Vuelta Abajo region. Its port is La Coloma, on the southern coast. The pueblo was created after 1773; but the history of the settlement goes back to 1571, and the parochial church dates from 1710.

PINCKNEY, CHARLES (1757-1824), American statesman, was born on the 26th of October 1757 at Charleston, South Carolina; he was the son of Charles Pinckney (1731-1784), first president of the first South Carolina Provincial Congress (Jan. to June 1775), and a cousin of Charles Cotesworth Pinckney and Thomas Pinckney. He was studying law at the outbreak of the War of Independence, served in the early campaigns in the South, and in 1779 was elected to the South Carolina House of Representatives. He was captured by the British at the fall of Charleston (1780), and remained a prisoner until the close of hostilities. He was elected a delegate to the Congress of the Confederation in 1784, 1785 and 1786, and in 1786 he moved the appointment of a committee "to take into consideration the affairs of the nation," advocating in this connexion an enlargement of the powers of Congress. The committee having been appointed, Pinckney was made chairman of a sub-committee which prepared a plan for amending the articles of confederation. In 1787 he was a delegate to the Federal constitutional convention, and on the same day (May 29) on which Edmund Randolph (*q.v.*) presented what is known as the Virginia plan, Pinckney presented a draft of a constitution which is known as the Pinckney plan. Although the Randolph resolutions were made the basis on which the new constitution was framed, Pinckney's plan seems to have been much drawn upon. Furthermore, Pinckney appears to have made valuable suggestions regarding phrasing and matters of detail. On the 18th of August he introduced a series of resolutions, and to him should probably be accredited the authorship of the substance of some thirty-one or thirty-two provisions of the constitution.¹ Pinck-

¹ The "Pinckney Plan" has been the subject of considerable discussion. When, in 1818, John Quincy Adams was preparing the journal of the convention for publication and discovered that the Pinckney plan was missing, he wrote to Pinckney for a copy, and Pinckney sent him what he asserted was either a copy of his original draft or a copy of a draft which differed from the original in no essentials. But as this was found to bear a close resemblance to the draft reported by the committee of detail, Madison and others, who had been members of the convention, as well as historians, treated it as spurious, and for years Pinckney received little credit for his work in the convention. Later historians, however, notably J. Franklin Jameson and Andrew C. McLaughlin, have accredited to him the suggestion of a number of provisions of the constitution, as a result of their efforts to reconstruct his original plan chiefly from his speeches, or alleged speeches, and from certain papers of James Wilson, a member of the committee of detail, one of which papers is believed to be an outline of the Pinckney plan. See J. F. Jameson, "Studies in the History of the Federal Convention of 1787," in the *Annual Report of the American Historical Association for 1902*, vol. I.; A. C. McLaughlin, "Outline of Pinckney's Plan for a Constitution," in *The Nation*, April 28, 1904; an article entitled "Sketch of Pinckney's Plan for a Constitution," in the *American Historical Review for July 1904*; and C. C. Nott, *The Mystery of the Pinckney Draft* (New York, 1908), an attempt by a former chief-justice of the U.S. Court of Claims to prove that

ney was president of the State Convention of 1790 that framed a new constitution for South Carolina, was governor of the state from 1789 to 1792, a member of the state House of Representatives in 1792-1796, and again governor from 1796 to 1798. From 1799 to 1801 he was a member of the United States Senate. He entered public life as a Federalist, but later became the leader in organizing the Democratic-Republican party in his state, and contributed largely to the success of Thomas Jefferson in the presidential election of 1800. By Jefferson's appointment he was American minister to Spain from 1801 to 1805. In general his mission was a distinct failure, his arrogance and indiscretions finally causing the Spanish government to request his recall. He was elected to the state House of Representatives in 1805, was again governor of South Carolina from 1806 to 1808, in 1810-1814 was once more a member of the state House of Representatives, in which he defended President Madison's war policy, and from 1819 to 1821 was a member of the National House of Representatives, in which he opposed the Missouri Compromise in a brilliant speech. He died at Charleston, South Carolina, on the 20th of October 1824.

His son, HENRY LAURENS PINCKNEY (1794-1863), was a member of the state House of Representatives in 1816-1832, founded in 1819 and edited for fifteen years the *Charleston Mercury*, the great exponent of state's rights principles, and was a member of the National House of Representatives in 1833-1837.

PINCKNEY, CHARLES COTESWORTH (1746-1825), American statesman, was born in Charleston, South Carolina, on the 25th of February 1746, the son of Charles Pinckney (*d. 1758*),² by his second wife, the celebrated girl planter, Eliza Lucas. When a child he was sent to England, like his brother Thomas after him, to be educated. Both of them were at Westminster and Oxford and were called to the bar, and for a time they studied in France at the Royal Military College at Caen. Returning to America in 1769, C. C. Pinckney began the practice of law at Charleston, and soon became deputy attorney-general of the province. He was a member of the first South Carolina provincial congress in 1775, served as colonel in the South Carolina militia in 1776-1777; was chosen president of the South Carolina Senate in 1779, took part in the Georgia expedition and the attack on Savannah in the same year, was captured at the fall of Charleston in 1780 and was kept in close confinement until 1782, when he was exchanged. In 1783 he was commissioned a brevet brigadier-general in the continental army. He was an influential member of the constitutional convention of 1787, advocating the counting of all slaves as a basis of representation and opposing the abolition of the slave-trade. He opposed as "impracticable" the election of representatives by popular vote, and also opposed the payment of senators, who, he thought, should be men of wealth. Subsequently Pinckney bore a prominent part in securing the ratification of the Federal constitution in the South Carolina convention called for that purpose in 1788 and in framing the South Carolina State Constitution in the convention of 1790. After the organization of the Federal government, President Washington offered him at different times appointments as associate justice of the Supreme Court (1791), secretary of war (1795) and secretary the document sent by Pinckney to Adams in 1818 is a genuine copy of his original plan.

² Charles Pinckney, the father, was long prominent in colonial affairs; he was attorney-general of the province in 1733, speaker of the assembly in 1736-1738 and in 1740, chief justice of the province in 1752-1753, and agent for South Carolina in England in 1753-1758. He was the uncle of Charles Pinckney (1731-1784), and the great-uncle of Charles Pinckney (1757-1824). Eliza Lucas Pinckney (*c. 1722-1793*) was the daughter of Lieut.-Colonel George Lucas of the British army, who about 1738 removed from Antigua to South Carolina, where he acquired several plantations. He was almost immediately recalled to Antigua, and his daughter undertook the management of the plantations with conspicuous success. She is said to have been the first to introduce into South Carolina (and into continental North America) the cultivation and manufacture of indigo, and she also imported silk-worms in 1753 she presented to the princess of Wales a dress made of silk from her plantations. She was married to Charles Pinckney in 1744. See Harriett H. Ravenel, *Eliza Pinckney* (New York, 1896), in the "Women of Colonial and Revolutionary Times" series.

of state (1795), each of which he declined; but in 1796 he succeeded James Monroe as minister to France. The Directory refused to receive him, and he retired to Holland, but in the next year, Elbridge Gerry and John Marshall having been appointed to act with him, he again repaired to Paris, where he is said to have made the famous reply to a veiled demand for a "loan" (in reality for a gift), "Millions for defence, but not one cent for tribute,"—another version is, "No, not a sixpence." The mission accomplished nothing, and Pinckney and Marshall left France in disgust, Gerry (*q.v.*) remaining. When the correspondence of the commissioners was sent to the United States Congress the letters "X," "Y" and "Z," were inserted in place of the names of the French agents with whom the commission treated—hence the "X Y Z Correspondence," famous in American history. In 1800 he was the Federalist candidate for vice-president, and in 1804 and again in 1808 for president, receiving 14 electoral votes in the former and 47 in the latter year. From 1805 until his death, on the 16th of August 1825, he was president-general of the Society of the Cincinnati.

PINCKNEY, THOMAS (1750–1828), American statesman and diplomat, was born in Charleston, South Carolina, on the 23rd of October 1750, a younger brother of Charles Cotesworth Pinckney (*q.v.*). Educated in England, he returned to Charleston in 1773, and was admitted to the bar in 1774. During the War of Independence his early training at the French military college at Caen enabled him to render effective service to General Benjamin Lincoln in 1778–1779, to Count d'Estaing (1779), to General Lincoln in the defence of Charleston and afterwards to General Horatio Gates. In the battle of Camden he was badly wounded and captured, remaining a prisoner for more than a year. Subsequently he was governor of South Carolina in 1787–1789; presided over the state convention which ratified the Federal constitution in 1788; was a member of the state legislature in 1791; and was United States minister to Great Britain in 1792–1796. During part of this time (1794–1795) he was also envoy extraordinary to Spain, and in this capacity negotiated (1795) the important Treaty of San Lorenzo el Real; by that treaty the boundary between the United States and East and West Florida and between the United States and "Louisiana" was settled (Spain relinquishing all claims east of the Mississippi above 31° N. lat.), and the United States secured the freedom of navigation of the Mississippi to its mouth with the right of deposit at New Orleans for three years, after which the United States was to have the same right either at New Orleans or at some other place on the Mississippi to be designated by Spain. In 1796 Pinckney was the Federalist candidate for vice-president, and in 1797–1801 he was a Federalist representative in Congress. During the War of 1812 he was a major-general. In 1825 he succeeded his brother as president-general of the Society of the Cincinnati. He died in Charleston on the 2nd of November 1828. Pinckney, like many other South Carolina revolutionary leaders, was of aristocratic birth and politics, closely connected with England by ties of blood, education and business relations. This renders the more remarkable their attitude in the War of Independence, for which they made great sacrifices. Men of Pinckney's type were not in sympathy with the progressive democratic spirit of America, and they began to withdraw from politics after about 1800.

See C. C. Pinckney, *Life of General Thomas Pinckney* (Boston, 1895).

PINDAR (Gr. Πινδαρος, c. 522–443 B.C.), the great lyric poet of ancient Greece, was born at Cynoscephalæ, in Boeotia, at the time of the Pythian games (*fr.* 175, Bergk¹, 193),² which is taken by Böckh to be 522 B.C. He would thus be some thirty-four years younger than Simonides of Ceos. He was the son of Daiphantus and Cleodice (or Cleidice). The traditions of his family have left their impress on his poetry, and are not without importance for a correct estimate of his relation to his contemporaries. The clan of the Aegidae—tracing their line from the hero Aegæus—belonged to the "Cadmean" element

of Thebes, i.e. to the elder nobility whose supposed date went back to the days of the founder Cadmus. A branch of the Theban Aegidae had been settled in Achæan times at Amyclæ in the valley of the Eurotas (*Pind. Isthm.* vi. 14), and after the Dorian conquest of the Peloponnesus had apparently been adopted by the Spartans into one of the three Dorian tribes. The Spartan Aegidae helped to colonize the island of Thera (*Pyth.* v. 68–70). Another branch of the race was settled at Cyrene in Africa; and Pindar tells how his Aegid clansmen at Thebes "showed honour" to Cyrene as often as they kept the festival of the Carneia (*Pyth.* v. 75). Pindar is to be conceived, then, as standing within the circle of those families for whom the heroic myths were domestic records. He had a personal link with the memories which everywhere were most cherished by Dorians, no less than with those which appealed to men of "Cadmean" or of Achæan stock. And the wide ramifications of the Aegidae throughout Hellas rendered it peculiarly fitting that a member of that illustrious clan should celebrate the glories of many cities in verse which was truly Panhellenic.

Pindar is said to have received lessons in flute-playing from one Scopelinus at Thebes, and afterwards to have studied at Athens under the musicians Apollodorus (or Agathocles) and Lasus of Hermione. In his youth, as the story went, he was defeated in a poetical contest by the Theban Corinna—who, in reference to his profuse employment of Theban mythology, is said to have advised him "to sow with the hand, not with the sack." There is an extant fragment in which Corinna reproves another Theban poetess, Myrtis, "for that she, a woman, contended with Pindar" (*ὄρι βαυδ ποιοῖ' ἔσα Πινδαροῦ ποτ' ἔφου*)—a sentiment which hardly fits the story of Corinna's own victory. The facts that stand out from these meagre traditions are that Pindar was precocious and laborious. Preparatory labour of a somewhat severe and complex kind was, indeed, indispensable for the Greek lyric poet of that age. Lyric composition demanded studies not only in metre but in music, and in the adaptation of both to the intricate movements of the choral dance (*ὄρχηστραή*). Several passages in Pindar's extant odes glance at the long technical development of Greek lyric poetry before his time, and at the various elements of art which the lyrist was required to temper into a harmonious whole (see, e.g. *Ol.* iii. 8, vi. 91, xiii. 18, xiv. 15; *Pyth.* xii. 23, &c.). The earliest ode which can be dated (*Pyth.* x.) belongs to the twentieth year of Pindar's age (502 B.C.); the latest (*Olymp.* v.) to the seventieth (452 B.C.).³ He visited the court of Hiero at Syracuse; Theron, the despot of Acragas, also entertained him; and his travels perhaps included Cyrene. Tradition notices the special closeness of his relations with Delphi: "He was greatly honoured by all the Greeks, because he was so beloved of Apollo that he even received a share of the offerings; and at the sacrifices the priest would cry aloud that Pindar come in to the feast of the god."⁴ His wife's name was Megacleia (another account says Timoxena, but this may have been a second wife), and he had a son named Daiphantes and two daughters, Eumetis and Protomache. He is said to have died at Argos, at the age of seventy-nine, in 443 B.C.

Among the Greeks of his own and later times Pindar was pre-eminently distinguished for his piety towards the gods. He tells us that, "near to the vestibule" of his house (*Pyth.* iii. 78), choruses of maidens used to dance and sing by night in praise of the Mother of the Gods (Cybele) and Pan—deities peculiarly associated with the Phrygian music of the flute, in which other members of Pindar's family besides the poet himself are said to have excelled. A statue and shrine of Cybele, which he dedicated at Thebes, were the work of the Theban artists, Aristomedes and Socrates. He also dedicated at Thebes a statue to Hermes Agoraios, and another, by Calamis, to Zeus Ammon. The latter god claimed his especial veneration because Cyrene, one of the homes of his Aegid ancestry, stood "where Zeus Ammon hath his seat," i.e. near the oasis and temple

¹ According to others, his latest poem is the eighth Pythian ode, 450 or 446.

² Πινδαρου γένος, in ed. Ald.

³ The references are to the edition of Pindar by C. A. M. Fennell (1893–1899), and the fourth edition of Bergk's *Poetae Lyrici graeci*.

(*Pyth.* iv. 16). The author of one of the Greek lives of Pindar says that, "when Pausanias the king of the Lacedaemonians was burning Thebes, some one wrote on Pindar's house, 'Burn not the house of Pindar the poet'; and thus it alone escaped destruction." This incident, of which the occasion is not further defined, has been regarded as a later invention.¹ Better attested, at least, is the similar clemency of Alexander the Great, when he sacked Thebes one hundred and eight years after the traditional date of Pindar's death (335 B.C.). He spared only (1) the Cadmeia, or citadel, of Thebes (thenceforth to be occupied by a Macedonian garrison); (2) the temples and holy places; and (3) Pindar's house. While the inhabitants were sold into slavery, exception was made only of (1) priests and priestesses; (2) persons who had been connected by private *φιλία* with Philip or Alexander, or by public *φιλία* with the Macedonians; (3) Pindar's descendants. It is probable enough, as Dio Chrysostom suggests (ii. 33), that Alexander was partly moved by personal gratitude to a poet who had celebrated his ancestor Alexander I. of Macedon. But he must have been also, or chiefly, influenced by the sacredness which in the eyes of all Hellenes surrounded Pindar's memory, not only as that of a great national poet, but also as that of a man who had stood in a specially close relation to the gods, and, above all, to the Delphian Apollo.² Upwards of six hundred years after Pindar's death the traveller Pausanias saw an iron chair which was preserved among the most precious treasures of the temple in the sanctuary at Delphi. It was the chair, he was told, "in which Pindar used to sit, whenever he came to Delphi, and to chant those of his songs which pertain to Apollo" (x. 24, 5).

During the second half of Pindar's life, Athens was rising to that supremacy in literature and art which was to prove more lasting than her political primacy. Pindar did not live to see the Parthenon, or to witness the mature triumphs of Sophocles; but he knew the sculpture of Calamis, and he may have known the masterpieces of Aeschylus. It is interesting to note the feeling of this great Theban poet, who stands midway between Homeric epos and Athenian drama, towards the Athens of which Thebes was so often the bitterest foe, but with which he himself had so large a measure of spiritual kinship. A few words remain from a dithyramb in which he paid a glowing tribute to those "sons of Athens" who "laid the shining foundations of freedom" (*παῖδες Ἀθηναίων ἱθάκοντο φωνῆναι κρητὶς ἑλευθερίας*, *fr.* 55, Bergk¹, 77), while Athens itself is thus invoked: *ὦ ναὶ λατράρι καὶ ἰσοσφάρασι καὶ αἰετῶσι, Ἑλλάδος ἔρσημα, κλεινὰ Ἀθῆναι, δαμνῶντων προδόντων* (*fr.* 54, Bergk¹, 76). Isocrates, writing in 353 B.C., states that the phrase "Ἑλλάδος ἔρσημα," "stay of Hellas," so greatly gratified the Athenians that they conferred on Pindar the high distinction of *προξενία* (i.e. appointed him honorary consul, as it were—for Athens at Thebes), besides presenting him with a large sum of money (*Antidosis*, 166). One of the letters of the pseudo-Aeschines (*Ep.* iv.) gives an improbable turn to the story by saying that the Thebans had fined Pindar for his praise of Athens, and that the Athenians repaid him twice the sum.³ The notice preserved by Isocrates—less than one hundred years after Pindar's death—is good warrant for the belief that Pindar had received some exceptional honours from Athens. Pausanias saw a statue of Pindar at Athens, near the temple of Ares (i. 8, 4). Besides the fragment just mentioned, several passages in Pindar's extant odes bespeak his love for Athens. Its name is almost always joined by him with some epithet of praise or reverence. In alluding to the great battles of the Persian wars, while he gives the glory of Plataea to the Spartans, he assigns that of Salamis to the Athenians (*Pyth.* i. 76). In celebrating (*Pyth.* vii.) the Pythian

¹ A. Schäfer, *Demosthenes und seine Zeit.* iii. 119.

² It will be remarked that history requires us to modify the statement in Milton's famous lines:—

"The great Emathian conqueror bade spare
The house of Pindarus, when temple and tower
Went to the ground."

Indeed, the point of the incident depends much on the fact that the temples and Pindar's house were classed together for exemption.

³ Compare Jebb, *Aitic Orators.* ii. 143.

victory of the Athenian Megacles, he begins thus: "Fairest of preludes is the renown of Athens for the mighty race of the Alcmaeonidae. What home, or what house, could I call mine by a name that should sound more glorious for Hellas to hear?" Referring to the fact that an Aeginetan victor in the games had been trained by an Athenian, he says (*Nem.* v. 49) "meet it is that a shaper of athletes should come from Athens"—and recollecting how often Pindar compares the poet's efforts to the athlete's, we may well believe that he was thinking of his own early training at Athens.

Pindar's versatility as a lyric poet is one of the characteristics remarked by Horace (*Odes*, iv. 2), and is proved by the fragments, though the poems which have come down entire represent only one class of compositions—the *Epinicia*, or odes of victory, commemorating successes in the great games. The lyric types to which the fragments belong, though it cannot be assumed that the list is complete, are at least numerous and varied.

(1) *Ἦμνοι*, *Hymns* to deities—as to Zeus Ammon, to Persephone, to Fortune. The fragmentary *Ἦμνος* entitled *Ὀψέλιος* seems to have celebrated the deities of Thebes. (2) *Ἰατρικά*, *Pragmatica*, *paeanis*, expressing prayer or praise for the help of *Zeus*. (3) *Διθύραμβοι*, *Dithyrambs*, odes of a lofty and impassioned strain, sung by choruses in honour of Dionysus (cf. *Pind.* *Ol.* xiii. 18, *ναὶ Διονύσιον πᾶν ἑτάραον εἰν ὀρχήσασθαι Χάρτες ἀδούρατος*—where Pindar alludes to the choral form given to the dithyramb, c. 600 B.C., by Arion—*βορῆαίον*, "ox-driving," perhaps meaning "winning an ox as prize"). (4) *Προόδεια*, *Processional Songs*, choral chants for worshippers approaching a shrine. One was written by Pindar for the Delians, another for the Aeginetans. (5) *Παρθενικά*, *Choral Songs for Maidens*. The reference in *Pyth.* iii. 78 to maidens worshipping Cybele and Pan near the poet's house is illustrated by the fact that one of these *Παρθενικά* invoked "Pan, lord of Arcadia, attendant of the Great Mother, watcher of her awful shrine" (*fr.* 72, Bergk¹, 95). (6) *Τροχίαινα*, *Choral Dance-Songs*, adapted to a lively movement, used from an early date in the cult of Apollo, and afterwards in that of other gods, especially Dionysus. To this class belongs one of the finest fragments (84, Bergk¹, 107), written for the Thebans in connection with propitiatory rites after an eclipse of the sun, probably that of the 30th of April 463 B.C. (7) *Ἐπάσματα*, *Songs of Praise* (for men, while *Ἦμνοι* were for gods), to be sung by a *κόμος* or *festal company*. In strictness *Ἐπάσματα* was the genus of which *Ἦμνοι* was a species; but the latter is more conveniently treated as a distinct kind. Pindar wrote *εὐκαμία* for Theron, despot of Acragas, and for Alexander I. (son of Amyntas) king of Macedon. (8) *Στάβα*, *Festal Songs*. The usual sense of *στάβα* is a drinking-song, taken up by one guest after another at a banquet. But Pindar's *στάβα* were choral and antistrophic. One was to be sung at Corinth by a chorus of the *ἑτάρατοι* attached to the temple of Aphrodite Ourania, when a certain Xenophon offered sacrifice before going to compete at Olympia. Another brilliant fragment, for Theocritus of Tenedos, has an erotic character. (9) *Ὀδοί*, *Dirges*, to be sung with choral dance and the music of the flute, either at the burial of the dead or in commemorative rituals. Some of the most beautiful fragments belong to this class (106–110, Bergk¹, 129–133). One of the smaller fragments (114, Bergk¹, 137)—in memory of an Athenian who had been initiated into the Eleusinian mysteries (*Ἰθὴν μέγα*)—has been conjecturally referred to the *Ὀδοί* which Pindar is said to have written (*schol.* *Pyth.* vii. 18) for Hippocrates, the grandfather of Pericles. A number of small fragments, which cannot be certainly classified, are usually given as *ἔξ ἀβήτων ἄλκιον*, "of uncertain class." On comparing the above list with Horace, *Odes*, iv. 2, it will be seen that he alludes to No. 3 (*dithyrambus*); to Nos. 1, 2, and 4 (*sex deo regibus canit*); and to No. 9 (*Arcti sponsae iuvenem raptum Plorati*)—as well as to the extant *Epinicia* (*sive quas Elea domum reduci Palma caelestis*).

The *Epinicia*.—The *ἐπινίκια* (sc. μέλα), or *ἐπινίκια* (sc. Ἦμνοι), "Odes of Victory," form a collection of forty-four odes, traditionally divided into four books, answering to the four great festivals: (1) *Ὀλυμπιονίκια* (sc. Ἦμνοι): fourteen odes for winners of the wild olive-wreath in the Olympian games, held at Olympia in honour of Zeus once in four years; (2) *Πυθιονίκια*: twelve odes for winners of the laurel-wreath in the Pythian games held at Delphi in honour of Apollo, once in four years, the third of each Olympiad; (3) *Νεμεονίκια*: eleven odes for winners of the pine-wreath in the Nemean games, held at Nemea, in honour of Zeus, once in two years, the second and fourth of each Olympiad; and (4) *Ισθμιονίκια*: seven odes for winners of the parsley wreath in the Isthmian games, held at the *Ἐσθμῶν*

of Corinth, in honour of Poseidon, once in two years, the first and third of each Olympiad. The Greek way of citing an ode is by the nomin. *πίναρ*, followed by the numeral, e.g. "the ninth Olympian" is 'Ἄλυμπεύεικα θ'. The chronological range of the collection (so far as ascertainable) is from 502 B.C. (*Pyth. x.*) to 452 B.C. (*Ol. v.*). With respect to the native places of the victors, the geographical distribution is as follows: for the mainland of Greece proper, 13 odes; for Aegina, 11; for Sicily, 15; for the Epizephyrian Locrians (southern Italy), 2; for Cyrene (Africa), 5.

The general characteristics of the odes may be briefly considered under the following heads: (1) language; (2) treatment of theme; (3) sentiment—religious, moral and political; (4) relation to contemporary art.

1. The diction of Pindar is distinct in character from that of every other Greek poet, being almost everywhere marked by the greatest imaginative boldness. Thus (a) metaphor is used even for the expression of common ideas, or the translation of familiar phrases, as when a cloak is called (*Ol. ix. 97*) "a warm remedy for winds." (b) Images for the highest excellence are drawn from the farthest limits of travel or navigation, or from the fairest of natural objects; as when the superlative hospitality of a man who kept open house all the year round is described by saying, "far as to Phasis was his voyage in summer days, and in winter to the shores of Nile" (*Isthm. ii. 41*); or when Olympia, the "crown" or "flower" of festivals, is said to be excellent as water, bright as gold, brilliant as the noonday sun (*Ol. i. ad inii.*). This trait might be called the *Pindaric imagery of the superlative*. (c) Poetical inversion of ordinary phrase is frequent; as, instead of, "he struck fear into the beasts," "he gave the beasts to fear" (*Pyth. v. 56*). (d) The efforts of the poet's genius are represented under an extraordinary number of similitudes, borrowed from javelin-throwing, chariot-driving, leaping, rowing, sailing, ploughing, building, shooting with the bow, sharpening a knife on a whetstone, mixing wine in a bowl, and many more. (e) Homely images, from common life, are not rare; as from account-keeping, usury, sending merchandise over sea, the *στανάλη* or secret dispatch, &c. And we have such homely proverbs as, "he hath his foot in this shoe," i.e. stands in this case (*Ol. vi. 8*). (f) The natural order of words in a sentence is often boldly deranged, while, on the other hand, the syntax is seldom difficult. (g) Words not found except in Pindar are numerous, many of these being compounds which (like *ἐπιμυθότροπος*, *καταθύλλοποιός*, &c.) suited the dactylic metres in their Pindaric combinations. Horace was right in speaking of Pindar's "nova verba," though they were not confined to the "audaces dithyrambi."

2. The actual victory which gave occasion for the ode is seldom treated at length or in detail—which, indeed, only exceptional incidents could justify. Pindar's method is to take some heroic myth, or group of myths, connected with the victor's city or family, and, after a brief prelude, to enter on this, returning at the close, as a rule, to the subject of the victor's merit or good fortune, and interspersing the whole with moral comment. Thus the fourth Pythian is for Arcesilaus, king of Cyrene, which was said to have been founded by men of Thera, descendants of one of Jason's comrades. Using this link, Pindar introduces his splendid narrative of the Argonauts. Many odes, again, contain shorter mythical episodes—as the birth of Iamus (*Ol. vi.*), or the vision of Bellerophon (*Ol. xiii.*)—which form small pictures of masterly finish and beauty. Particular notice is due to the skill with which Pindar often manages the return from a mythical digression to his immediate theme. It is bold and swift, yet is not felt as harshly abrupt—justifying his own phrase at one such turn—*καί τινα ἄμιον ἵαμι βραχίον* (*Pyth. iv. 247*). It has been thought that, in the parenthesis about the Amazons' shields (*quibus Mos unde deducit. querere distuli*, *Ods.*, iv. 4, 18), Horace was imitating a Pindaric transition; if so, he has illustrated his own observation as to the peril of imitating the Theban poet.

3. a. The religious feeling of Pindar is strongly marked in the odes. "From the gods are all means of human excellence."

He will not believe that the gods, when they dined with Tantalus, ate his son Pelops; rather Poseidon carried off the youth to Olympus. That is, his reason for rejecting a scandalous story about the gods is purely religious, as distinct from moral; it shocks his conception of the divine dignity. With regard to oracles, he inculcates precisely such a view as would have been most acceptable to the Delphic priesthood, viz. that the gods do illumine their prophets, but that human wit can foresee nothing which the gods do not choose to reveal. A mystical doctrine of the soul's destiny after death appears in some passages (as *Ol. ii. 66 sq.*). Pindar was familiar with the idea of metempsychosis (cf. *ibid. 68*), but the attempt to trace Pythagoreanism in some phrases (*Pyth. ii. 34, iii. 74*) appears unsafe. The belief in a fully conscious existence for the soul in a future state, determined by the character of the earthly life, entered into the teaching of the Eleusinian and other mysteries. Comparing the fragment of the *Θρήνος* (124, Bergk⁴, 137), we may probably regard the mystic or esoteric element in Pindar's theology as due to such a source.

b. The moral sentiment pervading Pindar's odes rests on a constant recognition of the limits imposed by the divine will on human effort, combined with strenuous exhortation that each man should strive to reach the limit allowed in his own case. Native temperament (*φύσις*) is the grand source of all human excellence (*ἀρετή*), while such excellences as can be acquired by study (*βιβλική ἀρετή*, *Ol. ix. 100*) are of relatively small scope—the sentiment, we may remark, of one whose thoughts were habitually conversant with the native qualities of a poet on the one hand and of an athlete on the other. The elements of *ὕψις ἄβυσος*—"same happiness," such as has least reason to dread the jealousy of the gods—are substance sufficing for daily wants and good repute (*εὐδοκία*). He who has these should not "seek to be a god." "Wealth set with virtues" (*πλοῦτος ἀρεταῖς δεδαυδαμένος*), as gold with precious gems, is the most fortunate lot, because it affords the amplest opportunities for honourable activity. Pindar does not rise above the ethical standard of an age which said, "love thy friend and hate thy foe" (cf. *Pyth. ii. 83; Isthm. iii. 65*). But in one sense he has a moral elevation which is distinctively his own; he is the glowing prophet of generous emulation and of reverent self-control.

c. The political sentiments of the Theban poet are suggested by *Pyth. xi. 52*; "In politics I find the middle state crowned with more enduring good; therefore praise I not the despot's portion; those virtues move my zeal which serve the folk." If in *Pyth. ii. 87*, a democracy is described as *ὁ λάβρος σπαραξ*, "the raging crowd," it is to be noted that the ode is for Hiero of Syracuse, and that the phrase clearly refers to the violence of those democratic revolutions which, in the early part of the 5th century B.C., more than once convulsed Sicilian cities. At Thebes, after the Persian wars, a "constitutional oligarchy" (*δυναστεία ἰστωμοσ*, Thuc. iii. 62) had replaced the narrower and less temperate oligarchy of former days (*δυναστεία οὐ μετὰ νόμον*); and in this we may probably recognize the phase of Greek political life most congenial to Pindar. He speaks of a king's lot as unique in its opportunities (*Ol. i. 113*), he sketches the character of an ideal king (*Pyth. iii. 71*); but nothing in his poetry implies liking for the *τυραννίς* as a form of government. Towards the Greek princes of Sicily and Cyrene his tone is ever one of manly independence; he speaks as a Greek citizen whose lineage places him on a level with the proudest of the Dorian race, and whose office invests him with an almost sacred dignity. In regard to the politics of Hellas at large, Pindar makes us feel the new sense of leisure for quiet pursuits and civilizing arts which came after the Persian wars. He honours "Tranquillity, the friend of cities" (*Λαυχία φιλόπολις*, *Ol. iv. 16*). The epic poet sang of wars; Pindar celebrates the "rivalries of peace."

4. Pindar's genius was boldly original; at the same time he was an exquisite artist. "Minc be it to invent new strains, mine the skill to hold my course in the chariot of the Muses, and may courage go with me, and power of ample grasp" (*Ol.*

ix. 80). Here we see the exulting sense of inborn strength, in many other places we perceive the feeling of conscious art—as in the phrase *δαδάλλειν*, so apt for his method of inlaying an ode with mythical subjects, or when he compares the opening of a song to the front of a stately building (*Ol.* vi. 3). Pindar's sympathy with external nature was deeper and keener than is often discernible in the poetry of his age. It appears, for example, in his welcome of the season when "the chamber of the hours is opened, and delicate plants perceive the fragrant spring" (*fr.* 53, Bergk⁴, 75), in the passage where Jason invokes "the rushing strength of waves and winds, and the nights, and the paths of the deep" (*Pyth.* iv. 195), in the lines on the eclipse of the sun (*fr.* 84, Bergk⁴, 107); and in the picture of the eruption, when Etna, "pillar of the sky, nurse of keen snow all the year," sends forth "pure springs of fire unapproachable" (*Pyth.* i. 20). The poet's feeling for colour is often noticeable—as in the beautiful story of the birth of Iamus—when Evadne lays aside her silver pitcher and her girdle of scarlet web, the babe is found, "its delicate body steeped in the golden and deep purple rays of pansies" (*Ol.* vi. 55).

The spirit of art, in every form, is represented for Pindar by *χάρις*—"the source of all delights to mortals" (*Ol.* i. 30)—or by the personified Charites (Graces). The Charites were often represented as young maidens, decking themselves with early flowers—the rose, in particular, being sacred to them as well as to Aphrodite. In Pindar's mind, as in the old Greek conception from which the worship of the Charites sprang, the instinct of beautiful art was inseparable from the sense of natural beauty. The period from 500 to 460 B.C., to which most of Pindar's extant odes belong, marked a stage in the development of Greek sculpture. The schools of Argos, Sicyon and Aegina were effecting a transition from archaic types to the art which was afterwards matured in the age of Phedias. Olympia forms the central link between Pindar's poetry and Greek sculpture. From about 500 B.C. onwards sculpture had been applied to the commemoration of athletes, chiefly at Olympia. In a striking passage (*Nem.* v. *ad. int.*) Pindar recognizes sculpture and poetry as sister arts employed in the commemoration of the athlete, and contrasts the merely local effect of the statue with the wide diffusion of the poem. "No sculptor I, to fashion images that shall stand idly on one pedestal for aye; no, go thou forth from Aegina, sweet song of mine, on every freighted ship, on each light bark." Many particular subjects were common to Pindar and contemporary sculpture. Thus (1) the sculptures on the east pediment of the temple at Aegina represented Heracles coming to seek the aid of Telamon against Troy—a theme brilliantly treated by Pindar in the fifth Isthmian; (2) Hiero's victory in the chariot-race was commemorated at Olympia by the joint work of the sculptors Onatas and Calamis, (3) the Gigantomachia, (4) the wedding of Heracles and Hebe, (5) the war of the Centaurs with the Lapithae, and (6) a contest between Heracles and Apollo, are instances of mythical material treated alike by the poet and by sculptors of his day. The contemporary improvements in town architecture, introducing spacious and well-paved streets, such as the *στυρωτή δόξος* at Cyrene (*Pyth.* v. 87), suggests his frequent comparison of the paths of song to broad and stately causeways (*ἡραρεῖαι πρόσδοιοί—εὐαγυρέοιοί κλειδοί*, *Nem.* vi. 47; *Isthm.* vi. 22). A song is likened to cunning work which blends gold, ivory and coral (*Nem.* vii. 78). Pindar's feeling that poetry, though essentially a divine gift, has a technical side (*σοφία*), and that on this side it has had an historical development like that of other arts, is forcibly illustrated by his reference to the inventions (*σοφίσματα*) for which Corinth had early been famous. He instances (1) the development of the dithyramb, (2) certain improvements in the harnessing and driving of horses, and (3) the addition of the pediment to temples (*Ol.* xiii. 21).

In the development of Greek lyric poetry two periods are broadly distinguished. During the first, from about 600 to 500 B.C., lyric poetry is local or tribal—as Alcaeus and Sappho write for Lesbians, Alcman and Stesichorus for Dorians. During

the second period, which takes its rise in the sense of Hellenic unity created by the Persian wars, the lyric poet addresses all Greece. Pindar and Simonides are the great representatives of this second period, to which Bacchylides, the nephew of Simonides, also belongs. These, with a few minor poets, are classed by German writers as *die universalen Meliker*. The Greeks usually spoke, not of "lyric," but of "melic" poetry (*i.e.* meant to be sung, and not, like the epic, recited); and "universal melic" is lyric poetry addressed to all Greece. But Pindar is more than the chief extant lyricist. Epic, lyric and dramatic poetry succeeded each other in Greek literature by a natural development. Each of them was the spontaneous utterance of the age which brought it forth. In Pindar we can see that phase of the Greek mind which produced Homeric epics passing over into the phase which produced Athenian drama. His spirit is often thoroughly dramatic—witness such scenes as the interview between Jason and Pelias (*Pyth.* iv.), the meeting of Apollo and Chiron (*Pyth.* ix.), the episode of Castor and Polydeuces (*Nem.* x.), the entertainment of Heracles by Telamon (*Isthm.* v.). Epic narrative alone was no longer enough for the men who had known that great trilogy of national life, the Persian invasions, they longed to see the heroes moving and to hear them speaking. The poet of Olympia, accustomed to see beautiful forms in vivid action or vivid art, was well fitted to be the lyric interpreter of the new dramatic impulse. Pindar has more of the Homeric spirit than any Greek lyric poet known to us. On the other side, he has a genuine, if less evident, kinship with Aeschylus and Sophocles. Pindar's work, like Olympia itself, illustrates the spiritual unity of Greek art.

The fact that certain glosses and lacunae are common to all our MSS of Pindar make it probable that these MSS. are derived from a common archetype. Now the older scholia on Pindar, which appear to have been compiled mainly from the commentaries of Didymus (c. 15 B.C.), sometimes presuppose a purer text than ours. But the compiler of these older scholia lived after Herodian (A.D. 160). The archetype of our MSS., then, cannot have been older than the end of the 2nd century. Our MSS. fall into two general classes. (1) the older, representing a text which, though often corrupt, is comparatively free from interpolations; (2) the later, which exhibit the traces of a Byzantine recension, in other words, of lawless conjecture, down to the 14th or 15th century. To the first class belong Parisinus 7, breaking off in *Pyth.* v.; Ambrosianus 1, which has only *Ol.* i.-xii.; Medicus 2; and Vaticanus 2—the two last-named being of the highest value. The editio princeps is the Aldine (Venice, 1513). A modern study of Pindar may be almost said to have begun with C. G. Heyse's edition (1773). Hermann did much to advance Pindaric criticism. But August Böckh (1811-1821), who was assisted in his commentary by L. Dissen, is justly regarded as the founder of a scientific treatment of the poet. The edition of Theodor Bergk (*Poetae Lyrae graecae*, new ed. by O. Schröder, 1906) is marked by considerable boldness of conjecture, as that of Tycho Mommsen (1864) by a sometimes excessive adherence to MSS. A recension by W. Christ has been published in Teubner's series (2nd ed., 1896), also with Prolegomena and commentary (1896), and by O. Schröder (1908). The complete edition of J. W. Donaldson (1841) has many merits; but that of C. A. M. Fennell (1879-1883; new ed., 1893-1899) is better adapted to the needs of English students. The *Olympics and Pythias* have been edited by B. L. Gildersleeve (1885), the *Nemea and Isthmia* by J. B. Bury (1890-1892); the *Scholia* by E. Abel (1890, unfinished) and A. B. Brachmann (1903). There is a special lexicon by J. Rumpel (1883). The translation into English prose by Ernest Myers (2nd ed., 1883) is excellent; verse translation by T. C. Baring (1875), and of the *Olympian Odes* by Cyril Mayne (1906). Pindar's metres have been analysed by J. H. H. Schmidt, in *Die Kunstformen der griechischen Poesie* (Leipzig, 1868-1872). On Pindar generally, see monographs by A. F. Villemann (1859), L. Schmidt (1862), G. Löbber (1882), A. Crouzet (1880), W. Christ, *Geschichte der griechischen Literatur* (1898); and the little volume by F. D. Morice in Blackwood's *A select Classics for English Readers*. Exhaustive bibliographical information on the earlier literature will be found in Engelmann, *Scriptores graeci* (1881); see also L. Bornemann, in *Bursian's Jahresbericht*, lxxvi. 1904; with special reference to chronological questions and *Pythia*, i., ii., iii. Some considerable fragments of the poems were discovered in 1906 by B. P. Grenfell and A. S. Hunt (see *Oxyrhynchus papyri*, pt. v. pp. 24-81); some critical notes will be found in *Classical Review*, Feb. 1908 (A. E. Housman).

(R. C. J.; X.)

PINDARICS, the name by which was known a class of long and irregular odes greatly in fashion in England during the class

of the 17th and the beginning of the 18th century. The invention is due to Abraham Cowley, who, probably in Paris—"a place where he had no other books to direct him"—and perhaps in 1650, found a text of Pindar and determined to imitate the Greek poetry in English, without having comprehended the system upon which Pindar's prosody was built up. Cowley published, however, in 1656, fifteen *Pindarique Odes*, which became the model on which countless imitators founded their pindarics. The erroneous form of these poems, which were absolutely without discipline of structure, was first exposed by Congreve, exactly half a century later, he very justly describing them as "bundles of rambling incoherent thoughts, expressed in a like parcel of irregular stanzas, which also consist of such another complication of disproportioned, uncertain and perplexed verses and rhymes." This is harsh, but it describes a pindaric with absolute justice. Cowley had not been aware that "there is nothing more regular than the *Odes* of Pindar," and that his poems were constructed in harmony with rigid prosodical laws in strophe, antistrophe and epode; "the liberty which Pindar took in his numbers, which has been so much misunderstood and misapplied by his pretended imitators, was only in varying the stanzas in different odes, but in each particular ode they are ever correspondent one to another in their turns, and according to the order of the ode." These excellent critical remarks were made by Congreve in his *Discourse on the Pindarique Ode* of 1706, and from that date forward the use of pindarics ceased to be so lax and frantic as it had been during the previous fifty years. The time had now passed in which such a critic as Sprat could praise "this loose and unconfined measure" as having "all the grace and harmony of the most confined." It began to be felt that the English pindaric was a blunder founded upon a misconception. If we examine Cowley's "Resurrection," which was considered in the 17th century to be a model of the style, and "truly pindarical," we find it to be a shapeless poem of 64 lines, arbitrarily divided, not into strophes, but into four stanzas of unequal volume and structure, the lines which form these stanzas are of lengths varying from three feet to seven feet, with rhymes repeated in wilful disorder, the whole forming a mere vague caricature of Pindar's brilliant odes. The very laxity of these pindarics attracted the poets of the unlyrical close of the 17th century, and they served the purpose not only of Dryden and Pope, but of a score of lesser poets, among whom Oldham, Mrs Behn, Otway, Sprat, Flatman and many others were prominent. The pindaric became the almost necessary form in which to indite a poem of compliment on a birth, a wedding or a funeral. Although the vogue of these forms hardly survived the age of Anne, something of the vicious tradition of them still remained, and even in the odes of Wordsworth, Shelley and Coleridge the broken versification of Cowley's pindarics occasionally survives. Tennyson's *Ode on the Death of the Duke of Wellington* (1852) is the latest important specimen of a pindaric in English literature. (E. G.)

PINDARIS, a word of uncertain origin, applied to the irregular horsemen who accompanied the Mahratta armies in India during the 18th century when the Mughal Empire was breaking up; loosely organized under self-chosen leaders, each band was usually attached to one or other of the great Mahratta chieftains. Their special characteristic was that they received no pay, but rather purchased the privilege of plundering on their own account. The majority of them seem to have been Mahomedans: when the regular forces of the Mahrattas had been broken up in the campaigns conducted by Sir Arthur Wellesley and Lord Lake in 1802-04, the Pindaris made their headquarters in Malwa, under the tacit protection of Sindhia and Holkar. They were accustomed to assemble every year at the beginning of November, and sally forth into British territory in search of plunder. In one such raid upon the Masulipatam coast they plundered 339 villages, killing or wounding 682 persons, torturing 3600 and carrying off property worth a quarter of a million. In 1808-09 they plundered Gujarat, and in 1812 Mirzapur. In 1814 they were reckoned at 25,000 to 30,000 horsemen, half of them well armed. At last the evil became intolerable, and in

1817 the marquis of Hastings obtained the consent of the East India Company to the organized campaign, known as the Pindari War. The Pindaris were surrounded on all sides by a great army, consisting of 120,000 men and 300 guns, which converged upon them from Bengal, the Deccan and Gujarat under the supreme command of Lord Hastings in person. Sindhia was overawed and forced to sign the treaty of Gwalior, consenting to aid in the extirpation of the Pindaris, whom he had hitherto protected. The Peshwa at Poona, the Bhonsla raja at Nagpur and the army of the infant Holkar each took up arms, but were separately defeated. The Pindaris themselves offered little opposition. Amir Khan, by far their most powerful leader, accepted the conditions offered to him, and his descendant is now Nawab of the state of Tonk in Rajputana. The rest surrendered or were hunted down, the fate of Chitu, one of the most notorious, being to perish in a tiger's den. These military operations were followed by the pacification of Central India under the administration of Sir John Malcolm.

See J. Grant Duff, *History of the Mahrattas* (1826); and Major Ross of Bladensburg, *Marquess of Hastings* (Rulers of India Series) (1893).

PIND DADAN KHAM, a town of British India, in the Jhelum district of the Punjab, situated near the right bank of the river Jhelum, on the Sind-Sagar branch of the North-Western railway. Pop. (1901), 13,770. It is an important centre of trade, and its manufactures include boats, brass-ware, pottery, embroidered scarves and riding-whips.

PINDUS, the ancient name of the rugged group of mountains which separates Thessaly from Epirus, and branches south in various directions. The geographical name is sometimes extended over all these branches, and so reaches from Aetolia to the Gulf of Lamia. The northern part of the ridge was known as Lacmon. There is no modern name covering the whole range, but its different parts have separate names. Several of them attain a height of 7000 ft. or more.

PINE (Lat. *Pinus*, Gr. *πινος*), a name given by the ancients to some of the resinous cone-bearing trees to which it is now applied, and, as limited by modern botanists, the designation of a large genus of true conifers, differing from the firs in their hard woody cone-scales being thickened at the apex, and in their slender needle-shaped leaves growing from a membranous sheath, either in pairs or from three to five together—each tuft representing an abortive branch, springing from the axil of a partially deciduous scale-leaf, the base of which remains closely adherent to the stem. The numerous male catkins are generally arranged in dense whorls around the bases of the young shoots; the anther-scales, surmounted by a crest-like appendage, shed their abundant pollen by longitudinal slits; the two ovules at the base of the inner side of each fertile cone-scale develop into a pair of winged seeds, which drop from the opening scales when mature—as in the allied genera.

The pines are widely distributed over the north temperate zone, in the southern portions chiefly confined to the mountains, along which, in Central America, a few are found within the tropic; in more northern regions they frequently form extensive forests, sometimes hardly mingled with other trees. Their soft, straight-grained, resinous and often durable wood gives to many kinds a high economic value, and some are among the most esteemed of timber trees.

Of the two-leaved species, *P. sylvestris*, the pine of northern Europe, may be taken as a type. When growing in perfection it is one of the finest of the group, and perhaps the most picturesque of forest trees; attaining a height of from 70 to 120 ft., it is of conical growth when young, but in maturity acquires a spreading cedar or mushroom-like top, with a straight trunk of from 2 to 4 ft. in diameter at the base, and gnarled twisted boughs, densely clothed at the extremities with glaucous green foliage, which contrasts strongly with the fiery red-brown bark. The leaves are rather short, curved, and often twisted; the male catkins, in dense cylindrical whorls, fill the air of the forest with their sulphur-like pollen in May or June, and fecundate the purple female flowers, which, at first sessile and erect, then

become recurved on a lengthening stalk; the ovate cones, about the length of the leaves, do not reach maturity until the autumn of the following year, and the seeds are seldom scattered until the third spring; the cone-scales terminate in a pyramidal



FIG. 1.—Scotch Fir (*Pinus sylvestris*).
a, Male flower and young cones; b, male catkin; c, d, outer and inner side of anther-scale.

recurved point, well marked in the green state and in some varieties in the mature cone, but in others scarcely projecting. *P. sylvestris* is found, in greater or less abundance, from the hills of Finmark and the plains of Bothnia to the mountains of Spain and even the higher forest-slopes of Etna, while in longitude its range extends from the shores of the North Sea to Kamchatka. Nowhere more abundant than in the Scandinavian peninsula, this tree is the true fir (*fur, fura*) of the old Norsemen, and still retains the name among their descendants in Britain, though botanically now classed as a pine. It grows vigorously in Lapland on the lower ground, and is found even at an elevation of 700 ft., while in south Norway it occurs up to 3000 ft., though the great forests from which "Norway pine" timber is chiefly derived are on the comparatively lower slopes of the south-eastern dales: in the highest situations it dwindles to a mere bush. It furnishes the yellow deal of the Baltic and Norway. In Germany, both on the mountains and the sandy plains, woods of "kiefer" are frequent and widely spread, while vast forests in Russia and Poland are chiefly composed of this species; in many northern habitats it is associated with the spruce and birch. In Asia it abounds in Siberia and on the mountains of the Amur region; on the European Alps it occurs at a height of 5600 ft., and on the Pyrenees it is found at still higher elevations; on the northern side of Etna it is said to grow at above 7000 ft. In Britain natural forests of Scotch fir of any extent are only now found in the Highlands, chiefly on the declivities of the Grampians. In former ages the tree covered a large portion of the more northern part of the island, as well as of Ireland; the numerous trunks found everywhere in the mosses and peat-bogs

of the northern counties of England attest its abundance there in prehistoric times; and in the remoter post-Glacial epoch its range was probably vastly more extended. The tree is not at present indigenous in southern Britain, but when planted in suitable ground multiplies rapidly by the wind-sown seeds; on many of the sandy moors and commons natural pine woods of large extent have been thus formed during the last fifty years. The Scotch fir is a very variable tree, and certain varieties have acquired a higher reputation for the qualities of their timber than others, among those most prized by foresters is the one called the Braemar pine, the remaining fragments of the great wood in the Braemar district being chiefly composed of this kind; it is mainly distinguished by its shorter and more glaucous leaves and ovoid cones with blunt recurved spines, and especially by the early horizontal growth of its ultimately drooping boughs, of all varieties this is the most picturesque. On the European continent the Hagenau pine of Westphalia is esteemed for the straightness and good quality of its timber. The heart-wood of the finer kinds of Scotch fir is of a deep brownish-red colour, abounding in the resin to which its durability is probably due. For all indoor and most outdoor purposes it is as lasting as oak, and for ship planking is perhaps little inferior; from its lightness and elasticity it is well adapted for the construction of yachts and other small fast-sailing craft, and is said to be the best of all wood for masts and large spars; its weight varies from 30 to 40 lb the cubic foot. The sap-wood is more perishable, but it is useful for fences, casks and a variety of other purposes; soaking in lime-water renders it more lasting; great numbers of young pines are annually cut for railway sleepers, mining timber and numerous agricultural applications; large quantities are consumed for road-pavement. The quality of the timber

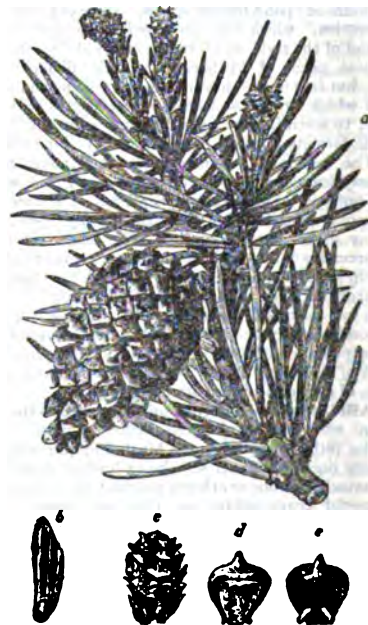

FIG. 2.—Scotch Fir (*Pinus sylvestris*).
a, Fertile flower of mature cone; b, winged seed; c, fertile catkin (or cone); d, scale and bract; e, inner side of scale.

depends greatly on the soil and position in which the trees are grown: the dry slopes of granitic or gneissic mountains, or the deep well-drained sandy gravels of the lower country seems to answer equally well; but on clay or wet peat the tree rarely

flourishes, and the timber is always indifferent; it is usually said that the wood is best in the cold climate of its more northern habitats, but a trunk (4 ft. in diameter) grown on the sands of Surrey had heart-wood quite equal to any produced in Glenmore or Rothiemurchus. The rapidity of growth is still more variable: in Britain full maturity is attained in from seventy to one hundred and twenty years, but in Norway the trunk increases much more slowly; Schübler states that a tree felled in the Alten district (about 70° lat.), measuring 2 ft. 10 in. in diameter without the bark, showed four hundred circles of annual growth. In Norway the tree, growing in dense forests, is generally of but moderate girth, and probably this pine nowhere reaches a greater size than in the Scottish woods; a plank from Glenmore forest measured nearly 5½ ft. across, and from 3 to 4½ ft. is not an unusual diameter for a British pine tree.

Vast numbers of Scotch firs are raised in nurseries for artificial planting; the seed is sown in the spring, being just covered with earth, and the seedlings transplanted in the second year into rows for further culture, or taken direct from the seed-bed for final planting; sometimes the seed is sown where the trees are intended to grow. A plantation of Scotch fir requires frequent and careful thinning as the young trees increase in size; but pruning should be avoided as much as possible, excepting for the removal of dead wood. Plantations in England are generally ready for final cutting in from sixty to seventy years, and many are cleared at a much earlier stage of growth. *P. sylvestris* in Britain is liable to many insect depredations: the pine-chafer, *Hylyrus piniperda*, is destructive in some places, the larva of this beetle feeding on the young succulent shoots, especially in young plantations; *Hylobius abietis*, the fir-weevil, eats away the bark, and numerous lepidopterous larvae devour the leaves; the pine-sawfly is also injurious in some seasons; the removal of all dead branches from the trees and from the ground beneath them is recommended, as most of these insects lay their eggs among the decaying bark and dead leaves. In common with other pines, *P. sylvestris* is subject to the attacks of various fungi. *Trametes radiciperda* attacks the roots and penetrates to the stem, causing rotting of the wood; the disease is difficult to eradicate, as the mycelium of the fungus travels from root to root in the soil. Rotting of the wood at the base of the trunk is also caused by *Agaricus melleus*, which spreads from root to root in the soil by means of its long purple-black, cord-like mycelial strands known as *Rhizomorpha*. Much damage is often caused by species of *Peridermium*, which often invade the cortex and cambium to such an extent as to "ring" the stem or branch, or to cause an abnormal formation of turpentine which soaks into the wood and stops the upward passage of water; this causes the parts above the diseased area to perish. In England the pine is largely employed as a "nurse" for oak trees, its conical growth when young admirably adapting it for this purpose; its dense foliage renders it valuable as a shelter tree for protecting land from the wind; it stands the sea gales better than most conifers, but will not flourish on the shore like some other species.

The pine is an important tree in the economy of the northern nations of Europe. In Scandinavia and Russia houses are chiefly constructed of its timber; and log-huts are made of the smaller trunks and lined and roofed with the bark. The inner bark is twisted into ropes, and, like that of the spruce, is kiln dried, ground up, and mixed with meal in times of scarcity; in Kamchatka it is macerated in water, then pounded, and made into a kind of substitute for bread without any admixture of flour. In recent days the fibre of the leaves has been extracted in some quantity and applied to textile purposes under the name of *waldwolle*, both in Germany and Sweden. It is prepared by boiling the needles in a solution of soda to remove the resin, which process loosens the fibre and renders its separation easy; it has some resemblance to coarse wool, and is spun and woven into blankets and garments that are said to be warm and durable; it is also used for stuffing cushions; an essential oil, obtained by a previous distillation of the leaves, has medicinal virtues attributed to it by some German practitioners.

Large quantities of turpentine are extracted from this pine in Sweden and Russia by removing a strip of bark, terminating below in a deep notch cut in the wood, into which the turpentine runs, and from which it is scooped as it accumulates; but the product is not equal to that of the silver fir and other species. Tar is prepared largely from *P. sylvestris*; it is chiefly obtained from the roots, which, mingled with a few logs, are arranged in a conical or funnel-shaped hollow made on the steep side of a hill or bank; after filling up, the whole is covered with turf and fired at the top, when the tar exudes slowly and runs into an iron vessel placed below, from the spout of which it is conveyed into barrels. Most of the so-called Stockholm tar is thus prepared, chiefly in the province of Bothnia.

Closely allied to the Scotch pine, and perhaps to be regarded as a mere alpine form of that species, is the dwarf *P. montana* (or *P. Pumilio*), the "krummholz" or "knieholz" of the Germans—a recumbent bush, generally only a few feet high, but with long zigzag stems, that root occasionally at the knee-like bends where they rest upon the ground. The foliage much resembles that of the Scotch fir, but is shorter, denser and more rigid; the cones are smaller but similar in form. Abounding on the higher slopes of the Bavarian and Tyrolean Alps, it is a favourite shelter for the chamois; the hunters call it the "latschen," from its recumbent straggling habit. Krummholz oil, valued in Germany as an outward application in rheumatism and for bruises and sprains, is distilled from the young branches, and a fragrant white resin that exudes in some quantity from the buds is used for similar purposes and as a perfume, under the name of Hungarian balsam it is sold in the towns of Germany, being probably obtained from the Carpathians.

The red pine of Canada and New England (so called from the colour of its bark), *P. resinosa*, is a tree of considerable size, sometimes attaining the dimensions of *P. sylvestris*. The somewhat glaucous leaves form dense tufts at the ends of the branches, and are 4 or 5 in. long; the ovate blunt cones are about half that length. The tree is of quick growth and the wood strong and resinous, but it is less durable than Scotch fir, though much employed in ship-building; according to Emerson, trunks exist in Maine 4 ft. in diameter. A sandy soil seems to suit it best, and the quality of the wood probably much depends on its place of growth. Red pines abound in Nova Scotia and Newfoundland, and the tree is rather widely distributed over the northern parts of the continent; it rarely forms extensive woods, but grows chiefly in clumps among other trees, at least in its more southern habitats. Nearly allied is *P. Banksiana*, the grey or Labrador pine, sometimes called the scrub pine from its dwarfish habit; it is the most northerly representative of the genus in America, and is chiefly remarkable for its much recurved and twisted cones, about 2 in. long. The trunks are too small to be of great economic value, but the light wood is used by the natives for their canoes.

P. Laricio, the Corsican pine, is one of the noblest trees of this group, growing to a height of 100 or even 150 ft., with a straight trunk and branches in regular whorls, forming in large trees a pyramidal head; the slender leaves, of a dark green tint, are from 4 to 7 in. long; the cones, either in pairs or several together, project horizontally, and are of a light brown colour. This pine abounds in Corsica, and is found in more or less abundance in Spain, southern France, Greece, and many Mediterranean countries; it occurs on the higher mountains of Cyprus. The tree is of very rapid growth, but produces good timber, much used in southern dockyards, and very durable, though less strong than that of *P. sylvestris*; the heart-wood is of a brownish-tint. In southern France it has been planted with success on the drift-sands of the Bay of Biscay, though it does not bear the full force of the sea-blast as well as the pinaster. In England it grows well in sheltered situations and well-drained soils.

The black pine, *P. austriaca*, generally now regarded as a variety of *P. Laricio*, derives its name from the extreme depth of its foliage tints—the sharp, rigid, rather long leaves of a dark green hue giving a sombre aspect to the tree. The light-coloured, glossy, horizontal cones are generally in pairs, but sometimes three or four together. The tree is conical when young, but when old forms a spreading head; it often attains a large size. Southern Austria and the adjacent countries are the natural habitats of this pine; it seems to flourish best on rocky mountain sides, but in England grows well on sandy soils. The timber is valued in its native country, and is said to be durable and to stand exposure to the weather well; various resinous products are extracted from it. *P. pyrenaica* is a handsome species of pyramidal form, attaining a large size on the mountains of northern Spain, whence it extends through the Mediterranean region to Asia Minor, northern Persia and Afghanistan. The leaves are long and of a light bright green; the cones are solitary, oblong, conical and of a yellow tint. The timber is used in Spanish dockyards, but opinions vary as to its quality. In plantations its bright foliage, with the orange cones and young shoots, render it an ornamental tree, hardy in southern Britain. *P. brutia*, the Calabrian pine, is regarded as the same

species. *P. halepensis*, another Mediterranean form, is valued for its timber, which is white with a fine grain, and resinous products.

P. pinaster, the cluster pine or pinaster, is an important species from its vigorous growth in the sand-drifts of the coast, for the purpose of binding which it has been grown more extensively and successfully than any other tree, especially on the dunes of the Bay of Biscay. Growing to a height of from 40 to 80 ft., the deeply-furrowed trunk occasionally reaches a diameter of 3 ft. or more at the base, where, like most sand trees, it usually curves upward gradually, a form that enables the long tap-roots to withstand better the strain of the sea gale; when once established, the tree is rarely overthrown even on the loosest sand. The branches curve upwards like the stem, with their thick covering of long dark green leaves, giving a massive rounded outline to the tree; the ovate cones are from 4 to 6 in. long, of a light shining brown hue, with thick scales terminating in a pyramidal apex; they are arranged around the branches in the radiating clusters that give name to the tree. The pinaster grows naturally on sandy soils around the Mediterranean from Spain to the Levant. On the drift-sands of France, especially in the Gironde, forests have been formed mainly of this pine; the seeds, sown at first under proper shelter and protected by a thick growth of broom sown simultaneously, vegetate rapidly in the sea-sand, and the trees thus raised have, by their wind-drifted seed, covered much of the former desert of the Landes with an evergreen wood. These forests of pinaster, apart from the production of timber in a once treeless district, have a great economic value as a source of turpentine, which is largely obtained from the trees by a process analogous to that employed in its collection from *P. sylvestris*; the resin is yielded from May to the end of September, the cuts being renewed as the supply fails, until the tree is exhausted; the trunks are then felled and used in the manufacture of charcoal and lamp black; much tar and pitch is also obtained from these pinaster forests. In England the cluster-pine has been largely planted on sandy districts near the sea, and has become naturalized in Purbeck and other wild tracts in the southern counties, but the summer heat is too small to permit of its resinous products acquiring any value; the soft coarse wood, though perishable in the natural state, has been used for railway sleepers after saturation with creosote or preservative solutions.

P. pinea is the stone pine of Italy; its spreading rounded canopy of light green foliage, supported on a tall and often branchless trunk, forms a striking feature of the landscape in that country, as well as in some other Mediterranean lands. The beautiful reddish-brown shining cones, roundly ovate in shape, with pyramidal scale apices, have been prized from the ancient days of Rome for their edible nut-like seeds, which are still used as an article of food or dessert. They do not ripen until the fourth year, and are kept in the cone until required, as their abundant oil soon turns rancid. The tree has been naturalized in many warm countries, even in China; in England it seldom attains any large size, as the deficient summer heat prevents the wood from maturing; but trees occur occasionally in plantations 20 or 30 ft. in height; the wood, though soft and deficient in the resin that gives durability to the timber of some species, is valued by the southern carpenter and cabinetmaker for its lightness, its fineness of grain, and the ease with which it is worked.

P. mitis, the yellow pine of the northern and middle states of America, is rather allied to the three-leaved section, but the leaves are mostly in pairs. It is a tree of large size, often attaining a height of 70 ft. and upwards, though rarely more than 2 ft. in diameter at the root; the lower branches spread horizontally, the upper, converging towards the trunk, give the tree somewhat the aspect of a spruce, hence it is called in some districts the "spruce-pine." The leaves are long, slender, and of a bluish-green hue; the pendant cones are about 1½ in. long, with a slender point to each scale. The yellow pine is one of the most important timber trees of the genus; the heart-wood being very durable is largely employed in ship-building and for house timber, being nearly equal to that of *P. sylvestris*; large quantities are exported to Britain under the name of "New York yellow pine"; the sapwood is perishable.

The three-leaved group includes several of the most valuable trees of America; among them is *P. rigida*, the pitch pine of the northern states, a tree of from 40 to 50 ft. in height with rugged trunk, occasionally 3 ft. in diameter; the short dark-green leaves are in thick tufts, contrasting with the pale yellowish, usually clustered cones, the scales of which are furnished with small curved spines. The wood is very hard and abounds with resin, but on swampy land is of inferior quality and of little value except for fuel, for which the pitch-pine is highly prized; on drier ground the grain is fine from the numerous knots. Large quantities of tar and pitch are obtained from this species. The tree is one of the few that will flourish in salt-marshes.

P. palustris (or *P. australis*) is the "Georgia pitch pine," or yellow pine of the southern states; it abounds on the sandy soils that cover so much of Georgia, the Carolinas, and Florida, and on those dry lands attains its highest perfection, though occasionally abundant on moist ground, whence its name. The most marked feature of the tree is its long tufted foliage—the leaves, of a bright

green tint, springing from long white sheaths, being often a foot in length. The tall columnar trunk furnishes the most valued pine timber of the states; close-grained and resinous, it is very durable and polishes well; it is largely employed in American shipyards, and immense quantities are exported, especially to Britain and the West Indies. This tree yields an abundant supply of tar and turpentine of good quality, which products are collected and manufactured in the "pine-barrens" on a large scale.

P. taeda, the "loblolly pine" of the backwoodsman, a tall tree with straight trunk and spreading top, covers great tracts of the "pine-barrens" of the southern states, but also frequently spreads over deserted arable lands that have been impoverished by long and bad farming; hence the woodmen call it the "old-field" pine, while, from the fragrance of its abundant resin, it is also known as the frankincense pine. It is a fine species 80 or 90 ft. high, having sometimes a girth of 6 or 8 ft., with a broad spreading head; the leaves are rather long and of a light green tint, the cones generally in pairs, the scales terminating in a sharp incurved prickle. The timber of this pine is indifferent, but the forests of it are of importance from the quantity of turpentine they yield; the trees also furnish much firewood of good quality.

P. ponderosa, the yellow pine of the Pacific coast of America, belongs to this section; it is a fine timber tree deserving of notice from the extreme density of its wood, which barely floats in water; it abounds in some parts of the western range of the Rocky Mountains, and is the most widely distributed pine tree of the mountain forests of western North America. The leaves are very long and twisted, the small ovate cones armed with recurved prickles; the tree is said to be of rapid growth. In Oregon and California several large pines of this group are found. *P. Coulteri* or *macrocarpa*, is remarkable for its enormous cones (sometimes a foot long, 6 in. in diameter, and weighing more than 4 lb.); the scales end in long hooked points curving upwards; the leaves are long, rigid, and glaucous in hue. Nearly related to this is *P. Sabiana*, the nut-pine of California, the cones of which are 7 to 9 in. long and 5 to 6 in. in diameter, also with hooked scales; the large nut-like seeds are eaten by the Indians; the tree is one of the largest of the section, sometimes attaining a height of 120 ft. and upwards, while trunks have been found, it is said, 10 or 12 ft. in diameter.

P. longifolia, a Himalayan species, is remarkable for the great length of its lax slender leaves, of a grass-green tint; the cones have the points of the scales recurved. It is known in India as the "cheer pine"; the wood is good, resinous, and moderately durable; the tree is common on the foot-hills of the Himalayas. *P. Gerardiana*, a north-west Himalayan species, is a medium-sized tree with a conical head, growing on the more elevated parts of the mountain range; it furnishes edible seeds. The leaves, short and glaucous, like those of the Scotch fir, have deciduous sheaths; the cones have recurved scale-points like those of the cheer pine. *P. casuarinensis*, which forms forests on the mountains of Grand Canary and Tenerife, growing at an elevation of 6000 ft., also belongs to this group. The leaves are long, lax, and of a bright green tint; the cone-scales are without spines; the trunk attains a large size, and yields good and durable timber. The beautiful Monterey pine, *P. insignis*, distinguished by the brilliant colour of its foliage, has the leaves in tufts of three or four; the lower cone-scales have recurved points. This fine pine has been planted in the south-west of England, but is scarcely hardy.

The pines with five leaves in each tuft have generally deciduous sheaths. The most important economic species is the well-known white pine, *P. strobus*, from its large growth and abundance, as well as the soft even grain of its white wood, one of the most valuable of North American timber trees. The tree abounds from Canada to Georgia, but in the eastern states has been so long sought for by the lumberer that most of the old trees have long disappeared, and large white pine timber is now only found in quantity in the Canadian Dominion. Formerly Maine and Vermont were celebrated for the size of their pines, but few of these great trees now exist in New England. On a deep rich soil *P. strobus* attains a height of 120 ft., and trunks without a branch are sometimes found 20 or 30 ft. long; in the earlier stages of growth it has a pyramidal form, in open glades the lower boughs often touching the ground, but in old age it acquires a wide almost cedar-like top. The light bluish-green foliage is somewhat lax, very dense in young trees; the cones are long and rather curved, with thin smooth scales a little thickened at the apex, and generally more or less covered with exuding white resin; they are about 5 or 6 in. in length and 1½ to 2 in. broad; the male catkins are of a bluish tint; the cones ripen in the autumn of the second year. The wood of the white pine is durable for indoor use, especially when protected by paint, but when exposed to moist air it rapidly decays, and it is very liable to dry rot; it is said to be best when grown on sandy soils. Immense quantities are still exported, especially from Canada, its smooth easily-worked grain rendering it a favourite wood for the house-carpenter and joiner; it weighs about 28 lb per cubic foot. In England where it is generally known as the "Weymouth pine," it succeeds well on deep light soils when well-drained; trees have attained occasionally a height of 100 ft. and upwards in British plantations; but it is apt to be infested with American blight (*Eriosema*). In northern Germany it also grows well. The climate of Scotland

PINE



Scotch Fir (*Pinus sylvestris*).
A, Cone, seed and needles.

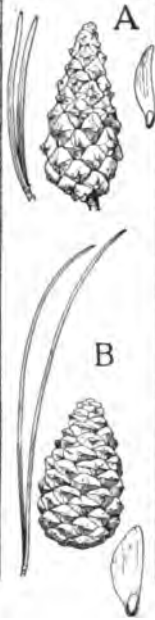

Corsican Pine (*Pinus Laricio*)
B, Cone, seed and needles.



Cluster Pine (*Pinus Pinaster*).
C, Cone, needle and seed.



Stone Pine (*Pinus Pinea*).
D, Cone and seed.

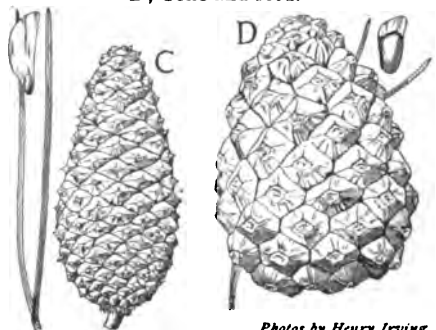

Photos by Henry Irving.

PINE

Other
Conifers



Weymouth Pine
(*Pinus Strobus*).

A, Cone, needles and seed.

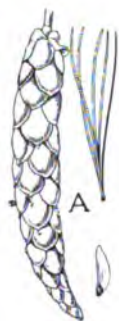

Larch (*Larix europaea*).
B, Cone and foliage.

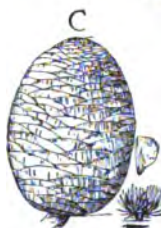

Cedar of Lebanon (*Cedrus Libani*).
C, Cone, foliage and seed.



Deodar (*Cedrus Deodara*).

Photos by Henry Irving.

appears less suitable for it, probably from the want of summer heat, and it can hardly be recommended for British planting otherwise than for ornamental purposes.

Nearly approaching this is *P. excelsa*, the Bhotan pine, which differs chiefly in its longer cones and drooping glaucous foliage. It is found in Kumaon and Bhotan and on some of the Nepal ranges, but does not grow in the moist climate of the Sikkim Himalayas; it is found at a height of 7000 to 12,000 ft., and attains large dimensions; the wood is highly resinous, and is said to be durable; great quantities of a white clear turpentine exude from the branches when injured. The Bhotan pine is quite hardy in southern England, and has been largely planted of late as an ornamental tree.

P. Lambertiana, the giant pine or sugar pine of California, is the largest of the genus, rising to the height of 200 ft., with a trunk 20 to 30 ft. in girth, and, it is said, occasionally attaining much larger dimensions. The head is of a pyramidal form, the lower branches drooping like those of a Norway spruce, its foliage is of a light bright green colour. The pendant cones are very large, sometimes 18 in. long and 4 in. in diameter, with large nut-like seeds, which, pounded and baked, are eaten by the Indians. The tree abounds in some sandy districts, but more generally occurs singly or in small groups dispersed through the woods, attaining its greatest dimensions in light soils. The wood is soft and nearly white, but contains much resin, which when fire has run through the forest exudes, and, having in this half-burnt condition a sweetish taste, has given the common name to the tree; the wood seems to be formed slowly; from its smooth grain it is valued for indoor carpentry; the saccharine burnt resin is used as a laxative in California.

P. Cembra is the stone pine of Siberia and central Europe. It abounds on the Alps, the Carpathians and the Siberian ranges, in Switzerland being found at an altitude of 4000 to 6000 ft. It is a straight-growing tree, with grey bark and whorls of horizontal branches giving a cylindro-conical outline; the leaves are short, rigid and glaucous; the cones, oblong and rather pointing upwards, grow only near the top of the tree, and ripen in the second autumn; the seeds are oily like those of *P. Pinea*, and are eaten both on the Alps and by the inhabitants of Siberia; a fine oil is expressed from them which is used both for food and in lamps, but, like that of the Italian pine, it soon turns rancid. The growth of *P. Cembra* is slow, but the wood is of remarkably even grain, and is employed by the Swiss wood-carvers in preference to any other. The *Cembra* is the "zirbel" or "zirbel-kiefler" of the Germans, and is known locally in Switzerland as the "arole," "aloies," and "arve."

P. occidentalis, a five-leaved pine with pale-green foliage and small ovate cones, is found on the high mountains of Santo Domingo and Cuba. Many members of the group occur on the Mexican isthmus, one of which *P. cembroides*, produces edible seeds; another, *P. Montezumae*, is a valuable timber tree. *P. Ayacahuite*, the common white pine of Mexico, spreads southwards on to the mountains of Guatemala, it is a large tree with glaucous foliage like *P. Strobus*, and yields a valuable resin. *P. hispidula* and *P. macrophylla*, likewise natives of Central America, are remarkable for the extreme length of their leaves; the former is said to attain a large size.

(C. P. J.)

PINE-APPLE. The pine-apple so called consists in reality of the inflorescence of the plant, the originally separate flowers of which, together with the bracts supporting them, become fleshy and consolidated into one mass. The swelling and fusion of the tissues take place after the process of fertilization, and it may be that the richly perfumed succulent mass is an aid in the distribution of seed by affording food to certain animals. In the highly developed cultivated pines, however, it frequently happens that the seeds do not ripen properly. The pine, *Ananas sativus*, is a member of the natural order Bromeliaceae, of tropical American origin, where it is widely spread; and it is now naturalized in the tropical regions of the Old World.

Evelyn in his *Diary* mentions tasting a pine-apple from Barbados at the table of Charles II., and this is we believe the first mention of the fruit in English literature. A picture, of which a copy may be seen at the rooms of the Royal Horticultural Society of London, represents the royal gardener, Mr Rose, presenting on bended knee the first pine-apple grown in Britain, and it is surmised that this may have been grown from the "suckers" of the fruit above alluded to by Evelyn, though it is generally considered that the pine was not cultivated in England till 1712. For many years pine-apples were cultivated in large private gardens, but owing to the great developments in culture in the West Indies, the Azores, Canary Islands, &c., they are no longer cultivated in Britain or Europe.

PINE BLUFF, a city and the county-seat of Jefferson county, Arkansas, U.S.A., situated at an altitude of about 200 ft. in the alluvial bottoms of the Arkansas river, about 107 m. from its

mouth, and about 42 m. S. by E. of Little Rock. Pop (1890); 15,102. It has an active river trade with St Louis, Memphis and New Orleans, and five railway outlets—the Missouri Pacific and its branch, the Pine Bluff & Western, and the St Louis South-Western and its two branches, the Pine Bluff & Arkansas River and the Altheimer. The city has many schools, and a business college, the state normal school for negroes, and Merrill institute, endowed by Joseph Merrill of Pine Bluff with \$700,000. Large quantities of cotton and lumber are shipped from the city. Among the manufactures are cotton-seed oil, lumber and staves, and furniture. Pine Bluff has shops of the St Louis South-Western railway. The city's factory products were valued at \$2,989,242 in 1905, an increase of 94% over their value in 1900. Pine Bluff was laid out in 1832 and chartered as a city in 1885.

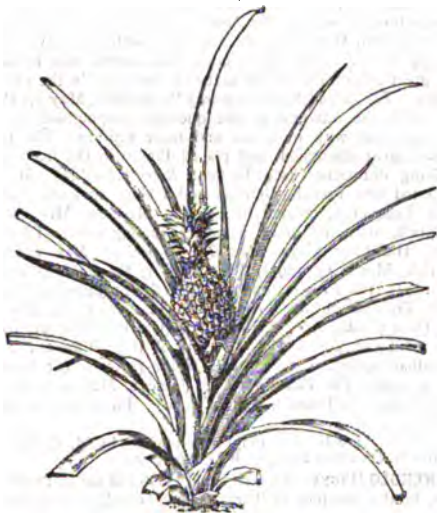

Pine-apple (*Ananas sativus*) much reduced.

PINEL, PHILIPPE (1745-1826), French physician, was born at the château of Rascas, Saint-André, in the department of Tarn, France, on the 20th of April 1745. He studied at Lavaur and afterwards at the university of Toulouse, where he took his doctor's degree in 1773. From Montpellier he removed in 1778 to Paris, engaging there chiefly in literary work connected with his profession. His first publication was a French translation of William Cullen's *Nosologie* (1785); it was followed by an edition of the works of G. Baglivi (1788), and in 1791 he published a *Traité medico-philosophique de l'aliénation mentale*. In 1792 he became head physician of the Bicêtre, and two years afterwards he received the corresponding appointment at the Salpêtrière, where he began to deliver a course of clinical lectures; these formed the basis of his *Nosographie philosophique* (1798; 6th ed., 1818), which was further developed in *La Médecine clinique* (1802). Pinel was made a member of the Institute in 1803, and soon afterwards was appointed professor of pathology in the École de Médecine. His fame rests entirely upon the fact that he was among the first to introduce the humane treatment of the insane. He died at Paris on the 26th of October 1826.

PINERO, SIR ARTHUR WING (1855-), English dramatist, was born in London on the 24th of May 1855, the son of John Daniel Pinero, a Jewish solicitor, whose family was of Portuguese origin, long established in London. A. W. Pinero was engaged in 1874 as an actor at the Theatre Royal, Edinburgh, and came to London in 1876, to play at the Globe Theatre. Later in the year he joined the Lyceum company, of which he remained a member for five years. The first piece of his to see the footlights

was *£800 a year*, played in October 1877 at the Globe Theatre for the benefit of Mr F. H. Macklin. The first play to make a hit was *The Money Spinner* (Theatre Royal, Manchester, Nov. 1880), but in *The Squire* (St James's Theatre, Dec. 1881) he attempted serious drama, and gave promise of the qualities of his later work. In 1883 and 1884 Pinero produced seven pieces, but the most important of his works at this period were the successful farces produced at the Court Theatre: *The Magistrate* (March 1885), which ran for more than a year; *The Schoolmistress* (March 1886), *Dandy Dick* (Jan. 1887), revived in February 1900; *The Cabinet Minister* (April 1890), and *The Amazons* (March 1893). Two comedies of sentiment, *Sweet Lovender* (Terry's, March 1888) and *The Weaker Sex* (Theatre Royal, Manchester, Sept. 1888), met with success, and *Sweet Lovender* has enjoyed numerous revivals. With *The Profligate* (Garrick, April 1889) he returned to the serious drama which he had already touched on in *The Squire*. Out of deference to the wishes of John Hare the play was fitted with the conventional "happy ending," but the original dénouement was restored, with great advantage to the unity of the play, in the printed version. *The Second Mrs Tanqueray* (St James's, May 27, 1893) dealt with the converse of the question propounded in *The Profligate*, but with more art and more courage. The piece aroused great discussion, and placed Pinero in the front rank of living dramatists (see DRAMA: *Recent English*). It was translated into French, German and Italian, and the part of Paula Tanqueray, created in the first place by Mrs Patrick Campbell, attracted many actresses, among others Eleonora Duse. His later plays were *The Notorious Mrs Ebbsmith* (Garrick, March 13, 1895), *The Benefit of the Doubt* (Comedy, Oct. 1895), *The Princess and the Butterfly* (St James's, April 7, 1897), *Trelawney of the Wells* (Court, Jan. 30, 1898), *The Gay Lord Quex* (Globe, April 8, 1899), *Iris* (Garrick, Sept. 21, 1901), *Letty* (Duke of York's, Oct. 8, 1903), *A Wife Without a Smile* (Wyndham's, Oct. 9, 1904), *His House in Order* (St James's, Feb. 1, 1906), *The Thunderbolt* (St James's, May 9, 1908) and *Mid-Channel* (St James's, Sept. 2, 1909). Pinero was knighted in 1909.

His *Plays* (11 vols. 1891-1895) have prefaces by M. C. Salaman. See also H. Hamilton Fyfe, *A. W. Pinero* (1902).

PINEROLO [PINEROL], a city and episcopal see of Piedmont, Italy, in the province of Turin. Pop. (1901), 12,608 (town), 18,039 (commune). It is built on a hill-side just above the valleys of the Chisone and the Lemina, at a height of 1234 ft. above the sea, 24 m. by rail S.W. of Turin. The railway goes on to Torre Pellice; and steam tramways run from Pinero to Perosa, and to Cavour and Saluzzo. Till 1696 it was strongly fortified with a citadel on Santa Brigida, a castle on S. Maurizio, and city walls constructed by Thomas I. of Savoy. It has a cathedral (St Donatus), the palace of the princes of Acaia and other buildings of some interest. Cotton, silk, wool and hemp are among the local manufactures.

Pinero was bestowed on the bishops of Turin by Otto III. in 996; but in 1078 the countess Adelaide made it over to the Benedictine abbey of Santa Maria, in whose possession it remained till 1159. Thomas I. of Savoy captured the castle in 1188, and in 1246 the commune formally recognized the supremacy of Savoy. Passing in 1295 into the hands of Philip, son of Thomas III., Pinero became his residence and capital, a distinction which it retained under Amadeus VIII. of Savoy. Francis I. of France obtained possession of the town in his descent into Italy, but Emmanuel Philibert received it back from Henry III. in 1574. A second occupation by the French occurred under Cardinal Richelieu; the French language was imposed on the people, great fortifications were constructed, and the fortress (Pignerol) was used as a state prison for such men as Fouquet, De Caumont and the Man with the Iron Mask (see IRON MASK). Victor Amadeus bombarded the place in 1693, and ultimately compelled Louis XIV. to relinquish his hold on it; but before the withdrawal of the French troops the defences were demolished. In 1748 the town was made a bishop's see.

PIN-EYED, a botanical term for flowers which occur in two forms, one of which shows the stigma at the mouth of the corolla, as in the primrose, the term is contrasted with thrum-eyed.

PING-PONG, or **TABLE-TENNIS**, a miniature variety of lawn-tennis played on a table, which may be of any size not less than 5½ ft. long by 3 ft. broad. Various attempts were made to adapt lawn-tennis to the house, but the real popularity of the game began when, near the close of the 19th century, celluloid balls were introduced, and the game was called ping-pong from the sound of the balls as they were struck by the racket or rebounded from the table. In 1900 the ball was improved and made heavier, and for the next two years ping-pong enjoyed a popularity never before attained by a game in so short a time, not only in Great Britain but in France, the British Colonies and America. Two leagues were formed, the "Table-Tennis Association" and the "Ping-Pong Association," whose laws were practically identical. The regular tournament table is 9 ft. long by 5 ft. broad, and the net is a little less than 7 in. high. The balls, which are of hollow celluloid, are about ½ in. in diameter. The racket has a blade, shaped like a lawn-tennis racket, about 6 in. long and a handle long enough to grasp comfortably, all in one piece. Rackets are made either wholly of wood covered with vellum, cork, sand-paper or rubber, or of light frames covered with vellum or some other material. The table was at first marked out in courts, but is now plain. It should be unpolished and stained. In serving, a player must stand directly behind his end of the table and use an underhand motion only. The ball must clear the net and strike the table anywhere on the other side. The game is then continued until the ball misses the table or fails to pass over the net. Only one service is allowed, except in case of a *let*. The scoring is the same as in lawn-tennis.

See *Ping-Pong*, by Arnold Parker (London, 1902); *Table Tennis*, by A. Sinclair (London, 1902).

PINK, in botany, the common name corresponding to a genus of *Caryophyllaceae*, the *Dianthus* of botanists. It is characterized by the presence of simple leaves borne in pairs at the thickened nodes, flowers terminating the axis and having a tubular calyx surrounded by a number of overlapping bracts, a showy corolla of five free long-stalked petals, ten stamens proceeding, together with the petals, from a short stalk supporting the ovary, which latter has two styles and ripens into a cylindrical or oblong pedicel-like one-chambered many-seeded capsule which opens at the apex by four culms or valves. The species are herbaceous perennials of low stature, often with very showy flowers. They are natives chiefly of southern Europe and the Mediterranean region, a few being found in temperate Asia and South Africa. Four species are wild in Britain. Of these, *D. armeria*, Deptford pink and *D. deltoides*, maiden pink, are generally distributed, *D. caesius*, Cheddar pink, occurs only on the limestone rocks at Cheddar. Two others, *D. plumarius* and *D. caryophyllus*, are more or less naturalized, and are interesting as being the originals of the pinks and of the carnations and picotees of English gardens. Garden pinks are derivatives from *Dianthus plumarius*, a native of central Europe, with leaves rough at the edges, and with rose-coloured or purplish flowers. The use of "pink" for a colour is taken from the name of the plant.¹ The pink is a favourite garden flower of hardy constitution. It has been in cultivation in England since 1629, and is a great favourite with florists, those varieties being preferred which

¹ The etymology of "pink" is disputed; it may be connected with "to pink" (apparently a naturalized form of "pick"), properly to prick or punch holes in material for the purpose of ornament, hence, later, to scallop or cut a pattern in the edge of the material. The flower has jagged edges to the petals, but the name occurs in the 16th century, and the later meaning, "to scallop," not till the 19th. Others connect with "pink," half-shut blinking of the eyes, as in "plumpe Bacchus, with pinke eye" (Shakespeare *Ant. and Cl.* II. vii. 121); this word is seen in Dutch *pinken*, to blink, shut the eyes, and may be connected with "pinch." The French name for the flower, *oillet*, little eye, may point to this derivation. The disease of horses, known as "pink-eye," a contagious influenza, is so-called from the colour of the inflamed conjunctiva, a symptom of the affection.

have the margin of the petals entire, and which are well marked in the centre with bright crimson or dark purple. Its grassy but glaucous foliage is much like that of the carnation, but the whole plant is smaller and more tufted. Pinks require a free loamy soil deeply trenched, and well enriched with cow-dung. They are readily increased by cuttings (pipings), by layers and by seed. Cuttings and layers should be taken as early in July as practicable. The former should be rooted in a cold frame or in a shady spot out of doors. When rooted, which will be about August, they should be planted 4 in. apart in a nursery bed, where they may remain till the latter part of September or the early part of October. The chief attention required during winter is to press them down firmly should they become lifted by frosts, and in spring the ground should be frequently stirred and kept free from weeds. The pink is raised from seeds, not only to obtain new varieties, but to keep up a race of vigorous-growing sorts. The seeds may be sown in March or April in pots in a warm frame, and the young plants may be pricked out into boxes and sheltered in a cold frame. They should be planted out in the early part of the summer in nursery beds, in which, if they have space, they may remain to flower, or the alternate ones may be transplanted to a blooming bed in September or the early part of October; in either case they will bloom the following summer. These will grow in any good garden soil, but the richer it is the better.

The border varieties are useful for forcing during the early spring months. These are propagated from early pipings and grown in nursery beds, being taken up in October, potted in a rich loamy compost, and wintered in a cold pit till required for the forcing house.

The following varieties are among the best. For borders and forcing: Ascot, Carne, Delicata, Derby Day, Her Majesty, Hercules, Anne Boleyn, Lady Blanche, Mrs Sinkins, Mrs James Welsh, Pilgrimage Park, Rubens, Snowdon, Tom Welsh. Florists' show and faced varieties: Attraction, Beauty of Bath, Clara, Criterion, Ensign, Galopin, Harry Hooper, John Ball, Malcolm Dunn, Mrs D. Gray, Reliance, William Paul.

The Carnation (*G.*) and Picotee are modifications of *Dianthus Caryophyllus*, the Love Pink. This is a native of Europe, growing on rocks in the south, but in the north usually found on old walls. Its occurrence in England on some of the old Norman castles, as at Rochester, is supposed by Canon Ellacombe to indicate its introduction by the Normans; in any case the plant grows in similar situations in Normandy. The carnation includes those flowers which are streaked or striped lengthwise—the picotees are those in which the petals have a narrow band of colour along the edge, the remainder of the petal being free from stripes or blotches. These by the old writers were called "gillyflowers." The Sweet William of gardens is a product from *Dianthus barbatus*.

The Sea-Pink, or Thrift, *Statice Armeria* (*Armeria vulgaris*), is a member of the natural order *Plumbaginaceae*; it is a widely distributed plant found on rocky and stony sea-shores and on lofty mountains. There are many improved varieties of it now in cultivation, one with almost pure white flowers.

PINKERTON, ALLAN (1819–1884), American detective, was born in Glasgow, Scotland, on the 25th of August 1819. His father, a sergeant of the Glasgow municipal police, died in 1828 of injuries received from a prisoner in his custody. In 1842 Allan emigrated to Chicago, Illinois. In 1843 he removed to Dundee, Kane county, Illinois, where he established a coopers' business. Here he ran down a gang of counterfeiters, and he was appointed a deputy-sheriff of Kane county in 1846 and immediately afterwards of Cook county, with headquarters in Chicago. There he organized a force of detectives to capture thieves who were stealing railway property, and this organization developed in 1852 into Pinkerton's National Detective Agency, of which he took sole charge in 1853. He was especially successful in capturing thieves who stole large amounts from express companies. In 1866 his agency captured the principals in the theft of \$700,000 from Adams Express Company safes on a train of the New York, New Haven & Hartford railway, and recovered all but about \$12,000 of the stolen money. In February 1861 Pinkerton found evidence of a plot to assassinate President-elect Lincoln upon his arrival in Baltimore on his way to Washington; as a result, Lincoln passed through Baltimore at an early hour in the morning without stopping. In April 1861 Pinkerton, on

the suggestion of General George B. McClellan, organized a system of obtaining military information in the Southern states. From this system he developed the Federal secret service, of which he was in charge throughout the war, under the assumed name of Major E. J. Allen. One of his detectives, James McFarlan, in 1873–1876 lived among the Molly Maguires (*q.v.*) in Pennsylvania and secured evidence which led to the breaking up of the organization. In 1869 Pinkerton suffered a partial stroke of paralysis, and thereafter the management of the detective agency devolved chiefly upon his sons, William Allan (b. 1846) and Robert (1848–1907). He died in Chicago on the 1st of July 1884. He published *The Molly Maguires and the Detectives* (1877), *The Spy of the Rebellion* (1883), in which he gave his version of President-elect Lincoln's journey to Washington; and *Thirty Years a Detective* (1884).

PINKERTON, JOHN (1758–1826), Scottish archaeologist, numismatist and author, was born at Edinburgh on the 17th of February 1758. He was articled as a law clerk in Edinburgh, and his *Elegy on Craigmillar Castle* (1776) was printed during his clerkship. In 1781 he removed to London to devote himself to literary work, publishing in the same year a volume of *Rimes* of no great merit, and *Scottish Tragic Ballads*. These were followed in 1782 by *Two Dithyrambic Odes on Enthusiasm and Laughter*, and by a series of *Tales in Verse*. Under the title of *Select Scottish Ballads* he reprinted in 1783 his tragic ballads, with a supplement comprising *Ballads of the Comic Kind*. Ritson pointed out in 1784 that the so-called ancient ballads were some of them of modern date, and Pinkerton confessed that he was the author of the second part of *Hardy Kanite* and part-author of some others. He published an *Essay on Medals* in 1784, and in 1785, under the pseudonym of "Robert Heron," his bold but eccentric *Letters of Literature* depreciating the classical authors of Greece and Rome. In 1786 he edited *Ancient Scottish Poems* from the MS. collections of Sir Richard Maitland of Lethington—a genuine reproduction. It was succeeded in 1787 by a compilation, under the new pseudonym of "H. Bennet," entitled *The Treasury of Wit*, and by his first important historical work, the *Dissertation on the Origin and Progress of the Scythians or Goths*, to which Gibbon acknowledged himself indebted. Pinkerton next collected and printed in 1789 certain *Vilae sanctorum scotiae*, and, a little later, published his *Enquiry into the History of Scotland preceding the Reign of Malcolm III.* His assertion that the Celtic race was incapable of assimilating the highest forms of civilization excited "violent disgust," but the *Enquiry* was twice reprinted, in 1794 and 1814, and is still of value for the documents embodied in it. His edition of Barbour's *Bruce* and a *Medallic History of England to the Revolution* appeared in 1790; a collection of *Scottish Poems reprinted from scarce Editions* in 1792; and a series of biographical sketches, the *Iconographia scotica*, in the years 1795–1797. In 1797 he published a *History of Scotland from the Accession of the House of Stuart to that of Mary*, containing much valuable material. A new biographical collection, the *Gallery of Eminent Persons of Scotland* (1799), was succeeded after a short interval by a *Modern Geography digested on a New Plan* (1802; enlarged, 1807). About this time he left London for Paris, where he made his headquarters until his death on the 10th of March 1826. His remaining publications were the *Recollections of Paris in the years 1802–3–4–5* (1806); a very useful *General Collection of Voyages and Travels* (1808–1814); a *New Modern Atlas* (1808–1810); and his *Petology* (1811).

PINKNEY, WILLIAM (1764–1822), American lawyer and statesman, was born in Annapolis, Maryland, on the 17th of March 1764. He was admitted to the bar in 1786, and in 1788–1792 practised in Harford county. In 1788 he was a member of the state convention which ratified the Federal constitution for Maryland, in 1788–1792 and in 1795 of the House of Delegates (where in 1788 and 1789 he defended the right of slave-owners to manumit their slaves), and in 1792–1795 of the state executive council. In 1796–1804 he was a commissioner under article 7 of Jay's Treaty of 1794 to determine the claims of American merchants for damage through "irregular or illegal captures

or condemnations," and during this time adjusted on behalf of Maryland a claim of the state to stock in the Bank of England. In May 1806, with James Monroe, then minister at London, he was commissioned to treat with the British government concerning the capture of neutral ships in time of war; in 1807-1811, after Monroe's return to America, he was resident minister in London. He was elected to the Maryland senate in September 1811, and from December 1811 to January 1814 was attorney-general of the United States. In August 1814 he was wounded at Bladensburg. He served in the National House of Representatives in January-April 1816, and in 1816-1818 was minister plenipotentiary to Russia and special minister to Naples, where he attempted to secure indemnity for the losses to American merchants by seizure and confiscation during the rule of Murat. In 1809. From 1820 until his death, at Washington, on the 25th of February 1822, he was a member of the United States Senate. He was a member of the conference committee on the bill for the admission of Maine and Missouri, which in its final form embodied what is known as the Missouri Compromise. Pinkney was a remarkably able lawyer and an orator of the old school.

See *The Life of William Pinkney* (New York, 1853) by his nephew, William Pinkney (1810-1883), who was Protestant Episcopal bishop of Virginia in 1879-1883; and Henry Wheaton, *Some Account of the Life, Writings, and Speeches of William Pinkney* (New York, 1828).

PINNACE, the name of two types of vessel or boat, one a light sailing vessel with two schooner-rigged masts, the other a heavy eight-oared man-of-war's boat. The word is usually referred to Lat. *pinus*, pine, but this derivation is at variance with the earlier form "spinace."

PINNACLE (from Lat. *pinnaeculum*, a little feather, *pinna*; the Gr. *πτερυγος*, diminutive of *πτερυξ*, wing, is also used in this sense), an architectural ornament originally forming the cap or crown of a buttress or small turret, but afterwards used on parapets at the corners of towers and in many other situations. Some writers have stated that there were no pinnacles in the Romanesque styles, but conical caps to circular buttresses, with finial terminations, are not uncommon in France at very early periods. Viollet-le-Duc gives examples from St Germer and St Remi, and there is one of similar form at the west front of Rochester Cathedral. In the 12th-century Romanesque two examples have been cited, one from Bredon in Worcestershire, and the other from Cleve in Gloucestershire. In these the buttresses run up, forming a sort of square turret, and crowned with a pyramidal cap, very much like those of the next period, the Early English. In this and the following styles the pinnacle seems generally to have had its appropriate uses. It was a weight to counteract the thrust of the vaults, particularly where there were flying buttresses; it stopped the tendency to slip of the stone copings of the gables, and counterpoised the thrust of spires; it formed a pier to steady the elegant perforated parapets of later periods; and in France especially served to counterbalance the weight of overhanging corbel tables, huge gargoyles, &c. In the Early English period the small buttresses frequently finished with gables, and the more important with pinnacles supported with clustered shafts. At this period the pinnacles were often supported on these shafts alone, and were open below; and in larger work in this and the subsequent periods they frequently form niches and contain statues. About the Transition and during the Decorated period, the different faces above the angle shafts often finish with gables. Those of the last-named period are much richer, and are generally decorated with crockets and finials, and sometimes with ball-flowers. Very fine groups are found at Beverley Minster and at the rise of the spire of St Mary's, Oxford. Perpendicular pinnacles differ but little from Decorated, except that the crockets and finials are of later character. They are also often set angle-ways, particularly on parapets, and the shafts are panelled. In France pinnacles, like spires, seem to have been in use earlier than in England. There are small pinnacles at the angles of the tower in the abbey of Saintes. At Roulet there are pinnacles in a similar position, each composed of four small shafts, with caps and bases surmounted with

small pyramidal spires. In all these examples the towers have semicircular-headed windows.

PINNOCK, WILLIAM (1782-1843), English publisher and educational writer, was born at Alton, Hampshire, on the 3rd of February 1782, and was at first a schoolmaster, then a bookseller. In 1817 he went to London and, in partnership with Samuel Mander, began to publish cheap educational works. The firm's first productions were a series of *Catechisms*, planned by Pinnock, consisting of short popular manuals, arranged in the form of question and answer, of the different departments of knowledge. They were followed by abridged editions of Goldsmith's histories of England, Greece and Rome, and a series of county histories which were no less profitable. Pinnock lost nearly all his money in outside speculation, and died in London on the 21st of October 1843. His son, William Henry Pinnock (1813-1885), a clergyman, was the editor and author of several elementary textbooks and scriptural manuals, and of various works on ecclesiastical law and usage.

PINOCHLE, or **PENUCHLE** (Ger. *Pinochel* or *Binochel*, of uncertain etymology), a game of cards probably invented by Germans in the United States about the middle of the 19th century. It bears a general resemblance to *Bézique* (q.v.), and has almost entirely usurped the place of the older game in America. Pinochle may be played by two, three or four persons. Two packs, from which all cards below the nines have been deleted, are shuffled together, forming one pack of 48 cards. The object of the game is to make 1000 points. The cards rank as follows: ace 11, ten 10, king 4, queen 3, knave 2. The nine counts nothing unless it be turned for trumps, when it scores 10. The last trick scores 10. The term "to meld" (Ger. *melden*, to announce), as used in pinochle, means "to declare." "Melds" are combinations which are declared during the play of the hands. They are of three classes: (1) "marriages" and "sequences," (2) "pinochles," and (3) "fours." The "melds" of the first class score as follows: "marriage" (king and queen of any plain suit), 20; "royal marriage" (king and queen of trumps), 40; "sequence" (the five highest trumps), 150. In the second class the "melds" are "pinochle" (queen of spades and knave of diamonds), 40; "double pinochle" (both queens of spades and knaves of diamonds), 300; "grand pinochle" (king and queen of spades and knave of diamonds), 80; this "meld" is not often played in America. Of the third class the "melds" are: four aces of different suits, 100; four kings of different suits, 80; four queens of different suits, 60; four knaves of different suits, 40; eight aces, 1000; eight kings, 800; eight queens, 600; eight knaves, 400.

In single pinochle (two players) each player receives twelve cards, four at a time, the twenty-fifth being turned up beside the stock for trumps. The non-dealer leads a card, to which the dealer plays. There is no obligation either to take, follow suit or trump. The winner of the trick leads again, before which, however, he may "meld" any one combination he holds. After he has "melded," or refused to do so, he draws a card from the top of the stock and adds it to his hand without showing it, his adversary doing the same, so that each player continues to hold twelve cards. Playing, announcing, and drawing then go on until the stock is exhausted. All combinations "melded" must be laid face upward on the table but still belong to the player's hand, though they may not be taken up until the stock has given out. When this happens all announcements cease, and all cards exposed are replaced in the hands. The last twelve tricks are then played, but now both players must follow suit and must win the trick if possible, either with a superior card or a trump. A failure to do this is a "revoke" and is penalized by the loss of all points made by "cards," i.e. for the five highest cards in each suit, which after all the tricks have been played, are counted for the player holding them. Ace counts 11 points, ten 10, king 4, queen 3, and knave 2, whatever the suit, so that 240 points for "cards" are divided between the two players. Though points are not counted during the play, a mental count is kept, and whenever a player sees that, by adding the value of his "melds" to what he thinks his cards will count, he has enough to win the game, namely 1000 points, he "calls out" or "knocks on the table, and proceeds to expose his cards. If he fails to show enough to win, he loses the game. If neither player knocks, the game continues until one of them scores 1250; if still a tie, 1500. If a player fails to make good a "meld" he is set back that number of points. The game is scored by counters or on a cribbage-board

In three-handed pinochle the "melds" are exposed before a card is played, and no player may "meld" after he has played to the first trick. A rule is sometimes made that an overlooked combination may be scored by the other players. Four-handed pinochle is played either with partners or each player for himself.

PINSK, a town of Russia, in the government of Minsk, at the confluence of the Strumen and Pina rivers, 196 m. S.W. by rail of Minsk. Pop., 27,938, two-thirds being Jews. The town carries on considerable trade, due to the navigable river Pina, which connects it with the fertile regions in the basin of the Dnieper, and, by means of the Dnieper-and-Bug canal, with Poland and Prussia, while the Oginaky canal connects it with the basin of the Niemen. Pottery, leather, oil, soap and beer are the chief products of the local industries. The draining of the marshes around Pinsk was begun by the government in 1872, and by 1897 8,000,000 acres had been drained at an average cost of 3s. per acre. Pinsk (Pinesk) is first mentioned in 1097 as a town belonging to Sviatopolk, prince of Kiev. In 1132 it formed part of the Minsk principality. After the Mongol invasion of 1239-42 it became the chief town of a separate principality, and continued to be so until the end of the 13th century. In 1320 it was annexed to Lithuania; and in 1569, after the union of Lithuania with Poland, it was chief town of the province of Brest. During the rebellion of the Cossack chief, Bogdan Chmielnicki (1640), the Poles took it by assault, killing 14,000 persons and burning 5000 houses. Eight years later the town was burned by the Russians. Charles XII. took it in 1706, and burned the town with its suburbs. Pinsk was annexed to Russia in 1795.

PINSUTI, CIRO (1829-1888), Anglo-Italian composer, was born at Siena, and was educated in music, for a career as a pianist, partly in London and partly at Bologna, where he was a pupil of Rossini. From 1848 he made his home in England, where he became a teacher of singing, and in 1856 he was made a professor at the Academy of Music in London. He became well known as a composer of numerous favourite songs and part-songs, as well as of three operas brought out in Italy, and it is by the former that he is still remembered.

PINT (derived probably through Spanish, from Lat. *pineta*, *pineta*, a painted or marked vessel), a liquid measure of capacity, equivalent to $\frac{1}{4}$ of a gallon. The imperial British pint = .57 of a litre, 34.66 cub. in. The United States standard pint = .47 of a litre, 28.4 cub. in. The word appears in French as *pinite* for a liquid measure as early as the 13th century.

PINTO, AMÍBAL (1825-1884), Chilean president, was born at Santiago, Chile. After a diplomatic training in the legation at Rome he learned the practice of administration as *intendente* of Concepcion, and from 1871 to 1876 was minister of war and marine under Errázuriz. During his term of office as president (1876 to 1881) Pinto had to deal first with a severe financial crisis, and then to conduct the struggle with Peru and Bolivia, in which he displayed great coolness of judgment and devotion to duty.

PINTO, FERNÃO MENDES (1500-1583), Portuguese adventurer, was born at Montemor-o-Velho, of poor and humble parents, and entered the service of a noble lady in Lisbon, being afterwards for two years page to the duke of Aveiro in Setubal. Desiring to try his fortune in the East, he embarked for India in 1537 in a fleet commanded by the son of Vasco da Gama, and for twenty-one years travelled, fought and traded in China, Tartary, Pegu and the neighbouring countries, sailing in every sea, while in 1542-1543 he was one of the first Europeans to visit Japan, where he introduced the musket. Though he was thirteen times a captive and seventeen times sold into slavery, his gay and dauntless spirit brought him through every misfortune. He was soldier and sailor, merchant and doctor, missionary and ambassador; moreover, as the friend and travelling companion of St Francis Xavier, he lent the apostle of the Indies the money with which to build the first Jesuit establishment in Japan. In January 1554 Mendes Pinto was in Goa, waiting for a ship to take him to Portugal, when he took a sudden resolution to enter the company of Jesus and devote a large part of the capital he had accumulated to the evangelization of Japan.

The viceroy appointed him ambassador to the king of Bungo in order to give the mission an official standing, and on the 18th of April he set sail with the provincial, Father Belchior Nunes. Owing to bad weather and contrary winds, however, the missionaries did not reach Japan until July 1556, but the success of the mission represented a notable service to the cause of Christianity and civilization. On the 14th of November 1556 Father Belchior and Mendes Pinto began their return voyage and reached Goa on the 17th of February 1557. During his stay of a twelve-month there, the latter left the company, being dispensed from his vows for want of vocation at his own request, though a modern authority states that he was expelled because he was found to be a *marrano*, i.e. to possess Jewish blood. He finally returned to Portugal on the 22nd of September 1558, and settled at Pragal near Almada, where he married and wrote his famous book, the *Peregrination*; the MS., in fulfilment of his wishes, was presented by his daughter to the Casa Pia for penitent women in Lisbon, and it was published by the administrators in 1614. When Philip II. of Spain came to Portugal as its king, he listened with pleasure to the account of Mendes Pinto's travels, and by letter of the 15th of January 1583 gave him a pension for his services in the Indies. But the reward came too late, for the great traveller died on the 8th of July.

In the light of our present-day knowledge of the East, Pinto is regarded as having been on the whole a careful observer and truthful narrator, but this was not always the case. Some witty countryman of his own parodied his name into *Fernão, mentes? Minto!* ("Ferdinand, do you lie? I do!"); and the English dramatist Congreve only expressed the general opinion of the unlearned when he wrote in *Love for Love* "Mendes Pinto was but a type of thee, thou liar of the first magnitude." It must be remembered that Pinto wrote the *Peregrination* long subsequent to the events he records, and this fact and a certain fertility of imagination sufficiently account for inaccuracies. Furthermore, as the book was only published posthumously, he never had the opportunity of correcting the proofs. Some of his most marvellous stories are expressly given on the authority of writers belonging to the countries he describes; others he tells from hearsay, and Oriental informants are prone to exaggeration. But if he somewhat adorned the truth, he did not wilfully misrepresent it. The book itself gives the impression of sincerity, and the editors of the first edition bear witness to the probity, good faith and truthfulness of Mendes Pinto as a man. Herrera Maldonado prefaced his Spanish translation of the *Peregrination* (1620) by a lengthy and erudite apology to demonstrate its authenticity, and Castilho has reinforced his arguments by modern testimonies. In the narrative portions of his work Pinto's style is simple, clear and natural, his diction rich, particularly in sea terms, and appropriate to his varying subjects. There is an entire absence of artifice about the book, which must always rank as a classic, and it might fairly be argued that Mendes Pinto did for the prose of Portugal what Camoens did for its poetry; this is the more remarkable, because it does not appear that he ever received any education in the ordinary sense. He wrote the book for his children to learn to read by, and modestly excused its literary defects by alleging his rudeness and lack of talent. Tradition has it that the MS. was entrusted to the chronicler Francisco de Andrade for the purpose of being polished in style and made ready for press, but that all he did was to divide it into chapters.

The *Peregrination* has gone through many editions subsequent to that of 1614, and in 1865 Castilho published excerpts in his *Livro clássico portuguez* with an interesting notice of Mendes Pinto's life and writings. Versions exist in German (3 editions), French (3 editions), Spanish (4 editions), and in English by Henry Cogan, London (1663, 1692 and—abridged and illustrated, with introduction by Arminius Vambery—1891). Cogan omits the chapters relating to Mendes Pinto's intercourse with, and the last days of, St Francis Xavier, presumably as a concession to anti-Catholic prejudice.

See Christovão Ayres, *Fernão Mendes Pinto* (Lisbon, 1904). *Fernão Mendes Pinto e o Japão* (Lisbon, 1906); also *Subsídios para a biographia de Fernão Mendes Pinto* by Jordão de Freitas (Coimbra, 1905). (S. Pn.)

PINTO. The remarkable brown, black and blue spots of discoloration of the whole body met with endemically in Mexico, Panama, Colombia and Venezuela, and known under the name of "pinto" or "mal de los pintos," were first claimed by Gastambide (*Presse med. Belge*, 1881, Nos. 33-41) as due to the presence of a vegetable parasite, whose spores and even mycelial filaments may be detected among the deeper rows of cells of the rete mucosum. The disease appears to be one of the many forms of *morbus miseriae*; but it is contagious, and is sometimes seen in the well-to-do. In some villages of the western districts of Tabasco (Mexico) it has been estimated that 9% of the inhabitants suffer from the pinto; M'Clellan says that in 1826 in the City of Mexico he saw a whole regiment of "pintados."

PINTURICCHIO (1454-1513), Italian painter, whose full name was BERNARDINO DI BETTI, the son of a citizen of Perugia, Benedetto or Betto di Biagio, was one of a very important group who inherited the artistic traditions and developed the style of the older Perugian painters, such as Bonfigli and Fiorenzo di Lorenzo. According to Vasari he was a pupil of Perugino; and so in one sense no doubt he was, but rather as a paid assistant than as an apprentice. The strong similarity both in design and methods of execution which runs through the works of this later Perugian school is very striking; paintings by Perugino, Pinturicchio, Lo Spagna and Raphael (in his first manner) may often be mistaken one for the other. In most cases, especially in the execution of large frescoes, pupils and assistants had a large share in the work, either in enlarging the master's sketch to the full-sized cartoon, in transferring the cartoon to the wall, or in painting backgrounds, drapery and other accessories. After assisting Perugino in the execution of his frescoes in the Sistine Chapel, Pinturicchio was employed by various members of the Della Rovere family and others to decorate a whole series of chapels in the church of S. Maria del Popolo in Rome, where he appears to have worked from 1484, or earlier, to 1492 with little interruption. The earliest of these is an altarpiece of the "Adoration of the Shepherds," in the first chapel (from the west) on the south, built by Cardinal Domenico della Rovere; a portrait of the cardinal is introduced as the foremost of the kneeling shepherds. In the lunettes under the vault Pinturicchio painted small scenes from the life of St. Jerome. The frescoes which he painted in the next chapel, that built by Cardinal Innocenzo Cibo, were destroyed in 1700, when the chapel was rebuilt by Cardinal Alderano Cibo. The third chapel on the south is that of Giov. della Rovere, duke of Sora, nephew of Sixtus IV., and brother of Giuliano, who was afterwards Pope Julius II. This contains a fine altarpiece of the "Madonna enthroned between Four Saints," and on the east side a very nobly composed fresco of the "Assumption of the Virgin." The vault and its lunettes are richly decorated with small pictures of the life of the Virgin, surrounded by graceful arabesques; and the dado is covered with monochrome paintings of scenes from the lives of saints, medallions with prophets, and very graceful and powerfully drawn female figures in full length in which the influence of Signorelli may be traced. In the fourth chapel Pinturicchio painted the Four Latin Doctors in the lunettes of the vault. Most of these frescoes are considerably injured by damp, but happily have suffered little from restoration; the heads are painted with much minuteness of finish, and the whole of the pictures depend very largely for their effect on the final touchings *a secco*. The last paintings completed by Pinturicchio in this church were the frescoes on the vault over the retro-choir, a very rich and well-designed piece of decorative work, with main lines arranged to suit their surroundings in a very skilful way. In the centre is an octagonal panel of the coronation of the Virgin, and round it medallions of the Four Evangelists—the spaces between them being filled up by reclining figures of the Four Sibyls. On each pendentive is a figure of one of the Four Doctors enthroned under a niched canopy. The bands which separate these pictures have elaborate arabesques on a gold ground, and the whole is painted with broad and effective touches, very telling when seen (as is necessarily the case) from

a considerable distance below. No finer specimen of the decoration of a simple quadripartite vault can anywhere be seen.

In 1492 Pinturicchio was summoned to Orvieto, where he painted two Prophets and two of the Doctors in the duomo. In the following year he returned to Rome, and was employed by Pope Alexander VI. (Borgia) to decorate a suite of six rooms in the Vatican, which Alexander had just built. These rooms, called after their founder the *Appartamenti Borgia*, now form part of the Vatican library, and five of them still retain the fine series of frescoes with which they were so skilfully decorated by Pinturicchio. The upper part of the walls and vaults, not only covered with painting, but further enriched with delicate stucco work in relief, are a masterpiece of decorative design applied according to the truest principles of mural ornament—a much better model for imitation in that respect than the more celebrated Stanze of Raphael immediately over the Borgia rooms. The main subjects are: (1) the Annunciation, the Nativity, the Magi, and the Resurrection; (2) Scenes from the lives of St. Catherine, St. Antony and other saints; (3) allegorical figures of music, arithmetic and the like; (4) four figures in half length, with rich arabesques; (5) figures of the planets, the occupations of the various months, and other subjects. The sixth room was repainted by Perino del Vaga.¹

Though not without interruption, Pinturicchio, assisted by his pupils, worked in these rooms from 1492 till 1498, when they were completed. His other chief frescoes in Rome, still existing in a very genuine state, are those in the Cappella Bufalini at the south-west of S. Maria in Ara Coeli, probably executed from 1497 to 1500. These are well-designed compositions, noble in conception, and finished with much care and refinement. On the altar wall is a grand painting of St. Bernardino of Siena between two other saints, crowned by angels; in the upper part is a figure of Christ in a vesica-glory, surrounded by angel musicians; on the left wall is a large fresco of the miracles done by the corpse of St. Bernardino, very rich in colour, and full of very carefully painted heads, some being portraits of members of the Bufalini family, for whom these frescoes were executed. One group of three females, the central figure with a child at her breast, is of especial beauty, recalling the grace of Raphael's second manner. The composition of the main group round the saint's corpse appears to have been suggested by Giotto's painting of St. Francis on his bier in S. Croce at Florence. On the vault are four noble figures of the Evangelists, usually attributed to Luca Signorelli, but certainly, like the rest of the frescoes in this chapel, by the hand of Pinturicchio. On the vault of the sacristy of S. Cecilia in Trastevere, Pinturicchio painted the Almighty surrounded by the Evangelists. During a visit to Orvieto in 1496 Pinturicchio painted two more figures of the Latin Doctors in the choir of the duomo—now, like the rest of his work at Orvieto, almost destroyed. For these he received fifty gold ducats.

Among his panel pictures the following are the most important. An altarpiece for S. Maria de' Fossi at Perugia, painted in 1496-1498, now moved to the picture gallery, is a Madonna enthroned among Saints, graceful and sweet in expression, and very minutely painted; the wings of the retable have standing figures of St. Augustine and St. Jerome; and the *predella* has paintings in miniature of the Annunciation and the Evangelists. Another fine altarpiece, similar in delicacy of detail, and probably painted about the same time, is that in the cathedral of San Severino—the Madonna enthroned looks down towards the kneeling donor. The angels at the sides in beauty of face and expression recall the manner of Lorenzo di Credi or Da Vinci. The Vatican picture gallery has the largest of Pinturicchio's panels—the Coronation of the Virgin, with the apostles and other saints below. Several well-executed portraits occur among the kneeling saints. The Virgin, who kneels at Christ's feet to receive her crown, is a figure of great tenderness and beauty, and the lower group is composed with great skill and grace in arrangement. Other important panel paintings by Pinturicchio exist

¹See Guattani, *Quadri nell'appart. Borgia* (Rome, 1820).

in the cathedral of Spello, in the Siena gallery, at Florence, at Perugia, and in other collections.

In 1501 Pinturicchio painted several fine frescoes in S. Maria Maggiore at Spello—all very decorative and full of elaborate architectural accessories. One of them, the Annunciation, is signed "Bernardinus Pinturichius Perusinus." The most striking of all Pinturicchio's frescoes, both for brilliance of colour and their wonderful state of preservation, are those in the cathedral library at Siena, a large room built in 1495 by Cardinal Francesco Piccolomini, afterwards Pius III. In 1502 the cardinal contracted with Pinturicchio to decorate the whole room with arabesques on the vault, and on the walls ten scenes from the life of Aeneas Sylvius Piccolomini, Pius II., the uncle of Cardinal Francesco.

The contract specially provided that the cartoons, their transference on to the walls, and all the heads, were to be by Pinturicchio's own hand, thus contradicting Vasari's assertion that the cartoons were the work of Raphael. The document provides for the price of these frescoes, namely one thousand gold ducats, to be paid in various instalments. The work was begun early in 1503, but was interrupted for a while by the death of Pius III. His will, however, provided for the completion of the work by his executors, and the whole series were finished in 1507. The subjects are (1) the journey of the young Sylvius Piccolomini to the Council of Basel, in the suite of Cardinal Capranica; (2) his reception by James I. of Scotland as envoy from the Council of Basel; (3) his being crowned with the poet's laurel by Frederick III.; (4) his reception by Pope Eugenius IV. as ambassador from Frederick III.; (5) outside the wall of Siena he presents to Frederick III. his bride Leonora, infanta of Portugal; (6) he receives the cardinal's hat from Pope Calixtus III.; (7) he is borne in procession after his election as Pope Pius II.; (8) he presides at a council at Mantua; (9) he canonizes St. Catherine of Siena; (10) he arrives in Ancona to promote the crusade against the Turks. In addition to these there is, outside the library, over the door, the coronation of Pius III. In the lower part of the scene of St. Catherine's canonization he has introduced his own portrait, and standing by him is a youth who bears some resemblance to Raphael.

In 1508 Pinturicchio painted another panel of the Madonna enthroned among saints for the church of the Minori Conventuali at Spello. It is now over the altar in the sacristy. On his return to Siena he painted a whole series of frescoes on the walls of the Palazzo Petrucci, now all destroyed except one scene of the return of Ulysses to Penelope (or possibly Collatinus and Lucretia), which is now in the National Gallery of London, transferred to canvas. One of his last works, painted in 1513, the year of his death, is a very beautiful and highly finished panel with Christ bearing His Cross, now in the Palazzo Borromeo in Milan. Pinturicchio married Grania di Niccolò, and had by her two sons and four daughters; there is probably no truth in the story of his being starved by his wife during his last illness.

Pinturicchio's worth as a painter has been for the most part undervalued, partly owing to the very strong prejudice and dislike which tinges Vasari's biography of him. Even Crowe and Cavalcasse hardly did him justice. A fairer estimate of his position in the history of art is given by Vermiglioli, *Memorie di Pinturicchio* (Perugia, 1837); and in the valuable notes and appendix of Milanesi's edition of Vasari, iii. 493-531 (Florence, 1878). See also Schmarow, *Raphael and Pinturicchio in Siena* (Stuttgart, 1880), and *Pinturicchio in Rome* (Stuttgart, 1882), both well illustrated by photo-lithography. (J. H. M.)

PINWELL, GEORGE JOHN (1842-1875), British water-colour painter, was born at Wyecombe, and educated at Heatherley's Academy. He is one of the most interesting personalities in the little group of water-colour painters which included Frederick Walker and A. B. Houghton, a group whose style was directly derived from the practice of drawing upon wood for book illustration. He was one of the most delightful book illustrators of his day, poetic in imagination, with considerable inventive power and an admirable sense of colour. As he died young his works are few, but their promise was so great that had he lived he would probably have attained a very high position. His early life was one of considerable privation. In 1862 he entered at Heatherley's studio and there obtained his art education. His earliest drawings appeared in *Littell's Living*. He did a little work for Fox and executed several designs for the silversmiths, Elkingtons. In 1863 his first drawing appeared in *Once a Week*,

and from that time his work was in constant demand. There are many of his compositions in *Good Words*, *The Sunday Magazine*, *The Quiver* and *London Society*, but his most important productions made for the Dalziel brothers were illustrations of Goldsmith, of Jean Ingelow's poems, Robert Buchanan's *Ballads of the Affections*, and the *Arabian Nights*.

Of Pinwell's pictures in colour, which are distinguished by a remarkable, jewel-like quality and marked by his strong love of pure, bright colour and opalescent effect, the chief are the two scenes from the *Pied Piper of Hamelin*, *Gilbert & Becket's Troth*, *Out of Tune* or *The Old Cross*, *A Seat in St James's Park*, and *The Elixir of Life*.

In 1874 Pinwell fell seriously ill and went to Africa for the winter. He painted several remarkable pictures at Tangier, but his strength gradually broke down and he returned to die in his wife's arms on the 8th of September 1875. Pinwell was an exhibitor at the Dudley gallery, and in 1869 was elected associate of the Royal Water-Colour Society and full member in 1870; to this gallery he contributed fifty-nine works. A posthumous exhibition of his works was held in 1876 in Bond Street.

See *Life of George J. Pinwell*, by George C. Williamson, quarto, 1900. (G. C. W.)

PINZON, a family of wealthy Spanish navigators, of Palos in Andalusia, three members of which—Martin Alonso, Francisco and Vicente Yañez, brothers—were associated with Columbus in the discovery of America.

MARTIN ALONZO PINZON, born about the middle of the 15th century, gave material assistance to Columbus in carrying out his project. "If Colon was the head, Pinzon was the right arm" (Asensio). In the expedition of 1492 he commanded the "Pinta," on which his brother Francisco was pilot; another brother, Vicente Yañez, commanded the "Nina." On the 6th of October Martin Alonso suggested to Columbus (when already in the longitude of the Bermudas) to change the course of the expedition from due west to south-west; on the 7th of October this suggestion—strengthened by the observation of a flight of birds to the south-west—was adopted, bringing the fleet, four days later, to the landfall at Guanahani (San Salvador, Watling Island) in the Bahamas (Oct. 12, 1492). On the 21st of November 1492, near the east end of the north coast of Cuba, Martin Alonso left Columbus, making eastward in search of the gold-land of which they had heard the natives speak. On the 6th of January 1493 he rejoined the admiral, who accepted his excuses. But on the return journey he again left his leader, and when Columbus arrived at Palos on the 15th of March 1493 he learned that Alonso had already landed at Bayona in Galicia. If his object was to forestall Columbus and pose as discoverer of the New World, he was foiled; audience was refused him by Ferdinand and Isabella, and soon after he died, perhaps of chagrin.

VICENTE YAÑEZ PINZON, who commanded the "Nina" in 1492-1493, also gave Columbus material help, and remained loyal to his leader throughout. In after years he made important discoveries on his own account. Late in December 1499 he sailed with four caravels across the Atlantic to the south-west, and on the 7th of February 1500 he struck the South American continent at Cape S. Agostinho, near its most easterly projection (called by him Cape Santa Maria de la Consolacion) almost three months before the Portuguese navigator Cabral reached Brazil, the discovery of which is generally attributed to him. Proceeding southwards a short distance, he then turned north, followed the coast to the north-west, discovered the Amazon estuary, and went at least as far as what is now Costa Rica. After touching at Haiti, and losing two of his vessels among the Bahamas, Vicente returned to Palos in the end of September 1500. Although concessions were made to him, and he was created governor of the newly discovered lands by Ferdinand and Isabella, he does not seem to have ever taken possession. In 1507 we find Vicente sailing with Juan Diaz de Solis along the east coast of Central America. In 1509, again with De Solis, he coasted the Atlantic side of South America as far as the La Plata estuary, hoping to find an opening westwards leading to the Spice Islands. According to Herrera, he even reached 40° S.

passing the La Plata without recognising it, and turning back about the mouth of the Rio Negro, but this is probably an exaggeration. After 1523 all traces of Vicente are lost.

See Navarrete, *Coleccion de viajes*; Washington Irving's *Columbus*, Bk. XIV., ch. ii.; bibliography in Joaquin Caetano da Silva's *L'Oyapoc et l'Amazone* (Paris, 1861); Herrera, *Indias Occid.*, Dec. I., lib. vi. cap. 17; lib. vii., caps. 1 and 9 (Madrid, 1730); Oviedo, *Hist. general de las Indias*, lib. xxiii. cap. 1 (Madrid, 1852); O. Peschel, *Geschichte der Erdkunde*, pp. 230, 233, 249 (Munich, 1865); *Zeitschrift der Entdeckungen*, pp. 305, &c., 426; Jose Maria Asensio, *Cristal Colon, su vida, sus viajes, sus descubrimientos* (Barcelona, 1891); Cesareo Fernandez Duro, *Colon e Pinson*.

PIO DI SAVOIA, an ancient noble Italian family, first mentioned by good authorities in the 14th century. From the house of Este (*q.v.*) they received the lordship of Carpi, and later they acquired the fiefs of Meldola, Sassuolo, &c. Many members of the family were distinguished as *condottieri*, diplomats and ecclesiastics. Alberto Pio obtained from the house of Savoy in 1450 the privilege of adding "di Savoia" to his name as a reward for his military services. Another Alberto Pio (1475-1531), who was French ambassador in Rome, won fame as a man of learning, and Cardinal Rodolfo Pio (1516-1564) was a trusted adviser to Pius III. and helped to establish the Inquisition at Milan. Ascanio Pio (d. 1649) was a dramatic poet of some merit. Spain conferred the title of prince on the family, and one branch of it is to this day established in Spain.

See P. Litta, *Le Famiglie celebri italiane* (Milan); G. Campori *Memorie storiche di Marco Pio di Savoia* (Modena, 1876); A. Ceriani and G. Porro, "Il Rotolo epistografico dei principi Pio di Savoia," in the *Archivio storico lombardo*, ser. II., n. XL, fasc. 1, ser. III., n. VIII., 96, and ser. III., n. XLX., 453.

PIOMBINO, a seaport of Tuscany, Italy, in the province of Pisa, 8 m. by rail W.S.W. of Campiglia Maritima (which is 53 m. S.S.E. of Pisa), 62 ft. above sea-level, at the southern extremity of the peninsula of the Monte Massoncello. Pop. (1901), 5970 (town); 7703 (commune). It is surrounded by old walls, and contains some interesting Renaissance works by a master of about 1458 under the influence of Alberti. It is the port of embarkation for Elba, the nearest point of which is about 6 m. to the south-west, and originally belonged to Pisa. It gives the title of prince to the Buoncompagni Ludovisi family, who, however, no longer own it.

PIONEER, properly a foot-soldier (Med. Lat. *pedo*, *pedonis*, through O. Fr. *poonier*, *piemier*, cf. "paw") who with spade, axe and other implements, precedes an army or smaller military body, and clears or makes a road, digs intrenchments, prepares a camping ground, &c. The word is thus applied to all who, actually or figuratively, are first in exploring or working an undiscovered or undeveloped country or field of inquiry.

PIOTRKOW (Ger. *Petrikow*), a government of Russian Poland, bounded by the government of Warsaw on the N., Radom and Kielce on the E., Kalisz on the W. and Prussian Silesia on the S. Area, 4729 sq. m.; pop. (1906, estimate), 1,675,200. Geologically it represents a continuation of Upper Silesia, and is built up of Upper Carboniferous deposits, containing near Bendzin a bed of coal 265 sq. m. in extent. Permian and Jurassic deposits, containing zinc ores, as also lignite and limonite iron ores, overlie the Carboniferous. The surface consists of a series of heights, 1000 to 1600 ft. above sea-level, intersected by ravines, and stretching from south-west to north-east. The government is drained by the Warta and the Pilica, and was formerly covered with thick forests. It was colonized by Mazurs and Poles (Veliko-Polyans and Malo-Polyans). The government, which is the most densely peopled in the Russian Empire, is divided into eight districts, of which the chief towns are Piotrkow, Bendzin, Brzeszyn, Czenstochowa, Lask, Loda, Nowo-Radom and Rawa. Agriculture and cattle-breeding are extensively carried on; and coal and iron are mined. Textile industries developed with extraordinary rapidity during the closing years of the 19th and the opening years of the 20th centuries, the towns of Loda, Fabianice, Zgers and Bendzin all being important centres. Other branches of productive industry are distilleries, breweries, flour-mills, brickyards, sugar, cement, glass and candle factories. Granica and Somowice, in this government, are two of the most

important custom-houses in Russia, and the annual trade is estimated at £12,000,000.

PIOTRKOW, a town of Russian Poland, capital of the government of the same name, and formerly the seat of the high court of Poland, on the railway from Warsaw to Vienna, 90 m. south-west of the former and 5 m. west of the river Pilica. Pop. (1900), 52,173. It is a well-kept town, with numerous gardens, and has flour-mills, saw-mills, tanneries, agricultural machinery works, and breweries. One of the oldest towns in Poland, Piotrkow was in the 15th and 16th centuries the place of meeting of the diets, and here the kings were elected. In the 14th century Casimir the Great built here a castle (now a military church) and surrounded the town with walls. Here in 1769 the Russians defeated the (Polish) forces of the Bar Confederation.

PIOZZI, HESTER LYNCH (1741-1821), English writer, well known as the friend (Mrs Thrale) of Samuel Johnson (*q.v.*), was born on the 16th of January 1741, her father being John Salusbury of Bobbel, Carnarvonshire. Her maternal uncle, Sir Robert Salusbury Cotton, contemplated providing for his niece, but he died without having carried out his intention. She and her mother lived in London, and amongst her childish recollections were meetings with James Quin and David Garrick. She received a solid education, for she was acquainted with Latin as well as with French, Italian and Spanish. In 1763 she was married to Henry Thrale, a rich Southwark brewer, whose house was at Streatham on the south-east corner of Tooting Bec Common. There was very little sympathy between the lively girl and Thrale, who was thirteen years her senior, but gradually she drew round her a distinguished circle of friends. She was introduced to Samuel Johnson in 1765 by Arthur Murphy, who was an old friend of her husband's. In 1766 Johnson paid a long visit to Streatham, and from that time was more or less domesticated with the Thrales. In time it became his custom to spend the middle of the week at Streatham, devoting the remaining days to his own heterogeneous "family." He was genuinely attached to his hostess, and thoroughly appreciated the luxury in which the Thrales lived. They were able to soften some of his eccentricities, and they certainly made him happy. He travelled with them in Wales in 1774, and in France in 1775. Dr Burney gave lessons to one of the Miss Thrales, and in 1778 he brought his daughter Fanny to Streatham. She became a warm friend of Mrs Thrale, and has left an account of the Streatham household in her diary. This friendship was by no means always unclouded. Fanny Burney was very sensitive, and sometimes thought that Mrs Thrale gave herself airs of patronage. Meanwhile, in 1772, Thrale's business was seriously injured, and he was threatened with bankruptcy. The situation was saved by his wife's efforts, and in the next year Thrale travelled, leaving her in charge of his affairs. He was twice returned for the borough of Southwark, chiefly through her efforts. In 1781 Mr Thrale died, and Dr Johnson helped the widow with her business arrangements, advising her to keep on the brewery, until she "cured his honest heart of its incipient passion for trade, by letting him into some, and only some, of its mysteries." The brewery was finally sold for £135,000. Mrs Thrale had met Gabriele Piozzi, an Italian musician, in 1780. Johnson was now in failing health, and soon began to feel himself slighted. His suspicions were definitely aroused when she laid aside her mourning for Thrale in 1782, and the Streatham house was sold. In 1783 her engagement to Piozzi was announced. The objections of her daughters and her friends induced her to break it off for a time, but it was soon resumed, and in 1784 they were married. Johnson told Miss Burney that he drove the memory of Mrs Thrale from his mind, burning every letter of hers on which he could lay his hand. The Piozzis presently left England to travel in Italy. At Florence they fell in with Robert Merry and the other "Della Cruscan" writers ridiculed by William Gifford in his *Martinus and Baniad*, and she contributed some verses to their *Florence Miscellany* in 1785. In 1786 she published *Anecdotes of the late Samuel Johnson, during the last twenty years of his life*, which was severely criticized by Boswell. She was ridiculed by "Peter Pinder" in *Benny and*

Piozzi; or the British Biographers, A Town Eclogue (1786). But though Miss Burney and some others held aloof, the Piozzis found plenty of friends when they returned to London in 1787. Piozzi died at Brynbell, a villa he had built on his wife's Carnarvonshire estate in 1800, and Mrs Piozzi gave up her Welsh property to her husband's son, and spent most of the rest of her life at Bath and Clifton. When long past seventy she took a fancy to William Augustus Conway, the actor. She retained her vivacity to the last, celebrating her 80th birthday by a ball to six or seven hundred people at Bath. She died at Clifton on the 2nd of May 1821.

From 1776 to 1809 she kept a note-book which she called "Thraliana." Her well-known poem of the "Three Warnings" is to be found in many popular collections. *Letters to and from the late Samuel Johnson* appeared in 1788; *Observations and Reflections made in the course of a Journey, through France, Italy and Germany*, in 1789; and in 1801 she published *Retrospection; or a review of the most striking and important events, characters, and situations . . . which the last eighteen hundred years have presented to the view of mankind* (1801).

See *Letters and Literary Remains of Mrs Piozzi (Thrale)*, edited with notes and an Introductory Account of her Life and Writings by A. Hayward (1861); *Piozziana; or Recollections of the late Mrs Piozzi by a Friend* (1833), the anonymous friend being Edward Mangin (1772-1852); L. E. Seeley, *Mrs Thrale, afterwards Mrs Piozzi . . .* (1891), and G. Birkbeck Hill, *Johnsonian Miscellanies* (1897). Also works noted in bibliography to JOHNSON, SAMUEL.

PIPE, a term used of a musical wind-instrument of tubular form, and hence of any cylindrical hollow tube. The original application of the term is to the musical instrument (see PIPE AND TABOR below), and the source is to be found in Lat. *pipare*, to chirp, of a bird. The general meaning of "pipe," in the sense of a tube for such purposes as carrying water, gas, sewage, &c., is treated under TUBE. Among specific uses of the word are those for the hollow stem of clay, wood or other material with a bowl at one end in which tobacco is smoked (see below); for the metal or wooden sound tubes in an organ (*q.v.*); and for various forms of cylindrical veins, hollows, channels, &c., in mining and geology. The Great Roll of the Exchequer was known as the "Pipe Roll", this contained the various "pipes" or enrolled accounts of the sheriffs, &c., which were so called either from being sent in a cylindrical case or as resembling a pipe in shape when rolled (see RECORDS).

Tobacco Pipe.—The smoking of tobacco in pipes is a custom which prevailed in America for a period of unknown duration previous to the discovery of that continent by Columbus. The most ancient pipes of which remains exist have been found in mounds or tumuli called pipe mounds, principally in Ohio, Indiana, Illinois and Iowa. These mound pipes, which are carved in porphyry and other hard stones, are very uniform in type. The pipe, cut out of a single piece of stone, consists of a slightly convex platform or base, generally from 3 to 4 in. in length, and about an inch broad, with the bowl on the centre. A



FIG. 1.—"Monitor" Pipe.

fine hole is pierced from one end of the platform to the bottom of the bowl, the opposite end being obviously for holding in the hand while the pipe is being smoked. In the commonest forms the bowl is a simple cylinder or urn (fig. 1), but in many cases remarkable artistic skill has been displayed in carving the bowls into miniature figures of birds, mammals, reptiles and human heads, often grotesque and fantastic, but always vigorously expressed (fig. 2). These mound or platform pipes with carved human and animal forms are objects of the highest ethnographic interest and importance, being among the most characteristic remains of the ancient inhabitants of the Mississippi valley. The wide area over which they, as well as



FIG. 2.—Heron Pipe.

remains of baked clay pipes, are found throughout the American continent testifies to the universal prevalence of smoking in the pre-Columbian era. Many of the ancient clay pipes found in Mexico, &c., are elaborately moulded and ornamented, while others show considerable similarity to the early clay pipes of Europe. Among the North-American Indian tribes the tobacco pipe occupies a position of peculiar symbolic significance in connexion with the superstitious rites and usages of the race. The calumet, peace pipe or medicine pipe, is an object of the most profound veneration, entrusted to the care of a highly honoured official, and produced and smoked with much ceremony only on occasions of great importance and solemnity. It is remarkable that, whilst the most ancient American pipes had no separate stem, it is the stem only of the medicine pipe which is the object of veneration among the Indians, the bowl used being a matter of indifference. The favourite material for Indian pipe bowls is the famous red pipe stone (catlinite), a fine-grained easily-worked stone of a rich red colour of the Côteau des Prairies, west of the Big Stone Lake in S. Dakota. The quarries were formerly neutral ground among the warring Indian tribes, many sacred traditions being associated with the locality and its product.

It is disputed whether pipes for smoking were at all known in Europe previous to the discovery of America. That tobacco-smoking was unknown is certain; but pipes of iron, bronze and clay have been so frequently found associated with Roman remains and other antiquities as to lead many authorities to maintain that such pipes must have been anciently used for burning incense or for smoking aromatic herbs or hemp. Throughout Great Britain and Ireland small clay pipes are frequently dug up, in some instances associated with Roman relics. These are known amongst the people as elfin, fairy or Celtic pipes, and in some districts supernatural agencies have been called in to account for their existence. The elfin pipes have commonly flat broad heels in place of the sharp spur now found on clay pipes, and on that flat space the mark or initials of the maker is occasionally found. There is no reason to believe that these pipes are older than the 17th century. The introduction of the tobacco pipe into Europe is generally ascribed to Ralph Lane, first governor of Virginia, who in 1586 brought an Indian pipe to Sir Walter Raleigh, and taught that courtier how to use the implement. The pipe-makers of London became an incorporated body in 1619, and from England the other nations of Europe learned the art of making clay pipes.

The habit of smoking with pipes spread with incredible rapidity; and among the various peoples the pipe assumed special characteristics, and its modifications became the medium of conveying social, political and personal allusions, in many cases with no little artistic skill and humour. The pipe also became the object of much inventive ingenuity, and it varied as greatly in material as in form—wood, horn, bone, ivory, stone, precious and other metals, amber, glass, porcelain and, above all, clay being the materials employed in various forms. By degrees pipes of special form and material came to be associated with particular people, e.g. the elongated painted porcelain bowls and pendulous stem of the German peasantry, the red clay bowl and long cherry wood-stem of the Turk, and the very small metallic bowl and cane stem of the Japanese, &c. Among other kinds of pipe which have been popular at various times are the "corn-cob," where the bowl is made of the cob of maize or Indian corn, and the "calabash" with the bowl of a small gourd. The "churchwarden" is a clay pipe with a slender stem, some 16 or 20 in. long. The most luxurious and elaborate form of pipe is the Persian *kalyan*, hookah or water tobacco pipe. This consists of three pieces, the head or bowl, the water bottle or base, and the snake or long flexible tube ending in the mouthpiece. The tobacco, which must be previously prepared by steeping in water, is placed in the head and lighted with live charcoal, a wooden stem passes from its bottom down into the water which fills the base, and the tube is fitted to a stem which ends in the bottle above the water. Thus the smoke is cooled and washed before it reaches the smoker by passing through the water in

the bottle, and by being drawn through the coil of tube frequently some yards in length. The bottles are in many cases made of carved and otherwise ornamented coco-nut shells, whence the apparatus is called *nargh*, from *nargh*, a coco-nut. Silver, gold, damascened steel and precious stones are freely used in the making and decoration of these pipes for wealthy smokers.

Pipe Manufacture.—The regular pipe-making industries divide into many branches, of which the more important are the clay pipe, meerschaum (real and artificial), and wooden bowl trades. Clay pipes are made in prodigious numbers by hand labour with an iron mould and a steel wire for forming the tube of the stem. Pipe-moulding is a very simple operation in pottery, and the work is performed with astonishing celerity. A number of machines have been devised for automatic pipe-moulding; but the manual operations are so rapid and inexpensive that there is little margin for saving by the substitution of machinery. The pipes are very slightly fired so as to keep them soft and porous; and so cheaply made are they that the commoner kinds can be retailed at a profit for a farthing each. The principal early centres of the clay-pipe industry were at Broseley in Staffordshire, where the trade has been established since the early part of the 17th century, and at Amesbury in Wiltshire. The manufacture is still carried on at Broseley. Meerschaum pipes (see MEERSCHAUM) are the luxury of the European smoker. The favourite wooden pipe generally known as a briar-wood or briar-root pipe is really made from the roots of the tree heath, *Erica arborea* (Fr. *bruyère*), principally obtained on the hills of the Maremma and taken thence to Leghorn. There the roots are shaped into blocks each suitable for a pipe, the cutting of the wood so as to avoid waste requiring considerable skill. These blocks are simmered in a vat for twelve hours, which gives them the much-appreciated yellowish-brown hue of a good "briar-root." So prepared the blocks are exported for boring and finishing. Many devices have been invented for the purpose of preventing the nicotine liquor from reaching the smoker's mouth or collecting in and fouling the pipe.

PIPE AND TABOR (Fr. *galoubet*; Ger. *Schwegel* or *Stamentienpfeiff*), a popular medieval combination of a small pipe or flageolet, and a small drum. The pipe consists of a cylindrical tube of narrow bore, pierced with three holes, two in front and one at the back, all very near the end of the pipe; and of a mouthpiece of the kind known as whistle, fipple or beak common to the *flûtes à bec* or recorder family. The compass of this instrument, with no more than three holes, exceeds two octaves in the hands of a good player, and is chromatic throughout. The fundamental notes of the open pipe and of the three holes cannot be produced; the scale consists, therefore, entirely of harmonics, the 2nd, 3rd and 4th of the series being easily obtained, and, by half stopping the holes, also the semitones which are required to complete the chromatic scale. The tabor being fastened to the performer's left elbow, the hands remained free, the right beating the little drum with a stick to mark the rhythm, while the left held and fingered the pipe with thumb and first two fingers.

Mersenne mentions a wonderful virtuoso, John Price, who could play to the twenty-second on the galoubet. Praetorius mentions and figures three sizes of the Stamentienpfeiff, the treble 20 in. long, the tenor 26 in. and the bass 30, the last being played by means of a crook about 23 in. long. A specimen of the bass in the museum of the Brussels Conservatoire has for its lowest note middle C. The pipe and tabor are said to be of Provençal origin; it is certain that they were most popular in France, England and the Netherlands, and they figure largely among the musical and social scenes in the illuminated MSS. of those countries. (K. S.)

PIPE-FISHES (*Syngnathina*), small fishes, which with the Seahorses form a distinct family, *Syngnathidae*, of Lophobranchiate

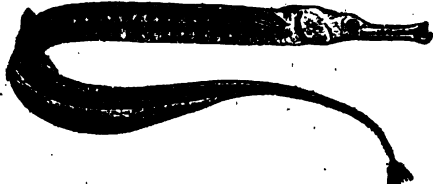

FIG. 1.—*Syngnathus acus*, Male, with sub-caudal pouch. The name is derived from the peculiar form of their snout, which is produced into a more or less long tube, ending in a

narrow and small mouth which opens upwards and is toothless. The body and tail are long and thin, snake-like, encased in hard integuments which are divided into regularly arranged segments. This dermal skeleton shows several longitudinal ridges, so that a vertical section through the body represents an angular figure, not round or oval as in the majority of other fishes. A dorsal fin is always present, and is the principal (in some species, the only) organ of locomotion. The ventral fins are as constantly absent, and the other fins may or may not be developed. The gill-openings are extremely small and placed near the upper posterior angle of the gill-cover. Most of the pipe-fishes are marine, only a few being fluviatile. Pipe-fishes are abundant on such coasts of the tropical and temperate zones as offer by their vegetation shelter to these defenceless creatures. They are very bad swimmers, slowly moving through the water by means of the rapid undulatory movement of the dorsal fin. Their tail, even when provided with a caudal fin, is of no use in swimming, and not prehensile as in sea-horses. Specimens, therefore, are not rarely found at a great distance from land, having been resolutely carried by currents into the open ocean; one species, *Syngnathus pelagicus*, has an extraordinarily wide range over the tropical seas, and is one of the common fishes inhabiting the vegetation of the Sargasso Sea. The colour of these fishes often changes with the sea-weeds among which they may be found, passing from brown to green or even brick-red. In pipe-fishes the male is provided with a pouch—in some species on the abdomen, in others on the lower side of the tail—in which the ova are lodged during their development. This marsupial pouch is formed by a fold of the skin developed from each side of the trunk or tail, the free margins of the fold being firmly united in the median line throughout the period during which the eggs are being hatched. When the young are hatched the folds separate, leaving a wide slit, by which the young gradually escape when quite able to take care of themselves. Nearly a hundred different species of pipe-fishes are known, of which *Siphonostoma typhis*, *Syngnathus acus* (the Great Pipe-fish up to 18 in. in length), *Nerophis aquaricus* (Ocean Pipe-fish), *Nerophis ophidion* (Straight-tailed Pipe-fish), and *Nerophis umbriciformis* (Little Pipe-fish) are British species. The last three are destitute of a caudal fin.

A review of the extensive literature on the breeding habits of the *Syngnathidae* is given by E. W. Gudger, "The Breeding habits and the Segmentation of the Egg of the Pipefish," *Proc. U.S. Nat. Mus.* (1905), vol. 447.

PIPER, CARL, COUNT (1647–1716), Swedish statesman, was born at Stockholm on the 29th of July 1647. He entered the foreign office after completing his academical course at Upsala, accompanied Benedict Oxensterna on his embassy to Russia in 1673, and attracted the attention of Charles XI. during the Scanian War by his extraordinary energy and ability. In 1679 he was appointed secretary to the board of trade and ennobled. In 1689 he was made one of the secretaries of state, and Charles XI. recommended him on his deathbed to his son and successor, Charles XII. Piper became the most confidential of the new sovereign's ministers. In 1697 he was made a senator and set over domestic affairs while still retaining his state-secretaryship. In 1698 he was created a count, in 1702 appointed chancellor of Upsala University, and during the first half of the Great Northern War, as the chief of Charles's perambulating chancellery, he was practically prime minister. It was his misfortune, however, to be obliged to support a system which was not his



FIG. 2.—Sub-caudal pouch of *Syngnathus acus*, with the young ready to leave the pouch. One side of the membrane of the pouch is pushed aside to admit of a view of its interior. (Nat. size.)

own. He belonged to the school of Benedict Onamstjerna and was therefore an avowed advocate of a pacific policy. He protested in vain against nearly all the military ventures of Charles XII., e.g. the War of Deposition against Augustus of Saxony and Poland, the invasion of Saxony, the raid into the Ukraine. Again and again he insisted that the pacific overtures of Peter the Great should at least be fairly considered, but his master was always immovable. Piper's career came to an end at Poltava (1709), where he was among the prisoners. The last years of his life were spent in exile in Russia. He died at Schlüsselburg on the 20th of May 1716.

See W. L. Svedelius, *Conni Carl Piper* (Stockholm, 1866). (R. N. B.)

PIPERAZIN, a substance formed by the action of sodium glycol on ethylene-diamine hydrochloride, consisting of small alkaline deliquescent crystals with a saline taste and soluble in water. It was originally introduced into medicine as a solvent for uric acid. When taken into the body the drug is partly oxidized and partly eliminated unchanged. Outside the body piperazin has a remarkable power of dissolving uric acid and producing a soluble urate, but in clinical experience it has not proved equally successful. Lycetol, lysidine and sidonal are bodies having similar action.

PIPERINE, $C_{17}H_{19}NO_3$, an alkaloid found in the fruits of *Piper nigrum* and *P. longum*. It forms white prisms, which melt at 128° – 210° . It is almost insoluble in water, but readily soluble in alcohol and ether. It is a very weak base, salts being only formed with mineral acids, and these are dissociated by water. Alcoholic potash decomposes it into piperidine, $C_4H_{11}N$, and piperic acid, $C_{13}H_{15}O_4$. The constitution of piperic acid was elucidated by R. Fittig and his pupils (*Ann.*, vols. 152, 159, 168, 216, 227) and shown to be (1). Piperine consequently is (2).

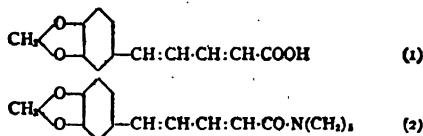

Oxidation with potassium permanganate converts piperic acid into piperonal, $C_8H_8O_3$, and piperonylic acid, $C_8H_7O_4$. The latter when heated with hydrochloric acid to 170° , or water to 200° , separates carbon with the formation of protocatechuic acid, 1,2-dioxy-3-benzoic acid, $C_7H_5(OH)COOH$. Conversely, by heating protocatechuic acid with potash and methylene iodide, piperonylic acid was regained. These results show that piperonylic acid is the methylene ether of protocatechuic acid. Piperonal (*q.v.*) is the corresponding aldehyde. Piperic acid differs from piperonylic acid by the group C_2H_5 , and it was apparent that these carbon atoms must be attached to the carbon atom which appears in the carboxyl group of piperonylic acid, for if they were directly attached to the benzene ring polycarboxylic acids would result in oxidation. The above formula for piperic acid was confirmed by its synthesis by A. Ladenburg and M. Scholtz (*Ber.*, 1894, 27, p. 2958) from piperonyl acrolein (the condensation product of piperonal and acetaldehyde) and acetic acid. The synthesis of piperine follows from the interaction of piperyl chloride (formed from piperic acid and phosphorus pentachloride) and piperidine (*L. Rügheimer, Ber.*, 1882, 15, p. 1390).

PIPERNO (anc. *Privernum*), a town of the province of Rome, Italy, 61 m. S.E. of Rome by rail. Pop. (1901), 6736. The mediæval town was founded in the 10th century (?) on a hill 490 ft. above sea-level, by refugees from the Roman town of Privernum, lower down (118 ft. above sea-level) on the highroad, 1½ m. to the north, at the mouth of a low pass leading through the Volscian mountains to the valley of the Sacco. Here are remains of an arch crossing the road and other ruins (mostly buried) of the Roman period; but the remains above ground are largely mediæval. It is improbable, however, that the ancient Volscian town should have occupied so easily accessible a site; it is not unlikely that it stood on the site occupied by the mediæval and modern town, but there is no proof of this. Privernum was a Volscian town, and took up arms against Rome after the foundation of a Latin colony at Setia in 382 B.C. It was finally captured in 329 B.C., and eleven years later the

tribes Ostentina was founded, taking its name from the river Ostens (mod. Uffente) in the territory of Privernum. Little is known of it subsequently. The mediæval town has a picturesque piazza, with a Gothic cathedral (1283), which preserves a fine porch, though the interior was modernized in 1782; a Gothic palazzo pubblico; and other Gothic churches exist in the town. Polygonal terrace walls of the Roman or pre-Roman period exist at various places in the vicinity (G. B. Giovenale and L. Mariani in *Notizie degli Scavi*, 1899, 88). (T. AS.)

PIPERONAL (heliotropine, protocatechuic aldehyde methylene ether), $C_8H_8O_3$, an aromatic aldehyde. It is prepared by oxidizing piperic acid with potassium permanganate (R. Fittig, *Ann.*, 1869, 152, p. 35); by condensing methylene iodide with protocatechuic aldehyde (R. Wegscheider, *Monats.*, 1893, 14, p. 388); or by oxidizing isosafrol with chromic acid. It forms long colourless crystals which melt at 37° C. and boil at 263° C. It has an agreeable smell, resembling that of heliotrope, and is much used in perfumery. It is only slightly soluble in cold water, but is readily soluble in alcohol and in ether. When heated with dilute hydrochloric acid to 200° C. it yields protocatechuic aldehyde, $C_7H_6O_3$, and carbon. It readily combines with sodium bisulphite and with various bases (ammonia, aniline, methylamine, &c.).

PIPT (cognate with the Lat. *Pipio*; see **PIGEON**), the name applied by ornithologists to a group of birds having a great resemblance both in habits and appearance to the larks (*q.v.*). They differ however from larks in several important characters, and, having been first separated to form the genus *Anthus*, which has since been much broken up, are now generally associated with the wagtails (*q.v.*) in the Passerine family *Motacillidae*. Pipts, of which over fifty species have been described, occur in almost all parts of the world, but in North America are represented by only two species—*Neocorys spragueii*, the prairie-lark of the north-western plains, and *Anthus ludovicianus*, the American titlark, which last is very nearly allied to the so-called water-pipit of Europe, *A. spipolletta*. To most English readers the best known species of pipit is the titlark or meadow-pipit, *A. pratensis*, a bird too common to need description, and abundant on pastures, moors, and uncultivated districts generally; but in some localities the tree-pipit, *A. trivialis*, or *A. arboris* of some authors, takes its place, and where it does so it usually attracts attention by its loud song, which is not unlike that of a canary, but delivered (as appears to be the habit of all the pipits) on the wing and during a short circuitous flight. Another species, the rock-lark, *A. obscurus*, scarcely ever leaves the seacoast and is found almost all round the British Islands. The South-African genus *Macronyx*, remarkable for the extreme length of its hind claw, is generally placed among the pipits, but differs from all the rest in its brighter coloration, which has a curious resemblance to the American genus *Sturnella* (see **ICTERUS**), though the bird is certainly not allied thereto.

(A. N.)

PIPPIN, or **PREPIN**, the name of three members of the Carolingian family.

PIPPIN I. (d. 640), incorrectly called Pippin of Landen, was mayor of the palace to the youthful Dagobert I., whom Clotaire II. had placed over the kingdom of Austrasia. He was disgraced when Dagobert became sole king in 629, and had to seek refuge in Aquitaine. Returning at Dagobert's death (639), he governed Austrasia in Sigebert's name, but died in the following year.

PIPPIN II. (d. 714), incorrectly called Pippin of Herstal, was son of Adalgisilus (son of Arnulf, bishop of Metz) by a daughter of Pippin I., called in later documents Begga. Towards 678 he placed himself at the head of the great nobles in Austrasia to combat Ebroin, the mayor of the palace, and Neustria. After some reverses he gained a great victory after Ebroin's death at the battle of Tertry, not far from St Quentin. This victory made Pippin almost entire master of Gaul. He appointed one of his sons mayor of the palace of Neustria, reserving for another of his sons the mayoralty of Austrasia. He made war

on the Frisians and defeated their duke Radbod; and part of this people became converts to Christianity. He also defeated Willari, the duke of the Alamanni, and subdued his country. The Bavarians, too, recognized the Frankish suzerainty. The plans he had formed for reforming the church and convoking councils were interrupted by his death, which took place on the 16th of December 742.

PIPPIN III. (d. 768), the Short,¹ was son of Charles Martel. Before his death in 741 Charles Martel had divided the Frankish kingdom between his two sons, Carloman and Pippin, giving Carloman the eastern part and Pippin the western. Since 737 there had been no king in the Frankish realm; in the diplomas the two brothers bear the title of *maiores palatii*, while the chroniclers call them simply *principes*. In 743, however, the mayors decided to appoint a king in the person of Childeric III., who was apparently connected with the Merovingian family. But Childeric was a mere figure-head, and had no power. The two brothers presided over the tribunals, convoked the councils at which the Frankish Church was reformed, assembled the host and made war, jointly defeating and subduing Duke Hunald of Aquitaine. In 747 Carloman unexpectedly abdicated, became a monk, and retired to a monastery near Rome, subsequently founding on Mt Soracte the monastery of St Silvester. From the time of the abdication Pippin was sole master; and in 751, after consulting Pope Zacharias, he took the title of king and removed the feeble Childeric to a monastery. He then got himself crowned by St Boniface, a ceremony which was new to France and which gave the sovereign immense prestige; henceforth the king of the Franks called himself *Gratia Dei rex Francorum*. Pippin's reign is marked by many important events. He received in France a personal visit from Pope Stephen II., who conferred on him the title of Patrician of the Romans and recrowned him. In return for these honours Pippin, at the appeal of the pope, made two expeditions into Italy, in 754 and 756; and he became the veritable creator of the papal state by conferring on the pope the exarchate of Ravenna, which he had wrested from Aistulf, the king of the Lombards. Pippin took Septimania from the Arabs, and after a stubborn war of nearly eight years' duration (760-68) succeeded in taking Aquitaine from its duke, Waifer. He also intervened in Germany, where he forced the duke of Bavaria, Tassilo, to become his vassal. In 763, however, Tassilo abandoned Pippin during an expedition against Aquitaine. Pippin made several expeditions against the Saxons, but failed to subdue them. He entered into relations with the Eastern Empire, exchanging ambassadors with the emperor Constantine Copronymus. During Pippin's reign Frankish institutions underwent some modification. The Frankish assemblies, previously held in the month of March (*champs de mars*), but under Pippin deferred to May (*champs de mai*), came to be more numerous, and served the king of the Franks as a means of receiving the gifts of his subjects and of promulgating his capitularies. At the head of the administration was placed the archchaplain, and an ecclesiastical chancellor was substituted for the ancient *referendarius*. Ecclesiastical reform was continued under Pippin, Bishop Chrodegang of Metz uniting the clergy of Metz in a common life and creating canons (see CANON). Pippin died on the 24th of September 768 at St Denis, leaving two sons, Charles (Charlemagne) and Carloman.

See H. Bonnell, *Die Anfänge des karolingischen Hauses* (Berlin, 1866); H. Hahn, *Jahrbücher des frankischen Reiches 741-752* (Berlin, 1863); L. Oelsner, *Jahrbücher des frankischen Reiches unter König Pippin* (Leipzig, 1871); J. F. Böhm and E. Mühlbacher, *Regesten des Kaiserreichs unter den Karolingern* (2nd ed., 1899); and E. Mühlbacher, *Deutsche Geschichte unter den Karolingern* (Stuttgart, 1896).

PIPRĀWA, a village on the Birdpur estate in the Basti district, United Provinces, India. It lies on the Uka-Nepal road at mile 10-75; and about half a mile south of the boundary pillar numbered 44 on the frontier line between British and Nepalese

¹ A surname given to Pippin III. on the strength of a legendary anecdote related by the monk of St Gall.

territory. The village is celebrated as the site of the following discovery:—

In 1896 interest having been aroused by the discovery, only twelve miles away, of the Buddha's birthplace (see LUMINA), William Peppé, then resident manager of the Birdpur estate, opened a ruined tope or burial mound situate at Piprāwa, but nothing of importance was found. In January 1897 he carried the work of excavation farther. A well, 10 ft. sq., was dug down the centre of the mound. After digging through 18 ft. of solid brickwork set in clay a massive stone coffer was found lying due magnetic north and south. Its dimensions were, 4 ft. 4 in. by 2 ft. 8½ in. and 2 ft. 2½ in. high. The stone lid of the coffer was split into four pieces; but the coffer remained perfectly closed, so accurately was the lid fitted into flanges on the sides of the box. The pieces were thus firmly held in their place, and the contents of the coffer were found intact. These consisted of five vessels, two vases, a bowl and a casket being made of steatite, and the fifth, also a bowl, of crystal. All these vessels are beautifully worked, the crystal bowl especially, with its fish-shaped cover handle, being as a work of art of high merit.² The coffer is of fine hard sandstone of superior quality, and has been hollowed out, at the cost of vast labour and expense, from a solid block of rock. Peppé calculates its weight, lid included, at 1537 lb. It is only the great solidity of this coffer which has preserved the contents. A cover of one of the vases was found dislodged and lying on the bottom of the stone coffer. As this cover fits very well it must have required a quite violent shock to remove it. This was almost certainly the shock of an earthquake, and the same shock probably caused the split in the stone lid of the coffer itself.

The vessels contained a dark dust, apparently disintegrated ashes, small pieces of bone, and a number of small pieces of jewelry in gold, silver, white and red corneal, amethyst, topaz, garnet, coral and crystal. Most of these are perforated for mounting on threads or wires, and had been, no doubt, originally connected together to form one or more of the elaborate girdles, necklaces and breast ornaments then worn by the women.³ On the bottom of the stone box there was similar dust, pieces of bone and jewelry, and also remains of what had been vessels of wood. The knob forming the handle of one of these wooden receptacles was still distinguishable. The total quantity of scraps of bone may have amounted to a wineglassful.

An inscription ran round one of the steatite vases just below the lid.⁴ The words mean: *This shrine for ashes of the Buddha, the Exalted One, is the pious work of the Sakiyas, his brethren, associated with their sisters, and their children, and their wives.* The thirteen words, in a local dialect of Pali, are written in very ancient characters, and are the oldest inscription as yet discovered in India. Twelve out of the thirteen are well-known words, the interpretation of which is not open to doubt. One word, rendered above by "pious work," has not been found elsewhere, and its derivation is open to discussion. The explanation here adopted as most probable was put forward by Professor Fischele of Berlin.⁵ The phrase "pious work" probably had a precise technical connotation like the English "benefaction."

The monument must have been of imposing appearance. The diameter (on the ground level) of the dome is 116 ft. For 8 ft. from the summit of the ruin it was not possible to trace the outline. At that point the outer wall, if one may so call it, of the solid dome could be traced, and had a diameter of 68 ft. The dome, therefore, sloped inwards 2 ft. for every 3 ft. in height, in other words, it was, like all the most ancient of these artificial burial domes in India, a shallow dome, and cannot have been more than about 35 ft. high exclusive of the ornament or "tee" on the summit. We have in bas-reliefs of the 5th century representations of what these ornaments were like—small

² An illustration from a photograph is given in Rhys Davids' *Buddhist India*, p. 131.

³ For figures of the jewelry found see the plate in Mr Peppé's article, reproduced in Rhys Davids' *Buddhist India*, p. 89. For the jewelry of the time, *ibid.*, p. 90, 91.

⁴ See illustration *ibid.*, p. 129.

⁵ *Zeitschrift der deutschen morgenländischen Gesellschaft*, iv. 257.

square erections, like a shrine or small temple, surmounted by a canopy called from its shape a T. They were then more than a third of the height of the dome itself. The total height of this Sakiya tope will therefore have been approximately a little under 50 ft. It was probably surrounded by a carved wooden railing, but this has long since disappeared.

All such monuments hitherto discovered in India were put up in honour of some religious teacher, not in memory of royal persons, generous benefactors, politicians, or soldiers or private persons, however distinguished. And we need have no hesitation in accepting this as a monument put up over a portion of the ashes from the funeral pyre of Gotama the Buddha. The account of the death and cremation of the Buddha, preserved in the Buddhist canon, states that one-eighth portion of the ashes was presented to the Sakiya clan, and that they built a *thupa*, or memorial mound, over it.¹

Mr Peppé presented the coffer and vases with specimens of the jewelry to the museum at Calcutta where they still are. He also gave specimens of the trinkets to the Asiatic Society in London.

Peppé's original article is in the *Journal of the Royal Asiatic Society* for 1898, pp. 573 sqq. Comments upon it, one or two of them sceptical, are in the same journal 1898, pp. 579, 588, 387, 868; 1899, p. 425; 1901, p. 398; 1905, p. 679; 1906, pp. 149 sqq. See also A. Barth, *Comptes rendus de l'academie des inscriptions* (1898), xxvi., 147, 233; Sylvain Levy, *Journal des savants* (1905) pp. 540 sqq.; and R. Pischel and Rhys Davids as quoted above. (T. W. R. D.)

PIQUA, a city of Miami county, Ohio, U.S.A., on the Miami River and the Miami & Erie Canal, 73 m. W. by N. of Columbus. Pop. (1890), 9090; (1900), 12,172, of whom 907 were foreign-born and 487 were negroes; (1910 census), 13,388. It is served by the Pittsburg, Cincinnati, Chicago & St. Louis, and the Cincinnati, Hamilton & Dayton railways, and by inter-urban electric lines to Lima, Dayton and Covington. It has a park, a public library and a public hospital. There are quarries of blue limestone in the vicinity. The city has various manufactures, the factory products being valued in 1905 at \$4,035,706. The municipality owns and operates its waterworks. On or near the site of Piqua was one of the principal villages of the Chillicothe division of the Shawnee tribe; the village also was called Chillicothe. It was destroyed by George Rogers Clark in 1782. A town was laid out here in 1809 under the name of Washington, and the present name, that of another division of the Shawnee tribe, was substituted in 1823. Piqua was chartered as a city in 1846. During the French and Indian War, in 1763, a battle was fought in this vicinity chiefly between the Miamis, Wyandots, Ottawas and other Indian allies of the French, and the Delawares, Shawnees, Cherokees, Catawbas and other Indian allies of the English, the English allies making an unsuccessful attempt to drive the French allies from their fortified position, Fort Piqua.

See Henry Howe, *Historical Collections of Ohio* (Columbus, 1891).

PIQUET, a game at cards, probably a development of *ronfle*, a game mentioned by Berni in 1526; *la ronfle* (included in Rabelais's list, c. 1530) may be regarded as the same game. The point at piquet was anciently called *ronfle*. The Spanish name of the game was *cientos* (centum, a hundred). Piquet was played in England under the name of *cent*, or *sant*, probably as early as 1550 (contemporaneously with the marriage of Mary to Philip of Spain). About the middle of the 17th century (shortly after the marriage of Charles I. to Henrietta Maria of France) the name cent was dropped in England, and the French equivalent, piquet, adopted. It is played by two persons, with a pack of thirty-two cards—the sixes, fives, fours, threes and twos being thrown out from a complete pack. At one time the *partie* was the best of five games of a hundred up (a player not obtaining fifty losing a double game). But now the *partie* is generally determined in six hands, the player making the largest aggregate score being the winner. The number of points won is the difference between the two scores, with a hundred

¹ Translated in Rhys Davids' *Buddhist Suttas* (Oxford, 1881).

added for the game. If, however, the loser fails to make a hundred in six hands, the number of points won is the sum of the two scores, with a hundred for the game. Piquet played in this way is called *Rabison Piquet*.

The dealer deals twelve cards to his adversary and twelve to himself, two at a time, or three at a time. He then places the eight undealt cards, called the "stock," face downwards on the table, the top five being for the elder hand (non-dealer) to take from first in exchange for his own. The players now look at their hands, and *carte blanche* (see later) having been declared, if there is one, put out (without showing them) such cards as they deem advisable in order to improve their hands, and take in an equivalent number from the stock. Each player must discard at least one card. If the elder hand discards less than the five he is entitled to, he must state how many he leaves. He is entitled to look at the cards he leaves, replacing them face downwards on the top of the stock. The younger hand then makes the exchange from the remainder of the stock. If the elder hand leaves any of the top five, the younger may exchange as many as remain in the stock, discarding an equal number. If the younger hand leaves any cards, he announces the number left. He may look at the cards he leaves. If he looks at them he must show them to the elder hand, after the elder has named the suit he will lead first, or has led a card.

If the younger hand elects not to look at the cards left the elder cannot see them. The younger hand must make his election before he plays to the card first led, or, if so required, after the dealer has named the suit he will first lead. Each player may examine his own discard at any time during the hand; but he must keep it separate from his other cards.

The elder hand next makes a declaration of what he has in his hand.

The "point" must be called first or the right to call it is lost. It is scored by the player who announces the suit of greatest strength, valued thus: ace 11; court cards, 10 each; other cards, the number of pips on each. Thus if the elder hand's best suit is ace, king, knave, nine, eight, he calls "five cards." If the younger hand has no suit better than cards, he says "good." The elder hand then says "in spades," or whatever the suit may be, or shows his point face upwards. If the younger hand has a suit of more than five cards, he says "not good." If the younger hand has also five cards, he says "equal" or "what do they make?" when the elder calls "forty-eight" (or "making eight," short for forty-eight). The younger must not inquire what the point makes unless he has an equal number of cards. If the younger hand's five cards make less than forty-eight he says "good"; if exactly forty-eight, he says "equal"; if more than forty-eight he says "not good." The player whose point is good reckons one for each card of it; if the points are equal neither player scores for point.

"Sequences" are usually called next, the elder hand stating what his best sequence is, and the younger saying, "good," "equal," or "not good," as in the case of the point. Any three or more consecutive cards of the same suit held in hand constitute a sequence. The order of the cards is as follows: ace (highest), king, queen, knave, ten, nine, eight, seven (lowest). A sequence of three cards is called a "tierce" of four, a "quart"; of five, a "quint"; of six, "sixième"; of seven, a "septième"; of eight, "huitième." A tierce of ace, king, queen is called a "tierce major"; a tierce of king, queen, knave is called a "tierce to a king" (and so on for other intermediate sequences according to the card which heads them); a tierce of nine, eight, seven is called a "tierce minor." Sequences of four or more cards follow the same nomenclature; e.g. ace, king, queen, knave is a quart major; knave, ten, nine, eight, is a quart to a knave; and so on. A sequence of a greater number of cards is good against a sequence of a smaller number; thus, a quart minor is good against a tierce major. As between sequences containing the same number of cards, the one headed by the highest card is good; thus, a quart to a queen is good against a quart to a knave. Only identical sequences can be equal. The player whose sequence is good reckons one for each card of it, and ten in addition for quints or higher sequences. Thus a tierce counts three; a quart, four; a quint, fifteen; a sixième, sixteen; and so on. If the elder hand's sequence is good, he names the suit, or shows it face upwards. If the highest sequence (or the sequence first called) is good, all lower sequences can be reckoned, notwithstanding that the adversary has a sequence of intermediate value. For example, A has a quart to a queen (good) and a tierce minor. He calls and reckons seven, notwithstanding that B has a quart to a knave. B's quart counts nothing. If the highest sequence is equal, neither player counts anything for sequence, even though one player may hold a second sequence of equal or inferior value.

"Quatorzes" and "trios" are the next calls. "Quatorzes" are composed of four aces, four kings, four queens, four knaves, or four tens, in order of value; "trios" of three of any of these. A quatorze, if good, reckons fourteen; a trio, if good, reckons three; one that is good establishes any smaller quatorzes or trios in his hand.

When the elder hand has done calling he leads a card. Before

playing to this card, the younger hand reckons all that he has good, stating of what cards his claims are composed, or showing the cards claimed for. The elder hand leads any card he pleases; the younger plays to it. The younger hand must follow suit if able; otherwise he may play any card he thinks fit. It is not compulsory to win the trick. The leader counts one for each card led, whether it wins the trick or not. If the second player wins the trick he also counts one. The winner of the last trick counts an additional one for the last card. The tricks are left face upwards in front of the player who wins them. They may be examined by either player.

If each player wins six tricks the cards are "divided," and there is no further score. If one player wins more than six tricks he wins "the cards," and adds ten to his score. If one player wins every trick, he wins a *capot*, and scores forty for the cards, instead of ten.

During the play of the hand, a player is entitled to be informed as to any cards his adversary holds which he has reckoned as good, or has declared to be equal. A player may require his adversary to exhibit any such cards. But if a player, having played three cards of a suit, declares as a *quint*, is asked how many he has left, he need only reply "Two."

During the progress of the hand each player repeats aloud the amount of his score for the time being. At the end of the hand the points scored are recorded by each player. If there is any difference in the written scores, a player's score of his own hand is deemed to be the correct one.

Example.—A (elder hand) has dealt him ace, king, knave of spades; ace, queen, knave, eight of hearts; knave, eight, seven of clubs; and nine, eight of diamonds. He discards king of spades; eight, seven of clubs; and nine, eight of diamonds. He takes in nine, eight of spades; king of hearts; nine of clubs; and king of diamonds.

B (younger hand) has ten, seven of spades; ten, nine, seven of hearts; king, queen, ten of clubs; and ace, queen, knave, ten of diamonds. He discards seven of spades; and nine, seven of hearts. He takes in queen of spades; ace of clubs; and seven of diamonds.

The hand then proceeds thus. A (calling his point) "five cards." B says "equal," or "what do they make?"

A "forty-nine," or "making nine." B "good." A (counting his point) "five" and, counting his sequence, which is good, "a quart major, nine. Three, knaves." B "not good."

A (leads ace of hearts and says) "ten." B "four, ten, fourteen, and three queens, seventeen" (plays the ten of hearts).

A (leads the remaining hearts and says) "eleven, twelve, thirteen, fourteen." B (plays seven, ten, knave, queen of diamonds, and repeating his score says) "seventeen."

A has now five tricks, and in order to win the cards should lead any card but a high spade. He leads king of diamonds, and says "fifteen." B (wins with ace and says) "eighteen" (and then leads the winning clubs, saying) "nineteen, twenty, twenty-one, twenty-two."

A (keeps ace, knave of clubs, and repeating his score says) "fifteen." B (leads queen of spades and says) "twenty-three."

A (wins with ace and says) "sixteen" (and leads knave, saying) "eighteen" (and adding ten for the cards) "twenty-eight."

A then writes on his scoring card 28; 23. B writes on his 23; 28. The pack is collected, and the next hand commences. Three scores (omitted in order to simplify the description of the game) have yet to be mentioned.

Carte Blanche.—If either player has no king, queen or knave in the hand dealt him, he holds *carte blanche*, for which he scores ten. As soon as a player discovers he has a *carte blanche*, he must tell his adversary; this he usually does by saying "discard for *carte blanche*." The adverse discard is then made (as explained under discarding), after which the *carte blanche* is shown by dealing the cards, face upwards on the table; they are then taken back into the hand.

Pique.—If the elder hand scores, in hand and play, thirty or more, before the younger hand counts anything in that deal, he gains a *pique*, for which he scores thirty.

Repique.—If a player scores in hand alone thirty or more before his adversary reckons anything, he gains a *repique*, for which he adds sixty to his score. Equalities do not prevent piques or repiques. A player who has an equal point or sequence scores nothing for it. Therefore if, notwithstanding the equality, a player makes thirty, in hand and play, or in hand, by scores which reckon in order before anything his adversary can count, he gains a *pique* or a *repique*.

The order in which the scores accrue is of importance. For the sake of convenience, the elder hand finishes his reckoning before the younger begins. The scores, however, whether made by the elder or younger hand are recordable in the following order: (1) *carte blanche*; (2) point; (3) sequences; (4) quatorzes and trios; (5) points made in play; (6) the cards. This will often affect a *pique* or *repique*. Thus, a *pique* can only be made by the elder hand, as the one he reckons in play when he leads his first card counts before points subsequently made in play by the younger hand. The younger, therefore, cannot make thirty in hand and play before the elder scores one. But the one reckoned by the

elder hand when he leads his first card does not prevent his being repiqued, because scores made in hand have precedence of points made in play. The elder leads his first card and counts for it before the younger reckons, simply as a convenient way of stating that he has nothing in hand which is good. Again, say A has a *quint* (good), a *terce*, and a *quatorze* (good). He scores thirty-two in hand alone; but, if his point is not good, he does not gain a *repique*, because the younger hand's point is recordable in order before the sequences and quatorze. *Carte Blanche*, taking precedence of all other scores, saves piques and repiques. It also counts towards piques and repiques. A *capot* does not count towards a *pique*, as the *capot* is not made in play. It is added after the play of the hand is over. A player who reckons nothing that hand as a penalty is not piqued or repiqued if he holds any cards which, but for the penalty, would have reckoned before his adversary reached thirty.

See "Cavendish," *The Laws of Piquet and of Rubicon Piquet, adopted by the Portland Club, with a Treatise on the Game* (1832); "Cavendish," *Guide to Piquet* (1898).

PIRAM, or **PERAN**, an island in the Gulf of Cambay, forming part of Ahmadabad district, Bombay. Formerly notorious as the stronghold of a pirate chieftain, it has attained fame among palaeontologists for the large quantity of fossil remains discovered here in 1836, similar to the better-known Siwalik fauna.

PIRANESI, GIOVANNI BATTISTA, Italian engraver of ancient architectural subjects, was born in the earlier half of the 18th century, and studied his art at Rome. The great remains of that city kindled his enthusiasm and demanded portrayal. His hand faithfully imitated the actual remains of a fabric; his invention, catching the design of the original architect, supplied the parts that were wanting; his skill introduced groups of vases, altars, tombs; and his broad and scientific distribution of light and shade completed the picture, and threw a striking effect over the whole. One engraving after another was executed with much brilliancy; and, as the work went on, the zeal of the artist only waxed stronger. In course of time it was found necessary to call in the aid of all his children and of several pupils. He did not, in fact, slacken in his exertions till his death in 1778.

The plates of Piranesi, in which the severity of burin work is largely supplemented by the freer lines of the etching-needle, were collected and preserved by his son and coadjutor Francesco. They were published, to the number of about 2000, in 29 vols. fol. (Paris, 1835-1837).

PIRANO, a seaport of Austria, in Istria, 22 m. S.W. of Trieste by rail. Pop. (1900), 13,339, mostly Italians. In addition to viticulture and the cultivation of the olive, its principal resources are ship-building and fishing. In the neighbourhood are the most extensive works in Istria for the extraction of salt from the sea-water, which produce about 50,000 tons of salt annually. Pirano is celebrated for the victory of the Venetians over the fleet of the emperor Frederick Barbarossa in 1177. It passed under the domination of Venice in 1283 and became definitely incorporated with Austria, together with the other possessions of Venice in the Istrian Peninsula, in 1813.

PIRATE AND PIRACY. Sir Edward Coke (*Instit.* iii. 113) describes a pirate (Lat. *pirata*, from Gr. *ῥαπῆς*, *rapā*, to attempt or attack) as *hostis humani generis*, and as a robber upon the sea. Sir J. Fitzjames Stephen in his *Digest of Criminal Law* defined piracy as follows: "Taking a ship on the High Seas or within the jurisdiction of the Lord High Admiral from the possession or control of those who are lawfully entitled to it and carrying away the ship itself or any of its goods, tackle, apparel or furniture under circumstances which would have amounted to robbery if the act had been done within the body of an English county" (cf. *A. G. for Hong-Kong v. Kwok-a-Sing*, 1873, L.R. 5 P.C. 179). Piracy, being a crime not against any particular state but against all mankind, may be punished in the competent court of any country where the offender may be found or into which he may be carried. But, whilst the practice of nations gives to every one the right to pursue and exterminate pirates without any previous declaration of war (pirates holding no commission or delegated authority from any sovereign or state), it is not allowed to kill them without trial except in battle. Those who surrender or are taken prisoners

must be brought before the proper tribunal and dealt with according to law.

Piracy has been dealt with in a large number of English statutes, from 1536 down to the Territorial Waters Jurisdiction Act 1878 (41 & 42 Vict. c. 73), which provided for the maintenance of the existing jurisdiction for the trial of "any act of piracy as defined by the law of nations."

During the Spanish-American War the Spanish government issued (1898) a decree declaring that "captains, masters and officers of vessels, which, as well as two-thirds of their crew, are not American, captured while committing acts of war against Spain, even if they are provided with letters of marque issued by the United States" would be regarded and judged as pirates. This was not in accordance with the international practice on the subject. A public ship or one which is entitled to fly the flag of a belligerent and navigates under the cover of state papers, by the very sense of the term, is not a pirate. Again, during the Russo-Japanese War, the word "piracy" was freely applied in British newspapers to the seizure of the "Malacca" and other vessels held up by the "Peterburg" and "Smolensk," two cruisers belonging to the Russian Black Sea volunteer fleet, which in July 1904 passed as merchantmen through the Bosphorus and Dardanelles and were transformed to their real character on the open sea. The application of the term in this case was equally inaccurate.

The conversion of merchant into war ships was one of the subjects dealt with by the second Hague Conference (1907), but it was agreed that "the question of the place where such conversion is effected remains outside the scope" of the agreement.

Piracy is essentially a crime under international law, and although any state may apply its penalties to its own subjects by analogy, as was done by Great Britain and the United States in connexion with the repression of the slave trade, they cannot be lawfully applied to subjects of other states. (T. BA.)

Historical Sketch.—It has at all times been more difficult to enforce good order on the sea than on the land; or perhaps we ought to say that the establishment of law and order on the sea has in all ages of the world's history followed, but has not accompanied, and has still less preceded, the creation of a good police on the land. The sea robber, or pirate, cannot make a profit from any part of his booty except the food which he consumes, or the vessels which he may use, unless he can find a market. But so long as he is sure that he will somewhere meet a purchaser for the goods he has taken by violence, he has every encouragement to pursue his trade. Therefore from the times described in the *Odyssey*, down to the days when Sir Henry Keppel sailed in H.M.S. "Dido" to suppress the pirates of Borneo, and when Rajah Brooke of Sarawak co-operated with him on land, we find that the prevalence of piracy and the suppression of it have been closely dependent on the efforts made to rout it out from its lurking-places on the coast, and the degree of success achieved.

Very different types of men have been named pirates. They have in fact been so unlike that to class them all together would be in the last degree unjust. The Greek in the youth of the world, and the Malay of Borneo in the 19th century, knew of no rule of morals which should restrain them from treating all who lay outside the limits of their city or their tribe as enemies, to be traded with when strong and plundered when weak. They might be patriotic, and law-abiding men towards the only authority they recognized. Their piracy was a form of war, not without close moral analogies to the seizure of Silesia by Frederick the Great, the attempted seizure of Spain by Napoleon. Indeed the story of this latter venture, with its deceitful preliminary success and its final disaster, may fairly be compared with the fall of Ulysses and his companions on the Cicones, as told in the ninth book of the *Odyssey*. Yet it would be highly uncritical to class Ulysses or Napoleon with Captain Avery, or Captain Kidd, or Bartholomew Roberts. We are not here concerned with the legal aspects of piracy, but with the true character of the persons to whom the name pirate has been applied at various times. The term was applied by the Romans

to the adventurers against whom Pompey was commissioned to act by the Gabinian Law, by the English of the 9th and 10th centuries to the Vikings, and by the Spaniards to the English, French and Dutch who were found sailing beyond the line. Sufferers by naval commerce-destroyers call it "a piratical form of warfare." But the pirates of the Roman Republic were no mere "gang of robbers." They were the victims of a time of conquest and "general overture"—"the ruined men of all nations, the hunted refugees of all vanquished parties, everyone that was wretched and daring—and where was there not misery and violence in this unhappy age? It was no longer a gang of robbers who had flocked together, but a compact soldier state, in which the freemasonry of exile and of crime took the place of nationality, and within which crime redeemed itself, as it so often does in its own eyes, by displaying the most generous public spirit." Such men are akin to the *fuorusciti* of Italian history or the Dutch Beggars of the Sea, the victims of party strife in the cities, who took to the sword because they had no other resource. *Mutatis mutandis* we may say as much for the intruders beyond the line, whom history calls the "Buccaneers" (q.v.). The "Vikings" (q.v.) were a portion of the Barbarian invasions. The "Barbary Pirates" (q.v.) stand apart. As for the piratical character of the commerce-destroyer, or privateer—why are we to brand Captain Fortunatus Wright, the Englishman who captures a French merchant ship, or Captain Robert Surcouf, the Frenchman who captures a British East Indiaman, as piratical, and not make the same reproach against Admiral Lord Howe, or Admiral Don Luis de Córdoba, who with a fleet captures whole convoys?

The pirate pure and simple is that member of an orderly community who elects to live on the sea, by violence and robbery, making no distinction between his own city or tribe and any other. The old adage that "war makes thieves and peace hangs them" has ever been peculiarly true of the sea. War has always been conducted there by the capture of an enemy's property, and by division of the spoil. A portion of the naval forces of all nations has been composed of privateers, letters of marque or corsairs, who plundered with a licence. They have ever found a difficulty in drawing the line between enemy and neutral; when peace returned some of them found it hard to be content with honest wages earned by dull industry. Nelson declared that all privateers were no better than pirates. He was borne out by the experience of Great Britain, which at the beginning of the Seven Years' War had to take strong measures to repress the excesses of its privateers, and to hang a good few of them as mere pirates. The pirates suppressed by Pompey did not all submit to remain in the settlements he made. Some continued to rob at sea. If we can trust the *Pastoral* of Longus, and the other Greek romances, the pirate was a known type even under the Roman peace, but it is highly probable that he was more of a stock literary figure than a reality. Before the Roman peace, and during long centuries after it had been shattered, piracy was common. It grew out of a state of war. In modern times—even down to 1815—a recrudescence of piracy has followed regular hostilities. But there are other conditions which have a material influence, such as the need for a lurking-place and for a receiver of the plundered goods. An archipelago provides the best lurking-places, and next to it a coast of many inlets. Therefore the Greek Islands, the British Isles, the Antilles, the Indian Ocean, the coast of Cilicia in Asia Minor, of Dalmatia, of Malabar and of Norway, have all at one time or other, and some of them for centuries, been haunts of pirates. The convenience of the place had to be completed by the convenience of the market. In the ancient world, and the middle ages, the market never failed. One city or tribe had little care for the sufferings of another. The men of the Cinque Ports who plundered the men of Yarmouth knew that their own townsmen would never call them to account, and therefore they had a safe refuge. Even when the medieval anarchy had come to an end on land, the sea was lawless. When peace was made with Spain after the death of Queen Elizabeth there were many who could not settle down to a life of industry. Some took the

plain course of betaking themselves to Algiers or Salee. But there were many who prowled nearer home. Sir William Monson, in his *Naval Tracts*, tells how he was sent in 1605 to hunt pirates out of the Shetlands and the Hebrides. He found none at sea near Scotland, but some unemployed, whom he shipped and used as guides and informers, on the coast of Ireland. At Broad Haven he discovered an Irish gentleman of the name of Cormat (presumably Cormac) living in some dignity. His house was "the well-head of all pirates," and their captains were the lovers of his daughters. Monson found agents of merchants of London and of Galway, who came to buy the goods which the pirates had to sell at a bargain. He put that interesting family under the gallows, and frightened them into turning king's evidence. It was his boast that he had cleared the Irish coast of pirates, but we know that they were common late in the reign of Charles I., and that under the name of "sea Tories" they abounded during the Civil War both in Ireland and in the Scilly Isles. Their existence was prolonged by the weakness of the government, which when piracy became very rampant took the disastrous course of offering pardon to all who would come in by a certain date. As a matter of course many did, and when their booty was spent returned to their piratical trade. Monson says that the pirates he caused to be executed had already tasted of the king's mercy. While there were friendly harbours to anchor in, purchasers to be met and a very fair prospect of a free pardon, piracy was not likely to cease.

As the 17th century drew on the law and the police became too strong for such persons as Mr Cormat at Broad Haven, and his pirate-friends. But the pirate class did not cease. It was only driven to a wider field of operations—to a field which in fact stretched from the Red Sea to New England. On this wide portion of the earth's surface everything combined to favour the pirate. In the West Indies there was a "well-head" of immense capacity. Spain was forced late and reluctantly to recognize the legitimacy of any foreign settlement. She would rather put up with the lawless adventurers known as the "Brothers of the Coast" and the "Buccaneers" than co-operate with foreign governments to suppress them. Even when she renounced her full pretensions, several of the islands remained unoccupied except by the lingering remnants of the native races. Swine and cattle had been let loose on many of them, and had multiplied. The turtle was abundant and succulent. There was no want of food. A population with predatory instincts had been formed in the early days of hostile settlement and buccaneering. Jamaica was full of the so-called "private men-of-war" whose doings are prominent in the correspondence of the early governors, who were not uncommonly their associates. Add to this that the commercial policy of Spain denied to her colonists the right of trading with foreigners, and yet that she could not supply their needs herself. Hence arose a smuggling trade which had affinities with piracy. The lawless trader was not liable to be asked awkward questions, as to the origin of his cargo, by the Spanish American who purchased it on the sly for money or by barter. Nor were any questions asked him when he brought his cargo to Jamaica, San Domingo, the Carolinas, New England or even Europe. In the decay of Spain her navy was not to be feared. But it was not the commercial policy of Spain alone which helped the pirate. Great Britain, and France also, insisted that their colonists should trade exclusively with or through them. The colonists were always ready to buy "good cheap" from the smuggler, and never ask him whether the East Indian produce—tea, silk, spices and so forth—be offered for sale were purchased or plundered in the Red Sea or on the coast of Malabar or of Coromandel. Add to all this that the police and patrol work of regular navies was but superficially done even in peace, and hardly at all in war, and that in the British colonies there was no judicial machinery for trying pirates till the 11th and 12th years of William III. (1700, 1701), and it will be seen that all the conditions favoured the pirate. In the East the decadence of the Mogul Empire was plunging India into anarchy,

and it had no navy. Yet a large native trade existed, conducted by "Moors," as they were called, and Madagascar, a great "no-man's-land," afforded ample anchorage and food. To get possession of a ship, to sail to the East, to plunder the "Moors," to sell the booty in New England or the Carolinas, to spend the produce in riotous living, and go to sea on the same errand again, was the round of life of the large class of known pirates, who formed a recognized element of the population of Massachusetts and New York at the end of the 17th century. These are the men we know best, for they were encouraged by the tolerance shown them to come into the light. Others are buried in, or only dimly visible in, obscurity. Some trace of these latter may be found in the *Letter Books* of the Old Providence Company, a puritan society formed in the reign of Charles I., of which Pym and the earl of Warwick, afterwards the Parliamentary admiral of the Civil War, were governors. It was founded to colonize Old Providence on the coast of Honduras, a place not to be confused with another pirate haunt, New Providence in the Bahamas. It took to plain piracy and was suppressed by the Spaniards in 1638. Warwick made a regular business and large profits by fitting out "privateers," which were in fact pirates on the "Spanish main," not the seas of America, as some have thought, but the coast of the mainland.

The lives of the later and better known pirates may be illustrated by the career of Captain Avery, or Every (alias Bridgman), whose renown was great at the end of the 17th century, and who has the credit of having inspired Defoe's *Life, Adventures and Piracies of Captain Singleton*. Avery was mate of a Bristol ship hired by the Spaniards in 1694 to serve as a coastguard vessel in South America. She was called the "Charles II.," commanded by one Captain Gibson, and mounted 40 guns. While the "Charles II." was lying at Corunna, in company with another vessel also hired by the Spaniards, waiting for the payment of wages which was delayed, Avery persuaded part of the two crews to seize her and sail with her on a piratical voyage to the East. The enterprise was carried out without bloodshed or, apparently, coercion of those who were unwilling to go. Avery and his crew sailed to Madagascar, a regular haunt of the pirates. Many of them ended by remaining for life among the natives. The adventurers in the "Charles II.," who had already made some small prizes, English and Danish, were joined at the island by others of the same character who had come from the West Indies. From Madagascar they went to the Straits of Bab-el-Mandeb, to lie in wait for the trade from India. Several prizes were taken, and finally a large and valuable ship, belonging "to the Great Mogul and his subjects," was captured about ten miles from Surat. Avery and his crew now hastened to New England to sell their booty. The "Charles II." was disposed of as a privateer at Providence, and the pirates bought a sloop in which they sailed along the coast of the English colonies, selling their spoil, with the consent of the colonists and the connivance of the officials, who were bribed. In an evil hour for themselves they decided to come to England. The Indian governments, exasperated by the piracy practised at the expense of their subjects, were threatening reprisals on the East India Company. The Company made complaints to the government at home, and energetic measures of repression were taken. Avery himself escaped capture, but several of his men were brought to trial, condemned and executed. It is to be noted that when first tried, on the 19th of October 1696, they were acquitted. They were, however, re-tried on other counts, on the 31st of October. The charge of Lord Chief Justice Holt to the jury, and the address of Sir Charles Hedges, the admiralty judge, shows that they felt both the importance and the uncertainty of securing a verdict.

The cruise of Avery is not only a typical example of a piratical venture, but it is an important date in the history of the policing of the sea. The English government was roused to a sense of the necessity for strong measures to repress piracy. All the steps taken were not according to knowledge. The extraordinary private venture of Lord Bellamont and his associates who sent out Captain Kidd (q.v.), a man of piratical antecedents,

to suppress pirates in the Eastern seas, brought deserved discredit upon them. The decision taken on the advice of Burchett, the secretary of the admiralty, to offer a pardon to all who would surrender by a given date—for all piracies committed before the 30th of April to the east of the Cape of Good Hope, and the 30th of June 1699 to the west—was an error. It induced many to come in, but it also gave all pirates the hope that they would in the future be provided with similar means of escape. The establishment of admiralty courts in the East Indies and America and the despatch of warships were more effectual methods. Yet it was long before piracy was thoroughly checked; indeed the signing of the Peace of Utrecht was followed by a recrudescence of this form of crime. The privateers who swarmed in the West Indies and, as long as the war lasted, used, in the phrase of the time, to join the squadrons of war-ships "on the plundering account," could not settle down to dull industry. They leagued themselves into a species of pirate republic, with its capital at Providence in the Bahamas. In 1718 a special force had to be sent against them under Woodes Rogers, who is best remembered now for having taken Alexander Selkirk from the island of Juan Fernandez, in the course of a privateering voyage into the Pacific with the "duke" and "duchess" of Bristol. Rogers broke up the Providence settlement, and did a similar piece of service on the coast of Madagascar. Piracy did not, however, die. The Asiento (q.v.) Treaty having given Great Britain a monopoly of the slave trade with Spanish America, the monopolists, i.e. the South Sea Company and Royal African Company, were of course subject to the competition of interlopers. The interlopers were the natural friends of the pirates, who divided their activity between the Antilles and the west coast of Africa, plundering in the second, selling and re-fitting, not without further plunder, in the first. The most notorious of these freebooters was Bartholomew Roberts, who was introduced to piracy by Howel Davis. Roberts was the nearest known approach to the pirate of romance, ostentatious, brave, not without touches of generosity. He was killed in action with Captain Chaloner Ogle, of H.M.S. "Swallow," on the coast of Africa, in 1722.

As the American colonies grew more settled piracy became intolerable to them. Yet it lingered on the coast of North Carolina, where the pirates could either terrorize the scattered inhabitants, or were encouraged by dishonest officials. Here flourished the grotesque brute known as Blackbeard, Edward Teach, till he was run down and slain by Lieut. Milvain in 1718. It was noted that several of those who helped to suppress him afterwards "went a-pirating" themselves. So strong was the piratical tradition of the New World that even men of some standing fell into it. "Major" or Captain Stede Bonnet, who was condemned and executed at Charleston, South Carolina, as a pirate, in 1718, was a gentleman of some property in Barbadoes, who first ventured to sea in a ship of his own. Stede Bonnet had taken advantage of an act of grace, had come in on a proclamation, and had returned to a pirate's life. The last great explosion of piracy in the West Indies followed the peace of 1815. Here again we find the old conditions—privateers and other unsettled men, the safe lurking-place and the receiver. The refuge and the market were supplied by the Spanish colonies, which were plunged into anarchy by their revolt against Spain. The pirates were able to masquerade as "patriot" navies. The aboth and corruption of Spanish captains-general of Cuba were no less favourable to the pirates. The south coast of the island became a haunt of these villains till the British and American governments were driven to combine for their suppression. When they had been followed into their hiding-places and their vessels sunk, they took to brigandage on land, and were garrotted by the Spanish authorities in self-defence. The piracy of the Greek islands went on to later years, and the Malays were not tamed till nearly 1850. On the coast and the rivers of China piracy was and is endemic, but the sailing junk has no chance with the modern steamer. When cases of piracy have occurred in the Straits of Malacca or in the China seas,

by which Europeans have been the sufferers, the crime has generally been perpetrated by men who shipped as passengers or as crew, and who surprised the vessel. The pirate has been as useful to the author of modern tales and poems as to the writers of the Greek romances. When he is seen in authentic evidence he is found to have been for the most part a pitiful rogue. His gains were but small. A share of £200 was wealth to a mere sailor, and one of £1000 wealth beyond the dreams of avarice. He rarely fought a warship if he could help it, and indeed nothing is more surprising than his readiness to surrender when the fate before him was the gallows.

AUTHORITIES.—The pirates of the ancient world are admirably dealt with in Mommsen's *History of Rome*. For the modern pirate, see Monson's "Naval Tracts" in *Churchill's Voyages*, v. 5 (London, 1744-1746), and in the edition of the Navy Record Society (1902). But the best accounts are to be found in the *State Trials*, vols. xiii., xiv., xv (London, 1812). Captain Charles Johnson's *General History of the Pyrates* (London, 1724) must be used with caution. He no doubt learnt much from pirates who, having come in on a proclamation, were free to talk, but he cannot always be reconciled with authentic records. The *Documents relative to the Colonial History of the State of New York* (Albany, 1856-1858) contain many curious details. For the eastern seas, the *Compendious History of the Indian Wars; with an account of the Rise, Progress, Strength and Forces of Angria, the Pyrate, &c.*, by Clement Downing (London, 1737) is useful. (D. H.)

PIRKE ABOTH. The penultimate tract of the fourth part of the Mishnah is the booklet of proverbs in five chapters called *Masseketh Aboth* (*tractatus patrum*), better known with a sixth chapter as *Pirke Aboth* (*capitula patrum*). For *Pirke Aboth* in English see *The Authorized Daily Prayer Book of the united Hebrew congregations of the British Empire*, with a new translation by the Rev S. Singer. The six chapters are there appointed to be read one on each Sabbath afternoon between Passover and New Year. Formerly they were read, in places at least, on the six Sabbaths between Passover and Pentecost only. The subsections of the chapters are hereinafter numbered as in the Authorized Prayer Book.

Chapters i., ii.—The Mosaic succession has first to be established, Moses (i., 1-3) having received the Torah from Sinai, it was handed down to Joshua, the Elders (Josh. xxiv. 31), the Prophets and the men of the Great Synagogue, from one of the last of whom, Simon Justus, it was received by Antigonus of Socho. Next are named (i. 4-15), without any title, as links in the chain of tradition, five pairs of teachers, the last Hillel and Shammai, elsewhere in the Mishnah called *mundi patres* (Surent. iv. 321). Rabban Jochanan ben Zaichai (ii. 9) "received from Hillel and Shammai." Sayings of Jochanan and his five disciples follow, and chap. ii. ends with words of their somewhat younger contemporary, Rabbi Tarphon (Trophon), to the effect *Avos longa vita brevis*. These sections (i. 1-15, ii. 9-21) contain the "Kern der Sammlung" (Strack). After the sayings of Shammai (i. 15) come interpolated sayings (i. 16-ii. 8) of Rabban Gamaliel I., Rabban Simon, "Rabbi," i.e. R. Jehudah ha-Nasi (cent. A.D. 1-2), the traditional redactor of the Mishnah, Rabban Gamaliel II. and Hillel, which break the sequence.

Chapters iii., iv.—Maxims of numerous authorities, mostly Mishnah teachers and called Rabbis (Matt. xxii. 7 seq.; J. P. p. 27), not in exact chronological order.

Chapters v., vi.—Chap. v. which is *sed genericis*, is presumably of later date than what precedes. Naming no teacher until the end, it combines historical, legendary and didactic elements. It touches upon the miraculous and its place in nature (v. 9). In form it is a series of numbered groups of things, from the ten creative Sayings to the triads of qualities which differentiate the disciples of Balaam and Abraham. R. Jacob ben Shimshon's commentary makes Aboth end with the saying of Jehudah ben Tema (v. 23), "Be bold as a leopard, and swift as an eagle, and fleet as a hart, and strong as a lion, to do the will of thy Father who is in heaven." Chapter vi., on *acquistio legis*, is thought to have been added for use on the last of the six sabbaths above-mentioned (Strack, J. P. p. 61). In some manuscripts there are seven chapters.

Pirke Aboth serves as a primer to the student of rabbinic Judaism. For the most part in simple Hebrew, it has a few sayings in Aramaic (i. 13-ii. 7, v. 25, 26) and some adopted Greek words, as *paraclete* (iv. 13; Philo). He who would be pious should fulfil the dicta of Aboth (Baba Kam. 30a). It gives favourite aphorisms of leading Jewish teachers who flourished in or before the earliest Christian centuries, and supplies material for some interesting illustrations of the New Testament. Too heterogeneous to be represented by a few extracts, the collection

must be read through to be appreciated. Among the sayings of Hillel we miss the best known one, *What is hateful to thee do not, &c.* (J. F. p. 142), with which we may now compare Ecclus. xxxi. 15 Heb., "Know (?) thy neighbour is as thyself, and consider what thou hatest." Of the precept, "Make a fence to the Torah" (i. i; cf. iii. 17) it may be said that "everything is therein." As a doctrine of development and as an ethical principle it is reflected in Clement of Alexandria's view of philosophy as a *φραγμός* of the vineyard (Strom. i. 20), and Polycarp's saying, "He that has love is far from all sin." The use of Aboth in the synagogue stamps it as authoritative, and, with its intrinsic excellence, has led to its being "the most popular of all rabbinical writings." For midrashic comments upon it see the Aboth of Rabbi Nathan (ed. S. Schechter, Vienna, 1887), or the rendering of it (new ed., New York, 1900) in M. L. Rodkinson's translation of the Babylonian Talmud into English. (See also APOCRYPHAL LITERATURE, § *Old Testament*, II. d.)

BIBLIOGRAPHY.—Aboth is included in editions of the Mishnah and the Talmud Babil. and in many prayer-books. For separate editions from about 1484–1485, see Moritz Steinschneider's *Bodleian Catalogus*, col. 228–239, 2785, and other works cited in Herm. L. Strack's very useful *Die Sprache der Vater* (ed. 3, 1901). See also C. Taylor's *Sayings of the Jewish Fathers* (ed. 2, 1897, referred to above as *J. F.*); a separate *Appendix* (1900) describes or enumerates manuscripts of Aboth—and *Jewish Encyclopaedia*, art. "Aboth." (C. T. *)

PIRMASENS, a town of Germany, in the Bavarian Palatinate, 40 m. W. by S. of Spire, on the railway from Biebermühle. Pop. (1905), 34,002. The only noteworthy buildings are the town-hall and the principal Evangelical church, which contains a fine monument to Louis IX. (d. 1790), landgrave of Hesse-Darmstadt, who made the town his residence. The staple industry is the production of boots and shoes; but musical instruments, leather and machines are also manufactured. Pirmasens owes its name to a St Pirmin, who is said to have preached Christianity here in the 8th century. It originally belonged to the count of Hanau-Lichtenberg, but passed to Hesse-Darmstadt in 1736. In September 1793 the Prussians gained a victory here over a body of French troops.

See T. Weiss, *Pirmasens in der Franzosenzeit* (Pirmasens, 1905).

PIRMEZ, OCTAVE (1832–1883), Belgian author, was born at Châtelineau in 1832. He belonged to a well-known Belgian family, and his cousin, Edouard Pirmez, was distinguished for his works on literary and political subjects. He lived an uneventful life at his château of Acoz, in Hainaut, where he died in May 1883. Pirmez was an ardent admirer of the French romanticists. His works include *Les Feuilles: pensées et maximes* (1862); *Victor Hugo* (1863); *Jours de solitude* (1866); *Rêve; Souvenirs d'un frère* (1880); *Heures de philosophie* (1881); and the posthumous *Lettres à José* (1884). These books form a history of his emotional life, and reveal an extreme melancholy.

See *Vie et correspondance d'Octave Pirmez* (1888), by Adolphe Siret and José de Coppin.

PIRNA, a town in the kingdom of Saxony, on the left bank of the Elbe, 11 m. above Dresden, and on the railway to Bodenbach and Prague. Pop. (1905), 19,220. The town is regularly built, with promenades covering the site of the old fortifications; the most notable edifices are the fine Gothic parish church, built in the 16th century and restored in 1890, and the old town-hall. Excellent sandstone is found on both banks of the Elbe. There are manufactures of glass, machinery, cigars, pottery and enamelled goods; and there is a trade in grain, fruit and timber, mainly carried on by river, and a little shipbuilding. Pirna, originally a Slavonic settlement, was for many years in the alternate possession of Bohemia and Meissen, but it became permanently united with the latter, and thus with Saxony, in 1405. The Sonnenstein, a fortress on a commanding eminence above the town, was erected in the 16th century on the site of an older castle by the elector of Saxony, Augustus I. It was once considered the most important fortress on the Elbe, and successfully withstood the Swedes in 1639, but it was captured and dismantled by the Prussians in 1758, and in 1813 was occupied by the French.

See R. Hofmann, *Zur Geschichte der Stadt Pirna* (Pirna, 1890); E. Künzel, *Führer durch Pirna* (Pirna, 1890); the *Urbuch der Stadt Dresden und Pirna*, edited by C. F. von Poser-Klett (Leipzig, 1875); and the publications of the *Veren für Geschichte der Stadt Pirna* (Pirna, 1897 seq.).

PIROGUE, or **PIRAGUA** (the French and Spanish forms respectively of a Caribbean word for this type of vessel, it has at various times taken many corrupt forms, e.g. *perriagua*, *pettiagua*, *pettyogar*), originally the native name of a vessel made by hollowing out the trunk of a tree, a "dug-out"; hence applied to many different developments of this type of vessel used in the West Indies and along the American coast. An early improvement was to split the "dug-out" into two sections and insert a flat bottom of planking to widen it; another form had a leeboard, was decked in at either end, and had two masts.

PIRON, ALEXIS (1689–1773), French epigrammatist and dramatist, was born at Dijon on the 6th of July 1689. His father, Aimé Piron, was an apothecary, who wrote verse in the Burgundian patois. Alexis began life as clerk and secretary to a banker, and then studied law. In 1710, when nearly thirty years old, he went to seek his fortune at Paris. An accident brought him money and notoriety. The jealousy of the regular actors produced an edict restricting the Théâtre de la Foire, or licensed booths at fair times, to a single character on the stage. None of the ordinary writers for this theatre would attempt a monologue-drama for the purpose, and Piron made a great success with a piece called *Arlequin Deucalion*, representing Deucalion immediately after the Deluge, amusing himself with recreating in succession the different types of man. In 1728 he produced *Les Fils ingrats* (known later as *L'École des pères*) at the *Comédie Française*. He attempted tragedy in *Callistobus* (1730), *Gustave Vasa* (1733) and *Fernand Cortès* (1744), but none of these succeeded, and Piron returned to comedy with *La Mère-souris* (1738), in which the hero, Damis, suffers from the versé mania. His most intimate associates at this time were Mlle Quinault, the actress, and her friend Marie Thérèse Quinault, known as Mlle de Bar. This lady was slightly older than Piron and not beautiful, but after twenty years' acquaintance he married her in 1741. He died on the 21st of January 1773 in his eighty-fourth year. He was elected in 1753 to the Academy, but his enemies raked up a certain *Ode à Priape*, dating from his early days, and induced Louis XV. to interpose his veto. Piron however was pensioned, and during the last half-century of his life was never in any want. His best title to remembrance lies in his epigrams. The burlesque epitaph on himself, in which he ridicules the Academy—

"C'est Piron, qui ne fut rien.
Pas même académicien."

is well-known, while many others are as brilliant. Grimm called him a "machine à saillies."

Piron published his own theatrical works in 1758, and after his death his friend and literary executor, Rigoley de Juvigny, published his *Œuvres complètes*. M. Bonhomme produced a critical edition in 1899, completed by *Poésies choisies et pièces inédites* in 1899.

PIROT (Turkish *Shehr-Koçy*), a Servian town, 12½ m. from the Bulgarian frontier at Tzaribrod, on the railway line between Nish and Sofia. Pop. (1900), 10,428. Pirot is the seat of the prefecture for the department of the same name, with a tribunal, several schools and a custom-house. It is the only proper industrial town in Servia, having numerous small factories for the manufacture of thin cloth (*shayak*), woollen braid (*eyonak*), and especially carpets. Its carpets have a great reputation in the Balkan Peninsula for their quaint designs, durability and freshness of colour. Pirot has a medieval fortress, believed to have been built on the site of the Roman fortress *Quimadone*, on the military road leading from Old Naissus to Philippopolis. The town is of great strategical importance, for which reason the Russian plenipotentiaries at the Berlin congress (1878) stubbornly tried to include it within the Bulgarian frontier, while Austria and some other Powers insisted that it should be given to Servia. In the war between Servia and Bulgaria in 1885 the Bulgarians occupied and held it until the conclusion of peace.

PISA, a town, archiepiscopal see and capital of a province of the same name, Tuscany, Italy, on the Arno, 7 m. from the sea and 49 m. west of Florence by rail. Pop. (1881), 42,779; (1900), 61,279. It still retains its ancient walls, 6½ m. in circuit, and is defended by a citadel on the south-west. The principal streets run alongside the river, and are lined with fine buildings. Besides the cathedral, the baptistery and the famous leaning tower, the city possesses several notable churches, as the Renaissance church of the Tuscan order of St Stephen, built in 1562 from plans by Vasari; San Niccolò, with a four-storeyed tower (1230), built by Niccolò Pisano, and the tomb of John of Swabia, the parricide; Santa Caterina (1262); Santa Maria della Spina, in the Italo-Gothic style, built in 1230 and restored in 1872; San Sepolchero, erected in 1150 by Diotisalvi; San Francesco, with frescoes by Taddeo Gaddi; and the basilica of San Michele (1018). Amongst the secular buildings may be mentioned the royal palace; the archiepiscopal palace; the palace of the order of St Stephen, built by Niccolò Pisano and reconstructed by Vasari; the Upezzinghi (formerly Lanfreducci) palace, built of Carrara marble in 1590; the Lanfranchi, Agostini and other palaces; the university (1472); a large hospital (1258); and fine market halls. There are statues to Cosimo I. (by Francavilla), Archduke Leopold, and Ferdinand I. The city possesses also an academy of the fine arts, with a gallery of paintings; and the university a library of 120,000 volumes, a natural history museum, botanical garden and agricultural schools. The university, founded in 1338, has faculties of law, medicine, mathematics and philosophy and literature, and is to this day one of the most famous in Italy.

The architects of the cathedral were Boschetto and Rinaldo, both Italians, probably Pisans. It is in plan a Latin cross, with an internal length of 311½ ft. and a breadth of 252 ft. The nave, 100 ft. high, has double vaulted aisles and the transepts single aisles; and at the intersection of nave and transepts there is a cupola. The basilica is still the predominant type, but the influence of the domed churches of Constantinople and the mosques of Palermo is also apparent. The pillars which support the nave are of marble from Elba and Giglio, those of the side aisles are the spoils of ancient Greek and Roman buildings brought by the Pisan galleys. Externally the finest part of the building is the west front, in which the note struck by the range of arches running round the base is repeated by four open arcades. Of the four doors three are by John of Bologna, who was greatly helped by Francafilza, Tacca and others; that of the south side, of much older date, is generally supposed to be the work of Bonanno. Of the interior decorations it is enough to mention the altars of the nave, said to be after designs by Michelangelo, and the mosaics in the dome and the apse, which were among the latest designs of Cimabue. The baptistery was completed only in 1278, and marred in the 14th century by the introduction of Gothic details. The building is a circle 100 ft. in diameter, and is covered with a cone-surmounted dome 190 ft. high on which stands a statue of St Raniero. The lowest range of semicircular arches consists of twenty columns and the second of sixty; and above this is a row of eighteen windows in the same style separated by as many pilasters. In the interior, which is supported by four pilasters and eight columns, the most striking features are the octagonal font and the hexagonal pulpit, erected in 1260 by Niccolò Pisano. The campanile or "leaning tower of Pisa" is a round tower, the noblest, according to Freeman, of the southern Romanesque. Though the walls at the base are 13 ft. thick, and at the top about half as much, they are constructed throughout of marble. The basement is surrounded by a range of semicircular arches supported by fifteen columns, and above this rise six arcades with thirty columns each. The eighth storey, which contains the bells, is of much smaller diameter than the rest of the tower, and has only twelve columns. The height of the tower is 179 ft., but the ascent is easy by a stair in the wall, and the visitor hardly perceives the inclination till he reaches the top and from the lower edge of the gallery looks "down" along the shaft receding to its base. The tower leans or deviates from the perpendicular, to a striking extent, which has gradually increased; it was 1½ ft. out of the perpendicular when measured in 1829, and 16½ ft. in 1910. There is no reason to suppose that the architects, Bonanno and William of Innsbruck, intended that the campanile should be built in an oblique position; it would appear to have assumed it while the work was still in progress. The foundations are not more than 10 ft. deep, and their circumference only that of the tower. The Campo Santo, lying to the north of the cathedral, owes its origin to Archbishop Ubaldo

¹ In Strabo's time it was only 2 m. away, but the increase of the delta at the mouth of the river has since then pushed forward the coast-line.

(1188-1200), who made the spot peculiarly sacred by bringing fifty-three shiploads of earth from Mount Calvary. The building, erected in the Italian Gothic style between 1278 and 1283, by Giovanni Pisano, is of special interest chiefly for its famous frescoes.

There are numerous industries, the most important being the manufacture of cottons. In the vicinity are the royal stud-farm (horses and dromedaries) of Cascine di San Rossore, and the mineral baths of San Giuliano, alkaline-ferruginous, with temperature 91.4° to 105.8° Fahr. At the mouth of the Arno, joined to the city by a steam tramway, is the seaside resort of Marina di Pisa, also known as Bocca d'Arno, a well-known centre for landscape painters.

The old town occupied the site of the ancient Pisae on the right bank of the Arno. The foundation of Pisae is by tradition ascribed to a very remote period, and it was often (possibly only owing to the similarity of name) believed to have been founded from Pisae in Elis. It is first mentioned in history as the place at which a Roman army from Sardinia landed in 225 B.C., its harbour being at the mouth of the south branch of the Arno, north of Livorno. Being situated on the coast road (Via Aemilia) it was important as a frontier fortress against Liguria, to which, and not to Etruria, it really belonged, perhaps, up to the time of Sulla, the actual boundary lying between it and Vada Volaterrana (mod. Vada). It became a colony in 180 B.C., and was important for the fertility of its territory, for its quarries, and for the timber it yielded for ship-building. Augustus gave it the name of Colonia Julia Pisana, his grandsons Gaius and Lucius were patrons of the colony, and after their death monuments were erected in their honour, as is recorded in two long inscriptions still extant. Greek vases have been found within the city itself, seeming to point to the presence of Etruscan tombs (G. Ghirardini in *Notizie degli Scavi*, 1892, 147); but no remains now exist except of the Roman period—some scanty ruins of baths and of a temple, while the Piazza dei Cavalieri follows the outline of the ancient theatre.

See E. Bormann, *Corp. Inscr. lat. xi. 272* (1888).

Little is known of the history of Pisa during the barbarian invasions, but it is an ascertained fact that it was one of the first towns to regain its independence. Under the Byzantine dominion Pisa, like many other of the maritime cities of Italy, profited by the weakness of the government at Constantinople to reassert its strength. And even during the first years of the harsh Lombard rule the need recognized by these oppressors of defending the Italian coast from the attacks of the Byzantines was favourable to the development of the Pisan navy. Few particulars are extant concerning the real condition of the town; but we occasionally find Pisa mentioned, almost as though it were an independent city, at moments when Italy was overwhelmed by the greatest calamities. According to Amari's happy expression, "it was already independent by sea, while still enslaved on land." Its prosperity notably declined after the establishment of the Lombard rule and under the Franks. It again began to flourish under the marquises of Tuscany, who governed it in the name of the emperor.

In 1003 we find records of a war between Pisa and Lucca, which, according to Muratori, was the first waged between Italian cities in the middle ages. But the military development and real importance of Pisa in the 11th century must be attributed to the continuous and desperate struggle it maintained against the tide of Saracenic invasion from Sicily. And, although the numerous legends and fables of the old chroniclers disguise the true history of this struggle, they serve to attest the importance of Pisa in those days. In 1004 the Saracens forced the gates and sacked a quarter of the town; and in 1011 they renewed the attack. But the Pisans repulsed them and assumed the offensive in Calabria, Sicily, and even in Africa. Still more memorable was the expedition afterwards undertaken by the united forces of Pisa and Genoa against Mogahid, better known in the Italian chronicles as Mugeto. This Moslem chief had made himself master of Sardinia, and was driven thence by the allied fleets in 1015. Again invading the island, he was again attacked and defeated by the same adversaries, leaving a

brother and son, or, as some authorities aver, a wife and son, prisoners in their hands. Sardinia continued to be governed by native "judges" who were like petty sovereigns, but were now subject to the sway of Pisa. This was the primary cause of the jealousy of the Genoese, and of the wars afterwards made by them upon Pisa and carried on until its power was crushed. Meanwhile the Pisans flourished more and more, and continued hostilities against the Saracens. In 1062 their ships returned from Palermo laden with spoil. Thus it is not surprising that Pisa should already have had its own code of laws (*Consuetudini di mare*), which in 1075 were approved by Gregory VII., and in 1081 confirmed by a patent from the emperor Henry IV., a document which mentions for the first time the existence of a magistrate analogous to the consuls of the republic, although the latter, according to some writers, already existed in Pisa as early as the year 1080, the point, however, is doubtful, and other writers place the first authentic mention of the consuls in the year 1094.¹ The oldest of Pisan statutes still extant is the *Brevi dei consoli di mare* of 1162.

In 1099 the Pisans joined in the second crusade, proved their valour at the capture of Jerusalem, and derived many commercial advantages from it; for within a short time they had banks, consuls, warehouses and privileges of all kinds in every Eastern port. Thus, while the commune of Pisa was still under the rule of the marquises of Tuscany, all negotiations with it were carried on as with an independent state officially represented by the archbishop and consuls. The aristocrats were the dominant party, and filled the highest offices of the republic, which, in the 12th century, rose to great power, both on sea and land, by its wars with the Lucchese, Genoese and Moslems. In 1110 Pisa made peace with Lucca after six years of continuous hostilities. And in the years 1113 and 1115 it achieved a still greater enterprise. The Pisan fleet of three hundred sail, commanded by the archbishop Pietro Moriconi, attacked the Balearic Isles, where as many as 20,000 Christians were said to be held captive by the Moslems, and returned loaded with spoil and with a multitude of Christian and Moslem prisoners. The former were set at liberty or ransomed, and among the latter was the last descendant of the reigning dynasty. The chief eunuch who had governed Majorca perished in the siege. Immediately afterwards the fourteen years' war with Genoa broke out. The two republics contested the dominion of the sea, and both claimed supreme power over the islands of Corsica and Sardinia. A papal edict awarding the supremacy of Corsica to the Pisan church proved sufficient cause for the war, which went on from 1118 to 1132. Then Innocent II. transferred the supremacy over part of Corsica to the Genoese church, and compensated Pisa by grants in Sardinia and elsewhere. Accordingly, to gratify the pope and the emperor Lothair II., the Pisans entered the Neapolitan territory to combat the Normans. They aided in the vigorous defence of the city of Naples, and twice attacked and pillaged Amalfi, in 1135 and 1137, with such effect that the town never regained its prosperity. It has been said that the copy of the Pandects then taken by the Pisans from Amalfi was the first known to them, but in fact they were already acquainted with those laws. The war with Genoa never came to a real end. Even after the rctaking of Jerusalem by the Moslems (1187) the Pisans and Genoese again met in conflict in the East, and performed many deeds of valour. They were always ready to come to blows, and gave still more signal proofs of their enmity during the Sicilian War in behalf of the emperor Henry VI. From that moment it was plain that there could be no lasting peace between these rival powers until the one or the other should be crushed. The greatness and wealth of the Pisans at this period of their history is proved by the erection of the noble buildings by which their city is adorned. The founda-

¹ It must be remembered that the Pisans and Florentines dated the beginning of the year *ab incarnatione*, i.e. from the 25th of March. But the Florentines dated it from the 25th following and the Pisans from the 25th of March preceding the commencement of the common year. The new or common style was adopted throughout Tuscany in the year 1250.

tions of the cathedral were laid in 1063, and its consecration took place in 1118, the baptistry was begun in 1152, and the campanile (the famous leaning tower) in 1174. And all three magnificent structures were mainly the work of Pisan artists, who gave new life to Italian architecture, as they afterwards renewed the art of sculpture.

It is asserted by some writers, especially by Tronci, that in the 12th century Pisa adopted a more democratic form of government. But in fact the chief authority was still vested in the nobles, who, both in Pisa and in Sardinia, exercised almost sovereign power. They formed the real strength of the republic, and kept it faithful to the empire and the Ghibelline party. The Guelph and popular element which constituted the force and prosperity of Florence was hostile to Pisa, and led to its downfall. The independence of the former city was of much later origin, only dating from the death of Countess Matilda (1115), but it rapidly rose to an ever-increasing power, and to inevitable rivalry with Pisa. Owing to the political and commercial interests binding Florence to the Roman court, the Guelph element naturally prevailed there, while the growth of its trade and commerce necessarily compelled that state to encroach on waters subject to Pisan rule. And, although Pisa had hitherto been able to oppose a glorious resistance to Genoa and Lucca, it was not so easy to continue the struggle when its enemies were backed by the arms and political wisdom of the Florentines, who were skilled in obtaining powerful allies. The chroniclers ascribe the first war with Florence, which broke out in 1222, to a most ridiculous motive. The ambassadors of the rival states in Rome are said to have quarrelled about a lapdog. This merely shows that there were already so many general and permanent reasons for war that no special cause was needed to provoke it. In 1228 the Pisans met and defeated the united forces of Florence and Lucca near Barga in the Garigliana, and at the same time they despatched fifty-two galleys to assist Frederick II. in his expedition to the East. Shortly after this they renewed hostilities with the Genoese on account of Sardinia. The judges who governed the island were always at strife, and, as some of them applied to Pisa and some to Genoa for assistance against one another, the Italian seas were once more stained with blood, and the war burst out again and again, down to 1259, when it terminated in the decisive victory of the Pisans and the consolidation of their supremacy in Sardinia. But meanwhile Florence had made alliance with Genoa, Lucca and all the Guelph cities of Tuscany against its Ghibelline rival. The pope had excommunicated Frederick II. and all his adherents. And, as a crowning disaster, the death of Frederick in 1250 proved a mortal blow to the Italian Ghibelline cause. Nevertheless, the Pisans were undaunted. Summoning Siena, Pistoia and the Florentine exiles to their aid, they boldly faced their foe, but were defeated in 1254. Soon after this date we find the old aristocratic government of Pisa replaced by a more popular form. Instead of the consuls there were now twelve elders (*ansiani*); besides the podestà, there was a captain of the people; and there was a general council as well as a senate of forty members. The rout of the Tuscan Guelphs on the field of Montapertoso (1260) restored the fortunes of Pisa. But the battle of Benevento (1266), where Manfred fell, and the rout of Tagliacozzo (1268), sealing the ruin of the house of Hohenstaufen in Italy and the triumph of that of Anjou, were fatal to Pisa. For the republic had always sided with the empire and favoured Conradin, whose cruel end struck terror into the Ghibelline faction. The pope hurled an edict against the Pisans and tried to deprive them of Sardinia, while their merchants were driven from Sicily by the Angevins. The internal condition of the city was affected by these events. Owing to the increasing influence of the Guelph and popular side, to which the more ambitious nobles began to adhere for the furtherance of personal aims, the aristocratic Ghibelline party was rapidly losing ground. The first man to step to the front at this moment was Count Ugolino della Gherardesca of the powerful house of that name. He had become the virtual head of the republic, and, in order to preserve its independence and his own sway, inclined to the

Guelphs and the popular party, in spite of the Ghibelline traditions of his race. He was supported by his kinsman Giovanni Visconti, judge of Gallura; but almost all the other great families vowed eternal hatred against him, and proclaimed him a traitor to his party, his country and his kin. So in 1274 he and Visconti were driven into exile. Both then joined the Florentines, took part in the war against their native city, and laid waste its surrounding territories. In 1276 the Pisans were compelled to agree to very grievous terms—to exempt Florentine merchandise from all harbour dues, to yield certain strongholds to Lucca, and to permit the return of Count Ugolino, whose houses they had burnt, and whose lands they had confiscated. Thus the count again became a powerful leader in Pisa. Visconti, however, was dead.

This was the moment chosen by Genoa for a desperate and decisive struggle with her perpetual rival. For some years the hostile fleets continued to harass each other and engage in petty skirmishes, as if to measure their strength and prepare for a final effort. On the 6th of August 1284 the great battle of Meloria took place. Here seventy-two Pisan galleys engaged eighty-eight Genoese, and half the Pisan fleet was destroyed. The chroniclers speak of 5000 killed and 11,000 prisoners; and, although these figures must be exaggerated, so great was the number of captives taken by the Genoese as to give rise to the saying—"To see Pisa, you must now go to Genoa." This defeat crushed the power of Pisa. She had lost her dominion over the sea, and the Tuscan Guelphs again joined in attacking her by land. Count Ugolino had taken part in the battle of Meloria and was accused of treachery. At the height of his country's disasters he sought to confirm his own power by making terms with the Florentines, by yielding certain castles to Lucca, and by neglecting to conclude negotiations with the Genoese for the release of the prisoners, lest these should all prove more or less hostile to himself. This excited a storm of opposition against him. The archbishop Ruggieri, having put himself at the head of the nobles, was elected podestà by the Lanfranchi, Sismondi and Gualandi, and a section of the popular party. The city was plunged into civil war. The great bell of the commune called together the adherents of the archbishop; the bell of the people summoned the partisans of the count. After a day's fighting (July 1, 1288) the count, his two sons and his two grandsons were captured in the palazzo del popolo (or town hall), and cast into a tower belonging to the Gualandi and known as the "Tower of the Seven Streets." Here they were all left to die of hunger. Their tragic end was afterwards immortalized in the *Divina commedia*. The sympathies of Dante Alighieri, the Florentine patriot and foe of Rome, were naturally in favour of the victims of an aristocratic prelate, opposed to all reconciliation with Florence.

The Florentines were now allied with Lucca and Genoa, and a few of their vessels succeeded in forcing an entry into the Pisan port, blocked it with sunken boats, and seized its towers. Their own internal dissensions of 1293 put a stop to the campaign, but not before they had concluded an advantageous peace. They and all the members of the Guelph league were freed from all imposts in Pisa and its port. In addition to these privileges the Genoese also held Corsica and part of Sardinia; and throughout the island of Elba they were exempted from every tax. They likewise received a ransom of 160,000 lire for their Pisan prisoners. These were no longer numerous, many having succumbed to the hardships and sufferings of all kinds to which they had been exposed.

In 1312 the arrival of the emperor Henry VII. gladdened the hearts of the Pisans, but his sudden death in 1313 again overthrew their hopes. He was interred at Pisa, and Ugucione della Faggiuola remained as imperial lieutenant, was elected podestà and captain of the people, and thus became virtual lord of the city. As a Ghibelline chief of valour and renown he was able to restore the military prestige of the Pisans, who under his command captured Lucca and defeated the Florentines at Montecatini on the 29th of August 1315. So tyrannical, however, was his rule that in 1316 he was expelled by the popular fury. But

Pisa's freedom was for ever lost. He was succeeded by other lords or tyrants, of whom the most renowned was Castruccio Castracane, a political and military adventurer of much the same stamp as Ugucione himself. With the help of Louis the Bavarian, Castruccio became lord of Lucca and Pisa, and was victorious over the Florentines, but his premature death in 1328 again left the city a prey to the conflicts of opposing factions. New lords, or petty tyrants, rose to power in turn during this period of civil discord, but the military valour of the Pisans was not yet extinguished. By sea they were almost impotent—Corsica and Sardinia were lost to them for ever; but they were still formidable by land. In 1341 they besieged Lucca in order to prevent the entry of the Florentines, to whom the city had been sold for 250,000 florins by the powerful Mastino della Scala. Aided by their Milanese, Mantuan and Paduan allies, they gave battle to their rivals, put them to rout at Altopiscio (Oct. 2), and then again excluded them from their port. Thereupon the Florentines obtained Porto Talamone from Siena and established a navy of their own. By this means they were enabled to capture the island of Giglio, and, attacking the Pisan harbour, carried off its chains, bore them in triumph to Florence, and suspended them in front of the baptistery, where they remained until 1348. Then, in pledge of the brotherhood of all Italian cities, they were given back to Pisa, and placed in the Campo Santo.

The war was now carried on by the free companies with varying fortune, but always more or less to the hurt of the Pisans. In 1369 Lucca was taken from them by the emperor Charles IV.; and afterwards Giovanni Galeazzo Visconti, known as the count of Virtù, determined to forward his ambitious designs upon the whole of Italy by wresting Pisa from the Gambacorti. For at this time the conflicts of the Raspanti faction, headed by the Gherardesca, with the Bergolini led by the Gambacorti, had left the latter family masters of the city. At Visconti's instigation Piero Gambacorti, the ruler of the moment, was treacherously assassinated by Jacopo d'Appiano, who succeeded him as tyrant of Pisa, and bequeathed the state to his son Gherardo. The latter, a man of inferior ability and daring, sold Pisa to the count of Virtù, receiving in exchange 200,000 florins, Piombino, and the islands of Elba, Pianosa and Monte Cristo. Thus in 1399 Visconti took possession of Pisa, and left it to his natural son Gabriele Maria Visconti, who was afterwards expelled from its gates. But even during this century of disaster the Pisans continued to cherish not only commerce, but also the fine arts. In the year 1278 they had entrusted the erection of their fine Campo Santo to Niccolò and Giovanni Pisano, by whom the architectural part of it was completed towards the end of the century. In the following year the first artists of Italy were engaged in its decoration, and the celebrated frescoes attributed to Orcagna (*q.v.*) were painted on its walls. Others were afterwards supplied by Benozzo Gozzoli and men of lesser note, and the labour of ornamentation was only discontinued in 1464.

Meanwhile, in 1406, the Florentines made another attack upon Pisa, besieging it simultaneously by sea and land. Owing to the starving condition of its defenders, and aided by the treachery of Giovanni Gambacorti, they entered the city in triumph on the 9th of October, and sought to "crush every germ of rebellion and drive out its citizens by measures of the utmost harshness and cruelty." Such were the orders sent by the Ten of War to the representatives of the Florentine government in Pisa, and such was then the established policy of every Italian state. Consequently for a long time there was a continual stream of emigration from Pisa. The Medici pursued a humaner course. In 1472 Lorenzo the Magnificent tried to restore the ancient renown of the Pisan university. To that end he filled it with celebrated scholars, and, leaving only a few chairs of letters and philosophy in Florence, compelled the Florentines to resort to Pisa for the prosecution of their studies. But nothing could now allay the inextinguishable hatred of the conquered people. When Charles VIII. made his descent into Italy in 1494, and came to Sarzana on his way to Tuscany, he was welcomed by the Pisans with the greatest demonstrations of joy. And, although that monarch was ostensibly the friend of Florence, they did not

hesitate, even in his presence, to assert their own independence, and, casting the Florentine ensign, the Marzocco, into the Arno, made instant preparations for war. Between 1499 and 1505 they heroically withstood three sieges and repulsed three attacking armies. But their adversaries always returned to the assault, and, what was worse, yearly laid waste their territories and destroyed all their crops. Soderini, who was perpetual gonfalonier of Florence, and Machiavelli, the secretary of the Ten, urged on the war. In 1509 Florence encamped her forces on three sides of the distressed city, which at last, reduced to extremity by famine, was compelled to surrender on the 8th of June 1509. Thenceforth the Florentines remained lords of Pisa. But now, mainly owing to the efforts of Soderini and Machiavelli, the conquerors showed great magnanimity. They brought with them large stores of provisions, which were freely distributed to all; they tried to succour the suffering populace in every way, and gave other assistance to the wealthier classes. Nevertheless, emigration continued even on a larger scale than in 1406, and the real history of Pisa may be said to have ended. In Naples, in Palermo, in all parts of Italy, Switzerland and the south of France, we still find the names of Pisan families who quitted their beloved home at that time. The Florentines immediately built a new citadel, and this was a great bitterness to the Pisans. The Medici, however, remained well disposed towards the city. Leo X. was an active patron of the university, but it again declined after his death. The grand duke Cosmo I., a genuine statesman, not only restored the university, but instituted the "uffizio dei fossi," or drainage office for the reclamation of marsh lands, and founded the knighthood of St. Stephen. This order played a noble part in the protection of Tuscan commerce, by fighting the Barbary pirates and establishing the prestige of the grand-ducal navy (see MEDICI). Under the succeeding Medici, Pisa's fortunes steadily declined. Ferdinand I. initiated a few public works there, and above all restored the cathedral, which had been partly destroyed by fire in 1595. These dreary times, however, are brightened by one glorious name—that of Galileo Galilei.

The population of Pisa within the walls had been reduced in 1551 to 8574 souls, and by 1745 it had only risen to the number of 12,406. Under the house of Lorraine, or more correctly during the reign of that enlightened reformer the grand duke Peter Leopold (1765-1790), Pisa shared in the general prosperity of Tuscany, and its population constantly increased. By 1840 it contained 21,670 souls, exclusive of the suburbs and outlying districts.

AUTHORITIES.—Paolo Tronci, *Annali di Pisa*, edited by E. V. Montazio (2 vols., Lucca, 1842-1843), which comes down to 1840; Raniero Grassi, *Pisa e le sue adiacenze* (Pisa, 1851), which is a useful historical guide; Roncioni, "Istorie Pisane," in the *Archivio storico italiano*, vol. vi., pt. 1; "Cronache Pisane," in the same *Archivio*, vol. vi., pt. 2; for the early constitution of the city, see G. Volpe's *Studi sulle istituzioni comunali di Pisa* (Pisa, 1902), and for the laws, F. Bonaini's *Status inediti della città di Pisa* (3 vols., Florence, 1851, &c.). The maritime and commercial history of the republic is dealt with in A. Schaub's *Das Konsulat der Lombarde in Pisa* (Leipzig, 1888) and in Pawinski's *Zur Entstehungsgeschichte des Konsulats in den Communen Nord- und Mittel-Italiens* (Berlin, 1867); for the monuments and inscriptions see A. Da Morrona, *Pisa illustrata* (Leghorn, 1812) and G. R. de Fleury's *Les Monuments de Pise au moyen âge* (Paris, 1866); also Repetti's *Dizionario geografico della Toscana*, s.v. "Pisa." For Dante's connexion with Pisa, see *Dante e i Pisanes*, by Giovanni Storza (Pisa, 1873). Among the more recent historical guides to Pisa of a popular character is *The Story of Pisa and Lucca*, by Janet Ross and Nellie Erichsen, in Dent's "Medieval Towns" (London, 1907), and T. B. Supino's *Pisa*, in the "Italia artistica Series."

(P. V.)

PISA, COUNCIL OF (1409). The great schism of the west had already lasted thirty years, and the efforts which had been made to restore unity within the Church by the simultaneous resignation of the two rival pontiffs had been in vain, when in the spring of 1408, the state of affairs being desperate, the idea arose of assembling a council to effect a union without the co-operation of the popes. The initiative came from those cardinals who had one after the other seceded either from Gregory XII. or Benedict XIII. They were forestalled by the popes, who each

summoned a council, the former to Cividale (in Friuli), the latter to Perpignan, so the dissident cardinals sent out antedated letters inviting Christendom to assemble at Pisa on the 25th of March 1409. Their appeal met with a response in a great part of Italy, France, Navarre, Portugal and England, and in Germany in the states subject to Wenceslas king of the Romans, the electors of Cologne and Mainz, the margrave of Brandenburg, &c. For a time the number of the fathers exceeded five hundred.

The day after the opening of the council, proceedings were started against the two popes, who, it was agreed, were to be eliminated. An act of accusation, containing in 37 articles the chief complaints against them, was read out to the people; not only their policy, but their orthodoxy was attacked, and there was even an insinuation of sorcery. The reason is, that in order to depose them with some show of legality, it was necessary, as a preliminary, to convict them of heresy, and it began to be seen that their tenacity of power, and the ruses by which they evaded the necessity of abdicating, however harmful might be their consequences, did not in themselves constitute a clearly-defined heresy. On the 5th of June 1409 was read the definitive sentence: that as heretics, and therefore separated from the Church, Pedro de Luna (Benedict XIII.) and Angelo Corrario (Gregory XII.) were *ipso facto* deposed from any office; they must not be obeyed, nor assisted, nor harboured. In the course of the rejoicings which followed this sentence among the populace of Pisa, occurred the somewhat scandalous event of the burning of two images crowned with parchment mitres, representing Gregory XII. and Benedict XIII. It was in vain that the ambassadors of Benedict XIII. presented themselves at Pisa. The crowd greeted their arrival with mockery and derision, and being treated as the envoys of heretics they escaped without having obtained a hearing.

In order to complete their task the cardinals present at Pisa, authorized by delegation of the council, shut themselves up in conclave, and elected one of their number, Peter Philargi, cardinal of Milan, as the new pope, who assumed the name of Alexander V. They had hoped to save the Church, but unfortunately the result of their efforts, generous as they were, was that the schism increased in bitterness, and that instead of the unity for which the Church craved, three popes continued to flourish. Both the deposed pontiffs protested against the legality of the council of Pisa; each had numerous partisans, and the thesis, constructed rather to meet the exigencies of the case, which attributed to a synod assembled by the cardinals the right of constituting itself judge of a sovereign pontiff, was far from being established.

Originally the council of Pisa was to have occupied itself not only with effecting the union, but also with the reform of the Church. As a matter of fact, it confined itself to expressing certain desiderata in a "libellus supplicatorius" which it submitted to the new pope. Alexander V. only partially acceded to these demands, many of which constituted serious encroachments on the prerogative of the Holy See; he then declared the work of reform suspended, and dissolved the council (August 7, 1409).

See Jacques Lenfant, *Histoire du concile de Pise* (Utrecht, 1731); Mansi, *Concil.*, xxvii.; F. Stühr, *Die Organisation und Geschäftsordnung des Pisaner und Konstanzer Konzils* (Schweizer, 1891); N. Valois, *La France et le grand schisme d'occident*, iv. 3-107, 175 seq. (Paris, 1902). (N. V.)

PIŚĀCA LANGUAGES, the name which has been given to a family of languages spoken immediately to the south of the Hindu Kush, and north of the frontier of British India. The family includes the group of Kafir languages spoken in Kafiristan, Khovar, spoken in the Chitral country, and the group of Shina languages, which includes the Shina of Gilgit, Kohistan, spoken in the Kohistan of the Indus and Swat rivers, and Kashmiri. Of all these Kashmiri is the only one which has received any literary cultivation, and of which the number of speakers is known. The Piśāca languages are Aryan by origin, but are neither Iranian nor Indo-Aryan. (See INDO-ARYAN LANGUAGES and KASHMIRI.) (G. A. GR.)

PISACANE, CARLO, duke of San Giovanni (1818-1857), Italian revolutionary, was born at Naples, and entered the Neapolitan army in 1830; but having become imbued with Mazzinian ideas he emigrated in 1847, and after a short stay in England and France served in the French army in Algeria. The revolution of 1848 recalled him to Italy; he played a part in the brief but glorious history of the Roman Republic, and was the life and soul of the war commission in the defence of the city. After its capture by the French he again went into exile, first to London and then to Genoa, maintaining himself by teaching. He regarded the rule of the house of Savoy as no better than that of Austria. When Mazzini, undeterred by the failure of the abortive Milan rising on the 6th of February 1853, determined to organise an expedition to provoke a rising in the Neapolitan kingdom, Pisacane offered himself for the task, and sailed from Genoa with a few followers (including Giovanni Nicotera) on board the "Cagliari" on the 25th of June 1857. They landed on the island of Ponza, where the guards were overpowered and some hundreds of prisoners liberated, and on the 28th arrived at Sapri in Calabria and attempted to reach the Cilento. But hardly any assistance from the inhabitants was forthcoming, and the invaders were quickly overpowered, Pisacane himself being killed.

See P. M. Bilotti, *La Spedizione di Sapri* (Salerno, 1907).

PISANI, CHRISTINE DE (1364-c. 1430), French poet, of Italian birth, was born at Venice in 1364. When she was four years old she was brought to her father, a councillor of the Venetian Republic, in Paris, where he held office as astrologer to Charles V. At fifteen Christine married Étienne du Castel, who became Charles's notary and secretary. After the king's death in 1380 her father lost his appointment, and died soon after; and when Christine's husband died in 1389 she found herself without a protector, and with three children depending on her. This determined her to have recourse to letters as a means of livelihood. Her first ballads were written to the memory of her husband, and as love poems were the fashion she continued to write others—*lais*, *virelais*, *rondeaux* and *jeux à vendre*—though she took the precaution to assure her readers (*Cent balades*, No. 50) that they were merely exercises. In 1399 she began to study the Latin poets, and between that time and 1405, as she herself declares, she composed some fifteen important works, chiefly in prose, besides minor pieces. The earl of Salisbury, who was in Paris on the occasion of the marriage of Richard II. with Isabella of France (1396), took her elder son, Jean du Castel (b. 1384), and reared him as his own; the boy, after Salisbury's death (1400), being received by Philip of Burgundy, at whose desire Christine wrote *Le Livre des faits et bonnes manières du seigneur roy Charles* (1405), valuable as a first-hand picture of Charles V. and his court. Her *Mutation de fortune*, in which she finds room for a great deal of history and philosophy, was presented to the same patron on New Year's Day, 1404. It possesses an introduction of great autobiographical interest. In *La Vision* (1405) she tells her own history, by way of defence against those who objected to her pretensions as a moralist. Henry IV. of England desired her to make his court her home, and she received a like invitation from Galcazzo Visconti, tyrant of Milan. She preferred, however, to remain in France, where she enjoyed the favour of Charles VI., the dukes of Berry and Burgundy, the duchess of Bourbon and others.

Christine was a champion of her own sex. In her *Dit de la rose* (1402) she describes an order of the rose, the members of which bind themselves by vow to defend the honour of women. Her *Épître au dieu d'amour* (1399) is a defence of women against the satire of Jean de Meun, and initiated a prolonged dispute with two great scholars of her time, Jean de Montreuil (d. 1415) and Gonthier Col, who undertook the defence of the *Roman de la rose*. Christine wrote about 1407 two books for women, *La Cité des dames* and *Le Livre des trois vertus*, or *Le Trésor de la cité des dames*. She was devoted to her adopted country. During the civil wars she wrote a *Lamentation* (1410) and a *Livre*

¹ See C. B. Pettitot, *Collection complète des mémoires relatifs à l'histoire de France* (1st series, vols. v. and vi., 1819, &c.).

de la paix (1412-1413), but after the disasters of the campaign of Agincourt she retired to a convent. We have no more of her work until 1429, when she broke her silence to write a song in honour of Joan of Arc. Of the circumstances of her death nothing is known but it probably took place about this time. Her *Cité des dames* contains many interesting contemporary portraits, and her *Livre des trois vertus* contains details of domestic life in the France of the early 15th century not supplied by more formal historians.

Her poems were edited by Maurice Roy for the Société des anciens Textes français (1886, &c.), and her *Livre du chemin du long étude*, by Puschel (Berlin, 1887). There are monographs by Raimond Thomassy (Paris, 1838); E. M. D. Robineau (Saint-Omer, 1882); and Friedrich Koch (Goslar, 1885). It is possible that Jean Castel, who was chronicler of France under Louis XI., was Christine's grandson. Hoccleve imitated her *Épître au dieu d'amour*, in his "Letter of Cupid" (*Chaucerian and other Pieces*, ed. W. W. Skeat, 1897). A translation of her *Épître d'Orléans* was made (c. 1440) by Stephen Scrope for his stepfather, Sir John Fastolf, and is preserved in a MS. at Longleat. This was edited (1904) for the Romberg Club by W. G. F. Warner as *The Epistle of Orléans to Hector, or the Book of Knighthood. The Moral Proverbs of Christine de Pise*, translated by Earl Rivers, was printed in 1478 by Caxton, who himself translated, by order of Henry VII., her *Livre des faits d'armes, et de chivalerie*, a treatise on the art of war, based chiefly on Vegetius. Her *Cité des dames* was translated by Brian Anslay (London, 1521).

PISANI, VETTOR (d. 1380), Venetian admiral, was in command of the Venetian fleet in 1378 during the war against the Genoese, whom he defeated off Capo d'Anzio; subsequently he recaptured Cattaro, Sebenico and Arbe, which had been seized by the Hungarians, the allies of the Genoese. But the Genoese fleet completely defeated Pisani at Pola in May 1379, and on his return to Venice he was thrown into prison. The enemy now pressed home their victory, and besieged and captured Chioggia, whereby Venice itself was in danger. The people thereupon demanded the liberation of Pisani, in whose skill they had the fullest confidence. The government gave way and appointed the aged commander admiral of the fleet once more. Through his able strategy and daring he recaptured Chioggia, defeated the Genoese and threatened Genoa itself until that republic agreed to peace terms. Pisani died in 1380 while on his way to Manfredonia with a squadron to ship provisions.

See Vittorio Lazzarini, "La morte e il monumento di Vettor Pisani," in the *Nuovo archivio veneto*, vol. xi., pt. ii. (1896).

PISANO, ANDREA, also known as ANDREA DA PONTADERA (c. 1270-1348), Italian sculptor, was born about 1270, and first learned the trade of a goldsmith. He became a pupil of Giovanni



Part of the first Bronze Door of the Baptistery at Florence, by Andrea Pisano.

Pisano about 1300, and worked with him on the sculpture for S. Maria della Spina at Pisa and elsewhere. But it is at Florence

that his chief works were executed, and the formation of his mature style was due rather to Giotto than to his earlier master. Of the three world-famed bronze doors of the Florentine baptistery, the earliest one—that on the south side—was the work of Andrea; he spent many years on it; and it was finally set up in 1336.¹ It consists of a number of small quatrefoil panels—the lower eight containing single figures of the Virtues, and the rest scenes from the life of the Baptist. Andrea Pisano, while living in Florence, also produced many important works of marble sculpture, all of which show strongly Giotto's influence. In some cases probably they were actually designed by that artist, as, for instance, the double band of beautiful panel-reliefs which Andrea executed for the great campanile. The subjects of these are the Four Great Prophets, the Seven Virtues, the Seven Sacraments, the Seven Works of Mercy and the Seven Planets. The duomo contains the chief of Andrea's other Florentine works in marble. In 1347 he was appointed architect to the duomo of Orvieto, which had already been designed and begun by Lorenzo Maitani. The exact date of his death is not known, but it must have been shortly before the year 1349.

Andrea Pisano had two sons, Nino and Tommaso—both, especially the former, sculptors of considerable ability. Nino was very successful in his statues of the Madonna and Child, which are full of human feeling and soft loveliness—a perfect embodiment of the Catholic ideal of the Divine Mother. Andrea's chief pupil was Andrea di Cione, better known as Orcagna (q.v.). Balduccio di Pisa, another, and in one branch (that of sculpture) equally gifted pupil, executed the wonderful shrine of S. Eustorgio at Milan—a most magnificent mass of sculptured figures and reliefs.

PISANO, GIOVANNI (c. 1250-1330), Italian architect and sculptor, was the son of Niccolò Pisano. Together with Arnolfo del Cambio and other pupils, he developed and extended into other parts of Italy the renaissance of sculpture which in the main was due to his father's talent. After he had spent the first part of his life at home as a pupil and fellow worker of



Part of the Tomb of Benedict XI., by Giovanni Pisano.

Niccolò, the younger Pisano was summoned between 1270 and 1274 to Naples, where he worked for Charles of Anjou on the Castel Nuovo. One of his earliest independent performances was the Campo Santo at Pisa, finished about 1283; along with this he executed various pieces of sculpture over the main door and inside the cloister. The richest in design of all his works (finished about 1286) is in the cathedral of Arezzo—a magnificent marble high altar and retables, adorned both in front and at the back with countless figures and reliefs—mostly illustrative of the lives of St. Gregory and St. Donato, whose bones are enshrined there. The actual execution of this was probably wholly the work of his pupils. In 1290 Giovanni was appointed architect or "capo maestro" of the new cathedral at Siena, in which office he succeeded Lorenzo Maitani, who went to Orvieto to build the less ambitious but equally magnificent duomo which had just been founded there. The design of the gorgeous façade of that duomo has been attributed to him, but it is more probable that he only carried out Maitani's design. At Perugia, Giovanni built the

¹ The date on the door, 1330, refers to the original wax model.

church of S. Domenico in 1304, but little of the original structure remains. The north transept, however, still contains his beautiful tomb of Benedict XI., with a sleeping figure of the pope, guarded by angels who draw aside the curtain. One of Giovanni's most beautiful architectural works was the little chapel of S. Maria della Spina (now rebuilt, "restored"), on the banks of the Arno in Pisa; the actual execution of this chapel, and the sculpture with which it is adorned, was mostly the work of his pupils.² The influence of his father Niccolò is seen strongly in all Giovanni's works, but especially in the pulpit of S. Andrea at Pistoia, executed about 1300. Another pulpit, designed on the same lines, was made by him for the nave of Pisa Cathedral between 1310 and 1311. The last part of Giovanni's life was spent at Prato, near Florence, where with many pupils he worked at the cathedral till his death about 1330.

See M. Sauerlandt, *Über die Bildwerke des Giovanni Pisano*, &c. (1904); A. Brach, *Niccolò und Giovanni Pisano und die Plastik des XIV. Jahrhunderts in Siena* (1904).

PISANO, NICCOLÒ (c. 1206-1278), Italian sculptor and architect. Though he called himself *Pisanus*, from Pisa, where most of his life was spent, he was not a Pisan by birth. There are two distinct accounts of his parentage, both derived mainly from existing documents. According to one of these he is said to have been the son of "Petrus, a notary of Siena;" but this statement is very doubtful, especially as the word "Siena" or "de Senis" appears to be a conjectural addition. Another document among the archives of the Sienese Cathedral calls him son of "Petrus de Apulia." Most modern writers accept the latter statement, and believe that he not only was a native of the province of Apulia in southern Italy, but also that he gained there his early instruction in the arts of sculpture and architecture. Those, on the other hand, who, with most of the older writers, prefer to accept the theory of Niccolò's origin being Tuscan, suppose that he was a native of a small town called Apulia near Lucca.

Except through his works, but little is known of the history of Niccolò's life. As early as 1221 he is said to have been summoned to Naples by Frederick II., to do work in the new Castel del l'Uovo. This fact supports the theory of his southern origin, though not perhaps very strongly, as, some years before, the Pisan Bonannus had been chosen by the Norman king as the sculptor to cast one of the bronze doors for Monreale Cathedral, where it still exists. The earliest existing piece of sculpture which can be attributed to Niccolò is a beautiful relief of the Deposition from the Cross in the tympanum of the arch of a side door at San Martino at Lucca; it is remarkable for its graceful composition and delicate finish of execution. The date is about 1237. In 1260, as an incised inscription records, he finished the marble pulpit for the Pisan baptistery; this is on the whole the finest of his works.

It is a high octagon, on semicircular arches, with trefoil cusps, supported by nine marble columns, three of which rest on white marble lions. In design it presents that curious combination of Gothic forms with classical details which is one of the characteristics of the medieval architecture of northern Italy; though much enriched with sculpture both in relief and in the round, the general lines of the design are not sacrificed to this, but the sculpture is kept subordinate to the whole. In this respect it is superior to the more magnificent pulpit at Siena, one of Niccolò's later works, which suffers greatly from want of repose and purity of outline, owing to its being overloaded with reliefs and statuettes. Five of the sides of the main octagon have panels with subjects—the Nativity, the Adoration of the Magi, the Presentation in the Temple, the Crucifixion and the Doom. These are all, especially the first three, works of the highest beauty, and a wonderful advance on anything of the sort that had been produced by Niccolò's predecessors. The drapery is gracefully arranged in broad simple folds; the heads are full of the most noble dignity; and the sweet yet stately beauty of the Madonna could hardly be surpassed. The panel with the Adoration of the Magi is perhaps the one in which Niccolò's study of the antique is most apparent (see figure). The veiled and diademed figure of the Virgin Mother, seated on a throne, recalls the Roman Juno; the head of Joseph behind her might be that of Vulcan; while the youthful beauty of an Apollo and the mature dignity of a Jupiter are suggested by the standing

² See Schuler, *Denkmäler der Kunst in Unter-Italien*, vii. 9.

and kneeling figures of the Magi. Certain figures in others of the panels are no less deeply imbued with classical feeling.

The next important work of Nicola in date is the Arca di San Domenico, in the church at Bologna consecrated to that saint, who died in 1221. Only the main part, the actual sarcophagus covered with sculptured reliefs of St Dominic's life, is the work of Nicola and his pupils. The sculptured base and curved roof with its fanciful ornaments are later additions. This "Arca"



The Adoration of the Magi, one of the panels in the pulpit of the Pisan Baptistery, by Nicola Pisano.

was made when St Dominic was canonized, and his bones translated; it was finished in 1267, not by Nicola himself, but by his pupils. The most magnificent, though not the most beautiful, of Nicola's works is the great pulpit in Siena cathedral (1268). It is much larger than that at Pisa, though somewhat similar in general design, being an octagon on cusped arches and columns. Its stairs, and a large landing at the top, with carved balusters and panels, rich with semi-classical foliage, are an addition of about 1500. The pulpit itself is much overloaded with sculpture, and each relief is far too crowded with figures. An attempt to gain magnificence of effect has destroyed the dignified simplicity for which the earlier pulpit is so remarkable.

Nicola's last great work of sculpture was the fountain in the piazza opposite the west end of the cathedral at Perugia. This is a series of basins rising one above another, each with sculptured bas-reliefs; it was begun in 1274, and completed, except the topmost basin, which is of bronze, by Nicola's son and pupil Giovanni.

Nicola Pisano was not only pre-eminent as a sculptor, but was also the greatest Italian architect of his century; he designed a number of very important buildings, though not all which are attributed to him by Vasari. Among those now existing the chief are the main part of the cathedral at Pistoia, the church and convent of Sta Margherita at Cortona, and Sta Trinità at Florence. The church of Sant' Antonio at Padua has also been attributed to him, but without reason. Unfortunately his architectural works have in most cases been much altered and modernized. Nicola was also a skilled engineer, and was compelled by the Florentines to destroy the great tower, called the *Guardamorto*, which overshadowed the baptistery at Florence, and had for long been the scene of violent conflicts between the Guelphs and Ghibellines. He managed skillfully so that it should fall without injuring the baptistery. Nicola Pisano died at Pisa in the year 1278, leaving his son Giovanni a worthy successor to his great talents both as an architect and sculptor.

Though his importance as a reviver of the old traditions of beauty in art has been to some extent exaggerated by Vasari, yet it is probable that Nicola, more than any other one man, was the means of starting that "new birth" of the plastic arts which, in the years following his death, was so fertile in countless works of the most unrivalled beauty. Both Nicola and his son had many pupils of great artistic power, and these carried the influence of the Pisani throughout Tuscany and northern Italy, so that the whole art of the succeeding generations may be said to have owed the greater part of its rapid development to this one family.

See SCULPTURE, and general histories of Italian art; Symonds,

Renaissance in Italy; A. Brach, *Nicola und Giovanni Pisano und die Plastik des XIV. Jahrhunderts in Siena* (Strassburg, 1904).

PISANO, VITTORE (c. 1380-1456), commonly called **PISANELLO**, Italian medallist, was a native of San Vigilio sul Lago in the territory of Verona. Specimens of his work as a painter are still extant in Rome, Venice, Verona, and Pistoia, and entitle him to a place of some distinction in the history of that art. The National Gallery in London possesses a very fine specimen of Pisanello's work—a panel painted with miniature-like delicacy. During the latter portion of his life he lived in Rome, where he enjoyed great repute.

PISAURUM (mod. Pesaro, *q.v.*), an ancient town of Umbria on the Via Flaminia, 26 m. from Ariminum and 8 from Fanum Fortunae. A Roman colony was founded here in the territory of the Galli Senones in 184 B.C., at the mouth of the river Pisaurus (mod. Foglia; the sea has since then receded about half a mile). Whether it took the place of an earlier town or not, is not known; an important Gaulish cemetery has been discovered near the village of Novilara between Pisaurum and Fanum, but to which of these centres (if either) it belonged is uncertain (E. Brizio in *Monumenti dei Lincei* [1895], v. 85 sqq.). In 174 B.C. we hear that the censors built a temple of Jupiter here and paved a road. T. Accius, the counsel who opposed Cicero in the case when he defended Cluentius in a still extant speech, was a native of Pisaurum. Catullus refers to the town as decadent or unhealthy, but this may be merely malicious, and does not seem to be borne out by facts: for it is not infrequently mentioned by classical authors. It was occupied by Caesar in 49 B.C., and was made a colony under the second triumvirate. Hence it bears the name Colonia Julia Felix. We hear little of it under the empire. It was destroyed by the Goths in 539, and restored by Belisarius in 545. From the inscriptions, nearly 200 in number, an idea of the importance of the town may be gained. Among them are a group of *cippi* found on the site of a sacred grove of the matrons of Pisaurum, bearing dedications to various deities, and belonging probably to the date of the foundation of the colony. There are some remains of the town walls, and an ancient bridge over the Foglia. It was, like Ariminum, a considerable place for the manufacture of bricks and pottery, though the factories cannot always be precisely localized.

PISCES (the fishes), in astronomy, the twelfth sign of the zodiac (*q.v.*), represented by two fishes tied together by their tails and denoted by the symbol ♓ . It is also a constellation, mentioned by Eudoxus (4th century B.C.) and Aratus (3rd century B.C.); and catalogued by Ptolemy (38 stars), Tycho Brahe (36) and Hevelius (39). In Greek legend Aphrodite and Eros, while on the banks of the Euphrates, were surprised by Typhon, and sought safety by jumping into the water, where they were changed into two fishes. This fable, however, as in many other similar cases, is probably nothing more than an adaptation of an older Egyptian tale. a *Piscium*, is a fine double star of magnitude 3 and 4; 35 *Piscium*, is another double star, the components being a white star of the 6th magnitude and a purplish star of the 8th magnitude.

Piscis australis, the southern fish, is a constellation of the southern hemisphere, mentioned by Eudoxus and Aratus, and catalogued by Ptolemy, who described 18 stars. The most important star is a *Piscis australis* or Fomalhaut, a star of the first magnitude. *Piscis volans*, the flying fish; is a new constellation introduced by John Bayer in 1603.

PISCICULTURE (from Lat. *piscis*, fish). The species of fish which can be kept successfully in captivity throughout their lives from egg to adult is exceedingly limited in number. The various breeds of goldfish are familiar examples, but the carp is almost the only food-fish capable of similar domestication. Various other food-fishes, both marine and fresh-water, can be kept in ponds for longer or shorter periods, but refuse to breed, while in other cases the fry obtained from captive breeders will not develop. Consequently there are two main types of pisciculture to be distinguished: (1) the rearing in confinement of young fishes to an edible stage, and (2) the stocking of natural waters with eggs or fry from captured breeders,

Fish-rearing.—Of the first type of pisciculture there are few examples of commercial importance. The pond-culture of carp is an important industry in China and Germany, and has been introduced with some success in the United States, but in England it has long fallen out of use, and is not likely to be revived so long as fresh fish can be obtained and distributed so readily as is now the case. Other examples are to be found in the cultivation of the lagoons of the Adriatic, and of the salt-marshes of various parts of France. Here, as in ancient Greece and Rome, it is the practice to admit young fish from the sea by sluices, into artificial enclosures or "viviers," and to keep them there until they are large enough to be used. An interesting modification of this method of cultivation has been introduced into Denmark. The entrances to the inner lagoons of the Limfjord are naturally blocked against the immigration of flatfish by dense growths of sea-grass (*Zostera*), although the outer lagoons are annually invaded by large numbers of small plaice from the North Sea. The fishermen of the district consequently combined to defray the expenses of transplanting large numbers of small plaice from the outer waters to the inner lagoons, where they were found to thrive far better than in their natural habitat. The explanation has been shown by Dr Petersen to be due to the abundance of food, coupled with the lack of overcrowding of the small fish. This transplantation of plaice in Denmark has been annually repeated for several years with the most successful results, and a suitable subvention to the cost is now an annual charge upon the government funds.

As a result of the International North Sea fishery investigations, it has been proposed to extend the same principle for the development of the deep sea fishery in the neighbourhood of the Dogger Bank. Experiments with labelled plaice, carried out in 1904 by the Marine Biological Association, showed that small plaice transplanted to the Dogger Bank in spring grew three times as rapidly as those on the inshore grounds, and the same result, with insignificant variations, has been obtained by similar experiments in each succeeding year. In this case the deep water round the Dogger Bank acts as a barrier to the emigration of the small plaice from the shores. It has consequently been proposed that the small plaice should be transplanted in millions to the Bank by well vessels every spring. It is claimed, as a further result of the experiments, that from May to October the young fish would be practically free on the shallow part of the Bank from the risk of premature capture by trawlers, and that the increased value of the fish, consequent upon their phenomenal growth-rate, would greatly exceed the cost of transplantation.

The methods of oyster- and mussel-culture are similar in principle to those just described. A breeding stock is maintained to supply the ground, or the "collectors," with spat, and the latter, when sufficiently grown, is then transplanted to the most favourable feeding-grounds, care being taken to avoid the local over-crowding which is so commonly observed among shell-fish under natural conditions.

Fish-hatching.—The second, and more familiar, type of pisciculture is that known as fish-hatching, with which must be associated the various methods of artificial propagation.

The fertilization of the spawn is very easily effected. The eggs are collected either by "stripping" them from the mature adult immediately after capture, or by keeping the adults alive until they are ready to spawn, and then stripping them or by keeping them in reservoirs of sea-water and allowing them to spawn of their own accord. In the two former cases a little mill is allowed to fall from a male fish into a vessel containing a small quantity of water—fresh or salt as required—and the eggs are pressed from the female fish into the same vessel. In fresh-water culture the eggs thus fertilized may be at once distributed to the waters to be stocked, or they may be kept in special receptacles provided with a suitable stream of water until the fry are hatched, and then distributed, or again they may be reared in the hatchery for several months until the fry are active and hardy.

The hatching of eggs, whether of fresh-water or salt-water fishes, presents no serious difficulties, if suitable apparatus is employed; but the rearing of fry to an advanced stage, without serious losses, is less easy, and in the case of sea-fishes with pelagic eggs, the larvae of which are exceedingly small and

tender, is still an unsolved problem, although recent work, carried out at the Plymouth laboratory of the Marine Biological Association, is at least promising. It has been found possible to grow pure cultures of various diatoms, and by feeding these to delicate larvae kept in sterilized sea-water, great successes have been attained. In fresh-water culture little advantage, if any, has been found to result from artificial hatching, unless this is followed by a successful period of rearing. Thus the Howietown Fishery Company recommend their customers to stock their streams either with unhatched ova or with three-month-old fry. Their experience is "that there is no half-way house between ova sown in redds and three-month-old fry. Younger fry may do, but only where ova would do as well, and at half the cost." In marine hatcheries, on the other hand, it is the invariable practice to hatch the eggs, although the fry have to be put into the sea at the most critical period of their lives. If it is a risky matter to plant out the robust young fry of trout under an age of three months, it would seem to be an infinitely more speculative proceeding to plant out the delicate week-old larvae of sea-fishes in an environment which teems with predaceous enemies.

Objects and Utility of Fish-hatcheries.—The earlier advocates of artificial propagation and fish-hatching seem to have been under the impression that the thousands of fry resulting from a single act of artificial propagation meant a corresponding increase in the numbers of edible fish when once they had been deposited in suitable waters; and also that artificial fertilization ensured a greater proportion of fertilized eggs than the natural process. For the second of these propositions there is no evidence, while the first proposition is now everywhere discredited. It is recognized that the great fertility of fishes is nature's provision to meet a high mortality—greater in sea-fishes with minute pelagic eggs than in fresh-water fishes with larger-yolked eggs, partly because of the greater risks of marine pelagic life, and partly because of the greater delicacy of marine larvae at the time of hatching. Artificially propagated eggs and fry after planting must submit to the same mortality as the other eggs and fry around them. Consequently it is useless to plant out eggs or fry unless in numbers sufficiently great to appreciably increase the stock of eggs and fry already existing.

It is this, combined always with the suitability of the external conditions, which accounts for the success of the best known experiments of American pisciculturists. The artificially propagated eggs of the shad from the eastern rivers of the United States were planted in those of California and the Mississippi, where the species did not naturally occur. The conditions were suitable, and the species became at once acclimatized. Similarly reservoirs and streams can be stocked with various kinds of fish not previously present. But in the case of indigenous species the breeding stock must be very seriously reduced before the addition of the eggs or fry of a few score or hundreds of fish can appreciably increase the local stock.

In the case of sea-fishes it is becoming increasingly recognized that the millions of cod fry which are annually turned out of the American, Newfoundland and Norwegian hatcheries are but an insignificant fraction of the billions of fry which are naturally produced. A single female cod liberates, according to its size, from one to five million eggs in a single season. Yet the annual output of fry from each of these hatcheries rarely exceeds 200 millions, i.e. the natural product of a few hundred cod at most. In Britain marine hatcheries have been established by the Fishery Board for Scotland in the bay of Nigg, near Aberdeen, by the Lancashire Sea Fisheries Committee at Peel, and by the government of the Isle of Man at Port Erin. These establishments have been principally devoted to the hatching of the eggs of plaice. But again the maximum output of fry from any one of these establishments has not exceeded 40 millions in any single year. As a single female plaice produces about 200,000 eggs per annum, this output does not exceed the natural product of a few hundred fish. Under these circumstances the probable utility of the operations could be

admitted only if the fry were sedentary and could be planted in suitable localities where young fish were naturally scarce. But the fry drift with the currents as helplessly as the eggs, and the a priori objections to the utility of the operations have in no case been met by evidence of tangible results. The plaice fry hatched in the Scottish establishment have been distributed for many years in the waters of Loch Fyne. Yet in this area, according to the investigations of Mr Williamson (*Report of the Scottish Fishery Board for 1898*), nearly 500 millions of plaice eggs are naturally produced in one spawning season. Evidence is still lacking as to whether the 50 to 30 million fry annually added from the hatchery have appreciably increased the quantities of young plaice on the surrounding shores. Supposing this could be established, the question would still remain whether the same result could not be obtained at far less expense by dispensing with the hatching operations and distributing the eggs directly after fertilization.

In the United States the utility of the cod-hatching operations has been constantly ascertained by representatives of the Bureau of Fisheries, but practically the only evidence adduced is the occasional appearance of unusual numbers of cod in the neighbourhood. It has not been established that the fluctuations in the local cod fisheries bear any fixed relation to the extent of the hatching operations, while the earlier reports of the Commissioners of Fisheries contain evidence that similar fluctuations occurred before the hatching of "fish commission cod" had begun.

The situation may be summed up in the words of Mr Fryer, H.M. Superintending Inspector of Fisheries, who critically examined the evidence bearing upon the operations of the Newfoundland Hatchery at Dildo (Reports x.-xii. of the Inspectors of Sea Fisheries, E. & W.): "Where the establishment of a hatchery, even on the smallest scale, is followed by an increased take of fish, there is a tendency to connect the two as cause and effect on insufficient evidence, and without any regard to the many conditions which have always led to fluctuations in the case of any particular kind of fish."

The most exact investigations bearing upon this problem are those which have been recently undertaken in Norway in connexion with the cod-hatching operations at Arendal under Captain Dannevig. Four fjords were selected in the south coast of Norway in proximity to the hatchery, and the usual number of fry (10-30 millions) were planted in the spring in alternate fjords, leaving the intermediate fjords unsupplied. The relative number of young cod in the various fjords was then carefully investigated throughout the succeeding summer and autumn months. It was found that there was no relation between the abundance of young fish and the presence or absence of "artificial" fry. In 1904, 33 million fry were planted in Sondefjord and young fish were exceptionally abundant in the following autumn (three times as abundant as in 1903 when no fry were planted). But their abundance was equally striking in other fjords in which no fry had been planted, while in 1905 all the fjords were deficient in young cod whether they had been planted with fry from the hatchery or not.

For a summary of these investigations see papers on "Artificial Fish-hatching in Norway," by Captain Dannevig and Mr Dahl, in the *Report of the Lancashire Sea Fisheries Laboratory for 1906* (Liverpool, 1907).

It would thus seem clear that the attempts hitherto made to increase the supply of sea-fish by artificial hatching have been unsuccessful. The experience gained has doubtless not been wasted, but the direction to be taken by future work is plain. The energy and money devoted to hatching operations should be diverted to the serious attempt to discover a means of rearing on a large scale the just-hatched fry of the more sedentary species to a sturdy adolescence. When that has been done (it has been achieved, by the present writer in the case of the sea fish *Colinus* with demersal eggs,) it would be possible to deposit the young fish in suitable localities on a large scale, with a reasonable prospect of influencing the local abundance of the species of fish in question.

For further details, see J. T. Cushingam, *Natural History of the Marketable Marine Fishes of the British Islands* (London, 1896); *A Manual of Fish-Culture* (Washington, 1897); Roché, *La Culture des mers* (Paris, 1898); W. Garstang, *Experiments on the Transplantation of Marked Plaice* (First Report of the North Sea Fisheries Investigation Committee, 1905). (W. Ga.)

PISCINA, a Latin word first applied to a fish-pond, and later used for any pool of water for bathing, &c., either natural or artificial, and also for a tank or reservoir. In ecclesiastical usage the term was given to a shallow stone basin (the French *cuvette*) placed near the altar in a church, with drains to take away the water used in the ablutions at the mass. "Piscinae" seem at first to have been mere cups or small basins, supported on perforated stems, placed close to the wall, and afterwards to have been recessed therein and covered with niche heads, which often contained shelves to serve as umbries. They are rare in England till the 13th century, after which there is scarcely an altar without one. They frequently take the form of a double niche, with a shaft between the arched heads, which are often filled with elaborate tracing.

PÍSEK, a town of Bohemia, 55 m. S. of Prague by rail. Pop. (1900), 13,608, mostly Czech. It lies on the right bank of the Wottawa, which is here crossed by an interesting stone bridge of great antiquity. The most prominent buildings are the church of the Nativity, the town-hall, and a castle dating from the 13th century. The industries are iron and brass founding, brewing, and the manufacture of shoes, paper, cement and Turkish fezes. Feldspar, quartz and granite are quarried in the environs. The name of Pisek, which is the Czech for sand, is said to be derived from the gold-washing formerly carried on in the bed of the Wottawa (1571-1621).

In 1619 it was captured by the imperialist general, Karl Bonaventura de Longueval, Graf von Biequoy, and suffered so severely that the citizens opened their gates to his opponent, Ernst von Mansfeld. This was punished in October of the following year, when Duke Maximilian of Bavaria sacked the town and put nearly all the inhabitants to the sword. Pisek was one of the chief centres of the Hussites. It was occupied by the French in 1741.

PISIDIA, in ancient geography, the name given to a country in the south of Asia Minor, immediately north of Pamphylia by which it was separated from the Mediterranean, while it was bounded on the N. by Phrygia, on the E. by Lyconia, Isauria and Cilicia, and on the W. and S.W. by Lycia and a part of Phrygia. It was a rugged and mountainous district, comprising some of the loftiest portions of the great range of Mt Taurus, together with the offshoots of the same chain towards the central table-land of Phrygia. Such a region was naturally occupied from a very early period by wild and lawless races of mountaineers, who were very imperfectly reduced to subjection by the powers that successively established their dominion in Asia Minor. The Pisidians are not mentioned by Herodotus, either among the nations that were subdued by Croesus, or among those that furnished contingents to the army of Xerxes, and the first mention of them in history occurs in the *Anabasis* of Xenophon, when they furnished a pretext to the younger Cyrus for levying the army with which he designed to subvert his brother's throne, while he pretended only to put down the Pisidians who were continually harassing the neighbouring nations by their lawless forays (*Anab.* i. 1, 11; ii. 1, 4; &c.). They are afterwards mentioned frequently by later writers among the inland nations of Asia Minor, and assume a more prominent part in the history of Alexander the Great, to whose march through their country they opposed a determined resistance. In Strabo's time they had passed under the Roman dominion, though still governed by their own petty chiefs and retaining to a considerable extent their predatory habits (giving rise to such wars as that carried on by Quirinius, about 8-6 B.C.).

The boundaries of Pisidia, like those of most of the inland provinces or regions of Asia Minor, were not clearly defined, and appear to have fluctuated at different times. This was especially the case on the side of Lycia, where the upland

district of Milyss was sometimes included in Pisidia, at other times assigned to Lycia. Some writers, indeed, considered the Pisidians as the same people with the Milyans, while others regarded them as descendants of the Solyml, but Strabo speaks of the language of the Pisidians as distinct from that of the Solyml, as well as from that of the Lydians. The whole of Pisidia is an elevated region of table-lands or upland valleys in the midst of the ranges of Mt Taurus which descends abruptly on the side of Pamphylia. It contains several small lakes, and two of large size, Bey-Sheher Lake, the ancient Karalis, and the double lake now called the Egerdir Geul, of which the ancient name was Linnai. The latter is a fresh-water lake of about 30 m. in length, situated in the north of Pisidia on the frontier of Phrygia, at an elevation of 3007 ft. Karalis is a large body, also of fresh water, and at a distinctly higher level above the sea. The only rivers of importance are the Cestrus and the Eurymedon, both of which take their rise in the highest ranges of Mt Taurus, and flow down through deep and narrow valleys to the plain of Pamphylia, which they traverse on their way to the sea.

Notwithstanding its rugged and mountainous character, Pisidia contained in ancient times several considerable towns, the ruins of which have been brought to light by the researches of recent travellers (Arundell, Hamilton, Daniell, G. Hirschfeld, Radet, Sterrett, Lanckoronki, Ramsay, &c.), and show them to have attained under the Roman Empire to a degree of opulence and prosperity far beyond what we should have looked for in a country of predatory mountaineers. The most important of them are Termessus, near the frontier of Lycia, a strong fortress in a position of great natural strength and commanding one of the principal passes into Pamphylia; Cretnna, another mountain fortress, north of the preceding, impending over the valley of the Cestrus; Sagalassus, a little farther north, a large town in a strong position, the ruins of which are among the most remarkable in Asia Minor; Selge, on the right bank of the Eurymedon, surrounded by rugged mountains, notwithstanding which it was in Strabo's time a large and opulent city; and Antioch, known for distinction's sake as Antioch of Pisidia, and celebrated for the visit of St Paul. This was situated in the extreme north-east of the district immediately on the frontier of Phrygia, between Lake Egerdir and the range of the Sultan Dagh and was reckoned in the Greek and earlier Roman period, e.g. by Strabo, as a city of Phrygia.

Besides these there were situated in the rugged mountain tract west of the Cestrus Cretopolis, Olbasa, Pogle, Isinda, Etenna and Comama. Pednelissus was in the upper valley of the Eurymedon above Selge. The only place in the district at the present day deserving to be called a town is Isbarta, the residence of a pasha; it stands at the northern foot of the main mass of Mt Taurus, looking over a wide and fertile plain which extends up to the northern chain of Taurus. North of this and immediately on the borders of Phrygia stood Apollonia, called also Mordiaem. Large estates in Pisidia and the adjoining parts of Phrygia belonged to the Roman emperors; and their administration has been investigated by Ramsay and others.

We have no clue to the ethnic character and relations of the Pisidians, except that we learn from Strabo that they were distinct from the neighbouring Solyml, who were probably a Semitic race, but we find mention at an early period in these mountain districts of various other tribes, as the Cabali, Milyans, &c., of all which, as well as the neighbouring Isaurians and Lycaonians, the origin is wholly unknown, and the absence of monuments of their languages must remain so. A few short Pisidian inscriptions have been published by Ramsay in *Revue des études anciennes* (1895, pp. 353-362). No inscriptions in these other languages are known. (W. M. RA.)

PISO, the name of a distinguished Roman plebeian family of the Calpurnian gens which continued in existence till the end of the 2nd century A.D. Nearly fifty of its members were prominent in Roman history, but the following deserve particular mention.

1. LUCIUS CALPURNIUS PISO CAMERINUS, Roman statesman, was the father-in-law of Julius Caesar. In 58 B.C., when consul, he and his colleague Aulus Gabinius entered into a compact with P. Clodius, with the object of getting Cicero out of the way. Piso's reward was the province of Macedonia, which he administered from 57 to the beginning of 55, when he was recalled, perhaps in consequence of the violent attack made upon him by Cicero in the senate in his speech *De provinciis consularibus*. On his return Piso addressed the senate in his defence, and Cicero replied with the coarse and exaggerated invective known as *In Pisonem*. Piso issued a pamphlet by way of rejoinder, and there the matter dropped, Cicero being afraid to bring the father-in-law of Caesar to trial. At the outbreak of the civil war Piso offered his services as mediator, but when Caesar marched upon Rome he left the city by way of protest. He did not, however, definitely declare for Pompey, but remained neutral, without forfeiting the respect of Caesar. After the murder of the dictator he insisted on the provisions of his will being strictly carried out, and for a time opposed Antony. Subsequently, however, he became one of his supporters, and is mentioned as taking part in an embassy to Antony's camp at Mutina with the object of bringing about a reconciliation.

2. LUCIUS CALPURNIUS PISO, surnamed *Prugi* (the worthy), Roman statesman and historian, was tribune in 149 B.C. He is known chiefly for his *lex Calpurnia repetundarum*, which brought about the system of *quaestiones perpetuae* and a new phase of criminal procedure. As praetor (136) and consul (133) Piso fought against the slaves in Sicily. He energetically opposed Gaius Gracchus, especially in connexion with his corn law.

See ANNALISTS: C. Cichorius in Pauly-Wissowa's *Realencyclopädie* (1897), vol. iii., pt. 1; H. Peter, *Historicum romanorum reliquias* (1870), vol. i.; Teuffel-Schwabe, *Hist. of Roman Lit.* (Eng. trans.), § 132, 4. On the lex Calpurnia, *Corpus iur. latinum*, I, No. 198, with Mommsen's commentary; A. H. J. Greenidge, *Hist. of Rome*, 133-104 B.C. (1904).

3. GNAEUS CALPURNIUS PISO, Roman statesman, was consul in 7 B.C., and subsequently governor of Spain and proconsul of Africa. In A.D. 17 Tiberius appointed him governor of Syria, with secret instructions to thwart Germanicus, to whom the eastern provinces had been assigned. The indignation of the people at the death of Germanicus, and the suspicion that Piso had poisoned him, forced Tiberius to order an investigation. Piso committed suicide, though it was rumoured that Tiberius, fearing incriminating disclosures, had put him to death.

See H. Schiller, *Geschichte der römischen Kaiserzeit* (1883), vol. I.

4. GAIUS CALPURNIUS PISO, Roman statesman, orator and patron of literature in the 1st century A.D., is known chiefly for his share in the conspiracy of A.D. 65 against Nero (q.v.). He was one of the most popular men in Rome, partly for his skill in poetry and music, partly for his love of luxury and generosity.

It is probably the last-named who is referred to by Calpurnius Siculus under the name of Meliboeus, and he is the subject of the panegyric *De laude Pisonis*.

PISSARRO, CAMILLE (1831-1903), French painter, was born at St Thomas in the Danish Antilles, of Jewish parents of Spanish extraction. He went to Paris at the age of twenty, and, as a pupil of Corot, came into close touch with the Barbizon masters. Though at first he devoted himself to subjects of the kind which will ever be associated with the name of Millet, his interest was entirely absorbed by the landscape, and not by the figures. He subsequently fell under the spell of the rising impressionist movement and threw in his lot with Monet and his friends, who were at that time the butt of public ridicule. Like Monet, he made sunlight, and the effect of sunlight on the objects of nature, the chief subjects of his paintings, whether in the country or on the Paris boulevards. About 1885 he took up the laboriously scientific method of the pointillists, but after a few years of these experiments he returned to a broader and more attractive manner. Indeed, in the closing years of his life he produced some of his finest paintings, in which he set down with admirable truth the peculiar atmosphere and colour and teeming life of the boulevards, streets and bridges of Paris and Rouen. He died in Paris in 1903.

Pissarro is represented in the Callebotte room at the Luxembourg, and in almost every collection of impressionist paintings. A number of his finest works are in the collection of M. Durand-Ruel in Paris.

PISTACHIO NUT, the fruit of *Pistacia vera* (natural order Anacardiaceae), a small tree which is a native of Syria and generally cultivated in the Mediterranean region. Although a delicious nut and much prized by the Greeks and other Eastern nations, it is not well known in Britain. It is not so large as a hazel nut, but is rather longer and much thinner, and the shell is covered with a somewhat wrinkled skin. The pistachio nut is the species named in Gen. xliii 11 (Heb. 192. Ar. *bofm*) as forming part of the present which Joseph's brethren took with them from Canaan, and in Egypt it is still often placed along with sweetmeats and the like in presents of courtesy. The small nut of *Pistacia Lentiscus*, not larger than a cherry stone, also comes from Smyrna, Constantinople and Greece. *P. Lentiscus* is the mastic tree, a native of the Mediterranean region, forming a shrub or small tree with evergreen pinnately-compound leaves with a winged stalk. "Mastic" (from *mosicare*, to chew) is an aromatic resinous exudation obtained by making incisions in the bark. It is chiefly produced in Asia Minor and is used by the Turks as a chewing gum. It is also used as a varnish for pictures. *P. Terebinthus*, the Cyprus turpentine tree, a native of southern Europe, Asia Minor and North Africa, yields turpentine from incisions in the trunk. A gall is produced on this tree, which is used in dyeing and tanning.

PISTIL, a term in botany for the female or seed-bearing organ of a flower (*q.v.*). The Lat. *pistillum* (diminutive from *pisere*, *pisum*, to pound), a pestle, a club-headed instrument used for crushing or braying substances in a mortar (*q.v.*), was taken as the name for this organ from its similarity in shape, and thence adapted in Fr *pistil* about the middle of the 18th century. In its complete form a pistil consists of three parts—ovary, at the base, containing the bodies which become seeds, style (Gr *στυλος*, pillar), and stigma (Gr *στυγα*, mark, *στυγαι*, to brand), the part which in impregnation receives the pollen.

PISTOIA, or **PISTOIA** (anc *Pistoria*), a town and episcopal see of Tuscany, Italy, in the province of Florence, from which it is 21 m. N.W. by rail. Pop. (1906), 27,127 (town), 68,131 (commune). It is situated on a slight eminence (210 ft.) near the Ombrone, one of the tributaries of the Arno. It is on the site of the Roman *Pistoria*, which is hardly mentioned in ancient times, except for the destruction of Catiline's forces and the slaughter of their leader near it in 62 B.C., and as a station on the road between Florentia and Luca, and earlier still by Plautus, but only with jesting allusion to the similarity of the name to the word *pistor* (baker). Hardly any inscriptions of the ancient town have been found, but excavations in 1902 (see G. Pellegrini in *Notizie degli Scavi*, 1904, p. 241) in the Piazza del Duomo led to the discovery of a large private house, which belonged to the end of the 1st century B.C. Some mosaic pavements were found, belonging perhaps to the 3rd century A.D., while the house appears to have fallen into ruin at the beginning of the 5th. Remains of four subsequent periods were discovered above it. It was found that the tradition that the cathedral occupied the site of a temple of Mars was groundless; for the house appears to have extended under it. Ammianus Marcellinus (5th century) mentions *Pistoria* as a city of *Tuscia Annonaria*. During the middle ages Pistoia was at times a dangerous enemy to Florence, and the scene of constant conflicts between the Guelphs and Ghibellines, it was there that the great party struggle took place which resulted in the creation of the Bianchi and Neri factions (see Dante, *Inferno*, xxiv. 121 to end). In 1302-06 it was besieged and eventually taken by the armies of Florence and Lucca, and in 1325 it became subject to Castruccio of Lucca. In 1351 it was obliged to surrender to Florence, and thenceforth shared its fate.

The city is still surrounded by walls, dating from shortly after the siege of 1302-06; while two inner lines of streets represent two earlier and inner lines of wall. In the early development of architecture and sculpture Pistoia played a very important

part; these arts, as they existed in Tuscany before the time of Niccolò Pisano, can perhaps be better studied in Pistoia than anywhere else, nor is the city less rich in the later works produced by the school of sculptors founded by Niccolò. In the 14th century Pistoia possessed a number of the most skilful artists in silver-work, a wonderful specimen of whose powers exists now in the cathedral—the great silver altar and frontal of St James, originally made for the high altar, but now placed in a chapel on the south side. The cathedral is partly of the 12th century, with a porch and façade with small arcades—in black and white marble, as is the case with several other churches of Pistoia—but was remodelled in the 13th century, and modernized inside in the worst taste. Besides the silver altar it contains many fine works of sculpture; the chief are the monument of Cino da Pistoia, lawyer and poet, Dante's contemporary (1337), by Cellino di Nese, surrounded by his scholars, and Verrocchio's finest work in marble, the monument to Cardinal Forteguerri (1474), with a large figure of Christ, surrounded by angels, in high relief. The clay model for it is in the South Kensington Museum. The monument has unfortunately been altered. The octagonal baptistery is by Cellino di Nese (1330). Among the earlier churches the principal is Sant' Andrea, enriched with sculpture, and probably designed by Gruamons and his brother Adeodatus in 1136; in the nave is Giovanni Pisano's magnificent pulpit, imitated from his father's pulpit at Pisa. Other churches of almost equal interest are S. Giovanni Fuorcivitas (so called because it was outside the line of the earliest, pentagonal, enceinte of the middle ages), with one of the long sides elaborately adorned with small arcades in the Pisan style, in black and white marble, also with sculpture by Gruamons (1162) on the façade. Within is a beautiful group of the Visitation by Luca della Robbia. There is also a fine pulpit by Fra Guglielmo dell' Agnello of Pisa (1270). S. Bartolomeo in Pantano is an interesting basilica of 1167. San Francesco al Prato is a fine church of the end of the 13th century with interesting frescoes of the school of Giotto. San Domenico, a noble church, begun in 1294, contains the beautiful tomb of Filippo Lazari by Bernardo and Antonio Rossellino (1462-1468). In addition to its fine churches, Pistoia contains many noble palaces and public buildings. The Palazzo del Comune and the Palazzo Pretorio, once the residence of the podestà, are both fine specimens of 14th-century domestic architecture, in good preservation. The quadrangle of the latter contains many well-painted armorial bearings of the podestà. The Ospedale del Ceppo, built originally in the 13th century, but remodelled in the 15th, is remarkable for the reliefs in enamelled and coloured terra-cotta with which its exterior is richly decorated. Besides various medallions, there is a frieze of figures in high relief extending along the whole front, over its open arcade. The reliefs consist of a series of groups representing the Seven Works of Mercy and other figures, these were executed by Giovanni Della Robbia between 1514 and 1525, and, though not equal to the best work of Luca and Andrea, are yet very fine in conception and modelling, and extremely rich in their general decorative effect. The last on the right was added in 1585 by Paladini.

The industries of Pistoia include iron and steel works, especially manufactures of glass, silk, macaroni, woollens, olive oil, ropes, paper, vehicles and fire-arms. The word "pistol" is derived (apparently through *pistolese*, a dagger—dagger and pistol being both small arms) from Pistoia, where that weapon was largely manufactured in the middle ages.

PISTOIA, SYNOD OF, a diocesan synod held in 1786 under the presidency of Scipione de' Ricci (1741-1810), bishop of Pistoia, and the patronage of Leopold, grand-duke of Tuscany, with a view to preparing the ground for a national council and a reform of the Tuscan Church. On the 26th of January the grand-duke issued a circular letter to the Tuscan bishops suggesting certain reforms, especially in the matter of the restoration of the authority of diocesan synods, the purging of the missals and breviaries of legends, the assertion of episcopal as against papal authority, the curtailing of the privileges of the monastic orders, and the better education of the clergy.

In spite of the hostile attitude of the great majority of the bishops, Bishop de' Ricci issued on the 31st of July a summons to a diocesan synod, which was solemnly opened on the 18th of September. It was attended by 233 benefited secular and 13 regular priests, and decided with practical unanimity on a series of decrees which, had it been possible to carry them into effect, would have involved a drastic reform of the Church on the lines advocated by "Febronius" (see FEBRONIANISM).

The first decree (*Decretum de fide et ecclesia*) declared that the Catholic Church has no right to introduce new dogmas, but only to preserve in its original purity the faith once delivered by Christ to His apostles, and is infallible only so far as it conforms to Holy Scripture and true tradition; the Church, moreover is a purely spiritual body and has no authority in things secular. Other decrees denounced the abuse of indulgences, of festivals of saints, and of processions and suggested reforms; others again enjoined the closing of shops on Sunday during divine service, the issue of service-books with parallel translations in the vernacular, and recommended the abolition of all monastic orders except that of St. Benedict, the rules of which were to be brought into harmony with modern ideas; nuns were to be forbidden to take the vows before the age of 40. The last decree proposed the convocation of a national council.

These decrees were issued together with a pastoral letter of Bishop de' Ricci, and were warmly approved by the grand-duke; at whose instance a national synod of the Tuscan bishops met at Florence on the 23rd of April 1787. The temper of this assembly was, however, wholly different. The bishops refused to allow a voice to any not of their own order, and in the end the decrees of Pistoia were supported by a minority of only three. They were finally condemned at Rome by the bull *Auctorem fidei* of the 28th of August 1794. De' Ricci, deprived of the personal support of the grand-duke (now the emperor Leopold I.), exposed to pressure from Rome, and threatened with mob violence as a suspected destroyer of holy relics, resigned his see in 1791, and lived in Florence as a private gentleman until his death in 1810. In May 1805, on the return of Pope Pius VII. from Paris, he had signed an act of submission to the papal decision of 1794.

De' Ricci's own memoirs, *Memoria di Scipione de' Ricci, vescovo di Prato e Pistoia*, edited by Antonio Galli, were published at Florence in 2 vols. in 1865. Besides this his letters to Antonio Marini were published by Cesare Guasti at Prato in 1887; these were promptly put on the Index. See also De Potter, *Vie de Scipion de' Ricci* (3 vols, Brussels, 1825), based on a MS. life and a MS. account of the synod placed on the Index in 1823. There are many documents in Zotti, *Storia civile della Toscana*, vols. ii. and iii. (Florence, 1856). The acts of the synod of Pistoia were published in Italian and Latin at Pavia in 1788.

PISTOL, a small fire-arm designed for quick work and personal protection at close quarters, and for use in one hand. It was originally made as a single and also double-barrelled smooth bore muzzle-loader, involving no departure in principle from the

History.—Pistols are understood to have been made for the first time at Pistoia in Italy, whence they receive their name. Caminello Vitelli, who flourished in 1540, is the accredited inventor. The first pistols, in the 16th century, had short single barrels and heavy butts, nearly at right-angles to the barrel. Shortly afterwards the pattern changed, the butts being lengthened out almost in a line with the barrels. These early pistols were usually fitted with the wheel-lock (see GUN). Short, heavy pistols, called "daggs," were in common use about the middle of the 17th century, with butts of ivory, bone, hard wood or metal. A chiselled Italian dagg of 1650, for example, had a slightly bell-nosed barrel of about 8 in. in length and 14 bore. The German wheel-lock military pistols used by the Reiters, and those made for nobles and gentlemen, were profusely and beautifully ornamented. Pistols with metal hafts were common in the 16th and 17th centuries, many beautiful specimens of which, silver-mounted, were made in Edinburgh and used by Highlanders. Duelling, when in vogue, caused the production of specially accurate and well-made single-barrelled pistols, reliable at twenty paces. The pattern of this pistol seldom varied, its accuracy at short range equalling that of more modern ones, the principle of a heavy bullet and light charge of powder being employed. The first double-barrelled pistols were very bulky weapons made with the barrels laid alongside one another, necessitating two locks and two hammers. There was also the "over and under" pistol, one barrel being laid over the other. This was a more portable weapon, only requiring one lock and hammer, the second barrel being turned round by hand, after the first had been fired, or, as an alternative, the flash-hole being adjusted to the second barrel by a key. These pistols were first made with flint and steel locks and subsequently for percussion caps. Double "over and under" pistols were also made with a trigger mechanism that served to discharge both barrels in turn.

Revolvers.—A revolver is a single-barrelled pistol with a revolving breech containing several chambers for the cartridges, thus enabling successive shots to be rapidly fired from the same weapon without reloading. The ordinary pistol is now, and has been for many years past, superseded by the revolver. The first revolver, fired with the percussion cap, was made with the whole of the barrels, six, seven or eight, revolving in one piece, and was known as the "pepper-box." It was "single action," i.e. the hammer was raised and the barrels revolved by the pull of the trigger. This weapon was cumbersome and no accurate aim could be taken with it owing chiefly to the strength and resistance of the main-spring and the consequent strong pull required on the trigger. The principle of a revolving breech to one barrel, which superseded the "pepper-box," is an old one in the history of fire-arms, dating from the 16th century. At

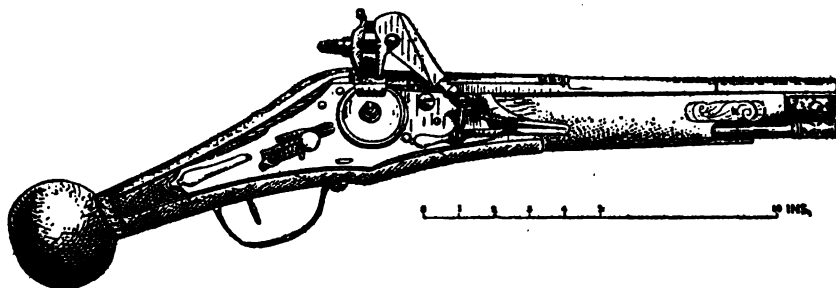

FIG. 1.—Dagg (Royal United Service Institution).

ordinary fire-arms of the day. With the introduction of revolvers and breech-loading pistols and the application of "rifling" to musket barrels, came also, in the early half of the 19th century, the rifling of pistol-barrels.

first the breech cylinder was revolved by hand, as in the revolving arquebus or matchlock, a specimen of which is now in the

¹ For the use of long heavy pistols by cavalry in the 16th and 17th centuries. see ARMY: HISTORY; and CAVALRY.

Tower of London, but this was subsequently improved by introducing geared mechanism, by which the pull of the trigger or the cocking of the hammer, or both, do the work. There exists a pistol of the time of Charles I. which is rotated automatically as the hammer is raised.

rapidly fired, if necessary, by the trigger action alone. Many revolvers on the Colt principle were in use during the Crimean War and the Indian Mutiny, and proved of valuable service to British officers.

As rim-fire, pin-fire and central-fire cartridges were succes-

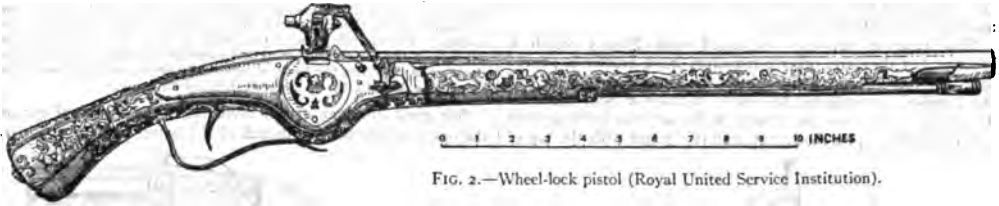

FIG. 2.—Wheel-lock pistol (Royal United Service Institution).

In 1814 a self-acting revolver mechanism of a crude pattern was produced in England. Four years later Collier used a separate spring to rotate the chamber. In 1835, an American, Samuel Colt, produced and patented the first practical revolving pistol, the idea of which was obtained by him. It is stated, from an ancient "revolving" weapon in the Tower of London. The chambers of the first Colt revolver were loaded with powder and bullets from the muzzle end, and each chamber had a nipple that required to be capped. It was the invention of the copper cap that made the Colt revolver possible. Under the old

sively introduced, breech-loading revolvers were constructed to use them. Messrs Smith & Wesson, of Springfield, U.S.A., produced the first metal cartridges for revolvers. Pin-fire cartridges, paper and metallic, were used on the continent of Europe for Lefauchaux and other revolvers, and these and rim-fire cartridges are still used for revolvers of small calibre. But since the central-fire cartridge has proved its superiority for guns, its principle has been generally applied to pistol cartridges, at first to the larger bores.

The alteration of the muzzle-loading to the breech-loading

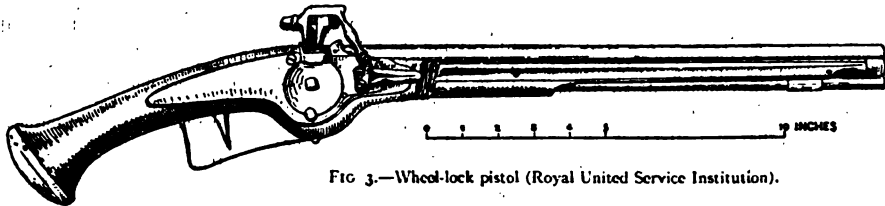

FIG. 3.—Wheel-lock pistol (Royal United Service Institution).

priming system with exposed powder in a pan the difficulty of separate and effective ignition with the revolving cylinder was almost insuperable.

The first American revolver makers caused the cocking of the hammer to revolve the cylinder, while the English makers effected this by the pull of the trigger. In 1835, Adams of London, and also Tranter of Birmingham, brought out the double-action revolver, in which the revolution of the cylinder could be effected by both these methods. When the revolver is cocked and fired by pressing the trigger, greater rapidity of

chamber in the revolver involved no decided change of type. The original Colt, as a breech-loader, remained practically the same weapon as before, with a changed chamber. A hinged flap uncovered the breech-chamber on the right, and as each chamber reached that point the empty cartridge case was ejected by means of an ejecting-rod carried in a tube attached to the under side of the barrel and kept in place by a spiral spring, and the chamber reloaded. The next improvement was greater ease and rapidity of extraction, obtained first by Thomas's invention of making the barrel and chamber slide

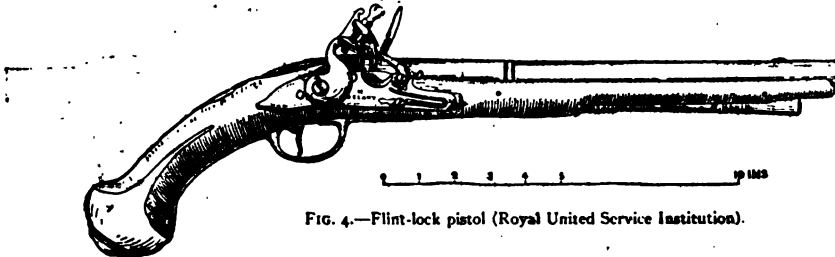

FIG. 4.—Flint-lock pistol (Royal United Service Institution).

fire is obtained than when the hammer is cocked with the thumb, but accuracy is impaired, as the trigger requires a long pull and considerable force in order to compress the mainspring and revolve the cylinder. The double action revolver was, therefore, a great advance on the single action, enabling the first and also following shots, if desired, to be accurately fired by a moderate pressure of the trigger after the hammer had been cocked by the thumb; or, alternatively, the revolver could be

forward on the frame of the pistol. The extractor, being fast to the pivot, retained the cartridges until the chamber was pushed clear of them. Then the chamber was made to swing on one side, as in the Colt pistol illustrated, enabling all the cartridges to be simultaneously extracted. Finally, self-extracting revolvers with jointed frames were introduced, in which the dropping of the barrel forces out the extractor as in an ordinary double gun, the extractor acting simultaneously in all the chambers of

the pistol. A spring returns the extractor to its place when the empty cartridge cases have been ejected, and brings the barrel to an angle of about 45°, for convenience in loading. The soundness and rigidity of the weapon depend upon the efficiency of the connexion between the barrels and the standing breech, and a top snap bolt has proved the strongest and handiest with the pistol, as with the shot-gun.

This type of revolver originated with Messrs Smith & Wesson, but they and other gunmakers have greatly improved upon the original model. Between the American pattern and the English, as made by Messrs F. Webley & Son, the chief difference is that in the Smith & Wesson the holding-down bolt or catch is upon the barrel, and it engages with the top of

hammer and trigger when the latch is pushed to the rear for opening the cylinder, and does not unlock them until the cylinder is positively closed and is locked by the latch. The cylinder revolves and is supported on a central arbour of the crane (E). The crane fits in a recess in the frame below the barrel and turns on its pivot arm (A). The ejector rod with its spring passes through the centre of the cylinder arbour and is terminated in rear by the ejector with a ratchet (y). Pushing against the front end of the ejector rod will empty the chambers, the cylinder being swung out for loading. The thumb-piece of the latch (j) slides to the rear in the left side of the frame, unlocking the cylinder for opening, but upon closing the cylinder, the body of the latch firmly enters a recess in the ejector, locking the cylinder in position for firing.

One great disadvantage of revolvers is the escape of gas at the opening between the breech of the barrel and the cylinder.

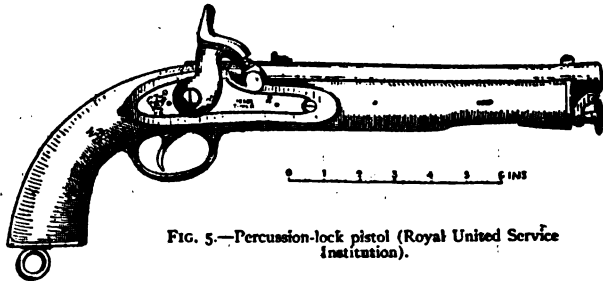

FIG. 5.—Percussion-lock pistol (Royal United Service Institution).



FIG. 6.—Pepper-box revolver.

the standing breech; whereas in the Webley the bolt is upon the standing breech and grips the extremity of the hinged barrel. Neither mechanism is as strong as could be wished if heavy charges of smokeless nitro-compounds are to be used. This hinged type of revolver is most convenient for use on horseback, as the pistol can be opened, the cartridges extracted and the weapon reloaded with one hand.

The *Colt's Double-action Revolver*, calibre .38, model 1896, used in the United States army, consists (figs. 7 and 8) of the barrel (B), the cylinder (C) with six chambers, the frame (F), and the firing mechanism, all of steel. The muzzle velocity, with a charge of 16 grains of black powder and a bullet of 150 grains of lead, is about 708 ft. per second, giving at 25 yards a penetration of about 5 in. in pine.

The lock mechanism consists of the hammer (h), with its stirrup (r), stirrup pin (p), strut (s), strut pin (i), strut spring (g); the trigger (t); the rebound lever (l); the hand (H), with the spring (e); the cylinder bolt (b), with its spring (x); the locking lever (v); the main spring (m), and rebound lever spring (n). The hammer (h), trigger (t), and rebound lever (l) are pivoted on their respective pins, which are fastened in the left side of the frame. The lower end of the rebound lever spring (n) is secured to the frame and the free end bears under the rear end of the rebound lever so that the latter, when the trigger is released, cams the hammer back to its safety position, and forces the trigger forward. Pressure upon the trigger causes its upper edge to engage the strut, and thereby raises the hammer until nearly in the full-cock position, when the strut will escape from the trigger, and the hammer, under the action of the main-spring, will fall and strike the cartridge. A projection on the upper part of the trigger, working in a slot in the frame, prevents the cylinder from making more than one-sixth of a revolution at a time by entering one of the grooves nearest the rear end of the surface of the cylinder. When the cylinder is swung out of the frame, the parts are arranged to prevent the cocking of the hammer. The cylinder bolt is pivoted on the trigger pin, and its spring, bearing on the rebound lever arm, causes the nose of the bolt to project through a slot in the frame ready to enter one of the rectangular cuts in the cylinder surface. During the first movement of the trigger in cocking the revolver, the nose of the bolt is withdrawn, allowing free rotation of the cylinder. The object of the bolt is to prevent rotation of the cylinder in transportation. The hand is attached by its pivot to the trigger, and, as the latter swings on its pin when the hammer is being cocked, the hand is raised and revolves the cylinder, and also serves to lock the cylinder in position at the time of firing. An abutment on the side plate supports the hand spring in rear. The spring ensures the engagement of the hand with the ratchet (y). The revolver is cocked by hand by withdrawing the hammer by the pressure of the thumb until its full-cock notch engages in the rear sharp corner of the trigger. Pulling the trigger then releases the hammer, allowing its firing pin (f) to move forward and strike the cartridge.

The locking lever is pivoted by its screw in a recess in the left side of the frame, and so connected with the latch that it locks the

employing a long cartridge case which extends beyond the nose of the bullet and bridges the gap between barrel and cylinder as the cylinder is moved forward. A "mitrailleuse" pistol has also been constructed by the Braendlin Armoury Co., Ltd., on the "pepper-box" principle, with fixed barrels, either four or six, arranged in pairs, and a special striking mechanism, in which there is no revolving chamber and no escape of gas at the breech. It gives stronger shooting than a revolver, but is more cumbersome, and has the serious defect that the shock of the discharge of one barrel sometimes prematurely fires a second barrel.

In 1805, Sharp, an American, patented an invention to remedy the escape of gas, in which the four barrels of the pistol

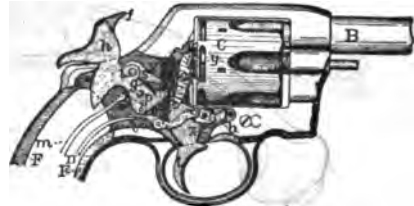
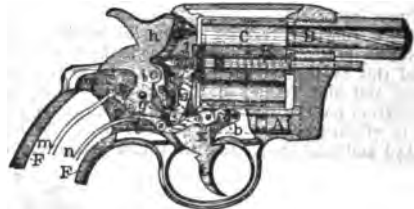

FIGS. 7 and 8.—Colt double-action revolver.

were drilled the full length out of one block of metal. The barrels were slid forward by an under lever to load, and the firing was effected by a revolving head to the hammer, set by the action of cocking the pistol.

About 1878 Messrs Lancaster introduced both two- and four-barrelled hammerless pistols, in which an internal hammer was worked by the pull of the trigger. In all the three weapons

above mentioned, extraction and reloading were slow processes, which made them unsuited for use on horseback.

Hammerless Revolver.—The Smith & Wesson pocket pistol is one of the safest weapons of the size made. There is no

and fires a charge of 1½ drams of powder without unpleasant recoil. The duelling pistol, as made by Gartinne Renette of Paris, is capable of wonderfully accurate shooting, firing a 9 millimetre spherical bullet and about 12 grs. of powder. This

Maker's Name.	Description of Revolver.	No. of Shots.	Calibre.	Length of Barrel.	Length over all.	Weight.		Cartridge.	
						lb	oz.	Powder Weight.	Bullet Weight.
Colt	New Service	6	.45	5½	10½	2	8	40	250
	New Army	6	.38	4½	9½	2	0	21	158
	New Police	6	.32	4	8½	1	2	13	98
	New Pocket or Pocket Positive	6	.32	2½	6½	1	0	12	82
	Police Positive	6	.38	4	8½	1	5½	14	150
Smith & Wesson	Double Action	5	.32	3	7½	0	12½	10	88
	Safety Hammerless	5	.32	3	7½	0	14½	10	88
	Single Action Target	6	.38/.44	3	7½	1	3½	20	146
	Single Action Bisley model	6	.45	3	12½	1	9	13	226
	Military and Police	6	.38	6½	12½	1	15½	21½	158
	Hand Ejector	7	.22	3	6½	0	9½	5	40
Webley	British Govt. Mark IV	6	.455	4	9	2	3	18	265
	"W.G." Army model	6	.455	6	11½	2	8	18	265
	"W.G." Target	6	.455	7½	13½	2	10	18	265
	Mark III	6	.380	3	7½	1	4	3 Cor	145
	"W.P." Pocket model	6	.320	3	7½	1	1	6	80
	R.I.C. No. 1	6	.450/.455	4½	9½	1	14	18	265

hammer or equivalent protuberance to catch as the pistol is drawn from the pocket; or to entangle if the weapon falls. An automatic safety bolt, whose length lies half across the palm of the hand, and ensures certainty of freedom at the time of shooting, blocks the action until the pistol is firmly gripped for use.

Breech-loading Pistols.—Although the revolver has for many years practically superseded the pistol, some breech-loading

weapons is far superior in accuracy to a revolver. Single-barrelled pistols, chambered for the .22 or 297/230 calibre cartridges, with a barrel of from 6 to 10 in. in length, are also made, and when fitted with a detachable metal stock form excellent little weapons for target practice.

Automatic Revolver.—The Webley-Fosbery automatic revolver is a weapon of a distinctly new design, in which for the first time the principle of utilizing the recoil of each shot to operate the mechanism is applied to the revolver. In appearance the weapon is very similar to the Webley service model. The simple pressure of the forefinger on the trigger, the pressure being released between each shot, is all that is required to fire the six successive shots of the revolver. It is supplied with a safety bolt worked by a thumb-piece, and Messrs Webley have introduced a clip loader which enables the six chambers to be reloaded at the same time. This weapon has met with considerable success, and is made in two calibres, the .455, 6 shot, 2 lb 5½ oz. in weight; and the .38 model, 8 shot, 2 lb 3 oz. in weight.

Automatic Pistols.—These weapons are the latest and most advanced type of pistol, and it is anticipated by experts that they will ultimately supersede the revolver. They are made with one barrel and a magazine, on the principle of the repeating rifle, thus doing away with the escape of gas that takes place in revolvers between the chamber and the barrel.

Automatic pistols are so constructed that the force of the recoil is utilized to open the breech, extract the empty case, cock the pistol, reload the chamber with the top cartridge from the magazine, and close the breech, leaving the pistol ready to fire on again pressing the trigger.

The Mauser "self-loading" pistol (fig. 9) is one of the earliest of the successful automatic weapons. It is usually .300 calibre, 10 shot, with a metal clip loader from which the cartridges are "stripped" into the magazine, weight 2½ lb, length of barrel 5½ in.; bullet 85 grains, initial velocity about 1394 f.s.

The barrel (1) and body (2) are in one piece; the latter contains the bolt (3). The barrel and body slide on the frame (4); the 10-shot magazine (5) and the stock are in one piece with the frame, and the lock frame (6) and lock-work are contained in the rear part of it. The bolt (3), which is square, slides in the body, and is kept pressed up to the chamber by the bolt spring (8); the rear end of this bolt spring bears against the block (9). The striker and extractor are contained in the bolt. The bolt is locked by the bolt-lock (10). This is slotted through the centre and fits on to the projection (11) under the body; it is supported at the moment of firing by a projection on the lock frame (12); the top of the bolt-lock has two teeth (13), which in the loaded and cocked position fit into two recesses in the bolt, and the bottom of its front end [in front of the body attachment (11)] has another tooth (14) which bears on the rocker (15). This rocker is pivoted at its bottom corner. The main-spring (16) bears in front against the rocker, and in rear against the hammer mechanism. The action of the mechanism is

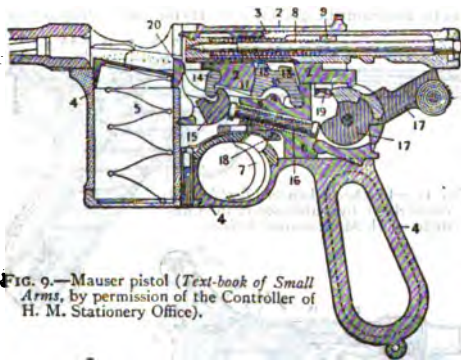
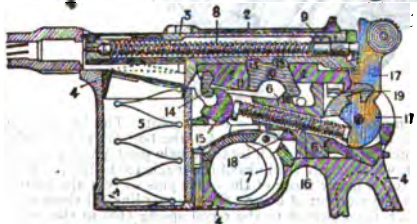

FIG. 9.—Mauser pistol (*Text-book of Small Arms*, by permission of the Controller of H. M. Stationery Office).



varieties of pistols are still made—the small pocket pistol, for example, and occasionally the heavy double-barrelled horse pistol. At one time these latter were much used, of .577 bore, as well as the well-known short, large-bore pistol known as the Derringer, usually of .41 calibre. The double horse pistol is now usually made for a 20-bore cartridge and spherical bullet, and weighs about 3½ lb. It is a clumsy, but effective weapon,

as follows. On pressing the trigger, the trigger nose lifts the lever (18) which is attached to the sear (19), the lifting of the sear allows the main-spring to act backwards on the hammer, which impinges on the striker and fires the cartridge. At this moment the bolt is locked by the two upper teeth (13) of the bolt-lock, which is itself held up by the lock frame projection (13). But, the barrel body and bolt recoiling together $\frac{1}{2}$ of an in., the rear end of the bolt-lock (10) is no longer supported, the rocker (15) acting on the forward tooth (14) pulls down the bolt-lock and its upper teeth, the nose of the bolt-lock falling into the recess just behind the projection (12). Thus the barrel and body come to a standstill and the remaining recoil energy is used in driving back the bolt (now free) and extracting the cartridge case. When this energy is used up the bolt spring (8) reasserts itself, drives the bolt forward and pushes another cartridge into the chamber as in the magazine rifle, and the main-spring, acting on the rocker, pulls up the bolt-lock again and engages the teeth (13) in the bolt, locking it for

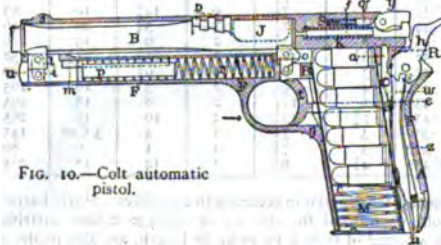

FIG. 10.—Colt automatic pistol.

the next shot. The releasing of the trigger brings the sear (19) to its former position, cocking the pistol.

This pistol is usually supplied with a wooden holster which can also be attached to the grip of the pistol and so form a shoulder-stock for long-range shooting. It is sighted from 50 to 1000 yards.

The *Colt Automatic Pistol, calibre .38* (fig. 10) consists of four main parts, namely the frame (F), the barrel (B), the slide (S), and the magazine (M). The frame forms, at its rear and lower part, the handle (A), which is hollow, and contains the seat for the magazine. After being charged with seven cartridges, the magazine is seated from below and held in place by the magazine catch (n) which slightly projects from the bottom of the handle. This projection serves to release the magazine from the catch, when it can be readily drawn from the handle for re-charging. In front of the handle is the trigger guard (g), in which the trigger (t) is found, and in the rear and above the grip the firing mechanism is placed in the part of the frame called the receiver (R). The firing mechanism consists of the hammer (h), the sear (w), the trigger (t), a safety device (e), the main-spring (s) and sear spring (e), the lower part of the latter serving to operate the magazine catch. The top of the receiver extends forward from the handle, and to it the barrel is attached by two short links, one (f) near the front end of the barrel, and the other (o) at its rear end; these links are pivoted to the receiver and also to the barrel, and allow the barrel to swing rearwards thereon. As both links are of the same length, the rearward movement of the barrel in swinging on these links carries the barrel slightly downwards, but keeps its longitudinal axis in parallel positions during all its movements. Below the barrel the receiver forms a tubular seat for the retractor spring (r), which in front is closed by a plug (u) fastened in the receiver by the lower pivot-pin (i) of the front barrel-link. The upper surface of the receiver and two longitudinal grooves on its sides form the seat for the slide, which is guided thereon in its rearward and forward movements. The rear part of the slide forms the bolt or breech block (K), and the front part forms a partly tubular cover (s) which encloses the barrel. In the forward part of the receiver is a transverse mortise extending through the retractor spring seat, and transverse recesses in the forward part of the slide serve to admit a key (m) which, passing through the sides of the slide and through the mortise, serves to lock the slide to the frame. The retractor spring (r), in its seat in the frame, consists of a spiral spring, the rear end of which rests against the receiver, and the front end of which carries a piston (p). The rear face of the key (m) has a slight recess, and when the key is in its place the front end of the retractor spring rests in this recess, thereby confining the key laterally. The tension of the retractor spring is exerted to force the key and the slide to their forward position. Upon the barrel are provided three transverse ribs (b), and in the interior of the slide are three corresponding recesses. These serve to lock the barrel and the slide firmly together when in their forward position. Between the locking recesses and the bolt, the slide has an opening on its right side for the ejection of the cartridge cases (J), and the bolt is provided with an extractor, a firing pin (f), a firing pin retraction

spring (g), and a firing pin lock (y). This latter is pivoted at the rear end in the top of the slide, and when depressed, locks the firing pin in its retracted position, thus preventing its point from coming in contact with the cartridge primer. When raised, the firing pin lock releases the firing pin, and in this position also serves as the rear sight, being provided on the top with a sighting notch.

The operation of the pistol is as follows: When a charged magazine (M) is inserted, the slide (S) is drawn once to the rear by hand, thereby cocking the hammer (h). In this position of the slide, the carrier (c) and carrier spring in the magazine raise the topmost cartridge so as to bring it into the path of the bolt (K). On releasing the slide, it, with the bolt, is carried forward by the retractor spring (r), and during this movement the bolt forces the topmost cartridge into the barrel (B). As the slide approaches its forward position the front of the bolt encounters the rear end of the barrel and forces the latter to its forward position. During this forward movement the barrel swings forward and upward on the links (f, o), and thus the locking ribs (b) on the barrel are carried into the corresponding locking recesses in the slide. The barrel and slide are thereby interlocked, and the pistol ready for firing.

A slight pull on the trigger (t) now serves to move the sear (w) so as to release the hammer (h) and fire a shot. The force of the powder gases driving the bullet from the barrel is exerted rearwardly against the bolt, and, overcoming the inertia of the slide and the tension of the retractor spring, causes the slide and the barrel to recoil together. After moving rearwards together, for a distance, enough to ensure the bullet having passed from the barrel, the downward swinging movement of the barrel releases the latter from the slide and stops the barrel in its rearmost position. The momentum of the slide causes the latter to continue its rearward movement, thereby again cocking the hammer and compressing the retractor spring, until, as the slide arrives at its rearmost position, the empty shell is ejected from the side of the pistol and another cartridge raised in front of the bolt. During the return or forward movement of the slide, caused by the retractor spring, the cartridge is driven into the barrel, and the slide and barrel are interlocked, thus making the pistol ready for another shot. These operations may be continued so long as there are cartridges in the magazine, each discharge requiring only the slight pull on the trigger. The pistol is provided with a safety device (e) which makes it impossible to release the hammer unless the slide and barrel are in their first forward position and interlocked.

In the Borchardt-Leuger pistol (fig. 11) the bolt is solidly supported

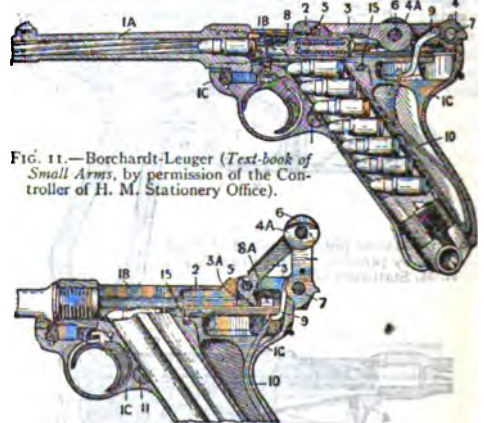

FIG. 11.—Borchardt-Leuger (Text-book of Small Arms, by permission of the Controller of H. M. Stationery Office).

at the moment of firing by a toggle joint. The barrel (1 A) and body (1 B) slide in the frame (1 C), the bolt (2) slides in the body and is held up to the breech by the toggle joint 3 and 4 and the pins 5 and 7, which secure the links of the toggle to the body. The crest of pin (6) is below those of the other pins so that the joint cannot bend at the moment of firing. On the rear link (4) there is a swivel (g) which is connected to the recoil spring (10) in the grip. This pistol is fired by a spring striker, like a rifle, instead of by a hammer. The striker is within the bolt; it is cocked in the recoil position by a claw on the end of the front link (3 A) and held thus when ready to fire by the nose of the trigger sear, these engaging with a projection (8 A) on the side of the striker. The magazine (8 shot) is in the grip. The action is as follows: the first cartridge is loaded from the magazine by pulling back the toggle joint. As soon as the toggle joint is released the recoil spring acts and forces the bolt home, with the cartridge in front of it. On pressing the trigger the barrel and body recoil a little. Then the toggle joint comes

against curved ramps on the sides of the non-recoiling frame and is forced up, so that thereafter the bolt alone recoils (the ejector is similar in principle to that of a rifle). The recoil spring then acts as before on reloading.

Other varieties of the automatic pistol are the "Mannlicher," the "Mars," the "Bergmann" and the "Webley." The last, being simple in construction, small and light, weight 18 oz. and length over all only 6½ in., may be classed as a pocket pistol.

Qualities of Automatic Pistols.—In reference to the general qualities of automatic pistols, while these weapons have the advantage over revolvers of longer range and greater rapidity of fire and recharging, on the other hand they are necessarily more complicated in their mechanism, which has to do the work of extraction, reloading and cocking that in the revolver is done by hand. A stoppage may occur through a cartridge missing fire, or continuous uncontrolled fire may take place through the trigger spring breaking until the magazine is exhausted. Their action is also to some extent uncertain, as it depends on the recoil of the discharge, which may be affected by variables in the cartridge; also the effective automatic working of the moving parts depends upon their cleanliness and lubrication. As automatic pistols, like revolvers, are intended for personal defence at short range and for sudden use in emergencies, simplicity of mechanism and certainty of action are in their case of paramount importance. There is usually no time to rectify a stoppage or jam, however slight. From a military point of view, therefore, before the revolver is altogether superseded by the automatic pistol, it is most desirable that the latter should be as certain in its action under service conditions as the former. Some automatic pistols, as already stated, are sighted up to 300 yards, and provided with attachable butts. The practical value of these improvements is open to question, as the sighting of a pistol differs materially when used with and without a butt, and under no circumstances can the accuracy of shooting of a pistol, even with a butt, equal that of a carbine.

The tendency in automatic pistols has been to reduce the bore to .3 in., and increase the muzzle velocity, on the lines of modern small-bore rifles. These, again, would appear to be advantages of minor importance in a weapon intended for use at short range in the field, where a heavy bullet of fairly large diameter, with a moderate muzzle velocity, has a more immediate and paralyzing effect, and is therefore, from this point of view, and particularly in savage warfare, preferable to a small projectile of high muzzle velocity. (H. S.-K.)

PISTOLE, the French name given to a Spanish gold coin in use from 1537; it was a double *escudo*, the gold unit, and was worth 16s. 11½d. sterling. The name was also given to the *louis d'or* of Louis XIII. of France, and to other European gold coins of about the value of the Spanish coin.

PISTON (through Fr. from Ital. *pistone* or *pestone*, a great pestle, from Late Lat. *pistare*, to pound, a frequentative form of classical Lat. *pisere*), in the steam engine, a disk or partition placed inside the cylinder, from end to end of which it moves alternately under the pressure of the steam. By means of the "piston-rod" attached to it this forward and backward motion is communicated to the machinery which the engine is employed to drive, and is in most cases converted into rotary motion by a "connecting-rod," one end of which is jointed to the "cross-head" carried at the end of the piston-rod, while the other turns the crank on the crank-shaft. The piston in gas, oil and air engines has a similar function, but in a pump, instead of imparting motion, it has motion imparted to it by some prime-mover. In every case the piston must fit the cylinder so accurately that as little as possible of the working fluid, whether it be steam, gas or water, can escape past it, packing of various forms being commonly placed round its periphery in order to secure this fit. In music, the valves which in certain wind instruments, such as the cornet, enable the player to increase the length of the air-column and thus lower the note produced, are known as pistons. (See *VALVES*.)

PIT (O. E. *pytt*, cognate with Du. *put*, Ger. *Pfütze*, &c. all ultimately adaptations of Lat. *puticus*, well, formed from root *pu-*, to cleanse, whence *purus*, clean, pure), a term of wide application for a hole, cavity or excavation in the earth or other

surface; thus it is applied to the excavations made in the ground for the purpose of extracting minerals, e.g. chalk, gravel or sand, or for carrying on some industry, e.g. tan-pit, saw-pit, or to the group of shafts which form a coal-mine. Roots and other vegetables can be stored in the winter in a pit, and the term in this transformed to a heap of such vegetables covered with earth or straw. The word is also used of any hollow or depression in a surface, as in the body, the arm-pit, the pit of the stomach, or on the skin, as the scars left by small-pox or chicken-pox. As applied to a portion of a building or construction, the word first appears for an enclosure, often sunk in the ground, in which cock-fighting was carried on, a "cock-pit." It would seem a transference of this usage that gave the common name to that part of the auditorium of a theatre which is on the floor, the French *parterre*. In the United States a special usage is that of its application to that part of the floor space in an exchange where a particular branch of business is transacted; thus in the Chicago Board of Trade, transactions in the grain trade are carried on in what is known as the "Wheat Pit."

In Scottish legal history there was a baronial privilege which in Latin is termed *furca et fossa*, "fork (i.e. gallows) and pit"; here the term has usually been taken to refer to the drowning-pit, in which women criminals were put to death; others take it to refer to an ordeal pit. There is a parallel phrase in M. Dutch, *putte ends galghen*; here *putte* is the pit in which women were buried alive as a penalty.

PITCAIRN, an island in the mid-eastern Pacific Ocean, in 25° 3' S., 130° 6' W., belonging to Great Britain. It lies south of the Paumotu archipelago, 100 m. from the nearest member of this group. Unlike the majority of the islands in this region, it is without coral reefs, but rises abruptly with steep and rugged cliffs of dark basaltic lava. The extreme elevation is over 2000 ft., and the area 2 sq. m. The soil in the valleys is volcanic and fertile, but the gradual utilization of natural timber increases the liability to drought, as there are no streams. The climate is variable and rainy. Stone axes, remains of carved stone pillars similar to those of Easter Island, and skeletons with a pearl-mussel beneath the head have been found in the island, though it was uninhabited when discovered by Philip Carteret in 1767. Pitcairn was the name of the midshipman who first observed it.

The island was destined to become the scene of a curious social experiment. On the 28th of April 1789 a mutiny broke out on board the "Bounty," then employed by the British government in conveying young bread-fruit trees from Tahiti to the West Indies. The commander, Lieutenant William Bligh, was set adrift in the launch with part of the crew, but managed to make his way to Timor in the Malay Archipelago. The twenty-five mutineers at first all returned to Tahiti. Some remained, and six of these were ultimately court-martialled in England, three being executed in 1792. Meanwhile in 1790 a party consisting of Fletcher Christian, the leader of the mutiny, eight Englishmen, six Polynesian men and twelve Polynesian women had taken possession of Pitcairn Island and burned the "Bounty." Treachery and debauchery filled the first years of the annals of the beautiful island. By 1800 all the men were dead except Alexander Smith, afterwards known as John Adams, who rose to a sense of his responsibility and successfully trained up the youthful generation left in his charge. An American vessel, the "Topaze," discovered the strange colony in 1808; again, by accident, it was visited by the "Briton," Captain Sir F. Staines, and the "Tagus," Captain Pipon, in 1817; and by the exploring ship "Blossom" in 1825. On the death of John Adams on the 29th of March 1829 George Hunn Nobbs, who had settled at Pitcairn in 1828, was appointed pastor and chief magistrate. Through fear of drought the islanders removed to Tahiti in 1830, but disapproved of both the climate and the morals of this island, and returned to Pitcairn in 1831. Shortly after this an adventurer named Joshua Hill appeared, and, claiming government authority, tyrannized over the islanders till his removal by a British man-of-war in 1838. In 1856 the whole of the islanders—60 married persons and 134 young men, women and children—were landed on

Norfolk Island, but in 1858 two families chose to return, and their example was afterwards followed by a few others. Visited in 1873 and 1878 the colony was found in excellent order, but by the end of the century it was stated that intermarriage was bringing a deterioration of intellect, morals and energy, and that the islanders would probably drift into imbecility. Later accounts made it appear that this was an exaggeration, although the standard of morality was unquestionably low on the whole.

In religion the islanders are Seventh Day Adventists. "They have adopted an extraordinary patois, derived from the language of the Tahitian women who accompanied the mutineers of the "Bounty" to Pitcairn Island, although most of the adults can speak the English language fairly well" (R. T. Simons, *Report*, 1905). The island is a British colony by settlement, and is within the jurisdiction of the High Commissioner for the Western Pacific (since 1898). There is a governing body chosen from among the islanders, the constitution of which has been altered more than once owing to internal jealousies, &c. The island produces sweet potatoes, yams, melons, bananas and other fruits, arrowroot and coffee. Goats and chickens run wild. Some trade is carried on with Mangareva in a vessel owned by the islanders. The population is about 170.

BIBLIOGRAPHY.—J. Shillibeer, *The "Briton's" Voyage to Pitcairn's Island* (London, 1818); F. W. Beechey, *Voyage to the Pacific* (London, 1831); Sir J. Barrow, *History of the Mutiny of the "Bounty"* (London, 1831); W. Brodie, *Pitcairn's Island . . . in 1850* (London, 1851); C. E. Meinicke, *Die Insel Pitcairn* (Prenzlau, 1858); T. B. Murray, *Pitcairn* (London, 1860), revised to date by C. C. Elcum (1883); Lady Belcher, *The Mutineers of the "Bounty"* (London, 1870); J. A. Brown, "Stone Implements from Pitcairn Island," in *Journ. Anthropol. Instit.* (1900), xxx.; R. A. Hermann, "Die Bevölkerung der Insel Pitcairn," in *Petermanns Mitteilungen* (1901), xlvii.; Parliamentary Papers C. 9148, and Cd. 754 (London, 1899, 1901); Cd. 2397 (*ibid.*, 1905; Mr R. T. Simon's report).

PITCAIRNE, ARCHIBALD (1652-1713), Scottish physician, was born at Edinburgh on the 25th of December 1652. After obtaining some classical education at the school of Dalkeith, Pitcairne entered Edinburgh University in 1668, and took his degree of M.A. in 1671. Having been sent to France for the benefit of his health, he was induced at Paris to begin the study of medicine, and after courses at Edinburgh and Paris he obtained in 1680 the degree of M.D. at Rheims. He began practice at Edinburgh, and in a short time acquired so great a reputation that in 1692 he was appointed professor of medicine at Leiden. Among his pupils were Richard Mead and H. Boerhaave, and both of them attributed much of their skill to what they had learned from Pitcairne. In 1693 Pitcairne returned to Scotland to marry a daughter of Sir Archibald Stevenson, an eminent physician in Edinburgh. The family objected to her going abroad, so he did not return to Leiden, but settled once more in Edinburgh. He rose to be the first physician in Scotland, and was frequently called into consultation both in England and Holland. Soon after his return to Edinburgh, feeling the great want of the means of anatomical study, he impudently the town council to permit himself and certain of his medical friends to treat without fee the sick paupers in "Paul's Work," on condition of being allowed to dissect such of the bodies as were unclaimed by their relatives, and therefore had to be buried at the town's expense. Strangely enough this proposal was strongly opposed by the chief surgeons of the place, but ultimately the town council had the good sense to comply with Pitcairne's request, and in this way he may be said to have the credit of laying the foundation of the great Edinburgh school of medicine.

Pitcairne's medical opinions are chiefly contained in a volume of *Disertationes medicas* which he published in 1701 (2nd ed. 1713). In these he discusses the application of geometry to physic, the circulation of the blood in the smaller vessels, the difference in the quantity of the blood contained in the lungs of animals in the womb and of the same animals after birth, the motions by which food becomes fit to supply the blood, the question as to inventors in medicine (in which he repels the idea of certain medical discoveries of modern times having been

known to the ancients, especially vindicating for Harvey the discovery of the circulation of the blood, and refuting the view that it was known to Hippocrates), the cure of fevers by evacuating medicines, and the effects of acids and alkalis in medicine. Pitcairne was a good classical scholar, and wrote Latin verses, occasionally with something more than mere imitative cleverness and skill. He was supposed to be the author of a comedy, *The Assembly*, or *Scotch Reformation*, and of a satirical poem *Babel*, containing witty sketches of prominent Presbyterian divines of the time, whom, as a loudly avowed Jacobite, he strongly disliked. He was prone to irreverent and ribald jests, and thus gained the reputation of being an unbeliever and an atheist, though he was a professed deist. The stories about his over-indulgence in drink are probably exaggerated. He was repeatedly involved in violent quarrels with his medical brethren and others, and once or twice got into scrapes with the government on account of his indiscreet political utterances. Among his friends, however, he was evidently well liked, and he is known to have acted with great kindness and generosity to deserving men who needed his help. Thomas Ruddiman, the Scottish scholar, for example, was rescued from a life of obscurity by his encouragement and assistance, and by no one was his memory more gratefully cherished. Mead, too, appears never to have forgotten what he owed to his old teacher at Leiden. A son of Pitcairne's had gone out in the rebellion of 1715, and, having been condemned to death, was saved by the earnest interposition of Mead with Sir Robert Walpole. He pleaded very artfully, that if Walpole's health had been bettered by his skill, or if members of the royal family were preserved by his care, it was owing to the instruction he had received from Dr Pitcairne. Pitcairne died in Edinburgh on the 20th of October 1713. He had been a great collector of books, and his library, which is said to have been of considerable value, was, through the influence of Ruddiman, disposed of to Peter the Great of Russia.

PITCH. (1) (O. Eng. *pic*, an adaptation of Lat. *pix*, *picis*, Gr. *πίσσα*, *πίττα*, allied with Gr. *πίτυς*, pine-tree, Lat. *pinus*), the name of various substances of dark colour and of extremely viscid and tenacious consistency when subjected to heat. Strictly the term is applied to the resinous substance obtained as a solid residuum by the distillation of wood-tar (see TAR), or the non-resinous substance similarly produced from Coal-tar (*q.v.*). The name is also applied to the natural mineral substances, *i.e.* asphalt or bitumen (*q.v.*). (2) A noun of various meanings which are somewhat difficult to connect with the verb from which they apparently must be derived. "To pitch" means primarily to thrust in or fix a stake or other pointed object into the ground, hence to place in a fixed position, set in order, cast or throw, hence to incline or slope. The etymology is obscure, but it appears in Northern dialects as "pick," of which it may be a variant; there is some difficulty in connecting this form with "pick," variant of "pike" (*q.v.*).

PITCH, MUSICAL. The pitch of a musical sound is aurally defined by its absolute position in the scale and by its relative position with regard to other musical sounds. It is precisely defined by a vibration number recording the frequency of the pulsations of a tense string, a column of air, or other vibrator, in a second of time. In Great Britain and America the complete vibration to and fro (swing both ways of a pendulum) is taken as the unit; elsewhere the vibration in one direction only (swing one way of the pendulum). The only official standard is the French, dating from 1859, preserved by a tuning-fork vibrating 870.9 (double vib. 435.45) at a temperature of 15° Centigrade (59° Fahr.) in a second. The vibration number stated in the edict establishing the Diapason Normal is 870 (435), which for comparison will be here adhered to. The natural basis for a standard musical pitch is the voice, particularly the male voice, which has been of greater importance historically. There is no reason to suppose the human voice has varied, during the period of which we have evidence, more than other physical attributes. The only difference to be reckoned with may be in recent tendencies of solo vocalists to sing for effect, and so

extend the compass of the voice upwards. Otherwise we may assume no disturbing alteration has taken place for more than 2000 years in its position and extent. Vibrations increase in rapidity as a note rises and decrease as it falls. Any note may be a pitch note; for orchestras custom has settled upon c^4 in the treble clef, for organs and pianos in Great Britain c^4 , and for modern brass instruments b flat¹.

We are not without a clue to the pitch usual in the classic Greek and Alexandrian ages: the vocal octave to which the lyre was adapted was noted as c to c^4 . As in choruses baritone and low tenor singers always prevail, $d-d^4$, at French or at medium pitch, would really be the Greek singing octave; we may therefore regard it as a tone lower than that to which we are accustomed. But to sing the lower Greek modes in or near the vocal octave it was necessary to transpose (*μεταβολή*) a fourth upwards, which is effected in modern notation by a flat placed upon the b line of the staff; thus modulating from our major key of C to that of F. This transposition has had, as we shall see, much to do with the history of our subject, ultimately influencing the ecclesiastical chant and lasting until the 17th century of our era. It does not appear from any evidence that the keyboards—when there were more than one—of the early organs were arranged for transposition, but it is certain that the Flemish harpsichords to 1650 were made with double keyboards to accommodate it (see Hipkins' *History of the Pianoforte*, 1897). But a positive identity of pitch cannot be claimed for any period of time, and certainly not for the early organs; the foot-rule of the organ-builder, which had to do with the lengths of the pipes, and which varied in every country and province, could easily cause a difference of a semitone. Scale and wind-pressure are also important factors. But with all these often opposed conditions, we find less variation than might be expected, the main and really important divergence being due to the necessity of transposition, which added a very high pitch to the primarily convenient low one.

The first to attempt to define pitch would seem to have been Arnold Schlick (*Musica ausgeutsch und ausgezogen*, Heidelberg, 1511), who gives a measure, a line of 4½ Rhenish inches, which, he says, multiplied sixteen times, should be the lowest F of a small organ. He gives no diameter or wind-pressure. Dr A. J. Ellis used this indication to have an organ pipe made which with one-sixteenth diameter and a wind-pressure of 3½ in., at one-fourth Schlick's length, gave f^1 301.6, from which he derived a just major third of c^1 377, which would compare very well with an old Greek c^1 . Schlick goes on to say the organ is to be suited to the choir and properly tuned for singing, that the singer may not be forced to sing too high or too low and the organist have to play chromatics, which is not handy for every one. Further, he says pitch cannot be exactly defined, because voices vary; he nevertheless gives the measure above mentioned for the low F, but if a larger organ is built to include the still lower C, then this C must be of the same measurement, the reason being that a greater part of church music ends in "grambus," a word understood by Schlick's editor to mean the transposition of a fourth. The larger high-pitch organ will therefore be at c^1 502.6. The Halberstadt organ, about which so much has been written, was, according to Praetorius (*Synagoga musicum*, Wölfenbüttel, 1618), built in 1367, and repaired or rebuilt 1495. He gives the longest pipe of this organ, B natural, as 31 Brunsvick feet, and the circumference 3½ ft. He further tells us this pitch was a tone, nearly a tone and a half, higher than a suitable church pitch (*Chorton*), for which he gives a diagram. Dr Ellis had pipes (now preserved in the Royal Institution, London) made to reproduce both these pitches at 3½ in. wind-pressure. The Halberstadt pitch was found to be c^1 505.8; the *Chorton*, 424.2. Ellis used mean-tone temperament in calculating this lower pitch; but as he used just intonation for the Halberstadt, it seems preferable to substitute it for the *Chorton*, thus reducing it to c^1 422.8. Praetorius's *Commer-ton*, or chamber pitch, formulated in his diagrams for voices and instruments, is, he says, a whole tone higher; equivalent, therefore, to c^1 475.65. Nearly all the German organs in his

time were tuned to this higher pitch. Ellis offered the suggestion of a much higher pitch for this *Commer-ton* in his lecture "On the History of Musical Pitch," read before the Society of Arts, London (*Journal Soc. Arts*, March 5, 1880), but the present writer is unable to accept it. The lower vibration number is justified by due consideration of the three divisions of the male voice, bass, tenor and alto, as given by Praetorius, whose *Commer-ton* very closely corresponds with Bernhardt Schmidt's Durham organ, 1663-1668, the original pitch of which has been proved by Professor Armes to have been c^1 474.1. The Halberstadt pitch is nearly a semitone higher, which again agrees with the statement of Praetorius, and also Schlick's high C organ. Yet it would seem there had been a still higher pitch used in the old ecclesiastical music. Upon this interesting question Praetorius is confused and difficult to understand, but he never wavers about the transposition of a fourth. In one passage he distinctly says the old organ high pitch had been a whole tone above his *Commer-ton*, with which we shall find his *tertius minor* combines to make the required interval. The term *tertius minor*, or *inferior*, is used by Praetorius to describe a low pitch, often preferred in England and the Netherlands, in Italy and in some parts of Germany. An organist, instead of transposing a whole tone down from the *Commer-ton*, would for the *tertius minor* have to transpose a minor third. A corroboration of this pitch is found in A. Silbermann's great organ in Strasburg minister (1713-1716), the pitch of which, taken in 1880 and reduced to 59° Fahr. (as are all-pitches in this article), is c^1 393.2. An old organ at Versailles (1789) was very near this example, c^1 395.8. Sir Frederick Gore Ouseley (*vide* Ellis's lecture) regarded the French *ton de chapelle* as being about a minor third below the Diapason Normal, c^1 435, and said that most of the untouched organs in the French cathedrals were at this low pitch. Strasburg was French territory in 1713, but Silbermann's organ is not quite a whole tone below. Ellis quotes an organ at Lille, c^1 374.2, but no other instance of the very low Schlick pitch is recorded, although trial of the French cathedral organs might perhaps result in the finding of examples. Ellis gives Dom Bédos (*L'Art de faire d'orgues*, Paris, 1766) as authority for a mean tone c^1 376.6. To return to the *tertius minor*. Dr R. Smith, of Cambridge, in 1759, had the organ of Trinity College, built by Bernhardt Schmidt, lowered a whole tone, to reduce it to certain Roman pitch pipes made about 1720. His determinations of pitch by a weighted wire are not trustworthy; Ellis thinks they are not safe within four or five vibrations per second, but gives a mean pitch for this organ, when altered, of c^1 395.2. St Michael's church at Hamburg, built as late as 1762 and unaltered in 1880, had a 17th-century pitch, c^1 407.9. This is about a semitone below the Diapason Normal, and a just minor third lower than the St Jacobi organ in the same city (1688), measured by Herr Schmahl, c^1 489.2. What was remarkable in this organ was that it had one stop which was an equal minor third lower, c^1 411.4¹. The difference of a minor third, or, as we shall see later, a whole tone, had replaced the earlier fourth. Sir Frederick Gore Ouseley's comparison of the church and chamber pitches of Orlando Gibbons (*vide* Ellis's lecture) clearly shows the minor third in Great Britain in the first half of the 17th century. But the narrowing continued. Bernhardt Schmidt, better known in England as Father Smith, was invited about 1660 to build the organ for the Chapel Royal, Whitehall; two years later he built the organ in Durham Cathedral c^1 474.1, difference a whole tone, and practically agreeing with the *Commer-ton* of Praetorius. The Hampton Court organ of 1690 shows that Schmidt had further lowered his pitch a semitone, to c^1 441.7. What happened at Durham was that at some subsequent date the pipes were shifted up a semitone to bring the organ into conformity with this lower pitch, with which it is probable Schmidt's organs in St Paul's and the Temple, and also Trinity College, Cambridge, agreed. This lowering tendency towards the low church pitch, and the final adoption of the latter as a general mean pitch throughout the 18th century, was no doubt influenced by the introduction of the violin, which would not bear the high tension to which the

lutes and viols had been strained. Harpsichords had long been preferred at the *tertia minore*. The *Chorton* of Praetorius, $a^1 422.8$, is practically the same pitch as that of the fork the possession of which has been attributed to Handel, $a^1 422.5$. It is a very fair mean between G. Silbermann's 18th-century Dresden pitch, $a^1 415$, and the organs of Renatus Harris, $a^1 428.7$. Stein tuned Mozart's piano to a fork $a^1 421.6$, and the Broadwood pianos used at the London Philharmonic Society in its first concerts (1813) were tuned to a fork $a^1 506.8$, which gives a mean tone $a^1 423.7$.

According to Schindler (*Niederrheinische Musik-Zeitung*, 1855, Nos. 8 and 9) and the report of the French Commission, 1859, the rise in pitch began at the Congress of Vienna in 1816, the military bands being the cause. With the improvements in wind instruments this continued, as a more brilliant effect was gained. In 1823 Weber's *Euryanthe* is recorded as having been played in Vienna at $a^1 437.5$, and in 1834 Kreutzer's *Nachfolger* at $a^1 440$. The measurements are doubtful, but the upward tendency is clear. Scheibler, by his simple and accurate tonometer, has recorded pitches in Vienna about 1834 from $a^1 433.9$ to 440.2 . About that time, or it may be a few years earlier, Sir George Smart established a fork for the Philharmonic Society, $a^1 433.2$. Forks intended for this vibration number, stamped "Philharmonic," were sold as late as 1846. But about that year the performing pitch of the Society had reached 452.5 . Sir Michael Costa was the conductor 1846-1854, and from his acceptance of that high pitch the fork became known as Costa's, and its inception was attributed to him, though on insufficient grounds. In 1874 a further rise in the fork to $a^1 454$ was instigated by Sir Charles Hallé. The British army is bound by His Majesty's Rules and Regulations to play at the Philharmonic pitch, and a fork tuned to $a^1 452.5$ in 1890 is preserved as the standard for the Military Training School at Kneller Hall. But the Philharmonic Society adopted the Diapason Normal in 1896, and the military bands have not gone with it. In point of fact, they are gradually going higher, and the brass bands, which are so important in the North of England and in Wales, are not behind them.

It was the irrepressible upward tendency that caused the French government in 1859, acting with the advice of Halévy, Meyerbeer, Auber, Ambroise Thomas and Rossini, to establish by law the *Diapason Normal*. Other countries have gradually followed, and, with few exceptions, the low pitch derived from the Diapason Normal may be said to prevail throughout the musical world. Great Britain has been the last to fall in, but the predominance of the low pitch, introduced at Covent Garden Opera since 1880, is assured. The proprietors of Queen's Hall, London, did much for it when they undertook the alteration, at great expense, of their large concert organ, which had only just been erected. In 1896 the Philharmonic Society decided upon a performing pitch, ostensibly at 68° Fahr., of $a^1 439$; and in 1899 Messrs Broadwood made a successful effort to get this vibration number accepted by their competitors in Great Britain. The high pitch remains only where there are large concert organs not yet lowered, and with the military and brass bands.

The consideration of temperature as affecting the use of a standard pitch was not attended to when the French government issued its ordonnance. The 15° Centigrade attached to the description of the standard fork in Paris was intended for the definition and verification of the fork only. The alteration of the fork due to heat is scarcely perceptible, but wind instruments, and particularly the organ, rise almost proportionately to the increase in temperature of the surrounding air, because sound travels at an enhanced rate as the temperature rises. The coefficient of this rise is equivalent to half a vibration (0.5) per degree Fahr. per second. D. J. Blaikley (*Essay on Musical Pitch*, Catalogue of the Royal Military Exhibition, Chelsea, 1890), and Victor Mahillon (*Catalogue descriptif et analytique du Musée*, Bruxelles, troisième volume, appendice, 1900) have recorded their experience of wind instruments under changes of temperature. The French Commission, in establishing the Diapason Normal, should have chosen a temperature of 30° C.

There would then have been less disturbance owing to the breath of the players and heat of the theatres or concert-rooms. It would be a great advantage to get this higher grade generally adopted. It was proposed in the Stimm-Conferenz at Vienna in 1885, but not carried. Table III., showing orchestral pitches obtained in 1899, for the measurements of which the writer is responsible, prove how chimerical it is to hope for greater accuracy than is found between 435 and 440 vibrations a second for a^1 , inasmuch as temperature must always be reckoned with.

Table I.

1495 to 1690. Pitch descending.	Authority.	V. at 59° F.
Halberstadt organ	Ellis	$a^1 505.8$
Arnold Schlick, Heidelberg	Ellis	502.6
St Jacobi, Hamburg 1689-1693	Schmahl	499.2
St Catharinen, Hamburg	Degenhardt	480.8
Praetorius, <i>Commerian</i>	Hipkins	475.65
Durham organ	Armes and Ellis	474.1
Great Franciscan organ, Vienna c. 1640	Ullmann	457.6
Hampton Court organ	Ellis	441.7

Table II.

1511 to 1900. Pitch ascending.	Authority.	V. at 59° F.
Arnold Schlick, Heidelberg 1511	Ellis	$a^1 377.0$
Strasburg Minister. A. Silbermann 1713-1716	Stockhausen	393.2
Trinity College, Cambridge	Smith and Ellis	395.2
Versailles organ 1789	M'Leod and Ellis	395.8
Praetorius "Tertia minore" 1618	Hipkins	392.4
St Michael's, Hamburg 1762	Schmahl	407.9
Pascal Taskin's tuning-fork, Paris 1783	Lissajous	409.0
St Jacobi, Hamburg, "Tertia minore" stop 1688-1693	Schmahl	411.4
Hofcapelle, Dresden 1754	Näke	415.0
St Sophie, Dresden, G. Silbermann 1722	Näke	415.5
Freiberg, G. Silbermann 1714	Näke	419.5
Seville Cathedral 1785-1790	Ellis	419.6
Old English tuning-fork c. 1715	Ellis	419.9
Imperial Russian Court Church Band 1860	Näke and Ellis	421.2
Stein's tuning-fork, Vienna 1780	Näke and Ellis	421.6
Handel's tuning-fork 1751	Ellis	422.5
Praetorius, <i>Chorton</i> 1618	Ellis and Hipkins	422.8
Peppercorn's tuning-fork (Broadwood) 1813	Ellis	423.5
Renatus Harris, St Andrew's, Undershaf 1696	Ellis	427.7
Renatus Harris, Newcastle-on-Tyne 1670	Ions and Ellis	428.7
C. Meeren's proposed standard derived from $a^1 512$, and favoured by Boito and other Italian musicians 1876	Meerens	432.0
Sir George Smart, Philharmonic 1826-1834	Ellis	433.2
Scheibler No. I., Vienna orchestra 1834	Scheibler	433.9
Montal's tuning-fork, Paris opera 1829	Cagnard de la Tour	434.0
Scheibler No. II., Paris opera 1834	Scheibler	434.0
Reissiger's tuning-fork, Dresden 1826	Näke	435.0
Paris Diapason Normal. Ordonnance 1859	Fr. Comm.	435.0
Scheibler No. III., Paris Conservatoire 1834	Scheibler	435.2
Paris Diapason Normal. Standard fork 1859	Koenig	435.45
Paris opera 1836	Cagnard de la Tour	437.0
Scheibler, Stuttgart, proposed standard (440 at 69° F.) 1834	Scheibler	440.2
Scheibler No. IV., Vienna opera 1834	Scheibler	440.3
Hullah's tuning-fork 1842	Ellis	441.3
Naples opera, San Carlo 1857	Lissajous	444.9
Society of Arts intended for (Since 1886 the Society of Arts has advocated the Diapason Normal) 1860	Ellis	445.7

1511 to 1900. Pitch ascending.	Authority.	V. at 59° F.
Broadwood's medium	1850	Ellis 445.9
Lazarus's clarinet	1858	Lissajous 448.0
Gewandhaus, Leipzig	1843	Ellis and Hipkins 448.0
Berlin opera	1869	Ellis 448.2
Milan opera, La Scala	1857	Lissajous 448.4
Philharmonic, London	1846-1854	Lissajous 439.3
Kneller Hall	1890	Ellis and Hipkins 453.8
Philharmonic, London	1874	Hipkins 452.8
Streicher's tuning - fork, Vienna	1859	Hipkins 454.0
Strauss's Band, Imperial Institute, London, open air	1897	Ellis 456.1
		Hipkins 457.5

Table III.

Orchestral Pitch. 1899.	Authority.	V. at 68° F.
Leipzig	Blüthner	435.0
Berlin	Bechstein	438.0
New York	Steinway	438.6
Boston	Chickering	438.8
London	Broadwood	439.0
St Petersburg	Becker	439.4
Meiningen (and Bayreuth)	Mühlfeld's clarinet	439.5
Stuttgart	A. Schiedmayer	440.0
Vienna	Bösendorfer	440.0
London, Covent Garden opera	Hipkins	440.0
Paris	Erard	442.4

Verified by A. J. Hipkins. But for Leipzig a comparison with the Gewandhaus Band may be sought. (A. J. H.)

PITCHBLEND, or URANINITE, a mineral species consisting essentially of uranium oxide, of importance as a source of uranium and radium. It is a very heavy (specific gravity 9.0-9.7), compact mineral with a conchoidal to uneven fracture, and a brownish to velvet-black colour and pitchy lustre. Crystals are rare; they have the form of regular octahedra or less often of cubes. The hardness is 5½, and the streak is brown with a greenish tinge. The mineral has been known to occur at Joachimsthal in Bohemia since 1727, and it was early called pitchblende, because of its appearance; but its true nature was not recognized until 1780, when M. H. Klaproth's analysis of it resulted in the discovery of the element uranium. Analyses of material from different localities exhibit wide variations in chemical composition. In addition to uranium oxides, there are thorium, cesium (and lanthanum), yttrium and lead oxides, each varying in amount from a trace up to 10%. Calcium, iron, magnesium, manganese, silica, water, &c., are also present in small amounts. The amounts of uranium and uranic oxides (UO₂, 21-72; UO₃, 13-59%) also vary considerably. The mineral is often described as a uranate of uranyl, lead, thorium and cerium; but in the least altered material from Branchville in Connecticut the uranous oxide predominates, whilst in altered specimens uranic oxide is in excess. In the closely allied mineral, thorianite, thorium predominates (ThO₂, 76; UO₂, 12%). Since the dioxides of uranium, thorium and cerium may be obtained artificially as cubic crystals, it seems probable that pitchblende consists of isomorphous mixtures of these dioxides, the uranic oxide being due to oxidation.

The radio-active properties of pitchblende are of special interest. The fact that this mineral is more strongly radio-active than metallic uranium led to the discovery in it of the elements radium, polonium and actinium. When pitchblende is ignited or dissolved in dilute sulphuric acid, a gas is evolved which consists largely of helium and argon; terrestrial helium was first recognized in this mineral.

The mineral occurs either as a primary constituent of granitic rocks or as one of secondary origin in metalliferous veins. Octahedral crystals ("clevite" and "bröggerite") occur in the pegmatite veins of southern Norway, being occasionally found in the felspar quarries at Moss, Arendal and other places. Crystals are found under similar conditions at Middletown and Branchville in Connecticut, Llano county in Texas ("nivenite"), Mitchell county in North Carolina, Villeneuve in Quebec, and other American localities. Thorianite, found as water-worn cubes in the gem-gravels near

Balangoda in Sabaragamuwa province, Ceylon, has also no doubt been derived from crystalline rocks. On the other hand, the mineral found in metalliferous veins, and to which the name pitchblende is more properly restricted, never occurs as crystals, but as compact masses rendered more or less impure by admixture of other minerals, the specific gravity being sometimes as low as 6.5; thorium, cerium, &c., are absent, and radium and helium are present in smaller amounts. This variety occurs with ores of silver, lead, copper, nickel, cobalt, bismuth, &c., at Johannsgorpenstadt, Marienberg and Schneeberg in Saxony, Joachimsthal and Příbram in Bohemia, Rezbánya in Bihar Mountains in Hungary, Gilpin county in Colorado, St Just, in Peawith, Redruth, Grampound Road and elsewhere in Cornwall.

Often associated with pitchblende, and resulting from its alteration, is an orange-yellow, amorphous, gum-like mineral called gummite, which is a hydrous uranic oxide with small amounts of lead, calcium, iron, &c. (L. J. S.)

PITCHER. (1) A large vessel for holding liquids, derived through Fr. from Med. Lat. *picarium*; the Lat. variant *picarium*, Gr. *πίκος*, has given the Ger *Becher*, Eng. beaker (q.v.). (2) One who "pitches," i.e. throws, casts, fixes; the name of the player in the game of base-ball who pitches or delivers the ball to the striker.

PITCHER PLANTS, in botany, the name given to plants in which the leaves bear pitcher-like structures or are pitcher-like in form. The plant generally understood by this name is *Nepenthes*, a genus containing nearly sixty species, natives of tropical Asia, north Australia and (one only) of Madagascar. North Borneo is especially rich in species. They are shrubby plants climbing over surrounding vegetation by means of tendril-like prolongations of the midrib of the leaf beyond the leaf-tip.

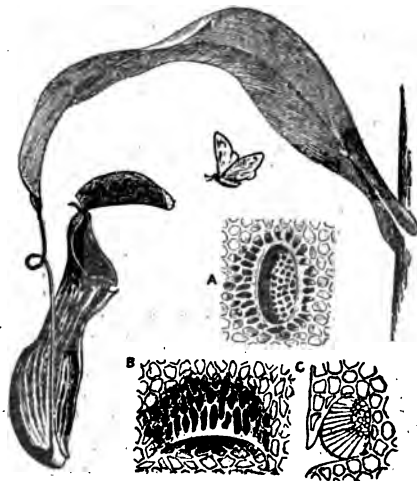

FIG. 1.—Pitcher of *Nepenthes distillatoria*. A, Honey-gland from attractive surface of lid. B, Digestive gland from interior of pitcher, in pocket-like depression of epidermis, opening downwards. C, Transverse section of the same.

The pitcher is a development at the end of the tendril. It is generally tubular in form, but in some species two forms are produced on the same plant, lower or terrestrial goblet-shaped pitchers and upper suspended pitchers retaining the more primitive more or less tubular form; in a few species a third form—funnel- or cornucopia-shaped pitchers—occurs in the upper part. In the terrestrial type a pair of well-developed wings traverse the length of the pitcher; in the tubular or funnel-shaped form the wings are narrow or ridge-like. The mouth of the pitcher has a corrugated rim (peristome) formed by incurving of the margin, the convex surface of which is firm and shining. It is traversed by more or less prominent parallel

ridges, which are usually prolonged as teeth beyond the infolded margin. Above the mouth is the lid (operculum), which varies in size from a small narrow process to a large heart-shaped expansion. A study of the development of the pitcher, especially in the young pitchers of seedling plants, shows that the inflated portion is a development of the midrib of the leaf, while the wings, which are especially well represented in the terrestrial type of pitcher, represent the upper portion of the leaf-blade which has become separated from the lower portion by the tendril; the lid is regarded as representing two leaflets which have become fused. The short straight or curved process from the back of the pitcher behind the lid represents the organic apex of the leaf (A in fig. 1).

The size of the pitcher varies widely in the different species, from an inch to a foot or more in depth. The colour also varies considerably, even in different pitchers of the same individual,

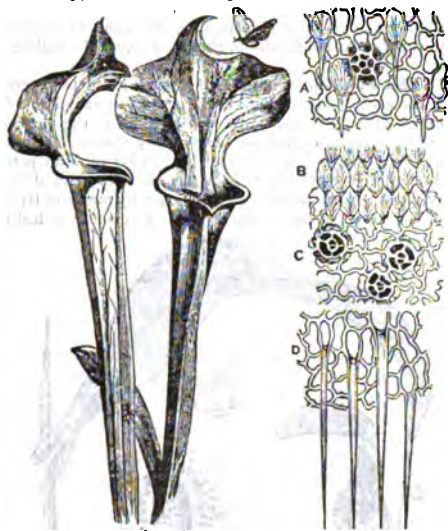

FIG. 2.—Leaves of *Sarracenia purpurea*.

A, Attractive surface of lid; B, conducting; C, glandular; and D, detentive surface; magnified. A and D are taken from *S. flava*.

according to age, light exposure or soil conditions. It is uniformly green or more or less spotted, blotched or suffused with red or crimson, or sometimes, as in *N. sanguinea* or *N. Edwardsiana*, largely or wholly of a rich scarlet or crimson colour. Insects are attracted to the mouth of the pitcher by a series of glands, yielding a sweet excretion, which occurs on the stem and also on the leaf from the base of the leaf-stalk to the lid and peristome. Embedded in the incurved margin of the rim which affords a very insecure foothold to insects, are a number of large glands excreting a sweet juice. The cavity of the pitcher is in some species lined throughout with a smooth glistening surface over which glands are uniformly distributed; these glands secrete a liquid which is found in the pitcher even in the young state while it is still hermetically closed by the lid. In other species the glands are confined to the lower portion of the cavity surface, while the upper part bears a smooth waxy secretion on which it is impossible, or at any rate extremely difficult, for insects to secure a foothold. This area is termed the "conducting" area, as distinguished from the lower or "detentive" gland-bearing area. It has been proved that the secretion contains a digestive ferment capable of rendering proteid matter soluble. Insects, especially running insects, which have followed the track of honey glands upwards from the stem along the leaf, reach the mouth of the pitcher, and in their efforts to sip the attractive marginal glands fall over into

the liquid. The smooth walls above the liquid afford no foothold, and they are drowned; their bodies are digested and the products of digestion are ultimately absorbed by the glands in the pitcher-wall. Thus *Nepenthes* secures a supply of nitrogenous food from the animal world in a manner somewhat similar to that adopted by the British sundew, butterwort, and other insectivorous plants.

The side-saddle plant, *Sarracenia*, native of the eastern United States, is also known as a pitcher-plant. There are about seven species, herbs with clusters of radical leaves some or all of which are more or less trumpet- or pitcher-shaped. The leaf has a broadly sheathing base succeeded by a short stalk bearing the pitcher, which represents a much enlarged midrib with a wing-like lamina. Above the rim of the pitcher is a broad flattened lid, which is also a laminar development. The surface of the leaf, especially the laminar wing, bears glands which in spring exude large glistening drops of nectar. The lid and mouth of the pitcher are brighter coloured than the rest of the leaf, which



FIG. 3.—*Cephalotus follicularis*, showing ordinary leaves and pitchers, the right hand one cut open to show internal structure.

varies from yellow-green to deep crimson in different species and in individuals according to exposure to sunlight and other conditions. This forms the attractive area, and the inner surface of the lid also bears numerous glands, as well as downward-pointing hairs, each with a delicately striated surface (fig. 2, A). Below it is the conducting surface (B) of glassy epidermal cells, with short downward-directed points, which facilitate the descent, but impede the ascent of an insect. Then come the glandular surface (C), which is formed of smooth polished epidermis with numerous glands that secrete the fluid contents of the pitcher, and finally the detentive surface (D), of which the cells are produced into long and strong bristles which point



FIG. 4.—Morphology of Pitchers.

A, Ordinary leaf of *Cephalotus*.
B, Monstrous leaf with spoon-shaped depression.
C and D, Other abnormal forms more deeply pouched, showing formation of pitcher.
E, Ordinary pitcher of *Cephalotus*.
a, Apex of leaf.

downwards and meet in the centre of the diminishing cavity so as to render escape impossible. The secretion wets an insect very rapidly, but, so far as is known, seems to be completely destitute of digestive power—indeed, rather to accelerate decomposition. The pitchers accumulate vast quantities of insects in the course of a season, and must thus abundantly manure the surrounding soil when they die. Moreover, the

least is largely shared by unbidden guests. Not to speak of insects which feed upon the pitcher itself, some drop their eggs into the putrescent mass, where their larvae find abundant nourishment, while birds often slit open the pitchers with their beaks and devour the maggots in their turn.

Cephalotus follicularis, a native of south-west Australia, a small herbaceous plant, bears ordinary leaves close to the ground as well as pitchers. The latter somewhat resemble in general form those of *Nepenthes*. The lid is especially attractive to insects from its bright colour and honey secretion; three wings lead up to the mouth of the pitcher, on the inside of which a row of sharp spines points downwards, and below this a circular ridge (*r*, fig. 3) armed with papillae serves as a conducting area. A number of glands on the interior of the pitcher secrete a plentiful fluid which has digestive properties. Comparison with monstrous forms shows that the pitcher of *Cephalotus* arises by a calceolate pouching from the upper surface of the ordinary spatulate leaves, the lid here arising from the proximal side of the pitcher-orifice.

PITCHSTONE (German *Packstein*, from its resemblance to pitch), in petrology, a glassy igneous rock having a resinous lustre and breaking with a hollow or conchoidal fracture. It differs from obsidian principally in its rather dull lustre, for obsidian is bright and vitreous in appearance; all pitchstones also contain a considerable quantity of water in combination amounting to from 5 to 30% of their weight or 10 to 30% of their volume. The majority of the rocks of this class occur as intrusive dikes or veins; they are glassy forms of quartz porphyry and other dike rocks. Their dull lustre may be connected with the great abundance of minute crystallites and microlites they nearly always contain. These are visible only in microscopic sections, and their varied shapes make pitchstones very interesting to the microscopist. Although pitchstones are known which are of Devonian age (e.g. the glassy dacite of the Tay Bridge in Fife, Scotland, and the andesite-pitchstones of the Cheviot Hills), most of them are Tertiary or recent, as like all natural glasses they tend to crystallize or become devitrified in course of time. In some of the older pitchstones the greater part of the mass is changed to a dull felsitic substance, while only nodules or kernels of unaltered glass remain.

Some pitchstones are very acid rocks, containing 70 to 75% of silica, and have close chemical affinities to granites and rhyolites. Others contain more alkalis and less silica, being apparently vitreous types of trachyte or keratophyre; others have the composition of dacite and andesite, but the black basaltic glasses are not usually classified among the pitchstones. Very well known rocks of this group occur at Chemnitz and Meissen in Saxony. They are brown or dark green, very often perlitic (see Petrology, Plate I., fig. 5), and show progressive devitrification starting from cracks and joints and spreading inwards through the mass. For a long time the pitchstone dikes of Arran in Scotland have been famous among geologists for the great beauty and variety of skeleton crystals they contain. These pitchstones are dull green in hand specimens. Some of them contain phenocrysts of feldspar, augite, &c.; others do not, but in all there is great abundance of branching feathery crystalline growths in the ground mass; they resemble the branches of fir trees or the fronds of ferns, minute crystalline rods being built together in aggregates which often recall the frost patterns on a window-pane. It is supposed that the mineral they consist of is hornblende. In addition to these larger growths there are many small microlites scattered through the glass, also hair-like trichites, and fine rounded globulites. When phenocrysts are present the small crystals are planted on their surfaces like grass growing from a turf-covered wall. These pitchstones are believed to proceed from the great eruptive centres which were active in western Scotland in early Tertiary times. Another pitchstone of the same period forms a great craggy ridge or scuir in the island of Eigg (Scotland). At one time regarded as a lava flow occupying an old stream channel it has recently been described as an intrusive sheet. It is from 200 to 300 ft. thick. The rock is a dark, nearly black, pitchstone-porphry, with glancing idiomorphic crystals of feldspar in a vitreous base. It contains no quartz; the feldspars are anorthoclase, and with them there are numerous crystals of green augite. The ground mass contains small crystallites of feldspar, and is of a rich brown colour in this section with well developed perlitic structure (see Petrology, Plate II., fig. 1). In

chemical composition this rock resembles the trachytes rather than the rhyolites. In Eigg and Skye there are many dikes of pitchstone, mostly of intermediate rather than of acid character, all connected with the great eruptive activity which characterized that region in early Tertiary times.

The following analyses give the chemical composition of a few well-known pitchstones:—

	SiO ₂	Al ₂ O ₃	Fe ₂ O ₃	MgO	CaO	Na ₂ O	K ₂ O	H ₂ O
I. Meissen, Saxony . . .	72.42	11.26	0.75	0.28	1.35	2.86	3.80	7.64
II. Corriegilla, Arran . .	72.07	11.26	3.24	tr.	1.53	0.61	5.61	5.45
III. Scuir of Eigg, Scotland	65.81	14.01	4.43	0.89	2.01	4.15	6.08	2.70

The first two of these contain much water for rocks the ingredients of which are but little decomposed. They are of acid or rhyolitic character, while the third is richer in alkalis and contains less silica; it belongs more naturally to the intermediate rocks (or trachytes.) (J. S. F.)

PITESCI (*Pitesti*), also written **PITESTI** and **PITEST**, the capital of the department of Arghesh, Rumania, situated among the outlying hills of the Carpathians, on the river Arghesh, which is here joined by several smaller streams. Pop. (1900), 15,570. The surrounding uplands produce good wine, fruit and grain, besides being rich in petroleum and salt; and, as the main Walachian railway is met at Pitesti by lines from Câmpulung and Hermannstadt in Transylvania, the town has a considerable trade. It has manufactures of lacquer and varnish.

PITH (O.E. *piha*, cognate with Du. *pit*, kernel of a nut), properly the medulla, the central column of spongy cellular tissue, in the stems of dicotyledonous plants (see **PLANTS: Anatomy**). The word is thence applied to the spinal cord or marrow in animals, to the medullary end of a hair, and to that which forms the central part or core of any object or substance; hence, figuratively, vigour, energy, concentrated force. Very light hats or helmets are made of the dried pith of the Indian spongewood or hat plant (*Aschynomene aspera*, the native name being *Solah*). These pith hats are worn by Europeans in India and the East. The Chinese Ricepaper-tree (*Aralia* or *Fatsia papyrifera*), from the pith of which the delicate white film known as "rice-paper" is made, is also known as the pith-plant.

PITHECANTHROPUS ERECTUS (Erect Ape-Man), the name given by Dr Eugene Dubois, of the Dutch army medical service, to the imaginary creature which he constructed from fossilized remains found by him in Java. These fragments consisted of a thigh-bone, two teeth, and the upper part of a skull, and were unearthed in 1891-1892 on the left bank of the Bengawan River near Trinil. The skull appears to have been low and depressed with strong supraciliary ridges; the teeth are very large, and the femur is quite human. The teeth and skull were found together, the femur a few yards away a year afterwards. The discoverer, however, stated it as his belief that the fragments were portions of the same skeleton and belonged to a creature half-way between man and the higher apes and of the Pleistocene age. Much discussion followed the "find," and many authorities have given an opinion adverse to Dr Dubois's theory. The prevailing opinion is that the bones are human. They are not held to represent what has been called "the missing link," bridging over the gulf between man and the apes, but almost all authorities are agreed that they constitute a further link in the chain, bringing man nearer his Simian prototype. L. Manouvrier concludes that *Homo javanensis* walked erect, was of about medium height, and was a true precursor, possibly a direct ancestor, of man. He calls attention to the fact that the cranial capacity decreases in proportion to the antiquity of the human skulls found, and that the pithecanthropus skull has a capacity of from 900 to 1000 cc.—that is, "stands at the level of the smallest which have been occasionally found amongst the reputedly lowest savage peoples."

See Dubois, *Pithecanthropus erectus* (Batavia, 1894); a later paper read by Dr Dubois before the Berlin Anthropological Society was translated in the *Smithsonian Report* for 1898. Also a paper read by Dr D. J. Cunningham before the Royal Dublin Society, January 23, 1895 (reported in *Nature*, February 28, 1895); O. C. Marsh,

American Journ. of Science (June 1896): "Le Pithecanthropus et l'origine de l'homme," in *Bull. de la soc. d'anthrop. de Paris* (1896), pp. 460-67; L. Manouvrier, "Discussion du pithecanthropus erectus comme précurseur de l'homme," in *Bull. soc. d'anthrop. de Paris* (1895), pp. 13-47 and 216-220; L. Manouvrier, *Bull. soc. d'anthrop.* (1896), p. 419 sqq.; "The Trilium Erectus contrasted with the Femora of various savage and civilized races," in *Journal of Anat. and Physiol.* (1896), xxxi, 1 seq.; Virchow, "Über den Pithecanthropus erectus Dubois" in *Zeitschrift f. Ethnologie* (1895), pp. 336, 435, 648.

PITHIVIERS, a town of north central France, capital of an arrondissement in the department of Loiret, 28 m. N.N.E. of Orleans, on the railway to Maleherbes. Pop. (1906), 5676. The church of St Solomon, chiefly in the Renaissance style, and remains of the ancient ramparts are of interest. Statues have been erected of the mathematician Denis Poisson (d. 1840), and of the physician and agriculturist Duhamel de Monceaux (d. 1782), natives of Pithiviers. The town is an agricultural market, and an important centre for the saffron of the region of Gâtinaris the cultivation of which, originally introduced by the Jews of Avignon in the 12th century was fostered by Louis XIV. The shrine of St Solomon in the 9th century and that of St Gregory, an Armenian bishop, in the 10th, formed the nuclei of the town; and the donjon built at the end of the 10th century for Héloïse, lady of Pithiviers, was one of the finest of the period.

PITHOM, one of the "treasure cities" stated to have been built for Pharaoh by the Hebrews in Goshen during the Oppression (Exod. i. 11). We have here the Hebraized form of the Egyptian Petôm "House of (the sun-god) Etôm," in Greek, Patûmos, capital of the 8th nome of Lower Egypt and situated in the Wadi Tumilat on the canal from the Nile to the Red Sea. Succoth (Egyptian Thuket) was identical with it or was in its immediate neighbourhood. The site, now Tell el Maskhuta, has yielded several important monuments, including the best preserved of the trilingual stelae of Darius which commemorated his work on the canal. The earliest name yet found is that of Rameses II. of the XIXth Dynasty, but in one case he has usurped earlier work, apparently of the XIIth Dynasty (a sphinx), and the city was evidently very ancient. Several of the monuments from Pithom have been removed to Ismailia on the Suez Canal.

See Ed. Naville, *The Store City of Pithom and the route of the Exodus* (London, 1885); W. M. F. Petrie, *Tanis*, pt. i. (London, 1885); W. Golénischéff, "Stèle de Darius" in *Recueil de travaux relatifs à la philologie et à l'archéologie égyptiennes et assyriennes*, xiii, 99, and the article RAMESES. (F. L. G.)

PITHOU, PIERRE (1539-1596), French lawyer and scholar, was born at Troyes on the 1st of November 1539. His taste for literature was early seen, and his father Pierre (1496-1556) cultivated it to the utmost. He was called to the Paris bar in 1560. On the outbreak of the second war of religion in 1567, Pithou, who was a Calvinist, withdrew to Sedan and afterwards to Basel, whence he returned to France on the publication of the edict of pacification. Soon afterwards he accompanied the duc de Montmorency on his embassy to England, returning shortly before the massacre of St Bartholomew, in which he narrowly escaped with his life. Next year he followed the example of Henry of Navarre by abjuring the Protestant faith. Henry, shortly after his own accession to the throne of France, recognized Pithou's talents and services by bestowing upon him various legal appointments. The most important work of his life was his co-operation in the production of the *Satire Ménippée* (1593), which did so much to damage the cause of the League; the harangue of the Sieur d'Aubray is usually attributed to his pen. He died at Nogent-sur-Seine on the 1st of November 1596. His valuable library, especially rich in MSS., was for the most part transferred to what is now the Bibliothèque Nationale in Paris.

Pithou wrote a great number of legal and historical books, besides preparing editions of several ancient authors. His earliest publication was *Adversariorum subscriptorum lib. II.* (1565). Perhaps his edition of the *Leges Visigothorum* (1579) was his most valuable contribution to historical science; in the same line he edited the *Capitula* of Charlemagne, Louis the Pious, and Charles the Bald in 1586, and he also assisted his brother François in preparing an edition of the

Corpus juris canonici (1667). His *Libertés de l'église galliane* (1594) is reprinted in his *Opera sacra juridica his oris miscellanea collecta* (1609). In classical literature he was the first who made the world acquainted with the *Fables* of Pædrus (1596); he also edited the *Perungium Veneris* (1587), and Juvenal and Persius (1583).

Three of Pithou's brothers acquired distinction as jurists: JEAN (1524-1602), author of *Traité de police et du gouvernement des républiques*, and, in collaboration with his twin brother NICOLAS (1511-1598), of *Institution de mariage chrétiens*; and FRANÇOIS (1543-1621), author of *Glossarium ad libros capitularium* (1588), *Traité de l'communication et de l'interdit*, &c. (1587).

PITIGLIANO, a town in Italy, province of Grosseto. Pop. (1901), 4416. It is the cathedral city of the bishopric named after the neighbouring town of Sovana, and possesses a 16th-century cathedral and a church of the 11th-15th centuries. Pitigliano was originally a fief of the countship of Sovana, which in 1293 came by marriage into the possession of the Orsini. In 1410 Sovana was taken by the Siennese, but by the terms of a peace concluded in 1417 the Orsini retained Pitigliano, Gentile Orsini (assassinated 1434) assuming the title of count of Pitigliano. The most famous of the line of counts was Niccolò III. (1447-1510), a celebrated *condottiere*. Under his successors Pitigliano became the scene of ceaseless family feuds culminating in assassinations. In 1562 the Medici of Florence seized part of their territories, and acquired the rest by exchange in 1580. The Orsini stronghold still stands in the town.

PITLOCHRY, a village of Perthshire, Scotland, 2½ m. N.W. of Perth by the Highland railway. Pop. (1901), 1541. It lies on the left bank of the Tummel, a little below the confluence of that river and the Garry, 350 ft. above the sea. It is a favourite health resort and tourist centre. Among the immediate attractions are the pass of Killiecrankie, the falls of Tummel, the exquisite prospect called "Queen's View" (named after Queen Victoria) and Loch Tummel, 8 m. to the west. One m. S.E. of the village is the Black Spout, a waterfall of 80 ft. formed by the Edradour.

PITMAN, SIR ISAAC (1813-1897), English phonographer, was born at Trowbridge, Wiltshire, on the 4th of January 1813, and was educated at the local grammar school. He started in life as a clerk in a cloth factory, but in 1831 he was sent to the Normal College of the British and Foreign School Society in London. Between 1832 and 1839 he held masterships at Barton-on-Humber and Wotton-under-Edge, but he was dismissed by the authorities when he became a Swedenborgian, and from 1839 to 1843 he conducted a private school of his own at Bath. In 1829 he took up Samuel Taylor's system of shorthand, and from that time he became an enthusiast in developing the art of phonography. In 1837 he drew up a manual of Taylor's system and offered it to Samuel Bagster (1771-1852). The publisher did not accept the work, but suggested that Pitman should invent a new system (see SHORTHAND) of his own. The result was his *Stenographic Soundhand* (1837). Bagster's friendship and active help had been secured by Pitman's undertaking to verify the half-million references in the *Comprehensivæ Bible*, and he published the inventor's books at a cheap rate, thus helping to bring the system within the reach of all. Pitman devoted himself to perfecting phonography and propagating its use, and established at Bath a Phonetic Institute and a *Phonetic Journal* for this purpose; he printed in shorthand a number of standard works, and his book with the title *Phonography* (1840) went through many editions. He was an enthusiastic spelling reformer, and adopted a phonetic system which he tried to bring into general use. Pitman was twice married, his first wife dying in 1837, and his second, whom he married in 1861, surviving him. In 1864 he was knighted, and on the 22nd of January 1897 he died at Bath. Sir Isaac Pitman popularized shorthand at a time when the advance of the newspaper press and modern business methods were making it a matter of great commercial importance. His system adapted itself readily to the needs of journalism, and its use revolutionized the work of reporting. He was a non-smoker, a vegetarian, and advocated temperance principles.

His Life was written by Alfred Baker (1908) and (1902) by his brother, Benn Pitman (1822-1911).

PITONI, GIUSEPPE OTTAVIO (1657-1743), Italian musical composer, was born at Rieti on the 18th of March 1657. He came to Rome as a boy and sang in the choir of SS Apostoli. Foggia gave him instructions in counterpoint, and he became maestro di Cappella, first at Terra di Rotondo and later (1673) at Assisi. In 1676 he went to Rieti, and in 1677 to Rome, where he held various appointments, dying on the 1st of February 1743 as maestro di Cappella at St Marco, where he was buried. Pitoni appears to have devoted himself exclusively to church music, and although he did not disdain the modern style with instrumental accompaniment, he is best known by his Masses and other works in the manner of Palestrina.

Several volumes of his autograph composition are in the Santini Library at Münster.

PITT, THOMAS (1653-1726), British East India merchant and politician, usually called "Diamond Pitt," was born at Blandford, Dorset, on the 5th of July 1653. In early life he went to India, and from his headquarters at Balasore he made trading journeys into Persia and soon became prominent among those who were carrying on business in opposition to the East India Company. Twice he was arrested by order of the company, the second time being when he reached London in 1683, but after litigation had detained him for some years in England he returned to India and to his former career. Unable to check him the East India Company took him into its service in 1695, and in 1697 he became president of Fort St George, or Madras Pitt was now very zealous in defending the interests of his employers against the new East India Company, and in protecting their settlements from the attacks of the natives; in directing the commercial undertakings of the company he also appears to have been very successful. Soon, however, he had a serious quarrel with William Fraser, a member of his council, and consequently he was relieved of his office in 1709, although he was afterwards consulted by the company on matters of importance. During his residence in India Pitt bought for about £20,000 the fine diamond which was named after him; in 1717 he sold this to the regent of France, Philip duke of Orleans, for £80,000 or, according to another account, for £135,000. It is now the property of the French government. During his former stay in England Pitt had bought a good deal of property, including the manor of Old Sarum, and for a short time he had represented this borough in parliament. After his final return from India in 1710 he added to his properties and again became member of parliament for Old Sarum. He died at Swallowfield near Reading on the 28th of April 1726. His eldest son, Robert, was the father of William Pitt, earl of Chatham (q.v.); and of Thomas Pitt (d. 1761), whose son became the first Lord Camelford; his second son, Thomas Pitt (c. 1688-1729), having married Frances (d. 1772), daughter of Robert Ridgeway, 4th earl of Londonderry (d. 1714), was himself created earl of Londonderry in 1726.

PITT, WILLIAM (1759-1806), English statesman, the second son of William Pitt, earl of Chatham, and of Lady Hester Grenville, daughter of Hester, Countess Temple, was born at Hayes, near Bromley, Kent, on the 28th of May 1759. The child inherited a name which, at the time of his birth, was the most illustrious in the civilized world, and was pronounced by every Englishman with pride, and by every enemy of England with mingled admiration and terror. During the first year of his life every month had its illuminations and bonfires, and every wind brought some messenger charged with joyful tidings and hostile standards. In Westphalia the English infantry won a great battle which arrested the armies of Louis XV. in the midst of a career of conquest; Boscawen defeated one French fleet on the coast of Portugal; Hawke put to flight another in the Bay of Biscay; Johnson took Niagara; Amherst took Ticonderoga; Wolfe died by the most enviable of deaths under the walls of Quebec; Clive destroyed a Dutch armament in the Hugli, and established the English supremacy in Bengal; Coote routed Lally at Wandewash, and established the English supremacy in the Carnatic. The nation, while loudly applauding the successful warriors,

considered them all, on sea and on land, in Europe, in America, and in Asia, merely as instruments which received their direction from one superior mind. It was the great William Pitt who had vanquished the French marshals in Germany and French admirals on the Atlantic—who had conquered for his country one great empire on the frozen shores of Ontario and another under the tropical sun near the mouths of the Ganges. It was not in the nature of things that popularity such as he at this time enjoyed should be permanent. That popularity had lost its gloss before his children were old enough to understand that the earl of Chatham was a great man. The energy and decision which had eminently fitted him for the direction of war were not needed in time of peace. The lofty and spirit-stirring eloquence which had made him supreme in the House of Commons often fell dead on the House of Lords. Chatham was only the ruin of Pitt, but an awful and majestic ruin, not to be contemplated by any man of sense and feeling without emotions resembling those which are excited by the remains of the Parthenon and of the Colosseum. In one respect the old statesman was eminently happy. Whatever might be the vicissitudes of his public life, he never failed to find peace and love by his own hearth. He loved all his children, and was loved by them; and of all his children the one of whom he was fondest and proudest was his second son.

The child's genius and ambition displayed themselves with a rare and almost unnatural precocity. At seven the interest which he took in grave subjects, the ardour with which he pursued his studies, and the sense and vivacity of his remarks on books and on events amazed his parents and instructors. One of his sayings of this date was reported to his mother by his tutor. In August 1766, when the world was agitated by the news that Mr Pitt had become earl of Chatham, little William exclaimed, "I am glad that I am not the eldest son. I want to speak in the House of Commons like papa." At fourteen the lad was in intellect a man. Hayley, who met him at Lyme in the summer of 1773, was astonished, delighted, and somewhat overawed, by hearing wit and wisdom from so young a mouth. The boy himself had already written a tragedy, bad, of course, but not worse than the tragedies of his friend. This piece (still preserved) is in some respects highly curious. There is no love. The whole plot is political; and it is remarkable that the interest, such as it is, turns on a contest about a regency. On one side is a faithful servant of the Crown, on the other an ambitious and unprincipled conspirator. At length the king, who had been missing, reappears, resumes his power, and rewards the faithful defender of his rights. A reader who should judge only by internal evidence would have no hesitation in pronouncing that the play was written by some Pittite poetaster at the time of the rejoicings for the recovery of George III. in 1789.

The pleasure with which William's parents observed the rapid development of his intellectual powers was alloyed by apprehensions about his health. He shot up alarmingly fast; he was often ill, and always weak; and it was feared that it would be impossible to rear a stripling so tall, so slender, and so feeble. Port wine was prescribed by his medical advisers; and it is said that he was, at fourteen, accustomed to take this agreeable physic in quantities which would, in our more abstemious age, be thought much more than sufficient for any full-grown man. It was probably on account of the delicacy of his frame that he was not educated like other boys of the same rank. Almost all the eminent English statesmen and orators to whom he was afterwards opposed or allied—North, Fox, Shelburne, Windham, Grey, Wellesley, Grenville, Sheridan, Canning—went through the training of great public schools. Lord Chatham had himself been a distinguished Etonian; and it is seldom that a distinguished Etonian forgets his obligations to Eton. But William's infirmities required a vigilance and tenderness such as could be found only at home. He was therefore bred under the paternal roof. His studies were superintended by a clergyman named Wilson; and those

studies, though often interrupted by illness, were prosecuted with extraordinary success. He was sent, towards the close of the year 1773, to Pembroke Hall, in the university of Cambridge. The governor to whom the direction of William's academical life was confided was a bachelor of arts named Pretzman,¹ who had been senior wrangler in the preceding year, and, who though not a man of prepossessing appearance or brilliant parts, was eminently acute and laborious, a sound scholar, and an excellent geometrical. A close and lasting friendship sprang up between the pair. The disciple was able, before he completed his twenty-eighth year, to make his preceptor bishop of Lincoln and dean of St Paul's, and the preceptor showed his gratitude by writing a life of the disciple, which enjoys the distinction of being the worst biographical work of its size in the world. Pitt, till he graduated, had scarcely one acquaintance, attended chapel regularly morning and evening, dined every day in hall, and never went to a single evening party. At seventeen he was admitted, after the fashion of those times, by right of birth, without any examination, to the degree of master of arts. But he continued during some years to reside at college, and to apply himself vigorously, under Pretzman's direction, to the studies of the place, while mixing freely in the best academic society.

The stock of learning which Pitt laid in during this part of his life was certainly very extraordinary. The work in which he took the greatest delight was Newton's *Principia*. His liking for mathematics, indeed, amounted to a passion, which, in the opinion of his instructors, themselves distinguished mathematicians, required to be checked rather than encouraged. Nor was the youth's proficiency in classical learning less remarkable. In one respect, indeed, he appeared to disadvantage when compared with even second-rate and third-rate men from public schools. He had never, while under Wilson's care, been in the habit of composing in the ancient languages; and he therefore never acquired the knack of versification. It would have been utterly out of his power to produce such charming elegiac lines as those in which Wellesley bade farewell to Eton, or such Virgilian hexameters as those in which Canning described the pilgrimage to Mecca. But it may be doubted whether any scholar has ever, at twenty, had a more solid and profound knowledge of the two great tongues of the old civilized world. He had set his heart on being intimately acquainted with all the extant poetry of Greece, and was not satisfied till he had mastered Lycophron's *Cassandra*.

To modern literature Pitt paid comparatively little attention. He knew no living language except French; and French he knew very imperfectly. With a few of the best English writers he was intimate, particularly with Shakespeare and Milton. The debate in Pandemonium was, as it well deserved to be, one of his favourite passages; and his early friends used to talk, long after his death, of the just emphasis and the melodious cadence with which they had heard him recite the incomparable speech of Belial. He had indeed been carefully trained from infancy in the art of managing his voice, a voice naturally clear and decepted. At a later period the wits of Brookes's, irritated by observing, night after night, how powerfully Pitt's sonorous elocution fascinated the rows of country gentlemen, reproached him with having been "taught by his dad on a stool."

His education, indeed, was well adapted to form a great parliamentary speaker. The classical studies of Pitt had the effect of enriching his English vocabulary, and of making him wonderfully expert in the art of constructing correct English sentences. His practice was to look over a page or two of a Greek or Latin author, to make himself master of the meaning, and then to read the passage straight forward into his own language. This practice, begun under his first teacher Wilson,

¹ George Pretzman (1730-1827) was senior wrangler in 1772. In 1803, on falling heir to a large estate, he assumed the name of Tomline. From Lincoln, to which see he had been elevated in 1787, he was translated to Winchester in 1820. Tomline, to whom Pitt when dying had bequeathed his papers, published his *Memoirs of the Life of William Pitt* (down to the close of 1792) in 1821 (3 vols. 8vo).]

was continued under Pretzman. Of all the remains of antiquity, the orations were those on which he bestowed the most minute examination. His favourite employment was to compare harangues on opposite sides of the same question, to analyse them, and to observe which of the arguments of the first speaker were refuted by the second, which were evaded, and which were left untouched. Nor was it only in books that he at this time studied the art of parliamentary fencing. When he was at home he had frequent opportunities of hearing important debates at Westminster; and he heard them, not only with interest and enjoyment, but with close scientific attention. On one of these occasions Pitt, a youth whose abilities were as yet known only to his own family and to a small knot of college friends, was introduced on the steps of the throne in the House of Lords to Fox, his senior by eleven years, who was already the greatest debater, and one of the greatest orators, that had appeared in England. Fox used afterwards to relate that, as the discussion proceeded, Pitt repeatedly turned to him, and said, "But surely, Mr Fox, that might be met thus," or "Yes; but he lays himself open to this retort." What the particular criticisms were Fox had forgotten; but he said that he was much struck at the time by the precocity of a lad who, through the whole sitting, seemed to be thinking only how all the speeches on both sides could be answered.

He had not quite completed his nineteenth year when, on the 7th of April 1778, he attended his father to Westminster. A great debate was expected. It was known that France had recognized the independence of the United States. The duke of Richmond was about to declare his opinion that all thought of subjugating those states ought to be relinquished. Chatham had always maintained that the resistance of the colonies to the mother country was justifiable. But he conceived, very erroneously, that on the day on which their independence should be acknowledged the greatness of England would be at an end. Though sinking under the weight of years and infirmities, he determined, in spite of the entreaties of his family, to be in his place. His son supported him to a seat. The excitement and exertion were too much for the old man. In the very act of addressing the peers, he fell back in convulsions. A few weeks later his corpse was borne, with gloomy pomp, from the Painted Chamber to the Abbey. The favourite child and namesake of the deceased statesman followed the coffin as chief mourner, and saw it deposited in the transept where his own was destined to lie. His elder brother, now earl of Chatham, had means sufficient, and barely sufficient, to support the dignity of the peerage. The other members of the family were poorly provided for. William had little more than £300 a year. It was necessary for him to follow a profession. He had already begun to "eat his terms." In the spring of 1780 he came of age. He then quitted Cambridge, was called to the bar, took chambers in Lincoln's Inn, and joined the western circuit. In the autumn of that year a general election took place; and he offered himself as a candidate for the university; but he was at the bottom of the poll. He was, however, at the request of an hereditary friend, the duke of Rutland, brought into parliament by Sir James Lowther for the borough of Appleby.

The dangers of the country were at that time such as might well have disturbed even a constant mind. Army after army had been sent in vain against the rebellious colonists of North America. Meanwhile the house of Bourbon, ^{Parliament, 1788.} humbled to the dust a few years before by the genius and vigour of Chatham, had seized the opportunity of revenge. France and Spain had united against England, and had recently been joined by Holland. The command of the Mediterranean had been for a time lost. The British flag had been scarcely able to maintain itself in the British Channel. The northern powers professed neutrality; but their neutrality had a menacing aspect. In the East, Hyder Ali had descended on the Carnatic, had destroyed the little army of Baillie, and had spread terror even to the ramparts of Fort St George. The discontents of Ireland threatened nothing less than civil war. In England the authority of Lord North's government had sunk to the

lowest point. The king and the House of Commons were alike unpopular. The cry for parliamentary reform was scarcely less loud and vehement than afterwards in 1830.

The Opposition consisted of two parties which had once been hostile to each other, but at this conjuncture seemed to act together with cordiality. The larger of these parties consisted of the great body of the Whig aristocracy, headed by Charles, marquess of Rockingham. In the House of Commons the adherents of Rockingham were led by Fox, whose dissipated habits and ruined fortunes were the talk of the whole town, but whose commanding genius, and whose sweet, generous and affectionate disposition, extorted the admiration and love of those who most lamented the errors of his private life. Burke, superior to Fox in largeness of comprehension, in extent of knowledge, and in splendour of imagination, but less skilled in that kind of logic and in that kind of rhetoric which convince and persuade great assemblies, was willing to be the lieutenant of a young chief who might have been his son. A smaller section of the Opposition was composed of the old followers of Chatham. At their head was William, earl of Shelburne, distinguished both as a statesman and as a lover of science and letters. With him were leagued Lord Camden, who had formerly held the Great Seal, and whose integrity, ability and constitutional knowledge commanded the public respect; Barré, an eloquent and acrimonious declaimer; and Dunning, who had long held the first place at the English bar. It was to this party that Pitt was naturally attracted.

On the 26th of February 1781 he made his first speech in favour of Burke's plan of economical reform. Fox stood up at the same moment, but instantly gave way. The lofty yet animated deportment of the young member, his perfect self-possession, the readiness with which he replied to the orators who had preceded him, the silver tones of his voice, the perfect structure of his unpremeditated sentences, astonished and delighted his hearers. Burke, moved even to tears, exclaimed, "It is not a chip of the old block; it is the old block itself." "Pitt will be one of the first men in parliament," said a member of the Opposition to Fox. "He is so already," answered Fox, in whose nature envy had no place. Soon after this debate Pitt's name was put up by Fox at Brookes's Club. On two subsequent occasions during that session Pitt addressed the house, and on both fully sustained the reputation which he had acquired on his first appearance. In the summer, after the prorogation, he again went the western circuit, held several briefs, and acquitted himself in such a manner that he was highly complimented by Buller from the bench, and by Dunning at the bar.

On the 17th of November the parliament reassembled. Only forty-eight hours before had arrived tidings of the surrender of Cornwallis and his army. In the debate on the report of the address Pitt spoke with even more energy and brilliancy than on any former occasion. He was warmly applauded by his allies; but it was remarked that no person on his own side of the house was so loud in eulogy as Henry Dundas, the lord advocate of Scotland, who spoke from the ministerial ranks. From that night dates his connexion with Pitt, a connexion which soon became a close intimacy, and which lasted till it was dissolved by death. About a fortnight later Pitt spoke in the committee of supply on the army estimates. Symptoms of dissension had begun to appear on the treasury bench. Lord George Germaine, the secretary of state who was especially charged with the direction of the war in America, had held language not easily to be reconciled with declarations made by the first lord of the treasury. Pitt noticed the discrepancy with much force and keenness. Lord George and Lord North began to whisper together; and Welbore Ellis, an ancient placeman who had been drawing salary almost every quarter since the days of Henry Pelham, bent down between them to put in a word. Such interruptions sometimes discompose veteran speakers. Pitt stopped, and, looking at the group, said with admirable readiness, "I shall wait till Nestor has composed the dispute between Agamemnon and Achilles." After several defeats, or victories hardly to be

distinguished from defeats, the ministry resigned. The king, reluctantly and ungraciously, consented to accept Rockingham as first minister. Fox and Shelburne became secretaries of state. Lord John Cavendish, one of the most upright and honourable of men, was made chancellor of the exchequer. Thurlow, whose abilities and force of character had made him the dictator of the House of Lords, continued to hold the Great Seal. To Pitt was offered, through Shelburne, the vice-treasurership of Ireland, one of the easiest and most highly paid places in the gift of the Crown, but the offer was without hesitation declined. The young statesman had resolved to accept no post which did not entitle him to a seat in the cabinet, and a few days later (March 1782) he announced that resolution in the House of Commons.

Pitt gave a general support to the administration of Rockingham, but omitted, in the meantime, no opportunity of courting that ultra-Whig party which the persecution of Wilkes and the Middlesex election had called into existence, and which the disastrous events of the war, and the triumph of republican principles in America, had made formidable both in numbers and in temper. He supported a motion for shortening the duration of parliaments. He made a motion for a committee to examine into the state of the representation, and, in the speech (May 7, 1782) by which that motion was introduced, avowed himself the enemy of the close boroughs, the strongholds of that corruption to which he attributed all the calamities of the nation, and which, as he phrased it in one of those exact and sonorous sentences of which he had a boundless command, had grown with the growth of England and strengthened with her strength, but had not diminished with her diminution or decayed with her decay. On this occasion he was supported by Fox. The motion was lost by only twenty votes in a house of more than three hundred members. The Reformers never again had so good a division till the year 1831.

The new administration was strong in abilities, and was more popular than any administration which had held office since the first year of George III., but was hated by the king, hesitatingly supported by the parliament, O.M.C.
1782. and torn by internal dissensions. It was all that Rockingham could do to keep the peace in his cabinet; and before the cabinet had existed three months Rockingham died. In an instant all was confusion. The adherents of the deceased statesman looked on the duke of Portland as their chief. The king placed Shelburne at the head of the treasury. Fox, Lord John Cavendish, and Burke immediately resigned their offices; and the new prime minister was left to constitute a government out of very defective materials. It was necessary to find some member of the House of Commons who could confront the great orators of the Opposition; and Pitt alone had the eloquence and the courage which were required. He was offered the great place of chancellor of the exchequer and he accepted it (July 1782). He had scarcely completed his twenty-third year.

The parliament was speedily prorogued. During the recess a negotiation for peace which had been commenced under Rockingham was brought to a successful termination. England acknowledged the independence of her revolted colonies; and she ceded to her European enemies some places in the Mediterranean and in the Gulf of Mexico. But the terms which she obtained were quite as advantageous and honourable as the events of the war entitled her to expect, or as she was likely to obtain by persevering in a contest against immense odds. There is not the slightest reason to believe that Fox, if he had remained in office; would have hesitated one moment about concluding a treaty on such conditions. Unhappily Fox was, at this crisis, hurried by his passions into an error which made his genius and his virtues, during a long course of years, almost useless to his country. He saw that the great body of the House of Commons was divided into three parties—his own, that of North, and that of Shelburne; that none of those three parties was large enough to stand alone; that, therefore, unless two of them united there must be a miserably feeble administration,

or, more probably, a rapid succession of miserably feeble administrations, and this at a time when a strong government was essential to the prosperity and respectability of the nation. It was then necessary and right that there should be a coalition. To every possible coalition there were objections. But of all possible coalitions that to which there were the fewest objections was undoubtedly a coalition between Shelburne and Fox. It would have been generally applauded by the followers of both. It might have been made without any sacrifice of public principle on the part of either. Unhappily, recent bickerings had left in the mind of Fox a profound dislike and distrust of Shelburne. Pitt attempted to mediate, and was authorized to invite Fox to return to the service of the Crown. "Is Lord Shelburne," said Fox, "to remain prime minister?" Pitt answered in the affirmative. "It is impossible that I can act under him," said Fox. "Then negotiation is at an end," said Pitt; "for I cannot betray him." Thus the two statesmen parted. They were never again in a private room together. As Fox and his friends would not treat with Shelburne, nothing remained to them but to treat with North. That fatal coalition which is emphatically called "The Coalition" was formed. Not three-quarters of a year had elapsed since Fox and Burke had threatened North with impeachment, and had described him night after night as the most arbitrary, the most corrupt, and the most incapable of ministers. They now allied themselves with him for the purpose of driving from office a statesman with whom they cannot be said to have differed as to any important question. Nor had they even the prudence and the patience to wait for some occasion on which they might, without inconsistency, have combined with their old enemies in opposition to the government. That nothing might be wanting to the scandal, the great orators who had, during seven years, thundered against the war determined to join with the authors of that war in passing a vote of censure on the peace.

The parliament met before Christmas 1782. But it was not till January 1783 that the preliminary treaties were signed. On the 17th of February they were taken into consideration by the House of Commons. There had been, during some days, floating rumours that Fox and North had coalesced; and the debate indicated but too clearly that those rumours were not unfounded. Pitt was suffering from indisposition—he did not rise till his own strength and that of his hearers were exhausted; and he was consequently less successful than on any former occasion. His admirers owned that his speech was feeble and petulant. He so far forgot himself as to advise Sheridan to confine himself to amusing theatrical audiences. This ignoble sarcasm gave Sheridan an opportunity of retorting with great felicity. "After what I have seen and heard to-night," he said, "I really feel strongly tempted to venture on a competition with so great an artist as Ben Jonson, and to bring on the stage a second Angry Boy." On a division, the address proposed by the supporters of the government was rejected by a majority of sixteen. But Pitt was not a man to be disheartened by a single failure, or to be put down by the most lively repartee. When, a few days later, the Opposition proposed a resolution directly censuring the treaties, he spoke with an eloquence, energy and dignity which raised his fame and popularity higher than ever. To the coalition of Fox and North he alluded in language which drew forth tumultuous applause from his followers. "If," he said, "this ill-omened and unnatural marriage be not yet consummated, I know of a just and lawful impediment; and, in the name of the public weal, I forbid the bans." The ministers were again left in a minority, and Shelburne consequently tendered his resignation (March 31, 1783). It was accepted; but the king struggled long and hard before he submitted to the terms dictated by Fox, whose faults he detested, and whose high spirit and powerful intellect he detested still more. The first place at the board of treasury was repeatedly offered to Pitt; but the offer, though tempting, was steadfastly declined. The king, bitterly complaining of Pitt's faintheartedness, tried to break the coalition. Every art of seduction was practised on North, but in vain. During

several weeks the country remained without a government. It was not till all devices had failed, and till the aspect of the House of Commons became threatening, that the king gave way. The duke of Portland was declared first lord of the treasury. Thurlow was dismissed. Fox and North became secretaries of state, with power ostensibly equal. But Fox was the real prime minister. The year was far advanced before the new arrangements were completed; and nothing very important was done during the remainder of the session. Pitt, now seated on the Opposition Bench, brought the question of parliamentary reform a second time (May 7, 1783) under the consideration of the Commons. He proposed to add to the house at once a hundred county members and several members for metropolitan districts, and to enact that every borough of which an election committee should report that the majority of voters appeared to be corrupt should lose the franchise. The motion was rejected by 293 votes to 149.

After the prorogation Pitt visited the Continent for the first and last time. His travelling companion was one of his most intimate friends, William Wilberforce. That was the time of Anglomania in France; and at Paris the son of the great Chatham was absolutely hunted by men of letters and women of fashion, and forced, much against his will, into political disputation. One remarkable saying which dropped from him during this tour has been preserved. A French gentleman expressed some surprise at the immense influence which Fox, a man of pleasure, ruined by the dice-box and the turf, exercised over the English nation. "You have not," said Pitt, "been under the wand of the magician."

In November 1783 the parliament met again. The government had irresistible strength in the House of Commons, and seemed to be scarcely less strong in the House of Lords, but was, in truth, surrounded on every side by dangers. The king was impatiently waiting for the moment at which he could emancipate himself from a yoke which galled him so severely that he had more than once seriously thought of retiring to Hanover; and the king was scarcely more eager for a change than the nation. Fox and North had committed a fatal error. They ought to have known that coalitions between parties which have long been hostile can succeed only when the wish for coalition pervades the lower ranks of both. At the beginning of 1783 North had been the recognized head of the old Tory party, which, though for a moment prostrated by the disastrous issue of the American war, was still a great power in the state. Fox had, on the other hand, been the idol of the Whigs, and of the whole body of Protestant dissenters. The coalition at once alienated the most zealous Tories from North and the most zealous Whigs from Fox. Two great multitudes were at once left without any head, and both at once turned their eyes on Pitt. One party saw in him the only man who could rescue the king; the other saw in him the only man who could purify the parliament. He was supported on one side by Archbishop Marham, the preacher of divine right, and by Jenkinson, the captain of the praetorian band of the king's friends; on the other side by Jebb and Priestley, Sawbridge and Cartwright, Jack Wilkes and Horne Tooke. On the benches of the House of Commons, however, the ranks of the ministerial majority were unbroken; and that any statesman would venture to brave such a majority was thought impossible. No prince of the Hanoverian line had ever, under any provocation, ventured to appeal from the representative body to the constituent body. The ministers, therefore, notwithstanding the sullen looks and muttered words of displeasure with which their suggestions were received in the closet, notwithstanding the roar of obloquy which was rising louder and louder every day from every corner of the island, thought themselves secure. Such was their confidence in their strength that, as soon as the parliament had met, they brought forward a singularly bold and original plan for the government of the British territories in India. What was proposed in Fox's India bill was that the whole authority which till that time had been exercised over those territories by the East India Company should be transferred to seven commissioners, who were to be

named by parliament; and were not to be removable at the pleasure of the Crown. Earl Fitzwilliam, the most intimate personal friend of Fox, was to be chairman of this board, and the eldest son of North was to be one of the members.

As soon as the outlines of the scheme were known all the hatred which the coalition had excited burst forth with an astounding explosion. Burke, who, whether right or wrong in the conclusions to which he came, had at least the merit of looking at the subject in the right point of view, vainly reminded his hearers of that mighty population whose daily rice might depend on a vote of the British parliament. He spoke with even more than his wonted power of thought and language, about the desolation of Rohilkund, about the spoliation of Benares, about the evil policy which had suffered the tanks of the Carnatic to go to ruin; but he could scarcely obtain a hearing. The contending parties, to their shame it must be said, would listen to none but English topics. Out of doors the cry against the ministry was almost universal. Town and country were united. Corporations exclaimed against the violation of the charter of the greatest corporation in the realm. Tories and democrats joined in pronouncing the proposed board an unconstitutional body. It was to consist of Fox's nominees. The effect of his bill was to give, not to the Crown, but to him personally, whether in office or in opposition, an enormous power, a patronage sufficient to counterbalance the patronage of the treasury and of the admiralty, and to decide the elections for fifty boroughs. He knew, it was said, that he was hateful alike to king and people; and he had devised a plan which would make him independent of both. Some nicknamed him Cromwell, and some Carlo Khan. Wilberforce, with his usual felicity of expression, and with very unusual bitterness of feeling, described the scheme as the genuine offspring of the coalition, as marked with the features of both its parents, the corruption of one and the violence of the other. In spite of all opposition, however, the bill was supported in every stage by great majorities, was rapidly passed, and was sent up to the Lords. To the general astonishment, when the second reading was moved in the upper house, the Opposition proposed an adjournment, and carried it by eighty-seven votes to seventy-nine. The cause of this strange turn of fortune was soon known. Pitt's cousin Earl Temple, had been in the royal closet, and had there been authorized to let it be known that his majesty would consider all who voted for the bill as his enemies. The ignominious commission was performed, and instantly a troop of lords of the bedchamber, of bishops who wished to be translated, and of Scotch peers who wished to be re-elected, made haste to change sides. On a later day the Lords rejected the bill. Fox and North were immediately directed to send their seals to the palace by their under-secretaries; and Pitt was appointed first lord of the treasury and chancellor of the exchequer (December 1783).

The general opinion was that there would be an immediate dissolution. But Pitt wisely determined to give the public feeling time to gather strength. On this point he differed from his kinsman Temple. The consequence was that Temple, who had been appointed one of the secretaries of state, resigned his office forty-eight hours after he had accepted it, and thus relieved the new government from a great load of unpopularity; for all men of sense and honour, however strong might be their dislike of the India Bill, disapproved of the manner in which that bill had been thrown out. The fame of the young prime minister preserved its whiteness. He could declare with perfect truth that, if unconstitutional machinations had been employed, he had been no party to them.

He was, however, surrounded by difficulties and dangers. In the House of Lords, indeed, he had a majority; nor could any orator of the Opposition in that assembly be considered as a match for Thurlow, who was now again chancellor, or for Camden, who cordially supported the son of his old friend Chatham. But in the other house there was not a single eminent speaker among the official men who sat round Pitt. His most useful

assistant was Dundas, who, though he had not eloquence, had sense, knowledge, readiness and boldness. On the opposite benches was a powerful majority, led by Fox, who was supported by Burke, North and Sheridan. The heart of the young minister, stout as it was, almost died within him. But, whatever his internal emotions might be, his language and deportment indicated nothing but unconquerable firmness and haughty confidence in his own powers. His contest against the House of Commons lasted from the 17th of December 1783 to the 8th of March 1784. In sixteen divisions the Opposition triumphed. Again and again the king was requested to dismiss his ministers; but he was determined to go to Germany rather than yield. Pitt's resolution never wavered. The cry of the nation in his favour became vehement and almost furious. Addresses assuring him of public support came up daily from every part of the kingdom. The freedom of the city of London was presented to him in a gold box. He was sumptuously feasted in Grocers' Hall; and the shopkeepers of the Strand and Fleet Street illuminated their houses in his honour. These things could not but produce an effect within the walls of parliament. The ranks of the majority began to waver; a few passed over to the enemy; some skulked away; many were for capitulating while it was still possible to capitulate with the honours of war. Negotiations were opened with the view of forming an administration on a wide basis, but they had scarcely been opened when they were closed. The Opposition demanded, as a preliminary article of the treaty, that Pitt should resign the treasury; and with this demand Pitt steadfastly refused to comply. While the contest was raging, the clerkship of the Pells, a sinecure post for life, worth three thousand a year, and tenable with a seat in the House of Commons, became vacant. The appointment was with the chancellor of the exchequer; nobody doubted that he would appoint himself, and nobody could have blamed him if he had done so; for such sinecure offices had always been defended on the ground that they enabled a few men of eminent abilities and small incomes to live without any profession, and to devote themselves to the service of the state. Pitt, in spite of the remonstrances of his friends, gave the Pells to his father's old adherent, Colonel Barré, a man distinguished by talent and eloquence, but poor and afflicted with blindness. By this arrangement a pension which the Rockingham administration had granted to Barré was saved to the public. Pitt had his reward. No minister was ever more rancorously libelled; but even when he was known to be overwhelmed with debt, when millions were passing through his hands, when the wealthiest magnates of the realm were soliciting him for marquises and garters, his bitterest enemies did not dare to accuse him of touching unlawful gain.

At length the hard-fought fight ended. A final remonstrance, drawn up by Burke with admirable skill, was carried on the 8th of March by a single vote in a full house. The supplies had been voted; the Mutiny Bill had been passed; and the parliament was dissolved. The popular constituent bodies all over the country were in general enthusiastic on the side of the new government. A hundred and sixty of the supporters of the coalition lost their seats. The first lord of the treasury himself came in at the head of the poll for the university of Cambridge. Wilberforce was elected knight of the great shire of York, in opposition to the whole influence of the Fitzwilliams, Cavendishes, Dundases and Saviles. In the midst of such triumphs Pitt completed his twenty-fifth year. He was now the greatest subject that England had seen during many generations. He dominated absolutely over the cabinet, and was the favourite at once of the sovereign, of the parliament and of the nation. His father had never been so powerful, nor Walpole, nor Marlborough.

Pitt's first administration (1784-1801) lasted seventeen years. That long period is divided by a strongly marked line into two almost exactly equal parts. The first part Pitt's first ended and the second began in the autumn of 1792. Throughout both parts Pitt displayed in the highest degree the talents of a parliamentary leader. During the first

part he was fortunate and in many respects a skilful administrator. With the difficulties which he had to encounter during the second part he was altogether incapable of contending; but his eloquence and his perfect mastery of the tactics of the House of Commons concealed his incapacity from the multitude.

The eight years which followed the general election of 1784 were as tranquil and prosperous as any eight years in the whole history of England. Her trade increased. Her manufactures flourished. Her exchequer was full to overflowing. Very idle apprehensions were generally entertained that the public debt, though much less than a third of the debt which we now bear with ease, would be found too heavy for the strength of the nation. But Pitt succeeded in persuading first himself and then the whole nation, his opponents included, that a new sinking fund, which, so far as it differed from former sinking funds, differed for the worse, would, by virtue of some mysterious power of propagation belonging to money, put into the pocket of the public creditor great sums not taken out of the pocket of the tax-payer. The minister was almost universally extolled as the greatest of financiers. Meanwhile both the branches of the house of Bourbon found that England was as formidable an antagonist as she had ever been. France had formed a plan for reducing Holland to vassalage. But England interposed, and France receded. Spain interrupted by violence the trade of the English merchants with the regions near the Oregon. But England armed, and Spain receded. Within the island there was profound tranquillity. The king was, for the first time, popular. From the day on which Pitt was placed at the head of affairs there was an end of secret influence. Any attempt to undermine him at court, any mutinous movement among his followers in the House of Commons, was certain to be at once put down. He had only to tender his resignation and he could dictate his own terms. For he, and he alone, stood between the king and the coalition. The nation loudly applauded the king for having the wisdom to repose entire confidence in so excellent a minister. His people heartily prayed that he might long reign over them; and they prayed the more heartily because his virtues were set off to the best advantage by the vices and follies of the prince of Wales, who lived in close intimacy with the chiefs of the Opposition.

How strong this feeling was in the public mind appeared signally on one great occasion. In the autumn of 1788 the king ⁷⁷⁶ became insane. The Opposition, eager for office, ⁷⁷⁷ committed the great indiscretion of asserting that ⁷⁷⁸ the heir apparent had, by the fundamental laws of England, a right to be regent with the full powers of royalty. Pitt, on the other hand, maintained it to be the constitutional doctrine that when a sovereign is, by reason of infancy, disease or absence, incapable of exercising the regal functions, it belongs to the estates of the realm to determine who shall be the viceregent, and with what portion of the executive authority such viceregent shall be entrusted. A long and violent contest followed, in which Pitt was supported by the great body of the people with as much enthusiasm as during the first months of his administration. Tories with one voice applauded him for defending the sick-bed of a virtuous and unhappy sovereign against a disloyal faction and an undutiful son. Not a few Whigs applauded him for asserting the authority of parliaments and the principles of the Revolution, in opposition to a doctrine which seemed to have too much affinity with the servile theory of indefeasible hereditary right. The middle class, always zealous on the side of decency and the domestic virtues, looked forward with dismay to a reign resembling that of Charles II. That the prince of Wales must be regent nobody ventured to deny. But he and his friends were so unpopular that Pitt could, with general approbation, propose to limit the powers of the regent by restrictions to which it would have been impossible to subject a prince beloved and trusted by the country. Some interested men, fully expecting a change of administration, went over to the Opposition. But the majority, purified by these desertions, closed its ranks, and presented a more firm array than ever to the enemy. In every division Pitt was

victorious. When at length, after a stormy interregnum of three months, it was announced, on the very eve of the inauguration of the regent, that the king was himself again, the nation was wild with delight. Pitt with difficulty escaped from the tumultuous kindness of an innumerable multitude which insisted on drawing his coach from St Paul's Churchyard to Downing Street. This was the moment at which his fame and fortune may be said to have reached the zenith. His influence in the closet was as great as that of Carr or Villiers had been. His dominion over the parliament was more absolute than that of Walpole or Pelham had been. He was at the same time as high in the favour of the populace as ever Wilkes or Sachevell had been. But now the tide was on the turn. Only ten days after the triumphant procession to St Paul's, the states-general of France, after an interval of a hundred and seventy-four years, met at Versailles.

The nature of the great Revolution which followed was long very imperfectly understood in England. Burke saw much further than any of his contemporaries; but whatever his sagacity descried was refracted and dis-^{French}^{Revolution}coloured by his passions and his imagination. More than three years elapsed before the principles of the English administration underwent any material change. Nothing could as yet be milder or more strictly constitutional than the minister's domestic policy. Not a single act indicating an arbitrary temper or a jealousy of the people could be imputed to him. In office, Pitt had redeemed the pledges which he had, at his entrance into public life, given to the supporters of parliamentary reform. He had, in 1785, brought forward a judicious plan for the representative system, and had prevailed on the king not only to refrain from talking against that plan, but to recommend it to the houses in a speech from the throne.¹ This attempt failed; but there can be little doubt that, if the French Revolution had not produced a violent reaction of public feeling, Pitt would have performed, with little difficulty and no danger, that great work which, at a later period, Lord Grey could accomplish only by means which for a time loosened the very foundations of the commonwealth. When the atrocities of the slave trade were first brought under the consideration of parliament an abolitionist was more zealous than Pitt. A humane bill, which mitigated the horrors of the middle passage, was, in 1788, carried by the eloquence and determined spirit of Pitt, in spite of the opposition of some of his own colleagues. In 1791 he cordially concurred with Fox in maintaining the sound constitutional doctrine that an impeachment is not terminated by a dissolution. In the course of the same year the two great rivals contended side by side in a far more important case. They are fairly entitled to divide the high honour of having added to the statute-book the inestimable law which places the liberty of the press under the protection of juries. On one occasion, and one alone, Pitt, during the first half of his long administration, acted in a manner unworthy of an enlightened Whig. In the debate on the Test Act he stooped to gratify the master whom he served, the university which he represented, and the great body of clergymen and country gentlemen on whose support he rested, by talking, with little heartiness indeed, and with no asperity, the language of a Tory. With this single exception, his conduct from the end of 1783 to the middle of 1792 was that of an honest friend of civil and religious liberty.

Nor did anything, during that period, indicate that he loved war, or harboured any malevolent feeling against any neighbouring nation. Those French writers who have represented him as a Hannibal sworn in childhood by his father to bear eternal hatred to France, as having, by mysterious intrigues and lavish bribes, instigated the leading Jacobins to commit those excesses which dishonoured the Revolution, as having been the real

¹ The speech with which the king opened the session of 1785 concluded with an assurance that his majesty would heartily concur in every measure which could tend to secure the true principles of the constitution. These words were at the time understood to refer to Pitt's Reform Bill.

author of the first coalition, know nothing of his character or of his history. So far was he from being a deadly enemy to France that his laudable attempts to bring about a closer connexion with that country by means of a wise and liberal treaty of commerce brought on him the severe censure of the Opposition. He was told in the House of Commons that he was a degenerate son, and that his partiality for the hereditary foes of our island was enough to make his great father's bones stir under the pavement of the Abbey.

And this man, whose name, if he had been so fortunate as to die in 1792, would have been associated with peace, with freedom, with philanthropy, with temperate reform, with mild and constitutional administration, lived to associate his name with arbitrary government, with harsh laws harshly executed, with alien bills, with gagging bills, with suspensions of the Habeas Corpus Act, with cruel punishments inflicted on some political agitators, with unjustifiable prosecutions instigated against others and with the most costly and most sanguinary wars of modern times. He lived to be held up to obloquy as the stern oppressor of England and the indefatigable disturber of Europe. Poets, contrasting his earlier with his later years, likened him sometimes to the apostle who kissed in order to betray, and sometimes to the evil angels who kept not their first estate. By the French press and the French tribune every crime that disgraced and every calamity that afflicted France was ascribed to the monster Pitt and his guineas. While the Jacobins were dominant it was he who had corrupted the Gironde, who had raised Lyons and Bordeaux against the Convention, who had suborned Paris to assassinate Lepelletier, and Cecilia Regnault to assassinate Robespierre. When the Thermidorian reaction came, all the atrocities of the Reign of Terror were imputed to him. Collet D'Herbois and Fouquier Tinville had been his pensioners. It was he who had hired the murderers of September, who had dictated the pamphlets of Marat and the carnages of Barere, who had paid Lebon to deluge Arras with blood and Carrier to choke the Loire with corpses. The truth is that he liked neither war nor arbitrary government. He was a lover of peace and freedom, driven, by a stress against which it was hardly possible for any will or any intellect to struggle, out of the course to which his inclinations pointed, and for which his abilities and acquirements fitted him, and forced into a policy repugnant to his feelings and unsuited to his talents.

Between the spring of 1789 and the close of 1798 the public mind of England underwent a great change. If the change of Pitt's sentiments attracted peculiar notice, it was not because he changed more than his neighbours, for in fact he changed less than most of them, but because his position was far more conspicuous than theirs, because he was, till Bonaparte appeared, the individual who filled the greatest space in the eyes of the inhabitants of the civilized world. During a short time the nation, and Pitt as one of the nation, looked with interest and approbation on the French Revolution. But soon vast confiscations, the violent sweeping away of ancient institutions, the domination of clubs, the barbarities of mobs maddened by famine and hatred, produced a reaction. The court, the nobility, the gentry, the clergy, the manufacturers, the merchants, in short nineteen-twentieths of those who had good roofs over their heads and good coats on their backs, became eager intolerant Antijacobins. This feeling was at least as strong among the minister's adversaries as among his supporters. Fox in vain attempted to restrain his followers. All his genius, all his vast personal influence, could not prevent them from rising up against him in general mutiny. Burke set the example of revolt; and Burke was in no long time joined by Portland, Spencer, Fitzwilliam, Loughborough, Carlisle, Malmesbury, Windham, Elliot. In the House of Commons the followers of the great Whig statesman and orator diminished from about a hundred and sixty to fifty. In the House of Lords he had but ten or twelve adherents left. There can be no doubt that there would have been a similar mutiny on the ministerial benches if Pitt had obstinately resisted the general wish. Pressed at once by his master- and by his colleagues, by old friends and by old

opponents; he abandoned, slowly and reluctantly, the policy which was dear to his heart. He laboured hard to avert the European war. When the European war broke out he still flattered himself that it would not be necessary for this country to take either side. In the spring of 1792 he congratulated the parliament on the prospect of long and profound peace, and proved his sincerity by proposing large remissions of taxation. Down to the end of that year he continued to cherish the hope that England might be able to preserve neutrality. But the passions which raged on both sides of the Channel were not to be restrained. The republicans who ruled France were inflamed by a fanaticism resembling that of the Mussulmans, who, with the Koran in one hand and the sword in the other, went forth conquering and converting, eastward to the Bay of Bengal, and westward to the Pillars of Hercules. The higher and middle classes of England were animated by zeal not less fiery than that of the crusaders who raised the cry of *Deus vult* at Clermont. The impulse which drove the two nations to a collision was not to be arrested by the abilities or by the authority of any single man. As Pitt was in front of his fellows, and towered high above them, he seemed to lead them. But in fact he was violently pushed on by them, and, had he held back but a little more than he did, would have been thrust out of their way or trampled under their feet.

He yielded to the current; and from that day his misfortunes began. The truth is that there were only two consistent courses before him. Since he did not choose to oppose himself, side by side with Fox, to the public feeling, ^{Pitt's War Policy.} he should have taken the advice of Burke, and should have availed himself of that feeling to the full extent. If it was impossible to preserve peace, he should have adopted the only policy which should lead to victory. He should have proclaimed a holy war for religion, morality, property, order, public law, and should have thus opposed to the Jacobins an energy equal to their own. Unhappily he tried to find a middle path; and he found one which united all that was worst in both extremes. He went to war; but he could not understand the peculiar character of that war. He was obstinately blind to the plain fact that he was contending against a state which was also a sect, and that a new quarrel between England and France was of quite a different kind from the old quarrels about colonies in America and fortresses in the Netherlands. It was pitiable to hear him, year after year, proving to an admiring audience that the wicked republic was exhausted, that she could not hold out, that her credit was gone, that her assignments were not worth more than the paper of which they were made—as if credit was necessary to a government of which the principle was rapine, as if Alboin could not turn Italy into a desert till he had negotiated a loan at 5%, as if the exchequer bills of Attia had been at par. It was impossible that a man who so completely mistook the nature of a contest could carry on that contest successfully. Great as Pitt's abilities were, his military administration was that of a driveller. In such an emergency, and with such means, such a statesman as Richelieu, as Louvois, as Chatham, as Wellesley, would have created in a few months one of the finest armies in the world, and would soon have discovered and brought forward generals worthy to command such an army. Germany might have been saved by another Blenheim; Flanders recovered by another Ramillies; another Poitiers might have delivered the Royalist and Catholic provinces of France from a yoke which they abhorred, and might have spread terror even to the barriers of Paris. But the fact is that, after eight years of war, after a vast destruction of life, after an expenditure of wealth far exceeding the expenditure of the American War, of the Seven Years' War, of the War of the Austrian Succession and of the War of the Spanish Succession united, the English army under Pitt was the laughing-stock of all Europe. It could not boast of one single brilliant exploit. It had never shown itself on the Continent but to be beaten, chased, forced to re-embark or forced to capitulate. To take some sugar island in the West Indies, to scatter some mob of half-naked Irish peasants—such were the most splendid victories

won by the British troops under Pitt's auspices. The English navy no mismanagement could ruin. But during a long period whatever mismanagement could do was done. The earl of Chatham, without a single qualification for high public trust, was made, by fraternal partiality, first lord of the admiralty, and was kept in that great post during two years of a war in which the very existence of the state depended on the efficiency of the fleet. Fortunately he was succeeded by George, Earl Spencer, one of those chiefs of the Whig party who, in the great schism caused by the French Revolution, had followed Burke. Lord Spencer, though inferior to many of his colleagues as an orator, was decidedly the best administrator among them. To him it was owing that a long and gloomy succession of days of fasting, and most emphatically of humiliation, was interrupted, twice in the short space of eleven months, by days of thanksgiving for great victories.

It may seem paradoxical to say that the incapacity which Pitt showed in all that related to the conduct of the war is, in some sense, the most decisive proof that he was a man of very extraordinary abilities. Yet this is the simple truth. While his schemes were confounded, while his predictions were falsified, while the coalitions which he had laboured to form were falling to pieces, while the expeditions which he had sent forth at enormous cost were ending in rout and disgrace, while the enemy against whom he was feebly contending was subjugating Flanders and Brabant, the electorate of Mainz and the electorate of Trèves, Holland, Piedmont, Liguria, Lombardy, his authority over the House of Commons was constantly becoming more and more absolute. There was his empire. There were his victories—his Lodi and his Arcola, his Rivoli and his Marengo. Of the great party which had contended against him during the first eight years of his administration more than one-half now marched under his standard, with his old competitor the duke of Portland at their head; and the rest had, after many vain struggles, quitted the field in despair. Session followed session with scarcely a single division. In the eventful year 1799 the largest minority that could be mustered against the government was twenty-five.

In Pitt's domestic policy there was at this time assuredly no want of vigour. While he offered to French Jacobinism a resistance so feeble that it only encouraged the evil which he wished to suppress, he put down English Jacobinism with a strong hand. The Habeas Corpus Act was repeatedly suspended. Public meetings were placed under severe restraints. The government obtained from parliament power to send out of the country aliens who were suspected of evil designs; and that power was not suffered to be idle. Writers who propounded doctrines adverse to monarchy and aristocracy were proscribed and punished without mercy. The old laws of Scotland against sedition, laws which were considered by Englishmen as barbarous, and which a succession of governments had suffered to rust, were now furnished up and sharpened anew. Men of cultivated minds and polished manners were, for offences which at Westminster would have been treated as mere misdemeanours, sent to herd with felons at Botany Bay. Some reformers, whose opinions were extravagant, and whose language was intemperate, but who had never dreamed of subverting the government by physical force, were indicted for high treason, and were saved from the gallows only by the righteous verdicts of juries.

One part only of Pitt's conduct during the last eight years of the 18th century deserves high praise. He was the first English minister who formed great designs for the benefit of Ireland. Had he been able to do all that he wished, it is probable that a wise and liberal policy would have averted the rebellion of 1798. But the difficulties which he encountered were great, perhaps insurmountable; and the Roman Catholics were, rather by his misfortune than by his fault, thrown into the hands of Jacobins. There was a third great rising of the Irish against the English, a rising not less formidable than the risings of 1642 and 1689. The English remained victorious; and it was necessary for Pitt, as it had been

necessary for Oliver Cromwell and William of Orange before him, to consider how the victory should be used. He determined to make Ireland one kingdom with England, and, at the same time, to relieve the Roman Catholic laity from civil disabilities, and to grant a public maintenance to the Roman Catholic clergy. Had he been able to carry these noble designs into effect the union would have been a union indeed. But Pitt could execute only one-half of what he had projected. He succeeded in obtaining the consent of the parliaments of both kingdoms to the union; but that reconciliation of races and sects without which the union could exist only in name was not accomplished. The king imagined that his coronation oath bound him to refuse his assent to any bill for relieving Roman Catholics from civil disabilities. Dundas tried to explain the matter, but was told to keep his Scotch metaphysics to himself. Pitt and Pitt's ablest colleagues resigned their offices (March 14, 1801).

It was necessary that the king should make a new arrangement. But by this time his anger and distress had brought back the malady which had, many years before, incapacitated him for the discharge of his functions. He actually assembled his family, read the coronation oath to them, and told them that, if he broke it, the crown would immediately pass to the house of Savoy. It was not until after an interregnum of several weeks that he regained the full use of his small faculties, and that a ministry after his own heart was at length formed. In an age pre-eminently fruitful of parliamentary talents, a cabinet was formed containing hardly a single man who in parliamentary talents could be considered as even of the second rate. Henry Addington was at the head of the treasury. He had been as early, indeed an hereditary friend of Pitt, and had ~~been~~ ^{been} by Pitt's influence been placed, while still a young ~~man~~ ^{man}, in the chair of the House of Commons. He was universally admitted to have been the best speaker that had sat in that chair since the retirement of Oakes. But nature had not bestowed on him very vigorous faculties; and the highly respectable situation which he long occupied with honour had rather unfitted than fitted him for the discharge of his new duties. Nevertheless, during many months, his power seemed to stand firm. The nation was put into high good humour by a peace with France. The enthusiasm with which the upper and middle classes had rushed into the war had spent itself. Jacobinism was no longer formidable. Everywhere there was a strong reaction against what was called the atheistical and anarchical philosophy of the 18th century. Bonaparte, now first consul, was busied in constructing out of the ruins of old institutions a new ecclesiastical establishment and a new order of knighthood. The treaty of Amiens was therefore hailed by the great body of the English people with extravagant joy. The popularity of the minister was for the moment immense. His want of parliamentary ability was, as yet, of little consequence; for he had scarcely any adversary to encounter. The old Opposition, delighted by the peace, regarded him with favour. A new Opposition had indeed been formed by some of the late ministers, and was led by Grenville in the House of Lords and by Windham in the House of Commons. But the new Opposition could scarcely muster ten votes, and was regarded with no favour by the country.

On Pitt the ministers relied as on their firmest support. He had not, like some of his colleagues, retired in anger. He had expressed the greatest respect for the conscientious scruple which had taken possession of the royal mind; and he had promised his successors all the help in his power. But it was hardly possible that this union should be durable. Pitt, conscious of superior powers, imagined that the place which he had quitted was now occupied by a mere puppet, which he had set up, which he was to govern while he suffered it to remain, and which he was to fling aside as soon as he wished to resume his old position. Nor was it long before he began to pine for the power which he had relinquished. Addington, on the other hand, was by no means inclined to descend from his high position. He took his elevation quite seriously, attributed a

to his own merit, and considered himself as one of the great triumvirate of English statesmen, as worthy to make a third with Pitt and Fox. Meanwhile Pitt's most intimate friends exerted themselves to effect a change of ministry. His favourite disciple, George Canning, was indefatigable. He spoke; he wrote; he intrigued; he tried to induce a large number of the supporters of the government to sign a round robin desiring a change; he made game of Addington and of Addington's relations in a succession of lively pasquinades. The minister's partisans retorted with equal acrimony, if not with equal vivacity. Pitt could keep out of the affray only by keeping out of politics altogether; and this it soon became impossible for him to do. The treaty of Amiens had scarcely been signed when the restless ambition and the insupportable insolence of the First Consul convinced the great body of the English people that the peace so eagerly welcomed was only a precarious armistice. As it became clearer and clearer that a war for the dignity, the independence, the very existence of the nation was at hand, men looked with increasing uneasiness on the weak and languid cabinet which would have to contend against an enemy who united more than the power of Louis the Great to more than the genius of Frederick the Great. They imagined that Pitt was the only statesman who could cope with Bonaparte. This feeling was nowhere stronger than among Addington's own colleagues. The pressure put on him was so strong that he could not help yielding to it. His first proposition was that some insignificant nobleman should be first lord of the treasury and nominal head of the administration, and that the real power should be divided between Pitt and himself, who were to be secretaries of state. Pitt, as might have been expected, refused even to discuss such a scheme, and talked of it with bitter mirth. "Which secretaryship was offered to you?" his friend Wilberforce asked. "Really," said Pitt, "I had not the curiosity to inquire." Addington was frightened into bidding higher. He offered to resign the treasury to Pitt on condition that there should be no extensive change in the government. But Pitt would listen to no such terms. Then came a dispute such as often arises after negotiations orally conducted, even when the negotiators are men of strict honour. Pitt gave one account of what had passed; Addington gave another; and, though the discrepancies were not such as necessarily implied any intentional violation of truth on either side, both were greatly exasperated.

Meanwhile the quarrel with the First Consul had to come to a crisis. On the 16th of May 1803 the king sent a message calling on the House of Commons to support him in withstanding the ambitious and encroaching policy of France; and on the 22nd the house took the message into consideration.

Pitt had now been living many months in retirement. There had been a general election since he had spoken in parliament, and there were two hundred members who had never heard him. It was known that on this occasion he would be in his place, and curiosity was wound up to the highest point. Unfortunately, the shorthand writers were, in consequence of some mistake, shut out on that day from the gallery, so that the newspapers contained only a very meagre report of the proceedings. But several accounts of what passed are extant; and of those accounts the most interesting is contained in an unpublished letter written by a very young member, John William Ward, afterwards earl of Dudley. When Pitt rose he was received with loud cheering. At every pause in his speech there was a burst of applause. The peroration is said to have been one of the most animated and magnificent ever heard in parliament. "Pitt's speech," Fox wrote a few days later, "was admired very much, and very justly. I think it was the best he ever made in that style." The debate was adjourned; and on the second night Fox replied to it in an oration which, as the most zealous Pittites were forced to acknowledge, left the palm of eloquence doubtful. Addington made a pitiable appearance between the two great rivals; and it was observed that Pitt, while exhorting the Commons to stand resolutely by the executive government against France, said

not a word indicating esteem or friendship for the prime minister.

War was speedily declared. The First Consul threatened to invade England at the head of the conquerors of Belgium and Italy, and formed a great camp near the Straits of Dover. On the other side of those straits the whole British population was ready to rise up as one man in defence of the soil. In the spring of 1804 it became evident that the weakest of ministries would have to defend itself against the strongest of Oppositions, an Opposition made up of three Oppositions, each of which would, separately, have been formidable from ability, and which, when united, were also formidable from number. It was necessary to give way; the ministry was dissolved, and the task of performing a government was entrusted (May 1804) to Pitt. Pitt was of opinion that there was now an opportunity, such as had never before offered itself, and such as might never offer itself again, of uniting in the public service, on honourable terms, all the eminent talents of the kingdom. ^{PAR 2} The treasury he reserved for himself; and to Fox ^{Secnd} he proposed to assign a share of power little inferior ^{Administra-} to his own. The plan was excellent; but the king would not hear of it. Dull, obstinate, unforgiving, and at that time half mad, he positively refused to admit Fox into his service. In an evil hour Pitt yielded. All that was left was to construct a government out of the wreck of Addington's feeble administration. The small circle of Pitt's personal retainers furnished him with a very few useful assistants, particularly Dundas (who had been created Viscount Melville), Lord Harrowby and Canning.

Such was the inauspicious manner in which Pitt entered on his second administration (May 12, 1804). The whole history of that administration was of a piece with the commencement. Almost every month brought some new disaster or disgrace. To the war with France was soon added a war with Spain. The opponents of the ministry were numerous, able and active. His most useful coadjutors he soon lost. Sickness deprived him of the help of Lord Harrowby. It was discovered that Lord Melville had been guilty of highly culpable laxity in transactions relating to public money. He was censured by the House of Commons, driven from office, ejected from the privy council and impeached of high crimes and misdemeanours. The blow fell heavy on Pitt. His difficulties compelled him to resort to various expedients. At one time Addington was persuaded to accept office with a peerage; but he brought no additional strength to the government. While he remained in place he was jealous and punctilious; and he soon retired again. At another time Pitt renewed his efforts to overcome his master's aversion to Fox; and it was rumoured that the king's obstinacy was gradually giving way. But, meanwhile, it was impossible for the minister to conceal from the public eye the decay of his health and the constant anxiety which gnawed at his heart. All who passed him in the park, all who had interviews with him in Downing Street, saw misery written in his face. The peculiar look which he wore during the last months of his life was often pathetically described by Wilberforce, who used to call it the Austerlitz look.

Still the vigour of Pitt's intellectual faculties and the intrepid haughtiness of his spirit remained unaltered. He had staked everything on a great venture. He had succeeded in forming another mighty coalition against the French ascendancy. The united forces of Austria, Russia and England might, he hoped, oppose an insurmountable barrier to the ambition of the common enemy. But the genius and energy of Napoleon prevailed. While the English troops were preparing to embark for Germany, while the Russian troops were slowly coming up from Poland, he, with rapidity unprecedented in modern war, moved a hundred thousand men from the shores of the ocean to the Black Forest, and compelled a great Austrian army to surrender at Ulm. To the first faint rumours of this calamity Pitt would give no credit. He was irritated by the alarms of those around him. "Do not believe a word of it," he said; "it is all a fiction." The next day he received a Dutch newspaper containing the

capitulation. He knew no Dutch. It was Sunday, and the public offices were shut. He carried the paper to Lord Malmesbury, who had been minister in Holland; and Lord Malmesbury translated it. Pitt tried to bear up, but the shock was too great; and he went away with death in his face.

The news of the battle of Trafalgar arrived four days later, and seemed for a moment to revive him. Forty-eight hours after that most glorious and most mournful of victories had been announced to the country came the Lord Mayor's Day; and Pitt dined at Guildhall. His popularity had declined. But on this occasion the multitude, greatly excited by the recent tidings, welcomed him enthusiastically, took off his horses in Cheapside, and drew his carriage up King Street. When his health was drunk, he returned thanks in two or three of those stately sentences of which he had a boundless command. Several of those who heard him laid up his words in their hearts; for they were the last words that he ever uttered in public: "Let us hope that England, having saved herself by her energy, may save Europe by her example."

This was but a momentary rally. Austerlitz soon completed what Ulm had begun. Early in December Pitt had retired to Bath, in the hope that he might there gather strength for the approaching session. While he was languishing there on his sofa arrived the news that a decisive battle had been fought and lost in Moravia, that the coalition was dissolved, that the Continent was at the feet of France. He sank down under the blow. Ten days later he was so emaciated that his most intimate friends hardly knew him. He came up from Bath by slow journeys, and on the 11th of January 1806 reached his villa at Putney. Parliament was to meet on the 21st. On the 20th was to be the parliamentary dinner at the house of the first lord of the treasury in Downing Street; and the cards were already issued. But the days of the great minister were numbered. On the day on which he was carried into his bedroom at Putney, the Marquess Wellesley, whom he had long loved, whom he had sent to govern India, and whose administration had been eminently able, energetic and successful, arrived in London after an absence of eight years. The friends saw each other once more. There was an affectionate meeting and a last parting. That it was a last parting Pitt did not seem to be aware. He fancied himself to be recovering, talked on various subjects cheerfully and with an unclouded mind, and pronounced a warm and discerning eulogium on the marquis's brother Arthur. "I never," he said, "met with any military man with whom it was so satisfactory to converse." The excitement and exertion of this interview were too much for the sick man. He fainted away; and Lord Wellesley left the house convinced that the close was fast approaching.

And now members of parliament were fast coming up to London. The chiefs of the Opposition met for the purpose of considering the course to be taken on the first day of the session. It was easy to guess what would be the language of the king's speech, and of the address which would be moved in answer to that speech. An amendment condemning the policy of the government had been prepared, and was to have been proposed in the House of Commons by Lord Henry Petty (afterwards 3rd marquis of Lansdowne). He was unwilling, however, to come forward as the accuser of one who was incapable of defending himself. Lord Grenville, who had been informed

of Pitt's state by Lord Wellesley, and had been *Deeply* deeply affected by it, earnestly recommended forbearance; and Fox, with characteristic generosity and good nature, gave his voice against attacking his now helpless rival. "Sunt lacrymæ rerum," he said, "et mentem mortalia tangunt." On the first day, therefore, there was no debate. It was rumoured that evening that Pitt was better. But on the following morning his physicians pronounced that there were no hopes. It was asserted in many after-dinner speeches, Grub Street elegies and academic prize poems and prize declamations that the great minister died exclaiming, "Oh my country!" This is a fable, but it is true that the last words which he uttered, while he knew what he said, were broken exclamations about

the alarming state of public affairs. He ceased to breathe on the morning of the 23rd of January 1806, the twenty-fifth anniversary of the day on which he first took his seat in parliament.

It was moved in the House of Commons that Pitt should be honoured with a public funeral and a monument. The motion was opposed by Fox in a speech which deserves to be studied as a model of good taste and good feeling. The task was the most invidious that ever an orator undertook; but it was performed with a humanity and delicacy which were warmly acknowledged by the mourning friends of him who was gone. The motion was carried by 288 votes to 80. The 22nd of February was fixed for the funeral. The corpse, having lain in state during two days in the Painted Chamber, was borne with great pomp to the northern transept of the Abbey. A splendid train of princes, nobles, bishops and privy councillors followed. The grave of Pitt had been made near to the spot where his great father lay, near also to the spot where his great rival was soon to lie. Wilberforce, who carried the banner before the bier, described the awful ceremony with deep feeling. As the coffin descended into the earth, he said, the eagle face of Chatham from above seemed to look down with consternation into the dark house which was receiving all that remained of so much power and glory.

Pitt was emphatically the man of parliamentary government, the type of his class, the mimic, the child, the spoiled child, of the House of Commons. He was a distinguished member of the House of Commons at twenty-one. The ability which he had displayed in the House of Commons made him the most powerful subject in Europe before he was twenty-five. It was when the House of Commons was to be convinced and persuaded that he put forth all his powers. Of these powers we must form our estimate chiefly from tradition; for, of all the eminent speakers of that age, Pitt has suffered most from the reporters. Even while he was still living, critics remarked that his eloquence could not be preserved, that he must be heard to be appreciated. They more than once applied to him the sentence in which Tacitus describes the fate of a senator, whose rhetoric was admired in the Augustan age: "Hæteril canorum illud et profuens cum ipso simul extinctum est." There is, however, abundant evidence that nature had bestowed on Pitt the talents of a great orator; and those talents had been developed in a very peculiar manner, first by his education, and secondly by the high official position to which he rose early, and in which he passed the greater part of his public life.

At his first appearance in parliament he showed himself superior to all his contemporaries in command of language. He could pour forth a long succession of round and stately periods, without premeditation, without ever pausing for a word, without ever repeating a word, in a voice of silver clearness, and with a pronunciation so articulate that not a letter was slurred over. He had less amplitude of mind and less richness of imagination than Burke, less ingenuity than Windham, less wit than Sheridan, less perfect mastery of dialectical fence and less of that highest sort of eloquence which consists of reason and passion fused together than Fox. Yet the almost unanimous judgment of those who were in the habit of listening to that remarkable race of men placed Pitt, as a speaker, above Burke, above Windham, above Sheridan and not below Fox. His declamation was copious, polished and splendid. In power of sarcasm he was probably not surpassed by any speaker, ancient or modern; and of this formidable weapon he made merciless use. In two parts of the oratorical art which are of the highest value to a minister of state he was singularly expert. No man knew better how to be luminous or how to be obscure. When he wished to be understood, he never failed to make himself understood. Nothing was out of place; nothing was forgotten; minute details, dates, sums of money, were all faithfully preserved in his memory. On the other hand, when he did not wish to be explicit—and no man who is at the head of affairs always wishes to be explicit—he had a marvellous power

of saying nothing in language which left on his audience the impression that he had said a great deal.

The effect of oratory will always to a great extent depend on the character of the orator. There perhaps never were two speakers whose eloquence had more of what may be called the race, more of the flavour imparted by moral qualities, than Fox and Pitt. The speeches of Fox owe a great part of their charm to that warmth and softness of heart, that sympathy with human suffering, that admiration for everything great and beautiful, and that hatred of cruelty and injustice, which interest and delight us even in the most defective reports. No person, on the other hand, could hear Pitt without perceiving him to be a man of high, intrepid and commanding spirit, proudly conscious of his own rectitude and of his own intellectual superiority, incapable of the low vices of fear and envy, but too prone to feel and to show disdain. Pride, indeed, pervaded the whole man, was written in the harsh, rigid lines of his face, was marked by the way in which he walked, in which he sat, in which he stood, and above all, in which he bowed. Such pride, of course, inflicted many wounds. But his pride, though it made him bitterly disliked by individuals, inspired the great body of his followers in parliament and throughout the country with respect and confidence. It was that of the magnanimous man so finely described by Aristotle in the *Ethics*, of the man who thinks himself worthy of great things, being in truth worthy. It was closely connected, too, with an ambition which had no mixture of low cupidity. There was something noble in the cynical disdain with which the mighty minister scattered riches and titles to right and left among those who valued them, while he spurned them out of his way. Poor himself, he was surrounded by friends on whom he had bestowed three thousand, six thousand, ten thousand a year. Plain Mister himself, he had made more lords than any three ministers that had preceded him. The garter, for which the first dukes in the kingdom were contending, was repeatedly offered to him, and offered in vain.

The correctness of his private life added much to the dignity of his public character. In the relations of son, brother, uncle, master, friend, his conduct was exemplary. In the small circle of his intimate associates he was amiable, affectionate, even playful. He indulged, indeed, somewhat too freely in wine, which he had early been directed to take as a medicine, and which use had made a necessary of life to him. But it was very seldom that any indication of undue excess could be detected in his tones or gestures; and, in truth, two bottles of port were little more to him than two dishes of tea. He had, when he was first introduced into the clubs of St James's Street, shown a strong sense for play; but he had the prudence and the resolution to stop before this taste had acquired the strength of habit. From the passion which generally exercises the most tyrannical dominion over the young he possessed an immunity, which is probably to be ascribed partly to his temperament and partly to his situation. His constitution was feeble, he was very shy; and he was very busy. The strictness of his morals furnished such buffoons as Peter Pindar and Captain Morris with an inexhaustible theme for merriment of no very delicate kind. But the great body of the middle class of Englishmen could not see the joke. They warmly praised the young statesman for commanding his passions, and for covering his frailties, if he had frailties, with decorous obscurity.

The memory of Pitt has been assailed, times innumerable, often justly, often unjustly; but it has suffered much less from his assailants than from his eulogists. For, during many years, his name was the rallying cry of a class of men with whom, at one of those terrible conjunctures which confound all ordinary distinctions, he was accidentally and temporally connected, but to whom, on almost all the great questions of principle, he was diametrically opposed. The haters of parliamentary reform called themselves Pittites, not choosing to remember that Pitt made three motions for parliamentary reform, and that, though he thought that such a reform could not safely be made while the passions excited by the French Revolution were raging, he never uttered a word

indicating that he should not be prepared at a more convenient season to bring the question forward a fourth time. The toast of Protestant ascendancy was drunk on Pitt's birthday by a set of Pittites who could not but be aware that Pitt had resigned his office because he could not carry Catholic emancipation. The defenders of the Test Act called themselves Pittites, though they could not be ignorant that Pitt had laid before George III. unanswerable reasons for abolishing the Test Act. The enemies of free trade called themselves Pittites, though Pitt was far more deeply imbued with the doctrines of Adam Smith than either Fox or Grey. The very negro-drivers invoked the name of Pitt, whose eloquence was never more conspicuously displayed than when he spoke of the wrongs of the negro. This mythical Pitt, who resembles the genuine Pitt as little as the Charlemagne of Ariosto resembles the Charlemagne of Eginhard, has had his day. History will vindicate the real man from calumny disguised under the semblance of adulation, and will exhibit him as what he was—a minister of great talents, honest intentions and liberal opinions, pre-eminently qualified, intellectually and morally, for the part of a parliamentary leader, and capable of administering with prudence and moderation the government of a prosperous and tranquil country, but unequal to surprising and terrible emergencies, and liable in such emergencies to err grievously, both on the side of weakness and on the side of violence. (M.)

AUTHORITIES.—Lord Macaulay's article, a classic on its subject, written in 1859 for this *Encyclopædia* and included in the 9th edition unaltered, is preserved above in its essentials, but has been shortened and readjusted. Among standard biographies are the 5th Earl Stanhope's important *Life* (4 vols., 2nd ed., 1862), and Lord Rosebery's masterly study in the "Twelve English Statesmen Series" (1891). See also the bibliographical note to the Rev. William Hunt's article on Pitt in the *Dict. Nat. Biog.*, and also the same historian's app. i., pp. 461-462, to his vol. x. (for the years 1760-1801) of *The Political History of England* (1905), dealing with the authorities for the period.

PITTA, in ornithology, from the Telugu *pitta*, meaning a small bird, latinized by Vieillot in 1816 (*Analyse*, p. 42) as the name of a genus, and since adopted by English ornithologists as the general name for a group of birds, called by the French *Bracons*, and remarkable for their great beauty.¹ For a long while the

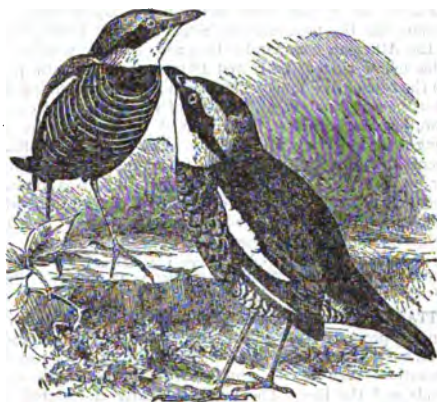

Pitta elegans, male and female.

pittas were commonly supposed to be allied to the Turdidae; and some English writers applied to them the name of "water-thrushes" and "ant-thrushes," though there was no evidence of their having aquatic habits or predilections, or of their preying especially upon ants; but the fact that they formed a separate

¹ In ornithology the word is first found as part of the native name, "Ponuncky pitta," of a bird, given in 1713 by Pteiver, in the "mantis" to Ray's *Synopsis* (p. 195), on the authority of Buckley (see ORNITHOLOGY). This bird is the *Pitta bengalensis* of modern ornithologists, and is said by Jerdon (*Birds of India*, i. 503) now to bear the Telugu name of *Pona-inki*.

family was gradually admitted. Their position was partly determined by A. H. Garrod, who, having obtained examples for dissection, in a communication to the Zoological Society of London, printed in its *Proceedings* for 1876, proved (pp. 512, 513) that the Pittidae belonged to that section of Passerine birds which he named Mesomyodi, since their syrinx, like that of the Tyrannidae (see KING-BIRD), has its muscles attached to the middle of its half-rings, instead of to their extremities as in the higher Passerines or Acromyodi. They are now placed as a separate family Pittidae of the Clamatores division of the Anisomyodine Passeres. There are about fifty species, divided into a number of genera, confined to the Old World, and ranging from India and North China to Australia, New Guinea and New Britain, with one species in West Africa, the greatest number being found in Borneo and Sumatra. Few birds can vie with the pittas in brightly-contrasted coloration. Deep velvety black, pure white and intensely vivid scarlet, turquoise-blue and beryl-green—mostly occupying a considerable extent of surface—are found in a great many of the species—to say nothing of other composite or intermediate hues; and, though in some a modification of these tints is observable, there is scarcely a trace of any blending of shade, each patch of colour standing out distinctly. This is perhaps the more remarkable as the feathers have hardly any lustre to heighten the effect produced, and in some species the brightest colours are exhibited by the plumage of the lower parts of the body. Pittas vary in size from that of a jay to that of a lark, and generally have a strong bill, a thick-set form, which is mounted on rather high legs with scutellated "tarsi," and a very short tail. In many of the forms there is little or no external difference between the sexes.

Placed originally among the Pittidae, but now created to form an allied family Philepittidae, is the genus Philepitta, consisting of two species peculiar to Madagascar. The two species which compose it have little outward resemblance to the pittas, not having the same style of coloration and being apparently of more arboreal habits. The sexes differ greatly in plumage, and the males have the skin round the eyes bare of feathers and carunculated. (A. N.)

PITTACUS, of Mytilene in Lesbos (c. 650-570 B.C.), one of the Seven Sages of Greece. About 611, with the assistance of the brothers of the poet Alcaeus, he overthrew Melanchrus, tyrant of Lesbos. In a war (606) between the Mytilenaeans and Athenians for the possession of Sigeum on the Hellespont he slew the Athenian commander Phrynion in single combat. In 589 his fellow citizens entrusted Pittacus with despotic power (with the title of Aesymnetes) for the purpose of protecting them against the exiled nobles, at the head of whom were Alcaeus and his brother Antimenes. He resigned the government after holding it for ten years, and died ten years later. According to Diogenes Laërtius, who credits him with an undoubtedly spurious letter to Croesus (with whom his connexion was probably legendary), Pittacus was a writer of elegiac poems, from which he quotes five lines. His favourite sayings were: "It is hard to be good," and "Know when to act."

See Herodotus v. 27, 94; Diog. Laërt. i. 4; Lucian, *Macrobii*, 18; Strabo xiii. 600, 617-618; Aristotle, *Politics*, ii. 12, iii. 14; T. Bergk, *Poetae lyrici graeci*.

PITTANCE (through O. Fr. *pitanco*, from Lat. *pitetas*, loving-kindness), properly a gift to the members of a religious house for masses, consisting usually of an extra allowance of food or wine on occasions such as the anniversary of the donor's death, festivals and the like. The word was early transferred to a charitable donation and to any small gift of food or money.

PITT-RIVERS, AUGUSTUS HENRY LANE-FOX (1827-1900), English soldier and archaeologist, son of W. A. Lane-Fox, was born on the 14th of April 1827. It was not till 1880 that he assumed the name of Pitt-Rivers, on inheriting the Dorsetshire and Wiltshire estates of his great-uncle, the second Lord Rivers. Educated at Sandhurst, he received a commission in the Grenadier Guards in 1845, being captain 1850, lieutenant-colonel 1857, colonel 1867, major-general 1877 and lieutenant-general 1882. He served in the Crimean War, and was at the Alma and the siege of Sebastopol. His talent for experimental research was utilized in investigation into

improvements of the army rifle, and he was largely responsible for starting the Hythe School of Musketry. It is not, however, for his military career, but for his work as an anthropologist and archaeologist, that General Pitt-Rivers will be remembered. His interest in the evolution of the rifle early extended itself to other weapons and instruments in the history of man, and he became a collector of articles illustrating the development of human invention. His collection became famous, and, after being exhibited in 1874-1875 at the Bethnal Green Museum, was presented in 1883 to the university of Oxford. When, in 1880, General Pitt-Rivers obtained possession of his great-uncle's estates—practically untouched by the excavator since they had been the battleground of the West Saxons, the Romans and the Britons—he devoted himself to exploring them. His excavations round Rushmore resulted in valuable "finds"; he founded a local museum and published several illustrated volumes. As a scientific archaeologist he attained high rank. Oxford gave him the D.C.L. in 1886; he was president of the Anthropological Institute, and F.R.S. He married, in 1853, Alice Margaret, daughter of the second Lord Stanley of Alderley, and had a numerous family; his second daughter became in 1884 the wife of Sir John Lubbock (Lord Avebury). General Pitt-Rivers died at Rushmore on the 4th of May 1900.

PITTSBURG, a city of Crawford county, Kansas, U.S.A., about 130 m. S. of Kansas City. Pop. (1880), 624; (1890), 6697; (1900) 10,112, of whom 860 were foreign-born; (1910 census), 14,755. It is situated at the intersection of four great railway systems—the Atchison Topeka & Santa Fé, the St Louis & San Francisco, the Kansas City Southern (which maintains shops here), and the Missouri Pacific, and is served by inter-urban electric railways. The city is the seat of the State Manual Training Normal School (1903) and of the Pittsburg Business College. Pittsburg is situated near the lead and zinc region of south-east Kansas and south-west Missouri, is in the midst of a large and rich bituminous coalfield, and lies near natural gas and oil fields. Among the manufactures are zinc spelter—there are large smelters here—clay products (chiefly vitrified brick, sewer pipe and tile; the clay being obtained from a great underlying bed of shale), blasting powder, packing-house products and planing-mill products. The total value of the city's factory products in 1905 was \$1,824,029. Pittsburg was settled about 1879, was chartered as a city in 1880, and became a city of the first class in 1908.

PITTSBURGH, or **PITTSBURGS**,¹ the second largest city of Pennsylvania, U.S.A., and the county-seat of Allegheny county, on the Allegheny, Monongahela and Ohio rivers, 440 m. by rail W. by S. of New York City, 360 m. W. by N. of Philadelphia, 368 m. N.W. of Washington and 468 m. E. by S. of Chicago. Pop. (1890), 238,617; (1900), 321,616, of whom 84,873 were foreign-born, 17,040 were negroes and 154 were Chinese; (1910 census, after the annexation of Allegheny), 533,925. Of the 84,873 foreign-born in 1900, 21,222 were natives of Germany, 18,620 of Ireland, 8002 of England, 6243 of Russian Poland, 5709 of Italy, 4107 of Russia, 3553 of Austria, 3515 of German Poland, 2530 of Wales, 2264 of Scotland, 2124 of Hungary, 1072 of Sweden and 1023 of Austrian Poland. Area (including Allegheny, annexed in 1906), 40-67 sq. m. Pittsburg is served by the Pennsylvania (several divisions), the Baltimore & Ohio, the Pittsburg & Lake Erie (controlled by the New York Central System), the Pittsburg, Cincinnati, Chicago & St Louis (controlled by the Pennsylvania Company), the Pittsburg, Chartiers & Youghiogeny (controlled jointly by the two preceding railways; 21 m. of track), the Buffalo, Rochester & Pittsburg, and the Wabash-Pittsburg Terminal (60 m. to Pittsburg Junction, Ohio; controlled by the Wabash railway), and the Pittsburg Terminal (also controlled by the Wabash and operating the

¹ "Pittsburgh" is the official spelling of the charter and used but "Pittsburg" is the spelling adopted by the U.S. Geographic Board and is in more general use.

² In previous census years the population was as follows: (1800), 1563; (1820), 7248; (1840), 21,115; (1860), 49,221; (1880), 156,389.

West Side Belt, from Pittsburg to Clairton, 21 m.) railways, and by river boats on the Ohio, Monongahela and Allegheny.

Picturesque rolling plateaus, the three rivers and narrow valleys, from which rise high hills or precipitous bluffs, are the principal natural features of the district over which the city extends. Retail houses, wholesale houses, banks, tall office buildings, hotels, theatres and railway terminals are crowded into the angle, or "The Point," formed at the confluence of the Allegheny and Monongahela rivers, with Fifth Avenue as the principal thoroughfare, especially for the retail houses, and Fourth Avenue as the great banking thoroughfare. Factories extend for miles along the banks of all three rivers into the tributary valleys; and are the cause of Pittsburg's nickname, "The Smoky City." The more attractive residential districts are on the plateau in the eastern portion of the district between the Allegheny and Monongahela rivers and on the hills overlooking the Allegheny river from the north. Overlooking the Monongahela river is Schenley Park (about 422 acres), the first city park, of which about 400 acres were given to the city in 1890 by Mrs. Mary E. Schenley. About 2 m. to the north, overlooking the Allegheny river, is Highland Park (about 366 acres), which contains the city reservoirs and a picturesque lake. Adjacent to Schenley Park are Homewood and Calvary cemeteries; and adjacent to Highland Park is Allegheny cemetery. Across the Allegheny river, in the Allegheny district, are the beautiful Riverview Park (240 acres), in which is the Allegheny Observatory, and West Park (about 100 acres). A number of bridges span the rivers.

The city has some fine public buildings, office buildings and churches. The Allegheny county court-house (1884-1888) is one of H. H. Richardson's masterpieces. The Nixon theatre is also notable architecturally. The high Frick Office building has exterior walls of white granite; in its main hall is a stained-glass window by John La Farge representing Fortune and her wheel. A large government building of polished granite contains the post office and the customs offices. St Paul's Cathedral (Roman Catholic, 1903-1906) is largely of Indiana limestone. The city is the see of a Roman Catholic and a Protestant Episcopal bishop. In Schenley Park is the Carnegie Institute (established by a gift of \$10,000,000 from Andrew Carnegie, who made further contributions of \$9,000,000 for its maintenance), with a main building containing a library, a department of fine arts, a museum (see *MUSEUMS OF SCIENCE*) and a music hall, and several separate buildings for the technical schools, which had 2102 students in 1909. The main building, dedicated in April 1907, is 660 ft. long and 400 ft. wide; in its great entrance hall is a series of mural decorations by John White Alexander, a masterpiece of the city. The library, in which the institution had its beginning in 1895, contains about 306,000 volumes. The Phipps Conservatory was presented to the city in 1893 by Henry Phipps (b. 1839), a steel manufacturer associated with Andrew Carnegie. It is the largest in America, and, with its Hall of Botany, which is utilized in instructing school children in botany, is situated in Schenley Park. The conservatory is maintained by municipal appropriations. There is a zoological garden in Highland Park. In December 1907 it was decided that the several departments of the Western University of Pennsylvania, then in different parts of the city, should be brought together on a new campus of 43 acres near the Carnegie Institute. In July 1908 the name was changed to "The University of Pittsburg." The university embraces a college and engineering school, the Western Pennsylvania School of Mines and Mining Engineering, a graduate department, an evening school of economics, accounts and finances, a summer school, evening classes, Saturday classes, and departments of astronomy (the Allegheny Observatory, in the Allegheny district), law (the Pittsburg Law School), medicine (the Western Pennsylvania Medical College), pharmacy (the Pittsburgh College of Pharmacy) and dentistry (the Pittsburgh Dental College). The institution had its beginning in the Pittsburg Academy, which was opened about 1770 and was incorporated in 1787. It was incorporated as the Western University of Pennsylvania in 1819,

but was only a college from that date until 1892, when the Western Pennsylvania Medical College became its department of medicine. In 1805 the department of law was added, the Pittsburgh College of Pharmacy was united to the university, and women were for the first time admitted. In 1806 the department of dentistry was established. In 1909 the university had 151 instructors and 1243 students. In the east end is the Pennsylvania College for Women (Presbyterian; chartered in 1869), with preparatory, collegiate and musical departments. In the Allegheny district are the Allegheny Theological Seminary (United Presbyterian, 1825), the Western Theological Seminary (Presbyterian, opened 1827), and the Reformed Presbyterian Theological Seminary (1856). Although Allegheny is now a part of Pittsburg, the two public school systems remain independent. The Pittsburg High School (five buildings in 1910) has a normal course; and there are various private schools and academies.

The Pittsburg *Gazette-Times* is probably the oldest newspaper west of the Allegheny Mountains; the *Gazette* was founded in 1786 and in 1906 was consolidated with the *Times* (1879). Other prominent newspapers of the city are the *Dispatch* (1846), the *Chronicle Telegraph* (1841), the *Post* (1792; daily, 1842), which is one of the few influential Democratic newspapers in Pennsylvania, the *Leader* (Sunday, 1864; daily, 1870) and the *Press* (1883). Two German dailies, one Slavonic daily, one Slavonic weekly, two Italian weeklies, and iron, building, coal and glass trade journals are published in the city. In Pittsburg is the publishing house of the United Presbyterian Church, and *The Christian Advocate* (weekly, Methodist Episcopal, 1834) is published here under the auspices of the general conference.

The oldest hospital is the Reinesman (private; 1803) for maternity cases; the municipal hospital (1878) is for contagious diseases; the Sisters of Charity, the Sisters of Mercy, the Institution of Protestant Deaconesses, the Presbyterian Church and the United Presbyterian Woman's Association each have charge of a hospital; and there is also an eye, ear and throat hospital (1895). The Western Pennsylvania Institution for the instruction of the deaf and dumb (1876), in Edgewood Park, is in part maintained by the state. And the state assists the Home for Aged and Infirm Colored Women (1882), and the Home for Colored Children (1881). Among other charitable institutions are the Curtis Home (1894) for destitute women and girls, the Bethesda Home (1890) for homeless girls and their children, the Florence Crittenton Home (1893) for homeless and unfortunate women, the Rosella Foundling Asylum and Maternity Hospital (1891), the Protestant Home for Incurables (1883), the Pittsburg Newsboys' Home (1894), the Children's Aid Society of Western Pennsylvania, the Pittsburg Association for the Improvement of the Poor and the Western Pennsylvania Humane Society.

Pittsburg is in the midst of the most productive coalfields in the country; the region is also rich in petroleum and natural gas. The city is on one of the main lines of communication between the east and the west, is the centre of a vast railway system, and has freight yards with a total capacity for more than 60,000 cars. Its harbour has a total length on the three rivers of 27.2 m., and an average width of about 1000 ft., and has been deepened by the construction (in 1877-1895) of the Davis Island dam, by dredging, under a federal project of 1899. Slack water navigation has been secured on the Allegheny by locks and dams (1860 and 1896 sqq.) at an expense up to July 1909 of \$1,658,804; and up to that time \$263,625 had been spent for open-channel work. The Monongahela from Pittsburg to the West Virginia state line (91.5 m.) was improved in 1836 sqq. by a private company which built seven locks and dams; this property was condemned and bought for \$3,761,615 by the United States government in 1897, and, under the project of 1899 for rebuilding three of the locks and enlarging another, and that of 1907 for a new lock and dam and for other improvements, \$2,675,692 was spent up to July 1909. Coal is brought to the city from the coalfields by boats on the Allegheny and Monongahela rivers as well as by rail, and

great fleets of barges carry coal and other heavy freight, such as steel rails, cotton ties, sheet iron, wire and nails, down the Ohio in the winter and spring. A ship canal to provide water communication between Pittsburg and Lake Erie has been projected. The railways have a heavy tonnage of coal, coke and iron and steel products, and a large portion of the iron ore that is produced in the Lake Superior region is brought to Pittsburg. In 1908 the river traffic amounted to 9,090,146 tons, most of which was carried on barges down the Ohio. Pittsburg is also a port of entry; in 1907 the value of its imports amounted to \$2,416,367, and in 1909 to \$2,062,162.

The value of the factory products in 1905 was \$165,428,881, and to this may be added \$45,830,272 for those of the city of Allegheny, making a total of \$211,259,153. In the manufacture of iron and steel products Pittsburg ranks first among the cities of the United States, the value of these products amounting in 1905 to \$88,250,805 or 53.3% of the total for all manufactures; if the manufactures of Allegheny be added they amounted to \$92,939,860 or 43.7%. Several neighbouring cities and towns are also extensively engaged in the same industry, and in 1902 Allegheny county produced about 24% of the pig-iron, nearly 34% of the Bessemer steel, more than 44% of the open-hearth steel, more than 53% of the crucible steel, more than 24% of the steel rails, and more than 59% of the structural shapes that were made in that year in the United States. In 1905 the value of Pittsburg's foundry and machine shop-products was \$9,631,514; of the product of steam railway repair shops, \$3,726,990 (being 42.8% more than in 1900); of malt liquors, \$3,166,829; of slaughtering and meat-packing products, \$2,732,027; of cigars and cigarettes, \$2,207,228; of glass, \$2,130,540; and of tin andterne plate, \$1,645,570. Electrical machinery, apparatus and supplies were manufactured largely in the city (value in 1905, \$1,796,557), and there was another large plant for their manufacture immediately outside of the city limits. Coke, cut cork, rolled brass and copper were other important products in 1905. In 1900, and for a long period preceding, Pittsburg ranked first among American cities in the manufacture of glass, but in 1905 it was outranked in this industry by Muncie, Indiana, Millville, New Jersey, and Washington, Pennsylvania; but in the district outside of the city limits of Pittsburg much glass is manufactured, so that the Pittsburg glass district is the greatest in the country, and there are large glass factories at Washington (18 m. south-west), Charleroi (20 m. south) and Tarentum (15 m. north-east). In Pittsburg or the immediate vicinity are the more important plants of the United States Steel Corporation, including that of the Carnegie Company. Here, too, are the plants of the Westinghouse Company for the manufacture of electrical apparatus, of air brakes invented by George Westinghouse (born 1846), and of devices for railway signals which he also invented. In the Allegheny district the H. J. Heinz Company has its main pickle plant, the largest establishment of the kind in the country.

The Pittsburg charter of 1816 vested the more important powers of the city government in a common council of 15 members and a select council of 9 members, and until 1834 the mayor was appointed annually by these city councils from their own number. By the Wallace Act of the state legislature in 1874 a form of government was provided for cities of three classes, and Pittsburg became a city of the second class (population between 100,000 and 300,000); under the act of 1895 a new classification was made, under which Pittsburg remains in the second class. An act of 1887 had amended the provisions of the Wallace Act in regard to second class cities by changing the terms of select councilmen from two to four years and of common councilmen from one to two years. In 1901 a new act was passed for the government of cities of the second class. It provided that the executive be a "city recorder"; this provision was repealed in 1903, when the title of mayor again came into use. The mayor holds office for three years, has the powers and jurisdiction of a justice of the peace, appoints the heads of departments (public safety, public works, collector of delinquent taxes, assessors, city treasurer, law, charities and correction,

and sinking fund commission), and may remove any of the officers he has appointed, by a written order, showing cause, to the select council. The city controller is elected by popular vote. The legislative bodies are the select and common council, elected under the law of 1887; by a three-fifths vote it may pass resolutions or ordinances over the mayor's veto. The department of public safety controls the bureaus of police, detectives, fire, health, electricity and building inspection; the department of public works controls bureaus of surveys, construction, highways and sewers, city property, water, assessment of water rents, parks, deed registry, bridges and light. In 1909 the taxable valuation was \$100,771,321, and the tax rate was 13.8 mills for city property, 9.2 mills on rural property and 6.9 mills on agricultural property. The tax rate for separate indebtedness varied from 6 mills in Allegheny to 16.2 mills in the 43rd ward. The water-supply of Pittsburg is taken from the Allegheny river and pumped into reservoirs, the highest of which, in Highland Park, is 367 ft. above the river, and there is a slow sand filtration plant for the filtration of the entire supply.

Pittsburg owed its origin to the strategic value of its site in the struggle between the English and the French for the possession of the North American continent. A few Frenchmen attempted to establish a settlement here in 1732, but were soon driven away by the Indians. In 1753, after the French had laid formal claim to this region and the Ohio Land Company had been formed with a view to establishing a settlement within it, Robert Dinwiddie, governor of Virginia and a shareholder in the Ohio Company, sent George Washington with a letter to "the commandant of the French forces on the Ohio" (then stationed at Fort Le Boeuf, near the present Waterford, about 115 m. north of the head-waters of that river) asking him to account for his invasion of territory claimed by the English. This was Washington's first important public service. He reached the present site of Pittsburg on the 24th of November 1753, and subsequently reported¹ that what is now called "The Point," i. e. the tongue of land formed by the confluence of the Monongahela and Allegheny rivers, was a much more favourable situation for a fort and trading post than the one about two miles up the Monongahela (near the present site of McKees Rocks) which had been tentatively selected by the Ohio Company. Accordingly, on the 17th of February 1754, a detachment of about 40 soldiers, under the command of Captain William Trent,² reached "The Point," and began to build a fortification (under the auspices of the Ohio Company), which it seems to have been the intention to call Fort Trent, and which was the beginning of the permanent settlement here by whites. On the 17th of the following April, however, Ensign Edward Ward, commanding the soldiers, in the absence of Captain Trent, was forced to evacuate the unfinished fortification by a party of about 1000 French and Indians, under Captain Contrecoeur, who immediately occupied the works, which he enlarged and completed, and named Fort Duquesne, in honour of Duquesne de Meaneville, governor of New France in 1752-1755. In the following summer Washington attempted to recover this fort, in a campaign which included the skirmish

¹ His *Journal*, published in 1754, gives a concise and lucid account of this expedition.

² William Trent (c. 1715-1778) was a native of Lancaster county, Pennsylvania, became a captain in the state militia in 1746 and served against the French and Indians, was for many years, after 1749, a justice of the court of common pleas and general sessions of the peace for Cumberland county, Pennsylvania, and in 1750-1751 was the partner of George Croghan in an extensive trade with the Indians. According to one account, he visited the site of Pittsburg and examined its availability for fortification, in August 1753—before the arrival of Washington. In 1755 he became a member of the council of Lieut.-Governor Robert H. Morris, and in 1758 he accompanied General Forbes's expedition against Fort Duquesne. He acted many times as Indian agent; his lucrative trade with the Indians, conducted from a trading house near Fort Pitt, was ruined during Pontiac's conspiracy. At the beginning of the War of Independence he was given a major's commission to raise troops in Western Pennsylvania. See *Journal of Captain William Trent* (Cincinnati, Ohio, 1871), edited by Alfred T. Goodman

(commonly considered the beginning of the French and Indian—Seven Years'—War) on the 28th of May 1754, at Great Meadows (in what is now Wharton township, Fayette county, Pennsylvania, about 50 m. south-east of Pittsburgh), between a detachment under his command and a scouting party under N. Coulon de Jumonville, in which Jumonville and several of his men were killed; the building, at Great Meadows, by Washington, of Fort Necessity, and its capitulation (July 3); and the retreat of Washington to Virginia. Another expedition, led by Major-General Edward Braddock, resulted in the engagement known as "Braddock's Defeat" (July 9, 1755), fought within the present borough of Braddock (about 8 m. east of Fort Duquesne), in which Braddock's force was practically annihilated, and Braddock was mortally wounded, dying four days later. The fort was finally recaptured by the English in 1758, as the result of an elaborate expedition (involving about 7000 troops) planned by Brigadier-General John Forbes (1710-1759), and prosecuted, with the assistance of Colonel George Washington and Colonel Henry Bouquet, in the face of great difficulties. General Forbes himself was so ill that he had to be carried in a litter throughout the campaign. The troops having rendezvoused during the summer (of 1758) at Ray's Town (now Bedford, Pennsylvania), and at Loyalkanna creek (now in Westmoreland county), about 50 m. to the north-west (where Fort Ligonier was built), Colonel Bouquet, commanding the division at the latter place, despatched Major James Grant (1720-1806) at the head of about 850 men to reconnoitre the fort. Grant advanced to a hill (still known by his name, and upon the crest of which the court-house now stands) within about a quarter of a mile of the fort. Here he rashly divided his force, and in a sortie of French and Indians, on the morning of the 14th of September, one of his divisions was surrounded, and a general rout ensued in which about 270 of Grant's men were killed, about 40 were wounded, and others (including Grant) were taken prisoners. Forbes's army advanced to within about 15 m. of the fort on the 24th of November, whereupon the French blew up part of the works, set fire to the buildings and retreated down the Ohio in boats. The English occupied the place on the next day and General Forbes ordered the immediate erection of a stockade fort near the site of the old one. In reporting to Lieut.-Governor William Denny (Nov. 26) the success of the expedition he dated his letter from Fort Duquesne "or now Pitts-Borough," and this name, with its subsequent modification "Pittsburgh," was thereafter more commonly used than that of Fort Pitt, which, as designating the fortification proper appears to have been first applied by General John Stanwix to the enlarged fort built (at a cost, it was estimated, of £60,000) chiefly under his direction during 1759-1760.

The first considerable settlement around the fort sprang up in 1760; it was composed of two groups of houses and cabins, the "lower town," near the fort's ramparts; and the "upper town," built chiefly along the banks of the Monongahela, and extending as far as the present Market Street. In April 1761, according to a census of the settlement, outside of the fort, taken for Colonel Bouquet, there were 332 inhabitants and 104 houses.

Fort Pitt was one of the important objective points of Pontiac's conspiracy (1763), and as soon as the intentions of the Indians became evident, Captain Simeon Ecuery, the Swiss officer in command of the garrison (which then numbered about 330); had the houses outside the ramparts levelled and prepared for a siege. The Indians attacked the fort on the 22nd of June (1763), and kept up a continuous, though ineffective, fire upon it from the 27th of July until the 1st of August, when they drew off and advanced to meet the relieving party under Colonel Bouquet. They were defeated at Bushy Run, and Colonel Bouquet relieved the fort on the 10th of August (see PONTIAC). In 1764 Colonel Bouquet added to the fort a redoubt, the "Block House," which still stands, the sole remaining trace of Fort Pitt, and is owned and cared for by the Daughters of the American Revolution.

A second town, laid out in 1764, by Colonel John Campbell (with the permission of the commandant at Fort Pitt), is bounded in

the present city by Water Street, Market Street, Second Avenue and Ferry Street, and comprises four blocks. In November 1768, at a general council of the Six Nations with Sir William Johnson and representatives of Pennsylvania and Virginia, held at Fort Stanwix, on the site of the present Rome, New York (q.v.), at which was signed a treaty establishing the boundary line between the English possessions and the territory claimed by the Six Nations, the Indians sold for \$10,000 to Thomas Penn (1702-1775) and Richard Penn (1706-1771), respectively, the second and third sons of William Penn—the founder of Pennsylvania—by his second wife, the remaining land in the province of Pennsylvania to which they claimed title, namely the tract lying south of the west branch of the Susquehanna river and of a straight line from the north-west corner of what is now Cambria county to the present Kittanning (in Armstrong county), and all of the territory east of the Allegheny river below Kittanning and south of the Ohio river. To this transaction the commissioner from Virginia seems to have made no objection, though the tract included the Fort Pitt region and other territory then claimed by Virginia. In January-March 1769 the Penns caused to be surveyed the "Manor of Pittsburgh," a tract of about 5700 acres, including much of the original city, intending to reserve it for their private use; but in the following April they offered at public sale the lands in the remainder of their purchase of the preceding year.¹ At this time the settlement about Fort Pitt consisted of about twenty houses, occupied chiefly by Indian traders. By order of General Thomas Gage the fort was abandoned as a military post in October 1772, and was partly dismantled. In January 1774 it was occupied by an armed force under Dr John Connolly, a partisan of Lord Dunmore, governor of Virginia, and by him was named Fort Dunmore (which name, however, was never formally recognized), this being one of Dunmore's overt acts ostensibly in support of his contention that the Fort Pitt region was included in Augusta county, Virginia. In the following April Connolly took forcible possession of the court-house at Hagana's Town (near the present Greensburg), the county-seat of Westmoreland county (which then included the Fort Pitt region), a few days afterwards arrested the three justices who lived in Pittsburgh, and for the remainder of the year terrorized the settlement. Lord Dunmore himself issued a proclamation dated "Fort Dunmore," 17th September (1774), in which he called upon the inhabitants to ignore the authority of Pennsylvania, and to recognize only that of Virginia. A year afterwards Fort Pitt was occupied by a company of Virginia soldiers by order of the Virginia Provincial Convention (assembled at Williamsburg in August 1775), but this move apparently was more for the defence of the frontier in the coming war than an expression on the Pennsylvania-Virginia boundary dispute; and, in November, Connolly was arrested at Fredericksburg, Maryland, on the charge of furthering Dunmore's plans for invading the western frontier. The boundary itself was in controversy until 1780, and the marking of the boundary lines was not completed until 1785. During the War of Independence the fort was maintained as a frontier Indian post, and as a protection against the British at Detroit. Soon after the close of the war it was neglected, and by 1791 it was in bad repair; therefore at the time of the Indian hostilities of 1792 another stockade fort was built near the bank of the Allegheny river and about a quarter of a mile above the site of Fort Pitt, this new fort being named Fort Lafayette, or, as it was more commonly called, Fort Fayette. After General Anthony Wayne's defeat of the Indians, at Fallen Timbers, Ohio (Aug. 20, 1794), Pittsburg lost its importance as a frontier post.

In January 1784 the sale of the land included in the "Manor of Pittsburgh" was begun by the grandsons of William Penn, John Penn (1729-1795), the second son of Richard Penn and lieutenant-governor of Pennsylvania in 1763-1771 and in 1773-1776; and John Penn (1760-1834), the fourth son of Thomas Penn; and in the following June a new series of town lots was laid out in which was incorporated Colonel Campbell's survey. Thereafter, settlers, chiefly Scotch and Irish, came rapidly.

¹ This tract was confiscated by Pennsylvania in 1779.

Pittsburg and its vicinity witnessed much of the disorder, and some of the violence against person and property, incident to the Whisky Insurrection of 1791-94. Delegates from Allegheny, Westmoreland, Washington and Fayette counties met here on the 7th of September 1791, and passed resolutions severely denouncing the excise tax; and a similarly constituted gathering, on the 24th of August 1792, voted to proscribe all persons who assisted in the enforcement of laws taxing the manufacture of liquor. Thereafter various persons who had paid the excise tax, or had assisted in collecting it, were tarred and feathered or had their houses or barns burned. General John Neville (1731-1803), having accepted the office of chief excise inspector for Western Pennsylvania, his fine country residence, about 7 m. south-west of Pittsburg, was attacked by a mob of about 500 men on the 16th and 17th of July 1794. The defenders of the property (who included a squad of soldiers from the garrison at Pittsburg) killed two and wounded several of the attacking party, but they were finally forced to surrender, and General Neville's mansion and other buildings were burned to the ground. A mass meeting of about 5000 citizens of the above-mentioned counties (many of them armed militiamen), at Braddock's Field, on the 1st and 2nd of August 1794, threatened to take possession of Fort Lafayette and to burn Pittsburg, but cooler counsel prevailed, and after voting to proscribe several persons, and marching in a body through the streets of the town, the crowd dispersed without doing any damage. Upon the arrival in the following November of the troops sent by President Washington, a military court of inquiry, held at Pittsburg, caused the arrest of several persons, who were sent to Philadelphia for trial, where some of them were found guilty and sentenced to terms of imprisonment, but the sentences were not enforced.

The town was made the county-seat in 1791, it was incorporated as a borough in 1794, the charter was revived in 1804, and the borough was chartered as a city in 1816. As early as the year of its incorporation as a borough Philadelphia and Baltimore merchants had established an important trade with it. Their goods were carried in Conestoga wagons to Shippensburg and Chambersburg, Pennsylvania, and Hagerstown, Maryland, taken from there to Pittsburg on pack horses, and exchanged for Pittsburg products; these products were carried by boat to New Orleans, where they were exchanged for sugar, molasses, &c., and these were carried through the gulf and along the coast to Baltimore and Philadelphia. Boat-building was begun in Pittsburg in 1797 or earlier; the galley "President Adams," built by the government, was launched here in 1798, and the "Senator Ross," completed in the same year, was launched in 1799. In 1797 glassworks which were the first to use coal as a fuel in making glass were built here; later Pittsburg profited greatly by the use of its great store of natural gas in the manufacture of glass. In 1806 the manufacture of iron was well begun, and by 1825 this had become the leading industry. On the 10th of April 1845 a considerable portion of the city was swept by fire, and in July 1877, during the great railway strike of that year, a large amount of property was destroyed by a mob. The commercial importance of the city was increased by the canal from Pittsburg to Philadelphia, built by the state in 1834 at a cost of \$10,000,000. The first petroleum pipe line reached Pittsburg in 1875. A movement to consolidate the cities of Pittsburg and Allegheny, together with some adjacent boroughs, was begun in 1853-1854. It failed entirely in that year but in 1867 Lawrenceville, Peebles, Collins, Liberty, Pitt and Oakland, all lying between the two rivers, were annexed to Pittsburg; in 1872 there was a further annexation of a district embracing 27 sq. m. south of the Monongahela river; in 1906 Allegheny (q.v.), although a large majority of those voting on the question in that city were opposed to it, was annexed, and in November 1907 the Supreme Court of the United States declared valid the act of the state legislature under which the vote was taken.

See N. B. Craig, *The History of Pittsburgh* (Pittsburg, 1851); *Early History of Western Pennsylvania and the West*, by a gentleman of the bar—J. D. Rupp (Pittsburg, 1848); William H. Egle,

Illustrated History of the Commonwealth of Pennsylvania (Harrisburg, Pa., 1876); Sarah H. Killikelly, *The History of Pittsburgh, Its Rise and Progress* (Pittsburg, 1906); S. H. Church, "Pittsburgh the Industrial City," in L. P. Powell's *Historic Towns of the Middle States* (New York, 1899); G. H. Thurston, *Pittsburgh and Allegheny in the Centennial Year* (Pittsburg, 1876); for a history of the various forts as such, *Report of the Commission to Locate the Frontier Forts of Pennsylvania*, vol. ii. (Harrisburg, Pa., 1896); and for a thorough study of economic and social conditions in Pittsburg, P. U. Kellogg (ed.), *The Pittsburg Survey* (6 vols., New York, 1910 sqq.), prepared under the direction of the Sage Foundation.

PITTSFIELD, a city and the county-seat of Berkshire county, Massachusetts, U.S.A., in the western part of the state among the Berkshire Hills, and about 150 m. W. of Boston. Pop. (1890), 17,281; (1900), 21,766, of whom 4344 were foreign-born; (1910 census), 32,121. Area, about 41 sq. m. It is served by the New York, New Haven & Hartford and the Boston & Albany (New York Central & Hudson River) railways, and by two inter-urban electric lines. Pittsfield is a popular summer resort; it lies in a plain about 1000 ft. above sea-level, is surrounded by the picturesque Berkshire Hills, and is situated in a region of numerous lakes, one of the largest—Lake Pontonoc—being a summer pleasure resort. On either side of the city flow the east and west branches of the Housatonic river. Standing in the public green, in the centre of the city, is the original statue (by Launt Thompson) of the "Massachusetts Color Bearer," which has been reproduced on the battlefield of Gettysburg, Pennsylvania. The principal institutions are the House of Mercy Hospital, with which is connected the Henry W. Bishop Memorial Training School for nurses, the Berkshire Home for aged women, the Berkshire Athenaeum, containing the public library, the Crane Art Museum and a Young Men's Christian Association. Prominent buildings are St. Joseph's Cathedral and the buildings of the Berkshire Life Insurance Company, the Agricultural National Bank and the Berkshire County Savings Bank. In the south-western part of Pittsfield, on the boundary between it and Hancock, is Shaker Village, settled about 1790 by Shakers. Pittsfield has water-power and important manufacturing industries. In 1905 its factory products were valued at \$8,577,358, or 49.1% more than in 1900. Fully half of the manufactures consist of textile goods.

The first settlement in what is now Pittsfield was made in 1743, but was soon abandoned on account of Indian troubles. In 1749 the settlement was revived, but the settlers did not bring their families to the frontier until 1755. The settlement was first called "Boston Plantation," or "Poontoosuck," but in 1761, when it was incorporated as a township, the name was changed to Pittsfield, in honour of the elder William Pitt. In 1801 Pittsfield was chartered as a city. It was here, in the Appleton (or Plunkett) House, known as "Elm Knoll," and built by Thomas Gold, father-in-law of Nathan Appleton, that in 1845 Henry W. Longfellow (who married Nathan Appleton's daughter) wrote his poem "The Old Clock on the Stairs." For thirty years (1842-1872) Pittsfield was the home of the Rev. John Todd (1800-1873), the author of numerous books, of which *Lectures to Children* (1834; 2nd series, 1858) and *The Student's Manual* (1835) were once widely read. From 1807 to 1808 Elkanah Watson (1758-1842), a prominent farmer and merchant, lived at what is now the Country Club, and while there introduced the merino sheep into Berkshire county and organized the Berkshire Agricultural Society; he is remembered for his advocacy of the building of a canal connecting the Great Lakes with the Atlantic Ocean, and as the author of *Memoirs: A Memoir and Times of the Revolution* (1855), edited by his son, W. C. Watson.

PITTSSTON, a city of Luzerne county, Pennsylvania, U.S.A., on the Susquehanna river just below the mouth of the Lackawanna, about 11 m. S.W. of Scranton and about 9 m. N.E. of Wilkes-Barre. Pop. (1890), 10,302; (1900), 12,556, of whom 3394 were foreign-born; (1910 census), 16,267. It is served by the Erie, the Lehigh Valley, the Delaware, Lackawanna & Western, the Central of New Jersey, the Delaware & Hudson, and the Lackawanna & Wyoming Valley railways; there is an electric railway from Pittston to Scranton, and a

belt-line electric railway connects Pittston with Avoca, Nanticoke, Plymouth and Wilkes-Barre. Two bridges connect the city with the borough of West Pittston (pop., 1910, 6848). Pittston is in the midst of the richest anthracite coal region of the state, and fire-clay also abounds in the vicinity. In 1905 the value of the factory products was \$1,474,928 (27.8% more than in 1900). Pittston, named in honour of William Pitt, earl of Chatham, was one of the five original towns founded in the Wyoming Valley by the Susquehanna Company of Connecticut; it was first settled about 1770 and was incorporated as a borough in 1803. It was chartered as a city in 1894.

PITYRIASIS VERSICOLOR (Gr. *πυρρῶσις*, scurf, from *πυρρῶς*, bran), a skin disease, consisting of patches of brownish discolorations of various sizes and shapes, mostly on the front of the body, and often attended with itching, especially after heating exercise. The pigmentation seems to radiate from the orifices of hair-follicles. The epidermis is in a scaly condition over the patch, and among the *débris* of the epidermic cell there may be seen minute oval spores due to a vegetable parasite, the *Microsporum furfur*. The disease is mostly one of adult age, found all over the world, and not associated in any special way with poor general health. The treatment consists of rubbing in an ointment of potassium sulphide or one of the mercurial ointments, or using sulphur-soap habitually.

PIURA, the northernmost maritime department of Peru, bounded north by the Gulf of Guayaquil, N.E. by Ecuador, S by the departments of Cajamarca and Lambayeque, and W by the Pacific. Area, 14,849 sq. m., pop. (1906, estimate), 154,080—both totals exclusive of the province of Tumbes, or Tumbes (area, about 1980 sq. m.; pop., in 1906, about 8000), which has been administratively separated from the department for military reasons. The department belongs partly to the arid coastal plain that extends from the Gulf of Guayaquil southward nearly to Valparaiso, and partly to a broken mountainous region belonging to the Western Cordilleras. The coastal zone is traversed by the Tumbes, Chira and Piura rivers, which have their sources in the melting snows of the higher Andes and flow westward across the desert to the coast. The valleys of the Chira and Piura are irrigated and maintain large populations. Rough cotton, called "vegetable wool," and tobacco are the principal products, and are also produced in the valley of the Tumbes and in some of the elevated mountain districts. On the upland pastures cattle have long been raised, and goat-breeding has been added in modern times. Mules also are reared. Petroleum is an important product, and there are wells at a number of places along the coast, from Tumbes to Secura, the most productive being those of Talara and Zorritos. There are sulphur deposits in the Secura desert, and salt is manufactured at some places on the southern coast. The making of Panama hats from the fibre of the "toquilla" palm is a household industry. The capital is Piura (est. pop. 9100 in 1906), on the Piura river, about 35 m. (direct) E.S.E. of Paíta, and 164 ft. above sea-level. It was founded by Pizarro in 1531 under the name of San Miguel, at a place called Tangarara, nearer Paíta, but the present site was afterwards adopted. A railway (60 m. long) by way of Sullana connects with the port of Paíta, and an extension of 6 m. runs S.S.E. to Catacaos. Other towns of the department, with their estimated populations in 1906, are: Tumbes, or Tumbes (2300), the most northern port of Peru, on the Gulf of Guayaquil, celebrated as the place where Pizarro landed in 1531; Paíta; Secura (6450), on Secura Bay in the southern part of the department, with exports of salt and sulphur; Sullana (5300), an inland town with railway connexions in the fertile Chira valley; Morropón (3800) on the upper Piura; Huanacabamba, the centre of a tobacco district in the mountains, and Tambo Grande (6100) and Chulucanas (4600), both in the fertile Piura valley above the capital.

PIUS, the name of ten popes.

PIUS I., pope from about 141 to 154. He was the brother of Hermas, author of the *Shepherd*.

PIUS II (Enea Silvio de' Piccolomini, known in literature as Aeneas Silvius), pope from 1458 to 1464, was born on the 18th

of October 1405, at Corsignano (afterward called Pienza after him), near Siena. His family, though poor, was noble, and claimed to trace descent from Romulus. The eldest of eighteen children, he had to work on the farm with his father, until a priest taught him the rudiments of letters, which enabled him, at the age of eighteen, to go as a poor student to Siena, dividing his time between severe humanistic studies and a life of sensual pleasure. He was attracted to Florence by the teaching of Filelfo. His father urged him to become a lawyer, but he accepted the position of secretary to Domenico Capranica, bishop of Fermo, and went with him to the council of Basel, where he stayed several years (1431-1435), changing masters whenever he could improve his position. As secretary of the bishop of Novara he became engaged in a conspiracy against Pope Eugenius IV.; his master was caught and imprisoned, and Aeneas only saved himself by a hasty flight. He was next (1435) employed as secretary of Cardinal Nicholas Albergati (d. 1443) at the congress of Arras, where peace was made between France and Burgundy. From here he took a long journey to Scotland and England, on a secret diplomatic mission, he had numerous adventures, in one of which he nearly lost his life. In 1436 he was back at Basel, and, although a layman, obtained a seat in the council and exercised considerable influence. In order to control it better Eugenius tried to get the council to move to Florence; a minority agreed and seceded; the majority, however, stayed where they were and took vigorous measures against the pope, culminating in his deposition on the 25th of June 1438. Aeneas took an active part in the council; and though he still declined to take orders, he was given a position on the conciliar conclave which elected Amadeus of Savoy as pope under the title of Felix V. In return for his services Felix made Aeneas papal secretary.

A new period of his career opened in 1442, when he was sent by the council to take part in the diet of Frankfort-on-Main. Here he met Frederick III. of Germany, who made him poet laureate and his private secretary. He ingratiated himself with the chancellor, Kaspar Schlick, at Vienna, one of whose adventures he celebrated in *Lucretia and Eurialus*, a novel in the style of Boccaccio. At this period he also wrote his witty but immoral play, *Christis*. In 1446 he took orders as subdeacon, and wrote that he meant to reform, "forsaking Venus for Bacchus," chiefly on the ground of satiety, and also, as he frankly wrote, because the clerical profession offered him more advantages than he could secure outside it.

Aeneas was useful to Frederick as a diplomatist, and managed to give all parties the impression that he was the devoted advocate of each. During the struggle between pope and council he induced Frederick to be neutral for a while. He took an important part in the diet of Nuremberg (1444), and being sent on an embassy to Eugenius in the following year he made his peace with the pope. At the diet of Frankfort (Sept. 1446) Aeneas was instrumental in changing the majority of the electors from their hostile position towards pope and emperor into a friendly one. He brought the good news to Eugenius shortly before his death (Feb. 7, 1447), and made friends with the new pope, Nicholas V., by whom he was made bishop of Siena. He was an agent of Frederick in making the celebrated concordat of Vienna (also called concordat of Aschaffenburg) in February 1448. His services to pope and emperor brought him the titles of prince of the empire and cardinal, positions which he used rather unscrupulously to get as many lucrative benefices into his hands as possible. Those in Germany brought him two thousand ducats a year.

The death of Calixtus III. (who succeeded Nicholas V.) occurred on the 5th of August 1458. After a hot fight in the conclave, in which it seemed that the wealthy French cardinal, Guillaume d'Estouteville, archbishop of Rouen and bishop of Ostia, would be elected, the intrigues of Aeneas and of his friend Rodrigo Borgia (later the notorious Alexander VI.) gave the victory to the cardinal of Siena, who took the title Pius II., with a reminiscence of Virgil's "pius Aeneas." The humanists hailed his election with joy, and flocked around to secure a share

of the good things, but they were bitterly disappointed, as Pius did not prove himself the liberal and undiscriminating patron they hoped. The fall of Constantinople in 1453 had made a deep impression upon Pius, and he never ceased to preach the crusade against the Turk. In September 1459 he opened a congress at Mantua for the purpose of considering what could be done in this direction. His proposals for the raising of troops and money met with general opposition. The French were angry because Pius had crowned the Spanish claimant, Ferdinand, king of Naples, and thus disposed of the pretensions of René of Anjou. The Germans also objected to Pius's plans, but finally agreed to furnish some troops and money, promises which they did not carry out. Pius felt how much the position of the papacy had fallen in importance since the days of Urban and Innocent III., and, believing that the change was due to the general councils which had asserted power over the popes, he changed his position, which before his election to the papal throne had been that of a warm advocate of the conciliar claims, and issued (Jan. 1460) the bull *Execrabilis et in pristinis temporibus inauditus*, in which he condemned as heretical the doctrine that the councils were superior to the popes, and proclaimed the anathema against any one who should dare to appeal to one. He issued another bull at the same time, promising forgiveness of sins to those who would take part in the crusade, and then dissolved the congress.

While Pius was at Mantua war broke out between the French and Spanish in southern Italy, and a rising of the barons devastated the Campagna. Hurrying back to Rome Pius succeeded in quelling the disorders, and sent his nephew Antonio Todeschini to the aid of Ferdinand, who made him duke of Amalfi and gave him his natural daughter Maria in marriage. This measure still further alienated the pope from the French, with whom he was at that time negotiating for the abrogation of the Pragmatic Sanction. When Louis XI. came to the throne (Nov. 1461), he sent to Pius saying that he had abolished the Pragmatic Sanction, hoping in return to get the kingdom of Naples for his countryman René of Anjou. When Pius refused to do anything to the prejudice of Ferdinand, Louis changed his attitude, and allowed the protests of the university of Paris and the parlements to persuade him to restore the ancient liberties of the Gallican Church. At the same time a serious quarrel with the Germans prevented anything being done towards a crusade. George Podiebrad, king of Bohemia, was plotting to depose the emperor Frederick III., who was supported by Pius. Diether, archbishop of Mainz, took the side of Podiebrad, and replied to Pius's measures by appealing to a general council. He was declared deposed by the pope, but kept his seat, and in 1464 compelled the pope to recognize him again. The quarrel with Podiebrad, who was accused of supporting the Ultraquist heresy, continued with increasing bitterness, but without any decisive result, until the death of Pius. In the meantime the pope did what he could to further the cause of the crusade. The discovery of alum mines at Tolfa gave him an unexpected pecuniary resource, and to stimulate the zeal of Christendom, Pius took the cross on the 18th of June 1464. He set out for Venice, where he intended to sail for the East, but he was attacked with a fever, and on the 14th of August 1464 he died.

Pius II. was a voluminous author. Besides poems, a novel and a play, he wrote a number of orations, which were considered models of eloquence in their day. His most valuable work, however, is his *Commentaries*, a history of his own life and times, told in an interesting and rational manner. He is very frank about himself, and most of the adverse judgments which have been pronounced on his character have been based on his own confessions. He was an opportunist, sailing along with any favourable breeze, and not quite enough in earnest about anything to pursue the same tack steadily for long. We must give him the credit, however, of advocating a statesman-like policy in the interests of the whole of Europe in trying to get the powers to unite against the Turks, who threatened to overwhelm them all.

See Herzog-Hauck, *Realencyclopädie* (1904), vol. xv., where a full bibliography will be found; M. Creighton, *History of the Popes during the Reformation*, vol. ii. (London, 1882); L. Pastor, *History of the Popes from the close of the Middle Ages* (Eng. trans., 1896, vol. ii.); Vogt, *Pius II.* (1856-1863). The *Commentaries* of Pius were published in 1584, under the name of Gobelinus Perona. His other works are found in *Aeneas Silvii opera omnia* (Basel, 1551). See also W. Bouling, *Aeneas Silvius* (1909). (P. Su.)

PIUS III. (Francesco Nanni-Todeschini-Piccolomini), pope from the 22nd of September to the 18th of October 1503, was born at Siena on the 9th of May 1439. After studying law at Perugia, he was made archbishop of Siena and cardinal-deacon of St Eustachio, when only twenty-two years of age, by his uncle Pius II., who permitted him to assume the name and arms of the Piccolomini. He was employed by subsequent popes in several important legations, as by Paul II. at the diet of Regensburg, and by Sixtus IV. to secure the restoration of ecclesiastical authority in Umbria. He bravely opposed the policy of Alexander VI., and was elected pope, amid the disturbances consequent upon the death of the latter, through the interested influence of Cardinal della Rovere, afterwards Julius II., and was crowned on the 8th of October 1503. He permitted Cesare Borgia to return to Rome, but promptly took in hand the reform of the curia. Pius was a man of blameless life, and would doubtless have accomplished much had he lived. His successor was Julius II.

See L. Pastor, *History of the Popes*, vol. vi., trans. by F. I. Antrobus (London, 1898); M. Creighton, *History of the Papacy*, vol. v. (London, 1901); F. Gregorovius, *Rome in the Middle Ages*, vol. viii., trans. by Mrs G. W. Hamilton (London, 1900-1902); Piccolomini, "Il Pontificato di Pio III.," in *Archivio stor. ital.*, vol. v. (Firenze, 1903).

PIUS IV. (Giovanni Angelo Medici, or "Medighino"), pope from 1559 to 1565, was born at Milan on the 31st of March 1499, of an obscure family, not related to the Medici of Florence (a claim to such relationship was advanced after Giovanni Angelo had attained to prominence). The fortune of the family was established by an elder brother, Gian Giacomo, who fought his way to the marquise of Marignano and distinguished himself in the service of the emperor. Giovanni Angelo studied in Bologna and Pavia, and for some time followed the law. Entering the service of the Church, he found favour with Paul III., who entrusted him with the governorship of several important towns, and in 1549 made him a cardinal. Julius III. sent him upon missions to Germany and Hungary. With Paul IV. he was out of favour, because not in sympathy with his policy, and accordingly retired to Milan. In the protracted and momentous conclave that followed the death of Paul the election of Pius (Dec. 25, 1559) was due to a compromise between the Spanish and French factions.

In temperament and habit Pius was the antithesis of his predecessor: affable, vivacious, convivial. He was, moreover, astute, diplomatic and experienced in affairs. He allowed the reform movement free course, but tried to repair certain injustices of Paul IV. (for example, releasing and reinstating Morone, who had been imprisoned on a charge of heresy), and mitigated some of his extreme decrees. But to the nephews of Paul he showed no mercy: they were charged with various crimes, condemned, upon testimony of suspicious validity, and executed on the 5th of March 1561. The Colonnae, who had been active in the prosecution, recovered Paliano. But under Pius V. judgment was reversed, the memory of the Caraffa rehabilitated, and restitution made to the family. Pius IV. himself was not guiltless of nepotism; but the bestowment of the cardinalate and the archbishopric of Milan upon his nephew, the pure and upright Carlo Borromeo, redounded to the honour of his pontificate and the welfare of the church.

With England lost to the papacy, Germany overwhelmingly Protestant, and France on the verge of civil war, Pius realized how fatuous was the anti-Spanish policy of his predecessor. He therefore recognized Ferdinand as emperor, and conciliated Philip II. with extensive ecclesiastical privileges. But subsequently, antagonized by Philip's arrogance, he inclined towards France, and gave troops and money for the war against the Huguenots.

After a suspension of ten years the council of Trent reconvened on the 18th of January 1562. Among the demands presented by the various nations were, the recognition of the equality of the episcopate, communion in both kinds, clerical marriage, and the use of the vernacular in Church services. It required all the pope's diplomacy to avoid compliance on the one hand, and a breach with the powers on the other. Thanks to Morone and Borromeo, however, he achieved his end. The council was dissolved on the 4th of December 1563, and its decrees and definitions confirmed by the pope (Jan. 26, 1564), who reserved to himself the sole right of interpretation. The decrees were immediately accepted by most of the Catholic states; only tardily, however, and with reservation by France and Spain. Various measures were taken for carrying the decrees into effect: residence was strictly enjoined; plurality of benefices prohibited; the Inquisition resumed, under the presidency of Ghislieri (afterwards Pius V.); a new edition of the Index published (1564); and the "Tridentine creed" promulgated (Nov. 13, 1564).

After the termination of the council Pius indulged his desire for ease and pleasure, to the great offence of the rigorists. A certain fanatic, Benedetto Accolti, brooding over the pope's unworthiness, felt inspired to remove him, but his plot was discovered and punished (1565). Pius fortified Rome, and contributed much to the embellishment of the city—among other works, the church of Sta Maria degli Angeli in the Baths of Diocletian; the Porta Pia; the Villa Pia in the Vatican Gardens; and the Palace of the Conservatori. He died on the 9th of December, and was succeeded by Pius V.

See Panvino, continuator of Platina, *De vitis pontif. rom.* (a contemporary of Pius); Ciaconius, *Vitae et res gestae summorum pontif. rom.* (Rome 1601-1602; also contemporary); T. Müller, *Das Konklave Pius IV.* (Gotha, 1889; more comprehensive than the title suggests); Ranke, *Popes* (Eng. trans., Austin), i. 323 seq., 358 seq.; and v. Reumont, *Gesch. der Stadt Rom.* iii. 2, 534 seq., 730 seq. (T. F. C.)

Pius V. (Michele Ghislieri), pope from 1566 to 1572, was born on the 17th of January 1504, in the Milanese. At the age of fourteen he became a Dominican monk. His austere life, his vehemence in attacking heresy and his rigorous discipline as prior of several monasteries proved his fitness for the work of reform, and he was appointed inquisitor in Como, where his zeal provoked such opposition as to compel his recall (1550). The chief inquisitor, Caraffa, convinced of his value, straightway sent him upon a mission to Lombardy, and in 1551 appointed him commissary-general of the Holy Office. When Caraffa became pope, Ghislieri was made bishop of Nepi and Sutri, cardinal (1557), and finally grand inquisitor, which office he discharged in a manner to make the name of "Fra Michele dell'Inquisizione" a terror. In this office he was continued by Pius IV., whom, however, he repelled by his excessive severity, and antagonized by his censoriousness and obstinacy. But the movement with which he was so fully identified was irresistible; and, after the death of Pius IV., the rigorists, led by Borromeo, had no difficulty in making him pope (Jan. 7, 1566).

Though pope, Pius did not cease to be a monk: his ascetic mode of life and his devotions suffered no interruption. Without delay he applied himself to the work of reform. Decrees and ordinances were issued with astonishing rapidity: the papal court was rid of everything unseemly, and became a model of sobriety; prostitutes were driven from the city, or confined to a certain quarter; severe penalties were attached to Sunday desecration, profanity and animal baiting; clerical residence was enforced; conventuals were compelled to live in strict seclusion according to their vows; catechetical instruction was enjoined. A new catechism appeared in 1566, followed by an improved breviary (1568), and an improved missal (1570). The use of indulgences and dispensations was restricted, and the penitential system reformed.

Pius was the avowed enemy of nepotism. One nephew, it is true, he made cardinal, but allowed him no influence: the rest of his relatives he kept at a distance. By the constitution *Admonet nos* (March 29, 1567), he forbade the reinvestiture

of fiefs that should revert to the Holy See, and bound the cardinals by oath to observe it. In March 1569 Pius ordered the expulsion of the Jews from the states of the Church. For commercial reasons they were allowed to remain in Rome and Ancona, but only upon humiliating conditions. In February 1571, the Umiliati, a degenerate monastic order of Milan, was suppressed on account of its complicity in an attempt upon the life of the archbishop, Carlo Borromeo.

The election of Pius to the papacy was the enthronement of the Inquisition: the utter extinction of heresy was his darling ambition, and the possession of power only intensified his passion. The rules governing the Holy Office were sharpened; old charges, long suspended, were revived; rank offered no protection, but rather exposed its possessor to fiercer attack; none were pursued more relentlessly than the cultured, among whom many of the Protestant doctrines had found acceptance; princes and states withdrew their protection, and courted the favour of the Holy See by surrendering distinguished offenders. Cosmo de' Medici handed over Pietro Carnesecchi (and two years later received in reward the title of grand duke, Sept. 1569); Venice delivered Guido Zanetti; Philip II., Bartolomé de Carranza, the archbishop of Toledo. In March 1571 the Congregation of the Index was established and greater thoroughness introduced into the pursuit of heretical literature. The result was the flight of hundreds of printers to Switzerland and Germany. Thus heresy was hunted out of Italy: the only regret of Pius was that he had sometimes been too lenient. In 1567 Pius condemned the doctrines of Michael Baius, a professor of Louvain, who taught justification by faith, asserted the sufficiency of the Scriptures, and disparaged outward forms. Baius submitted; but his doctrines were afterwards taken up by the Jansenists.

The political activities of Pius were controlled by one principle, war upon the heretic and infidel. He spurred Philip II. on in the Netherlands, and approved the bloody work of Alva. He denounced all temporizing with the Huguenots, and commanded their utter extermination (*ad internecionem usque*). While it cannot be proven that he was privy to the massacre of St Bartholomew, still his violent counsels could not fail to stir up the most savage passions. He exclaimed loudly against the emperor's toleration of Protestantism, and all but wished his defeat at the hands of the Turks. He urged a general coalition of the Catholic states against the Protestants; and yet published, in sharper form, the bull *In coena domini* (1568), which was regarded by these very states as an attack upon their sovereignty. One of his cherished schemes was the invasion of England and the dethronement of Elizabeth, whom he excommunicated and declared a usurper (Feb. 25, 1570); but he was obliged to content himself with abetting plots and fomenting rebellions. He did, however, effect an alliance with Spain and Venice against the Turks, and contributed to the victory of Lepanto (Oct. 6, 1571).

Thus lived and wrought Pius, presenting "a strange union of singleness of purpose, magnanimity, austerity and profound religious feeling with sour bigotry, relentless hatred and bloody persecution" (Ranke). He died on the 1st of May 1572; and was canonized by Clement XI. in 1712.

See Ciaconius, *Vitae et res gestae summorum pontif. rom.* (Rome, 1601-1602); *Acta sanctorum, maji*, tom. I. pp. 616 seq., containing the life by Gabuzio (1605), based upon an earlier one by Catena (1586); Falloux, *Hist. de St Pie V.* (3rd ed., Paris, 1858), eulogistic; Mendham, *Life and Pontificate of St Pius V.* (London, 1832), a bitter polemic. The life of Pius has also been written by Fuenmayor (Madrid, 1593); Paolo Alessandro Maffei (Rome, 1712), and by T. M. Granello (Bologna, 1877). His letters have been edited by Catena (*vide supra*), Goubau (Antwerp, 1640), and a select number in a French translation, by de Potter (Paris, 1805). See also Hiliger, *Die Wahl Pius V. zum Papste* (Leipzig, 1801); Ranke, *Popes* (Eng. trans., Austin), i. 361 seq., 384 seq.; and von Reumont, *Gesch. der Stadt Rom.* iii. 2, 557 seq. (T. F. C.)

Pius VI. (Giovanni Angelo Braschi), pope from 1775 to 1799, was born at Cesena, on the 27th of December 1717. After taking the degree of doctor of laws he went to Ferrara and became the private secretary of Cardinal Ruffo, in whose bishopric of Ostia and Velletri he held the post of *uditor* until 1733. His

skill in the conduct of a mission to the court of Naples won him the esteem of Benedict XIV., who appointed him one of his secretaries and canon of St Peter's. In 1758 he was raised to the prelature, and in 1766 to the treasurership of the apostolic chamber by Clement XIII. Those who chafed under his conscientious economies cunningly induced Clement XIV. to create him cardinal-priest of San Onofrio on the 26th of April 1773, a promotion which rendered him for the time innocuous. In the four months' conclave which followed the death of Clement XIV., Spain, France and Portugal at length dropped their objection to Braschi, who was after all one of the more moderate opponents of the anti-Jesuit policy of the previous pope, and he was elected to the vacant see on the 15th of February 1775.

His earlier acts gave fair promise of liberal rule and reform in the defective administration of the papal states. He showed discrimination in his benevolences, reprimanded Potenzi, the governor of Rome, for unsuppressed disorders, appointed a council of cardinals to remedy the state of the finances and relieve the pressure of imposts, called to account Nicolo Bischi for the expenditure of moneys intended for the purchase of grain, reduced the annual disbursements by the suppression of several pensions, and adopted a system of bounties for the encouragement of agriculture. The circumstances of his election, however, involved him in difficulties from the outset of his pontificate. He had received the support of the ministers of the Crowns and the anti-Jesuit party upon a tacit understanding that he would continue the action of Clement, by whose brief *Dominus ac redemptor* (1773) the dissolution of the Society of Jesus had been pronounced. On the other hand the *zelanti*, who believed him secretly inclined towards Jesuitism, expected from him some reparation for the alleged wrongs of the previous reign. As a result of these complications Pius was led into a series of half measures which gave little satisfaction to either party: although it is perhaps largely due to him that the order was able to escape shipwreck in White Russia and Silesia; at but one juncture did he even seriously consider its universal re-establishment, namely in 1792, as a bulwark against revolutionary ideas. Besides facing dissatisfaction with this temporizing policy, Pius met with practical protests tending to the limitation of papal authority. To be sure "Febronius," the chief German literary exponent of the old Gallican ideas, was himself led (not without scandal) to retract; but his positions were adopted in Austria. Here the social and ecclesiastical reforms undertaken by Joseph II. and his minister Kaunitz touched the supremacy of Rome so nearly that in the hope of staying them Pius adopted the exceptional course of visiting Vienna in person. He left Rome on the 27th of February 1782, and, though magnificently received by the emperor, his mission proved a fiasco; he was, however, able a few years later to curb those German archbishops who, in 1786 at the Congress at Ems, had shown a tendency towards independence. In Naples difficulties necessitating certain concessions in respect of feudal homage were raised by the minister Tannucci, and more serious disagreements arose with Leopold I. and Scipione de' Ricci, bishop of Pistoia and Prato, upon the questions of reform in Tuscany; but Pius did not think fit to condemn the offensive decrees of the synod of Pistoia (1786) till nearly eight years had elapsed. At the outbreak of the French Revolution Pius was compelled to see the old Gallican Church suppressed, the pontifical and ecclesiastical possessions in France confiscated and an effigy of himself burnt by the populace at the Palais Royal. The murder of the republican agent, Hugo Bassville, in the streets of Rome (January 1793) gave new ground of offence; the papal court was charged with complicity by the French Convention; and Pius threw in his lot with the league against France. In 1796 Napoleon invaded Italy, defeated the papal troops and occupied Ancona and Loreto. Pius sued for peace, which was granted at Tolentino on the 19th of February 1797; but on the 28th of December of that year, in a riot created by some Italian and French revolutionists, General Duphot of the French embassy was killed and a new pretext furnished for invasion. General Berthier marched to Rome, entered it unopposed on the 13th of February 1798,

and, proclaiming a republic, demanded of the pope the renunciation of his temporal authority. Upon his refusal he was taken prisoner, and on the 20th of February was escorted from the Vatican to Siena, and thence to the Certosa near Florence. The French declaration of war against Tuscany led to his removal by way of Parma, Piacenza, Turin and Grenoble to the ciaded of Valence, where he died six weeks later, on the 29th of August 1799. Pius VII. succeeded him.

The name of Pius VI. is associated with many and often unpopular attempts to revive the splendour of Leo X. in the promotion of art and public works—the words "Munificencia Pii VI. P. M." graven in all parts of the city, giving rise amongst his impoverished subjects to such satire as the insertion of a minute loaf in the hands of Pasquin with that inscription beneath it. He is best remembered in connexion with the establishment of the museum of the Vatican, begun at his suggestion by his predecessor, and with an unpractical and expensive attempt to drain the Pontine marshes.

AUTHORITIES.—Zöpfel and Benrath, "Pius VI.," in *Henzel-Hauck, Realencyklopädie*, 3rd ed., vol. xv. pp. 441–451 (Leipzig, 1904, with elaborate bibliography); F. Nielsen, *History of the Popes in the 18th Century*, vol. 1. chap. vii. (London, 1906); J. Gendry, *Pius VI. sa vie, son pontificat, d'après les archives vaticanes et de nombreux documents inédits* (2 vols., Paris, 1907). (W. W. R.)

Pius VII. (Luigi Barnaba Chiaramonti), pope from 1800 to 1823, the son of Count Scipione Chiaramonti and the deeply religious Countess Ghini, was born at Cesena on the 14th of August 1740 (not 1742). After studying at Ravenna, at the age of sixteen he entered the Benedictine monastery of St Mary in his native town: here he was known as Gregorio. Almost immediately he was sent by his superiors to Padua and to Rome for a further course of studies in theology. He then held various teaching appointments in the colleges of his order at Parma and at Rome. He was created an abbot of his order by his relative Pius VI., who also appointed him bishop of Tivoli on the 16th of December 1782, and on the 14th of February 1785, because of excellent conduct of office, raised him to the cardinalate and the see of Imola. At the death of Pius VI. the conclave met at Venice on the 30th of November 1799, with the result that Chiaramonti, the candidate of the French cardinal-archbishop Maury, who was most skillfully supported by the secretary of the conclave Ercole Consalvi, was elected pope on the 14th of March 1800. He was crowned on the 21st of that month; in the following July he entered Rome, on the 11th of August appointed Consalvi cardinal-deacon and secretary of state, and busied himself with administrative reforms.

His attention was at once directed to the ecclesiastical anarchy of France, where, apart from the broad schism on the question of submission to the civil constitution of the clergy, discipline had been so far neglected that a large proportion of the churches were closed, dioceses existed without bishops or with more than one, Jansenism and clerical marriage were on the increase, and indifference or hostility widely prevailed amongst the people. Encouraged by Napoleon's desire for the re-establishment of the Roman Catholic religion in France, Pius negotiated the celebrated concordat, which was signed at Paris on the 15th of July and ratified by Pius on the 14th of August 1801 (see CONCORDAT). The importance of this agreement was, however, considerably lessened by the "articles organiques" appended to it by the French government on the 8th of April 1802. In 1804 Napoleon opened negotiations to secure at the pope's hands his formal consecration as emperor. After some hesitation Pius was induced to perform the ceremony at Notre Dame and to extend his visit to Paris for four months; but in return for these favours he was able to obtain from Napoleon merely one or two minor concessions. Pius, who arrived in Rome on the 16th of May 1805, gave to the college of cardinals a more-coloured report of his experience, but disillusionment was rapid. Napoleon soon began to disregard the Italian concordat of 1803, and himself decreed the dissolution of the marriage of his brother Jerome with Miss Patterson of Baltimore. The irritation between France and the Vatican increased so rapidly that on the 2nd of February 1808 Rome was

occupied by General Miollis; a month later the provinces of Ancona, Macerata, Fermo and Urbino were united to the kingdom of Italy, and diplomatic relations between Napoleon and Rome were broken off; finally, by a decree issued from Schönbrunn on the 17th of May 1809, the emperor united the papal states to France. Pius retaliated by a bull excommunicating the invaders; and, to prevent insurrection, Miollis—either on his own responsibility, as Napoleon afterwards asserted, or by order of the latter—employed General Radet to take possession of the pope's person. The palace on the Quirinal was broken open during the night of July 5th, and, on the persistent refusal of Pius to rescind the bull of excommunication and to renounce his temporal authority, he was carried off, first to Grenoble, thence after an interval to Savona on the Gulf of Genoa. Here he steadfastly refused canonical institution to the bishops nominated by Napoleon; and, when it was discovered that he was maintaining a secret correspondence, he was deprived of all books, even of pen and ink. At length, his nerves shattered by insomnia and fever, he was willing to give satisfactory oral assurances as to the institution of the French bishops.

In May 1812 Napoleon, on the pretext that the English might liberate the pope if he were left at Savona, caused the aged and sick pontiff to be transported to Fontainebleau; the journey was so hard that on Mount Cenis Pius received the viaticum. Arriving safely, however, at Fontainebleau, he was lodged in a suite of regal magnificence to await the return of the emperor from Moscow. When Napoleon arrived, he entered into personal negotiations with the pope, who on the 25th of January 1813 assented to a concordat so degrading that his conscience found no relief till the 24th of March, when, on the advice of the cardinal Pacca and Consalvi, he abrogated it; and on the 9th of May he proceeded to defy the emperor by declaring invalid all the official acts of the new French bishops. In consequence of the battle of Leipzig and the entry of the allied forces into France, Napoleon ordered in January 1814 that the pope be returned to Savona for safe keeping; but soon the course of events forced him to liberate the pope and give back the States of the Church. On the 19th of March Pius left Savona, and was received with rejoicing at Rome on the 24th of May. While Consalvi at the Congress of Vienna was securing the restitution of nearly all the papal territory, reaction had full swing at Rome; the Jesuits were restored; the French legislation, much of which was of great social value, was repealed; the Index and the Inquisition were revived. On his return Consalvi conducted a more enlightened and highly centralized administration, based largely on the famous *Motu proprio* of 1816; nevertheless the finances were in a desperate condition. Discontent centred perhaps in the *Carbonari*, a Liberal secret society condemned by the pope in 1821. The chief triumphs of Consalvi were the negotiation of a series of valuable concordats with all the Roman Catholic powers save Austria. In the latter years of Pius's life royalty often came to Rome; the pope was very gracious to exiled kings and showed notable magnanimity toward the family of Napoleon. He also attracted many artists to the city, including the greatest sculptors of the time, one of whom, the Protestant Thorwaldsen, prepared the tomb in which repose the remains of the gentle and courageous pontiff, who passed into rest on the 20th of August 1823. His successor was Leo XII.

AUTHORITIES.—Zöpfel and Benrath, "Pius VII.," in Herzog-Hauck, *Realencyklopädie*, xv. 451-458 (Leipzig, 1904); (long list of older literature); Mario Rinaldi, *La Diplomazia pontificia nel secolo XIX.* (Rome, 1902), two volumes treating the years 1800-1805, based largely on Vatican sources; I. Rinieri, *Napoleone Pio VII. (1804-1813), relazioni storiche sui documenti inediti dell'archivio vaticano* (Turin, 1906); H. Chotard, *Le Pape Pie VII. à Savone* (Paris, 1887); Mary H. Allies, *Pius the Seventh* (London, 1897), a popular Roman Catholic biography; Leo König, S.J., *Pius VII. Die Säkularisation und das Reichskonkordat* (Innsbruck, 1904), based chiefly on Vienna material; H. Walschinger, *Le Pape et l'Empereur, 1804-1815* (Paris, 1905); Louis Madelin, *La Rome de Napoléon: la domination française à Rome de 1809 à 1814* (Paris, 1906), an elaborate study; L. G. Wickham-Legg, "The Concordats" (*Cambridge Modern History*, vol. ix. ch. 7, 1906); Lady Elizabeth Sumner, "The Papacy and the Catholic Church" (*Cambridge Modern History*, vol. x. ch. 5, 1907). Both these last have good bibliographies. (W. W. R.)

PIUS VIII. (Francesco Xaviero Castiglioni), pope from 1829 to 1830, who came of a notable family at Cingoli near Ancona, was born on the 20th of November 1761. He studied canon law at Rome, became vicar-general at Anagni and later at Fano, and in 1806 was appointed bishop of Montalto. Because he refused the oath of allegiance to the Napoleonic king of Italy he was carried captive to France; but in 1826 his steadfastness was rewarded by his being created cardinal-priest of Sta Maria in Trastevere; and this same year he was translated from the see of Montalto to that of Cesena. In 1821 he was made cardinal-bishop of Frascati, also grand-penitentiary; and later he became prefect of the Congregation of the Index. In the conclave which followed the death of Leo XII., Castiglioni, the candidate of France, was elected pope on the 31st of March 1829. He avoided nepotism, abandoned the system of espionage employed by his predecessor, and published an encyclical condemning Bible societies and secret associations. He rejoiced over Catholic emancipation in England, recognized Louis Philippe as king of the French, and exhibited a pacific spirit in dealing with the problem of mixed marriages in Germany. Worn out with work, he died on the morning of the 1st of December 1830. His successor was Gregory XVI.

AUTHORITIES.—Zöpfel and Benrath, "Pius VIII.," in Herzog-Hauck, *Realencyklopädie*, xv. 458 seq. (Leipzig, 1904, with bibliography); F. Nielsen, *A History of the Papacy in the 19th Century*, li. 31-30 (London, 1906); P. B. Gams, *Series episcoporum ecclesie catholice* (Regensburg, 1873). (W. W. R.)

PIUS IX. (Giovanni Maria Mastai-Ferretti), pope from 1846 to 1878, was born on the 13th of May 1792 at Sinigaglia, the fourth son of Count Jerome and Countess Catherine Volazzi; the family of Mastai was of ancient descent, and the title of count came to it in the 17th century, while later the elder branch, allied by marriage with the Ferretti family, took that name in addition. He spent some time at the College of Piarists in Volaterra, and then proceeded to Rome with the intention of entering the pontifical guard as an officer. In spite of his good connexions, he was disappointed in this aim as it became known that he suffered from epilepsy. The malady, however, was surmounted; and in 1819 he was ordained priest. After ministering for some time in his native town, he accompanied Cardinal Muzzi to Chile (1823). On his return he was entrusted by Leo XII. with the direction of the Roman hospital of San Michele; in 1830 he received the archbishopric of Spoleto, in 1832 the bishopric of Imola, and in 1840 Gregory XVI. created him a cardinal, with the title Santi Pietro e Marcellino.

On the death of Gregory XVI. (June 1, 1846) the College of Cardinals met in conclave on the 14th of June. But their deliberations were destined to last but a short while; for, on the 16th of June, Cardinal Mastai Ferretti had already obtained the requisite two-thirds majority, and ascended the papal chair under the title of Pius IX. In his various capacities he had gained much popularity: he had shown himself to be of a kindly disposition and a zealous churchman, and his reputation for piety and tact stood high; he possessed, too, a winning personality and a handsome presence.

The reign of Pius IX. began at an extremely critical time. The problem of the government of the Papal States, transmitted to him by his predecessor, stood in urgent need of solution, for the actual conditions were altogether intolerable. The irritation of the populace had risen to such a pitch that it found vent in revolts which could only be quelled by the intervention of foreign powers; and the ferment in the dominions of the Church was accentuated by the fact that the revolutionary spirit was in the ascendant in all the states of Europe. The proclamation of a general amnesty for all political offenders made an excellent impression on the people; and Pius at once instituted preparations for a reform of the administration, the judicature and the financial system. The regulations affecting the censorship were mitigated, and a breath of political liberalism vitalized the whole government. Pius at once acquired the reputation of a reforming pope. But the prestige so gained was not sufficient to calm the people permanently, and two demands were urged with ever increasing energy—a share in the government and a national

Italian policy. The problem of giving the people a due share in the government was one of peculiar difficulty in the papal states. It was not simply a question of adjusting the claims of monarch and subject: it was necessary, at the same time, to oust the clergy—who, till then, had held all the more important offices in their own hands—from their dominant position, or at least to limit their privileges. That the clerical character of the administration could not be indefinitely retained was plain enough, it would seem, to any clear-thinking statesman: for, since the restoration of the papal state in 1814, the pernicious effects of this confusion of the spiritual and the secular power could no longer be denied. But Pius IX. lacked the courage and perspicacity to draw the inevitable conclusions from these premises; and the higher clergy at Rome were naturally opposed to a policy which, by laicizing the administration, would have deprived them of the power and privileges they had so long enjoyed. In these circumstances it is not surprising that the pope, while making concessions to his people, did so with reservations which, so far from restoring peace, served only to aggravate the turmoil.

By a *motu proprio* of the 2nd of October 1847 the government of the city of Rome was reorganized and vested in a council of 100 members, not more than four of whom were to be clerics. But the pope reserved to himself the right of nominating the first members, and the new senate was only later to have the right of filling up vacancies by co-optation. The institution of a state council (*consulta*) was announced on the 10th of April 1847; and on the 14th of October it was called into existence by a *motu proprio*. It consisted of 24 councillors, who were to be selected by the pope from a list of candidates to be submitted by the provincial assemblies. A cardinal and one other prelate were to be at its head. The *consulta* was to be divided into four sections, dealing with (1) legislation, (2) finance, (3) internal administration, (4) the army and public works. Matters of importance were, however, to be submitted to the College of Cardinals, after being debated in the *consulta*. A *motu proprio* of the 29th of December altered the constitution of the ministerial council. Nine mutually independent ministries were formed, and the principle of the responsibility of the ministers was established: but all the positions were filled by clerics.

The agitation for constitutional government was urgent in the demand for further concessions; but they came too late. On the 12th of February a proclamation of the pope transferred three portfolios to the laity; but the impression produced by the news of the revolution in Paris nullified the effect. At the formation of the Antonelli ministry (March 11), only the three departments of foreign affairs, finance and education, were reserved by the clergy; while the remaining six were entrusted to laymen. On the 14th of March 1848 Pius took the last step, and published a constitution (*Fundamental Statute for the Secular Government of the States of the Church*). Two chambers were to be formed. The first (*alta consiglio*) consisted of members nominated for life by the pope; the second, of a hundred elected deputies. The laws adopted by these two chambers had first to undergo the scrutiny of the College of Cardinals, before being submitted to the pope for his assent or rejection. Ecclesiastical, or ecclesiastico-political, affairs were exempted from the jurisdiction of the parliament; which was further required to abstain from the enactment of laws conflicting with the discipline of the Church, and from criticism of the diplomatic and religious relations of the Holy See with foreign powers.

The utility of this constitution was never tested; for the demand for an extension of popular rights was now eclipsed by a still more passionate aspiration towards the national unity of Italy. This nationalist movement at once took head against Austria. On the 18th of March the revolution broke out in Milan, and King Albert of Sardinia undertook the conduct of the war against the emperor. When news of the events at Milan reached Rome the populace was swept away in a whirlwind of enthusiasm: the Austrian embassy was mobbed; the imperial arms, surmounting the main gate of the palace, were torn down; and great troops of volunteers clamoured to be led against Austria. Pius was carried away at first on the flood-tide of excitement, and seemed,

after his proclamation of the 30th of March, on the point of conferring his blessing upon the war against Austria. But the course of political events during the next few weeks damped his ardour. When, on the 29th of April, in his allocution to the cardinals, he proclaimed the papal neutrality, the Romans received his vacillation as a sign of treachery; and the storm, precluded from discharging its fury on Austria, broke over his head. When the ministry in power resigned office on the 1st of May, the Mamiani administration was formed, only one cleric being included. Mamiani himself, whose writings were on the Index, had little sympathy with the pope, and did all that was possible to complete the secularization of government in the States of the Church. He received his dismissal on the 1st of August, and was followed by Count Fabri, then by Count de Rossi, who made the last attempt to restore order by a moderate liberal policy. On the 15th of November, as he was about to open the Chambers, he was assassinated on the staircase leading to the hall of session. A state of anarchy ensued. Armed bands gathered before the Quirinal, and attempted to storm it. To avoid further bloodshed the pope was compelled to assent to the formation of a radically democratic ministry under Galetti. The Swiss, who composed the papal guard, were disbanded; and the protection of the pontiff was transferred to the civil militia; in other words, Pius IX. was a prisoner. On the evening of the 24th of November he contrived by the aid of the French and Bavarian ambassadors—the duc d'Harcourt and Count Spaur—to leave the palace unobserved, in the dress of a common priest, and to reach Gaeta in the kingdom of Naples. From this refuge he issued a breve on the 27th of November, protesting against the sacrilege practised on himself, declaring all actions forced upon him null and void, and appointing a commission to carry on the government in his absence. Since the Chamber declined to recognize this step, and the pope was equally resolute in refusing to hold any intercourse with the deputation which it despatched to him, a supreme *Giunta* was provisionally created by the Chamber on the 11th of December to discharge all the functions assigned to the executive power by the constitution. On the 17th of the same month Pius made a public protest; and, as soon as the elections for a national assembly were announced, he forbade any participation in them, menacing the disobedient with the penalties of the Church (Jan. 1, 1849). The elections, however, were held; and on the 9th of February the constituent assembly decreed, by 142 votes to 23, the erection of a Roman republic. Pius answered by a protest dated the 14th of February. All the ecclesiastical property of the Roman state was now declared to be vested in the republic; convents and religious edifices were requisitioned for secular purposes; benevolent institutions were withdrawn from clerical influence; and church establishments were deprived of the right to realize their possessions. In the beginning of December Pius had already appealed to the European powers for assistance; and on the 7th of February 1849 it was resolved in the Consistory to approach officially France, Austria, Spain and Naples, with a view to their armed intervention. The French republic, under the presidency of Louis Napoleon, was the first state to throw troops into Italy. On the 24th of April General Oudinot appeared before Civita Vecchia; only to be defeated at first by Garibaldi. But, after receiving reinforcements, he prosecuted the war successfully, and made his entry into Rome on the 3rd of July, while, in the early part of May an Austrian army advanced into the north of the papal states. On the 14th of July Oudinot proclaimed the restoration of the pontifical dominion; and, three days later, Pius IX. issued a manifesto entrusting the government to a commission appointed by himself.

On the 12th of April 1850 Pius returned to Rome, supported by foreign arms, embittered, and hostile henceforward to every form of political liberalism or national sentiment. In Gaeta he had mentally cut himself loose from all ideas of progress, and had thrown himself into the arms of the Jesuits. His subsequent policy was stamped by reaction. Whether it might have been possible to avoid the catastrophe of 1870 is a difficult question. But there can be no question whatever that the policy which

Pius now inaugurated, of restoring the old pre-revolutionary conditions, sealed the fate of the temporal dominion of the papacy. He made no attempt to regain the estranged affections of the populace, and took no measures to liberate himself and his subjects from the incubus of the last few years. He even sought to exact vengeance for the events of that period: the state officials, who had compromised themselves, lost their offices; and all grants in aid were forfeited if the recipients were discovered by the secret commissions (*consigli di censura*) to have taken part in the revolutionary movement. The tribunals extorted declarations on the part of witnesses by flogging, deprivation of food, and like methods of torture. In many cases the death sentence was executed at their instance, though the guilt of the accused was never established. The system of precautionary arrest, as it was termed, rendered it possible for any man to be thrown into prison, without trial and without verdict, simply on the ground that he lay under suspicion of plotting against the government. The priests, who usurped the judicial function, displayed such cruelty on several occasions that officers of the Austrian army were compelled to record a protest. The consequence of these methods was that every victim—innocent or guilty—ranked as a martyr in the estimation of his fellow-citizens. A subsidiary result was the revival of brigandage, which found a suspicious degree of support among the people. Corruption was rampant among the officials; the police were accused of illicit bargaining with criminals; and nothing but contempt was entertained for the papal army, which was recruited from the dregs of humanity. To this was added a disastrous financial administration, under which the efficiency and credit of the country sank to appalling depths. The system of taxation was calculated with a view to relieving the Church and the clergy, and imposing the main burden upon the laity. In this department the family of Cardinal Antonelli seems to have played a fatal part. The secretary of state was born in humble circumstances: when he died he left a fortune of more than 100,000,000 lire, to which a daughter succeeded in establishing her claim. His brother Felippo was president of the Roman Bank, and his brother Luigi the head of the Annona—an office created to regulate the import of grain. The pope himself had neither the will nor the power to institute searching financial reforms; possibly, also, he was ignorant of the facts.

The mismanagement which obtained in the papal dominions could not escape the observation of the other powers. As early as the Congress of Paris in 1856 the English ambassador, Lord Clarendon, had directed an annihilating criticism against the government of the pontiff; and a convincing proof of the justice of his verdict was given by Pius himself, in his treatment of the famous Mortara case. A Jewish boy of this name had been torn from his parents in Rome and the rite of baptism performed on him without their knowledge or consent. The pope flatly refused to restore the "Christian" to his Jewish parents, and turned a deaf ear both to the protest of public opinion and the diplomatic representations of France and England. The sequel to this mode of government was that the growing embitterment of the subjects of the Church came to be sympathized with outside the bounds of Italy, and the question whether the secular authority of the papacy could be allowed to continue became a much-debated problem. Even the expression of the doubt was symptomatic. In 1859 appeared an anonymous brochure, *Le Pape et le congrès*, composed by Lagueronnière, the friend of Napoleon III., in which it was proposed to ensure the pope "un revenu considérable" and the city of Rome, but to relieve him of a political task to which he was not competent. In 1861 another anonymous pamphlet, *Pro causa italica ad episcopos catholicos*, was published in Florence, advocating the ecclesiastico-political programme of Cavour; and the pope was horrified when he discovered that it came from the pen of Passaglia, the professor of dogmatic theology. In spite of all, the national idea gained strength in Italy, and the movement towards unity found powerful champions in King Victor Emmanuel of Sardinia and his great statesman Cavour. Free scope was given when the understanding between the two powers protecting the papal state—

France and Austria—broke down. So soon as Napoleon and Cavour had come to an agreement war ensued, France and Sardinia being ranged against Austria (1859). The result was that Austria lost the greater part of her Italian possessions, while the pope also forfeited two-thirds of his dominions. By the war of 1866, in which Italy fought on the Prussian side, Victor Emmanuel gained Venice in addition; so that the States of the Church now formed the last remaining obstacle to complete national unity. In September 1864, France—who had been the protectress of these states since 1849—had concluded a treaty with Victor Emmanuel, undertaking to withdraw her garrison from Rome in two years time; while, on his part, the king agreed to abstain from any attack on the papal dominions, and to guarantee the safety of the pope and the *patrimonium Petri*. The emperor Napoleon had, in point of fact, recalled his troops in 1866; but in 1867, when Garibaldi crossed the frontiers of the papal state at the head of his volunteers, he declared the treaty violated and again threw his regiments into Rome. Three years later the time came when he could employ his arms more advantageously elsewhere, and after the outbreak of the war with Germany Rome was evacuated. The news that the French Empire had fallen produced an electrical effect in Italy: the Italian parliament called on the king to occupy Rome; on the 8th of September Victor Emmanuel crossed the borders; and on the 20th of September the green-white-and-red of the tricolour floated over the Capitol. The protests of Pius IX. remained unheeded, and his attempts to secure another foreign intervention met with no success. On the 2nd of October Victor Emmanuel instituted a *plébiscite* in Rome and the possessions of the Church to decide the question of annexation. The result of the suffrage was that 153,681 votes were given in favour of union with Italy, and 1507 against the proposed incorporation: that is to say only the direct dependants of the Vatican were opposed to the change. The papal state was now merged in the kingdom of Italy, which proceeded to define its diplomatic relations with the Holy See by the law of the 13th of May 1871 (see ITALY: History).

In his capacity as head of the Church, Pius IX. adhered to the principles of the Ultramontanist party, and contributed materially to the victory of that cause. The political reaction which followed the revolutionary era in most quarters of Europe offered a favourite soil for his efforts; and in several countries he found it possible to regulate the relations between Church and state from the standpoint of the curia. In 1851 he concluded a concordat with Queen Isabella II. of Spain, proclaiming Roman Catholicism the sole religion of the Spanish people, to the exclusion of every other creed (art. 1); and we find the same provision in another concordat with the South American republic of Ecuador (1862). A third concordat, negotiated with the emperor Francis Joseph I. of Austria (1855), entrusted the supervision of schools and the censorship of literature to the clergy, recognized the canon law, and repealed all secular legislation conflicting with it. France came into line with the wishes of the pope in every respect, as Napoleon needed clerical support in his political designs. Even in Germany he found no resistance; on the contrary, he was able to secure advantageous compacts from individual states (Hesse, 1854; Würtemberg, 1857). In fact, the growing tendency to romanize Catholicism—to bring it, that is to say, into close connexion with Rome, and to a state of dependency on the guidance and instructions of the curia—made special progress in Germany.

Among the most important acts of Pius IX. must be counted his proclamation of the dogma of the Immaculate Conception of the Virgin Mary, by the bull *Ineffabilis Deus*, on the 8th of December 1854. In this bull the preservation of Mary from every stain of hereditary sin, in the first moment of her conception, was declared to be a divinely revealed truth, which consequently demanded universal acceptance (see IMMACULATE CONCEPTION). By this means a view, which till then had been no more than a pious belief, was elevated into a dogma to be held *de fide*; though grave doubts on the subject had always been entertained, even in the midst of the Church itself. For the inner life of that

Church this solution of the controversy was of great significance, and created a desire for further dogmatic decisions on the Virgin Mary—her resurrection and ascension. But the procedure of Pius IX. proved of far-reaching importance from another point of view. True, he had taken the opinion of the bishops on the subject, and had received the assent of a large majority; none the less, the verdict was pronounced by himself alone, not by an ecumenical council. Thus, by arrogating the function formerly exercised by the ecumenical council, he virtually laid claim to the infallibility which had always been regarded as inherent only in the doctrinal pronouncements of such a council: in other words, he availed himself of a privilege not accorded to him till the 18th of July 1870.

Though the Marian dogma of 1854 received, with very few exceptions, an enthusiastic welcome in Roman Catholic circles, another measure of the pope, ten years later, excited a painful sensation even among the orthodox members of the Church. As reigning sovereign of the papal states Pius IX. had passed through a "liberal period"; as head of the Church, he had never been liable to attacks of liberalism. Nevertheless, his return from exile left its mark on his spiritual administration. For from this period onwards he deliberately and stubbornly set his face against the influence of modernism on ecclesiastical life; showed his displeasure at and distrust of the scientific theology and philosophy which marked a moderate advance (Günter, Frohschammer and Döllinger); and, entrenched in the stronghold of medieval ideals, combated the transformations of the new order of society, and the changes in the relationship between Church and state, which obtained in most countries of Europe since the French Revolution. After long and careful consultation, the adverse criticisms which he had expressed on various occasions were published on the 8th of December 1864, together with the encyclical *Quanta cura*, under the title *Syllabus complectens precipuos nostrae aetatis errores* (see SYLLABUS). In this Pius claimed for the Church the control of all culture and all science, and of the whole educational system. He rejected the liberty of faith, conscience and worship enjoyed by other creeds; and bade an easy farewell to the idea of tolerance. He claimed the complete independence of the Church from state control; upheld the necessity of a continuance of the temporal power of the Roman See; and finally, in the last clause, declared that "the pontiff neither can be nor ought to be reconciled with progress, liberalism and modern civilization." The publication of this syllabus created a profound impression: for it declared war on modern society, and committed the papacy to the principles of Ultramontanism (*q.v.*). But, as any attempt to translate its precepts into practice would entail a disastrous conflict with the existing régime as established by law, Roman Catholic circles have frequently shown a tendency to belittle the significance of the manifesto and to deny that its rules are absolutely binding. But these well-meant explanations, however comprehensible, are refuted by the unequivocal pronouncements of Pius IX., Leo XIII., and many recognized ecclesiastical authorities—*e.g.* Cardinal Manning, archbishop of Westminster, who described the syllabus as an emanation from the highest doctrinal authority in the Church.

The zenith of Pius's pontificate was attained on the 18th of July 1870 when the Vatican council proclaimed the infallibility of the pope and the universality of his episcopate, thus elevating him to a pinnacle which none of his predecessors had reached and at the same time fulfilling his dearest wish. That, personally, he laid great stress on the acceptance of the dogma, was a fact which he did not attempt to conceal during the long preliminary deliberations of the council; and his attitude was a not inconsiderable factor in determining its final resolutions. But the loss of the papal states, immediately afterwards, was a blow from which he never recovered. Whenever he brought himself to speak of the subject—and it was not rarely—he repeated his protest in the bitterest terms, and, to the end of his days, refused to be reconciled with the "sacrilegious" king of Italy. When, in Germany, the situation created by the Vatican council led to the outbreak of the Kulturkampf, Pius IX. failed to display the tact peculiar

to his successor. For, in the encyclical *Quod nunquam* (Feb. 5, 1875), he took the rash step of declaring invalid the Prussian laws regulating the relationship between Church and state—the only result being that the feud was still further embittered.

In these later years the dark days of his "captivity" were amply compensated by the proofs of reverence displayed by Roman Catholic Christianity, which accorded him magnificent ovations as his period of jubilee began to fall due. The twenty-fifth anniversary of his pontificate was celebrated with great splendour on the 16th of June 1871; for he was the first pope who had thus reached the traditional "years of Peter." In 1872 his 80th birthday gave occasion for new demonstrations; and 1875 was a so-called "year of jubilee." Finally, in 1877, the fifty years of his priesthood were completed: an event which brought him innumerable expressions of loyalty and led to a great manifestation of devotion to the Holy See from all the Roman Catholic world. On the 7th of February 1878 Pius IX. died. His successor was Leo XIII.

BIOGRAPHIES.—Hülkamp, *Papst Pius IX. in seinem Leben und Wirken* (2nd ed., Münster, 1870); Legge, *Pius IX.* (London, 2 vols., 1872); Gillet, *Pie IX., sa vie et les actes de son pontificat* (Paris, 1877); Shea, *Life and Pontificate of Pius IX.* (New York, 1877); Trollope, *Life of Pius IX.* (London, 2 vols., 1877); F. v. Döllinger "Pius IX." in his *Kleine Schriften*, ed. Reusch (Stuttgart, 1890), p. 558 sqq.; Steptischnegg, *Papst Pius IX. und seine Zeit* (2 vols., Vienna, 1879); Wappmangspurger, *Leben und Wirken des Papstes Pius IX.* (Regensburg, 1879); Pougeois, *Histoire de Pie IX., son pontificat et son siècle* (6 vols., Paris, 1877-1886); Fr. Nielsen, *The History of the Papacy in the 19th Century*, translated under the direction of A. F. Mason, vol. ii. (London, 1906). For his work as sovereign of the papal states, see F. v. Döllinger, *Kirche und Kirchen. Papsttum und Kirchenstaat* (Munich, 1861); M. Brosch, *Geschichte des Kirchenstaates*, vol. ii. (Gotha, 1882); A. F. Nurnberger, *Papsttum und Kirchenstaat* (3 vols., Mainz, 1897-1900); C. Mirbt "Die Geschichtsschreibung des vatikanischen Konzils," in the *Historische Zeitschrift*, 101. Bd. (3. Folge, 5 Bd., 1908, p. 529-600.

SOURCES.—*Acta Pii IX.* (4 vols., Rome, 1854 sqq.); *Acta sanctae sedis* (Rome, 1865 sqq.). A selection of the documents for the history of Pius IX. will be found in C. Mirbt, *Quellen zur Geschichte des Papsttums und des römischen Katholicismus* (2nd ed., Tübingen, 1901), §§ 422-442, pp. 361-390. (C. M.)

PIUS X. (GIUSEPPE SARTO), elected pope in 1903, was born on the 2nd of June 1835, of humble parents, at the little town of Riete in the province of Treviso, Italy. He studied theology at the episcopal seminaries of Treviso and Padua, and was ordained priest in 1858. For seventeen years he acted as parish priest at various small places in Venetia, until in 1875 he was appointed canon of the cathedral and superior of the seminary at Treviso. In 1880 he refused the bishopric of Treviso, but in 1884, on the express command of Leo XIII., he accepted that of Mantua. On the 12th of June 1893 he was created a cardinal, and three days later was nominated patriarch of Venice. In Venice he made himself very popular owing to his piety, his simplicity and generosity, and by his readiness to act in harmony with the Italian government. He succeeded Leo XIII. in his election to the papal chair on the 4th of August 1903. (See PAPACY, *ad fin.*)

PIVOT (Fr. *pivot*; probably connected with Ital. *piuolo*, peg, pin, diminutive of *pieno*, *pipe*, pipe), that on which something turns, specifically a metal pointed pin or short shaft in machinery, such as the end of an axle or spindle. The term occurs frequently in combination with other words, chiefly in technical usage, *e.g.* "pivot-gearing," for a system of gearing in machinery which admits of the shifting of the axis of a driving wheel, so that the power may be communicated in various directions.

PIZARRO, FRANCISCO (c. 1471 or 1475-1541), discoverer and conqueror of Peru, was born at Trujillo in Estremadura, Spain, about 1471 (or 1475). He was an illegitimate son of Gonzalo Pizarro, who as colonel of infantry afterwards served in Italy under Gonzalvo de Cordova, and in Navarre, with some distinction. Of Pizarro's early years hardly anything is known; but he appears to have been poorly cared for, and his education was neglected. Shortly after the news of the discovery of the New World had reached Spain he was in Seville, and thence found his way across the Atlantic. There he is heard of in 1510 as having taken part in an expedition from Hispaniola to Uraba

under Alonzo de Ojeda, by whom he was entrusted with the charge of the unfortunate settlement at San Sebastian. He accompanied Balboa (whom he afterwards helped to bring to the block) in the discovery of the Pacific; and under Pedrarias d'Avila he received a *repartimento*, and became a cattle-farmer at Panama. Here in 1522 he entered into a partnership with a priest named Hernando de Luque, and a soldier named Diego de Almagro, for purposes of exploration and conquest towards the south. Pizarro, Almagro and Luque afterwards renewed their compact in a more solemn and explicit manner, agreeing to conquer and divide equally among themselves the opulent empire they hoped to reach. Explorations were then undertaken down the west coast of South America, in which Pizarro, though left for months with but thirteen followers on a small island without ship or stores, persisted till he had coasted as far as about 9° S. and obtained distinct accounts of the Peruvian Empire. The governor of Panama showing little disposition to encourage the adventurers, Pizarro resolved to apply to the sovereign in person for help, and with this object sailed from Panama for Spain in the spring of 1528, reaching Seville in early summer. Charles V. was won over, and on the 26th of July 1529 was executed at Toledo the famous *capitulacion*, by which Pizarro was upon certain conditions made governor and captain-general of the province of New Castile for the distance of 200 leagues along the newly discovered coast, and invested with all the authority and prerogatives of a viceroy, his associates being left in wholly secondary positions. One of the conditions of the grant was that within six months Pizarro should raise a sufficiently equipped force of two hundred and fifty men, of whom one hundred might be drawn from the colonies; as he could not make up his due complement he sailed clandestinely from San Lucar in January 1530. He was afterwards joined by his brother Hernando with the remaining vessels, and when the expedition left Panama in January of the following year it numbered three ships, one hundred and eighty men, and twenty-seven horses. The subsequent movements of Pizarro belong to the history of Peru (q.v.). After the final effort of the Incas to recover Cuzco in 1536-37 had been defeated by Diego de Almagro, a dispute occurred between him and Pizarro respecting the limits of their jurisdiction. This led to battle; Almagro was defeated (1538) and executed; but his supporters conspired, and assassinated Pizarro on the 26th of June 1541.

PIZZICATO (from Ital. *picciare*, to pluck or twitch), a term in music for a direction to the players of stringed instruments, that the passage so marked is to be played by plucking the strings with the fingers instead of using the bow.

PIZZO, a seaport of Calabria, Italy in the province of Catanzaro, 72 m. by rail N.E. of Reggio, situated on a steep cliff overlooking the Gulf of Santa Eufemia, 351 ft. above sea-level. Pop. (1901), 9172. It has an old castle, in which Joachim Murat, ex-king of Naples, was shot on the 13th of October 1815. The people engage in tunny- and coral-fishing. In 1783 the town was almost destroyed by an earthquake, and it suffered some damage from the same cause in 1905.

PLACARD (15th cent. Fr. *placart*, from *plaquier*; mod. *plaque*, to plaster), a bill or poster pasted or affixed to a wall or in any prominent position for the purpose of giving notice to the public of a proclamation, police or other regulations, or of forthcoming events or the like.

PLACE (through Fr. from Lat. *platea*, street; Gr. *πλατος*, wide), a definite position in space, whether of limited or unlimited extent, situation or locality; also position in a series or rank; or an office, or employment, particularly one in the service of a government. Special applications are to an open space in a town, a group of buildings, row of houses, or as the name of a residence or manor-house. In certain cases this latter use

accounts for the occurrence of parts of a town being known as Place, e.g. Ely Place in London, formerly the site of the town residence of the bishops of Ely. A "place of arms" (Fr. *place d'armes*), in fortification, means the wide spaces (suitable for the assembly of troops for a sortie) made by the salients and re-entrants of the covered way. The phrase is also used in a strategic sense to express an entrenched camp or fortress in which a large army can be collected under cover previous to taking the field.

PLACENTA (Lat. for a cake), in anatomy, the organ by which the embryo is nourished within the womb of its mother. When the young one is born the placenta and membranes come away as the "afterbirth." In human anatomy the organ is a circular disk about seven or eight inches in diameter and one and a quarter inches in thickness at its centre, while at its margin it is very thin and is continuous with the foetal membranes. It weighs about a pound.

In order to explain the formation of the placenta it is necessary to encroach to some extent on the domain of physiology. Before each menstrual period, during the child-bearing age of a woman, the mucous membrane of the uterus hypertrophies, and, at the period, is cast off and renewed, but if a fertilized ovum reaches the uterus the casting off is postponed until the birth of the child. From the fact that the thickened mucous membrane lining the interior of the uterus is cast off sooner or later, it is spoken of as the "decidua." The fertilized ovum, on reaching the uterus, sinks into and embeds itself in the already prepared decidua, and, as it enlarges, there is one part of the decidua lying between it and the uterine wall ("decidua serotina" or "basalis"), one part stretched over the surface of the enlarging ovum ("decidua reflexa" or "capularia") and one part lining the rest of the uterus ("decidua vera") (see fig 1.).

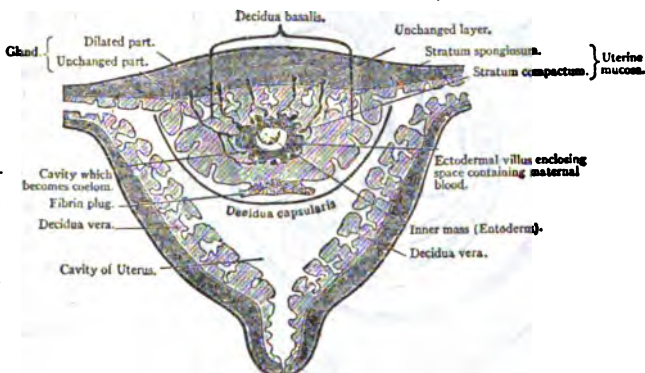

FIG. 1.—Diagram representing a very young human ovum almost immediately after its entrance into the decidua, and whilst the place of its entrance is still covered with a plug of fibrin. The ectoderm has already proliferated and embraced spaces which contain maternal blood and are continuous with the maternal blood-vessels.

It is the decidua basalis which is specially interesting in considering the formation of the placenta. That part which is nearest the ovum is called the "stratum compactum," but farther away the uterine glands dilate and give a spongy appearance to the mucous membrane which earns this particular layer the name of "stratum spongiosum." Processes grow out from the surface of the ovum which penetrate the stratum compactum of the decidua basalis and capsularis and push their way into the enlarged maternal blood sinuses; these are the "chorionic villi." Later, the "allantoic" or "abdominal stalk" grows from the mesoderm of the hind end of the embryo into the chorionic villi which enter the decidua basalis, and in this blood-vessels pass which push their way into the maternal blood sinuses. Eventually the original walls of these sinuses, together with the false amnion, disappear, and nothing now separates the maternal from the foetal blood except the delicate walls of the foetal vessels covered by some nucleated noncellular tissue, known as *syncytium*, derived from the chorionic epithelium, so that the embryo is able to take its supply of oxygen and materials for growth from the blood of its mother and to give up carbonic acid and excretory matters. It is the gradual enlargement of the chorionic villi in the decidua basalis together with the intervillous maternal blood sinuses that forms the placenta; the decidua capsularis and vera eventually become pressed

together as the embryo enlarges, and then, as pressure continues, atrophy. The allantoic stalk elongates enormously, and in its later stages contains two arteries (umbilical) and only one vein (owing to the obliteration of the right one) embedded in some loose connective tissue known as "Wharton's jelly." At first the stalk of the yolk-sac is quite distinct from this, but later the two structures become bound up together (see fig. 2), after which they are known as the "umbilical cord." A distinction must be made between the allantoic stalk and the allantois; the latter is an entodermal outgrowth from the hind end of the mesodacum or primitive alimentary canal, which in the human subject only reaches a little way toward the placenta. The allantoic stalk is the mass of mesoderm containing blood-vessels which is pushed in front of the allantois and, as has been shown, reaches and blends with the decidua basalis to form the placenta.

For further details see Quain's *Anatomy*, vol. i. (London, 1908); and, for literature, O. Hertwig's *Handbuch der Entwicklungslehre* (Jena).

Comparative Anatomy.—If the placenta is to be regarded as a close union between the vascular system of the parent and embryo, the condition may be found casually scattered throughout the phylum of the Chordata. In such a very lowly member of the

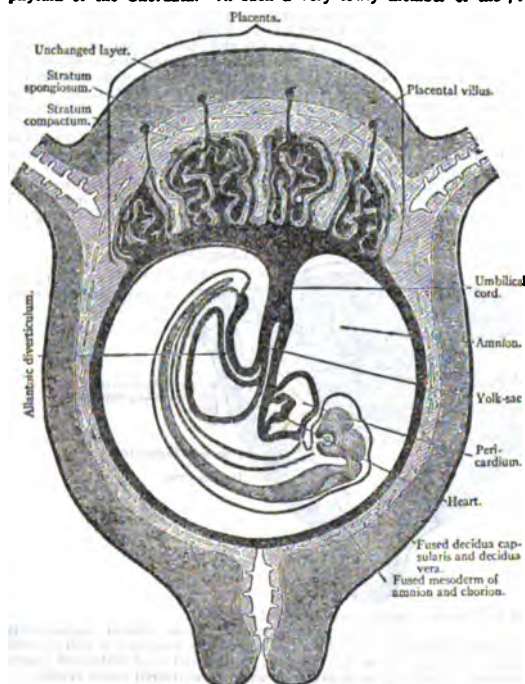

From A. H. Young and A. Robinson, in Cunningham's *Text-Book of Anatomy*.

FIG 2.—Diagram. Later stage in the development of the placenta, showing the relations of the foetal villi to the placental sinuses, the fusion of the amnion with the inner surface of the chorion, and the thinning of the fused deciduae (capsularis and vera).

phylum as Salpa, a placenta is formed, and the embryo is nourished within the body of its parent. In some of the viviparous sharks, e.g. the blue shark (*Carcharias*), the yolk-sac has ridges which fit into grooves in the wall of the oviduct and allow an interchange of materials between the maternal and foetal blood. This is an example of an "umbilical placenta." In the viviparous blennies (*Zoarces viviparus*), among the teleostean fishes, two or three hundred young are nourished in the hollow ovary, which develops villi secreting nutritive material. Among the Amphibia the alpine salamander (*Salamandra atra*) nourishes its young in its oviducts until the gilled stage of development is past, while in the Reptilia the young of a viviparous lizard (*Seps chalcides*) establish a communication between the yolk-sac anteriorly and the allantois posteriorly, on the one hand, and the walls of the oviduct on the other. In this way both an umbilical and an allantoic placenta are formed.

The mammals are divided into Placentalia and Aplacentalia; in the latter group, to which the monotremes and most marsupials

belong, the ova have a great deal of yolk, and the young, born in a very immature condition, finish their development in their mother's pouch; but although these mammals have no allantoic placenta there is an intimate connexion between the walls of the yolk-sac and the uterine mucous membrane, and so an umbilical or omphalic placenta exists. The name Aplacentalia therefore only means that they have no allantoic placenta. Among the Placentalia the umbilical and allantoic placentae sometimes coexist for some time, as in the case of the hedgehog, the bandicoot and the mouse. In most of the lower placental mammals the allantois is much more developed than in man, and the most primitive type of placenta is that in which villi are formed over the whole surface of the chorion projecting into the decidua of the tubular cornu of the uterus. This is known as a "diffuse placenta," and is met with in the pangolin, pig, hippopotamus, camel, chevrotain, horse, rhinoceros, tapir and whale. When the villi are collected into a number of round tufts or cotyledons, as in most ruminants, the type is spoken of as a "cotyledonous placenta," and an intermediate stage between this and the last is found in the giraffe.

In the Carnivora, elephant, procaeva (*Hyrax*) and aardvark (*Orycteropus*), there is a "zonary-placenta" which forms a girdle round the embryo. In sloths and lemurs the placenta is dome-shaped, while in rodents, insectivores and bats, it is a vestral disk or closely applied pair of disks, thus differing from the dorsal disk of the ant-eater, armadillo and higher Primates, which is known as a "metadiscoidal placenta." It will thus be seen that the form of the placenta is not an altogether trustworthy indication of the systemic position of its owner. In the diffuse and cotyledonous placentae the villi do not penetrate very deeply into the decidua, and at birth are simply withdrawn, the decidua being left behind in the uterus, so that these placentae are spoken of as non-deciduate while other kinds are deciduate.

For further details see S. W. W. Turner, *Lectures on the Comparative Anatomy of the Placenta* (Edinburgh, 1876); A. Robinson, "Mammalian Ova and the Formation of the Placenta," *Jour. Anat. and Phys.* (1904) xxxviii., 186, 325. For literature up to 1906, R. Wiedersheim's *Comparative Anatomy of Vertebrates*, translated and adapted by W. N. Parker (London, 1907). (F. G. P.)

PLAGIARISM, an appropriation or copying from the work of another, in literature or art, and the passing off of the same as original or without acknowledgment of the real authorship or source. The Lat. *Plagiarius* meant a kidnapper, stealer or abductor of a slave or child, though it is also used in the modern sense of a literary pilferer or purloiner by Martial (I. 53, 9). The word *plagium* is used in the Digest of the offence of kidnapping or abduction, and the ultimate source is probably to be found in *plaga*, net, snare, trap, cognate with Gr. *πλάξω*, to weave, plait. The idea of plagiarism as a wrong is comparatively modern, and has grown up with the increasing sense of property in works of the intellect. (See COPYRIGHT.)

PLAGIOCLASE, an important group of rock-forming minerals, constituting an isomorphous series between albite or soda-felspar and anorthite, or lime-felspar. Intermediate members are thus soda-lime-felspars, which in their crystallographical, optical and other physical characters vary progressively with the chemical composition between the two extremes albite ($\text{NaAlSi}_3\text{O}_8$) and anorthite ($\text{CaAl}_2\text{Si}_2\text{O}_8$). This variation is continuous in the series, but specific names are applied to members falling between certain arbitrary limits, viz.: Albite, Ab ($=\text{NaAlSi}_3\text{O}_8$); Oligoclase, Ab_2An_1 to Ab_1An_1 ; Andesine, Ab_2An to Ab_1An ; Labradorite, Ab_1An to Ab_1An_2 ; Bytownite, Ab_1An_2 to Ab_1An_3 ; Anorthite, An ($=\text{CaAl}_2\text{Si}_2\text{O}_8$).

All the members of the series crystallize in the anorthic (trigonal) system. They possess a perfect cleavage parallel to the basal pinacoid $P(001)$ and a somewhat less pronounced cleavage parallel to the pinacoid $M(100)$. The angle between these two cleavages varies from $86^\circ 24'$ in albite to $85^\circ 50'$ in anorthite. It was on account of the oblique angle between the cleavages that A. Breithaupt in 1847 gave the name plagioclase (Gr. *πλάγιος*, oblique, and *κλάω*, to cleave) to these felspars, to distinguish them from the orthoclase felspar in which the corresponding cleavage angle is a right angle. It should be noted that the potash- and potash-soda-felspars, microcline ($q.g.$) an orthoclase, though also anorthic, are not included in the plagioclase series of soda-lime-felspars. Crystals are

usually tabular in habit, parallel to the plane *M*, as shown in the accompanying figure; sometimes, however, they are flattened parallel to *P*, this being a characteristic habit of the perikline variety of albite; microlitic crystals forming the ground-mass of volcanic rocks are usually elongated in the direction of the edge between *P* and *M*.

Twinning is an important character, which is almost invariably present and affords a ready means of distinguishing the plagioclases from other feldspars. Most frequent is the twinning according to the "albite law" with *M* as twin-plane. One half of the twin is turned through 180° about the normal to this plane and the two portions are united along the same plane (for figures of twinned crystals see ALBITE). The basal planes of the two portions are inclined to each other at a salient or re-entrant angle of 7° 12' in albite and 8° 20' in anorthite. This twinning is usually polysynthetic, being many times repeated, and giving rise to numerous thin lamellae, which are the cause of the fine striations on the cleavage planes *P* and parallel to the edge *PM*, so characteristic of the plagioclases as seen in hand specimens. Viewed in polarized light, thin sections of twinned crystals show a very characteristic banded structure parallel to *M*. A second twinning is known as the "perikline-law" because of its frequent occurrence in perikline. Here the axis of rotation is the edge *xP* (the crystallographic axis *b*) and the plane of composition is the "rhombic section": the latter is a plane which intersects the prism faces *T* and *l* in a rhomb; it is not a possible face of the crystal, and its position varies in the different species. In addition to being twinned according to these two laws, plagioclase may also be twinned on the Carlsbad-, Baveno- and Manebach-laws, as in orthoclase (*q.v.*).



a specific infectious fever, one variety being characterized by buboes (glandular swellings) and carbuncles. This definition excludes many of the celebrated pestilences recorded in history—such as the plague of Athens, described by Thucydides; that not less celebrated one which occurred in the reign of Marcus Aurelius and spread over nearly the whole of the Roman world (A.D. 164-180),¹ which is referred to, though not fully described, by the contemporary pen of Galen; and that of the 3rd century (about 253), the symptoms of which are known from the allusions of St. Cyprian (*Sermo de mortalitate*). There is a certain resemblance between all these, but they were very different from Oriental plague. "Plague" was formerly divided into two chief varieties: (1) mild plague, *pestis minor*, larval plague (Radcliffe), *peste fruste*, in which the special symptoms are accompanied by little fever or general disturbance; and (2) ordinary epidemic or severe plague, *pestis major*, in which the general disturbance is very severe. Cases which are rapidly fatal from the general disturbance without marked local symptoms have been distinguished as fulminant plague (*pestis siderans*, *peste foudroyante*).

History up to 1880.—The first historical notice of the plague is contained in a fragment of the physician Rufus of Ephesus, who lived in the time of Trajan, preserved in the *Collections of Oribasius*.² Rufus speaks of the buboes called pestilential as being specially fatal, and as being found chiefly in Libya, Egypt and Syria. He refers to the testimony of a physician Dionysius, who lived probably in the 3rd century A.C. or earlier,

Constants of Plagioclase Feldspars.

Composition.	SiO ₂	Al ₂ O ₃	Na ₂ O	CaO	Sp. gr.	Melting-point (Centigrade).	Cleavage Angle <i>PM</i> .	Angle of Rhombic Section.*	Mean Refractive Index β .	Optical Extinction.		
										On <i>P</i> .*	On <i>M</i> .*	In sections $\perp M$.
Ab	68.7	19.5	11.8	0	2.624	—	86° 22'	+ 27°	1.534	+ 4° 30'	+ 19°	- 16°
Ab ₁ An ₁	62.0	24.0	8.7	5.3	2.659	1340°	86° 24'	+ 3°	1.542	+ 1° 3'	+ 4° 36'	+ 7°
Ab ₂ An ₁	55.6	28.3	5.7	10.4	2.694	1419°	86° 14'	- 3°	1.558	- 5° 10'	- 16°	+ 27°
Ab ₁ Ab ₂	49.3	32.6	2.8	15.3	2.728	1477°	86° 4'	- 9°	1.576	- 17° 40'	- 29° 28'	+ 48°
An	43.2	36.7	0	20.1	2.758	1532°	85° 50'	- 16°	1.582	- 37°	- 36°	+ 53°

* Angles measured to the edge *PM*.

The optical characters of the plagioclases have been the subject of much study, since they are of great value in determining the constituents of rocks in thin sections under the microscope. The mean indices of refraction and the angles of extinction on the cleavages *P* and *M* are given in the accompanying table. (The meaning of the + and - directions will be seen from the figure, where the face *P* slopes from left to right, i.e. the angle between the normals to the faces lettered *P* and *M* is less than 90°). The extinction angles on other faces, or in sections of known orientation in the crystal, also give constants of determinative value: for example, in sections perpendicular to the plane *M* the extinctions, which in crystals twinned according to the albite-law are symmetrical with respect to this place, reach the maximum values given in the table. Not only do the directions of extinction (axes of light-elasticity) vary in the different species, but also the optic axial angle, so that while albite is optically positive, anorthite is negative, and a member near andesine has an axial angle of 90°. The figures seen in convergent polarized light through the *P* and *M* cleavages are characteristic of the different species. A detailed summary of the optical characters and their employment in discriminating the several members of the plagioclase series is given by H. Rosenbuch, *Mikroskopische Physiographie der Mineralien und Gesteine* (4th ed. Stuttgart, 1905).

The plagioclases occur as primary constituents of igneous rocks of almost every kind, and are also frequent as secondary minerals in metamorphic rocks. Albite and oligoclase are more characteristic of acidic rocks, whilst the basic members at the anorthite end of the series are characteristic of rocks containing less silica. The composition may, however, vary even in the same crystal, zoned crystals with a basic nucleus and with shells successively more and more acid towards the exterior being common.

For further particulars respecting individual species and their modes of occurrence see ALBITE; ANDESINE; ANORTHITE; BYTOWNITE; LABRADORITE; OLIGOCLASE. (L. J. S.)

PLAGUE (in Gr. *λοιμὸς*; in Lat. *pestis, pestilentia*), in medicine, a term applied to any epidemic disease causing a great mortality, and used in this sense by Galen and the ancient medical writers, but now confined to a special disease, otherwise called Oriental, Levantine, or Bubonic Plague, which may be shortly defined as

and to Dioscorides and Posidonius, who fully described these buboes in a work on the plague which prevailed in Libya in their time. Whatever the precise date of these physicians may have been, this passage shows the antiquity of the plague in northern Africa, which for centuries was considered as its home. The great plague referred to by Livy (*lx. Epitome*) and more fully by Orosius (*Histor. iv. 11*) was probably the same, though the symptoms are not recorded. It is reported to have destroyed a million of persons in Africa, but is not stated to have passed into Europe.

It is not till the 6th century of our era, in the reign of Justinian, that we find bubonic plague in Europe, as a part of the great cycle of pestilence, accompanied by extraordinary natural phenomena, which lasted fifty years, and is described with a singular misunderstanding of medical terms by Gibbon in his forty-third chapter. The descriptions of the contemporary writers Procopius, Evagrius and Gregory of Tours are quite unmistakable.³ The plague of Justinian began at Pelusium in Egypt in A.D. 542; it spread over Egypt, and in the same or the next year passed to Constantinople, where it carried off 10,000 persons in one day, with all the symptoms of bubonic plague. It appeared in Gaul in 546, where it is described by Gregory of Tours with the same symptoms as *lues inguinalis* (from the frequent seat of buboes in the groin). In Italy there was a great mortality in 543, but the most notable epidemic was in 565, which so depopulated the country as to leave it an easy prey to the Lombards. In 571 it is again recorded in Liguria,

¹ Amm. Marcell. xxiii. 7; see Hecker, *De peste Antoniana* (Berlin, 1835).

² Lib. xlv. cap. 17—*Œuvres de Oribase*, ed. Bussemaker and Daremberg (Paris, 1851), iii. 607.

³ Evagrius, *Hist. eccl. iv. 29*; Procopius, *De bello persico*, ii. 22, 23.

and in 590 a great epidemic at Rome is connected with the pontificate of Gregory the Great. But its spread in fact over the whole Roman world, beginning in maritime towns and radiating inland. In another direction it extended from Egypt along the north coast of Africa. Whether the numerous pestilences recorded in the 7th century were the plague cannot now be said; but it is possible the pestilences in England chronicled by Bede in the years 664, 672, 679 and 683 may have been of this disease, especially as in 690 *pestis inguinaris* is again recorded in Rome. For the epidemics of the succeeding centuries we must refer to more detailed works.¹

It is impossible, however, to pass over the great cycle of epidemics in the 14th century known as the Black Death.

Whether in all the pestilences known by this name the disease was really the same may admit of doubt, but it is clear that in some at least it was the bubonic plague.

Contemporary observers agree that the disease was introduced from the East; and one eyewitness, Gabriel de Mussis, an Italian lawyer, traced, or indeed accompanied, the march of the plague from the Crimea (whither it was said to have been introduced from Tartary) to Genoa, where with a handful of survivors of a Genoese expedition he landed probably at the end of the year 1347. He narrates how the few that had themselves escaped the pest transmitted the contagion to all they met.² Other accounts, especially old Russian chronicles, place the origin of the disease still farther east, in Cathay (or China), where, as is confirmed to some extent by Chinese records, pestilence and destructive inundations are said to have destroyed the enormous number of thirteen millions. It appears to have passed by way of Armenia into Asia Minor and thence to Egypt and northern Africa. Nearly the whole of Europe was gradually overrun by the pestilence. It reached Sicily in 1346, Constantinople, Greece and parts of Italy early in 1347, and towards the end of that year Marseilles. In 1348 it attacked Spain, northern Italy and Rome, eastern Germany, many parts of France including Paris, and England; from England it is said to have been conveyed to the Scandinavian countries. In England the western counties were first invaded early in the year, and London in November. In 1349 we hear of it in the midlands; and in subsequent years, at least till 1357, it prevailed in parts of the country, or generally, especially in the towns. In 1352 Oxford lost two-thirds of her academical population. The outbreaks of 1361 and 1368, known as the second and third plagues of the reign of Edward III., were doubtless of the same disease, though by some historians not called the black death. Scotland and Ireland, though later affected, did not escape.

The nature of this pestilence has been a matter of much controversy, and some have doubted its being truly the plague. But when the symptoms are fully described they seem to justify this conclusion, one character only being thought to make a distinction between this and Oriental plague, viz. the special implication of the lungs as shown by spitting of blood and other symptoms. Guy de Chauliac notes this feature in the earlier epidemic at Avignon, not in the later. Moreover, as this complication was a marked feature in certain epidemics of plague in India, the hypothesis has been framed by Hirsch that a special variety of plague, *pestis indica*, still found in India, is that which overran the world in the 14th century. But the same symptoms (haemoptysis) have been seen, though less notably, in many

¹ See Noah Webster's *History of Epidemic Diseases*, 8vo (2 vols., London, 1800) (a work which makes no pretension to medical learning, but exhibits the history of epidemics in connexion with physical disasters—as earthquakes, famines, &c.); Lersch, *Kleine Pest-Chronik* (8vo, 1880) (a convenient short compendium, but not always accurate); Athanasii Kircheri *Chronologia Pestium* (to A.D. 1656), in *Scrutinium pestis* (Rome, 1658; Leipzig, 1671, 4to); Bascome, *History of Epidemic Pestilences* (London, 1851, 8vo). The most complete medical history of epidemics is Häser's *Geschichte der epidemischen Krankheiten* (3rd ed., Jena, 1882), forming the third volume of his *History of Medicine*.

² See the original account reprinted with other documents in Häser, *op. cit.*; also Hecker, *Epidemics of the Middle Ages*, trans. by Babington, Sydenham Soc. (London, 1844); *Volkshrankheiten des Mittelalters*, ed. Hirsch (Berlin, 1865); R. Hoening, *Der schwarze Tod in Deutschland* (Berlin, 1882).

plague epidemics, even in the latest, that in Russia in 1878-1879, and, moreover, according to the latest accounts, are not a special feature of Indian plague. According to a Surgeon-General Francis (*Trans. Epidem. Soc. v. 398*) "haemorrhage is not an ordinary accompaniment" of Indian plague, though when seen it is in the form of haemoptysis. It seems, therefore, impossible to make a special variety of Indian plague, or to refer the black death to any such special form. Gabriel de Mussis describes it even in the East, before its arrival in Europe, as a bubonic disease.

The mortality of the black death was, as is well known, enormous. It is estimated in various parts of Europe at two-thirds or three-fourths of the population in the first pestilence, in England even higher; but some countries were much less severely affected. Hecker calculates that one-fourth of the population of Europe, or 25 millions of persons, died in the whole of the epidemics.

In the 15th century the plague recurred frequently in nearly all parts of Europe. In the first quarter it was very destructive in Italy, in Spain (especially Barcelona and Seville), in Germany and in England, where London was severely visited in 1400 and 1406, and again in 1428. In 1427, 80,000 persons died in Dantzic and the neighbourhood. In 1438-1439 the plague was in Germany, and its occurrence at Basel was described by Aeneas Sylvius, afterwards Pope Pius II. In 1448-1450 Italy (Kircher), Germany (Lersch, from old chronicles), France and Spain, were ravaged by a plague supposed to have arisen in Asia, scarcely less destructive than the black death. England was probably seldom quite free from plague, but the next great outbreak is recorded in 1472 and following years. In 1466, 40,000 persons died of plague in Paris; in 1477-1485 the cities of northern Italy were devastated, and in 1485 Brussels. In the fifteenth year of Henry VII. (1499-1500) a severe plague in London caused the king to retire to Calais.

The 16th century was not more free from plague than the 15th. Simultaneously with a terrible pestilence which is reported to have nearly depopulated China, plague prevailed over Germany, Holland, Italy and Spain, in the first decade of the century, and revived at various times in the first half. In 1529 there was plague in Edinburgh; in London in 1537-1539, and again 1547-1548; and also in the north of England, though probably not absent before. Some of the epidemics of this period in Italy and Germany are known by the accounts of eminent physicians, as Vochs, Fracastor, Mercurialis, Borgarucci, Ingrassia, Massaria, Amici, &c., whose writings are important because the question of contagion first began to be raised, and also plague had to be distinguished from typhus fever, which began in this century to appear in Europe.

The epidemic of 1563-1564 in London and England was very severe, a thousand dying weekly in London; in Paris about this time plague was an everyday occurrence, of which some were less afraid than of a headache (Borgarucci). In 1570, 200,000 persons died in Moscow and the neighbourhood, in 1572, 50,000 at Lyons; in 1568 and 1574 plague was at Edinburgh, and in 1570 at Newcastle. When, however, in 1575 a new wave of plague passed over Europe, its origin was referred to Constantinople, whence it was said to have spread by sea to Malta, Sicily and Italy, and by land through the Austrian territories to Germany. Others contended that the disease originated locally; and, indeed, considering previous history, no importation of plague would seem necessary to explain its presence in Europe. Italy suffered severely (Venice, in 1576, lost 70,000); North Europe not less, though later; London in 1580-1582. In 1585 Breslau witnessed the most destructive plague known in its history. The great plague of 1592 in London seems to have been a part of the same epidemic, which was hardly extinguished by the end of the century, and is noted in London again in 1599. On the whole, this century shows a decrease of plague in Europe.

In the first half of the 17th century plague was still prevalent in Europe, though considerably less so than in the middle ages. In the second half a still greater decline is observable, and by the third quarter the disease had disappeared or was disappearing from a great part of western Europe. The epidemics in England will be most conveniently considered in one series. From this time

³ Vochs, *Opusculum de pestilentia* (1537); Fracastorius, "De Contagione, &c.," *Opera* (Venice, 1535); Hieron. Mercurialis, *De peste, praesertim de Veneta et Palatina* (Basel, 1577); Prosper Borgarucci, *De peste* (Venice, 1565), 8vo; Filippo Ingrassia, *Informazione del pestifero morbo . . . Palermo s . . . regno di Sicilia* (1575-1576, 4to; Palermo, 1576-1577); A. Massaria, *De peste* (Venice, 1597); Diomedes Amicus, *Tres tractatus* (Venice, 1599), 4to; Victor de Bonaventibus, *Decem problemata de peste* (Venice, 1556), 8vo; Georgius Agricola, *De peste libri tres* (Basel, 1554) 8vo. The works of English physicians of this period are of little medical value; but Lodge's *Treatise of the Plague* (London, 1603) deserves mention.

wards we have the guidance of the "Bills of Mortality" issued in London, which, though drawn up on the evidence of ignorant persons, are doubtless roughly true. The accession of James I. in 1603 was marked by a very destructive plague which killed 38,000 in London. In this and subsequent years the disease was widely diffused in England—for instance, Oxford, Derbyshire, Newcastle. It prevailed at the same time in Holland, and had done so some years previously in northern Germany. In the same year (1603) one million persons are said to have died of plague in Egypt. This plague is said to have lasted eight years in London. At all events in 1609 we have the second great plague year, with a mortality of 11,785. After this there is a remission till about 1620, when plague again began to spread in northern Europe, especially Germany and Holland, which was at that time ravaged by war. In 1625 (the year of the siege of Breda in Holland) is the third great London plague with 35,417 deaths—though the year 1624 was remarkably exempt, and 1626 nearly so. In 1630 was the great plague of Milan, described by Ripamonti.¹ In 1632 a severe epidemic, apparently plague, was in Derbyshire. 1636 is the fourth great plague year in London with a mortality of 10,400, and even in the next year 3082 persons died of the same disease. The same year 7000 out of 20,000 inhabitants of Newcastle died of plague; in 1635 it was at Hull. About the same time, 1635-1637, plague was prevalent in Holland, and the epidemic of Nijmegen is celebrated as having been described by Diemerbroeck, whose work (*Tractatus de peste*, 4to, 1641-1665) is one of the most important on the subject. The English epidemic was widely spread and lasted till 1647, in which year, the mortality amounting to 3397, we have the fifth epidemic in London. The army diseases of the Civil Wars were chiefly typhus and malarial fevers, but plague was not unknown among them, as at Wallingford Castle (Willis, "Of Fevers," *Works*, ed. 1681, p. 131) and Dunstar Castle. From this time till 1664 little was heard of plague in England, though it did not cease on the Continent. In Ireland it is said to have been seen for the last time in 1650.²

In 1656 one of the most destructive of all recorded epidemics in Europe raged in Naples; it is said to have carried off 300,000 persons in the space of five months. It passed to Rome, but there was much less fatal, making 14,000 victims only—a result attributed by some to the precautions and sanitary measures introduced by Cardinal Gastaldi, whose work, a splendid folio, written on this occasion (*Tractatus de avertenda et profuganda peste politico-legalis*, Bologna, 1684) is historically one of the most important on the subject of quarantine, &c. Genoa lost 60,000 inhabitants from the same disease, but Tuscany remained untouched. The comparatively limited spread of this frightful epidemic in Italy at this time is a most noteworthy fact. Minorca is said to have been depopulated. Nevertheless the epidemic spread in the next few years over Spain and Germany, and a little later to Holland, where Amsterdam in 1663-1664 was again ravaged with a mortality given as 50,000, also Rotterdam and Haarlem. Hamburg suffered in 1664.

The Great Plague of London.—The preceding enumeration will have prepared the reader to view the great plague of 1664-1665 *Great* in its true relation to others, and not as an isolated *Plague of* phenomenon. The preceding years had been unusually free from plague; and it was not mentioned in the bills of mortality till in the autumn of 1664 (Nov. 2) a few isolated cases were observed in the parishes of St Giles and St Martin's, Westminster, and a few occurred in the following winter, which was very severe. About May 1665 the disease again became noticeable, and spread, but somewhat slowly. Boghurst, a contemporary doctor, notices that it crept down Holborn and took six months to travel from the western suburbs (St Giles) to the eastern (Stepney) through the city. The mortality rapidly rose from 43 in May to 590 in June, 6137 in July, 17,036 in August, 37,159 in September, after which it began to decline. The total number of deaths from plague in that year, according to the bills of mortality, was 68,596, in a population estimated at 460,000,³ out of whom two-thirds are supposed to have fled to escape the contagion. This number is likely to be rather too low than too high, since of the 6432 deaths from spotted fever many were probably really from plague, though not declared so to avoid painful restrictions. In December there was a sudden fall in the mortality which continued through the winter; but in 1666 nearly 2000 deaths from plague are recorded.

According to some authorities, especially Hodges, the plague was imported into London by bales of merchandise from Holland, which came originally from the Levant; according to others it was introduced by Dutch prisoners of war; but Boghurst regarded it as of local origin. It is in favour of the theory that it spread by some means from Holland that plague had been all but extinct in London for some seventeen years, and prevailed in Holland in 1663-1664. But from its past history and local conditions, London might well be deemed capable of producing such an epidemic. In the bills of mortality since 1603 there are only three years when no deaths from plague are recorded. The uncleanness of the city was comparable to that of oriental cities at the present day, and, according to contemporary testimony (Garcinières, *Angliæ flagellum*, London, 1647, p. 85), little improved since Erasmus wrote his well-known description. The spread of the disease only partially supported the doctrine of contagion, as Boghurst says: "The disease spread not altogether by contagion at first, nor began only at one place and spread further and further as an eating sore doth all over the body, but fell upon several places of city and suburbs like rain." In fact dissemination seems to have taken place, as usual, by the conversion of one house after another into a focus of disease, a process favoured by the fatal custom of shutting up infected houses with all their inmates, which was not only almost equivalent to a sentence of death on all therein, but caused a dangerous concentration of the poison. The well-known custom of marking such houses with a red cross and the legend "God have mercy upon us!" was no new thing: it is found in a proclamation in the possession of the present writer dated 1641; and it was probably older still. Hodges testifies to the utility and injurious effects of these regulations. The lord mayor and magistrates not only carried out the appointed administrative measures, but looked to the cleanliness of the city and the relief of the poor, so that there was little or no actual want; and the burial arrangements appear to have been well attended to. The college of physicians, by royal command, put forth such advice and prescriptions as were thought best for the emergency. But it is clear that neither these measures nor medical treatment had any effect in checking the disease. Early in November with colder weather it began to decline; and in December there was so little fear of contagion that those who had left the city "crowded back as thick as they fled." As has often been observed in other plague epidemics, sound people could enter infected houses and even sleep in the beds of those who had died of the plague "before they were even cold or cleansed from the stench of the diseased" (Hodges). The symptoms of the disease being such as have been generally observed need not be here considered. The disease was, as always, most destructive in squalid, dirty neighbourhoods and among the poor, so as to be called the "poor's plague." Those who lived in the town in barges or ships did not take the disease; and the houses on London Bridge were but little affected. Of those doctors who remained in the city some eight or nine died, not a large proportion. Some had the rare courage to investigate the mysterious disease by dissecting the bodies of the dead. Hodges implies that he did so, though he left no full account of his observations. Dr George Thomson, a chemist and a disciple of Van Helmont, followed the example, and nearly lost his life by an attack which immediately followed.⁴

The plague of 1665 was widely spread over England, and was

¹ On the plague of 1665 see Nath. Hodges, *Loimologia sive pestis nuperæ apud populum londinensem narratio* (London, 1672) 8vo—in English by Quincy (London, 1720), (the chief authority); *Λοιμογραφία or an Experimental Relation of the last Plague in the City of London*, by William Boghurst, apothecary in St Giles's-in-the-Fields (London, 1666),—a MS. in British Museum (Sloane 349), containing important details; George Thomson, *ΔΟΙΜΟΤΟΜΙΑ, or the Pest Anatomised*, 8vo (London, 1666); Sydenham, "Febris pestentialis et pestis annorum 1665-1666," *Opera*, ed. Greenhill, p. 96 (London, 1844); *Collection of Scarce Pieces on the Plague in 1665* (London, 1721), 8vo; Defoe's fascinating *Journal of a Citizen*, which should be read and admired as a fiction, but accepted with caution as history; T. Vincent (minister of the gospel), *God's Terrible Voice in the City*, 8vo (London, 1667); *Calendar of State Papers* (1665-1666); "Domestic" series), by M. E. Green.

² Josephus Ripamonti, *De peste anni 1630* (Milan, 1641), 4to.

³ For this period see Index to *Remembrancia in Archives of City of London 1579-1664* (London, 1870); Richardson, *Plague and Pestilence in North of England* (Newcastle, 1852).

⁴ Graunt, *Observations on the Bills of Mortality* (3rd ed., London, 1665).

generally regarded as having been transmitted from London, as it appeared mostly later than in the metropolis, and in many cases the importation by a particular person could be traced. Places near London were earliest affected, as Brentford, Greenwich, Deptford; but in July or August 1665 it was already in Southampton, Sunderland, Newcastle, &c. A wider distribution occurred in the next year. Oxford entirely escaped, though the residence of the court and in constant communication with London. The exemption was attributed to cleanliness and good drainage.

After 1666 there was no epidemic of plague in London or any part of England, though sporadic cases appear in bills of mortality up to 1679; and a column filled up with "o" was left till 1703, when it finally disappeared. The disappearance of plague in London was attributed to the Great Fire, but no such cause existed in other cities. It has also been ascribed to quarantine, but no effective quarantine was established till 1720, so that the cessation of plague in England must be regarded as spontaneous.

But this was no isolated fact. A similar cessation of plague was noted soon after in the greater part of western Europe. In 1666 a severe plague raged in Cologne and on the Rhine, which was prolonged till 1670 in the district. In the Netherlands there was plague in 1667-1669, but there are no definite notices of it after 1672. France saw the last plague epidemic in 1668, till it reappeared in 1720. In the years 1675-1684 a new plague epidemic appeared in North Africa, Turkey, Poland, Hungary, Austria and Germany, progressing generally northward. Malta lost 11,000 persons in 1675. The plague of Vienna in 1679 was very severe, causing 76,000 or probably more deaths. Prague in 1681 lost 83,000 by plague. Dresden was affected in 1680, Magdeburg and Halle in 1682—in the latter town with a mortality of 4397 out of a population of about 10,000. Many North German cities suffered about the same time; but in 1683 the plague disappeared from Germany till the epidemic of 1707. In Spain it ceased about 1681; in Italy certain cities were attacked till the end of the century, but not later (Häser).

Plague in the 18th Century.—At the beginning of this period plague was very prevalent in Constantinople and along the Danube. In 1703 it caused great destruction in the Ukraine. In 1704 it began to spread through Poland, and later to Silesia, Lithuania, Prussia and a great part of Germany and Scandinavia. In Prussia and Lithuania 283,000 persons perished; Dantzic, Hamburg and other northern cities suffered severely. Copenhagen was attacked in 1710. In Stockholm there was a mortality of 40,000. Certain places near Brunswick (10° E.) marked the western limit of the epidemic; and cholera was arrested at the same spot in later years (Häser).

At the same time the plague spread westward from the Danube to Transylvania and Styria, and (1713) appeared in Austria and Bohemia, causing great mortality in Vienna. Thence it passed to Prague and Ratisbona—to the former, possibly to the latter, almost certainly conveyed by human intercourse. This city (12° E.) was the western limit reached in this year. Häser states that the plague disappeared everywhere in Europe after the great hurricane of the 27th of February 1714.

In 1719 plague raged severely in Constantinople; and in 1719 it made a fresh progress westward into Transylvania, Hungary, Galicia and Poland, but not farther (about 20° E.). It thus appears that each successive invasion had a more easterly western limit, and that the gradual narrowing of the range of plague, which began in the 17th century, was still going on.

This process suffered a temporary interruption by the outbreak of plague of southern France in 1720-1722. In 1720 Marseilles became affected with an epidemic plague, the origin of which was attributed by some to contagion through the ship of a Captain Chataud which arrived on the 20th of May 1720, from Syria, where plague at that time prevailed, though not epidemically when he sailed. Six of the crew had died on the voyage to Leghorn, but the disease was declared not to be plague. Cases of plague occurred, however, on the ship, and on the 22nd of June among porters unloading the cargo. Hence, according to believers in contagion, the disease passed to families in the "old town," the poorest and unhealthiest quarter. In the meantime other ships had arrived from Syria, which were put in quarantine. According to others the plague arose in Marseilles from local causes; and recently discovered data show that suspicious cases of contagious disease occurred in the town before the arrival of Chataud's ship.¹ Opinions were divided, and the evidence appears even now nearly balanced, though the believers in contagion and importation gained the victory in public opinion. The pestilence was fearfully severe. Thousands of unburied corpses filled the streets, and in all 40,000 to 60,000 persons were carried off. In December 1721 the plague passed away, though isolated cases occurred in 1722. It passed to, or at least broke out in, Arles and Aix in 1720, causing great mortality, but in Toulon not till 1721, when it destroyed

¹ *Relation historique de la peste de Marseille* (Cologne, 1721, Paris, 1722, &c.); Chicoyneau, Verry, &c., *Observations et réflexions . . . de la peste (Marseille, 1721)*; Chicoyneau, *Traité de la peste*, Paris, 1744; Littre, article "Peste," in *Dictionnaire de médecine*, xxiv. (Paris, 1841).

two-thirds of the population. The epidemic spread generally over Provence, but not to other parts of France, notwithstanding that, as confessed by D'Antrechaux, consul of Toulon, a believer in the exclusive power of contagion, there were abundant opportunities. The disease was in fact, as in other cases, self-limited. In all 87,659 persons are said to have died out of a population of nearly 250,000.²

This great epidemic caused a panic in England which led to the introduction (under Mead's advice) of quarantine regulations, never previously enforced, and also led to the publication of many pamphlets, &c., beside Mead's well-known *Discourse on Pestilential Contagion* (London, 1720).

Plague in Sicily in 1743.—An outbreak of plague at Messina in 1743 is important, not only for its fatality, but as one of the strongest cases in favour of the theory of imported contagion. Messina had been free from plague since 1624, and the Sicilians prided themselves on the rigour of the quarantine laws which were thought to have preserved them. In May 1743 a vessel arrived from Corfu, on board of which had occurred some suspicious deaths. The ship and cargo were burnt, but soon after cases of a suspicious form of disease were observed in the hospital and in the poorest parts of the town; and in the summer a fearful epidemic of plague developed itself which destroyed 40,000 or 50,000 persons, and then became extinct without spreading to other parts of Sicily.

Spread of Plague from the East.—Independent of the episodes of Marseilles and Messina, the spread of plague from the East continued to exhibit the above-mentioned law of limitation. In 1738-1744 the disease was in the Ukraine, Hungary, the borders of Carolia, Moravia and Austria, extending along the Carpathians as far as Poland (20° E.), and also in Bukovina (25° E.). It lasted till 1745, and then disappeared from those parts for fifteen years. In 1755-1757 plague prevailed in parts of European Turkey, whence it on one occasion extended into Transylvania, in the neighbourhood of Cronstadt, where it was checked (25.5° E.).³

In 1770 a destructive plague arose in Moldavia during the Russo-Turkish War, and shortly afterwards in Wallachia, apparently endemic in the former country at least. It affected also Transylvania and part of Hungary, and still more severely Poland, but was confined to Podolia, Volhynia, the Ukraine and east Galicia (5° E.), not even penetrating as far as Warsaw. After destroying, it is said, 300,000 persons, and without being checked by any quarantine regulations, the plague died out finally in March 1771, being remarkable for its short duration and spontaneous limitation (Häser).

In another direction the plague spread over Little Russia in 1770 and desolated Kieff, while in the next year it broke out in Moscow and produced one of the most destructive epidemics of modern times. More than 50,000 persons, nearly one-fourth of the population, were carried off.

The remaining European plague-epidemics of the 18th century were inconsiderable, but on that very account noteworthy. Transylvania was again affected in 1785. Slavonia and Livonia (a district of eastern Galicia) in 1795-1796 (25° E.), Volhynia in 1798. The disease, while reappearing in the seats of the terrible earlier epidemics, was more limited in its range and of shorter duration.⁴ An epidemic in Dalmatia in 1783-1784 is noteworthy in connexion with later outbreaks in the same region. In the last years of the century (1799-1800) there was a new epidemic in Syria and Egypt, where it affected the French and afterwards the English army.

Plague in the 19th Century.—Plague appeared at Constantinople in 1802-1803, about the same time in Armenia (Kars), and in 1801 in Bagdad. It had prevailed since 1798 in Georgia and the Caucasus, and in 1803-1806 began to spread from the north of the Caucasus into Russia, till in 1806 it was established at or near Astrakhan, and in 1807 reached Zareff, 200 m. higher up the Volga. These localities are interesting as being near those where plague appeared in 1877-1878. It is also said to have entered the government of Saratov, but probably no great distance.⁵ The plague remained in the Caucasus and Georgia till 1819 at least. In 1828-1831 it was in Armenia, and again in 1840-1843, since which time it has not been heard of in that country.

² D'Antrechaux, *Relation de la peste de Toulon en 1721* (Paris, 1756); G. Lambert, *Histoire de la peste de Toulon en 1721* (Toulon, 1861), quoted by Häser, *Gesch. der epidem. Krankh.*

³ Adam Chenot, *Abhandlung von der Pest* (Dresden, 1776); *De Peste* (Vienna, 1766).

⁴ Samoilowitz, *Mémoire sur la peste en Russie, 1771* (Paris, 1799); Mertens, *De la peste en 1771* (Paris, 1784).

⁵ Lorinser, *Pest des orientis* (Berlin, 1837) p. 103; Schraud, *Pest in Syrmien*, 1795 (2 vols., Pesth, 1801).

⁶ From the annals of the Moravian community of Sarepta on the Volga, *Geschichte der Brüder-Gemeinde Sarepta*, by A. Glitsch (Sarepta and Berlin, 1865); also Tholoman, *Epidémies de peste au Caucase* (Paris, 1879).

In 1808 plague was at Constantinople, in 1809 at Smyrna. In 1812 was a more general epidemic affecting these places and also Egypt. An outbreak at Odessa is supposed to have been brought from Constantinople, and thence to have passed to Transylvania. In 1813 a severe plague at Bucharest is supposed to have been brought from Constantinople. About the same time plague prevailed in Bosnia, and is supposed to have passed thence to Dalmatia in 1815. In 1814-1815 it again appeared in Egypt, and once more invaded the continent of Europe in Albania and Bosnia. Two insular outbreaks, Malta in 1813 and Corfu in 1815, attracted much attention as being both thought to be cases of importation by sea-traffic,¹ and there seems good reason for this opinion.

A panic spread through Europe in 1815 in consequence of an outbreak in Noja on the eastern coast of Italy. According to one view it was imported from the opposite coast of Dalmatia, though no definite history of contagion was established; according to others, it originated endemically in that place. It remained, however, strictly confined to a small district, perhaps in consequence of the extraordinarily rigorous measures of isolation adopted by the Italian government. In 1828 an isolated epidemic appeared in Greece in the Morea, supposed to have been brought by troops from Egypt.² In 1824-1825 an outbreak took place at Tutchhoff in Bessarabia; the town was strictly isolated by a military cordon and the disease did not spread.³ Cronstadt in Transylvania was the scene of a small outbreak in 1828, which was said to be isolated by similar measures (Lorinser). A far more serious epidemic was connected with the campaign of the Russian army against Turkey in 1828-1829. Moldavia, Wallachia and Bessarabia were widely affected; the disease broke out also in Odessa and the Crimea, and isolated cases occurred in Transylvania. The most northerly points reached by the plague were near Czernowitz on the frontier of Bessarabia and Bukowina, and its limitation was as before attributed to the Russian and Austrian military cordons.

In 1831 another epidemic occurred in Constantinople and Roumelia; in 1837 again in Roumelia and in Odessa—its last appearance in these regions, and the last on the European continent except an isolated outbreak in Dalmatia in 1840, and one in Constantinople in 1841.⁴

The plague-epidemics in Egypt between 1833 and 1845 are very important in the history of plague, since the disease was almost for the first time scientifically studied in its home by skilled European physicians, chiefly French. The disease was found to be less contagious than reported to be by popular tradition, and most of the French school went so far as to deny the contagiousness of the disease altogether. The epidemic of 1834-1835 was not less destructive than many of those notorious in history; but in 1844-1845 the disease disappeared.

In 1853 plague appeared in a district of western Arabia, the Asir country in North Yemen, and it is known to have occurred in the same district in 1815, as it did afterwards in 1874 and 1879. In 1874 the disease extended within four days' march of Mecca. From the scantiness of population the mortality was not great, but it became clear that this is one of the endemic seats of plague.⁵

In June 1858 intelligence was received in Constantinople of an outbreak of disease at the small town Benghazi, in the district of Barca, province of Tripoli, North Africa, which though at first misunderstood was clearly bubonic plague. From later researches there is reason to believe that it began in 1856 or in 1855. The disease did not spread, and ceased in the autumn, to

¹ Faulkner, *On the Plague in Malta* (London, 1820), 8vo; J. D. Tully, *History of the Plague in Malta, Gozo, Corfu and Cephalonia* (London, 1821), 8vo; White, *Treatise on the Plague* (at Corfu) (London 1847); Calvert, "On the Plague in Malta, 1813," *Med.-Chi. Transactions*, vi, 1.

² L. A. Gouze, *Relation de la peste en Grèce, 1827-1828* (Paris, 1838).

³ Lorinser, *Pest des orient*, p. 319.

⁴ For the authorities, see Hæser, *Op. cit.*

⁵ J. N. Radcliffe, *Report of Local Government Board 1879-1880*, suppl., p. 42.

return with less violence in 1859, when it died out. In the autumn of 1873 it returned, but came again to a spontaneous termination.⁶

After the epidemic of Benghazi in 1856-1859, plague was next heard of in the district of Maku, in the extreme north-west of Persia in November 1863. It occurred in a scattered population, and the mortality was not absolutely large.⁷

In 1867 an outbreak of plague was reported in Mesopotamia (Iraq), among the marshes of Hindieh bordering on the lower Euphrates. The epidemic began in December 1866 (or probably earlier) and ceased in June 1867. But numerous cases of non-fatal mild bubonic disease (mild plague or *pestis minor*) occurred both before and after the epidemic, and according to Tholozan similar cases had been observed nearly every year from 1856 to 1865.⁸

The next severe epidemic of plague in Iraq began in December 1873. But facts collected by Tholozan show that *pestis minor*, or sporadic cases of true plague, had appeared in 1868 and subsequent years. The outbreak of 1873-1874 began about 60 m. from the origin of that of 1867. It caused a much greater mortality and extended over a much wider area than that of 1867, including the towns of Kerbela and Hillah. After a short interval it reappeared at Divanieh in December 1874, and spread over a much wider area than in the previous epidemics. This epidemic was carefully studied by Surgeon-Major Colvill.⁹ He estimated the mortality at 4000. The epidemic ceased in July, but broke out again early in 1876, and in this year extended northwards to Bagdad and beyond. The whole area now affected extended 250 m. from north-west to south-east, and the total number of deaths was believed to be 20,000. In 1877 plague also occurred at Shuster in south-west Persia, probably conveyed by pilgrims returning from Iraq, and caused great mortality.

After its customary cessation in the autumn the epidemic began again in October 1876, though sporadic cases occurred all the summer. The disease appeared in 1877 in other parts of Mesopotamia also with less severity than in 1876, but over a wider area, being now announced at Samara, a town 70 m. above Bagdad on the Tigris. The existence of plague in Bagdad or Mesopotamia was not again announced till the year 1884, when accounts again appeared in the newspapers, and in that July the usual official statement was made that the plague had been stamped out.

In 1870-1871 it appeared in a district of Mukri in Persian Kurdistan to the south of Lake Urmiah (far removed from the outbreak of 1863). The epidemic appears, however, to have died out in 1871, and no further accounts of plague there were received. The district had suffered in the great epidemic of plague in Persia in 1829-1835. In the winter 1876-1877 a disease which appears to have been plague appeared in two villages in the extreme north of the province of Khorāsān, about 25 leagues from the south-east angle of the Caspian Sea. In March 1877 plague broke out in Resht, a town of 20,000 inhabitants, in the province of Ghilan, near the Caspian Sea at its south-west angle, from which there is a certain amount of trade with Astrakhan. In 1832 a very destructive plague had carried off half the inhabitants. In 1877 the plague was very fatal. From March to September 4000 persons were calculated to have died. The disease continued till the spring of 1878. In 1877 there was a doubtful report of the same disease at Astrabad, and also in some parts near the Perso-Afghan frontier. In 1878 plague again occurred in Kurdistan in the district of So-uj-Bulak, said by Dr Tholozan to be the same as in the district of Mukri where it occurred in 1870-1871. These scattered outbreaks of plague in Persian territory are the more remarkable because that country

⁶ Tholozan, *La Peste en Turquie dans les temps modernes* (Paris, 1880).

⁷ J. Netten Radcliffe, *Report of the Medical Officer of the Privy Council, &c.* (1878); also in *Papers on Levantine Plague*, presented to parliament (1879), p. 7.

⁸ Tholozan, *La Peste en Turquie*, p. 86.

⁹ See his report cited by Radcliffe, *Papers on Levantine Plague* (1879).

had been generally noted for its freedom from plague (as compared with Asiatic Turkey and the Levant).

A few cases of plague occurred in January 1877 at Baku on the west shore of the Caspian, in Russian territory.¹

An outbreak of plague on European soil in 1878-1879 on the banks of the Volga caused a panic throughout Europe.² In the summer of 1877 a disease prevailed in several villages in the neighbourhood of Astrakhan and in the city itself, which was clearly a mild form of plague (*pestis minor*). It caused no deaths (or only one due to a complication) and died out apparently spontaneously. An official physician, Dr Kastorsky, who investigated the matter for the government, declared the disease to be identical with that prevailing in the same year at Resht in Persia; another physician, Dr Janizky, even gave it the name of *pestis nostras*. In October 1878 some cases appeared in the *stanitza* or Cossack military settlement of Vetlanka, 130 m. from Astrakhan on the right bank of the Volga, which seem to have puzzled the physicians who first observed them, but on the 30th of November were recognized as being but the same mild plague as had been observed the year before near Astrakhan by Dr Döppner, chief medical officer of the Cossacks of Astrakhan. His report on the epidemic is the only original one we have. At the end of November³ the disease became suddenly more severe, and most of those attacked died; and from the 21st of December it became still more malignant, death occurring in some cases in a few hours, and without any buboes being formed. No case of recovery was known in this period. At the end of the year it rapidly declined, and in the first weeks of January still more so. The last death was on the 24th of January. In the second half of December, when the disease had already lasted two months, cases of plague occurred in several neighbouring villages, all of an extremely malignant type, so that in some places all who were attacked died. In most of these cases the disease began with persons who had been at Vetlanka, though this was not universally established. The inhabitants of these villages, terrified at the accounts from Vetlanka, strictly isolated the sick, and thus probably checked the spread of the disease. But it evidently suffered a spontaneous decline. By the end of January there were no cases left in the district except at one village (Selitrennoye), where the last occurred on the 9th of February. The total number of cases in Vetlanka, out of a population of about 1700, was 417, of whom 362 died. In the other villages there were about 62 deaths from plague, and not more than two or three cases of recovery. In consequence of the alarm excited by this appearance of plague upon European soil, most European governments sent special commissions to the spot. The British commissioners were Surgeon-Major Colvill and Dr J. F. Payne, who, like all the foreign commissioners, reached the spot when the epidemic was over. With respect to the origin of this epidemic, the possibility of its having originated on the spot, as in Resht and on the Euphrates in very similar situations, is not to be denied. An attempt was made to show that the contagion was brought home by Cossacks returning from the Turkish War, but on absolutely no evidence. In the opinion of Dr Payne the real beginning of the disease was in the year 1877, in the vicinity of Astrakhan, and the sudden development of the malignant out of a mild form of the disease was no more than had been observed in other places. The Astrakhan disease may have been imported from Resht or Baku, or may have been caused concurrently with the epidemics of these places by some cause affecting the basin of the Caspian generally.

Plague in India.—It used to be held as a maxim that plague never appeared east of the Indus; nevertheless it was observed during the 19th century in more than one distinct centre in India. So long ago as 1815 the disease appeared in Guzerat, Kattywar and Cutch, "after three years of severe famine."

¹ J. Netten Radcliffe, *Reports*; Tholozan, *Histoire de la peste bubonique en Perse* (Paris, 1874).

² See Radcliffe, *Reports* (1879-1880); Hirsch and Sommerbrodt, *Pest-Epidemie 1878-1879 in Astrakhan* (Berlin, 1880); Zuber, *La Peste d'Astrakhan en 1878-1879* (Paris, 1880); Colvill and Payne, *Report to the Lord President of the Council* (1879).

³ The dates are all reduced to new style.

It reappeared early next year, in the same locality, when it extended to Sind as far as Hyderabad, and in another direction south-east as far as Ahmedabad and Dholerab. But it disappeared from these parts in 1820 or early in 1821, and was not heard of again till July 1836, when a disease broke out into violence at the town of Pali in Marwar in Rajputana. It spread from Pali to the province of Meywar, but died out spontaneously in the hot season of 1837. The origin of these two epidemics was obscure. No importation from other countries could be traced.

In 1823 (though not officially known till later) an epidemic broke out at Kedarnath in Gurwhal, a sub-district of Kumaon on the south-west of the Himalayas, on a high situation. In 1834 and 1836 other epidemics occurred, which at last attracted the attention of government. In 1849-1850, and again in 1852, the disease raged very severely and spread southward. In 1853 Dr Francis and Dr Pearson were appointed a commission to inquire into the malady. In 1876-1877 another outbreak occurred. The symptoms of this disease, called *maha murree* or *mahamari* by the natives, were precisely those of oriental plague. The feature of blood-spitting, to which much importance had been attached, appeared to be not a common one. A very remarkable circumstance was the death of animals (rats, and more rarely snakes) at the outbreak of an epidemic. The rats brought up blood, and the body of one examined after death by Dr Francis showed an affection of the lungs.⁴

Oriental plague was observed in the Chinese province of Yunnan from 1871, and also at Pakhoi, a port in the Tongking Gulf, in 1882—being said to have prevailed there at least fifteen years. In both places the symptoms were the same, of undoubted bubonic plague. At Pakhoi it recurs nearly every year.⁵

In 1880 therefore plague existed or had existed within ten years, in the following parts of the world: (1) Benghazi, Africa; (2) Persian Kurdistan; (3) Irak, on the Tigris and Euphrates; (4) the Asir country, western Arabia; (5) on the lower Volga, Russia; (6) northern Persia and the shores of the Caspian; (7) Kumaon and Gurwhal, India; (8) Yunnan and Pakhoi, China.

LITERATURE.—See the following works, besides those already quoted: Kamintus, *Regimen contra epidemiam sive pestem*, 4to. c. 1494 (many editions); Jacobus Soidus, *Opus insignis de peste*, 4to (Bologna, 1478); Alex. Benedictus, *De observatione in pestilentia*, 4to (Venice, 1493); Nicolaus Massa, *De febre pestilentiâ*, 4to (Venice, 1556, &c.); Fioravanti, *Regimento della peste*, 8vo, Venice, 1557; John Woodall, *The Surgeon's Mate*, folio (London, 1629); Van Helmont, *Tumulus pestis*, 8vo (Cologne, 1644, &c.); Muratori, *Trattato del governo della peste*, Modena, 1714; John Howard, *An Account of Lazarettoes in Europe*, &c., 4to (London, 1789); Patrick Russell, *A Treatise of the Plague*, 4to (London, 1791); Thomas Hancock, *Researches into the Laws of Pestilence*, 8vo (London, 1821); Foderé, *Leçons sur les épidémies*, &c., 4 vols. 8vo (Paris, 1822-1824); Ségur Dupeyron, *Recherches historiques, &c. sur la peste* (1837); Bulard, *La Peste orientale*, 8vo (Paris, 1839); Griesinger, *Die Infectiouskrankheiten* (2nd ed., 8vo, Erlangen, 1864). (J. F. F.)

History since 1880.—The most striking feature of the early history of plague summarized above is the gradual retrocession of plague from the west, after a series of exceedingly destructive outbreaks extending over several centuries, and its eventual disappearance from Europe. It appears to have come to a sudden end in one country after another, and to have been seen there no more. Those lying most to the west were the first

⁴ On Indian plague, see Francis, *Trans. Epidem. Soc. Lond.* iv. 407-408; John Murray, *ibid.*, vol. iv. part 2; J. N. Radcliffe, *Reports of Local Government Board* (1875, 1876, 1877 and for 1879-1880); *Parliamentary Papers* (1879); Frederick Forbes, *On Plague in North-West Provinces of India* (Edinburgh, 1840) (Dissertation); Hirsch, *Handbuch der historischen-geog. Pathologie*, i. 209 (1860). (Eng. trans. by Creighton, London, 1883); Hecker's *Volkskrankheiten des Mittelalters* (Berlin, 1865), p. 101; Webb, *Pathologie indica* (2nd ed., Calcutta, 1848).

⁵ See J. N. Radcliffe's *Report for 1879-1880*, p. 45; Manson in *Reports of Imperial Chinese Customs*, special series No. 2, for half-year ended the 31st of March 1878, 15th issue (Shanghai); Lowry, "Notes on Epidemic Disease at Pakhoi" (1882), *ibid.*, 24th issue, p. 31.

to be freed from its presence, namely, England, Portugal and Spain. From all these it finally disappeared about 1680, at the close of a period of pandemic prevalence. Northern and central Europe became free about 1714, and the south of France in 1722. The last outbreak in northern Russia occurred in 1770. After this plague only appeared in the south-east of Europe, where in turn it gradually died away during the first half of the 19th century. In 1841 its long reign on this continent came to an end with an isolated outbreak in Turkey. From that time until quite recently it remained extinct, except in the East. The province of Astrakhan, where a very small and limited outbreak occurred in 1878, is politically in Europe, but geographically it belongs rather to Asia. And even in the East plague was confined to more or less clearly localized epidemics; it showed no power of pandemic diffusion. In short, if we regard the history of this disease as a whole, it appears to have lost such power from the time of the Great Plague of London in 1665, which was part of a pandemic wave, until the present day. There was not merely a gradual withdrawal eastwards lasting nearly two hundred years, but the outbreaks which occurred during that period, violent as some of them were, showed a constantly diminishing power of diffusion and an increasing tendency to localization. The sudden reversal of that long process is therefore a very remarkable occurrence. Emerging from the remote endemic centres to which it had retreated, plague has once more taken its place among the zymotic diseases with which Western communities have to reckon, and that which has for more than a century been little more than a name and a tradition has become the familiar object of investigation, carried on with all the ardour and all the resources of modern science. In what follows an attempt will be made to summarize the facts and indicate the conclusions to be drawn from recent experience.

Diffusion.—At the outset it is characteristic of this subtle disorder that the present pandemic diffusion cannot be traced with certainty to a definite time or place of origin. Herein it differs notably from other exotic diseases liable to similar diffusion. For instance, the last visitation of cholera could be traced clearly and definitely to a point of origin in northern India in the spring of 1892, and could be followed thence step by step in its march westward (see CHOLERA). Similarly, though not with equal precision, the last wave of influenza was shown to have started from central Asia in the spring of 1889, to have travelled through Europe from east to west, to have been carried thence across the sea to America and the Antipodes, until it eventually invaded every inhabited part of the globe (see INFLUENZA). In both cases no doubt remains that the all-important means of dissemination is human intercourse. The movements of plague cannot be followed in the same way. With regard to origin, several endemic centres are now recognized in Asia and Africa, namely, (1) the district of Assyria in Arabia, on the eastern shore of the Red Sea; (2) parts of Mesopotamia and Persia; (3) the district of Garwhal and Kumaon in the North-West Provinces of India; (4) Yunnan in China; (5) East and Central Africa. The last was recently discovered by Dr Koch. It includes the district of Kisiba in German East Africa, and extends into Uganda. In applying the term "endemic centres" to these localities, no very precise meaning can be attached to the word. They are for the most part so remote, and the information about them so scanty, that our knowledge is largely guesswork. What we mean is that there is evidence to show that under various names a disease identical with plague has been more or less continuously prevalent for a number of years, but how long and how continuously is not known. Whether any of them are permanent homes of plague the evidence does not enable us to say. They seem, at any rate, to have harboured it since its disappearance from Europe, and probably further investigation would disclose a still wider prevalence. For instance, there are good reasons for believing that the island of Réunion has been subject, since 1840 or thereabouts, to outbreaks under the name of "*Lymphangite infectieuse*," an elegant euphemism characteristically French. In

all the countries named plague appears to behave very much as it used to do in Europe from the time of the Black Death onwards. That is to say, there are periods of quiescence, with epidemic outbreaks which attract notice at irregular intervals.

Taking up the story at the point where the earlier historical summary leaves off, we get the following list of countries in which plague is known to have been present in each year (see Local Government Board's Reports): 1880, Mesopotamia; 1881, Mesopotamia, Persia and China; 1882, Persia and China; 1883, China; 1884, China and India (as *mahomari*); 1885, Persia; 1886, 1887, 1888, India (as *mahomari*); 1889, Arabia, Persia and China; 1890, Arabia, Persia and China; 1891, Arabia, Persia and India (as *mahomari*); 1892, Mesopotamia, Persia, China, Russia (in central Asia); 1893, Arabia, Persia, Russia and India (as *mahomari*); 1894, Arabia, Persia and India (as *mahomari*); 1895, Arabia and Persia; 1896, Arabia, Asia Minor, China, Japan, Russia and India (Bombay); 1897, Arabia, Persia, China, Japan, India, Persia and East Africa; 1898, Arabia, Persia, China, Japan, Russia, East Africa, Madagascar and Vienna; 1899, Arabia, Persia, China, Japan, Mesopotamia, East Africa, West Africa, Philippine Islands, Straits Settlements, Madagascar, Mauritius, Réunion, Egypt, European Russia, Portugal, Sandwich Islands, New Caledonia, Paraguay, Argentine, Brazil; 1900, to the foregoing should be added Turkey, Australia, California, Mexico and Glasgow; in 1901, South Africa and in 1902 Russia chiefly at Odessa.

This list is probably by no means exhaustive, but it sufficiently indicates in a summary fashion the extent of that wave of diffusion which set in during the closing years of the 19th century. It did not fully gather way till 1896, when plague appeared in Bombay, but our modern knowledge of the disease dates from 1894, when it attacked Hong Kong and first presented itself to accurate observation. From this point a more detailed account may be given. Plague was recognized at Hong Kong in May 1894, and there can be little doubt that it was imported from Canton, where a violent outbreak—said to have caused 100,000 deaths—was in progress a few months earlier, being part of an extensive wave of infection which is believed to have come originally out of the province of Yunnan, one of the recognized endemic centres, and to have invaded a large number of places in that part of China, including Pakhoi and other seaports. Hong Kong was severely affected, and has never since been entirely free from plague. In two intermediate years—1895 and 1897—very few cases were recorded, but more recently the epidemic has gathered force again. The following table gives the cases and deaths in each of the six years 1894-1899:—

Year.	Cases.	Deaths.	Case Mortality.
1894	2833	2550	90
1895	45	36	80
1896	1204	1078	89
1897	21	18	85
1898	1320	1175	89
1899	1486	1415	95
Total	6909	6272	90.7

The excessively high rate of mortality is probably due in part to under-statement of the number of cases. Concealment is practised by the Chinese, who are chiefly attacked, and it is easier to conceal sickness than death. Plague appears to have been equally persistent and destructive on the mainland in southern China during the period indicated, but no accurate details are available. In 1897 the Portuguese settlements of Lappa and Macao were invaded. In addition to the provinces of Yunnan, Kwang-si and Kwang-tung in southern China, plague is reported to have been present for several years in a district in Mongolia to the north of Peking, and distant about "twelve days' ride." More recently several localities in Mongolia and Manchuria have been affected. Formosa was attacked in 1896, and suffered considerably in subsequent years; in 1899 the Japanese government officially reported 2633 cases, with

PLAGUE

... the human stock has had a certain amount of imported ... Speaking generally, the disease ... in the Far East since 1894, but precise ... in India, except with regard to Hong Kong. ... in his *Report on the Causes of the Plague in ...* reports the endemicity of the plague in that ... by (a) infection among rats often ... with infectious material in rat runs or in houses, the ... of which has not been destroyed, (b) retention of infection ... which are rat-ridden, and (c) infected clothing of people ... who have been ill or died of plague. He considers the outbreaks ... are favoured by the seasonal heat and moisture of the spring ... and early summer, and the movement from place to place of ... infected rats or persons. He also believes that human beings ... may infect rats. In 310 cases of plague examined by Simpson ... 56% were bubonic, 40% septic and 4% pneumonic.

In 1896 plague appeared in the city of Bombay. It was certainly present in August, but was not recognized until the 23rd of September, and the diagnosis was not bacteriologically confirmed until the 13th of October. This fact should be remembered when failure to recognize the disease on its first appearance occurs elsewhere. The origin of the Bombay invasion is shrouded in obscurity. It is not even known when or in what part of the city it began (Condon, *The Bombay Plague*). Several theories have been put forward, and importation by sea from China is the theory which has met with most acceptance. The native form of plague, known as *mahamari*, is confined to the southern slopes of the Himalaya. It is described above, but that account may be supplemented by some earlier references unearthed by the *Bombay Gazetteer* (vol. iv.). Ibn Batesta notices two destructive pestilences in the 14th century, and Ferishta one in 1443, which he calls *ta'un*, and describes as very unusual in India. At the end of the 16th century there was a pestilence following a prolonged famine, and in the 17th century two violent epidemics are recorded under the names *ta'un* and *waba*. In the second of these, which occurred in the Ahmedabad district of the Bombay Presidency in 1683-89, buboes are distinctly described. In the 18th century several pestilences are recorded without description. It is at least probable from these notes that even before the undoubted outbreak, which began in Cutch in 1812, India was no stranger to epidemic plague. To return to Bombay and 1896: the infection spread gradually and slowly at first, but during the first three months of 1897 not only was the town of Bombay severely affected, but district after district in the presidency was attacked, notably Poona, Karachi, Cutch Mandvi, Bhiwandi and Daman. The number of cases and deaths reported in the presidency, exclusive of the city, in each year down to the end of 1899, was as follows:—

Year.	Cases.	Deaths.	Case Mortality %
1896	367	273	74.3
1897	49,125	36,797	74.7
1898	99,506	68,061	75.2
1899	131,794	101,485	77.0
Total	271,792	206,616	75.8

The corresponding figures for Bombay city are:—

Year.	Cases.	Deaths.	Case Mortality %
1896	2,530	1,801	71.1
1897	11,963	10,232	85.7
1898	19,863	18,160	91.2
1899	19,484	15,830	81.3
Total	53,840	46,023	85.4

The total for the presidency, including the city, in four years was 325,632 cases with 252,549 deaths in a population of 26,060,421 (census of 1891). The population of the city is 821,764, but during the earlier plague period large numbers fled, so that the foregoing figures do not give the true plague

Incidence according to population. Moreover, concealment was extensively practised. The most striking fact brought out by the tables just given is the large and steady increase year by year in the presidency, in spite of all efforts to arrest the spread of infection. It has gone on since 1896, and it has not been confined to Bombay, but has extended over the whole of India. In 1897 it had already penetrated to Rajputana, the Punjab, the North West Provinces and the Central Provinces. In the following year Bengal, Madras, Haidarabad and Mysore were invaded. Not all these provinces suffered alike, but on the whole plague steadily strengthened its hold on India generally, and hardly relaxed it in any part. The most noteworthy details available are as follows, taken from the plague mortality returns published June 1908. In the Punjab from 179 deaths in 1897 the mortality reached a maximum of 334,897 in 1905, in Agra and Oudh they rose from 72 in 1897 to 383,802 in 1905, and in Madras Presidency from 1658 in 1899 to 20,125 in 1904.

The most striking figures, however, are those for Bombay and Bengal which are given below, as well as the total mortality in India.

Year.	Bengal Presidency (including Calcutta).	Bombay Presidency (including Bombay City).	All India.
1896	—	2,219	2,219
1897	—	47,710	47,974
1898	219	86,191	86,265
1899	3,264	96,592	102,369
1900	38,412	53,196	73,576
1901	78,629	128,259	236,433
1902	32,967	184,752	452,455
1903	65,680	281,269	684,445
1904	75,438	223,937	938,010
1905	126,084	71,363	940,821
1906	59,619	51,525	300,355

Outside China and India plague has caused no great mortality in any of the countries in which it has appeared, with the exception perhaps of Arabia, about which very little is known. But some of the outbreaks are interesting for other reasons, and require notice. The first case is the singular occurrence of three deaths at Vienna in October 1898. The earliest victim was an attendant named Barisch, employed in the pathological laboratory of the Vienna General Hospital, and told off to look after the animals and bacteriological apparatus devoted to the investigation of plague, cultures of which had been brought from India by the medical commissioners sent by the Royal Academy of Science in 1897. Barisch was drunk and out all night on the 8th of October; on the 14th of October he fell ill. Plague was suspected, but Dr Müller, who attended the man and had studied the disease in India, would not admit the diagnosis on clinical grounds, nor was it bacteriologically established until the 10th of October. Barisch died on the 18th of October. On the 20th one of the nurses, and on the 21st Dr Müller, fell ill. Both died of pneumonic plague, from which also Barisch had undoubtedly suffered. A second nurse and a sister of mercy had feverish attacks, but no further case occurred. Barisch was shown to have been careless in the performance of his duties, and to have disregarded instructions; and the inference is that he conveyed the infection to his mouth, and so to the lungs, from the bacteriological specimens or inoculated animals. The melancholy incident illustrates several points of interest: (1) the correctness of the bacterial theory of causation, and the identity of the *bacillus pestis* as the cause; (2) the infectious character of the pneumonic type of disease; (3) its high fatality; (4) the difficulty of diagnosis.

The next occurrence of special interest is the appearance of plague in Portugal in 1899, after an absence of more than 200 years. Its origin is shrouded in obscurity. Oporto, the seat of the outbreak, had no connexion by sea with any place known to be infected, and all attempts to trace introduction ended in speculation or assumption. The most probable theory was that soldiers returning home from infected Portuguese possessions in the East brought it with them, but this does not explain the selection of Oporto and the escape of other places. The earliest

cases, according to retrospective inquiry, occurred in June 1899; suspicions were aroused in July, but the diagnosis was not established until August. The conclusion reached, after careful investigation by Dr Jorge, the medical officer of health, that the commencement really dated from June, is confirmed by the fact that about that time the riverside labourers, who were first affected, began to notice an illness among themselves sufficiently novel to attract their attention and that of an English ship-owner, who from their description suspected plague. Through him the suspicion was conveyed to the *Medical Times and Gazette*, in which the suggestion of plague at Oporto was made before any public mention of it in the town itself. The outbreak never assumed large proportions. It gained ground by degrees until October, after which it declined, and eventually ceased in February 1900. No recrudescence has been officially announced. The number of cases recorded in a population of 150,000 was 310, with 114 deaths, representing a case mortality of 36.7%. They were widely scattered about the town and outlying suburbs; but no further extension occurred, except some isolated cases at Braga, a town 35 m. distant, and one at Lisbon, in the person of the distinguished bacteriologist, Professor Camara Pestana, who contracted the disease in making a *post-mortem* at Oporto, and died in Lisbon.

The only other appearance of plague in Europe in 1899 was on the Volga. Three places were affected, namely, Kolobovka, and Krasnoyarsk, in the province of Astrakhan, and Samara, higher up the river. All three outbreaks were small and limited, and no further extension took place. A commission appointed by the Russian government pronounced the disease to be undoubtedly plague, and it appears to have been very fatal. The origin was not ascertained.

The most interesting extensions of plague in 1900 were those in Australia and Glasgow. The following towns were affected in Australia: Sydney, in New South Wales; Adelaide, in South Australia; Melbourne, in Victoria; Brisbane, Rockhampton, Townsville, Cairns and Ipwich, in Queensland; Fremantle, Perth and Coolgardie, in West Australia. In none of these, with the exception of Sydney, did plague obtain a serious hold. The total number of cases reported in Queensland was only 123, with 53 deaths. In Sydney there was 303 cases, with 103 deaths, a case mortality of 34%. The infection is supposed to have been brought from Noumea, in New Caledonia, where it was present at the end of 1899; and the medical authorities believe that the first case, which occurred on the 19th of January, was recognized. The outbreak, which hardly reached epidemic proportions, lasted about six months. That in Glasgow was on a still smaller scale. It began, so far as could be ascertained, in August 1900, and during the two months it lasted there were 34 cases and 15 deaths. Once more the disease was not at first recognized, and its origin could not be traced. In 1901 plague invaded South Africa, and obtained a distinct footing both at Cape Town and Port Elizabeth. The total number of cases down to July was 760, with 362 deaths; the number of Europeans attacked was 196, with 68 deaths, the rest being natives, Malays, Indians, Chinese and negroes. With regard to Great Britain, a few ship-borne cases have been dealt with at different ports from time to time since 1896, but except at Glasgow the disease has nowhere obtained a footing on land.

Caustion.—Plague is a specific infectious fever, caused by the *bacillus pestis*, which was identified in 1894 by Kitasato, and subsequently, but independently, by Yersin (see PARASITIC DISEASES). It is found in the buboes in ordinary cases, in the blood in the so-called "septicæmic" cases, and in the sputum of pneumonic cases. It may also be present in the urine. *Post-mortem* it is found in great abundance in the spleen and liver. Nothing is known of its natural history outside the body, but on cultivation it is apt to undergo numerous involution forms. Its presence in a patient is regarded as positive diagnostic proof of plague; but failure to find or to identify it does not possess an equal negative value, and should not be too readily accepted, for many instances are recorded in which expert observers have only succeeded in demonstrating its presence after repeated

attempts. It is clear, from the extreme variations in the severity of the illness, that the resisting power of individuals varies greatly. According to the Plague Research Committee of Bombay, the predisposing causes are "those leading to a lower state of vitality," of which insufficient food is probably the most important. There is no evidence that age, sex or race exercises a distinct predisposing influence. The largest incidence in Bombay was on young adults; but then they are more numerous and more exposed to infection, because they go about more than the younger and the older. Similarly, the comparative immunity of Europeans in the East may be explained by their different conditions of life. It is doubtful whether the distinction drawn between *pestis minor* and *pestis major* has a real aetiological basis. Very mild cases occurring in the course of an outbreak of typical plague may be explained by greater power of resistance in individuals, but the epidemic prevalence of a mild illness preceding the appearance of undoubted plague suggests some difference or modification of the exciting cause. "It is impossible," writes Sir Richard Thorne (Local Government Board Report, 1898-1899), "to read the medical history of this disease in almost every part of the world without being impressed with the frequency with which recognized plague has been preceded by ailments of such slight severity, involving some bubonic enlargement of glands and some rise in body-temperature, as to mask the real nature of the malady." Considering the great importance of arresting the spread of infection at the outset, and the implicit reliance placed upon bacteriological criteria, the aetiology of such antecedent ailments deserves more attention than has hitherto been paid to it. Of course plague does not stand alone in this respect. Epidemic outbreaks of other diseases—for instance, cholera, diphtheria and typhoid fever—are often preceded and followed by the prevalence of mild illness of an allied type; and the true significance of this fact is one of the most important problems in epidemiology. In plague, however, it is of special importance, on account of the peculiarly insidious manner in which this disease fastens itself upon a locality.

The path by which the bacillus enters the body varies. In pneumonic cases it is presumed to enter by the air-passages, and in bubonic cases by the skin. The Bombay Plague Research Committee, whose experience is unequalled, say: "In a number of instances points of inoculation were found on the extremities of patients, from which plague cultures were obtained, and in these cases buboes were found above the point of inoculation. In the majority of instances, however, no local indication could be found marking the point at which the microbe was implanted." From the fact that bacilli are hardly ever found in the blood of bubonic cases it may be inferred that they are arrested by the lymphatic glands next above the seat of inoculation, and that the fight—which is the illness—takes place largely in the bubo; in non-bubonic cases they are not so arrested, and the fight takes place in the general circulatory system, or in the lungs. As might be expected from these considerations, the bubonic type is very little infectious, while pneumonic cases are highly so, the patients no doubt charging the surrounding atmosphere by coughing. Whether infection can be introduced through the digestive tract by infected food is doubtful. The bacillus is non-resistant and easily killed by heat and germicide substances, particularly acids. Little is known of its toxic action; only a weak toxin has been obtained from cultures. Of the lower animals, mice, rats, guinea-pigs, rabbits, squirrels and monkeys are susceptible to the bacillus; horses, cattle, sheep, goats, pigs, dogs and cats are more or less resistant, but cats and dogs have been known to die of plague (Oporto, Daman, Cutch and Poona). In the Great Plague of London they were believed to carry the infection, and were killed in vast numbers. The bacillus has been demonstrated in the bodies of fleas, flies, bugs and ants.

Clinical Characters.—One of the results of recent observation is the classification of plague cases under three heads, which have already been mentioned several times: (1) bubonic, (2) pneumonic, (3) septicæmic. (The word "pesti-cæmic" is

also used instead of "septi-caemic," and though etymologically objectionable, it is otherwise better, as "septicaemic" already has a specific and quite different meaning.) It should be understood that this classification is a clinical one, and that the second and third varieties are just as much plague as the first. It is necessary to say this, because a misleading use of the word "bubonic" has given rise to the erroneous idea that true plague is necessarily bubonic, and that non-bubonic types are a different disease altogether. The word "plague"—or "pest," which is the name used in other languages—had originally a general meaning, and may have required qualifications when applied to this particular fever; but it has now become a specific label, and the prefix "bubonic" should be dropped.

The illness varies within the widest limits, and exhibits all gradations of severity, from a mere indisposition, which may pass almost unnoticed, to an extreme violence, only equalled by the most violent forms of cholera. The mild cases are always bubonic; the other varieties are invariably severe, and almost always fatal. Incubation is generally from four to six days, but it has been observed as short as thirty-six hours and as long as ten days (Bombay Research Committee). Incubation, however, is so difficult a thing to determine that it is unwise to lay down any positive limit. As a rule the onset is sudden and well marked. The symptoms may be described under the headings given above. (1) Bubonic cases usually constitute three-fourths of the whole, and the symptoms may therefore be called typical. In a well-marked case there is usually an initial rigor—in children convulsions—followed by a rise of temperature, with vomiting, headache, giddiness, intolerance to light; pain in epigastrium, back and limbs; sleeplessness, apathy or delirium. The headache is described as splitting; delirium is of the busy type, like delirium tremens. The temperature varies greatly; it is not usually high on the first day—from 101° to 103° —and may even be normal, but sometimes it rises rapidly to 104° or 105° or even 107° F.; a fall of two or three degrees on the second or third day has frequently been observed. The eyes are red and injected; the tongue is somewhat swollen, and at first covered with a thin white fur, except at the tip and edges, but later it is dry, and the fur yellow or brownish. Prostration is marked. Constipation is the rule at first, but diarrhoea may be present, and is a bad sign. A characteristic symptom in severe cases is that the patient appears dazed and stupid, is thick in speech, and staggers. The condition has often been mistaken for intoxication. There is nothing, however, in all these symptoms positively distinctive of plague, unless it is already prevalent. The really pathognomonic sign is the appearance of buboes or inflamed glands, which happens early in the illness, usually on the second day; sometimes they are present from the outset, sometimes they cannot be detected before the third day, or even later. The commonest seat is the groin, and next to that the axilla; the cervical, submaxillary and femoral glands are less frequently affected. Sometimes the buboes are multiple and on both sides, but more commonly they are unilateral. The pain is described as lancinating. If left, they usually suppurate and open outwards by sloughing of the skin, but they may subside spontaneously, or remain hard and indurated. Petchiae occur over buboes or on the abdomen, but they are not very common, except in fatal cases, when they appear shortly before death. Boils and carbuncles are rare. (2) Pneumonic plague was observed and described in many of the old epidemics, and particularly by two medical men, Dr Gilder and Dr Whyte, in the outbreak in Kathiawar in 1816; but its precise significance was first recognized by Childe in Bombay. He demonstrated the presence of the bacilli in the sputa, and showed that the inflammation in the lungs was set up by primary plague infection. The pneumonia is usually lobular, the onset marked by rigors, with difficult and hurried breathing, cough and expectoration. The prostration is great and the course of the illness rapid. The breathing becomes very hurried—forty to sixty respirations in the minute—and the face dusky. The expectoration soon becomes watery and profuse, with little whitish specks, which contain great quantities of

bacilli. The temperature is high and irregular. The physical signs are those of broncho-pneumonia; oedema of the lungs soon supervenes, and death occurs in three or four days. (3) In septicaemic cases the symptoms are those of the bubonic type, but more severe and without buboes. Prostration and cerebral symptoms are particularly marked; the temperature rises rapidly and very high. The patient may die comatose within twenty-four hours, but more commonly death occurs on the second or third day. Recovery is very rare.

There is no reason for doubting that the disease described above is identical with the European plagues of the 14th and subsequent centuries. It does not differ from them in its clinical features more than epidemics of other diseases are apt to vary at different times, or more than can be accounted for by difference of handling. The swellings and discolorations of the skin which play so large a part in old descriptions would probably be equally striking now but for the surgical treatment of buboes. Similarly, the comparatively small destructiveness of modern plague, even in India, may be explained by the improved sanitary conditions and energetic measures dictated by modern knowledge: The case mortality still remains exceedingly high. The lowest recorded is 34% in Sydney, and the highest 95% at Hong Kong in 1899. During the first few weeks in Bombay it was calculated by Dr Viegas to be as high as 99%. It is very much higher among Orientals than among Europeans. In the Bombay hospitals it was about 70% among the former, and between 30 and 40% among the latter, which was much the same as in Oporto, Sydney and Cape Town. It appears, therefore, that plague is less fatal to Europeans than cholera. The average duration of fatal cases is five or six days; in the House of Correction at Byculla, where the exact period could be well observed, it was five and a half days. Patients who survive the tenth or twelfth day have a good chance of recovery. Convalescence is usually prolonged. Second attacks are rare, but have been known to occur.

Diagnosis.—When plague is prevalent in a locality, the diagnosis is easy in fairly well-marked cases of the bubonic type, but less so in the other varieties. When it is not prevalent the diagnosis is never easy, and in pneumonic and septicaemic cases it is impossible without bacteriological assistance. The earliest cases have hardly ever been even suspected at the time in any outbreak in a fresh locality. It may be taken at first for almost any fever, particularly typhoid, or for venereal disease or lymphangitis. In plague countries the diseases with which it is most liable to be confounded are malaria, relapsing fever and typhus, or broncho-pneumonia in pneumonic cases.

Treatment.—The treatment of plague is still symptomatic. The points requiring most attention are the cerebral symptoms—headache, sleeplessness, delirium, &c.—and the state of the heart. Alcohol and cardiac stimulants may be required to prevent heart failure. Speaking generally, it is important to preserve strength and guard against collapse. Extracts of supra-renal gland have been found useful. Buboes should be treated on ordinary surgical principles. An antitoxic serum has been prepared from horses by the Institut Pasteur in France, but has not met with success. The results in India obtained by British and various foreign observers were uniformly unfavourable, and the verdict of the Research Committee (1909) was that the serum had "failed to influence favourably the mortality among those attacked." Success was somewhat noisily claimed for an improved method tried in Oporto, but the evidence is of little or no value. Of 142 cases treated, 21 died; while of 72 cases not treated, 46 died; but the former were all hospital patients, and included several convalescents and many cases of extreme mildness, whereas the non-serum cases were treated at home or not at all, some being only discovered when death had made further concealment impossible. Later observations have, however, established that the Yersin-Roux serum is of undoubted benefit when used early in the case, in fact during the first twenty-four hours. Very large doses, so much as 150 cc. may be injected subcutaneously or preferably intravenously, and it is stated to modify the whole course of

the disease. Another serum has been prepared by Lustig and Galozetti.

Morbid Anatomy.—(1) Bubonic cases. A bubo is found to consist of a chain of enlarged glands, surrounded by a mass of engorged connective tissue, coagulated blood and serum. Nearly all the lymphatic glands in the body are a little swollen, but the lymphatic vessels show little or no change. The spleen and liver are always enlarged, the former to sometimes twice or thrice its natural size. The lungs are engorged and oedematous, and often show hæmorrhages. The kidneys are enlarged and congested. The serous membranes show petechiæ and hæmorrhages. The right side of the heart is frequently dilated, with clots in the cavities. The heart muscle is normal, or soft and friable. The substance of the brain, spinal cord and nerve-trunks is normal, but the membranes are engorged. (2) Pneumonic cases. The lymphatic glands are hardly affected. There is general engorgement and oedema of the lungs, with pneumonic patches varying in size and irregularly distributed. (3) Septicæmic cases. Nearly all the lymphatic glands in the body are involved, and have a characteristic appearance. They are enlarged to the size of an almond, rounded, firm and pink; there is some engorgement and oedema on section; the substance is rather soft, and can be scraped off with a knife. The surrounding tissue is not engorged or oedematous. The description of the other organs given under (1) applies also to (2) and (3).

Dissemination.—Given the bacillus, the questions arise, How is it disseminated? and What are the conditions that favour its propagation? That it is conveyed from person to person is an undoubted fact, proved by innumerable cases, and tacitly implied by the word "infectious," which is universally allowed. The sick are a source of danger and one means of dissemination, and, since the illness may be so slight as to pass unrecognized, an obviously insidious one. The ambulatory plague patient goes far to explain the spread of the disease without leaving any track. But there is evidence that persons may carry the infection and give it to others without being ill at all themselves. One such case occurred at Glasgow, and another at Oporto. In the Glasgow case the wife of a laundryman employed in handling plague linen contracted the disease. She was brought into connexion with it in no other way, and there can be no doubt that she took it from her husband, though he was not ill at all himself. The Oporto instance is still more conclusive. Two little girls had plague at Argoncilbe, a suburb some miles from Oporto, and were the only cases which occurred in that place. Their father was a riverside labourer, who lodged during the week in Oporto, but went home for Sunday. He was not ill, but several cases of plague occurred in the house in which he lodged. How the poison passes from one person to another is less clear. In pneumonic cases patients no doubt spread it around them by coughing, and others may take it up through the air-passages or the skin; but even then the range of infection is small, and such cases are comparatively rare. In the vast majority of cases the bacilli are in the lymphatic or the circulatory system, and aerial convection, even for a short distance, seems highly improbable. This view is borne out by the experience in hospitals and with "contacts," which goes to show that with reasonable care and under fair conditions the risk of infection from ordinary plague patients is very small. When persons live crowded together in close contact, and when they are careless with regard to discharges of all kinds from patients, the risk is obviously much increased. Discharges—vomited matters, sputa, urine and faeces—are possible media by which plague is spread from person to person. They also contaminate clothing, which thus becomes another means of dissemination capable of acting at a distance. This is the most probable explanation of the two cases of indirect infection related above. Failure to catch or induce plague from clothing that has been worn by plague patients proves nothing. Such clothing is not necessarily infectious; indeed, the probability is that it is not, unless contaminated by discharges. There is no evidence that merchandise and food-stuffs are means of dissemination, but a great deal of evidence

against such a theory. Then we come to the lower animals. Attention has been concentrated on rats, and some observers seem disposed to lay upon them the whole blame for the propagation and spread of plague, which is held to be essentially a rat-borne disease. The susceptibility of rats has been noted from remote times and in many countries, particularly in China, but it has never attracted so much attention as during the recent prevalence of plague. From one place after another a great mortality among rats was reported, and the broad fact that they do die of plague is incontestable. It is therefore easily intelligible that they may play an important part in multiplying and fixing the poison on a locality. As to how they convey it from man to man the greatest probability is in favour of the flea as an intermediary. Mortality among rats is said to precede the appearance of human plague, but the evidence of this is always retrospective and of a very loose character. At Sydney a careful investigation was made; and the conclusion reached by Dr Tidswell was that "there was no ground for even a suspicion that our epidemic was being maintained by any process of direct contagion between man and man," but that rats were the carriers. In Glasgow the experience was just the contrary. Personal connexion was traced in every case, and rats excluded; there was no mortality among them, and of 300 caught and examined none had plague (Chalmers). Similarly, at Oporto, personal connexion was traced in all the earlier cases; there was no mortality among rats, and no evidence to connect them with the outbreak (Jorge). Again, a comparison between rat-infested and rat-free districts in Bombay showed a much higher incidence of plague in the latter. A campaign against rats in Bombay, by which 50,000 or 60,000 were killed in a short time, had no effect in checking the disease. Plague-rats have rarely been found in ships sailing from infected ports; and though millions of these animals must have been carried backwards and forwards from quay to quay between Hong-Kong, Bombay and the great European ports, they have not brought the disease ashore.

By far the most important communication on the rôle of rats in the spread of plague is formed by the "Report on the Plague Investigations in India" (*Journal of Hygiene*, vol. vi. No. 4; vol. vii. No. 3, 1907). The chief conclusions arrived at in the report as the result of experiments are the following:—

1. Healthy rats contracted plague from infected rats when the only apparent means of communication between the two was the rat flea (*Pulex cheopii*).
2. In 21 experiments out of 38, 55% of healthy rats living in flea-proof cages have contracted plague after receiving fleas collected from rats either dead or dying of septicæmic plague; consequently it is proved the rat flea can transmit plague from rat to rat.
3. Close and continuous contact of plague-infected animals with healthy ones does not infect the latter if fleas are excluded.
4. Should fleas be present an epizootic at once starts and spreads in proportion to the number of fleas present.
5. Guinea-pigs set free in plague-infected houses become infected with the rat flea and develop plague in a certain percentage.
6. Fleas caught on plague-infected rats are able to infect rats placed in flea-proof cages.
7. Guinea-pigs placed in plague-infected houses do not contract plague if they are protected from fleas; those placed in cages protected by a border of sticky paper at least six inches in radius, which the fleas cannot jump over, do not contract plague; the others not similarly protected, do.
8. Chronic plague may prevail in rats.

On this report it may, therefore, be taken that aerial infection, except, perhaps, in pneumonic cases; may be excluded, and that the chief source of infection is the flea. It was also shown that animals may become infected through the faeces of a flea which has been fed on plague-infected rats. This may serve to explain the manner in which plague-infected linen and clothing may convey the disease. The report also considers it proved that the bacillus *pestis* multiplies in the stomach of a flea and may remain a considerable time within its host.

Browning Smith says the following facts are admitted as known. (1) Plague can be carried by fleas from an unhealthy rat. (2) A flea can retain the plague bacilli alive for seven or eight days. (3) Man is, in the majority of cases, infected through the skin, though the puncture may not be seen. (4) The rat flea, when finding no rats, will attack man and it will also attack other animals.

Very little light has been thrown on the conditions which favour the prevalence of plague. We do not know why it has developed a diffusive activity of late years, nor why it has attacked some places and consistently passed by others, such as Singapore. The words "dirt" and "insanitary conditions" are much used, but such general terms explain nothing. Singapore, where plague has several times been introduced, but never taken hold, is probably quite as dirty and insanitary as Hong-Kong, and it is pertinently remarked by the Bombay Research Committee that filth *per se* has but little influence, inasmuch as "there occurred in the House of Correction at Byculla, where cleanliness is brought as near to perfection as is attainable, an outbreak which exceeded in severity that in any of the filthy *chawls* and tenements around." Again, in Oporto there is an area which combines every possible sanitary defect—dense overcrowding, great poverty, no light, no air, no drainage, no scavenging, water brought in buckets. Plague got into this quarter, but did not spread there; on the other hand, it appeared in other and vastly superior parts of the town. Yet in at least one case neither the patient nor the "contacts" were removed, but were all shut up in one room with a sentry at the door and another in the street. The seasonal variations have been well marked and extremely regular in Bombay. The disease begins to be active in late autumn or the beginning of winter, and reaches its height in February or March, dying down in the summer. Baldwin Latham made an elaborate examination of the meteorological conditions, and more particularly of the vapour tension, from which he draws the conclusion that the seasonal variations are due to exhalation from the ground. His observations are original and worth attention. A simpler explanation is that the people live more indoors, and are so more exposed to infection during the plague season. The curve shows two rises, one at the beginning of winter, and the other at the commencement of the monsoon, and at both these times the people are driven indoors. A broad survey of the epidemiological facts suggests some general conclusions. The outbreaks fall into two well-defined groups: (1) those in which the disease is destructive and persistent, (2) those in which its effects are slight and transient. In the former the poison clearly fastens on the locality, and gradually increases its hold. The place is infected, not merely the people in it; for if they evacuate it, the disease soon ceases among them, and if they return in a short time, they are again attacked. Now the poison is contained, as we have already seen, in the discharges from patients, and in such infected localities the standing conditions and the habits of the people combine to retain the discharges on the premises. The floors, mostly of mud covered with dung, are fouled with spittle, vomit, and urine, and, being seldom or never cleaned out, foster a gradual accumulation of poison, to which infected rats and the concealment of illness contribute. These are just the conditions which prevailed in Europe in the old plague days. They do not prevail now in those "white countries" which have been invaded but have repelled the attack with comparative ease and little loss. It may be concluded, with some confidence, from experience and theory alike, that localities where they do not prevail may fail to keep plague out, but have very little to fear from it, except the disturbance of trade caused by the traditional terrors that still cling to the name.

Prevention.—The principles are the same as those which govern the prevention of other infectious diseases. "Sanitary cordons" and the like are obsolete. International procedure is supposed to be regulated by the Venice convention of 1807 (see QUARANTINE), but that instrument contains an optional clause, which allows countries to do as they please with their own frontiers. Except Great Britain and Germany, they all retain quarantine in a more or less stringent form at seaports. It is generally used as a system of local extortion imposed upon travellers and shipping. According to the Venice convention, ships are divided into (1) healthy, (2) suspected, (3) infected. (1) Healthy are those free from plague throughout the voyage, (2) suspected, those in which plague has occurred, but no fresh

case within twelve days; (3) infected, those in which plague has occurred within twelve days. Great Britain relies on medical inspection, removal of sick or suspected cases, and supervision of the healthy arriving on an infected ship; infected clothing is burnt and infected ships are disinfected. The procedure is the same as for cholera, but it has been equally successful. Ships passing through the Suez Canal are subject to similar inspection; sick persons are landed at Moses Wells, and suspected ones detained. The risk of importing plague from India has been materially lessened by medical inspection of outward-bound ships at the principal ports. This has been very thoroughly carried out at Bombay with good results. In 1807 pilgrimages from India to the Hedjaz were prohibited. By the Venice convention a number of articles of merchandise are classed as susceptible and liable to be refused admission, but the only ones which there is any reason to consider dangerous are used clothing and rags. A watch should be kept on rats at ports of arrival and on board ships from infected countries.

When plague is present in a place, the measures to be taken are the usual ones for dealing with infectious disease, with some additions. The sick and suspected should be removed in special ambulances to an isolation hospital, their soiled linen, &c., should be burnt, and the premises disinfected. Corrosive sublimate in an acid solution is the best disinfectant, but sulphuric acid, 1 in 250, is efficient and cheaper. Suspected cases should be bestowed in a special isolated building until the diagnosis is fully determined. "Contacts" should be kept under observation. Rats should be exterminated as far as possible, especially by means of the *Danysz virus*, which spreads a disease amongst rats which cannot be communicated to man. The greatest care should be taken in dealing with the hospital linen and discharges from patients. Hospital staffs should be kept apart. Inoculation with Haffkine's prophylactic fluid should be offered to all persons willing to avail themselves of it. It is especially desirable for hospital and ambulance staffs to be inoculated with a vaccine prepared from sterilized cultures of plague bacillus. Inoculation is harmless, and the results obtained in India justify a favourable opinion of its protective efficacy.¹ At Hubli, where nearly the whole population was inoculated between the 11th of May and the 27th of September

¹ The system of inoculation against plague with a fluid prepared from sterilized virus of the disease was introduced in India by Professor Haffkine early in 1897. The composition of this fluid was subjected to a searching inquiry by the Indian Plague Commission, who pronounced its employment to be free from danger, and it was used on a large scale in various parts of India without producing injurious effects. In September 1902, the standard method of manufacturing this fluid was changed by the director of the Plague Institute on his own authority, with the object of expediting the process, and thus meeting the heavy demand then being made by the Punjab government in connexion with a large scheme of inoculation. The change involved the omission of a small proportion of carbolic acid which had up till then been added to the original fluid as a further precaution against contamination. The new fluid, or water agar process, contained no carbolic acid, other methods being relied upon to ensure its purity. On the 6th of November 1902, nineteen persons who had been inoculated on the 30th of October in the village of Malkowal from a single bottle (labelled 53-n) of the new fluid were found to be suffering from tetanus, and all of them subsequently died. A commission, consisting of Sir Lawrence Jenkins, Lieut.-Colonel Bomford, M.D., principal of the Medical College, Calcutta, and Major Semple, R.A.M.C., director of the Pasteur Institute, Kasauli, was appointed by the government of India to inquire into the disaster. They found that the germ of tetanus had been introduced into the fluid before the bottle was opened at Malkowal, and they thought it probable that this might have occurred owing either to insufficient sterilization or to the process of filling the bottle from a larger flask having been performed with defective precautions. They also expressed the opinion that carbolic acid was a valuable agent in restraining tetanus growth when added to plague prophylactic, and they, therefore, thought that its omission was a grave mistake. Experiments undertaken in India by two independent inquiries appeared to confirm the view, and their conclusions, together with the data on which they were based, were submitted with the report of the commission for examination and further experiment to the Lister Institute in London. With reference to the findings of the Malkowal commission the Institute were asked to report: (1) On the comparative efficacy of the standard and new fluids as a

1898, the mean mortality among the inoculated was 1.3%; among the uninoculated 13.2%. At Daman the mortality was—inoculated 1.6%, uninoculated 24.6%; at Dharwar, inoculated 1.2%, uninoculated 5.2%. In all these cases the numbers dealt with were large and the test fair.

Simpson, in *The Practitioner* (Dec. 1906), gives an analysis of the results of Haffkine's serum inoculations as follows:—

Year.	Case Mortality.	
	Uninoculated.	Inoculated.
1897-1900 average . . .	60.99	36.55
1900-1901 " . . .	60.59	36.50
1901-1902 " . . .	65.12	35.07
1902-1903 " . . .	60.1	23.9

In Poona, out of 5595 uninoculated cases the incidence was 6.8%, while in 1300 inoculated cases it was only 0.33%. Klein also prepares a new prophylactic from the dried organs of a guinea-pig, and one of the most interesting experiments is that of Strong (*Archiv für Schiffs- und tropische Hygiene*, April, 1906), who uses for producing immunity in man a living virulent culture of the bacillus *pestis*. He immunized 40 persons without mishap and with no more unpleasant results than those occurring after vaccination. Inoculation protects against attack, and greatly modifies the illness when it fails to protect. How long the protection lasts has not been determined, but it appears to be several months at least.

The main authorities for the researches into plague are in the official reports of recent years from India and elsewhere. See generally W. J. Simpson, *A Treatise on Plague* (1905).

(A. S.; H. L. H.)

protection against plague; (2) on the comparative liability of each fluid to contamination; and (3) on the probable origin of tetanus virus in the Malkowal cases. Their report on these points (Dec. 1904) contained the following conclusions: (1) "The Institute sees no reason to differ from the conclusions of the commission that the new prophylactic is not less efficacious than the old." (2) The Institute is of opinion that in the hands of more or less unskilled workers it is easier to ensure freedom from contamination by Haffkine's 'standard method' of manufacturing plague vaccine than with the 'water agar process' as employed by him. (3) The Institute is in entire agreement with the commission as to the value of 5% carbolic acid in restraining tetanus growth when added to plague prophylactic, and its experiments emphasize still further the importance of this addition in preventing growth and toxin formation in a vaccine which might be liable to the possibility of contamination with spores of tetanus. (4) The conclusions of the Institute coincide with those of the commission that in all probability tetanus was at the time of inoculation in the fluid contained in the bottle, but that it is impossible to determine at what stage in its history or in what way the bottle (53-n) became contaminated."

The government decided, on the advice of the director, that only the standard fluid should be manufactured at the plague institute. This fluid was sterilized by methods approved by the Indian Plague Commission and contained the requisite proportion of carbolic acid. It was bottled by a new method patented by Dr E. Maynard.

The result of the inquiries by the commission and the Lister Institute led to a protracted controversy with regard to the responsibility of Mr Haffkine's laboratory, and to his subsequent treatment by the government of India; and the leading bacteriologists in England warmly took up his cause. A parliamentary "Return of Papers" was issued in June 1907, and in *The Times* of the 29th of July there appeared a letter signed by the distinguished pathologists, Ronald Ross, R. T. Hewlett, A. S. Grunbaum, W. J. Simpson, R. F. C. Leith, W. R. Smith, G. Sims Woodhead, E. Klein, S. Flexner and C. Hunter Stewart, pointing out that the evidence, so far from showing that Mr Haffkine's laboratory was to blame, made it clear to those acquainted with bacteriological work that it could have had nothing to do with the occurrence. They agreed that there was strong evidence to show that "the contamination took place when the bottle was opened at Malkowal, owing to the abolition by the plague authorities of the technique prescribed by the Bombay laboratory, and to the consequent failure to sterilize the forceps which were used in opening the bottle, and which during the process were dropped on the ground"; and they complained of the inadequacy of the inquiries made by the Indian government, and called for Mr Haffkine's exoneration. The evidence showed that it had been much too readily believed that the tetanus germs had entered the fluid before the bottle was opened, and that a grave injustice had been done to Mr Haffkine. Acting on this view, in November 1907, the Indian government invited Mr Haffkine again to take up work in India.

PLAICE (*Pleuronectes platessa*), a species of flat-fish, common on the coasts of northern Europe from Iceland to the Bay of Biscay. It is readily recognized by the yellow or orange-coloured spots which are placed in a row along the dorsal and anal fins, and scattered over the body. The eyes are on the right side, and the teeth in the jaws compressed and truncate. The scales are minute and smooth. Plaice, like other flat-fishes, prefer a sandy flat bottom to a rocky ground, and occur in suitable localities in great abundance; they spawn early in spring, and are in finest condition in the month of May. Individuals of seven or eight pounds weight are considered fish of large size, but specimens of double that weight have been caught.

See the monograph by F. J. Cole and J. Johnstone (Liverpool, 1901); and W. Garstang's "Reports on the Natural History of the Plaice" (*Rapports et procès-verbaux du conseil international pour l'exploration de la mer*, 1905 seq.).

PLAID (Gael. *plaid*, Ir. *plaid*, usually taken to be derived from Gael. *peall*, sheepskin, Lat. *pellis*, skin), an outer garment, consisting of an oblong piece of woollen cloth, which has formed the principal outer part of the costume of the Highlanders of Scotland. The wearer wrapped himself in the plaid, the lower portion, reaching to the knees and belted, forming the kilt. Later the lower portion was separated, being called the *philibeg*, the plaid being used as a covering for the shoulders and upper part of the body. The plaids were usually of a checked or tartan pattern. The word is thus used of any cloth made with such a pattern. "Shepherd's plaid" is a cloth with a chequer of black on a white ground.

PLAIN (O. Fr. *plain*, from Lat. *planus*), a level surface; hence in physical geography a tract of country generally quite flat or comparatively so (see GEOGRAPHY). The adjective "plain" signifies "level," and thence smooth, clear, simple, ordinary, &c.

PLAINFIELD, a city of Union county, New Jersey, U.S.A., about 24 m. W. by S. of New York City. Pop. (1910 U.S. census), 20,550. It is served by the Central Railroad of New Jersey and by electric lines connecting with neighbouring towns. It is situated for the most part on a plain; north-east are heights occupied by the suburb of Netherwood, and north in Somerset county, on the slope of the first Watchung Mountain, is the borough of North Plainfield (pop. 1910 U.S. census, 6117), which forms with Plainfield virtually a single residential and business community. Plainfield is one of the most attractive residential suburbs of New York. The city has an excellent public school system, a good public library, with an art gallery and museum. The Muhlenberg hospital, club houses and a driving track are features of the city. The value of the factory products increased from \$2,437,434 in 1900 to \$3,572,134 in 1905, or 46.6%. Plainfield was settled in 1684, but it was not until 1735 that the first frame house was erected. In 1760 a grist mill was erected, and for several years the place was called Milltown. The township of Plainfield was created out of Westfield township in 1847, and in 1867 Plainfield was chartered as a city.

PLAIN SONG, or **PLAIN CHANT** (*Gregorian Music*; Lat. *cantus planus*; Ital. *canto gregoriano*; Fr. *plain chant*), a style of unisonous music, easily recognizable by certain strongly marked characteristics, some very ancient fragments of which are believed to have been in use under the Jewish dispensation from a remote period, and to have been thence transferred to the ritual of the Christian Church.

The theories advanced as to the origin of this solemn form of ecclesiastical music are innumerable. The most widely spread opinion is that the older portion of it originated with the Psalms themselves, or at least sprang from the later synagogue music. Another theory traces the origin of plain song to the early Greeks; and the supporters of this view lay much stress on the fact that the scales in which its melodies are composed are named after the old Greek "modes." But, beyond the name, no connexion whatever exists between the two tonalities. Less reasonable hypotheses attribute the origin of the plain song to the Phœnicians, to the Egyptians, to the early Christian converts, and to the musicians of the middle ages.

Towards the close of the 4th century Ambrose of Milan, fearing the loss or corruption of the venerable melodies which had been preserved by means of oral tradition only, endeavoured to restore them to their primitive purity, and to teach the clergy to sing them with greater precision. A still more extensive work of the same nature was undertaken, two centuries later, by Pope Gregory the Great. And thus arose two schools of ecclesiastical music, still known as the "Ambrosian" and the "Gregorian chant"—the first of which is practised only in the diocese of Milan, while the latter is universally accepted as the authorized "Roman use." In order to explain the essential differences between these two schools, we must describe in detail some of the peculiar characteristics of plain song.

The melodies which form the *répertoire* of plain chant are not written in modern major and minor scales, but in certain tonalities bearing names analogous to those of the early Greek "modes," though constructed on very different principles. Of these "modes," fourteen exist in theory, though twelve only are in practical use. The intervals of each "mode" are derived from a fundamental sound, called its "final."¹ The compass of each mode comprises eight sounds—that of the first, third, fifth, seventh, ninth, eleventh and thirteenth "modes" extending to the octave above the "final," and that of the second, fourth, sixth, eighth, tenth, twelfth and fourteenth extending from the fourth note below the final to the fifth note above it. Consequently, the "finals" of the first series, called the "authentic modes," occupy the lowest place in each system of sounds, and those of the second series, called the "plagal modes," the middle place—the same "final" being common to one "authentic" and one "plagal mode." The following table exhibits the entire system, expressed in the alphabetical notation peculiar to modern English music—the "final" being indicated in each case by an asterisk, and the position of the semitones, from which each mode derives its distinctive character, by brackets.

Authentic Modes.

1. Dorian, *D, E, F, G, A, B, C, D.
2. Phrygian, *E, F, G, A, B, C, D, E.
3. Lydian, *F, G, A, B, C, D, E, F.
7. Mixolydian, *G, A, B, C, D, E, F, G.
9. Aeolian, *A, B, C, D, E, F, G, A.
11. Locrian, *B, C, D, E, F, G, A, B.
13. Ionian, *C, D, E, F, G, A, B, C.

Plagal Modes.

4. Hypodorian, A, B, C, *D, E, F, G, A.
4. Hypophrygian, B, C, D, *E, F, G, A, B.
6. Hypolydian, C, D, E, *F, G, A, B, C.
8. Hypomixolydian, D, E, F, *G, A, B, C, D.
10. Hypoaeolian, E, F, G, *A, B, C, D, E.
12. Hypolocrian, F, G, A, *B, C, D, E, F.
14. Hypoionian, G, A, B, *C, D, E, F, G.

Nos. 11 and 12 in this series are rejected, for technical reasons into which we have not space to enter; they are practically useless.²

Of these modes Ambrose used four only—the first four "authentic modes," now numbered 1, 3, 5 and 7. Gregory acknowledged, and is said by some historians of credit to have invented, the first four "plagal modes"—Nos. 2, 4, 6 and 8. The use of the remaining "modes," except perhaps the ninth, was not formally authorized until the reign of Charlemagne, who published an official decision upon the subject. In one or other of the twelve "modes" recognized by this decision every plain-chant melody is composed. The number of such melodies preserved to us, the genuineness of which is undoubted, is very large; and the collection is divided into several distinct classes, the most important of which are the melodies proper to the *Psalm-Tones* and *Antiphons*; the *Ordinarium Missae*, the *Introsols*, *Graduals* and *Offertoria*; the *Præfationes*, *Versiculi* and *Responsoria*; the *Hymns* and *Sequences*; and the *Lamentationes*, *Exultes* and other music used in Holy Week.

Of these classes the most interesting by far is that which includes the psalm-tones, or psalm-tunes, called by modern English historians, the "Gregorian tones." The oldest of these are tones 1, 3, 5 and 7, as sung by Ambrose. The antiquity of tones 2, 4, 6 and 8 is less firmly established, though there is no doubt that Gregory the Great sanctioned their use on strong traditional evidence. In addition to these, a peculiarly beautiful melody in mode 9, known as the *Tonus peregrinus*, has been sung from time immemorial only to the psalm *In exitu Israel*.

¹ Analogous to the tonic or key-note of the modern scale.

² For fuller information on the subject see the article "Modes," in Grove's *Dictionary of Music*.

The oldest version of this melody now extant is undoubtedly to a certain extent impure; but tradition imputes to it a very high antiquity, and even our doubts as to the authenticity of the now generally accepted reading extend only to one single note. A widely accepted tradition points out this melody as the tune sung to *In exitu Israel*, as part of the Great Hallel (see *PSALMS*), which is generally (but hardly rightly) identified with the hymn sung by Christ and His apostles immediately after the Last Supper.

One very powerful argument in favour of the Jewish origin of the psalm-tones lies in the peculiarity of their construction. It is impossible to ignore the perfect adaptation of these venerable melodies to the laws of Hebrew poetry, as opposed to those which governed Greek and Latin verse. The division of the tune into two distinct strains, exactly balancing each other, points assuredly to the intention of singing it to the two contrasted phrases which, inseparable from the constitution of a Hebrew verse, find no place in any later form of poetry. And it is very remarkable that this constructional peculiarity was never imitated, either in the earliest hymns or antiphons we possess or in those of the middle ages—evidently because it was found impossible to adapt it to any mediæval form of verse—even to the *Te Deum*, which, though a manifest reproduction of the Hebrew psalm, was adapted by Ambrose to a melody of very different formation, and naturally so since so many of its phrases consist of a single clause only, balanced in the following verse. This peculiarity now passes for the most part unnoticed; and the *Te Deum* is constantly sung to a psalm-tone, very much to the detriment of both. But in the middle ages this abuse was unknown; and so it came to pass that, until the "School of the Restoration" gave birth, in England, to the single chant, avowedly built upon the lines of its Gregorian predecessor, and a somewhat later period to the double one, so constructed as to weld two verses of the psalm into one, often with utter disregard to the sense of the words, the venerable psalm-tones stood quite alone—the only melodies in existence to which the psalms could be chanted. And so intimate is the adaptation of these plain-chant melodies to the rhythm as well as to the sense of the sacred text, even after its translation into more modern languages, so strongly do they swing with the one and emphasize the other, that it is difficult to believe that the composition of the music was not coeval with that of the poetry.

Next in antiquity to the psalm-tones are the melodies adapted to the antiphons, the offertoria, the graduals and the introsols, sung at High-Mass. Those proper to the *Ordinarium missae* are probably of later date. Those belonging to hymns and sequences are of all ages. Among the latest we possess—perhaps the very latest of any great importance—is that of *Lauda Sion*, a very fine one, in modes 7 and 8, adapted to the celebrated sequence written by Thomas Aquinas about 1261.

To the melodies adapted to the *Lamentationes* and the *Exultes*, as sung in the Church of Rome during Holy Week, it is absolutely impossible to assign any date at all. All we know is that they are of extreme antiquity, and beautiful beyond all description. The melody of *Exultes* is, indeed, very frequently cited as the finest example of plain song in existence.

To assert that melodies so old as these have been handed down to us in their original purity would be absurd. But the presence of corruption rarely passes undetected by the initiated; and vigorous efforts have been made from time to time to purify the received text by reference to the oldest and most trustworthy MSS. attainable. Such an effort was begun on a very extensive scale by the "Congregation of Rites," at the instigation of Pope Pius IX., in the year 1868; and the labours of that learned body, together with those of the monks of Solesmes and elsewhere, have done much towards the restoration of plain chant to the highest state of purity possible. In England the Plain-Song and Mediæval Music Society, founded in 1888, has also done valuable work by its publications. (W. S. R.)

PLAINTIFF, one who brings a "plaint" (Low Lat. *placita Nangere*, beat the breast, lament), the name, in law, of the party who brings an action against another, who is called the

"defendant." In suits for divorce the party bringing the suit is styled the "petitioner," the party against whom it is brought the "respondent."

PLAIT (through O. Fr. *plait*, from Lat. *picium*, folded, *picare*, to fold), properly a fold, especially a fold of cloth, now usually in the collateral form "pleat." "Plait" is now principally applied to entwined strands of ribbon, hair, straw or fibre.

PLAN (from Lat. *planus*, flat), a diagram on a flat surface; hence by analogy any deliberate scheme or design. In architecture, a "plan" is a horizontal geometrical section of the walls of a building, or indications, on a horizontal plane, of the relative positions of the walls and partitions, with the various openings, such as windows and doors, recesses and projections, chimneys and chimney-breasts, columns, pilasters, &c. This term is sometimes incorrectly used in the sense of design (q.v.).

PLANARIANS, a well-defined group of animals, characterized externally by their ovoid or vermiform shape, their gliding movement and their soft, unsegmented, ciliated bodies; internally by that combination of low somatic type of structure and complex gonidial organization which is characteristic of the *Platyhelminthes* (q.v.). Their low type of bodily structure may be exemplified by the facts that the mouth is the only means of ingress to and egress from the blind alimentary sac, and that no vascular system is differentiated. Most Planarians are aquatic and the cilia that cover the body produce by their beating a stirring of the water. Hence the class is generally known by the name *Turbellaria*.

Planarians form one of the basal groups of the animal kingdom. They are the simplest of multicellular creeping things. In them the gliding movement has become habitual. The lowest Planarians are still largely free-swimming animalcules and we can trace within the limits of the group the development of the creeping habit and the consequences that flow from it. It has led to the differentiation of anterior and posterior extremities; to the formation of bilateral symmetry; and to the development of a mucilage protecting the body against friction. It entails the concentration of the scattered nervous system on the ventral surface and at the anterior end, and it has induced the segregation of the diffused sense-organs in the head. The Planarians occupy a position midway between the simple planula larva of *Coelenterates* and the segmented *Annelids*. They have probably sprung either from an early *Coelomate* stock, or represent an independent class descended from a two-layered parentage distinct from that of the *Coelenterates*; a view which is adopted in the present article.

Occurrence.—Most *Turbellaria* are aquatic. They abound on the seashore and in fresh water, amongst weeds or under cover of stones, shells and sand. Few of them are pelagic or deep-water forms, and only some half-dozen Planarians are known to be parasitic. A large number of land Planarians are known, chiefly from tropical and south temperate countries.

The majority of marine Planarians are nocturnal or cryptozoic, hiding away during the period of low tide to avoid desiccation of their soft sticky bodies and coming out at night or during high tide to feed. They are mostly carnivorous, and their movements are correlated largely with the nature of their food. The smaller, more active species occur in companies amongst the finer seaweeds over which they creep or swim in pursuit of their food. The larger marine species occur singly or in pairs on *Ascidians*, *Nullipores* or *Polyzoa*, from whence as the tide rises they issue to feed. By the time the next low tide exposes them, these Planarians have so completely digested their meal that we know very little of its nature. The common fresh-water Planarians form either little companies of a dozen or more, usually of a single species, huddled together under a stone or in some cranny (see Pearl [8]), or societies of several species that inhabit *Sphagnum* and other fresh-water vegetation. This fresh-water planarian fauna is of two kinds, the fauna of permanent and that of temporary sheets of water and both show a certain adaptation to their environment. The latter, being subject to greater extremes of temperature than the lacustrine Planarians, produce

thick-shelled eggs only. The development of these eggs is rapid in warm water, slow in cold: so that a pool after a few days of early spring sunshine is soon populated and provision is made for the continuance of the race should a cold snap follow. The lacustrine Planarians exhibit a different form of adaptation. The eggs laid by many of these animals are either thin-shelled and rapidly hatched or thick-shelled and slowly hatched. The lake-water, however, is in spring, even after sunshine, of a much lower temperature than that of pool-water, but the masses of *Sphagnum* and other weeds that border lakes and marshes are often warmer than the open water and may be as much as 13° or 15° C. higher in temperature. Here the Planarians assemble to benefit by the warmth, and under such favourable conditions lay thin-shelled eggs which rapidly develop; whilst in colder surroundings or at the onset of winter thick-shelled resting eggs are laid. In this manner we can understand the abundance of Planarian life in cold meres and transitory pools in Great Britain, Scandinavia, Finland, Denmark and North America.

In contrast to the general habit among *Turbellaria* of haunting dim or dark places, the station chosen by a few species is exposed and strongly illuminated. The marine *Convoluta* and *Polychaerus* and the fresh-water *Vortex viridis* may be taken as examples. *Convoluta paradoxa* occurs among brown weeds which receive much light during neap tides and strong direct sun or light every fortnight. *Polychaerus* creeps about the New England shore without resorting habitually to cover, and is also strongly insolated. *Vortex* resembles the green *Hydra* of our ponds in choosing the lightest side of its surroundings; and finally, *Convoluta roscoffensis* paints the beach green in Brittany, part of Normandy and Natal. In every such case the Planarian is coloured brown or green by the presence of photosynthetically active cells and the singular heliotropic habit of these *Turbellaria* is associated with the illumination necessary for the activity of their coloured cells.

Only one branch of the Planarians has become terrestrial, but this has spread over almost all the whole globe. One species (*Rhynchodemus terrestris*, fig. 1, e) is fairly common in Great Britain under stones, logs and occasionally on fungi, but the Holarctic countries (North America, Europe and North Africa, North Asia) are extremely poor in terrestrial species. In countries lying in the centre and in the south of the great continents and in the south temperate continental islands and archipelagos these land Planarians become more abundant and varied; and being frequently transported with earth or plants they are often found in hotheouses and botanical gardens far from their native country. Their distribution offers some points of special interest showing a close relationship between the South American fauna and that of Australia and New Zealand: between the land Planarians of Madagascar, of Ceylon and of Indo-Malaya; and a marked contrast between Japan and the rest of the Palearctic region (see Von Graff [1], 1899).

External Characters.—Planarians range from the minute forms no larger than *Infusoria* to ovate, marine species, 6 in. in diameter and to ribbon-like land forms 8 in. in length. The majority are small, somewhat cylindrical organisms with a flat creeping surface. Others, comprising the common fresh-water and marine forms, are flattened and leaf-like, often provided with a pair of tentacles near the front end of the body, and in some cases the whole dorsal surface is beset with papillae. The land forms are elongate and smooth, and their anterior extremity is often modified into the arcuate shape of a cheese-cutter. Their movements are usually of a gliding character. The minuter forms perform short excursions into the water round their station, and in so doing recall *Infusoria*. The larger forms, in addition to gliding like pellicles, fold the expanded anterior part of their body into a couple of fins, with which they swim after the fashion of a skate. The folded margins of other forms clasp the weeds on which they live. Adhesion is effected by the mucous investment of the body and frequently by some specially developed local secretion of slime, or by a sucker. By these means, aided by their

* These references are to the literature at the end of this article.

algae-frequenting and cryptic habits, the Turbellaria, though soft-bodied, are able to withstand the violence of the waves.

The anterior end in all Turbellaria is the site of the chief sense-organs, and in some forms (Proboscida) becomes transformed into an invaginable proboscis of highly tactile nature. Such forms lead naturally to the Nemertina (q.v.).

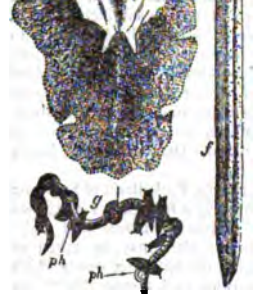

FIG. 1.

- a, *Convoluta paradoxa*, Oe.
b, *Vortex viridis*, M. Sch.
c, *Monolus fuscus*, Gff.
d, *Thysanozoon brochii*, Gr., with elevated anterior extremity (after Joh. Schmidt).
e, *Rhynchodemus terrestris*, O. F. Müller (after Kennel).
f, *Bipalium ceres*, Moe. (after Moseley).
g, *Polycelis cornuta*, O. Sch., attached by the pharynx (ph) to a dead worm (after Johnson).

All the figures of natural size, and viewed from the dorsal surface. a, c and d are marine, b and g are fresh-water, e and f are terrestrial. All found in Great Britain except d.

This green effect is due to the infection of the Planarian by a minute alga which multiplies in the tissues and may profoundly affect the habits and even the structure of its "host." The planarian so affected acquires a heliotropic habit; it becomes gregarious and in extreme cases ceases to ingest solid food. In *Convoluta roscoffensis* the green cells have become indispensable. They function both as the nutritive and excretory organs of the Planarian, and the young animal cannot develop until it is infected and has acquired a supply of these green cells which become incorporated into its tissues (Gamble and Keeble [7]). Brown algal cells (Zooxanthellae) are known in other species of *Convoluta*.

Food.—The food of Turbellarians consists, in the smaller species, of diatoms, unicellular algae, microscopic animals and other Turbellarians; in the larger ones, of worms, mollusca and insects. The fine feeders capture their food chiefly at night by gulping down the minute organisms that settle or swim in their neighbourhood. The coarse feeders enclose their prey with a coating of slime and then proceed either to engulf it in their expandible mouth or to perforate it by their trumpet-like pharynx. The mouth is remarkably variable in position (fig. 2). In many flattened Planarians it is placed centrally on the ventral surface somewhat as in a jelly-fish. In the majority it is nearer the anterior end, but in a few remarkably elongate forms it occupies a position near the hinder end of the animal. In the cylindrical forms (Rhabdocoela) a similar variability in the position of the mouth is met with.

Anatomy.—The structure of the Turbellaria though greatly varied in detail, conforms to a single type of somatic organization which is transitory in the higher invertebrates. The sexual organs,

on the other hand, are founded on two or more types, and the astounding complications of these structures suggest that their evolution has been governed by quite other factors or combinations of factors than those that have guided the somatic evolution of the group.

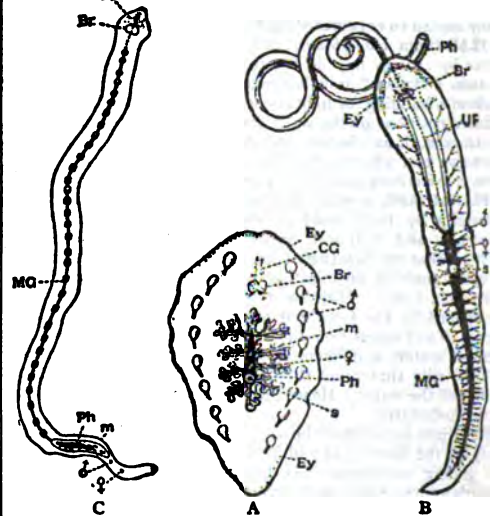

(From Cambridge Natural History, vol. II. "Worms, etc." by permission of Macmillan & Co., Ltd. After Lang.)

FIG. 2.—A group of Polyclad Turbellaria, illustrating the various positions in which the mouth of Planarians may occur, and the concomitant changes in other organs.

- A, *Anonymus viridis*: mouth central, male genital aperture (d) multiple and biradial.
B, *Prosthlostomum siphunculius*: mouth anterior, the pharynx protruded through it.
C, *Cestoplana*: mouth posterior (m); ♂, male; ♀, female genital apertures; Br, brain; CG, eyes especially related to the brain; Ey, marginal eyes; m, mouth; MG, stomach; Ph, Pharynx; s, sucker.

The general structural characters are as follows. The body consists of a muscular envelope covered externally by a ciliated glandular epidermis and of an alimentary sac, cylindrical or branched,

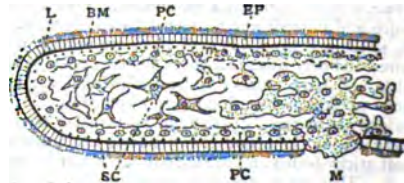

(After Böhmig.)

FIG. 3.—To show the structure of the simplest Turbellaria.

The figure represents the left half of a transverse section across the body of the Acoelous planarian *Haplodiscus*. The mouth (M) is plugged up with a digestive polyuclear mass of cytoplasm and the transitions from this to the stellate scattered central parenchyma (SC) and again from the latter to a firmer peripheral zone (PC) are shown. The outermost layer (EP) is a ciliated epidermis resting on (BM), a basement membrane (dark line); the row of dots beneath this represents the longitudinal muscles (L).

for which the mouth serves both as ingress and egress. Between this apterous gut and the integument the body consists of a jelly-like, vacuolated mesenchyme made up of branched gland-cells, excretory cells, pigment- and muscle-cells. A space may be secondarily hollowed out around part of the gut; but no coelomic or true perivisceral cavity exists in the sense in which these terms are used in higher animals. A nervous system is present and consists of an anterior "brain" and of ramifying ganglionic trunks that are developed in relation to the muscular integument and to the sense-organs for the perception of light and pressure. No

Respiratory organs are developed, probably in correlation with the absence of a blood-vascular system. On the other hand, the process of reproduction is elaborately organized. The Planarians are hermaphrodite and, as in so many other small animals, the body, after attaining maturity, becomes in many Planarians practically a genital sac and is soon exhausted by the repeated calls upon its reserves that are involved in the rapid production of eggs and spermatozoa. The intervals between successive clutches has been found in *Convoluta roscoffensis* to be a month, thus suggesting the influence of the lunar tides upon maturation.

Integument.—The epidermis is ciliated and highly glandular. It consists of a single layer of cubical or oblong cells with the structure seen in fig. 3. The glandular secretion takes various forms, such as mucus, mucinoid granular blocks, or fusiform refringent homogeneous rods. These rods or "rhabdites" are

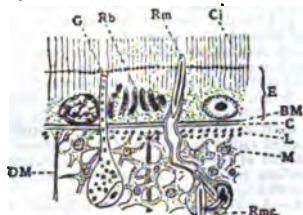

(Partly after Luther: *Zeitschrift für wissenschaftl. Zoologie*, by permission of Wilhelm Engelmann.)

FIG. 4.—Portion of a transverse section of *Mesostoma ehrenbergii*.

The epidermis (*E*) consists of cells divided into an outer and inner zone, the latter containing rhabdites (*Rb*); the cilia (*Ci*) are thickened about the middle of their length. Below the epidermis is the basement-membrane (*BM*), a layer of circular muscles (*C*) and of longitudinal ones (*L*). Below this again is the mesenchyma (*M*), made up of branched cells and dorso-ventral muscle-fibres (*DM*). The mesenchymatous glands (*Rmc*) are producing rhammites (*Rm*) which pass outwards.

frequently coloured red or yellow, and are highly characteristic of the Turbellaria. Their real use is unknown. In only two genera does the epidermis produce cuticular spines (*Acanthozoon*, *Enantia*) on the surface, but chitinoid hooks, spines and spirals occur frequently on the lining membrane of the male and female copulatory ducts.

Below the epidermis is a firm basement membrane into which the subjacent muscles are inserted. They are divided into outer circular and inner longitudinal groups and subdivided in the larger forms by diagonal fibres, and in the most highly differentiated Planarians there are six muscular layers, two of each kind. In a number of Turbellaria the musculature is modified to form a sucker either single or double and anterior or posterior, and it undergoes further modification in connexion with the pharynx and reproductive organs.

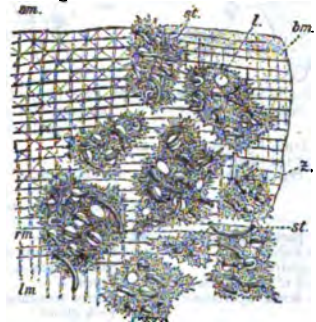

FIG. 5.—Integument of *Mesostoma lingua*, O. Sch.

On the right hand is the epidermis (*s*) with perforations (*l*) through which the rhabdites (*st*) project. Beneath this the basement membrane (*bm*), and beneath this again the muscular layers consisting of circular (*rm*), diagonal (*sm*), and longitudinal (*lm*) fibres.

Alimentary Sac.—The alimentary sac consists of a muscular pharynx opening outwards through the mouth and inwards into a median digestive organ which may be solid or hollow, and in the latter case straight, lobate or branched. These characters are correlated with such a number of distinctive features that the

classification of the Planarian is based on them. Thus we have the *Rhabdocoelida* with straight gut and the *Tricladida* and the *Polycladida* with triple and multiple branches to the gut. The *Rhabdocoelida* are further divided into three groups: the *Acocela*

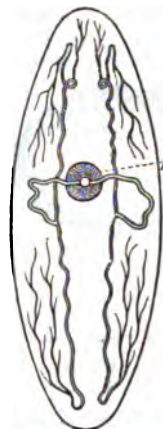

FIG. 6.—Main trunks of the Excretory System of *Mesostoma ehrenbergii*, O. Sch., opening to the exterior through the mouth; *ph*, Pharynx.



(From Lankester's *Treatise on Zoology*, Part IV.)

FIG. 7.—Flame-cell from the Excretory System. *a*, nucleus; *b*, excretory granules; *c*, "flame"; *d*, branches of cell; *e*, beginning of excretory tube.

with a simple syncytial gut not sharply separated from the surrounding mesenchyma; the *Rhabdocoela*, with a hollow gut and a perivisceral schizocoelic span; and the *Allocoocela* with a lobate gut and reduced schizocoel. The last group leads one naturally to the *Tricladida*; the *Polycladida* being an independent group.

The pharynx varies widely in structure. In the *Acocela* it is a mere thickening and pitting of the integument. In the *Rhabdocoela* a great number of elaborate modifications are found. These are based on the type of a buccal invagination, which forms the pharyngeal sheath, and from the bottom of this there springs a muscular outwardly directed tube or fold. In the *Allocoocela* and *Tricladida* the pharynx is an elongate protrusible cylinder, and in the *Polycladida* it may be an immensely distensible filled organ, the folds of which have independent movement, or an elongate tube. At the base of the pharynx lie the openings of salivary glands. In the *Polycladida* the section of the alimentary sac into which the pharynx opens is a median stomach from which the intestinal branches radiate. The stomach in few forms is provided with digestive glands. The branches possess an independent musculature and exhibit active peristalsis. The intestine of Planarians is not ciliated, and digestion appears to be largely intracellular and not cavity.

Mesenchyma.—The mesenchyma (Bohmig: parenchyma *ascti*.) consists of a mass of branched vacuolated cells, imbedded in which lie gland-cells, pigment-cells and the excretory system. It envelops the genital organs, which though in the mesenchyma are not of it, and it forms an investment to the gut and to the space (schizocoel) which often occurs between the gut and the mass of the mesenchyma. The mesenchymatous gland-cells are of different kinds. (1) Single cells in which rods (rhammites) are developed (fig. 4, *Rmc*). Such cells in embryonic life give rise to a process which perforates the soft basement-membrane and penetrates between the epidermal cells. The process becomes hollow, and the rhammites pass outwards along it on to the surface of the animal, forming in many Turbellarians thickly set rows of rods on the head. (2) Similar cells contain nematocysts in a few Planarians (*Microstoma*, *Stenostoma*, *Anonyxus viridis* and *Stylochoplana tarda*). Whether these

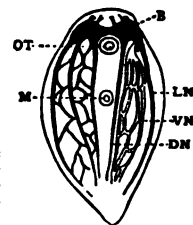
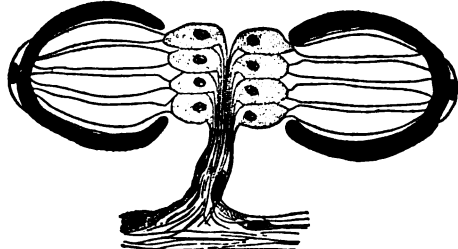

FIG. 8.—The Nervous System of a Simple Planarian (*Haplodiscus*, one of the *Acocela*). *B*, the brain which gives off a dorsal (*DN*) and a ventral (*VN*) plexus and also lateral nerves (*LN*). The mouth (*M*) and the otocyst (*OT*) are shown. The former is ventral, the latter dorsal in position.

neumatocysts develop in the Turbellarian is doubtful, and it is not impossible that they are derived from the tissues of some coelenterate animals eaten by the Planarian, as has been shown to be the case in the neumatocysts of Eolida. (3) Cells producing aciculate spicules, sometimes associated with a spiral thread. These structures are often associated together in batteries, notably so in the remarkable genus *Anonymus*.

Excretory System.—The excretory system consists of proto-nephridia, that is, of tubes opening to the exterior by one or more



(From *Cambridge Natural History*, vol. ii. "Worms, etc." by permission of Macmillan & Co., Ltd. After Lang.)

FIG. 9.—Double Eye found on the brain of Polyclads. Each consists of a pigment-cup and of four nerve-end cells (rod-cells) in which the nerves terminate.

N, nerve fibres and cells. *Pc*, pigment-cell. *Rc*, rod cell.

apertures, and after branching extensively in the mesenchyma, end blindly in peculiar hollow cells (flame-cells) provided with a bunch of synchronously vibrating cilia. The excretory tubules have a markedly sinuous course and are provided with cilia. The motion of these cilia and of the flame-cells is to induce an outward current of the fluid from the canals, but the process of excretion seems to be performed chiefly by the branched mesenchymatous flame-cells. The position of the external opening varies greatly. It may be single or paired, mid-ventral or terminal, or again multiple and arranged in pairs along the dorsal surface (Tricladida and probably in Polycladida). The flame-cells are arranged in pairs in Tricladida, but lie less regularly in the mesenchyma of most forms. Finally, it is noteworthy that in the Acoela no excretory system is known.

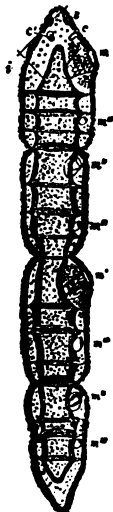

FIG. 10.—*Microstoma lineare*, Oe., undergoing division. There are 16 individuals. 8 with mouth apertures, showing the buds of the first (*m*), second (*m'*), third (*m''*), and fourth (*m'''*) generation. The fifth generation has not yet acquired a mouth aperture. *c*, ciliated aperture; *e*, eye spots; *s*, intestine.

The otcyst occurs constantly in the Acoela and sporadically in every other division of the group. It is with one exception a single median organ placed over the brain, and consists of a uni- or bi-cellular sac containing a calcareous

concretion lying in a fluid. From what is known of these organs in higher invertebrates we may infer that they serve to increase the perception of slow wave-movement and enhance the control of the muscular sense.

Eyes are generally present in Planarians. Two types are distinguishable—eyes with a cup-shaped retina facing outwards, and those with an inverted retina facing inwards. The former occur in Tricladids and Polycladids around the margin of the body often a hundred or more may be present. The latter occur in all groups except the Acoela, but are limited to the neighbourhood of the brain or bases of the nuchal tentacles. Recent investigation has shown that the essential part of the eyes has in all cases a complicated structure and is not a mere epidermal cell-group enclosed by pigment and provided with an optic nerve. On the contrary (Hesse [10]), adequately known eyes are composed of rod-cells that contain each an axial filament or bundle of fibrillae (the termination of the nerve), and the distal end of the rod-cell is converted into a striated usually broad border where the action of light commences. A group of such specialized rod-cells is enclosed in a pigmented cup opening either outwards or inwards and pierced by an optic nerve. The whole is usually depressed beneath the epidermis, but in some Acoela and Allocoela the eyes retain a surface-position. In the Polycladids eyes may increase by division and in Tricladids may decrease in number by fusion (Carrière [11]). The marginal and often radial disposition of the scattered eyes, and the prostomial position of the paired eyes, afford interesting evidence of the intermediate position that Planarians occupy between the radiate Coelentera and the bilateral Annelida.

Reproduction.—All Turbellaria are hermaphrodite, and reproduce sexually, but a few forms (Microstomidae and some Tricladida)

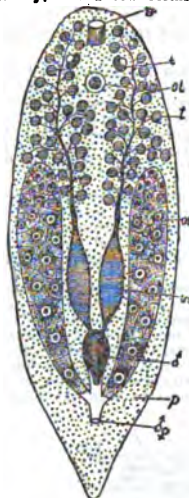

FIG. 11.—Plan of an Acoelous Turbellarian.

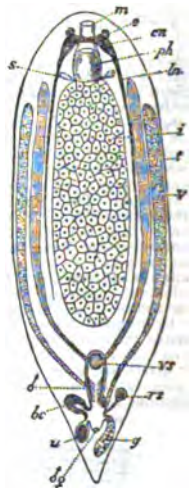

FIG. 12.—Plan of a Rhabdocoelous Turbellarian.

- e*, Eye.
- m*, Mucous gland, formerly mistaken for the mouth, which lies in the centre of the body.
- ol*, Otolith.
- p*, Digesting parenchyma.
- i*, Testicular follicles.
- vs*, Vesicula seminalis.
- sigma*, Male-organ of copulation.
- sigma-delta*, Common sexual aperture.
- bc*, Bursa copulatrix.
- ca*, Brain.
- e*, Eye.
- g*, Germarium.
- s*, Intestine.
- ln*, Longitudinal nerve trunk.
- m*, Mouth.
- ph*, Pharynx.
- rs*, Receptaculum seminis.
- s*, Salivary gland.
- t*, Testis.
- u*, Uterus (containing an egg).
- v*, Yolk gland.
- vs*, Vesicula seminalis.
- sigma-delta*, Chitinous copulatory organ.
- sigma-delta*, Common sexual aperture.
- bc*, Bursa copulatrix.

increase during the summer by fission and during the winter by eggs. The body of the Microstomidae becomes constricted and partially subdivided into two, the posterior half regenerates a brain and pharynx. Subsequently each becomes again converted into two zooids, and the process is repeated until a chain is formed as in fig. 10. This breaks up into its constituent members, each of which repeats the process until the onset of reproduction. The

Triclad, on the other hand, fragment, without undergoing preparatory changes.

The male and female genital ducts (gono-ducts) open to the exterior, either through a common chamber on the ventral surface (most Rhabdocoelida and all Tricladida, figs. 12, 14) or by separate apertures that are also usually ventral. In the latter case, the male gonopore is usually in front of the female one (all Polycladida and some Rhabdocoelida). A separate opening is sometimes acquired by one or other of the accessory reproductive organs (as by the spermotheca in some Rhabdocoelida in which it is dorsal).

The generative organs of the Planarians are complex. Male and female germ-cells develop in one and the same individual and reach the exterior by independent ducts. These ducts are provided with accessory glands along their course and terminate in penial

ally into the oviduct, and sterile ova that become yolk-cells and open into the brood-pouch.

The remaining Rhabdocoelida possess separate ovaries and yolk-glands. The union between the two sets of ducts takes place in the genital atrium which is provided with a spermotheca for the fertilization of the ova, but in at least one sub-family (*Cylindrostomidae*) the spermotheca opens by a special dorsal pore. These ova, together with the yolk and spermatozoa, are then transferred to another atrial diverticulum—the uterus, in which a shell is formed and from which they are deposited in the form of a cocoon. In addition, a muscular pouch, the so-called "bursa copulatrix," is usually present. The male organs of Rhabdocoelida are no less complex. The testes are either follicular (Allocoelida) or compact

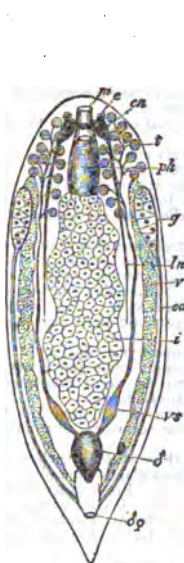

FIG. 13.—Plan of an Allocoelous Turbellarian. Lettering as in fig. 12.

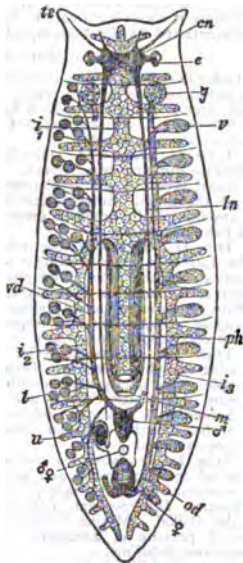

FIG. 14.—Plan of a Triclad.

*i*₁, Anterior, and *i*₂, paired posterior branches of intestine.
od, Oviduct.
te, Tentacle.
vd, Vas deferens.
♂, Male, and ♀, female copulatory organ. Other letters as in fig. 12.

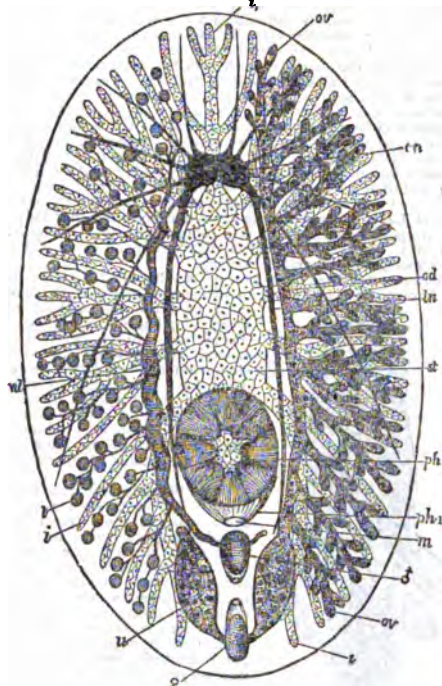

FIG. 15.—Plan of a Polyclad.

cn, Brain.
i, Intestinal branches.
*i*₁, Anterior unpaired intestinal branch.
*i*₂, Longitudinal nerve cord.
m, Mouth.
od, Oviduct.
ov, Ovarian follicle.
ph, Pharynx.
ph, Pharyngeal pouch.
st, Stomach.
f, Testicular follicle.
u, Uterus.
vd, Vas deferens.
♂, Male copulatory organ, with the male aperture behind.
♀, Female copulatory organ, with the female aperture before it. The eyes are omitted.

or vaginal structures, often of great complexity, which are surrounded by an "atrium" or invagination of the ventral body-wall. From this invagination a special vesicle "uterus" is often developed for the reception of the fertilized egg previous to oviposition.

The Acœla present the simplest arrangement. In this group (fig. 11) the male germ-cells arise in follicles each of which is the product of a single sperm-mother-cell. From these follicles, the motile spermatozoa enter the paired sperm-duct, which opens by a single aperture near the hinder end of the animal, and is provided with a simple unarmed glandular penis. The female germ-cells or ova arise from a paired ovary, some of the cells of which appear to act as nurse-cells, supplying the young eggs with nourishment. When mature the eggs are transferred to the oviduct. At the point where the two oviducts join in order to open to the exterior they receive a conical sac (spermotheca) which contains spermatozoa. At this point the eggs are fertilized, and deposited in a mucilaginous mass which is attached to algae or buried in the sand. It is characteristic of the Acœla that the testes and ovaries should not be continuous with either the sperm-duct or the oviduct respectively.

In one genus of the Acœloous Turbellaria—*Polychaerus*—this primitive arrangement undergoes a development which foreshadows the complicated ovaria and vitellaria of higher forms. In *Polychaerus* the eggs mature in a special roomy chamber and are here provided with yolk which is elaborated by a sterile part of the ovary. Thus we have a differentiation of germ-cells into two portions allocated to two chambers: fertile ova which open eventu-

(Rhabdocœla), and communicate indirectly or directly with the paired seminal ducts. The ducts unite at the base of an evaginable penis. This muscular organ is provided with glandular and chitinous appendages of considerable complexity, and, in addition to these, a poison gland and duct are sometimes present. In certain genera (*Macrorhynchus*, *Prohynchus*) the penis is used for catching prey, perhaps exclusively so in the former genus. The opening of the atrium into the oral cavity in *Cylindrostominae* and of the male organ into the mouth of *Prohynchus* is possibly explained by this fact.

From the Allocoœla we pass readily to the Triclad. In both of these groups the reproductive organs are based on the same plan; but in Triclad the separation of ovarian and vitellarian portions of the gonad is less perfectly effected. The oviduct transmits the eggs from the anteriorly placed ovary, and receives in its course the openings of numerous vitellaria (fig. 14). No distinct spermotheca is developed, but a cocoon is formed in a special chamber—

the uterus—which may either be a dilatation of the common oviduct (vagina) or of the atrium, and may open to the exterior independently (single in *Uteriporus*, paired in *Syncoelidium*). In *Bdellooura* the uterus is said to act as a spermatheca. In addition to these structures, accessory muscular organs are found in *Dendrocoelum* and developed to a high degree in land Planarians, where they form the so-called adenocoeletri and adenodactyli (see von Graff, 1899).

Lastly, the Polyclads offer certain distinctive sexual characters. The ovaries are follicular, very numerous, and the ova elaborate their own yolk (fig. 15). The oviducts open into a chamber which, after receiving a voluminous shell-gland, opens by a muscular bursa to the exterior. No special uterus is developed, but from the point of union of the two egg-chambers a vesicle is given off which may open separately to the exterior (*Trigonoporus*). The testes are equally diffused and the seminal vesicles usually form a median muscular eversible sac which opens in front of the female genital pore. In *Stylostomum*, however, this penial organ opens through the mouth, as in certain Rhabdocoelida. Moreover, it may be paired (*Thysanozoon*) or multiple. Thus in *Anonymus* twelve or more pairs occur. In *Cryptocoelids* two, four or six may be present, but in this genus they all lie in a common sac. In *Polyostia* twenty pores occur ranged about the female pore, but the most posteriorly placed of these structures are devoid of a seminal duct. This condition supports the view that in Polyclads the penis was at first a glandular organ probably used for attacking prey and that it has become secondarily connected with reproduction. In confirmation of this conclusion we have the observations of Lang (5) that *Yungia* stabs the body of other Polyclads with its penis when brought into contact with them. (See Whitman [9].) The genus *Laidlawia* differs from all other Polyclads in possessing a dorsal genital opening.

Development.—The development of the Polyclads, development is direct and without metamorphosis; but in *Thysanozoon* and *Yungia* the embryo develops eight strongly ciliated lobes which form a circumoral band of larval processes. These have been compared with the girdle of Trochophore larvae and also with the eight rows of swimming plates in Ctenophores. From the name of their discoverer these girdled larvae are called Müller's larvae (fig. 16).



(After A. Lang.)

FIG. 16.—Larva of *Yungia auranitica*, L. (*Polycladida*), with provisional ciliated processes.

The ova contain yolk-granules, and yolk-cells are absent. Groups of such eggs, each with its own shell, are laid in a gelatinous envelope. Each ovum segments into a two-layered embryo composed of a ciliated outer layer and a central syncytium. No trace of a distinct enteron or gut is visible, but as the embryo grows the syncytium becomes differentiated into a more fluid central portion and a firmer periprteral zone. The former, together with the wandering phagocytes, corresponds functionally to the separate gut of other Rhabdocoelida. Pelagic larvae with a coat of long cilia have been identified by Uljanin as belonging to the Acoela.

The development of the Tricladida offers other peculiarities. From four to twenty or more ova are surrounded by several hundred amoeboid yolk-cells in each cocoon. Each egg-cell divides; but, as happens in the capsular ova of certain Mollusca and Oligochaeta, they do not all survive, some being used up as food by the remainder. The segmented ovum becomes dislocated as in some Rhabdocoelids, the blastomeres moving apart from one another. The details of organ-formation are still imperfectly understood.

The eggs of the Polyclads are laid somewhat like those of the Acoela in a gelatinous envelope, each ovum being provided with yolk and an egg-shell which may be operculate. The majority of species go through a direct development. The segmentation of the egg in *Discoceles* and *Leptopana* has been worked out by Lang and his results re-interpreted by Wilson and others (Hubrecht

[12]). In Polyclads a distinction of germ-layers similar to that occurring in the development of Mollusca, Chaetopod-Annelids and certain other Invertebrates, is early apparent. The ovum by unequal segmentation gives rise to megameres and micromeres, and between the two, intermediate cells form one origin for the mesenchyma. The micromeres surround the intermediates and centrally placed macromeres. The latter undergo division into hypoblast cells and yolk-masses. The similarity of cell-lineage in Polyclads and Coelomate Invertebrates, together with the trochophore-like Polyclad larval form (Müller's larva), have been the two chief arguments in support of the view that this group is a link between the Planarian and Coelomata. It is at present, however, doubtful whether such highly organized animals as Polyclads can be regarded as in any sense ancestral forms. Their relations to other Turbellaria are quite uncertain, and on present evidence it seems legitimate to hold that they are the most highly differentiated division both in embryonic and adult structure.

Systematic Arrangement.

Order Turbellaria.—Free-living Platyhelmintha with a ciliated epidermis. A well-developed nervous system and sense-organs concentrated at the anterior end of the body, diffused elsewhere.

Sub-order A. Rhabdocoelida.—Gut syncytial or tubular. Female gonads always compact.

Tribe I. Acoela (fig. 11).—Mesenchyma not differentiated into separate gut and parenchyma. No excretory organs of protozoophidial type. A simple pharynx. A median otocyst (statocyst) over the brain. Small, often flattened forms. All marine and many infected by brown or green algal cells. One species parasitic in Echinoderms.

Tribe II. Rhabdocoela (fig. 12).—Gut and parenchyma separate, the former a simple straight sac. Vitellaria usually present. Testes compact. Penis and pharynx often complex, occasionally protruded through a common opening. Marine and fresh-water. Many fresh-water forms infected by algal cells. *Typhlopana*, *Graffia*, *Anopodium*, are respectively parasitic in *Nephtys*, in Gastropods and Holothurians.

Tribe III. Allocoela.—Gut and parenchyma distinct. Intestine straight or lobate. Testes follicular. Penis and pharynx simple. One family with otolith. All marine except *Plagiosomus lemami* (deep-water, Geneva) and the *Bothrioplanidae*.

Sub-order B. Dendrocoelida.—Large forms with flattened body, branched intestine, follicular testes and follicular ovaries or compact ovaries and yolk-glands.

Tribe I. Tricladida.—Intestine with three main branches. A pair of compact ovaria and numerous yolk-glands connected by a common duct. A single genital aperture. Fresh-water forms: *Planaria*, *Dendrocoelum*, *Polycelis*, common. Peculiar forms in Lake Baikal. Marine forms: *Gunda segmentata*, *Bdellooura* (external parasite of *Limulus*). Terrestrial forms: *Rhynchodemus*, *Geoplana*, *Biparium*.

Tribe II. Polycladida.—Body leaf-like. Intestine composed of a median stomach with many branched or reticulate coeca; testes and ovaries follicular; genital openings usually separate, the male gonopore preceding the female one. Multiple male gonopores in some forms. All marine and widely distributed; some genera cosmopolitan.

LITERATURE.—(1) L. von Graff (Rhabdocoela, Acoela, Tricladida), *Monographie d. Turbellarien* (1883), vol. i., (1899) vol. ii.; *Die Acoela* (1891); (2) *Arbeiten aus der zool. Institut zu Graz* (1904, 1905, 1906); (3) "Turbellaria," in Bronn's *Klassen u. Ordnungen d. Thierreich*, vol. ii.; (4) *Turbellaria als Parasiten v. Wirthe* (Graz, 1904); (5) A. Lang, "Die Polycladen," *Fauna and Flora of the Gulf of Naples*, vol. ii. (1884); (6) F. F. Laidlaw (Polyclads) in *Zoological Results of Expeditions conducted by Dr. Willey, Stanley Gardiner and C. Crossland*, Cambridge Univ. Press, and *Proc. Zool. Soc.* (1902-1906); (7) Gamble and Keeble (Green cells of *Convoluta*), *Quart. Jour. Micro. Sci.* (1903, 1907); (8) E. R. Pearl (Bionomics of Planarians), *ibid.* (1903); (9) Whitman (Hypodermic Impregnation), *Jour. Morphology* (1890), iv. 361; (10) Hesse (Eyes of Planarians), *Zeitschr. f. wiss. Zool.*, vol. lxi. (1897); (11) Carrière (ditto), "Die Sehorgane der Thiere" (1885); (12) A. A. W. Hubrecht (affinities), *Zeitschr. f. Naturwiss.* (Jena, 1905); (13) Breslau (Development of Rhabdocoels), *Zeitschr. f. wiss. Zool.* (1905). Besides these special works, useful general accounts of the Turbellaria will be found in *Cambridge Natural History*, ii. 1-50; *A Treatise on Zoology* (Black), iv. 1-42, and the references given by these works.

Appendix to the Turbellaria.

Class Temnocephaloida.—This small class of Platyhelmintha possesses a special interest. It connects the Turbellaria (and in particular the Vorticid Rhabdocoela) with the Trematoda. At the same time the Temnocephaloidea present certain peculiar structural features which entitle the class to an independent position.

The name of the class is derived from the digitate tentacles which occur on the anterior or lateral margins of the body. The body measures about 5 mm. in length, and the flattened ventral surface is armed with a sucker. It presents in most genera the appearance of a minute cephalopod, but in *Craspedella* the posterior

part of the dorsal surface is raised up into three transverse fringed lamellae. These animals are epizoic, i.e. they live attached to the outer surface of other organisms, but are not ectoparasitic for they ingest Infusoria, Rotifera and Diatoms. Most of the species occur on fresh-water crayfish and crabs in Chile, Madagascar, the Malay Archipelago and Australasia. Two Brazilian forms are known, one from the pulmonary chamber of the Mollusc *Ampullaria* and the other from water tortoises. The genus *Temnocephala* is found in all the countries mentioned. The two others, *Craspedella* and *Actinodactylia* are only known from Australia.

The epidermis offers an interesting transitional structure. It is still, as in Turbellaria, cellular, or rather syncytial without cell-boundaries, but in most species has lost its cilia and developed a

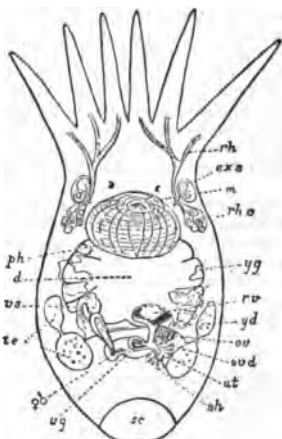

(From Cambridge Natural History, vol. ii. "Worms," &c., by permission of Macmillan & Co., Ltd.)

FIG. 17.—The anatomy of *Temnocephala* (after Haswell).

- | | |
|------------------------------|-------------------------------|
| ♂♂, Common genital aperture. | rh, Rhabdites. |
| d, Gut. | rh.c, Rhabdite-forming cells. |
| ex.s, Excretory sac. | sc, Sucker. |
| m, Mouth. | sh, Shell-land. |
| ov, Ovary. | te, Testis. |
| ovd, Oviduct. | ut, Uterus. |
| ph, Pharynx. | vg, Vagina. |
| rv, Receptaculum vitelli. | vs, Vesicula seminalis. |

thick cuticle as in Trematodes, pierced by the necks of subdermal gland-cells. These cells, however, still retain the Turbellarian character of secreting rhabdites and form thickly-grouped tracts. The mouth, which is placed near the anterior end, leads into a bulbous pharynx from which a short, broad digestive sac is given off. The excretory system is peculiar. Besides the ordinary flame cells, single large canalculated cells may form the commencement of the tubules, composed of comparatively few cells with large nuclei. They open to the exterior by a pair of contractile sacs situated dorsally at the level of the mouth as in certain Trematoda. Each sac is the product of a single cell, and is said to contain several branches of "flames" or synchronously contractile cilia. The reproductive system recalls that of certain Rhabdocoels, whilst the nervous system has retained a more primitive condition. The brain, which is placed over the mouth, gives rise to six main longitudinal tracts interconnected by a subdermal network. A pair of eyes is placed above the brain.

Class and order *Temnocephalida*.—Platyelmia in which the flattened body is produced into anterior or anterior and lateral tentacular processes and carries a ventral sucker. The epidermis is a syncytium covered by a thick cuticle. Cilia and rhabdites are present. Family I.: *Temnocephalidae*: 4-12 anterior tentacles. Family II.: *Actinodactylidae*. Lateral tentacular processes.

See Haswell, *Macleay Memorial Volume* (1893); Plate, *Stsberich. Akad. Wiss. Berlin* (1894), p. 527. (F. W. GA.)

PLANCEER, or **PLANCHIER** (O. Fr. *plancier*, or *planchier*, planking), in architecture, a term sometimes used in the same sense as a soffit, but more correctly applied to the soffit of the corona in a cornice.

PLANCHE, **JEAN BAPTISTE GUSTAVE** (1808-1857), French critic, was born in Paris on the 16th of February 1808. Intro-

duced by Alfred de Vigny to François Buloz, he began to write for the *Revue des deux mondes*, and continued to do so until 1840. He resumed his connexion with the journal in 1846 and contributed to it until his death in Paris on the 18th of September 1857. Gustave Planche was an altogether honest critic and refused to accept a place from Napoleon III. for fear of compromising his freedom. He was in early life a fervent admirer of George Sand, and he lavished praise on De Vigny. But he had nothing but scorn for Victor Hugo, whose earlier dramas he characterized as odes, those following *Le Roi s'amuse* as anti-theses, and the later ones as nothing but *spectacle*. His critical papers were collected under the titles: *Portraits littéraires* (1836-1849); *Nouveaux portraits littéraires* (1854); and art criticisms, *Études sur l'école française* (1855).

See Ernest Montégut, in the *Revue des deux mondes* (June 1858); Hatzfeld and Meunier, *Les Critiques littéraires du XIX^e siècle* (1891).

PLANCHÉ, **JAMES ROBINSON** (1796-1880), English dramatist and antiquary, was born in London on the 27th of February 1796, the son of a watchmaker of Huguenot descent. In 1810 he was articled to a bookseller. In 1818 his first dramatic piece, a burlesque entitled *Amoroso, King of Little Britain*, was produced at Drury Lane theatre. From this time onwards he made play-writing his principal work. In 1820-1821 he wrote ten pieces for the Adelphi theatre. In 1823 he designed the dresses for Charles Kemble's revival of *King John* at Covent Garden, and superintended its production. This was the first time that an historical drama had been "dressed" in the costume of the period. In 1828 he began writing regularly for Covent Garden theatre, and in 1830 was manager of the Adelphi. On Mme Vestris taking the Olympic theatre in 1831, Planché entered into an agreement with her to write a series of plays. The first of these, *Olympic Revels*, a burlesque, was given on the opening night of the theatre, the performance being given in correct classical costume. In 1843 his *Fair One with the Golden Locks* was produced by Webster at the Haymarket. In 1847 Mme Vestris became manageress of the Lyceum theatre, and Planché was engaged as her leading author and designer, his principal success being the *Island of Jewels* (1849). Subsequently he wrote for a number of other managements, his last dramatic piece being *King Christmas* (1871), but he also wrote the songs for *Babil* and *Bijou* at Covent Garden (1872). In addition to his dramatic work Planché enjoyed a considerable reputation as an antiquary and heraldic student. He was a Fellow of the Society of Antiquaries, and aided in the foundation of the British Archaeological Association in 1843. In 1834 he published *The History of British Costumes*. In 1854 he was appointed Rouge Croix pursuivant of arms at the Heralds' College, and in 1866 Somerset herald. In 1869, at the request of the War Office, he arranged the collection of armour at the Tower of London in chronological order. He died at Chelsea on the 30th of May 1880.

Planché's *Recollections and Reflections* were published in 1872.

PLANCK, **GOTTLIEB JAKOB** (1751-1833), German Protestant divine and historian, was born at Nürtingen in Württemberg, where his father was a notary, on the 15th of November 1751. Educated for the Protestant ministry at Blaubeuren, Bebenhausen and Tübingen, he became *repentant* at Tübingen in 1774, preacher at Stuttgart in 1780, and professor of theology at Göttingen in 1784. At Tübingen he wrote *Das Tagebuch eines neuen Ehemannes*. In 1781 he published anonymously the first volume of his *Geschichte des protestantischen Lehrbegriffs*; the second, also anonymous, appearing in 1783, and it was completed in six volumes in 1800. It was followed by an extensive *Geschichte der christlich-kirchlichen Gesellschaftsverfassung* in five volumes (1803-1809). Both are works of considerable importance, and are characterized by abundant learning. He died on the 31st of August 1833. His son Heinrich Ludwig Planck (1785-1831), also professor of theology at Göttingen, published *Bemerkungen über den ersten Brief an den Timotheus* (1808) and *Abriß d. philos. Religionslehre* (1821).

PLANCK, KARL CHRISTIAN (1810-1880), German philosopher, was born at Stuttgart on the 17th of January 1810. He studied at Tübingen, where he became doctor of philosophy in 1840 and *Privatdozent* in 1848. During this period the influence of Reiff led him to oppose the dominant Hegelianism of the time. In 1850-1851 he published his great book, *Die Weltalter*, in which he developed a complete original system of philosophy, based on the realistic view that thought should proceed from nature to the highest forms of existence in the spiritual life. Not only did Planck oppose the idealism of his *confrères*; his views were, in another aspect, directly antagonistic to the Darwinian theory of descent, which he specifically attacked in *Wahrheit und Flachheit des Darwinismus* (Nördlingen, 1872). The natural consequence of this individuality of opinion was that his books were practically disregarded, and Planck was deeply incensed. The ill success of *Die Weltalter* nerved him to new efforts, and he repeated his views in *Katechismus des Rechts* (1852), *Grundlinien einer Wissenschaft der Natur* (1864), *Seele und Geist* (1871), and numerous other books, which, however, met with no better fate. In the meantime he left Tübingen for Ulm, whence he came finally to the seminary of Maulbronn. He died on the 7th of June 1880 in an asylum after a short period of nervous prostration. After his death a summary of his work came into the hands of K. Köstlin (author of *Aesthetics*, 1860), who published it in 1881 under the title *Testament eines Deutschen, Philosophie der Natur und der Menschheit*. Planck's views were elaborately developed, but his method of exposition told heavily against their acceptance. He regarded himself as the Messiah of the German people.

Beside the works above quoted, he wrote *System des reinen Idealismus* (1851); *Anthropologie und Psychologie auf naturwissenschaftlicher Grundlage* (1874); a political treatise, *Bismarck: Sieddeutschland und der deutsche Nationalstaat* (1872); and *Logisches Causalgesetz und natürliche Zweckmässigkeit* (1874).

See Umfrid, *Karl Planck, dessen Werke und Wirken* (Tübingen, 1881); and Schmidt, "Das Lebensideal Karl Christian Plancks," in the *Vorträge der philosophischen Gesellschaft* (Berlin, 1896).

PLANE. 1. In botany, the common name of a handsome tree known botanically as *Platanus orientalis*, a native of Greece and western Asia, a favourite shade-tree of the ancient Greeks and Romans, and introduced by the latter to south-west Europe. It

flowers are borne in dense pendulous heads, which contain either male or female flowers; the small one-seeded fruits are densely crowded in a ball, from which they gradually separate in drying, and are readily carried by the wind. The wood, which is hard and heavy, though not strong, is used in Persia and other countries of western Asia for house construction and furniture. A variety of forms are known in cultivation, the commonest being the maple-leaved (*acerifolia*), the London plane, which has usually three-lobed leaves; var. *laciniata* has very deeply much divided leaves, and var. *variegata*, variegated foliage. *Platanus occidentalis*, an allied species, is a native of the United States, being most abundant and growing to its largest size in the bottom lands of the basins of the lower Ohio and the Mississippi rivers. It was introduced into England early in the 17th century, and is occasionally met with in western and central Europe. Professor C. S. Sargent (*Silva of North America*) refers to it as the most massive if not the tallest, deciduous-leaved tree of the North American forest; it is known in America as sycamore and buttonwood. It differs from *P. orientalis* in its less deeply lobed, more leathery pubescent leaves and in the usually solitary balls of fruit.

2. The name of a carpenter's hand-tool, used for leveling and smoothing (Lat. *planus*, level) the surface of wood. The machine tool used for a similar purpose for metals is generally known as a planing-machine or planer.

PLANET (Gr. $\piλανήτης$, a wanderer), in the ancient astronomy, one of seven heavenly bodies characterized by being in motion relative to the fixed stars, which last appeared immovable upon the celestial sphere. As thus defined the planets were the sun, the moon, Mercury, Venus, Mars, Jupiter and Saturn. In modern astronomy since Copernicus, the term is applied to any opaque body moving around the sun. Taken in its widest sense it applies to the satellites which are sometimes termed *secondary planets*. Each of these moves around a planet larger than itself, which it accompanies in its revolution round the sun. A planet not revolving round another is termed a *primary planet*.

The primary planets are classified as major and minor. The former are eight in number and, with the sun, form the principal members of the solar system, under which head their arrangement is described. The earth on which we live is the third in the order of the major planets from the sun. With respect to the positions of their orbits relative to the earth, the other planets are distinguished as *inferior* and *superior*. The former, only two in number, comprise Mercury and Venus, which revolve between the earth and the sun. The superior planets are those whose orbits are outside that of the earth. The synodic revolution of an inferior planet is the time in which it performs a revolution relative to the line joining the earth and the sun. This is greater than its actual time of revolution. The phases or appearances presented by such a planet depend upon its configuration with respect to the earth and sun, and therefore go through their complete periods in a synodic revolution. At superior conjunction the illuminated hemisphere of the planet is presented to the earth so that it presents the form of a full moon. As it moves towards inferior conjunction, the lines from the planet to the sun and to the earth, or the angle sun-earth as seen from the planet, on which the phase depends, continually make a greater angle. At the time of greatest elongation this angle is 90°, and the planet appears one half illuminated, like the moon at first or last quarter. Then, as it approaches inferior conjunction, the visible portion of the disk assumes the crescent form, and while the circle bounding the disk continually increases owing to the approach of the planet to the earth, the crescent becomes thinner and thinner until, near inferior conjunction, the planet is no longer visible. After conjunction the phases occur in the reverse order. The brilliancy of the planet, as measured by the total amount of light we receive from it, goes through a similar cycle of change. The point of greatest brilliancy is between inferior conjunction and greatest elongation. In the case of Venus this phase occurs about three or four weeks before and after inferior conjunction.

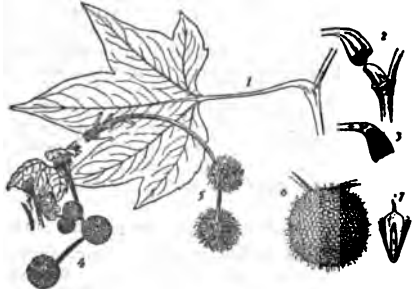

Plane (*Platanus orientalis*).

- 1, Leaf, $\frac{1}{2}$ nat. size.
- 2 and 3, Base of leaf-stalk showing bud-protecting cap, about $\frac{1}{2}$ nat. size.
- 4, Male. 5, Female inflorescence.
- 6, Head of fruits, about $\frac{1}{2}$ nat. size.
- 7, A fruit with enclosed seed, cut lengthwise.

is one of the most successful trees in London and other large towns; the smooth face of the leaf is easily washed by rain; and the periodical peeling of the bark also serves to get rid of impurities. It is a large tree with widely spreading branches and alternate, palmately five-lobed leaves, resembling those of the sycamore in shape, but quite hairless and of a brighter green. The bud in the leaf axil is protected during its development by the hollow base of the leaf-stalk, which lifts off like an extinguisher when the leaf falls in autumn. The minute, unisexual

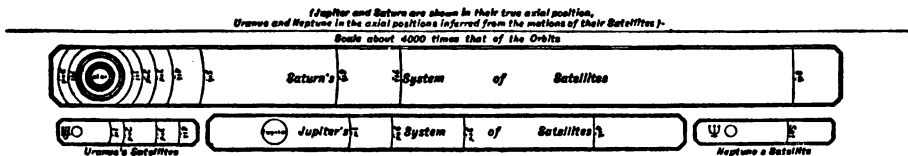
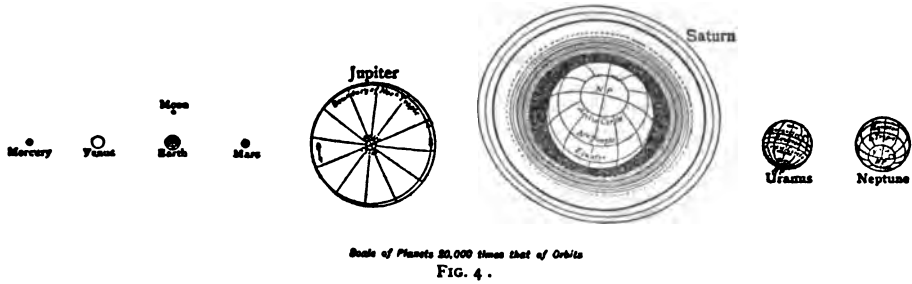
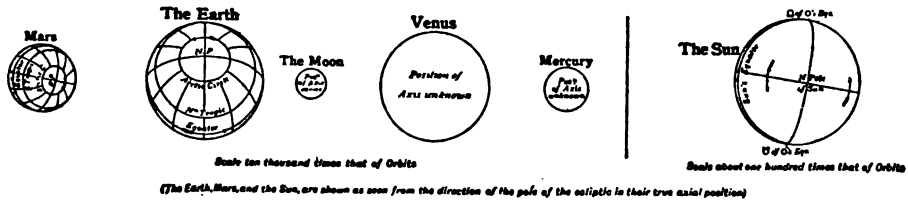
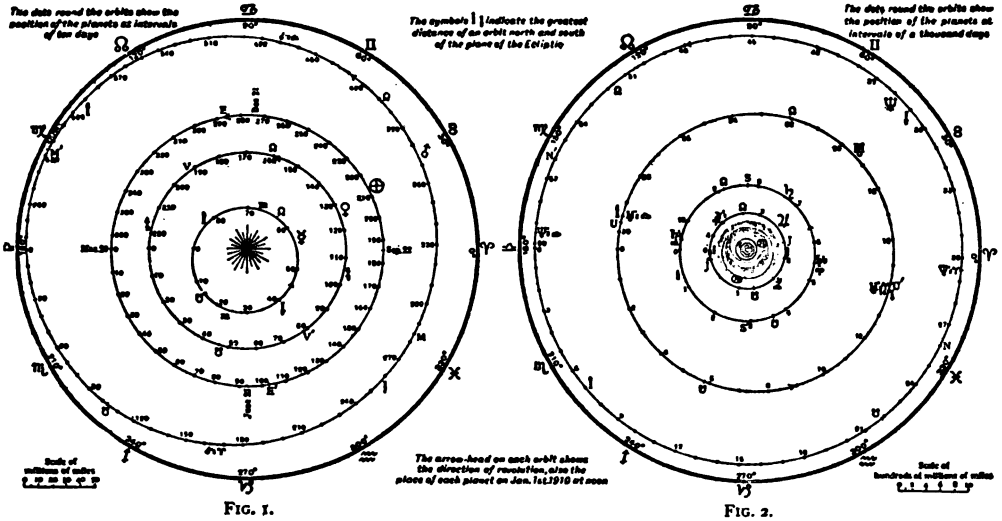

In the figures given above are shown the relative orbits of the planets, the orbits of Mars, the Earth, Venus and Mercury (fig. 1) being drawn to a scale twenty times that of the outer ones—Neptune, Uranus, Saturn, Jupiter (fig. 2). The positions of the planets at ten-day intervals; their actual position on the 1st of January 1910 at noon, of their nodes and nearer apses, and the points when they are farthest distant north and south of the ecliptic, are also given.

The relative sizes of the planets are also given, orientated in their true axial position with regard to the ecliptic. The nearer planets (and also the Moon) are separately compared (fig. 3); and then shown (on a smaller scale) in comparison with the more distant ones (fig. 4). Finally scale diagrams of the distances of the orbits of the satellite-systems of Saturn, Uranus, Jupiter and Neptune are given (fig. 5).

The phases of a superior planet are less strongly marked, because the lines from the planet to the earth and sun never increase to a right angle. The result is that although the apparent disk of Mars is sometimes gibbous in a very marked degree, it is always more than half illuminated. In the case of the other superior planets, from Jupiter outward, no variation in phase is perceptible even to telescopic vision. The entire disk always seems fully illuminated.

The most favourable time for viewing an inferior planet is near that of greatest brilliancy. As it recedes further from the earth, although a continually increasing proportion of its disk is illuminated by the sun, this advantage is neutralized by the diminution in its size produced by the increasing distance. When a superior planet is in opposition to the sun it rises at sunset and is visible all night. This is also the time when nearest the earth, and therefore when the circumstances are most favourable for observation.

The greater the distance of a planet from the sun the less is the speed with which it moves in its orbit. The orbit being larger, the time of its revolution is greater in a yet larger degree. An approximation to the general laws of speed in different planets is that the linear speed is inversely proportional to the square root of the mean distance. From this follows Kepler's third law, that the squares of the times of revolution are proportional to the cubes of the mean distances.

Notes on the Plate showing Planetary Spectra.

Only those lines and bands are mentioned which are peculiar to the planets; the Fraunhofer lines are therefore omitted.

Wave length.	Remarks.	
4600		Neptune.
4800	F hydrogen, H β strong.	Neptune, Uranus, Saturn (?)
5090		Neptune, Uranus.
5190 =	Broad.	Neptune, Uranus.
5370		Neptune, Uranus.
5430	Broad, unsymmetrical, strong.	Neptune, Uranus, Saturn, Jupiter.
5570 =		Neptune, Uranus (?).
5700 =	Broad, unsymmetrical, strong.	Neptune, Uranus, Saturn (?) Jupiter (?).
5980	Strong.	Neptune, Uranus.
6090		Neptune, Uranus.
6190	Very strong.	Neptune, Uranus, Saturn, Jupiter.
6400	Broad (?).	Neptune, Uranus.
6500 =		Neptune, Uranus, Jupiter, Saturn (?).
6560	C hydrogen, H α ,	Neptune, Uranus.
6670 =	Broad band.	Neptune, Uranus, Saturn, Jupiter.
[6780	Bright region due to absence of selective absorption which is strong both above and below.	Neptune, Uranus.
6820	Strong, narrow, near above B.	Neptune, Uranus, Saturn, Jupiter.
7020	Strong, broad.	Neptune, Uranus, Saturn, Jupiter.
[7140	Bright, unabsorbed region similar to that at 6780.	Neptune, Uranus.
7260	Strongest band present.	Saturn, Jupiter.
7500	Band (?).	Saturn.

It was once supposed that the planets were surrounded by comparatively dense atmospheres. The question whether such Spectra and is the case, and, if so, what is the physical constitution of the atmospheres, is a difficult one, on which little light is thrown except by the spectrocope. Atmospheres of the Planets. If any of these bodies is surrounded by a transparent atmosphere like that of the earth, the light which reaches us from it will have passed twice through this atmosphere. If the latter were materially different in its constitution from that of the earth, that fact would be made known by the spectrum showing absorption lines or bands different from those found in the solar spectrum as we observe it. If, however, the planetary atmosphere had the same composition as ours we should see only an intensification of the atmospheric lines, which might be imperceptible were the atmospheres rare.

Actual observation has thus far shown no well marked deviation in the spectra of any of the inner group of planets, Mercury, Venus and Mars, from the solar spectrum as we see it. It follows that any atmospheres these planets may have must, if transparent, be rare. The evidence in the cases of Venus and Mars is given in the articles on these planets. Taking the outer group of planets, it is found that the spectrum of Jupiter shows one or more very faint shaded bands not found in that of the sun. In Saturn these bands become more marked, and in Uranus and Neptune many more are seen. The spectra in question have been observed both optically and photographically by several observers, among whom Huggins, Vogel and Lowell have been most successful. It may be said, in a general way, that seven or eight well marked dark bands, as well as some fainter ones are observable in the spectra of the two outer planets. The general conclusion from this is that these planets are surrounded by deep and dense atmospheres, semi-transparent, of a constitution which is probably very different from that of the earth's atmosphere. But it has not, up to the present time, been found practicable to determine the chemical constitution of these appendages, except that hydrogen seems to be an important constituent. (See Plate.)

Intimately associated with this subject is the question of the conditions necessary to the permanence of an atmosphere round a planet. Dr Johnstone Stoney investigated these *Stability of conditions, taking as the basis of his work the Planetary kinetic theory of gases (Trans. Roy. Dubl. Soc. vi. Atmospheres. 305).* On this theory every molecule of a gaseous mass is completely disconnected from every other and is in rapid motion, its velocity, which may amount to one or more thousand feet per second, depending on the temperature and on the atomic weight of the gas. At any temperature the velocities of individual molecules may now and then increase without any well-defined limit. If at the boundary of an atmosphere the velocity should exceed a certain limit fixed by the mass and force of gravity of the planet, molecules might fly away through space as independent bodies. The absence of hydrogen from the atmosphere of the earth, and of an atmosphere from the moon, may be thus explained. If the fundamental hypotheses of Dr Stoney's investigations are correct and complete, it would follow that neither the satellites and minor planets of the solar system nor Mercury can have any atmosphere. If the separate molecules thus flying away moved according to the laws which would govern an ordinary body, they would, after leaving their respective planets, move round the sun in independent orbits. The possibility is thus suggested that the matter producing the zodiacal light may be an agglomeration of gaseous molecules moving round the sun; but several questions respecting the intimate constitution of matter will have to be settled before any definite conclusions on this point can be reached. It is not to be assumed that a molecule would move through the ether without resistance as the minutest known body does, and there is probably a radical difference between the minutest particle of meteoric matter and the molecule of a gas. The relations of identity or difference between such finely-divided matter as smoke and atmospheric haze and a true gas have yet to be fully established, and until this is done a definite and satisfactory theory of the subject does not seem possible.

Since the radiation of heat by a planet is, with our present instruments, scarcely capable of detection and measurement, the temperature of these bodies can be estimated *Temperature only from general physical laws.* The laws governing the radiation of heat have been so developed *of the Planets.* during recent years that it is now possible to state at least the general principle on which a conclusion as to the temperature of a planet may be reached. At the same time our knowledge of the conditions which prevail on other planets is so limited, especially as regards their atmospheres, that only more or less probable estimates of the temperature of their surfaces can even now be made. Summarily stated, some of the physical principles are these:—

1. A neutrally coloured body—understanding by that term

PLANET

PLATE I.

Planetary Spectra, photographed at Lowell Observatory, Flagstaff, Arizona,
By V. M. Slipher.

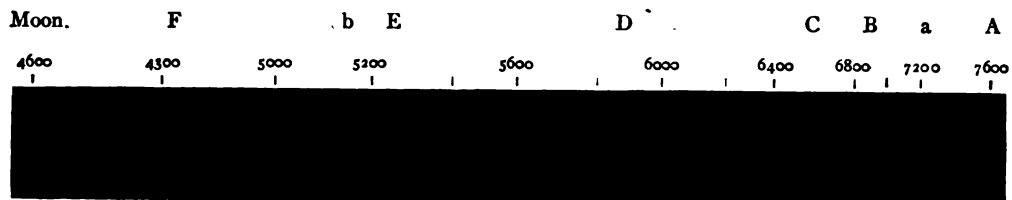

Jupiter.



Saturn.



Uranus.



Neptune.



Comparison spectograms of the Moon and Mars, showing absorption bands in that of the latter, which denote the presence of water vapour in the Martian atmosphere (see MARS).

Representative Stellar Spectra, photographed at Lowell Observatory, Flagstaff, Arizona, by V. M. Slipher.



Fig. 1. Orion Nebula.—Typical of the spectrum of the gaseous nebulae; contains bright lines of nebularium, hydrogen and helium. (The helium lines are too faint to show in this reproduction.)



Fig. 2. Rigel.—Typical of the helium star spectrum; contains, in addition to the helium series and so-called Orion lines, dark lines of hydrogen.



Fig. 3. Sirius.—The hydrogen type spectrum; contains dark hydrogen lines at their greatest strength and many fine metallic lines.



Fig. 4. Procyon.—Transition or hydrogen-to-solar type spectrum. The hydrogen lines are weaker, the metallic lines stronger, than in Sirius.

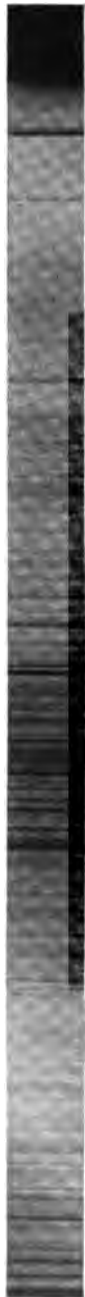

Fig. 5. Sun.—Hydrogen absorption fainter, metallic lines stronger and more numerous.



Fig. 5. Arcturus.—Advanced solar type spectrum.

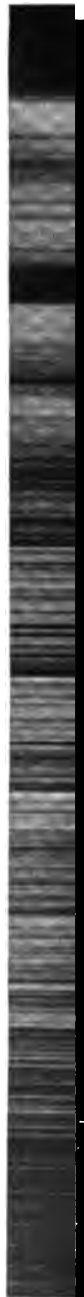

Fig. 7. Betelgeuse.—Typical of the spectrum partaking of the nature of that of the sun and that of the long period variable star exemplified in Fig. 8.

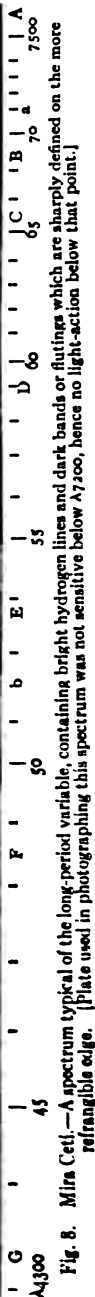
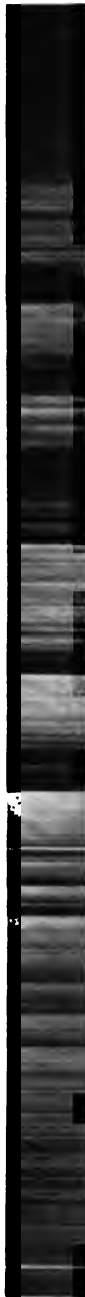

Fig. 8. Mira Ceti.—A spectrum typical of the long-period variable, containing bright hydrogen lines and dark bands or flutings which are sharply defined on the more refrangible edge. [plate used in photographing this spectrum was not sensitive below $\lambda 7200$, hence no light-action below that point.]

one which absorbs the same fraction of the thermal radiation falling upon it whatever the wave length of this radiation—exposed to the sun's radiation in void space tends to assume a definite temperature, called the normal temperature, the degree of which depends upon the distance of the body from the sun. This is a result of Kirchhoff's laws of radiation.

2. An atmosphere surrounding such a body, if at rest, will tend to assume a state of thermal equilibrium, in which the temperature will be the same at all heights.

3. If the atmosphere is kept in constant motion by an interchange between its higher and lower portions, the tendency is towards adiabatic equilibrium, in which the temperature diminishes at a constant rate with the height, until it may approach the absolute zero. The rate of diminution depends upon the intensity of gravity and the physical constants of the gases composing the atmosphere.

4. In the actual case of a planet surrounded by an atmosphere and exposed to the sun's radiation, the actual rate of diminution of temperature with height above the surface of the planet lies between the extreme limits just defined, the rate varying widely with the conditions. The general tendency will be towards a condition in which the temperature at the base of the atmosphere is higher than the normal, while in the upper regions it is lower. The temperature of the surface of the planet on which the atmosphere rests is determined partly by the sun's radiation and partly by the temperature of the air. What we should generally expect in the absence of any selective absorption by the air is that the temperature of the lower air would be higher than that of the material surface on which it rests. But this condition might be reversed by the effect of such absorption in either the air or the material of the planet.

ment. Something of this sort has been suspected in the case of Jupiter, which has several points of resemblance to the sun. The planets Uranus and Neptune which, but for their atmospheres, would approximate to the absolute zero in temperature, may be prevented from doing so by the dense atmosphere which the spectroscope shows around them.

A very elaborate investigation of the probable mean temperatures of the surfaces of the several planets has been made by J. H. Poynting, *Phil. Trans.* (vol. 202A, 1904).

Tables of Planetary Elements and Constants.

Table I. gives the elements determining the motions of each major planet, and Table II. certain numbers pertaining to its physical condition. For explanation of terms used see OABIT. The elements are given for the epoch 1900, Jan. 0, Greenwich mean time, except the mean longitudes, which are for 1910, Jan. 0.

In interpreting or using the numbers it must be remembered that only the mean distances and mean daily motions can be regarded as well determined and invariable quantities. The other elements are subject to a secular variation, and all vary more or less from the action of the planets. In Table II. the reciprocal of the mass is given, the mass of the sun being unity. Some of these and other quantities are extremely uncertain. This is especially the case with the mass of Mercury, which the astronomical tables put at 1/6,000,000 that of the sun, while G. W. Hill has computed from an estimate of the probable density of the planet that it is probably less than 1/11,000,000. In the table we assume the round number 1/10,000,000. The volumes are derived from microscopic measures of the diameters, which are more or less uncertain. From these and the mass follows the density of each planet. From this again is derived the intensity of gravity at the surface; this is also frequently uncertain. Finally the normal temperature is that which a black or neutrally coloured body would assume when every part of it is equally exposed to the sun's rays by a rapid revolution. As has already been intimated, the actual temperature may also depend upon the interior heat of the planet, which is an unknown quantity. (S. N.)

TABLE I.—Elements of the Orbits of the Eight Major Planets.

Planet.	Mean Distance from Sun.		Eccentricity of Orbit.	Longitude of Perihelion.	Longitude of Node.	Inclination.	Period of Revolution.	Mean Daily Motion.	Mean Longitude 1910, Jan. 0.
	Astronomical Units.	Thousands of Miles.							
Mercury . . .	0.3870987	36,000	0.205614	75° 54'	47° 9'	7° 0'	Days 87.969256	4° 0927	3° 32'
Venus . . .	0.7233315	67,269	0.006821	130° 10'	130° 10'	3° 24'	224.700798	1° 6021	73° 53'
Earth . . .	1.0000000	92,998	0.016751	101° 13'	—	—	365.256300	0° 9826	99° 17'
Mars . . .	1.523688	141,701	0.093309	334° 13'	48° 47'	1° 51'	686.979702	0° 52403	47° 39'
Jupiter . . .	5.202804	483,853	0.048254	123° 36'	99° 37'	1° 19'	4332.5879	0° 085091	181° 43'
Saturn . . .	9.538844	887,008	0.056061	90° 46'	113° 3'	2° 30'	10759.2010	0° 033460	285° 56'
Uranus . . .	19.190965	1,784,732	0.047044	169° 3'	73° 29'	0° 36'	30589.29	0° 011770	286° 47'
Neptune . . .	30.07067	2,796,528	0.008533	43° 45'	130° 41'	1° 47'	60187.65	0° 006020	107° 1'

TABLE II.—Physical Constants pertaining to the Major Planets.

Planet.	Angular Semidiameter		At Dist.	Diameter in Miles.	Reciprocal of Mass. (O's mass = 1)	Density.		Gravity at Surface. (⊙ = 1)	Orbital Velocity. Miles per sec.	Normal Temperature Centigrade.
	Equatorial.	Polar.				(Water = 1)	(⊕ = 1)			
Mercury . . .	3.30"	3.30"	1	2,976	10,000,000	3.5	.633	0.24	29.76	195°
Venus . . .	8.46"	8.46"	1	7,629	408,000	5.05	.913	0.880	21.77	70°
Earth . . .	8.79"	8.76"	1	7,917	333.430	5.53	1.000	1.00	18.52	10°
Mars . . .	4.80"	4.76"	1	4,316	3,093.500	3.68	.666	0.363	15.00	- 36°
Jupiter . . .	18.75"	17.65"	5.203	86,259	1,047.35	1.363	.247	2.68	8.12	-144°
Saturn . . .	8.75"	7.88"	9.539	72,772	3.500	0.678	.123	1.13	6.00	-177°
Uranus . . .	1.90"	1.90"	19.19	32,879	22.869	1.13	.204	0.85	4.24	-205°
Neptune . . .	1.10"	1.10"	30.07	29,827	19,314	1.79	.322	1.22	3.40	-218°

It would follow from these laws that the temperature of the superior planets diminishes rapidly with distance from the sun, and must therefore be far below that of the earth, unless they are surrounded by atmospheres of such height and density as to be practically opaque to the rays of heat, or unless they have no solid crust.

The resemblance of the spectra of Mars, Jupiter and Saturn to that of the sun leads to the conclusion that the atmospheres of these planets are transparent down to the reflecting surface of the body. The temperature of these surfaces must therefore be determined by Kirchhoff's law, unless they resemble the sun in being entirely liquid or gaseous, or in having only solid nuclei surrounded by liquid matter in a condition of continual move-

PLANETS, MINOR. The minor planets, commonly known as *asteroids* or *planetoids*, form a remarkable group of small planetary bodies, of which all the known members but three move between the orbits of Mars and Jupiter. Until recently they were all supposed to be contained within the region just mentioned; but the discovery of one, which at perihelion comes far within the orbit of Mars, and of two others, which at aphelion pass outside the orbit of Jupiter, shows that no well-defined limit can be set to the zone containing them. Before the existence of this group was known, the apparent vacancy in the region occupied by it, as indicated by the arrangement of the planets according to Bode's law, had excited remark and led to the belief that a planet would eventually be found there. Towards the

end of the 18th century the conviction that such a planet existed was so strong that an association of astronomers was formed to search for it. The first discovery of the looked-for planet was not, however, made by any member of this association, but by Giuseppe Piazzi of Palermo. On the 1st of January 1801 he noted a small star in Taurus, which, two days later, had changed its place, thus showing it to be a planet. Shortly after Piazzi's discovery the body was lost in the rays of the sun, and was not again seen until near the following opposition in 1801-1802. The orbit was then computed by C. F. Gauss, who found its mean distance from the sun to correspond with Bode's law, thus giving rise to the impression that the gap in the system was filled up. The planet received the name Ceres.

On the 28th of March 1802 H. W. M. Olbers (1758-1840) discovered a second planet, which was found to move in an orbit a little larger than that of Ceres, but with a very large eccentricity and inclination. This received the name of Pallas. The existence of two planets where only one was expected led Olbers to his celebrated hypothesis that these bodies were fragments of a larger planet which had been shattered by an internal convulsion; and he proposed that search should be made near the common node of the two orbits to see whether other fragments could be found. Within the next few years two other planets of the group were discovered, making four. No others were found for more than a generation; then on the 8th of December 1845 a fifth, *Astrea*, was discovered by K. L. Hencke of Driesen. The same observer added a sixth in 1847. Two more were found by J. R. Hind of London during the same year, and from that time discovery has gone on at an increasing rate, until the number now known is more than six hundred and is growing at the rate of thirty or more annually.

Up to 1800 discoveries of these bodies were made by skillful search with the telescope and the eye. Among the most successful discoverers were Johann Palisa of Vienna, C. H. F. Peters (1813-1890) of Clinton, New York, and James Craig Watson (1838-1880) of Ann Arbor, Michigan. In recent times the discoveries are made almost entirely by photography. When a picture of the stars is taken with a telescope moved by clockwork, so as to follow the stellar sphere in its apparent diurnal rotation, the stars appear on the plates as minute dots. But if the image of a planet is imprinted on the plate it will generally appear as a short line, owing to its motion relative to the stars. Any such body can therefore be detected on the plate by careful examination much more expeditiously than by the old method of visual search. The number now known is so great that it is a question whether they can be much longer individually followed up so as to keep the run of their movements.

Among the distinctive features of the planets of this group one is their small size. None exists which approaches either Mercury or the moon in dimensions. The two largest, Ceres and Juno, present at opposition a visible disk about 1" in diameter, corresponding to about 400 miles. The successively discovered ones naturally have, in the general average, been smaller and smaller. Appearing only as points of light, even in the most powerful telescopes, nothing like a measure of their size is possible. It can only be inferred from their apparent magnitude that the diameters of those now known may range from fifteen or twenty miles upwards to three or four hundred, the great majority being near the lower limit. There is yet no sign of a limit to their number or minuteness. From the increasing rate at which new ones approaching the limit of visibility are being discovered, it seems probable that below this limit the number of unknown ones is simply countless; and it may well be that, could samples of the entire group be observed, they would include bodies as small as those which form the meteors which so frequently strike our atmosphere. Such being the case, the question may arise whether the total mass of the group may be so great that its action on the major planets admits of detection. The computations of the probable mass of those known, based upon their probable diameter as concluded from the light which they reflect, have led to the result that their

combined action must be very minute. But it may well be a question whether the total mass of the countless unknown planets may not exceed that of the known. The best answer that can be made to this question is that, unless the smaller members of the group are almost perfectly black, a number great enough to produce any observable effect by their attraction would be visible as a faintly illuminated band in the sky. Such a band is occasionally visible to very keen eyes; but the observations on it are, up to the present time, so few and uncertain that nothing can positively be said on the subject. On the other hand, the faint "Gegenschein" opposite the sun is sometimes regarded as an intensification of this supposed band of light, due to the increased reflection of the sun's light when thrown back perpendicularly (see ZODIACAL LIGHT). But this supposition, though it may be well founded, does not seem to fit with all the facts. All that can be said is that, while it is possible that the light reflected from the entire group may reach the extreme limit of visibility, it seems scarcely possible that the mass can be such as to produce any measurable effect by its attraction.

Another feature of the group is the generally large inclinations and eccentricities of the orbits. Comparatively few of these are either nearly circular or near any common plane. Considering the relations statistically, the best conception of the distribution of the planes of the orbits may be gained by considering the position of their poles on the celestial sphere. The pole of each orbit is defined as the point in which an axis perpendicular to the plane intersects the celestial sphere. When the poles are marked as points on this sphere it is found that they tend to group themselves around a certain position, not far from the pole of the invariable plane of the planetary system, which again is very near that of the orbit of Jupiter. This statistical result of observation is also inferred from theory, which shows that the pole of each orbit revolves around a point near the pole of the invariable plane with an angular motion varying with the mean distance of the body. This would result in a tendency toward an equal scattering of the poles around that of Jupiter, the latter being the centre of position of the whole group. From this it would follow that, if we referred the planes of the orbit to that of Jupiter, the nodes upon the orbit of that planet should also be uniformly scattered. Examination, however, shows a seeming tendency of the nodes to crowd into two nearly opposite regions, in longitudes of about 180° and 330°. But it is difficult to regard this as anything but the result of accident, because as the nodes move along at unequal rates they must eventually scatter, and must have been scattered in past ages. In other words it does not seem that any other than a uniform distribution can be a permanent feature of the system.

A similar law holds true of the eccentricities and the perihelia. These may both be defined by the position of the centre of the orbit relative to the sun. If a be the mean distance and e the eccentricity of an orbit, the geometry of the ellipse shows that the centre of the orbit is situated at the distance ae from the sun, in the direction of the aphelion of the body. When the centres of the orbits are laid down on a diagram it is found that they are not scattered equally around the sun but around a point lying in the direction of the centre of the orbit of Jupiter. The statistical law governing these may be seen from fig. 1. Here S represents the position of the sun, and J that of the centre of the orbit of Jupiter. The direction JS produced is that of the perihelion of Jupiter, which is now near longitude 12°. As the perihelion moves by its secular variation, the line SJ revolves around S. Theory then shows that for every asteroid there will be a certain point A near the line SJ and moving with it. Let C be the actual position of the centre of the planetoid. Theory shows that C is in motion around A as a centre in the direction shown by the arrow, the linear eccentricity ae being represented by the line SC. It follows that e will be at a minimum when AC passes through S, and at a maximum when in the opposite direction. The position of A is different in the case of different planetoids, but is generally about two-thirds of the way from S to J. The lines AC for different bodies are at any time scattered miscellaneously around the region A as a centre. AC may be called the constant of eccentricity of the planetoid, while SC represents its actual but varying eccentricity.

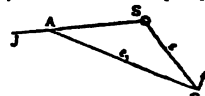

FIG. 1.

Grouping of the Planetoids.—A curious feature of these bodies is that when they are classified according to their distances from the sun a tendency is seen to cluster into groups. Since the mean distance and mean motion of each planet are connected by Kepler's third law, it follows that this grouping may also be described as a tendency toward certain times of revolution or certain values of the mean motion around the sun. This feature was first noticed by D. Kirkwood in 1870, but at that time the number of planetoids known was not sufficient to bring out its true nature. The seeming fact pointed out by Kirkwood was that, when these bodies are arranged in the order of their mean motions, there are found to be gaps in the series at those points where the mean motion is commensurable with that of Jupiter; that is to say, there seem to be no mean daily motions near the values $598''$, $748''$ and $898''$, which are respectively 2 , $2\frac{1}{2}$ and 3 times that of Jupiter. Such mean motions are nearly commensurable with that of Jupiter, and it is shown in celestial mechanics that when they exist the perturbations of the planet by Jupiter will be very large. It was therefore supposed that if the commensurability should be exact the orbit of the planet would be unstable. But it is now known that such is not the case, and that the only effect of even an exact commensurability would be a libration of long period in the mean motion of the planetoid. The gaps cannot therefore be accounted for on what seemed to be the plausible supposition that the bodies required to fill these gaps originally existed but were thrown out of their orbits by the action of Jupiter. The fact can now be more precisely stated by saying that we have not so much a broken series as a tendency to an accumulation of orbits between the points of commensurability. The law in question can be most readily shown in a graphical form. In fig. 2 the horizontal line represents distances from the sun,

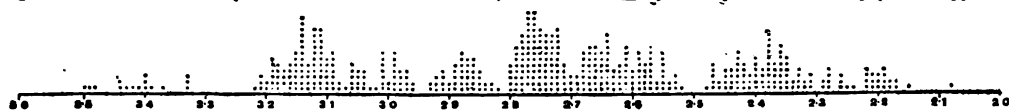

FIG. 2.

increasing toward the left, of which certain equidistant numerical values are given below the line. Points on the line corresponding to each 0.01 of the distances are then taken, and at each point a perpendicular line of dots is drawn, of which the number is equal to that of the planetoids having this mean distance, no account being taken of fractions less than 0.01. The accumulations between the points of close commensurability with the mean motion of Jupiter may be seen by inspection. For example, at the point 2.59 the mean motion is three times that of Jupiter; at the point 2.81 twice the mean motion is equal to five times that of Jupiter; at 3.24 the mean motion is twice that of Jupiter. It will be seen that there is a strong tendency toward grouping near the values 2.75, and a lesser tendency toward 3.1 and 2.4. It is probable that the grouping had its origin in the original formation of these bodies and may be plausibly attributed to the formation of three or more separate rings which were broken up to form the group.

Continuing the question beyond these large collections, it will be seen that between the values 3.22 and 3.33 there are no orbits at all. Then between 3.3 and 3.5 there are nine orbits. The space between 3.5 and 3.9 is thus far a complete blank; then there are three orbits between 3.90 and 3.95, not shown in the diagram.

A group of great interest, of which only three members are yet known, was discovered during the years 1906-1907. The mean distance of each member of this group, and therefore its time of revolution, is so near that of Jupiter that the relations of the respective orbits are yet unknown. The case thus offered for study is quite unique in the solar system, but its exact nature cannot be determined until several more years of observation are available.

Several planetoids of much interest are situated without the

limits of the groups shown in the figure. Eros is so near the sun, and its orbit is so eccentric, that at perihelion it is only about 0.16 outside the orbit of the earth. On those rare occasions when the earth is passing the perihelion point of the orbit at nearly the same time with Eros itself, the parallax of the latter will be nearly six times that of the sun. Measurements of parallax made at these times will therefore afford a more precise value of the solar parallax than can be obtained by any other purely geometrical measurement. An approach almost as close as the nearest geometrically possible one occurred during the winter of 1893-1894. Unfortunately the existence of the planet was then unknown, but after the actual discovery it was found that during this opposition its image imprinted itself a number of times upon the photographs of the heavens made by the Harvard Observatory. The positions thus discovered have been extremely useful in determining the elements of the orbit. The next near approach occurred in the winter of 1900-1901, when the planet approached within 0.32 of the earth. A combined effort was made by a number of observatories at this time to determine the parallax, both by micrometric measures and by photography. Owing to the great number of stars with which the planet had to be compared, and the labour of determining their positions and reducing the observations, only some fragmentary results of this work are now available. These are mentioned in the article PARALLAX. So far as can yet be seen, no other approach so near as this will take place until January 1931.

A few of the minor planets are of such special interest that some pains will doubtless be taken to determine their orbits and continue observations upon them at every available opposition. To this class belong those of which the orbits are so eccentric that they either pass near that of Jupiter or approach

near that of the earth. With most of the others little more can be done than to compute their elements with a view of subsequently identifying the object when desired. Unless followed up at several oppositions after discovery, the planet is liable to be quite lost. Of those discovered before 1890 about fifteen have not again been found, so that if discovered, as they doubtless will be, identification will be difficult.

The system of nomenclature of these bodies is not free from difficulty. When discoveries began to go on at a rapid rate, the system was introduced of assigning to each a number, in the order of its discovery, and using as its symbol its number enclosed in a circle. Thus Ceres was designated by the symbol (1); Pallas by (2), &c., in regular order. This system has been continued to the present time. When photography was applied to the search it was frequently doubtful whether the planet of which the image was detected on the plates was or was not previously known. This led to the use of capital letters in alphabetical order as a temporary designation. When the alphabet was exhausted a second letter was added. Thus there are planetoids temporarily designated as A, B, &c., and AB, AC, &c. The practice of applying a name to be selected by the discoverer has also been continued to the present time. Originally the names were selected from those of the gods or goddesses of classical mythology, but these have been so far exhausted that the name is now left to the discretion of the person selecting it. At present it is customary to use both the number and the name, the former being necessary to the ready finding of the planetoid in a list, while the name serves for more certain identification. (S. N.)

PLANK, a flat piece of timber, sawn and planed; it is technically distinguished from a "board" by its greater thickness, and should measure from 2 to 4 in. in thickness and from 16 to 11 in.

in width. The word comes through the Fr. *plouche* (from post-Augustan, Lat. *plouca*, a nasalized adaptation probably of Gr. $\pi\lambda\acute{\alpha}\xi$, something flat, especially a flat stone. The use of the word "plank" in the sense of an article in a political programme is of American origin and is due to the use of "platform" for the programme itself.

PLANKTON, a name invented by Professor Victor Hensen for the drifting population of the sea. This is a convenient heading under which to discuss not only *plankton* proper, but the *benthos*, or crawling population of the sea-bottom. Scientific investigation of these subjects dates from the reports of the "Challenger" expedition, which, despite its many successors, still stands out as the most important of the oceanographic expeditions, alike by the work achieved, the distance traversed, the time occupied, and the money devoted to the publication of the results. It laid the foundation of our knowledge of the physics and chemistry of ocean water, of oceanic and atmospheric currents, of the contour of the sea-bottom, and of the main features of distribution of deep-sea life. Later work has confirmed and expanded, but not revoked, the conclusions thus attained. But, in spite of this and of several subsequent expeditions, it cannot be pretended that we are in a position to formulate general canons of marine distribution other than of the most tentative character. Two fallacies underlie many attempts to define distributional oceanic areas for special groups: the one, that such areas can be made to bear some relation to existing geographical or even national divisions; the other, that what is true for one group of the animal kingdom must hold good equally for another. It is necessary at the outset to divest oneself of these errors, oceanic conditions depend only very indirectly upon the distribution of the land, and strongly swimming or freely floating animals are not to be confined by the same factors as determine the distribution of sessile forms, whose range is governed by a variety of circumstances.

As Wyville Thomson pointed out long ago, there is but one ocean. This surrounds the southern half of the globe, and has two large gulfs, generally called the Atlantic and Pacific Oceans, which meet through narrow channels in the small Arctic Ocean, and a half gulf, the Indian Ocean. The Atlantic and Pacific exhibit a striking homology of atmospheric pressure and of prevalent wind and current; the Indian, to a great extent, resembles the southern half of a larger one, but this resemblance is modified by the neighbourhood of vast land masses. The prevalent winds, dependent on the fairly constant distribution of atmospheric pressure over the great oceans, are the most important determinant of currents. As at most points in the ocean the temperature, salinity and chemical composition of the water are mainly determined by the currents—that is, by the condition at the place whence the water came—it is obvious that a study of currents must precede any general view of the distribution of marine forms.

Regard must be had not merely to the superficial currents indicated in fig. 1, but also to the movements of the deeper layer. Ice melting at the poles, together with polar precipitation of hail, snow and rain, yields large quantities of water of low salinity and very low temperature; this water sinks under the warmer saltier surface water drifted from lower latitudes, and, creeping slowly north and south from the poles, covers the bottom of all the great open oceans at very uniformly low temperatures (in some cases as low as 30° F.). Between surface and bottom the temperature gradually decreases (except where affected by local circumstances), and in the middle layers the existence of slow currents is suspected. The cold bottom water wells up to the surface in certain areas, replacing the surface water drained away by currents, notably to the westward of the great land masses. Ocean water is remarkably uniform as regards its contained salts and gases, and it does not seem likely that we can look to these to explain the facts of distribution. In its temperature, on the contrary, there is enormous variation. While the bottom water of the ocean is very cold, and the mid-water of a more or less intermediate temperature, the surface water, according as it has drifted from the equator polewards

or in the reverse direction, has a mean annual temperature somewhere between 84° and 30° F., losing or gaining heat on its way. In the case of narrow or "closed" seas, and near land masses, sea-water does not exhibit that uniformity of composition which characterizes the open ocean; but even in such cases the temperature is largely influenced by adjacent currents, and, though less obviously than in the open ocean, seems to be a very important agent in distribution.

The fauna of the sea is divisible into the *plankton*, the swimming or drifting fauna which never rests on the bottom (generally taken now to include E. Haeckel's *nekton*, the strong swimmers, such as fish and cephalopods), and the *benthos*, which is fixed to or crawls upon the bottom. These groups require a further subdivision according to depth—the more necessarily since, to some zoologists, any water over 100 fathoms is "deep" or even "abyssal." It is simplest to begin with the *benthos*. From

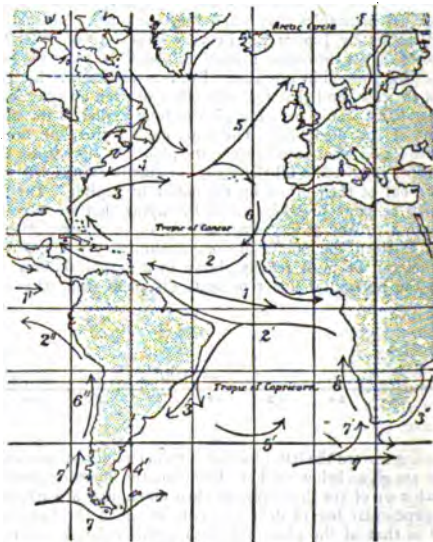

FIG. 1.—Diagram of the Atlantic Ocean, showing the Main Surface Currents (some are seasonal only); the corresponding Indian and Pacific currents are cited in parentheses; they are rarely so strongly marked as in the Atlantic.

1. Counterequatorial (also 1' Pacific and Indian)
2. North Equatorial (also Pacific).
- 2'. The Equatorial (also 2" Pacific and Indian).
3. Gulf Stream proper (Japan Stream).
- 3'. Brazil Current (Australian Current).
- 3". Mozambique Current (returved off Cape Agulhas).
4. Labrador Current (Kamchatka Current).
5. North Atlantic Drift, generally called Gulf Stream (North Pacific Drift).
- 5'. South Atlantic Drift, ill defined (South Pacific Drift).
6. North African Current (Mexico Current).
- 6'. Benguela Current.
- 6". Peru Current.
7. Antarctic Circumpolar Drift. 7', its northerly branches on the west sides of Africa and South America.

the shore seawards we may distinguish several zones. Even the tidal zone, between high and low water-mark, is subdivisible by its fauna and flora. There generally follows on this a very gentle slope to the depth of about 100 fathoms, locally subdivisible into many lesser zones. It has been termed the continental shelf or littoral zone, not very appropriately, since it occurs round many oceanic islands, and even away from any land. In this zone, if near land, fall to the bottom the heavy materials produced by land waste and river drainage. The fauna of this zone, generally very well characterized, may be

distinguished as the *epibenthos*. As with the shallowest or tidal zone, its nature varies much more according to latitude and the character of the coast than the deeper zones. Everywhere, however, the epibenthic fauna is exposed to certain definite environmental conditions, as compared with a deeper fauna: namely, a high or fairly high temperature (except near the poles); a fairly good light, with its important consequence, a vegetable basis of food supply; tide and current to distribute the larvae to a suitable habitat, which the varied nature of the bottom near land is likely to furnish. Passing farther seawards, we find a steeper slope to about the 500-fathom line, the so-called continental slope. In this zone the environment is absolutely

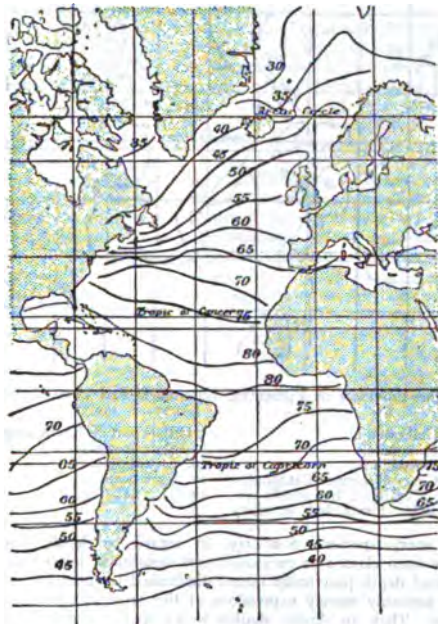

FIG. 2.—Mean Annual Surface Isotherms of the Atlantic. (After Buchan, "Challenger" Report on "Oceanic Circulation.") On the north-east and south-west sides they are deflected polewards by the warm North Atlantic Drift and Brazil Current; on the south-east and north-west sides equatorwards by the cold Labrador and Benguela Currents. Note the markedly different latitudes of the same isotherms east and west of South America and Africa; also the effect of the Falkland Current against the Brazil Current.

different. The water, no longer subject to seasonal variations of temperature, or to direct sunlight, is cold, and of a nearly uniform annual temperature (300 fathoms, = 44.7° F.). Light has disappeared from all but the shallower part, and with it plant life; tide and current are no longer felt. To the latter fact is due, however, a great part of the food supply, which maintains in this zone an abundant fauna: a great quantity of organic matter, brought down by river action, produced by disintegrated sea-weed, and due to the death of surface organisms, together with the finer clayey materials of land waste, settles to the bottom in quiet water, near the 100-fathom contour, thus making the *mud-line* the richest feeding-ground in the ocean (Murray). The mud-line is the real upper limit of this zone; it typically begins at about 100 fathoms, but may begin at 5 to 20 fathoms in deep sheltered bays, or be pushed down to 300 fathoms where currents are strong. The fauna of this zone may be termed the *mesobenthos*; it is not so abundant, nor so sharply characterized, as the epibenthos, and yet is sufficiently distinct to deserve at any rate a provisional name. Another

difference of condition between epibenthos and mesobenthos is the pressure of the water; at a depth of 500 fathoms this is, roughly speaking, half a ton to the square inch. It is very doubtful whether this enormous pressure makes the slightest difference to marine invertebrates, the tissues of which are uniformly permeated by fluids, so that the pressure is uniform in every direction; but animals with free gases naturally require time to adjust the gas-pressure when altering their levels. As regards the penetration of light, assimilative rays useful to plant life probably do not reach beyond 150 fathoms. Photographic rays have been detected as low as 220 fathoms, and if any light penetrate beyond this depth, it will consist only of blue, violet and ultra-violet rays: it has been suggested that the red colour prevalent in many deep-sea animals may be a screen from these hurtful rays. Below the 500-fathom line the ocean bottom exhibits almost uniform conditions everywhere, varied only by the character of the bottom deposit and the amount of food supply. In this zone, which extends from about 500 fathoms to the greatest depths (which may in some cases exceed 5000 fathoms, or more than 5½ m.), the temperature at any given point is uniform throughout the year, and is always very low: the mean at 2200 fathoms is 35.2° F.; at greater depths and in special circumstances less than 30° F. has been recorded. The darkness is probably absolute, for food the animals are dependent upon each other and upon the incessant rain of dead plankton from higher levels; the pressure may be anything between half a ton and five tons per square inch. To the fauna which lives in these remarkable circumstances the name *hypobenthos* may be applied.

That each of the three benthic groups is well characterized by a special fauna is shown by the following table, out of the total numbers of species captured by the "Challenger" at seventy stations in these three zones:—

	Species confined to this Zone.	Species occurring in other Zones.
Epibenthos . . .	91 %	8 %
Mesobenthos . . .	74 "	25 "
Hypobenthos . . .	61 "	38 "

Out of the 25% of its species which the mesobenthos shares with other zones, 59% occur also in the epibenthos, about 40% in the hypobenthos; the mesobenthos, therefore, on these figures, may be taken to consist of 74% of peculiar species, 15% shared with the epibenthos, 10% with the hypobenthos. Speaking of the benthos as a whole, it may be said that the following statement holds good: The number of individuals, the proportion of species to genera, and the number of individuals of a given species, all decrease with increasing depth. Animal life also tends to diminish with increasing distance from land; this may be partly due to the greater food supply near land, partly to the fact that population is obviously thinnest on the advancing fringe of a migration.

The plankton can be subdivided into at least two groups. The fauna to which light and warmth are more or less necessary, which feeds either upon plants or upon organisms nearly dependent upon plant life, may be termed the *epiplankton*. This fauna is capable of a good deal of vertical movement upwards and downwards, the causes of which are still obscure, but most of its members seem rarely to descend lower than about 100 fathoms. Below this depth the fauna may be called the *mesoplankton*. In every area this appears to have its peculiar species, but the careful study by opening and closing tow-nets of the distribution of the mesoplankton is of so recent a growth that no statistics, such as we have of the benthos, are available. It is now generally admitted that the mesoplankton extends to the lowest depths yet searched (2730 to 2402 fathoms, Valdivia); but the number of specimens decreases rapidly after 200 fathoms, and below 1000 fathoms very little is captured. The conditions of light, temperature, pressure, &c., are practically those of the corresponding depths of the benthos; as regards the food, however, the mesoplankton can only depend on intercepting dead organisms which are falling from higher horizons, or on capturing the scanty prey of its own zone. It is possible that the plankton immediately over the bottom may prove to be sufficiently distinct to be separately classed as *hypoplankton*.

The main subdivisions of the marine fauna having thus been briefly sketched, it is advisable to consider them in somewhat more detail. The *epibenthos* is obviously that fauna *Epibenthos*, to which, except in polar regions, light and warmth are necessary; and the absence of these at greater depths is

probably the chief barrier to its vertical extension; the food supply is sufficiently plentiful in, at any rate, the upper parts of the mesobenthic zone to present no obvious barrier. The chemical constitution of the water (except to animals in brackish water near river mouths) and the pressure appear to exert little or no influence; and only those species which attach themselves to clean hard substances would be repelled by the mud-line.

restrain. In relation to temperature the wide-ranging species are termed *eurythermal*, the limited, *stenothermal* (Möbius); the terms are useful to record a fact, but are not explanatory. It seems to be the case that to every organism is assigned a minimum temperature below which it dies, a maximum temperature above which it dies, and an optimum temperature at which it thrives best, but these have to be studied separately

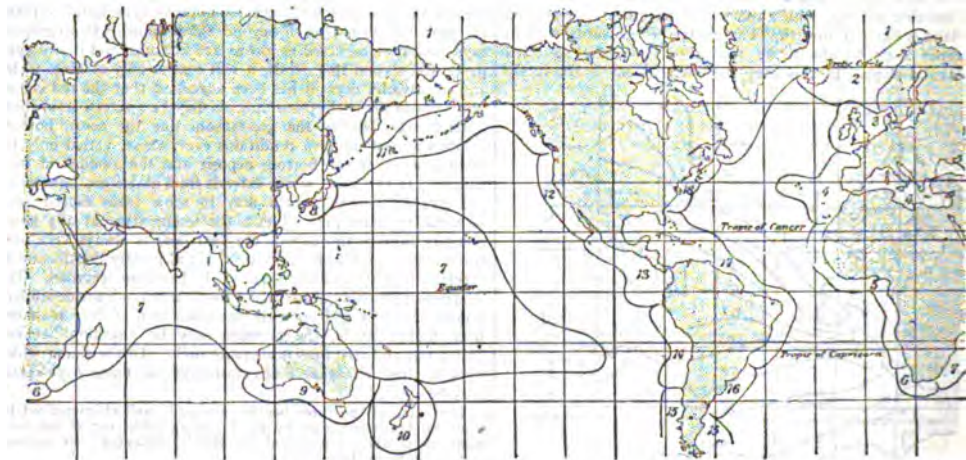

FIG. 3.—Diagram showing the Coastwise (not seaward) Extension of the Provinces of Epibenthic Gastropods and Lamellibranchs. Provinces:—

1. Arctic.
2. Boreal of East Atlantic.
- 2'. Boreal of West Atlantic.
3. Celtic.
4. Lusitanian.
5. West African.

6. South African
7. Indo-Pacific.
8. Japanese.
9. Australian.
10. New Zealand.
11. Aleutian.

12. Californian.
13. Panama.
14. Peruvian.
15. Generally termed Patagonian or Magellanic for purely epibenthic forms, but in many

- Orders part of the circumpolar Antarctic region.
16. Argentinian.
 17. Caribbean.
 18. Transatlantic.

The chief barrier to a horizontal extension of the epibenthos is undoubtedly temperature. As an example of its distribution may be taken the Gastropod and Lamellibranch Molluscs, as groups of which the distribution has been studied for many years by specialists. The shallow-water species fall into provinces (compare Cooke, *Camb. Nat. Hist.* vol. "Molluscs," ch. xii.), and a comparison of figs. 1 and 3 shows at once the profound influence upon them of the great currents. Taking the Atlantic Ocean, we find the Arctic species, tempted southwards by the cold Labrador Current, repelled northwards by the warm North Atlantic Drift. The Boreal or sub-Arctic species, many of which are identical on both sides of the ocean (2 and 2', fig. 3), lie much farther southwards on the west than on the east side, from the same causes. The warm-water molluscs of West Africa (5) are cut off from those of the east side (7) by the cold water from the great easterly Antarctic Drift, which impinges on the Cape, giving it a special fauna (6). On the South American coasts the tropical and temperate fauna reach respectively to 28° S. and 45° S. on the east coast, owing to the warm Brazil Current; but the corresponding groups on the west coast only to 5° S. and 37° S., being kept back by cold upwelling and Humboldt's Current. This influence is visible in individual species as well as in the facies of a fauna: *Purpura lapillus*, a temperate form, reaches on the east side of the Pacific to 24° N. and on the East Atlantic to 32° N.; but on the West Pacific only to 41° N. and the West Atlantic to 42° N., being repelled by the Japan stream (and other warm currents of the south-west monsoon) and Gulf Stream respectively.

But while some species may be confined to a bay, others to a province, others to an ocean, there are cosmopolitan species which either vertical or horizontal barriers, or both, fail to

for every species. Similarly, in regard to depth, species have been classed as *eurybathic* and *stenobathic*, but, since increased depth practically means diminished temperature, these are probably merely expressions of the same fact in another form. That an Arctic shallow-water species should stretch to considerable depths is not surprising, but it is remarkable to find such forms as, for example, *Venus mesodesma* on a New Zealand beach at 55° F. and in 1000 fathoms at 37° F. off Tristan d'Acunha. The provinces of zoological distribution, like the geographical divisions of mankind, must be taken merely to indicate the facies of a well-characterized fauna, not to imply the restriction of all its habitants to that area.

In considering the effect of temperature (and this applies to plankton as well as to benthos down to 100 fathoms), attention must be directed not only to the question of general warmth or cold as expressed by the mean annual temperature, but also to the range between the annual extremes: these ranges of variation have been carefully mapped by Sir J. Murray (*Geog. Journ.* xii. 113; compare *ibid.* xiv. 34). Still more important to the death-rate than these is the suddenness with which such variations occur: many animals are known to endure great extremes of heat and cold if exposed to them gradually, but to succumb to rapid alterations of temperature. Hence the frontier districts (*Mischgebiete*) between opposing currents are characterized by a heavy death-rate, and constitute marked barriers. A conspicuous instance of such a barrier in distribution is afforded at the Cape. The warm Mozambique Current, with a south-westerly direction off Natal, meets a north-east branch of the cold Antarctic Drift, and is beaten back eastwards: a result of the constant warring of these hot and cold currents is a high range of sudden temperature variation. Hence the Cape fauna

consists mainly of only such species from neighbouring provinces as can endure high sudden variations; and the district is practically impassable. For example, nineteen species of Echinoids are known from the Cape district. Of these twelve are peculiar to the Indo-Pacific province, which stretches from East Africa to the Sandwich Islands and from Japan to Australia; two species are Southern Ocean forms, all but confined to south of 40° S.; four species are peculiar to the Atlantic Ocean: of these eighteen not one gets past the Cape into the next province; the nineteenth is practically a cosmopolitan (A. Agassiz, "Challenger" Reports: "Echinoides"; compare also C. Chun, *Aus den Tiefen des Walmeeres*, pp. 157, 158).

Among the barriers to the horizontal extension of epibenthos must be mentioned a wide deep ocean. The Indo-Pacific fauna ranges from East Africa to about 108° W., stepping from island to island over the Pacific; but this continuity is then broken by 37 degrees of longitude and more than 2000 fathoms of water, and such sessile species as are most Mollusca (cf. fig. 3) are unable to reach the American coast. This is presumably due to the fact that the planktonic larvae of epibenthic adults must settle on a suitable bottom within a certain period or die. In spite of the direct set of the currents from Florida to the British Isles, the epibenthos of the two is absolutely dissimilar; the similarity of the two Boreal provinces (2 and 2', fig. 3) is to be assigned to a former continuity by way of Greenland, Iceland and Faeroe, a similar continuity, still unbroken, is exhibited by the Aleutian province on both sides of the Pacific. Though larvae cannot cross wide oceans, adults may no doubt traverse great stretches occasionally on floating timber, &c.

This barrier by distance may be instanced in another way. In the Arctic regions land masses are continuous or contiguous, and there are many circumpolar species, as, for example, *Rhynchonella psittacea*; towards the South Pole the southern continent is almost ice-bound, and the available land consists only of the tips of the continents and of the few oceanic islands. Hence few if any littoral species are circumpolar. For example, not a single littoral Ophiurid surrounds the South Pole, but five or six species are circumpolar in the northern hemisphere.

Taking next the *mesobenthos* and *hypobenthos*, living at depths where temperature is constant and current practically negligible, there appears theoretically to be no reason why an organism which can thrive at 500 fathoms should not have a world-wide range over the bottom of all oceans. Yet this is not often, although occasionally, known to be the case; and although perhaps, speaking generally, hypobenthic species have wider ranges than epibenthic, still they also seem to be limited. It must, however, be remembered that the ocean is large, deep hauls of trawl or dredge few, and individuals at great depths scattered, so that too much stress must not be laid on this point. The "Challenger" results seem to allow of at least one generalization—the deeper the fauna, the wider its range. This is shown by the following table of the "Challenger" benthos: the first column gives the number of benthos species captured at depths indicated in fathoms by the second column; the percentage of these species which is known to have been captured between the tropics, as well as south and north of the tropics, is shown in the third column:—

Number of Specimens	Horizon.	S. T. N.
4248	0-100	0.6
1887	100-500	3
616	500-1000	4
493	1000-1500	7
394	1500-2000	7
247	2000-2500	9
153	over 2500	9

We can only guess at the causes of the apparently limited range of many deep-sea types. (a) One of these is probably the limited food supply; presumably, as with a land fauna, there are as many mouths in a given area as it will support, and an equilibrium of species is maintained which will at least hinder the extension of any one. For food the bulk of the deep-water fauna

is dependent upon the rain of dead organisms falling from higher levels, these, slowly disintegrating (probably under chemical, not bacterial, action), seem to form with the bottom deposit a kind of nitrogenous ooze, through which many deep-sea organisms slowly swallow their way, as an earthworm goes through earth extracting nutriment. (b) Another hindrance to the extension of many deep-sea species is that they are *holobenthic*, that is, do not pass through a free-swimming larval stage; the means of dispersal is therefore regulated by the animal's own power of locomotion. Generally speaking, as might be expected, the freely-moving hypobenthos, fish and crustacea, have the widest ranges, and even these are not helped by currents, as are epibenthic or planktonic forms. The larval history of deep-water forms is, however, unfortunately obscure. (c) Lastly, extension of area of a species being at best difficult in deep water for non-swimmers, the place and date of their first migration must be taken into account; forms which have comparatively recently adopted deep-water life cannot be expected to have spread far from their original centre. As regards this point, in the first place, it is with migration, not with local evolution, that we have to deal: no classes and orders, only a few families and genera, rarely sub-orders, are peculiar to the hypobenthos; the deep members of each group consist for the most part of widely separated genera, the species do not grade into each other, as is so often the case in the epibenthos; and evolution could hardly have produced these species and genera under the uniformity of their present environment. This migration downwards from the mud-line has no doubt occurred all over the world, notably in the Southern Ocean, if we may judge by the richness of the deep-water fauna there to-day; probably also largely in Arctic and sub-Arctic regions, less so in tropical and temperate zones. As to the date of migration, the following fact seems to show that it is of comparatively recent origin, and is indeed still in progress: taking the "Challenger" species from the epibenthos, from the mesobenthos, and then from zones of 500 fathoms down to 2500, each zone shares a larger percentage of species with the zone above it than with that below it (except in one case where they are nearly equal). But it is not to be supposed that all our present-day deep-water forms began their migration simultaneously, and we can say with fair certainty that migration to deep water did not begin before the close of the Mesozoic epoch. Had it begun earlier, we should find typical Mesozoic and even older forms, or their congeners, at great depths: so far is this from being the case that the most venerable animals of to-day—*Lingula*, *Amphioxus*, *Limulus*, 75% of Crinoids, 90% of Brachiopoda, &c.—are epibenthic or mesobenthic. On the other hand, it is extremely likely that the Cretaceous epoch marked the commencement of migration. The hexactinellidan sponges are known to have lived in quite shallow water at the date of deposition of the Inferior Oolite; to-day none occur at a less depth than 95 fathoms; and as only two genera are known from the shallow Tertiary deposits, it would seem that the migration began about Cretaceous times ("Challenger" Reports: "Hexactinellida," F. E. Schulze). In 1881 (A. Agassiz, "Challenger" Reports: "Echinoides") 105 living genera of Echinoids were admitted; of these 23% were known from Cretaceous but not from Tertiary deposits, 35% from Tertiary but not Cretaceous, and 40% as Recent only. The species of Cretaceous genera constituted only 29% of the epibenthic Echinoids, 44% of the mesobenthic, and no less than 55% of the hypobenthic. These species of Cretaceous genera were distributed fairly evenly over all three zones, but 72% of the species of Tertiary genera and 55% of the Recent forms were confined to the epibenthos. As out of the twenty-five living genera known from the Cretaceous only seven are known also from Jurassic deposits, it is obvious that the close relationship is between Cretaceous and hypobenthos, rather than between any other geological and bathymetric horizons. Other instances, such as that of the Eryoniidae, seem to point to similar conclusions.

Excepting the essential air-breathers, practically every phylum and class and most orders are represented in the benthos. The

epibenthos of warm seas appears to be especially wealthy in such forms as secrete heavy calcareous skeletons; but in colder water, among the epibenthos of polar or sub-polar regions, and the hypobenthos everywhere in open oceans, the predominant forms are those which exhibit little or no calcareous secretion: even the apparent exceptions, Madreporaria and Echinoderma from great depths, tend to develop slighter skeletons than their warm-water congeners. The following table will serve to illustrate this point, and to give an idea of the composition of the epibenthos of cold and warm seas and of the hypobenthos: the figures are the percentages of total species captured in each locality by H.M.S. "Challenger," the balance being made up by few specimens in scattered groups:—

	Kerguelen Area—over 1260 fm.	Kerguelen Area—0 to 150 fm.	Cape York— 0 to 12 fm.	
Madreporaria	0.8	0.0	3.3	} Calcareous skeleton well developed.
Alcyonaria	1.2	1.0	3.3	
Shelled Mollusca	8.0	19.7	57.3	
Decapoda	3.6	0.8	8.1	
Echinodermata	33.6	11.7	7.9	
Actinaria	6.8	4.6	1.7	
Hydrozoa	6.8	8.0	0.9	
Annelida	16.5	25.0	7.6	
Crustacea except Decapoda	4.4	6.8	1.1	
Tunicata				
	81.7	77.6	91.2	

While the Madreporaria represent only 3.3% of the species at the tropical station, it must be remembered that they probably made up 80% or more of the weight.

The epiplankton is dependent either directly or proximately upon light, warmth and the presence of plant life. The wealth of minute organisms near the surface is inconceivable to those who have not seen the working of a two-net: it may be gauged by the fact that a single species is sometimes present in such quantities as to colour the sea over an appreciable area, and by the estimate that the skeletons of epiplankton from a square mile of tropical ocean a hundred fathoms deep would yield 16 tons of lime. In the tropics the wealth of species, and towards the poles the number of individuals of comparatively few species, are characteristic of the latitudes. In temperate and tropical regions there is a great difference between the epiplankton near land and that far out at sea: the former is termed *neritic*; it extends, roughly speaking, at least as far out as the mid-line, and is characterized by the predominance of what may be termed *hemibenthic* forms, that is, benthic forms with a planktonic larval stage (*Decapoda*, *Polychaeta*, &c.), or with a planktonic phase (metagenetic *Medusae*). The horizontal barriers to the neritic plankton are practically those mentioned as governing the epibenthos; indeed, it would seem that the distribution of hemibenthic adults is determined by that of their more delicate larvae. Special conditions of wind and current may of course carry into the neritic zone forms which are characteristic of the open sea, and vice versa. In the neritic epiplankton of polar waters the larvae of hemibenthic forms are almost absent; indeed, the development of cold-water benthos, whether shallow or abyssal, appears to be in most cases direct, this is, without a larval metamorphosis. The epiplankton of the open sea is described as *oceanic*; it consists almost entirely of *holoplanktonic* forms and their larvae. The chief barrier to horizontal distribution, here as elsewhere, is doubtless temperature. For example, through the reports of the "National" cruise (German Plankton Expedition) runs the same story; one fauna characterized their course from Shetland to Greenland and Newfoundland, another the traverse of the Gulf Stream, Sargasso Sea and the Equatorial Currents. The influence of temperature may be gauged in another way: where hot and cold currents meet, occur "frontier" districts, in which the respective organisms are intermingled, and can only exist till their maxima or minima are reached. Well-marked examples of such districts occur off New Jersey (Gulf Stream and Labrador Current), in

the China Sea (warm currents of the south-west monsoon and Kamchatka Current), in the Faeroe Channel, south of the Cape (recurring of the Agulhas Current): in some of these the range of variation amounts to as much as 50° F. in the year, with the result of a colossal death-rate of the plankton, and its corollary, a rich bottom fauna, for which food is thus amply supplied. The majority of the oceanic epiplankton appears to be stenothermal; for example, few components of the well-characterized fauna of the Gulf Stream and Sargasso Sea ever reach the British shores alive, although, if current and salinity were the determining factors and not temperature, this fauna should reach to Shetland, and even to Lofoten. It will only be possible to make satisfactory distributional areas for these oceanic forms by such systematic traverses as that of the "National"; at present it would seem that adjacent species have such different maxima and minima that every species must be mapped separately (compare the distribution-maps of the "National" Plankton Expedition). Some members of the epiplankton are, however, extraordinarily eurythermal and eurybathic; for example, *Calanus finmarchicus* ranges from 76° N. to 52° S. (excepting perhaps for 10° each side of the equator), and is apparently indifferent to depth.

In the first hundred fathoms at sea the fall of temperature is gradual and slight, and forms practically no hindrance to the diurnal oscillation of the oceanic epiplankton—the alleged rise and fall of almost the entire fauna. Roughly speaking, the greatest number of animals is nearest the surface at midnight; but different species sink and rise at different times, and to or from different depths. Apart from this diurnal oscillation, unfavourable conditions at the surface send or keep the fauna down in a remarkable way: for example, in the Bay of Biscay few organisms are to be found in the first fathom in bright sunlight, but on a still, hot day the next few fathoms teem with life; yet after a few minutes' wind or rain these upper layers will be found almost deserted. This leads to the consideration of the *hydrostatics* of the plankton: apart from strong swimmers, the majority contests the tendency to sink either by some means of diminishing specific gravity (increasing floating power) or by increased frictional resistance. The former is generally attained (a) by increase of bulk through development of a fluid secretion of low specific gravity (vacuoles of *Foraminifera*, *Radiolaria*, &c.); (b) or of a gelatinous secretion of low specific gravity (*Melissa*, *Chaetopod* and *Echinoderm* larvae, *Chaetognaths*, *Thaliacea*: the characteristic transparency of so many oceanic forms is probably attributable to this); (c) by secretion or retention of air or other gas (*Physalia*, *Minyas*, *Eudne*); (d) by development of oil globules (*Copepoda*, *Cladocera*, fish ova). Increased frictional resistance is obtained by flattening out of the body (*Phyllosoma*, *Sapphirina*), or by its expansion into lateral processes (*Tomopteris*, *Glaucus*), or by the development of long delicate spines or hairs (pelagic *Foraminifera*, many *Radiolaria*, many *Chaetopod* and *Decapod* larvae). In many cases two or more of these are combined in the same organism. Notwithstanding the above adaptations, some of which are adjustable, it is difficult to understand the mechanics of the comparatively rapid oscillations of the epiplankton, of which both causes and methods are still obscure.

It will be seen from the distribution of the Thecosomatus Pteropoda—a purely oceanic group—how difficult it will prove to draw distributional areas for classes of epiplankton. P. Felseener recognizes in all ten such provinces ("Challenger" Reports: "Zool.," xix., xxiii.) and 43 good species: of the latter 1 is confined to the Arctic, 4 to the Antarctic province, but of the remaining 37 species and eight provinces 30% occur in all eight, 16% in seven, and only 35% have as yet been captured in a single province only.

The mesoplankton has only received serious attention during the last few years. In the "Challenger," open nets towed at various depths seemed to show the existence of a deep-water plankton, but this method gives no certain information as to the horizon of capture, the nets being open in their passage down and up. C. Chan

constructed the first efficient net which could be opened and shut at known depths, using a propeller mechanism (*Bibl. Zool.* vol. 1.); and he improved his original pattern for the "National" and "Valdivia" expeditions. The present writer has devised a net, of which the opening and closing are effected from the deck by heavy weights; this has been used successfully on the "Siboga" expedition and in cruises of the "Research" (*Proc. Zool. Soc.*, 1898). W. Garstang has constructed an ingenious net which is useful in comparatively shallow water, but is open to criticism as being too light for depths beyond 100 fathoms; and several other types are in use. The existence of a mesoplankton, that is, of a plankton living between 100 fathoms from the surface and the bottom, has been generally considered as definitely proved by these nets. On the other hand, A. Agassiz, using the Tanner tow-nets, contends that while a mixture of surface and bottom species may occur in a closed sea near land, there is no intermediate fauna in the open ocean between about 200 fathoms from the surface and the bottom; his conclusions, based on negative evidence, have not met with general acceptance. Animals captured below the first hundred fathoms in the open sea (the Mediterranean, for special physical reasons, is on a special footing) are divisible into at least three categories: (1) those which are eurythermal and eurybathic, e.g. *Calanus finmarchicus*; (2) those which, so far as we know, are purely mesoplanktonic and never come to the surface, for example, the Radiolarian family *Tuscaroridae*; (3) those which, like some *Schizopoda*, spend a larval period in the epiplankton, and seek deeper water when adult, rising to the surface, if at all, only at night. But until the publication of the results of expeditions provided with efficient mesoplankton nets, generalizations about this fauna had better be stated with all reserve. There is, however, a certain amount of evidence to show that the mesoplankton includes different organisms in different latitudes; that surface animals of the north and south, unable to spread into the warmer surface water of lower latitudes, there sink into the cooler waters of the mesoplankton; the distributional area of such an organism will be in three dimensions bounded by isotherms (isobathytherms) and isothermobaths. As with the hypobenthos, there seems to be no theoretical reason against the universal distribution of the mesoplankton.

When a more systematic investigation of the various horizons has been carried out, many of the present cases of supposed discontinuous distribution will doubtless disappear. There are, however, undoubted cases of discontinuity where physical barriers have cut across a distributional area, an example of which may be cited here. The Isthmus of Panama was apparently only upraised about Miocene time, having been previously an archipelago through which a great circum-equatorial current could pass; consequently the benthos of the Panama region shows marked alliance with the Caribbean, with which it was formerly continuous, but practically none with the Indo-Pacific. To the same cause is doubtless attributable the distribution of the five Decapoda which are characteristic of the Sargasso Sea, which are circum-equatorial oceanic types, only occasionally littoral: three of these are known only from the Atlantic, one occurs in the Atlantic and Pacific, one in the Atlantic, Pacific and Indian Oceans. The damming of a great circum-equatorial current by the Isthmus of Panama is probably also responsible for that dislocation of currents which resulted in the present relations of the Gulf Stream and North Atlantic Drift to the Labrador Current, and cut the Atlantic Boreal fauna into two discontinuous districts (2 and 2', fig. 3).

Under the head of discontinuous distribution, the alleged phenomenon known as *bipolarity* must be mentioned. In summarizing the work of the "Challenger," Sir John Murray maintained on the basis of the reports that numerous species occurred in both polar and sub-polar areas which were absent from the tropic. He regarded them as the hardy survivors of a universal fauna which had withstood that polar cooling which set in towards the close of the Mesozoic period (Murray, *Trans. Roy. Soc. Edin.* vol. xxxviii., 1896; G. Pfeffer, *Verh. deutsch. Zool. Gesellsch.* ix. 1899). This view and the facts on which it was

based have been acutely contested, and the question is still far from settlement (for lists of the literature see A. E. Ortmann, *Am. Nat.* xxxiii. 583; and Miss E. M. Pratt, *Mem. Manchester Soc.* vol. xlv., 1901). As regards the purely epibenthic and sessile fauna, there are a few undoubted instances of actual specific identity; in some classes, however, such as the Echinoderms, this does not appear to hold (*Hamburger Magalhaensische Sommerreise*; and F. Römer and F. Schaudinn's *Fauna arctica*); but even in these the general composition of the fauna and the presence of certain identical and peculiar genera seem to point to something more than a mere "convergence" due to similar environment. As regards the plankton of the two polar regions and such epibenthic forms as extend also into deep water, the suggestion has been made that the Arctic and Antarctic benthos and plankton are really continuous by way of deep water in the main oceans, where the organisms can find a suitably low temperature. As an instance of this, C. Chun (*Bezieh. zwischen dem arkt. und antarkt. Plankton*, 1897) cites *Krokia hamata*, a characteristic Arctic and sub-Arctic constituent of the epiplankton and mesoplankton, known only from the mesoplankton in the tropics, but rising to 38 fathoms at 40° S. 26° E. More exact information, such as may be expected from the various Antarctic expeditions, is required to settle this interesting question with its far-reaching corollaries. (G. H. Fo.)

See also ZOOLOGICAL DISTRIBUTION: § *Marius*.

PLANQUETTE, ROBERT (1850-), French musical composer, was born in Paris on the 31st of July 1850, and educated at the Conservatoire. As a boy he wrote songs and operettas for café concerts, and sprang into fame as the composer of *Les Cloches de Corneville* (Paris, 1877; London, 1878). In this work he showed a fertile vein of melody, which won instant recognition. There is in his music a touch of pathos and romantic feeling, which, had he cared to cultivate it, would have placed him far above contemporary writers of *opéra bouffe*. Unfortunately, he did little but repeat the formula which originally brought him reputation. *Le Chevalier Gaston* was produced in 1879 with little success. In 1880 came *Les Voltigeurs du 32^m*, which had a long run in London in 1887 as *The Old Guard*, and *La Cantinière*, which was translated into English as *Nectarine*, though never produced. In 1882 *Rip van Winkle* was produced in London, being subsequently given in Paris as *Rip*, in both cases with remarkable success. The libretto, an adaptation by H. B. Farnie of Washington Irving's famous tale, brought out what was best in Planquette's talent. In 1884 the phenomenon of an opera by a French composer being produced in London previously to being heard in Paris was repeated in *Nell Gwynne*, which was tolerably successful, but failed completely when produced in Paris as *La Princesse Colombine*. It was followed by *La Crémillère* (Paris, 1885), *Surcouf* (Paris, 1887; London, as *Paul Jones*, 1889), *Captain Thérèse* (London, 1887), *La Cocarde tricolore* (Paris, 1892), *Le Talisman* (Paris, 1892), *Panurge* (Paris, 1895) and *Mam'zelle Quat'sous* (Paris, 1897).

PLANTAGENET, a surname conveniently, but unhistorically, applied to the royal line descended from the union of Geoffrey, count of Anjou, with the empress Maud, who are now styled by historians the Angevin house. It was, historically, only a personal nickname of Geoffrey, as was "Beaucerc" of his father-in-law (Henry I.) and "Curmantel" of his son (Henry II.), and was derived from his wearing in his cap a sprig of the broom (*genet*) plant, "which in early summer makes the open country of Anjou and Maine a blaze of living gold." When the fashion of personal nicknames passed away, the members of the royal house were usually named from their birthplace, as Thomas "of Brotherton," Thomas "of Woodstock," Edmund "of Woodstock," Edmund "of Langley," Lionel "of Antwerp," and so forth. But Edward I. and his younger brother, the founder of the house of Lancaster, had still nicknames respectively, as "Longshanks" and "Crouchback." In the later days of the dynasty the surname of Beaufort was adopted by the legitimated issue of John of Gaunt by Katherine Swynford, but that of Plantagenet was bestowed on Arthur, natural son

of Edward IV., who was created Viscount L'Isle. It appears, however, to have been adopted as a surname by Richard duke of York (father of Edward IV.) some twelve years before his death.

At the death of Geoffrey's grandson, Richard I., the succession was in doubt, John's elder brother Geoffrey having left, by the heiress of Brittany, a son and a daughter. But at that epoch the law of inheritance was in such a case unsettled, and their right was not clear. Arthur's fate is well known, and Eleanor, the daughter, was kept captive till her death in 1241. John's younger son Richard, king of the Romans, left a son Edmund, earl of Cornwall, with whom his line ended; his elder son Henry III. left two sons, of whom the younger was created earl of Lancaster and was grandfather of Henry, earl of Lancaster, whose heiress married John of Gaunt (s.e. Ghent). Edward I., the elder son, was grandfather of Edward III., the marriages of whose numerous children greatly affected English history. Edward his heir, the "Black Prince," left an only son, who succeeded his grandfather as Richard II., on whose death (1399) this line became extinct. Lionel, the next surviving brother of the Black Prince, left an only child Philippa, who married the earl of March, in whose heirs was the right to the succession. But John of Gaunt, the next brother, who had married the heiress of Lancaster and had been created duke of Lancaster in consequence, refounded the Lancastrian line, which obtained the throne in the person of his only son by her, Henry IV., on the deposition of Richard II., to the exclusion of the infant earl of March. His next brother, Edmund of Langley, who was created duke of York (1385), founded the Yorkist line, and was father, by a daughter and co-heiress of Pedro the Cruel, king of Castile, of two sons, Edward, second duke, who was slain at Agincourt, and Richard, earl of Cambridge, who by marrying the granddaughter and eventual heiress of Lionel's daughter Philippa, brought the right to the succession into the house of York.

Between their son and Henry VI. (grandson of Henry IV.) and Edward and Henry, sons and heirs of these rivals, was fought out the dynastic struggle known as "the Wars of the Roses," which proved fatal to several members of both houses. Richard, the son of Richard and Anne Mortimer, became third duke of York (1425), and was made protector of the realm 1454-1455, being finally declared heir to the throne on the triumph of his side in 1460; but he was slain at the battle of Wakefield (Dec. 31, 1460). Of his four sons, Edward, the eldest, became king as Edward IV. within three months of his death; Edmund, the second, was slain with his father at Wakefield; George, the third, duke of Clarence, was put to death in 1478; and Richard, the fourth, duke of Gloucester, became king as Richard III. in 1483 and was slain on Bosworth Field in 1485. King Edward IV.'s two surviving sons, Edward and Richard (the princes in the Tower), had been mysteriously put to death in 1483, so that the only male descendant of the house of York, and indeed of the whole Plantagenet race, was the duke of Clarence's son Edward, earl of Warwick (grandson of "the Kingmaker"), who was imprisoned by Richard III. (his father's younger brother) in 1483, and finally executed on Tower Hill, under Henry VII., in 1499.

Of the house of Lancaster, the only son of Henry VI. was slain after the battle of Tewkesbury (1471), while Edmund (Beaufort) duke of Somerset, a grandson of John of Gaunt, was slain at the first battle of St Albans (1455), and all his three sons were slain or beheaded. On the death of Henry VI. and his son in 1471, so complete was the extinction of their line that its representation vested in the heirs of the two daughters of John of Gaunt by the heiress of Lancaster, viz. Philippa queen of Portugal and Elizabeth countess of Huntingdon. But by his second wife, the heiress of Castile, John had left an only daughter, wife of Henry III., king of Castile and Leon, who also left descendants, and from his third but ambiguous union sprang the house of Beaufort, whose doubtful claims to his heirship passed with his great-granddaughter Margaret, by her husband Edmund Tudor, to their son Henry VII. Although Henry was careful to claim the crown in his own right (1485),

he soon fortified that claim by marrying Elizabeth, eldest daughter of Edward IV. and rightful heiress to the throne. The marriage of their eldest daughter Margaret to James IV. of Scotland in 1503 resulted in the accession of James VI. of Scotland, a century later, as next heir to the throne (see STEWART).

Although no other dynasty has reigned so long over England since the Norman Conquest, the whole legitimate male issue of Count Geoffrey Plantagenet is clearly proved to have become extinct in 1499. Of its illegitimate descendants the house of Cornwall was founded by Richard, a natural son of Richard, king of the Romans and earl of Cornwall, who was ancestor of Lord Cornwall of Fanhope, temp. Henry VI., of the Cornwalls, "barons of Burford," and other families; but the principal house is that which was founded, at a later date, by Sir Charles Somerset, natural son of Henry (Beaufort) duke of Somerset (beheaded 1464), who was created earl of Worcester in 1513, and whose descendant Henry, marquis and earl of Worcester, obtained the dukedom of Beaufort in 1682. From him descend the ducal house, who bear the ancient arms of France and England, quarterly, with a bordure. (J. H. R.)

PLANTAIN (Lat. *plantago*), a name given to certain plants with broad leaves. This is the case with certain species of *Plantago*, *Alisma* and *Musa*, to all of which the term is popularly applied. The species of *Plantago* are mostly weeds with a dense tuft of radical leaves and scapes bearing terminal spikes of small flowers; the long spikes of *P. major*, when in seed, are used for feeding cage-birds; *P. lanceolata*, so called from its narrow lanceolate 3-6-ribbed leaves, is popularly known as ribwort; *Alisma P.* is the water-plantain, so called from the resemblance of its broad ribbed aerial leaves to those of *P. major*. The tropical fruit known as plantain belongs to the genus *Musa* (see BANANA).

PLANTATION (Lat. *plantare*, to plant), literally the placing of plants in the ground, hence a place planted or a collection of growing things, &c., particularly used of ground planted with young trees. The term was early applied, in a figurative sense, to the settlement of people, and particularly to the colonization of North America in the early part of the 17th century and to the settlement of Scotch and English in the forfeited lands in Ireland (see below). The practice of sending convicted criminals to serve on the plantations in the colonies became common in the 17th century (see DEPORTATION). These plantations were chiefly in the cotton, sugar and tobacco growing colonies, and the term "plantation" is thus particularly applied to estates in tropical or semi-tropical countries; the proprietors of such estates are specifically styled "planters."

The negroes on the plantations of the Southern States of North America sang their songs and hymns and danced to tunes which were traditional, and are frequently known as "Plantation Songs." It has been claimed for some of them that they represent the folk songs brought by the first slaves from Africa; but the more generally accepted view is that they were those European hymn and song tunes which the negroes picked up from the revivalist preachers or from the Europeans around them, and adapted to their own strongly marked rhythms, which are certainly of African origin. The earliest song which became familiar to those outside the Southern States was "Jim Crow," sung by Dan Rice, and introduced to England about 1836. The "Jubilee Singers," a troupe from Fisk University, Nashville, Tennessee, toured the United States and Europe in 1871; but the great popularity of the negro songs and dances, and the traditional instruments, the bones and tambourine (the banjo was not originally used by the genuine negro), was due to the so-called "negro minstrel" troupes, of which the best known in England were Christy's, whence the generic name of Christy Minstrels, and later of the Moore and Burgess troupe at St James's Hall, London, started in 1862 and finally dissolved in 1904.

The best collection of genuine "plantation songs" and their words is *Slave Songs of the United States* (New York, 1871); see also

C. L. Edwards, *Bahama Songs and Stories* (Boston, 1895); J. B. T. Marsh, *The Story of the Jubilee Singers* (Boston, 1895); and articles by G. W. Cable on "The Creole Slave Dance" and "Creole Slave Songs," in the *Century*, February and April 1886.

Plantation of Ulster.—The Irish rebellion, which had disturbed Ulster during the closing years of Elizabeth's reign, was followed under James I. by further trouble, due partly to the inability of the English government to understand the system of land ownership prevalent in Ireland. At this time the chief offenders against the authority of England were the earls of Tyrconnell and Tyrone, but in September 1607 these once powerful nobles fled from the country. The English lawyers declared that the extensive estates which they held, not in their personal capacity, but as the heads respectively of the tribes of O'Neill and O'Donnell, had become the property of the English crown; and the problem which now confronted James I. and his advisers was what to do with the land, which was much too large to be cultivated properly by the scanty population living thereon. The idea of a plantation or colonization of Ulster, which was put forward as an answer to this question, is due mainly to Sir Arthur Chichester, the Irish lord deputy; its object was to secure the better cultivation of the land and to strengthen the English influence in Ulster by granting estates to English and Scottish settlers. Chichester proposed that the native inhabitants should be allowed to occupy as much land as they could cultivate, for he said, "that many of the natives in each county claim freehold in the lands they possess, and albeit these demands are not justifiable by law, yet it is hard and almost impossible to displant them." Even if this advice were carried out on a generous scale, the deputy considered that there would be abundance of land to offer to colonists, and also to reward the class of men known as servitors, those who had served the English king in Ireland. He submitted his ideas to Sir James Ley and Sir John Davies, two of the ministers of James I.; they reported to the English privy council, which signified its approval, and after the question had been illuminated by Bacon's great intellect, a committee was appointed to make the necessary arrangements. But those responsible for the plantation made one cardinal mistake, a mistake which was to cost the country much in the future. They rejected Chichester's idea of allotting land to the natives on a liberal scale, preferring to turn them out and to parcel out the whole of the forfeited district anew.

The forfeited lands lay in six counties, Tyrone, Donegal, Armagh, Fermanagh, Cavan and Coleraine (Londonderry), and the scheme for the plantation having been drawn up, the necessary survey began in May 1609. This was very inaccurate, but it served its purpose. The land was divided into three sections. One block was set apart for English and Scottish settlers, who were not to be allowed to have any Irish tenants; another was allotted to the servitors, who might have either English or Irish tenants; and a third was reserved for the Irish. Applications were then entertained from those willing to take up the land, and under Chichester's direction the settlement was proceeded with. The land was divided into portions of 1000, 1500 and 2000 acres, each colonist undertaking in return for his grant to build a castle or a walled enclosure, and to keep, train and arm sufficient men for its defence. Moreover he must take the oath of supremacy to James, and must not alienate his estate to an Irishman. He was given two years in which to do the necessary building; during this period he was freed from paying rent, but afterwards he must pay a quit-rent to the Crown. A scale of rents was drawn up, the native Irish paying at a higher rate than the English and Scottish settlers. Out of the forfeited lands provision was made for the maintenance of churches and schools, which were to be erected in conformity with the scheme.

The work progressed very slowly and much of the building was not even begun within the required time. Then in 1611 James I., who had from the first taken a lively interest in the plantation, sent Lord Carew to report on it. Carew's inspection did not reveal a very favourable condition of affairs, and in

1615 Sir Josiah Bodley was sent to make a further report about the progress of the work. A third report and survey was made three years later by Nicholas Pynnar, who found in the six counties 1974 British families, with 6215 men capable of bearing arms. He said that even on the lands occupied by the colonists the cultivation of the soil was still very much neglected. The words spoken by Bacon in 1617 with reference to the plantation had come true. "Take it from me," he said, "that the bane of a plantation is when the undertakers or planters make such haste to a little mechanical present profit, as disturbeth the whole frame and nobleness of the work for times to come." Another survey took place in 1622, when various changes were suggested, but no serious alterations were made. On the whole the plantation had been a failure. Very few of the settlers had carried out their undertaking. In many cases the Irish had remained on the land allotted to the colonists, living under exactly the same conditions as they had done before the plantation, and holding on "whether the legal landlords liked it or not." As actually carried out the plantation dealt with 511,465 acres. Two-fifths of this was assigned to British colonists, being divided about equally between Englishmen and Scotchmen. Rather more than one-fifth went to the Church and about the same amount to the servitors and the natives. The best settlers were the Scots, although their tendency to marry with the Irish was noted and condemned during the early years of the settlement.

An important part of the plantation was the settlement of the county of Coleraine by the corporation of the city of London. Receiving a grant of practically the whole of the county the corporation undertook to spend £30,000, and within two years to build 200 houses in Derry and 100 in Coleraine. This was the most successful part of the settlement, and to it Londonderry owes its present name.

The expulsion of the Irish from the land in which by law and custom they had a certain proprietary and hereditary right, although not carried out on the scale originally contemplated, naturally aroused great indignation among them. Attacks on the settlers were followed by reprisals, and the plantation may fairly be regarded as one of the causes which led to the terrible massacre in Ulster in 1641. During Elizabeth's reign a scheme for the plantation of Munster was considered, and under Charles I. there was a suggestion for the plantation of Connaught, but eventually both were abandoned.

The "Orders and Conditions of Plantation" are printed in Walter Harris's *Hibernica* (Dublin, 1770); and in George Hill's *Historical Account of the Plantation in Ulster, 1608-1620* (Belfast, 1877). See also S. R. Gardiner, *History of England* (1899), vol. i.; and R. Bagwell, *Ireland under the Stuarts* (1909); vol. i.

PLANTIN, CHRISTOPHE (1514-1589), French printer, was born in a village near Tours (probably Saint-Avertin). He learned bookbinding and bookselling at Caen, and, having married in that town, settled in 1549 as bookbinder in Antwerp, where he was soon known as the first in his profession. A bad wound in the arm seems to have been the cause that first led him (about 1555) to apply himself to typography. The first known book printed in his office was *La Institutione di una fanciulla nata nobilmente*, by J. M. Bruto, with a French translation, and this was soon followed by many other works in French and Latin, which in point of execution rivalled the best printing of his time, while the masters in the art of engraving then flourishing in the Netherlands illustrated many of his editions. In 1562, Plantin himself being absent in Paris, his workmen printed an heretical pamphlet, which caused his movables to be seized and sold. It seems, however, that he recovered a great deal of the money, and in 1563 he associated himself with some friends to carry on his business on a larger scale. Among them were two grand-nephews of Dan. Bomberg, who furnished him with the fine Hebrew types of that renowned Venetian printer. His editions of the Bible in Hebrew, Latin and Dutch, his *Corpus juris*, Latin and Greek classics, and many other works produced at this period are renowned for their beautiful execution and accuracy. A much greater enterprise

was planned by him in those years—the publication of a *Biblia polyglotta*, which should fix the original text of Old and New Testaments on a scientific basis. In spite of clerical opposition he was supported by Philip II. king of Spain, who sent him the learned Benedictus Arias Montanus to take the leading part in the work of editorship. With his zealous help the work was finished in five years (1569–1573, 8 vols. folio). Plantin earned little profit, but received the privilege of printing all liturgical books for the states of King Philip, and the office of "prototypographus regius." Though outwardly a faithful son of the church, he was till his death the partisan of a mystical sect of heretics; and it is now proved that many of their books published without the name of a printer came from his presses together with the missals, breviaries, &c., for the Roman Catholic Church.

Besides the polyglot Bible, Plantin published in those years many other works of note, such as editions of St Augustine and St Jerome, the botanical works of Dodonæus, Clusius and Lobelius, the description of the Netherlands by Guicciardini, &c. In 1575 his printing-office reckoned more than twenty presses and seventy-three workmen, besides a similar number that worked for the office at home. But in November 1576 the town was plundered and in part burnt by the Spaniards, and Plantin had to pay an exorbitant ransom. He established a branch of his office in Paris; and when in 1583 the states of Holland sought a typographer for the newly erected university at Leiden, he left his much reduced business in Antwerp to his sons-in-law John Moerentorf (Moretus) and Francis van Ravelinghen (Raphelengius), and settled there. When in 1585 Antwerp was taken by the prince of Parma and affairs became there more settled, he left the office in Leiden to Raphelengius and returned to Antwerp, where he laboured till his death on the 1st of July 1589. His son-in-law, John Moretus, and his descendants continued to print many works of note "in officina Plantiniana," but from the second half of the 17th century the house began to decline. It continued, however, in the possession of the Moretus family, which religiously left everything in the office untouched, and when in 1876 the town of Antwerp acquired the old buildings with all their contents, for 1,200,000 francs, the authorities were able with little trouble to create one of the most remarkable museums in existence (the Musée Plantin, opened August 19, 1877).

See Max Rooses, *Christophe Plantin imprimeur anversois* (Antwerp, 1882); Aug. de Backer and Ch. Ruelens, *Annales de l'imprimerie Plantinienne* (Brussels, 1865); DeGeorge, *La Maison Plantin* (2nd ed., Brussels, 1878). (P. A. T.)

PLANTS. In the most generally used sense, a plant is a member of the lower or vegetable order of living organized things; the term is also popularly applied to the smaller herbaceous plants, thus excluding trees and shrubs. The early use of the word is for a twig, shoot, cutting or sapling, which was the meaning of Lat. *planta* (for *planctia*, the root being that seen in *planus*, flat, cf. Gr. *πλατεις*, broad; *planta* thus meant a spreading shoot or sucker). Other meanings of "plant" are derived from the verb "to plant" (Lat. *plantare*, to fix in position or place). It is thus used of the fixtures, machinery, apparatus necessary for the carrying on of an industry or business, and in colloquial or slang use, of a swindle, a carefully arranged plot or trap laid or fixed to deceive; cf. also PLANTATION. In the following sections the botanical sense of the word is followed, the term being used generally as opposed to "animals."

CLASSIFICATION OF PLANTS

Some account of the history of plant classification and the development of a natural system in which an attempt is made to show the actual relationships of plants, is given in the article BOTANY. The plant world falls into two great divisions, the higher or flowering plants (*Phanerogams*), characterized by the formation of a seed, and the lower or flowerless plants (*Cryptogams*), in which no seed is formed but the plants are disseminated by means of unicellular bodies termed spores. The term

Cryptogam is archaic, implying a hidden method of reproduction as compared with the obvious method represented by the flower of the Phanerogam; with the aid of a good microscope it is, however, easier to follow the process of fertilization in many Cryptogams than in the flowering plants. These two great divisions are moreover of unequal value, for the Cryptogams comprise several groups differing from each other by characters as marked as those which separate some of them from the Phanerogams. The following groups or sub-kingdoms are those which are now generally recognized:—

Cryptogams	{	I. Thallophyta.
		II. Bryophyta.
		III. Pteridophyta.
		Phanerogams or IV. Spermatophyta.

Thallophyta are the most lowly organized plants and include a great variety of forms, the vegetative portion of which consists of a single cell or a number of cells forming a more or less branched thallus. They are characterized by the absence of that differentiation of the body into root, stem and leaf which is so marked a feature in the higher plants, and by the simplicity of their internal structure. Both sexual and asexual reproduction occur, but there is usually no definite succession of the two modes marking that alternation of sexual generation (gametophyte) and asexual generation (sporophyte) which characterizes the higher groups. The group has until recent years been regarded as comprising three classes distinguished by well-marked physiological features—the Algae (including the Seaweeds) which contain chlorophyll, the Fungi which have no chlorophyll and therefore lead a saprophytic or parasitic mode of life, and the Lichens which are composite organisms consisting of an alga and a fungus living together in a mutual parasitism (symbiosis); Bacteria were regarded as a section of Fungi. Such a system of classification, although convenient, is not the most natural one, and a sketch of the system which better expresses the relationships between the various subdivisions is given here. It has, however, been deemed advisable to retain the older groups for purpose of treatment in this work, and articles will be found under the headings ALGAE, FUNGI, BACTERIA, and LICHENS. The study of phylogeny has suggested fourteen classes arranged in the following sequence: (1) Bacteria; (2) Cyanophyceae (Blue-green algae); (3) Flagellatae; (4) Myxomycetes (Slime-fungi); (5) Peridinea; (6) Conjugatae; (7) Diatomaceae (Diatoms); (8) Heterocontae; (9) Chlorophyceae (Green Algae); (10) Characeae (Stoneworts); (11) Rhodophyceae (Red Algae); (12) Eumycetes (Fungi); (13) Phycomycetes (Algal fungi); (14) Phaeophyceae (Brown Algae). Bacteria (see BACTERIOLOGY) and Cyanophyceae (see ALGAE), which are often grouped together as Schizophyta, are from points of view of both structure and reproduction extremely simple organisms, and stand apart from the remaining groups, which are presumed to have originated directly or indirectly from the Flagellatae, a group of unicellular aquatic organisms combining animal and plant characteristics which may be regarded as the starting-point of unicellular Thallophytes on the one hand and of the Protozoa on the other. Thus simple forms included in the Heterocontae, Chlorophyceae and Phaeophyceae show an obvious connexion with the Flagellatae; the Peridinea may be regarded as a further developed branch; the Conjugatae and Diatomaceae cannot be directly connected; the origin of the Rhodophyceae is also obscure; while the Characeae are an advanced and isolated group (see ALGAE). The Mycetozoa (*g.p.*) or Myxomycetes are a saprophytic group without chlorophyll, of simple structure and isolated position. The algal fungi, Phycomycetes, are obviously derived from the Green Algae, while the remaining Fungi, the Eumycetes, appear to have sprung from the same stock as the Rhodophyceae (see FUNGI). Owing to the similarity of structure and mode of life it is convenient to treat the Lichens (*g.p.*) as a distinct class, while recognizing that the component fungus and alga are representatives of their own classes.

The *Bryophyta* and *Pteridophyta* have sprung from the higher Thallophyta, and together form the larger group Archegoniatae, so-called from the form of the organ (*archegonium*) in which the egg-cell is developed. The Archegoniatae are characterized by a well-marked alternation of gametophyte and sporophyte generations; the former bears the sexual organs which are of characteristic structure and known as antheridia (male) and archegonia (female) respectively; the fertilized egg-cell on germination gives rise to the spore-bearing generation, and the spores on germination give rise directly or indirectly to a second gametophyte.

The Mosses and Liverworts (see BRYOPHYTA) include forms with a more or less leaf-like thallus, such as many of the liverworts, and forms in which the plant shows a differentiation into a stem bearing remarkably simple leaves, as in the true mosses. They have no true roots, and their structure is purely cellular or conducting bundles of a very simple structure are present. The independent plant which is generally attached to the soil by hair-like structures is the sexual generation, the sporophyte is a stalked or sessile capsule

which remains always attached to the gametophyte from which it derives the whole or part of its nourishment.

The Ferns and fern-like plants (see PTERIDOPHYTA) have on the other hand a well developed independent sporophyte which is differentiated into stem, leaf and root with highly organized internal structure including true vascular bundles. In general structure they approach the Phanerogams with which they form collectively the Vascular Plants as contrasted with the Cellular Plants—Thallophyta and Bryophyta. The gametophyte is a small thalloid structure which shows varying degrees of independence affording an interesting transition to the next group.

Spermatophyta are characterized by an extreme reduction of the gametophyte generation. The sporophyte is the plant which is differentiated into stem, leaf and root, which show a wonderful variety of form; the internal structure also shows increased complexity and variety as compared with the other group of vascular plants, the Pteridophyta. The spores, as in the heterosporous Pteridophyta, are of two kinds—microspores (pollen grains) borne in microsporangia (pollen sacs) on special leaves (sporophylls) known as stamens, and macrospores (embryo-sac) borne in macrosporangia (ovules) on sporophylls known as carpels. The fertile leaves or sporophylls are generally aggregated on special shoots to form flowers which may contain one or both kinds. The microspores are set free from the sporangium and carried generally by wind or insect agency to the vicinity of the macrospore, which never leaves the ovule. The male gametophyte is represented by one or few cells and, except in a few primitive forms where the male cell still retains the motile character as in the Pteridophyta, is carried passively to the macrospore in a development of the pollen grain, the pollen tube. The Spermatophyta are thus land plants *par excellence* and have, with the few exceptions cited, lost all trace of an aquatic ancestry. Aquatic plants occur among seed plants but these are readaptations of land plants to an aquatic environment. After fertilization the female cell, now called the oospore, divides and part of it develops into the embryo (new sporophyte), which remains dormant for a time still protected by the ovule which has developed to become the seed. The seed is a new structure characteristic of this group, which is therefore often referred to as the Seed-plants. The seed is set free from the parent plant and serves as the means of dissemination (see FLOWERS; POLLINATION; FRUIT, and SEED). The Spermatophyta fall into two classes, Gymnosperms (g.s.) and Angiosperms (g.p.); the former are the more primitive group, appearing earlier in geological time and showing more resemblance in the course of their life-history to the Pteridophyta. A recently discovered fossil group, the Pteridospermae (see PALAEOBOTANY) have characters intermediate between the Pteridophyta and the more primitive seed-plants.

In GYMNOSPERMS—so called because the ovules (and seeds) are borne on an open sporophyll or carpel—the microsporangia and macrosporangia are not as a rule associated in the same shoot and are generally arranged in cone-like structures; one or two small prothallial cells are formed in the germination of the microspore; the male cells are in some older members of the group motile though usually passive. The ovule is not enclosed in an ovary, and the usually solitary macrospore becomes filled with a prothallus, in the upper part of which are formed several rudimentary archegonia. The fertilized egg-cell (oospore) forms a filamentous structure, the proembryo, from a restricted basal portion of which one or more embryos develop, one only as a rule reaching maturity. The embryo consists of an axis bearing two or more cotyledons and ending below in a radicle; it lies in a generally copious food-storing tissue (endosperm) which is the remains of the female prothallus. The plant has a well-developed main root (tap-root) and a single or branched leafy stem which is provided with a means of secondary increase in thickness. The leaves are generally tough-skinned and last for more than one season.

The ANGIOSPERMS, which are much the larger class, derive their name from the fact that the carpel or carpels form a closed chamber, the ovary, in which the ovules are developed—associated with this is the development of a receptive or *stigmatic* surface on which the pollen grain is deposited. The sporophylls (stamens and carpels) are generally associated with other leaves, known as the perianth, to form a flower; these subsidiary leaves are protective and attractive in function and their development is correlated with the transport of pollen by insect agency (see ANGIOSPERMS; POLLINATION, and FLOWER). The male gametophyte is sometimes represented by a transitory prothallial cell; the two male cells are carried passively down into the ovary and into the mouth of the ovule by means of the pollen-tube. The female gametophyte is extremely reduced; there is a sexual apparatus of naked cells, one of which is the egg-cell which, after fusion with a male cell, divides to form a large "suspensorial" cell and a terminal embryo. Endosperm is formed as the result of the fusion of the second male cell with the so-called "definitive nucleus" of the embryo-sac (see ANGIOSPERMS). The embryo consists of an axis bearing one (Monocotyledons) or two (Dicotyledons) cotyledons, which protect the stem bud (*plumule*) of the future plant, and ending below in a radicle. The seed is enclosed when ripe in the fruit, a development of the ovary as a result of fertilization of the egg-cell. (A. B. R.)

ANATOMY OF PLANTS

The term "Anatomy," originally employed in biological science to denote a description of the facts of structure revealed on cutting up an organism, whether with or without the aid of lenses for the purposes of magnification, is restricted in the present article, in accordance with a common modern use, to those facts of internal structure not concerned with the constitution of the individual *cell*, the structural unit of which the plant is composed.

An account of the structure of plants naturally begins with the cell which is the proximate unit of organic structure. The cell is essentially an individualized mass of protoplasm containing a differentiated protoplasmic body, called a *nucleus*. But all cells which are permanent tissue-elements of the plant-body possess, in addition, a more or less rigid limiting membrane or *cell-wall*, consisting primarily of cellulose or some allied substance. It is the cell-walls which connect the different cells of a tissue (see below), and it is upon their characters (thickness, sculpture and constitution) that the qualities of the tissue largely depend. In many cases, indeed, after the completion

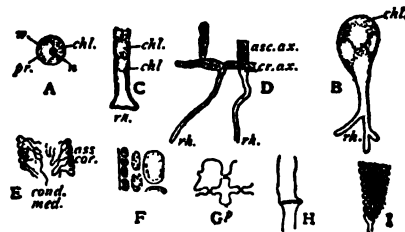

FIG. 1.—Examples of the differentiation of the cells of plants.

A, Cell (individual) of the unicellular Green Alga *Pleurococcus*, as an example of an undifferentiated autonomous assimilating cell. *pr.*, Cell protoplasm; *n.*, nucleus; *chl.*, chloroplast; *c.w.*, cell-wall.

B, Plant of the primitive Siphonous Green Alga *Protosiphon botryoides*. The primitive cell sends colourless tubelets (rhizoids, *rh.*) into the mud on which it grows. The subaerial part is tubular or ovoid, and contains the chloroplast (*chl.*). There are several acaeli.

C, Base of the multicellular filamentous Green Alga *Chaetomorpha oerea*. The basal cell has less chlorophyll than the others, and is expanded and fixed firmly to the rock on which the plant grows by the basal surface, *rh.*, thus forming a rudimentary rhizoid.

D, Part of branched filamentous thallus of the multicellular Green Alga *Oedocladium*. *cr. ax.*, Green axis creeping on the surface of damp soil; *rh.*, colourless rhizoids penetrating the soil; *asc. ax.*, ascending axes of green cells.

E, Vertical section of frond of the complicated Siphonous Green Alga *Halimeda*. The substance of the frond is made up by a single much-branched tube, with interwoven branches, *cond. med.*, longitudinally running comparatively colourless central (medullary) branches, which conduct food substances and support the (*ass. cov.*) green assimilating cortical branches, which are the ends of branches from the medulla and fit tightly together, forming the continuous surface of the plant.

F, Section through the surface tissue of the Brown Alga *Codium multispadum*, showing the surface layer of assimilating cells densely packed with phaeoplasts. The layers below have progressively fewer of these, the central cells being quite colourless.

G, Section showing thick-walled cells of the cortex in a Brown Alga (seaweed). Simple pits (*p.*) enable conduction to take place readily from one to another.

H, Two adjacent cells (leptoids) of a food-conducting strand in *Fucus* (a Brown seaweed). The wall between them is perforated, giving passage to coarse strands of protoplasm.

I, End of hydroid of the thalloid Liverwort *Blyttia*, showing the thick lignified wall penetrated by simple pits.

of the cell-wall (which is secreted by the living cell-body) the protoplasm dies, and a tissue in which this has occurred consists solely of the dead framework of cell-walls, enclosing in the cavities, originally occupied by the protoplasm, simply water or air. In such cases the characters of the adult tissue clearly depend solely upon the characters of the cell-walls, and it is usual in plant-anatomy to speak of the wall with its enclosed

cavity as "the cell," and the contained protoplasm or other substances, if present, as *cell-contents*. This is in accordance with the original use of the term "cell," which was applied in the 17th century to the cavities of plant-tissues on the analogy of the cells of honeycomb. The use of the term to mean the individualized nucleated mass of living protoplasm, which, whether with or without a limiting membrane, primitively forms the proximate histological element of the body of every organism, dates from the second quarter of the 19th century. For a more detailed description of the cell see *CYTOLOGY* and the section on *Cytology of Plants* below) In all but the very simplest forms the plant-body is built up of a number of these cells, associated in more or less definite ways. In the higher (more complicated) plants the cells differ very much among themselves, and the body is composed of definite systems of these units, each system with its own characteristic structure, depending partly on the characters of the component cells and partly

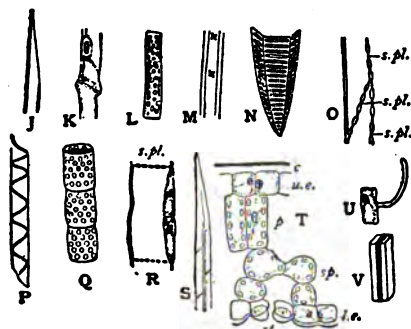

FIG. 18.—Examples of the differentiation of the tissue of plants.

J, End of hydroid of the Moss *Mnium*, showing particularly thin oblique end-wall. No pits.

K, Optical section of two adjacent leptoids of the Moss *Polytrichum juniperinum*. The leptoids are living and nucleated. They bulge in the neighbourhood of the very thin cross-wall. Note resemblance to H and R.

L, Optical section of cell of parenchyma in the same moss. Embedded in the protoplasm are a number of starch grains.

M, Part of elongated stereid of a Moss. Note thick walls and oblique slit-like pits with opposite inclination on the two sides of the cell seen in surface view.

N, One side of the end of hydroid (tracheid) of a Pteridophyte (fern), with scalariform pits.

O, Optical section of two adjacent leptoids (sieve-tube segments) of Pteridophyte, with sieve plates (*s. pl.*) on oblique end-wall and side-walls.

P, Part of spiral hydroid (tracheid) of Phanerogam (Flowering Plant).

Q, Three segments of a "pitted" vessel of Phanerogam.

R, Optical section of leptoid (sieve-tube segment) of Phanerogam, with two proteid (companion) cells. *s. pl.*, sieve-plate.

S, Optical section of part of thick-walled stereid of Phanerogam, with almost obliterated cavity and narrow slit-like oblique pits.

T, Part of vertical section through blade of typical leaf of Phanerogam. *u. e.*, Upper epidermal cells, with (*c*) cuticle. (*p*) Assimilating (palisade) cells. *sp.*, Assimilating (spongy) cells with large lacunae. *l. e.*, Lower epidermis, with *st.*, stoma.

U, Absorbing cell, with process (root-hair) from piliferous layer of root of Phanerogam.

V, Endodermal cell of Phanerogam, with suberized central band on radial and transverse walls.

on the method of association. Such a system is called a *sisseu*-system, the word tissue being employed for any collection of cells with common structural, developmental, or functional characters to which it may be conveniently applied. The word is derived from the general resemblance of the texture of plant substance to that of a textile fabric, and dates from a period when the fundamental constitution of plant substance from individual cells was not yet discovered. It is convenient here to define the two chief types of cell-form which characterize tissues

of the higher plants. The term *parenchyma* is applied to tissues whose cells are isodiametric or cylindrical in shape, *prosenchyma* tissues consisting of long narrow cells, with pointed ends.

We may now proceed to a systematic account of the anatomy of the different groups of plants, beginning with the simplest, and passing to the more complicated forms.

Thallophyta.—The simplest members of both the Algae and the Fungi (*q. v.*) (the two divisions of the *Thallophyta*, which is the lowest of the four great groups into which the plant-kingdom is divided) have their bodies each composed of a single cell. In the Algae such a cell consists essentially of (1) a mass of protoplasm provided with (2) a nucleus and (3) an assimilating apparatus consisting of a coloured protoplasmic body, called a *chromatophore*, the pigment of which in the pure green form is chlorophyll, and which may then be called a *chloroplast*. The whole of these living structures are covered externally by the dead cell-membrane (fig. 1 A). It is from such a living and assimilating cell, performing as it does all the vital functions of a green plant, that, according to current theory, all the different cell-forms of a higher plant have been differentiated in the course of descent.

Among the Green Algae the differentiation of cells is comparatively slight. Many forms, even when multicellular, have all their cells identical in structure and function, and are often spoken of as "physiologically unicellular." The cells are commonly joined end to end in simple or branched filaments. Such differentiation as exists in the higher types mainly takes two directions. In the fixed forms the cell or cells which attach the plant to the substratum often have a peculiar form, containing chlorophyll and constituting a rudimentary fixing organ or *rhizoid* (fig. 1 C). In certain types living on damp soil, the rhizoids penetrate the substratum, and in addition to fixing the plant absorb food substances (dissolved salts) from the substratum (fig. 1 B and D).

The second type of differentiation is that between supporting axis and assimilating appendages. The cells of the axis are commonly stouter and have much less chlorophyll than those of the appendages (*Draparnaldia*). This differentiation is parallel with that between stem and leaf of the higher plants. In the group of the Siphonaceae both these types of differentiation may exist in the single, long, branched, tube-like and multinucleate "cell" (*coenocyst*) which here forms the plant-body. *Protosiphon* (fig. 1 B) is an example parallel with *Oedocladium*; *Bryopsis*, with *Draparnaldia*. In *Caulerpa* the imitation of a higher plant by the differentiation of fixing, supporting and assimilating organs (root, stem and leaf) from different branches of the single cell is strikingly complete. In the Siphonaceous family of *Codiaceae* the branches of the primitive cell become considerably interwoven one with another, so that a dense tissue-like structure is often produced. In this we get a further differentiation between the central tubes (branches of the primitive cell), which run in a longitudinal direction through the body, possess little or no chlorophyll, and no doubt serve to conduct food substances from one region to another, and the peripheral ones, which are directed perpendicularly to the surface of the body, ending blindly there, contain abundant chlorophyll, and are the assimilating organs (fig. 1 E).

None of the existing Red Seaweeds (*Rhodophyceae*) has a unicellular body. The thallus in all cases consists of a branched filament of cells placed end to end, as in many of the Green Algae. Each branch grows simply by the transverse division of its apical cell. The branches may be quite free or they may be united laterally to form a solid body of more or less firm and compact consistency. This may have a radial stem-like organization, a central cell-thread giving off from every side a number of short sometimes unicellular branches, which together form a cortex round the central thread, the whole structure having a cylindrical form which only branches when one of the short cell-branches from the central thread grows out beyond the general surface and forms in its turn a new central thread, from whose cells arise new short branches. Or the thallus may have a leaf-like form, the branches from the central threads which form the midrib growing out mainly in one plane and forming a lamina, extended right and left of the midrib. Numerous variations and modifications of these forms exist. In all cases, while the internal threads which bear the cortical branches consist of elongated cells with few chromatophores, and no doubt serve mainly for conduction of food substances, the superficial cells of the branches themselves are packed with chromatophores and form the chief assimilating tissue of the plant. In the bulky forms colourless branches frequently grow out from some of the cortical cells, and, pushing among the already-formed threads in a longitudinal direction, serve to strengthen the thallus by weaving its original threads together. The cells belonging to any given thread may be recognized at an early stage of growth, because each cell

is connected with its neighbours belonging to the same thread by two depressions or pits, one at each end. The common wall separating the pits of the two adjoining cells is pierced by strands of protoplasm. The whole structure, consisting of the two pits and the wall between is known as a *generic pit*. Other pits, connecting cells not belonging to the same branch, are, however, formed at a later stage.

Many of the lower forms of Brown Seaweeds (Phaeophyceae) have a thallus consisting of simple or branched cell threads, as in the green and red forms. The lateral union of the branches to form a solid thallus is not, however, so common, nor is it carried to so high a pitch of elaboration as in the Rhodophyceae. In a few of the lower forms (Sphaeriales), and in the higher forms which possess a solid thallus, often of very large size, the plant-body is no longer formed entirely of branched cell-threads, but consists of what is called a true parenchymatous tissue, i.e. a solid mass of cells, formed by cell division in all directions of space. In the Laminariaceae this tissue is formed by cell division at what is called an *intercalary growing point*, i.e. a *meristematic* (cell-dividing) region occupying the whole of a certain transverse zone of the thallus, and cutting off new cells to add to the permanent tissue on both sides. In the Fucaceae, on the other hand, there is a single prismatic apical cell situated at the bottom of a groove at the growing apex of the thallus, which cuts off cells from its sides to add to the peripheral, and from its base to add to the central permanent cells. The whole of the tissue of the plant is formed by the division of this apical cell. In whatever way the tissues are originally formed, however, the main features of their differentiation are the same. According to a law which, as we have seen, applies also to the green and red forms, the superficial cells are packed with chromatophores and form the assimilating tissue (fig. 1, F). In these brown types with bodies of considerable thickness (Laminariaceae and Fucaceae), there is, however, a further differentiation of the internal tissues. The cells immediately adjacent to the superficial assimilating layer form a colourless, or nearly colourless, parenchymatous *cortex*, which acts as a food storage tissue (fig. 1, G), and surrounds a central *medulla* of elongated conducting cells. The latter are often swollen at the ends, so that the cross-wall separating two successive cells has a larger surface than if the cells were of uniform width along their entire length. Cells of this type are often called *trumpet-hyphae* (though they have no connexion with the hyphae of Fungi), and in some genera of Laminariaceae those at the periphery of the medulla simulate the *sieve-tubes* of the higher plants in a striking degree, even (like these latter) developing the peculiar substance *callose* on or in the perforated cross-walls or sieve-plates. A specialized conducting tissue of this kind, used mainly for transmitting organic substances, is always developed in plants where the region of assimilative activity is local in the plant-body, as it is in practically all the higher plants. This is the case in the Fucaceae, and in a very marked degree in the Laminariaceae in question, where the assimilative *frond* is borne at the end of an extremely long supporting and conducting *stipe*. A similar state of things exists in some of the more highly differentiated Red Seaweeds. The tissue developed to meet the demands for conduction in such cases always shows some of the characters described. It is known as *leptom*, each constituent cell being a *leptoid* (fig. 1, H). In addition to the cell types described, it is a very common occurrence in these bulky forms for rhizoid-like branches of the cells to grow out, mostly from the cells at the periphery of the medulla, and grow down between the cells, strengthening the whole tissue, as in the Rhodophyceae. This process may result in a considerable thickening of the thallus. In many Laminariaceae the thallus also grows regularly in thickness by division of its surface layer, adding to the subjacent permanent tissue and thus forming a *secondary meristem*.

The simpler Fungi, like the simpler Green Algae, consist of single cells or simple or branched cell-threads, but among the higher kinds a massive body is often formed, particularly in connexion with the formation of spores, and this may exhibit considerable tissue-differentiation.

Tissue Differentiation in Fungi. A characteristic feature of the fungal vegetative plant-body (*mycelium*) is its formation from independent coenocytic tubes or cell-threads. These branch, and may be packed or interwoven to form a very solid structure; but each grows in length independently of the others and retains its own individuality, though its growth in those types with a definite external form is of course correlated with that of its neighbours and is subject to the laws governing the general form of the body. Such an independent coenocytic branch or cell-thread is called a *hypha*. Similar modes of growth occur among the Siphonous Green Algae and also among the Red Seaweeds. A solid fungal body may usually be seen to consist of separate hyphae, but in some cases these are so bent and closely interwoven that an appearance like that of ordinary parenchymatous tissue is obtained in section, the structure being called *pseudoparenchyma*. By the formation of numerous cross-walls the resemblance to parenchyma is increased. The *surface-layer* of the body in the massive Fungi differs in character according to its function which is not constant throughout the class, as in the Algae, because of the very various conditions of life to which different Fungi are exposed. In many forms its hyphae are particularly thick-walled, and may strikingly resemble

the epidermis of a vascular plant. This is especially the case in the lichens (symbiotic organisms composed of a fungal mycelium in association with algal cells), which are usually exposed to very severe fluctuations in external conditions. The formation of a massive body naturally involves the localization of the absorptive region, and the function of absorption (which in the simpler forms is carried out by the whole of the vegetative part of the mycelium penetrating a solid or immersed in a liquid substratum) is subverted by the outgrowth of the hyphae of the surface-layer of that region into *rhizoids*, which, like those of the Algae living on soil, resemble the root-hairs of the higher plants. The *internal tissue* of the body of the solid higher Fungi, particularly the elongated stalks (*stipes*) of the fructifications of the Agarica, consists of hyphae running in a longitudinal direction, which no doubt serve for the conduction of organic food substances, just as do the "trumpet-hyphae," similar in appearance, though not in origin, of the higher Brown Seaweeds. (In one genus (*Lactarius*) "milk-tubes," recalling the laticiferous tubes of many vascular plants, are found.) These elongated hyphae are frequently thick-walled, and in some cases form a central strand, which may serve to resist longitudinal pulling strains. This is particularly marked in certain lichens of shrubby habit. The internal tissues, either consisting of obvious hyphae or of pseudoparenchyma, may also serve as a storehouse of plastic food substances.

Looking back over the progress of form and tissue-differentiation in the Thallophyta, we find that, starting from the simplest unicellular forms with no external differentiation of the body, we can trace an increase in complexity of organization everywhere determined by the principles of the division of physiological labour and of the adaptation of the organism to the needs of its environment. In the first place there is a differentiation of fixing organs, which in forms living on a soft nutrient substratum penetrate it and become absorbing organs. Secondly, in the Algae, which build up their own food from inorganic materials, we have a differentiation of supporting axes from assimilating appendages, and as the body increases in size and becomes a solid mass of cells or interwoven threads, a corresponding differentiation of a superficial assimilative system from the deep-lying parts. In both Algae and Fungi the latter are primarily supporting and food-conducting, and in some bulky Brown Seaweeds, where assimilation is strongly localized, some of the deep cells are highly specialized for the latter function. In the higher forms a storage and a mechanically-strengthening system may also be developed, and in some aerial Fungi an external protective tissue. The "hyphal" mode of growth, i.e. the formation of the thallus, whatever its external form, by branched, continuous or septate, coenocytic tubes (Siphonous and Fungi), or by simple or branched cell-threads (Red and many Green Algae), in both cases growing mainly or entirely at the apex of each branch, is almost universal in the group, the exceptions being met with almost entirely among the higher Brown Seaweeds, in which is found parenchyma produced by the segmentation of an apical cell of the whole shoot, or by cell division in some other type of meristem.

Bryophyta.—The Bryophyta [including the Liverworts (Hepaticae) and Mosses (Musci)], the first group of mainly terrestrial plants, exhibit considerably more advanced tissue differentiation, in response to the greater complexity in the conditions of life on land. In a general way this greater complexity may be said to consist (1) in the restriction of regular absorption of water to those parts of the plant-body embedded in the soil, (2) in the evaporation of water from the parts exposed to the air (transpiration). But these two principles do not find their full expression till we come, in the ascending series, to the Vascular Plants. In the Bryophytes water is still absorbed, not only from the soil but also largely from rain, dew, &c., through the general surface of the subaerial body (thallus), or in the more differentiated forms through the leaves. The lowest Hepaticae have an extremely simple vegetative structure, little more advanced than that found in some of the higher Green Algae and very much simpler than in the large Red and Brown Seaweeds. The plant-body (thallus) is always small and normally lives in very damp air, so that the demands of terrestrial life are at a minimum. It always consists of true parenchyma, and is entirely formed by the cutting off of segments from an apical cell.

A sufficient description of the thallus of the liverworts will be found in the article *BRYOPHYTES*. We may note the universal occurrence on the lower surface of the thallus of fixing and absorbing rhizoids in accordance with the terrestrial life on soil (cf. *Oedocladius* among the Green Algae). The Marchantiaceae (see article *BRYOPHYTES*) show considerable tissue-differentiation, possessing a distinct assimilative system of cells, consisting of branched cell threads packed with chloroplasts and arising from the basal cells of large cavities in the upper part of the thallus. These cavities are completely roofed by a layer of cells; in the centre of the roof is a pore surrounded by a ring of special cells. The whole arrangement has a strong resemblance to the lacunae, mesophyll and stomata, which form the assimilative and transpiring (water-evaporating) apparatus in the leaves of flowering plants. The frondose (thalloid) Jungermanniales show no such differentiation of an assimilating tissue, though the upper cells of the thallus usually have more chlorophyll than the rest. In three genera—*Blytia*, *Symphogyna* and *Hymenophyllum*—there are one or more strands or bundles consisting of long thick-walled fibre-like (prosenchymatous) cells, pointed at the ends and running longitudinally through the thick midrib. The walls of these cells are strongly lignified (i.e. consist of woody substance) and are irregularly but thickly studded with simple pits (see *CYTOLOGY*), which are usually arranged in spirals running round the cells, and are often elongated in the direction of the spiral (fig. 1, I). These cells are not living in the adult state, though they sometimes contain the disorganized remains of protoplasm. They serve to conduct water through the thallus, the assimilating parts of which are in these forms often raised above the soil and are comparatively remote from the rhizoid-bearing (water-absorbing) region. Such differentiated water-conducting cells we call *hydroids*, the tissue they form *hydrom*. The sporogonium of the liverworts is in the simpler forms simply a spore-capsule with arrangements for the development, protection and distribution of the spores. As such its consideration falls outside the scheme of this article, but in one small and peculiar group of these plants, the Anthoceroses, a distinct assimilating and transpiring system is found in the wall of the very long cylindrical capsule, clearly rendering the sporogonium largely independent of the supply of elaborated organic food from the thallus of the mother plant (the gametophyte). A richly chlorophyllous tissue with numerous intercellular spaces communicates with the exterior by stomata, strikingly similar to those of the vascular plants (see below). If the axis of such a sporogonium were prolonged downwards into the soil to form a fixing and absorptive root, the whole structure would become a physiologically independent plant, exhibiting in many though by no means all respects the leading features of the *sporophyte* or ordinary vegetative and spore-bearing individual in Pteridophytes and Phanerogams. These facts, among others, have led to the theory, plausible in some respects, of the origin of this sporophyte by descent from an Anthoceros-like sporogonium (see *PTERIDOPHYTES*). But in the Bryophytes the *sporogonium* never becomes a *sporophyte* producing leaves and roots, and always remains dependent upon the gametophyte for its water and mineral food, and the facts give us no warrant for asserting homology (i.e. morphological identity) between the differentiated tissues of an Anthocerosian sporogonium and those of the sporophyte in the higher plants. Opposed to the thaloid forms are the group of leafy Liverwort (Acrogynae), whose plant-body consists of a thin supporting stem bearing leaves. The latter are plates of green tissue one cell thick, while the stem consists of uniform more or less elongated cylindrical cells. The base of the stem bears numerous cell-filaments (rhizoids) which fix the plant to the substratum upon which it is growing.

In the Mosses the plant-body (gametophyte) is always separable into a radially organized, supporting and conducting axis (stem) and thin, flat, assimilating, and transpiring appendages.

Mosses. (Leaves). To the base of the stem are attached a number of branched cell-threads (*rhizoids*) which ramify in the soil, fixing the plant and absorbing water from soil. (For the history of the comparatively simple but in many respects aberrant Bog-mosses (Sphagnaceae), see *BRYOPHYTES*.) The stems of the other mosses resemble one another in their main histological features. In a few cases there is a special surface or epidermal layer, but usually all the outer layers of the stem are composed of brown, thick-walled, lignified, prosenchymatous, fibre-like cells forming a peripheral *steroom* (mechanical or supporting tissue) which forms the *outer cortex*. This passes gradually into the thinner-walled parenchyma of the *inner cortex*. The whole of the cortex, *steroom* and parenchyma alike, is commonly living, and its cells often contain starch. The centre of the stem in the forms living on soil is occupied by a strand of narrow elongated hydroids, which differ from those of the liverworts in being thin-walled, unligified, and very seldom pitted (fig. 1, J). The hydrom strand has in most cases no connexion with the leaves, but runs straight up the stem and spreads out below the sexual organs or the foot of the sporogonium. It has been shown that it conducts water with considerable rapidity. In the stalk of the sporogonium there is a similar strand, which is of course not in direct connexion with, but continues the conduction of water from, the strand of the gametophytic axis. In the aquatic, semi-aquatic, and xerophilous

types, where the whole surface of the plant absorbs water, perpetually in the first two cases and during rain in the last, the hydrom strand is either much reduced or altogether absent. In accordance with the general principle already indicated, it is only where absorption is localized (i.e. where the plant lives on soil from which it absorbs its main supply of water by means of its basal rhizoids) that a water-conducting (hydrom) strand is developed. The leaves of most mosses are flat plates, each consisting of a single layer of square or oblong assimilating (chlorophyllous) cells. In many cases the cells bordering the leaf are produced into teeth, and very frequently they are thick-walled so as to form a supporting rim. The centre of the leaf is often occupied by a *midrib* consisting of several layers of cells. These are elongated in the direction of the length of the leaf, are always poor in chlorophyll and form a channel for conducting the products of assimilation away from the leaf into the stem. This is the first indication of a conducting foliar strand or *leaf bundle* and forms an approach to leptom, though it is not so specialized as the leptom of the higher Phanerogae. Associated with the conducting parenchyma are frequently found hydroids identical in character with those of the central strand of the stem, and no doubt serving to conduct water to or from the leaf according as the latter is acting as a transpiring or a water-absorbing organ. In a few cases the hydrom strand is continued into the cortex of the stem as a *leaf-trace bundle* (the anatomically demonstrable trace of the leaf in the stem). This in several cases runs vertically downwards for some distance in the outer cortex, and ends blindly—the lower end or the whole of the trace being band-shaped or star-shaped so as to present a large surface for the absorption of water from the adjacent cortical cells. In other cases the trace passes inwards and joins the central hydrom strand, so that a connected water-conducting system between stem and leaf is established.

In the highest family of mosses, Polytrichaceae, the differentiation of conducting tissue reaches a decidedly higher level. In addition to the water-conducting tissue or *hydrom* there is a well-developed tissue (*leptom*) inferred to be conducting chiefly for organic substances. This *leptom* is not so highly differentiated as in the most advanced Laminariaceae, but shows some of the characters of sieve-tubes with great distinctness. Each *leptoid* is an elongated living cell with nucleus and a thin layer of protoplasm lining the wall (fig. 1, K). The whole cavity of the cell is sometimes stuffed with proteic contents. The end of the cell is slightly swollen, fitting on to the similar swollen end of the next *leptoid* of the row exactly after the fashion of a trumpet-hypha. The end wall is usually very thin, and the protoplasm on artificial contraction commonly sticks to it just as in a sieve-tube, though no perforation of the wall has been found. Associated with the *leptoids* are similar cells without swollen ends and with thicker cross-walls. Besides the hydrom and leptom, and situated between them, there is a tissue which perhaps serves to conduct soluble carbohydrates, and whose cells are ordinarily full of starch. This may be called *epylem*. The stem in this family falls into two divisions, an underground portion bearing rhizoids and scales, the *rhizomes*, and a leafy aerial stem forming its direct upward continuation. The leaf consists of a central midrib, several cells thick, and two wings, one cell thick. The midrib bears above a series of closely set, vertical, longitudinally-running plates of green assimilative cells over which the wings close in dry air so as to protect the assimilative and transpiring plates from excessive evaporation of water. The midrib has a strong band of *steroom* above and below. In its centre is a band-shaped bundle consisting of rows of leptom, hydrom and amyloam cells. This bundle is continued down into the cortex of the stem as a leaf-trace, and passing very slowly through the sclerenchymatous external cortex and the parenchymatous, starchy internal cortex to join the central cylinder. The latter has a central strand consisting of filer of large hydroids, separated from one another by very thin walls, each file being separated from its neighbour by stout, dark-brown walls. This is probably homologous with the hydrom cylinder in the stems of other mosses. It is surrounded by (1) a thin-walled, smaller-celled hydrom mantle, (2) an amyloam sheath; (3) a leptom mantle, interrupted here and there by starch cells. These three concentric tissue mantles are evidently formed by the conjoined bases of the leaf traces, each of which is composed of the same three tissues. As the aerial stem is traced down into the underground rhizome portion, these three mantles die out almost entirely—the central hydrom strand forming the bulk of the cylinder and its elements becoming mixed with thick-walled stereids; at the same time this central hydrom-steroom strand becomes three-lobed, with deep furrows between the lobes in which the few remaining leptoids run, separated from the central mass by a few starchy cells, the remains of the amyloam sheath. At the periphery of the lobes are some comparatively thin-walled living cells mixed with a few thin-walled hydroids, the remains of the thin-walled hydrom mantle of the aerial stem. Outside this are three arcs of large cells showing characters typical of the endodermis in a vascular plant, these are interrupted by strands of narrow, elongated, thick-walled cells, which send branches into the little brown scales borne by the rhizome. The surface layer of the rhizome bears rhizoids, and its whole structure strikingly resembles that of the typical root of a vascular plant. In *Catarrhus*

medullate the central hydrom cylinder of the aerial stem is a loose tissue, its interstices being filled up with thin-walled, starchy parenchyma. In *Diossotis superba*, a large New Zealand moss, the hydroids of the central cylinder of the aerial stem are mixed with thick-walled stereids forming a hydrom-stereom strand somewhat like that of the rhizome in other Polytrichaceae.

The central hydrom strand in the seta of the sporogonium of most mosses has already been alluded to. Besides this there is usually a living conducting tissue, sometimes differentiated as leptom, forming a mantle round the hydrom, and bounded externally by a more or less well-differentiated endodermis, abutting on an irregularly cylindrical lacuna; the latter separates the central conducting cylinder from the cortex of the seta, which, like the cortex of the gametophyte stem, is usually differentiated into an outer thick-walled stereom and an inner starchy parenchyma. Frequently, also, a considerable differentiation of vegetative tissue occurs in the wall of the spore-capsule itself, and in some of the higher forms a special assimilative and transpiring organ situated just below the capsule at the top of the seta, with a richly lacunar chlorophyllous parenchyma and stomata like those of the wall of the capsule in the Anthocerotan liverworts. Thus the histological differentiation of the sporogonium of the higher mosses is one of considerable complexity; but there is here even less reason to suppose that these tissues have any homology (phylogenetic community of origin) with the similar ones met with in the higher plants.

The features of histological structure seen in the Bryophytic series are such as we should expect to be developed in response to the exigencies of increasing adaptation to terrestrial life on soil, and of increasing size of the plant-body. In the liverworts we find fixation of the thallus by water-absorbing rhizoids; in certain forms with a localized region of water-absorption the development of a primitive hydrom or water-conducting system; and in others with rather a massive type of thallus the differentiation of a special assimilative and transpiring system. In the more highly developed series, the mosses, this last division of labour takes the form of the differentiation of special assimilative organs, the leaves, commonly with a midrib containing elongated cells for the ready removal of the products of assimilation; and in the typical forms with a localized absorptive region, a well-developed hydrom in the axis of the plant, as well as similar hydrom strands in the leaf-midribs, are constantly met with. In higher forms the conducting strands of the leaves are continued downwards into the stem, and eventually come into connexion with the central hydrom cylinder, forming a complete cylindrical investment apparently distinct from the latter, and exhibiting a differentiation into hydrom, leptom and amyloem which almost completely parallels that found among the true vascular plants. Similar differentiation, differing in some details, takes place independently in the other generation, the sporogonium. The stereom of the moss is found mainly in the outer cortex of the stem and in the midrib of the leaf.

Vascular Plants.—In the Vascular Plants (Pteridophytes, *i.e.* ferns, horse-tails, club mosses, &c., and Phanerogams or Flowering Plants) the main plant-body, that which we speak of in ordinary language as "the plant," is called the *sporophyte* because it bears the asexual reproductive cells or *spores*. The gametophyte, which bears the sexual organs, is either a free-living thallus corresponding in degree of differentiation with the lower liverworts, or it is a mass of cells which always remains enclosed in a spore and is parasitic upon the sporophyte.

The body of the sporophyte in the great majority of the vascular plants shows a considerable increase in complexity over that found in the gametophyte of Bryophytes. The principal new feature in the external conformation of the body is the acquirement of "true" roots, the nearest approach to which in the lower forms we saw in the "rhizome" of Polytrichaceae. The primary root is a downward prolongation of the primary axis of the plant. From this, as well as from various parts of the shoot system, other roots may originate. The root differs from the shoot in the characters of its surface tissues, in the absence of the green assimilative pigment chlorophyll, in the arrangement of its vascular system and in the mode of growth at the apex, all features which are in direct relation to its normally subterranean life and its fixative and absorptive

functions. Within the limits of the sporophyte generation the Pteridophytes and Phanerogams also differ from the Bryophytes in possessing special assimilative and transpiring organs, the leaves, though these organs are developed, as we have seen, in the gametophyte of many liverworts and of all the mosses. The leaves, again, have special histological features adapted to the performance of their special functions.

Alike in root, stem and leaf, we can trace a *three-fold division of tissue systems*, a division of which there are indications among the lower plants, and which is the expression of the fundamental conditions of the evolution of a bulky differentiated plant-body. From the primitive uniform mass of undifferentiated assimilating cells, which we may conceive of as the starting-point of differentiation, though such an undifferentiated body is only actually realized in the thallus of the lower Algae, there is, (1) on the one hand, a specialization of a surface layer regulating the immediate relations of the plant with its surroundings. In the typically submerged Algae and in submerged plants of every group this is the absorptive and the main assimilative layer, and may also be the production of mucilage be of use in the protection of the body in various ways. In the terrestrial plants it differs in the subterranean and subaerial parts, being in the former pre-eminently absorptive, and in the latter protective—provision at the same time being made for the gaseous interchange of oxygen and carbon dioxide necessary for respiration and feeding. This surface layer in the typically subaerial "shoot" of the sporophyte in Pteridophytes and Phanerogams is known as the *epidermis*, though the name is restricted by some writers, on account of developmental differences, to the surface layer of the shoot of Angiosperms, and by others extended to the surface layer of the whole plant in both these groups. On the other hand, we have (2) an internal differentiation of *conducting tissue*, the main features of which as seen in the gametophyte of Bryophytes have already been fully described. In the Vascular Plants this tissue is collectively known as the *vascular system*. The remaining tissue of the plant-body, a tissue that we must regard phylogenetically as the remnant of the undifferentiated tissue of the primitive thallus, but which often undergoes further differentiation of its own, the better to fulfil its characteristically vital functions for the whole plant, is known, from its peripheral position in relation to the primitively central conducting tissue, as (3) the *cortex*. Besides absorption, assimilation, conduction and protection there is another very important function for which provision has to be made in any plant-body of considerable size, especially when raised into the air, that of *support*. Special tissues (*stereom*) may be developed for this purpose in the cortex, or in immediate connexion with the conducting system, according to the varying needs of the particular type of plant-body. The important function of *aeration*, by which the inner living tissues of the bulky plant-body obtain the oxygen necessary for their respiration, is secured by the development of an extensive system of *intercellular spaces* communicating with the external air.

In relation to its characteristic function of protection, the epidermis, which, as above defined, consists of a single layer of cells has typically thickened and cuticularized outer walls. These serve not only to protect the plant against slight mechanical injury from without, and against the entry of smaller parasites, such as fungi and bacteria, but also and especially to prevent the evaporation of water from within.

At intervals it is interrupted by pores (*stomata*) leading from the air outside to the system of intercellular spaces below. Each stoma is surrounded by a pair of peculiarly modified epidermal cells called *guard-cells* (fig. 1, T), which open and close the pore according to the need for transpiration. The structure of the stomata of the sporophyte of vascular plants is fundamentally the same as that of the stomata on the sporogonium of the true mosses and of the liverwort *Anthoceros*. Stomata are often situated at the bottom of pits in the surface of the leaf. This arrangement is a method of checking transpiration by creating a still atmosphere above the pore of the stoma, so that water vapour collects in it and diminishes the further outflow of vapour. This type of structure, which is extremely various in its details, is found especially, as we should expect, in plants which have to economise their water

supply. The stomata serve for all gaseous interchange between the plant and the surrounding air. The guard-cells contain chlorophyll, which is absent from typical epidermal cells, the latter acting as a tissue for water storage. Sometimes the epidermis is considerably more developed by tangential division of its cells, forming a many-layered *water-tissue*. This is found especially in plants which during certain hours of the day are unable to cover the water lost through transpiration by the supply coming from the roots. The water stored in such a time supplies the immediate need of the transpiring cells and prevents the injury which would result from their excessive depletion.

The epidermis of a very large number of species bears hairs of various kinds. The simplest type consists simply of a single elongated cell projecting above the general level of the epidermis. Other hairs consist of a chain of cells; others, again, are branched in various ways; while yet others have the form of a flat plate of cells placed parallel to the leaf surface and inserted on a stalk. The cells of hairs may have living contents or they may simply contain air. A very common function of hairs is to diminish transpiration, by creating a still atmosphere between them, as in the case of the sunk stomata already mentioned. But hairs have a variety of other functions. They may, for instance, be glandular or stinging, as in the common stinging nettle, where the top of the hair is very brittle, easily breaking off when touched. The sharp, broken end penetrates the skin, and into the slight wound thus formed the formic acid contained by the hair is injected.

Mention may be made here of a class of epidermal organ, the *hydathodes*, the wide distribution and variety of which have been revealed by recent research. These are special organs, usually situated on foliage leaves, for the excretion of water in liquid form when transpiration is diminished so that the pressure in the water-channels of the plant has come to exceed a certain limit. They are widely distributed, but are particularly abundant in certain tropical climates where active root absorption goes on while the air is nearly saturated with water vapour. In one type they may take the form of specially-modified single epidermal cells or multicellular hairs without any direct connexion with the vascular system. The cells concerned, like all secreting organs, have abundant protoplasm with large nuclei, and sometimes, in addition, part of the cell-wall is modified as a filter. In a second type they are situated at the ends of tracheal strands and consist of groups of richly protoplasmic cells belonging to the epidermis (as in the leaves of many ferns), or to the subjacent tissue (the commonest type in flowering plants); in this last case the cells in question are known as *epithem*. The epithem is penetrated by a network of fine intercellular spaces, which are normally filled with water and debouch on one or more intercellular cavities below the epidermis. Above each cavity is situated a so-called *water-stoma*, no doubt derived phylogenetically from an ordinary stoma, and enclosed by guard-cells which have nearly or entirely lost the power of movement. The pores of the water-stomata are the outlets of the hydathode. The epithem is frequently surrounded by a sheath of cuticularized cells. In other cases the epithem may be absent altogether, the tracheal strand debouching directly on the lacunae of the mesophyll. This last type of hydathode is usually situated on the edge of the leaf. Some hydathodes are active glands, secreting the water they expel from the leaf. [Many other types of glands also exist, either in connexion with the epidermis or not, such as nectaries, digestive glands, oil, resin and mucilage glands, &c. They serve the most various purposes in the life of the plant, but they are not of significance in relation to the primary vital activities, and cannot be dealt with in the limits of the present article.] The typical epidermis of the shoot of a land plant does not absorb water, but some plants living in situations where they cannot depend on a regular supply from the roots (e.g. epiphytic plants and desert plants) have absorptive hairs or scales on the leaf epidermis through which rain and dew can be absorbed. Some hydathodes also are capable of absorbing as well as excreting water.

The surface layer of the root, sometimes included under the term epidermis, is fundamentally different from the epidermis of the stem. In correspondence with its water-absorbing function it is not cuticularized, but remains usually thin-walled; the absorbing surface is increased by its cells being produced into delicate tubes which curl round and adhere firmly to particles of soil, thus at once fixing the root firmly in the soil, and enabling the hair to absorb readily the thin films of water ordinarily surrounding the particles (fig. 1, U). The root-hair ends blindly and is simply an outgrowth from a surface cell, having no cross-walls. It corresponds in function with the rhizoid of a Bryophyte. At the apex of a root, covering and protecting the delicate tissue of the growing point, is a special *root-cap* consisting of a number of layers of tissue whose cells break down into mucilage towards the outer surface, thus facilitating the passage of the apex as it is pushed between the particles of soil.

The cortex, as has been said, is in its origin the remains of the primitive assimilating tissue of the plant, after differentiation of the surface layer and the conducting system. It consists primitively of typical living parenchyma; but its differentiation may be extremely varied, since in the complex

bodies of the higher plants its functions are numerous. In all green plants which have a special protective epidermis, the cortex of the shoot has to perform the primitive fundamental function of carbon assimilation. In the leafy shoot this function is mainly localized in the cortical tissue of the leaves, known as *mesophyll*, *mesophyll* which is essentially a parenchymatous tissue containing chloroplasts, and is penetrated by a system of intercellular spaces so that the surfaces of the assimilating cells are brought into contact with air to as large an extent as possible, in order to facilitate gaseous interchange between the assimilating cells and the atmosphere. At the same time the cells of the mesophyll are transpiring cells—i.e. the evaporation of water from the leaf goes on from them into the intercellular spaces. The only pathways for the gases which thus pass between the cells of the mesophyll and the outside air are the stomata. A land plant has nearly always to protect itself against over-transpiration, and for this reason the stomata of the typical *dorsiventral leaf* (fig. 2, A), which has distinct upper and lower faces, are placed mainly or exclusively on the lower side of the leaf, where the water vapour that escapes from them, being lighter than air, cannot pass away from the surface of the leaf, but remains in contact with it and thus tends to check further transpiration. The stomata are in direct communication with the ample system of intercellular spaces which is found in the loosely arranged mesophyll (*spongy tissue*) on that side. This is the main transpiring tissue, and is protected from direct illumination and consequent too great evaporation. The main assimilating tissue, on the other hand, is under the upper epidermis, where it is well illuminated, and consists of oblong cells densely packed with chloroplasts and with their long axes perpendicular to the surface (*palisade tissue*). The intercellular spaces are here very narrow channels between the palisade cells. Leaves whose blades are normally held in a vertical position possess palisade tissue and stomata on both sides (*isobilateral leaves*) (fig. 2, B), since there is no difference in the illumination and other external conditions.

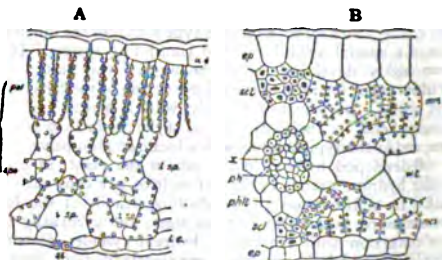

FIG. 2.—Transverse Sections of Leaves.

A, Dorsiventral leaf. B, Isobilateral leaf.
ep, epidermis; st, stoma; mes, mesophyll; pal, palisade; sp, spongy tissue;
i.sp., intercellular space; w.t., water tissue; x, xylem; ph, phloem;
pb, phloem; scl, sclerenchyma.

while those which are cylindrical or of similar shape (*centric lemes*) have it all round. The leaves of shade plants have little or no differentiation of palisade tissue. In fleshy leaves which contain a great bulk of tissue in relation to their chlorophyll content, the central mesophyll contains little or no chlorophyll and acts as water-storage tissue. The cortex of a young stem is usually green, and plays a more or less important part in the assimilative function. It also always possesses a well-developed lacunar system communicating with the external air through stomata (in the young stem) or *lenticels* (see below). This lacunar system not only enables the cells of the cortex itself to respire, but also forms channels through which air can pass to the deeper lying tissues. The cortex of the older stem of the root frequently acts as a reserve store-house for food, which generally takes the form of starch, and it also assists largely in providing the stereom of the plant. In the leaf-blade this sometimes appears as a layer of thickened subepidermal cells, the *hypodermis*, often also as subepidermal bundles of sclerenchymatous fibres, or as similar bundles extending right across the leaf from one epidermis to the other and thus acting as struts. Isolated cells (*idioblasts*), thickened in various ways, are not uncommonly found supporting the tissues of the leaf. In the larger veins of the leaf, especially in the midrib, in the petiole, and in the young stem, an extremely frequent type of mechanical tissue is *collenchyma*. This consists of elongated cells with cellulose walls, which are locally thickened along the original corners of the cells, reducing the lumen to a cylinder, so that a number of vertical pillars of cellulose connected by comparatively thin walls form the framework of the tissue. This tissue remains living and is usually formed quite early, just below the epidermis, where it provides the first peripheral support for a still growing stem or petiole. Sclerenchyma may be formed later in various positions in the cortex, according to local needs. Scattered single stereids or bundles of fibres are not uncommon in the cortex of the root.

The innermost layer of the cortex, abutting on the central cylinder of the stem or on the bundles of the leaves, is called the *phlooterma*, and is often differentiated. In the leaf-blade it takes the form of special parenchymatous sheaths to the bundles. The cells of these sheaths are often distinguished from the rest of the mesophyll by containing little or no chlorophyll. Occasionally, however, they are particularly rich in chloroplasts. These bundle sheaths are important in the conduction of carbohydrates away from the assimilating cells to other parts of the plant. Rarely in the leaf, frequently in the stem (particularly in Pteridophytes), and universally in the root, the phlooterma is developed as an *endodermis* (see below). In other cases it does not differ histologically from the parenchyma of the rest of the cortex, though it is often distinguished by containing particularly abundant starch, in which case it is known as a *starch sheath*.

One of the most striking characters common to the two highest groups of plants, the Pteridophytes and Phanerogams, is the possession of a double (hydrom-leptom) conducting vascular system, such as we saw among the highest mosses, but with sharply characterized and peculiar features, probably indicating common descent throughout both these groups. It is confined to the sporophyte, which forms the leafy plant in these groups, and is known as the *vascular system*. Associated with it are other tissues, consisting of parenchyma, mainly starchy, and in the Phanerogams particularly, of special stereom. The whole tissue system is known as the *stelar system* from the way in which in primitive forms it runs through the whole axis of the plant in the form of a column). The stelar system of Vascular Plants has no direct phylogenetic connexion with that of the mosses. The origin of the Pteridophyta (*q.v.*) is very obscure, but it may be regarded as certain that it is not to be sought among the mosses, which are an extremely specialized and peculiarly differentiated group. Furthermore, both the hydrom and leptom of Pteridophytes have marked peculiarities to which no parallel is to be found among the Bryophytes. Hence we must conclude that the conducting system of the Pteridophytes has had an entirely separate evolution. All the surviving forms, however, have a completely established double system with the specific characters alluded to, and since there is every reason to believe that the conditions of evolution of the primitive Pteridophyte must have been essentially similar to those of the Bryophytes, the various stages in the evolution of the conducting system of the latter (*p. 732*) are very useful to compare with the arrangements met with in the former.

The hydroid of a Pteridophyte or of a Phanerogam is characteristically a dead, usually elongated, cell containing air and water, and either thin-walled with lignified (woody) spiral (*fig. 1, f.*), or annular thickenings, or with thick lignified walls, in- **Thuse** completely perforated by pits (*fig. 1, q.*) (usually bordered pits) of various shapes, *e.g.* the pits may be separated by a network of thickenings when the tracheid is *reticulate* or they may be transversely elongated and separated by bars of thickening like the rungs of a ladder (scalariform thickening). When, in place of a number of such cells called *tracheids*, we have a continuous tube with the same kind of wall thickening, but composed of a number of cells whose cross walls have disappeared, the resulting structure is called a *vessel*. Vessels are common in the Angiospermous group of Flowering Plants. The scalariform hydroids of Ferns (*fig. 1, n.*) have been quite recently shown to possess a peculiar structure. The whole of the middle lamella or originally formed cell-wall separating one from another disappears before the adult state is reached, so that the walls of the hydroids consist of a framework of lignified bars with open communication between the cell cavities. The tracheids or vessels, indifferently called *tracheal elements*, together with the immediately associated cells (usually amyloin in Pteridophytes) constitute the *xylem* of the plant. This is a morphological term given to the particular type of hydrom found in both Pteridophytes and Phanerogams, together with the parenchyma or stereom, or both, included within the boundaries of the hydrom tissue strand. The leptoid of a Pteridophyte (*fig. 1, o.*) is also an elongated cell with a thin lining of protoplasm, but destitute of a nucleus, and always in communication with the next cell of the leptom strand by perforations (in Pteridophytes often not easily demonstrable), through which originally gas strings of protoplasm which are bored out by a ferment and converted into relatively coarse "slime strings," along which pass, we must suppose, the organic substances which it is the special function of the leptoids to conduct from one part of the plant to another. The peculiar substance called *callose*, chemically allied to cellulose, is frequently formed over the surface of the perforated end-walls. The structure formed by a number of such cells placed end to end is called a *slime-tube* (obviously comparable with a xylem-vessel), and the end-wall or area of end-wall occupied by a group of perforations, a *slime-plate*. When the slime-tube has ceased to function and the protoplasm, slime strings, and callose have disappeared, the perforations through which the slime strings passed are left as relatively large holes, easily visible in some cases with low powers of the microscope, piercing the *slime-plate*. The slime-tubes, with their accompanying parenchyma or stereom, constitute the tissue called *phloem*. This is

the term for a morphologically defined tissue system, *i.e.* the leptom found in Pteridophytes and Phanerogams with its associated cells, and is entirely parallel with the xylem. The sieve-tubes differ, however, from the tracheids in being immediately associated, apparently constantly, not with starchy parenchyma, but with parenchymatous cells, containing particularly abundant protoid contents, which seem to have a function intimately connected with the conducting function of the sieve-tubes, and which we may call *protoid-cells*. In the Angiosperms there are always sister-cells of sieve-tube segments and are called companion-cells (*fig. 1, r.*).

The xylem and phloem are nearly always found in close association in strands of various shapes in all the three main organs of the sporophyte—root, stem and leaf—and form a connected tissue-system running through the whole body. In the primary axis of the plant among Pteridophytes and many Phanerogams, at any rate in its first formed part, the xylem and phloem are associated in the form of a cylinder (stele), with xylem occupying the centre, and the phloem (in the upward-growing part or primary stem) forming a mantle at the periphery (*fig. 4*). In the downward growing part of the axis (primary root), however, the peripheral mantle of phloem is interrupted, the xylem coming to the surface of the cylinder along (usually) two or (sometimes) more vertical lines. Such an arrangement of vascular tissue is called *radial*, and is characteristic of all roots (*figs. 3 and 10*). The cylinder is surrounded by a mantle of one or more layers of parenchymatous cells, the *pericycle*, and the xylem is generally separated from the phloem in the stem by a similar layer, the *mesocycle* (corresponding with the amyloin sheath in mosses). The pericycle and mesocycle together form the *conjunctive tissue* of the stele in these simplest types. When the diameter of the stele is greater, parenchymatous conjunctive tissue often occupies its centre and is frequently called the *pith*. In the root the mesocycle, like the phloem, is interrupted, and runs into the pericycle where the xylem touches the latter (*fig. 3*). The whole cylinder is enclosed by the peculiarly differentiated innermost cell-layer of the cortex, known as the *endodermis*. This layer has its cells closely united and sealed to one another, so to speak, by the conversion of the radial and transverse walls (which separate each cell from the other cells of the layer), or of a band running in the centre of these, into corky substance (*fig. 1, v.*), so that the endodermal cells cannot be split apart to admit of the formation of intercellular spaces, and an air-tight sheath is formed round the cylinder. Such a vascular cylinder is called a *haplostele*, and the axis containing it is said to be *haplostelic*. In the stele of the root the strands of tracheids along the lines where the xylem touches the pericycle are spiral or annular, and are the xylem elements first formed when the cylinder is developing. Each strand of spiral or annular first-formed tracheids is called a *protoxylem* strand, as distinct from the *metaxylem* or rest of the xylem, which consists of thick-walled tracheids, the pits of which are often scalariform. The thin-walled spiral or annular tracheae of the protoxylem allow of longitudinal stretching brought about by the active growth in length of the neighbouring living parenchymatous cells of a growing organ. During the process the thin walls are stretched and the turns of the spiral become pulled apart without rupturing the wall of the tracheid or vessel. If the pitted type of tracheal element were similarly stretched its continuously thickened walls would resist the stretching and eventually break. Hence such tracheae are only laid down in organs whose growth in length has ceased. The stele is called *monarch*, *diarch*, . . . *polyarch* according as it contains one, two, . . . or many protoxylems. When the protoxylem strands are situated at the periphery of the stele, abutting on the pericycle, as in all roots, and many of the more primitive Pteridophyte stems, the stele is said to be *exarch*. When there is a single protoxylem strand in the centre of the stele, or when, as is more commonly the case, there are several protoxylem strands situated at the internal limit of the xylem, the centre of the stem being occupied by parenchyma, the stele is *endarch*. This is the case in the stems of most Phanerogams and of some Pteridophytes. When the protoxylems have an intermediate position the stele is *mesarch* (many Pteridophytes and some of the more primitive Phanerogams). In many cases external *protophloem*, usually consisting of narrow sieve-tubes often with swollen walls, can be distinguished from *metaphloem*.

As the primitive stele of a Pteridophyte is traced upwards from the primary root into the stem, the phloem becomes continuous round the xylem. At the same time the stele becomes more bulky, all its elements increasing in number (*fig. 4*). Soon a bundle goes off to the first leaf. This consists of a few xylem elements, a segment of phloem, pericycle, and usually an arc of endodermis, which closes round the bundle as it detaches itself from the stele. As the stele is traced farther upwards it becomes bulkier, as do the successive leaf-bundles which leave it. In many Pteridophytes the solid haplostele is maintained throughout the axis. In others a central parenchyma or *primitive pith*—a new region of the primitive stelar conjunctive—appears in the centre of the xylem. In most ferns *internal phloem* appears instead of a parenchymatous pith (*fig. 5*). Sometimes this condition,

Evolution of the Stele in Pteridophytes.

that of the *amphiphloic haplostele*, is maintained throughout the adult stem (*Lindsaya*). In the majority of ferns, at a higher level, after the stele has increased greatly in diameter, a large-celled *true pith* or *medulla*, resembling the cortex in its characters, and quite distinct from conjunctive, from which it is separated by an *internal endodermis*, appears in the centre. These successive new tissues, appearing in the centre of the stele, as the stem of a higher fern is traced upwards from its first formed parts, are all in continuity with the respective corresponding external tissues at the point of origin of each leaf trace (see below). Where internal phloem is present this is separated from the internal endodermis by an *endocycle* or "internal pericycle," as it is sometimes called, and from the xylem by an *internal mesocycle*—these two layers, together with the outer mesocycle and pericycle, constituting the conjunctive tissue of the now hollow cylindrical stele. (The conjunctive frequently forms a connected whole with bands of

axis. The type of siphonostele characteristic of many ferns, in which are found internal phloem, and an internal endodermis separating the vascular conjunctive from the pith, is known as a *solenostele*. The solenostele of the ferns is broken by the departure of each leaf-bundle, the outer and inner endodermis joining so that the stele becomes horseshoe-shaped and the cortex continuous with the pith (fig. 6). Such a break is known as a *leaf-gap*. A little above the departure of the leaf-bundle the stele again closes up, only to be again broken by the departure of the next leaf-bundle. Where the leaves are crowded, a given leaf-gap is not closed before the next ones appear, and the solenostele thus becomes split up into a number of segments, sometimes band-shaped or semi-lunar, sometimes isodiametric in cross-section (fig. 7). In the latter case each segment of the solenostele frequently resembles a *Dicranostele* haplostele, the segments of inner endodermis, pericycle, phloem and

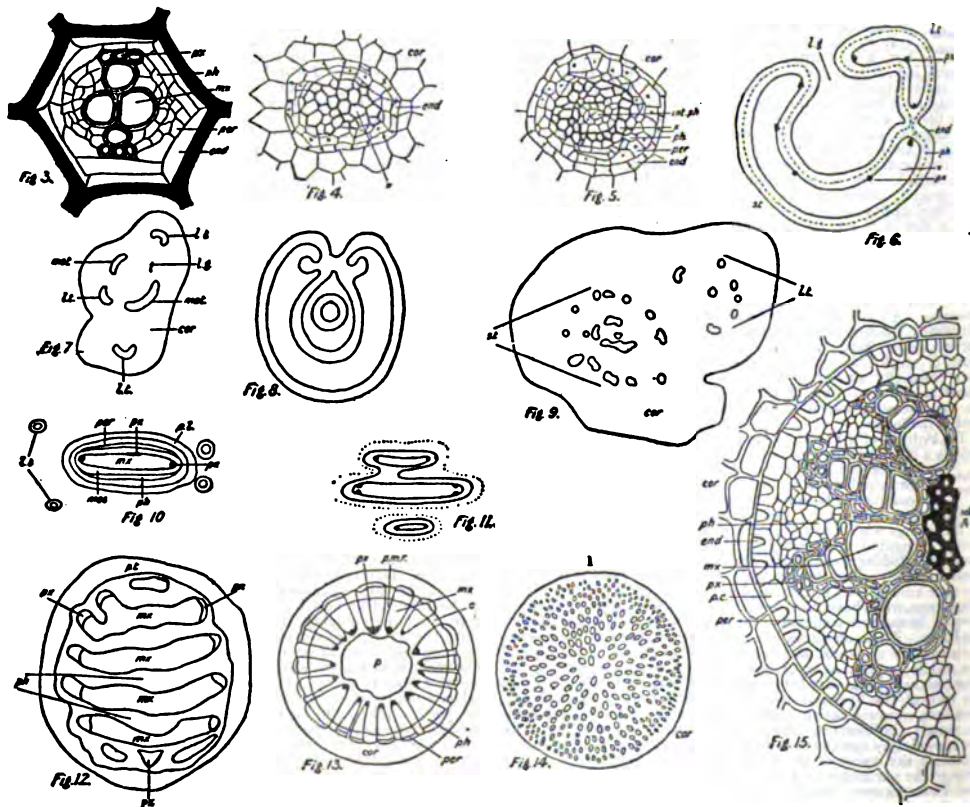

FIGS. 3-15.—Types of Stele in Vascular Plants. FIG. 3.—Diarch stele of root of a Fern. FIG. 4.—Haplostele of stem of young Fern. FIG. 5.—Amphiphloic haplostele of stem of young Fern. FIG. 6.—Solenostele of stem of Fern showing detachment of leaf-trace and leaf-gap. FIG. 7.—Dicranostele of Fern. FIG. 8.—Tricyclic solenostele of *Hintonia*. FIG. 9.—Tricyclic dicranostele of *Dioscorea*. FIG. 10.—Diarch haplostele of *Selaginella*. FIG. 11.—Tristele stem of *Selaginella*. FIG. 12.—Banded haplostele of *Lycopodium*. FIG. 13.—Typical siphonostele of dicotyledon. FIG. 14.—Stele of monocotyledon. FIG. 15.—Polyarch root of *Vallisneria* (a monocotyledon).

Explanation of Lettering: st. stele; met. meristele; L.G. leaf-gap; cor. cortex; p.t. peristele lacuna; end. endodermis; p.c. pith; p.p. pericycle; p.h. phloem; mes. mesocycle; a. xylem; p.t. protoxylem; m.t. metaxylem; p. pith; s.d. sclerid pith; c. cambium; p.m.v. primary, medullary, ray.

starchy *xylem-parenchyma*, which, when the xylem is bulky, usually appear among the tracheids, the phloem also often being penetrated by similar bands of *phloem-parenchyma*.)

In the other groups of Pteridophytes internal phloem is not found and an internal endodermis but rarely. The centre of the stele is however often occupied by a large-celled pith resembling the cortex in structure, the cortex and pith together being classed as *ground tissue*. To this type of stele having a "ground-tissue pith," whether with or without internal phloem, is given the name *siphonostele* to distinguish it from the solid *haplostele* characteristic of the root, the first-formed portion of the stem, and in the more primitive Pteridophytes, of the whole of the

mesocycle joining with the corresponding outer segments to form a nearly concentric structure. For this reason a stem in which the vascular system has this type of structure used to be spoken of as *polystele*, the term "stele" being transferred from the primary central cylinder of the axis and applied to the vascular strands just described. In this use the term loses, of course, its morphological value, and it is better to call such a segment of a broken-up stele a *meristele*, the whole solenostele with overlapping leaf-gaps being called a *dicranostele*. The splitting up of the vascular tube into separate strands does not depend wholly upon the occurrence of leaf-gaps. In some forms other gaps (*perforations*) appear in the vascular tube placing the pith and cortex in communication

In other cases the leaf-gaps are very broad and long, the meristemes separating them being reduced to comparatively slender strands while there is present in each gap a network of fine vascular threads, some of which run out to the leaf, while others form cross-connections between these "leaf-trace" strands and also with the main cauline meristemes. Finally the cauline meristemes themselves may be resolved into a number of fine threads. Such a structure may be spoken of as a dissected *dictyostele*.

In some solenostelic ferns, and in many dictyostelic ones additional vascular strands are present which do not form part of the primary vascular tube. They usually run freely in the pith and form a *polyarchy*. They join the primary tube in the neighbourhood of the leaf-gaps. Sometimes a complete internal vascular cylinder, having the same structure as the primary one, and concentric with it, occurs in the pith, and others may appear, internal to the first (*Matosia*, *Saccoloma*). Junctions of the first internal cylinder are made with the primary (external) cylinder at the leaf-gaps, and of the second internal cylinder with the first in the same neighbourhood (fig. 8). In dictyostelic ferns similar internal (dictyostelic) cylinders are found in some forms, and occasionally a large series of such concentric cylinders is developed (*Marattiaceae*) (fig. 9). In such cases the vascular system is said to be *polycyclic* in contrast with the ordinary *monocyclic* condition. These internal strands or cylinders are to be regarded as peculiar types of elaboration of the stele, and probably act as reservoirs for water-storage which can be drawn upon when the water supply from the root is deficient.

The vascular supply of the leaf (leaf-trace) consists of a single strand only in the haplostelic and some of the more primitive siphonostelic forms. In the "microphyllous" groups *Leaf-trace* of Pteridophytes (Lycopodiales and Equisetales) in *Andropogon* and *Pottolus* which the leaves are small relatively to the stem, the single bundle destined for each leaf is a small strand whose departure causes no disturbance in the cauline stele. In the "megaphyllous" forms, on the other hand, (Ferns) whose leaves are large relatively to the stem, the departure of the correspondingly large trace causes a gap (leaf-gap) in the vascular cylinder, as already described. In the haplostelic ferns the leaf-trace appears as a single strand with a tendency to assume the shape of a horse-shoe on cross-section, and this type is also found in the more primitive solenostelic types. In the more highly developed forms, as already indicated, the leaf-trace is split up into a number of strands which leave the base and sides of the leaf-gap independently. In the petiole these strands may increase in number by branching, and though usually reducible to the outline of the primitive "horse-shoe," more or less elaborated, they may in some of the complex polycyclic dictyostelic types (*Marattiaceae*) be arranged in several concentric circles, thus imitating the arrangement of strands formed in the stem. The evolution of the vascular structure of the petiole in the higher ferns is strikingly parallel with that of the stem, except in some few special cases.

There is good reason to believe that the haplostele is primitive in the evolution of the vascular system. It is found in most of these Pteridophytes which we have other reasons for considering as primitive types, and essentially the same type is found, as we have seen, in the independently developed primitive conducting system of the moss-stem. This type of stem is therefore often spoken of as *protostelic*. In the Ferns there is clear evidence that the amphiphloic haplostele or protostele succeeded the simple (ectophloic) protostele in evolution, and that this in its turn gave rise to the *solenostele*, which was again succeeded by the *dictyostele*. Polycyclicity was derived independently from monocyclicity in solenostelic and in dictyostelic forms. In the formation of the stem of any fern characterized in the adult condition by one of the more advanced types of vascular structure all stages of increase in complexity from the haplostele of the first-formed stem to the particular condition characteristic of the adult stem are gradually passed through by a series of changes exactly parallel with those which we are led to suppose, from the evidence obtained by a comparison of the adult forms, must have taken place in the evolution of the race. There is no more striking case in the plant-kingdom of the parallel between ontogeny (development of the individual) and phylogeny (development of the race) so well known in many groups of animals.

The stele of most Lycopods is a more or less modified protostele, but in the genus *Lycopodium* a peculiar arrangement of the xylem and phloem is found, in which the latter, instead of being confined to a peripheral mantle of tissue, forms bands running across the stele and alternating with similar bands of xylem (fig. 12). In *Selaginella* the stele system shows profounder modifications. In some forms we find a simple protostele, exarch-polyarch in one species (*S. selaginoides*), exarch-diarch in several (fig. 10). In other species, however, a peculiar type of *polystely* is met with, in which the original diarch stele gives rise to so-called dorsal and ventral stele "cords" which at first lie on the surface of the primary stele, but eventually, at a higher level separate from it and form distinct "secondary" steles resembling the primary one. Similar cords may be formed on, and may separate from, these secondary steles, thus giving rise

to a series of steles arranged in a single file (fig. 11). In the creeping stem of one species (*S. Lyallii*) a polycyclic solenostele is found exactly parallel with that of the rhizome of ferns. The gaps in the outer tubular stele, however, are formed by the departure of aerial branch-traces, instead of leaf-traces as in the ferns. The first formed portion of the stem in all species of *Selaginella* which have been investigated possesses an exarch haplostele. The stele of *Equisetum* is of a very peculiar type whose relations are not completely clear. It consists of a ring of endarch collateral bundles surrounding a hollow pith. The protoxylem of each is a leaf-trace, while the metaxylem consisting of a right and a left portion forms a quite distinct cauline system. All the metaxylems join at the nodes into a complete ring of xylem. The whole stele may be surrounded by a common external endodermis; sometimes there is an internal endodermis in addition, separating the bundles from the pith; while in other cases each bundle possesses a separate endodermis surrounding it. At the nodes the relation of the endodermis to the bundles undergoes rather complex but definite changes. It is probable that this type of stele is a modification of a primitive protostele, in which the main mass of stele xylem has become much reduced and incidentally separated from the leaf-traces.

During recent years a number of fossil (Carboniferous and Permian) plants have been very thoroughly investigated in the light of modern anatomical knowledge, and as a result it has become clear that in those times a large series of plants existed intermediate in structure between the modern ferns and the modern Gymnosperms (especially Cycads), and to these the general name "Cycadofilices" has been applied. We now know that many at least of the Cycadofilices bore seeds, of a type much more complex than that of most modern seed plants, and in some cases approximating to the seeds of existing Cycads. Among the Cycadofilices a series of stages is found leading from the primitive fern-protostele to the type of siphonostele characteristic of the Cycads which agrees in essentials in all the Spermophytes. The main events in this transition appear to have been (1) disappearance of the central xylem of the protostele and replacement by pith, leading to the survival of a number of (mesarch) collateral bundles (see below) at the periphery of the stele; (2) passage from mesarchy to endarchy of these bundles correlated with a great increase in secondary thickening of the stele. The leaves of the more primitive members of this series were entirely fern-like and possessed a fern-like vascular strand; while in the later members, including the modern Cycads, the leaf bundles, remaining unaffected by secondary thickening, are mesarch, while those of the stem-stele have become endarch. Besides the types forming this series, there are a number of others (Medulloseae and allied forms) which show numerous, often very complex, types of stele structure, in some cases polystelic, whose origin and relationship with the simpler and better known types is frequently obscure. Among the existing Cycads, though the type of vascular system conforms on the whole with that of the other existing seed-plants, peculiar structures are often found (e.g. indications of polystely, frequent occurrence of extra-stelar concentric bundles, "anomalous" secondary thickening) which recall these complex types of stele structure in the fossil Cycadofilices.

The typical structure of the vascular cylinder of the adult primary stem in the Gymnosperms and Dicotyledons is, like that of the higher ferns, a hollow cylinder of vascular tissue enclosing a central parenchymatous pith. But, unlike the ferns, there is in the seed-plants no internal phloem (except as a special development in certain families) and no internal endodermis. The xylem and phloem also, rarely form perfectly continuous layers as they do in a solenostelic fern. The vascular tissue is typically separable into distinct *collateral bundles* (figs. 13, 23), the xylem of which is usually wedge-shaped in cross-section with the protoxylem elements at the inner extremity, while the phloem forms a band on the outer side of the xylem, and separated from it by a band of conjunctive tissue (*mesoderm*). These collateral bundles are separated from one another by bands of conjunctive tissues called *primary medullary rays*, which may be quite narrow or of considerable width. When the pith is large celled, the xylems of the bundles are separated from it by a distinct layer of conjunctive tissue called the *endocycle*, and by a similar layer, the *pericycle*, separates the phloem from the cortex. The inner layer of the cortex (*phlootermis*) may form a well-marked *endodermis*, or differ in other ways from the rest of the cortex. The pericycle, medullary rays, endocycle and mesoderm all form parts of one tissue system, the *external conjunctives*, and are only topographically separable. The external conjunctive is usually a living comparatively small-celled tissue, whose cells are considerably elongated in the direction of the stem-axis and frequently contain abundant starch. Certain regions of it, particularly the whole or part of the pericycle, but sometimes also the endocycle, are typically converted into thick-walled hard (sclerenchymatous) tissue usually of the prosenchymatous (fibrous) type, which is important in strengthening the stem, particularly in enabling it to resist *bending strains*. The relatively peripheral position in the stem of the pericycle is important in this connexion. Various *secondary meristems* (see p. 741) also arise in the external conjunctive.

Most of the collateral bundles of this spermatophytic type of siphonostele are leaf-trace bundles, i.e. they can be traced upwards from any given point till they are found to pass out of the cylinder, travel through the cortex of the stem and enter a leaf. The remaining bundles (*compensation bundles*) which go to make up the cylinder are such as have branched off from the leaf-traces, and will, after joining with others similarly given off, themselves form the traces of leaves situated at a higher level on the stem. Purely cauline vascular strands (i.e. confined to the stem) such as are found in the dictyostele of ferns are rare in the flowering plants. The leaf trace of any given leaf rarely consists of a single bundle only (*unifascicular*); the number of bundles of any given trace is always odd; they may either be situated all together before they leave the stele or they may be distributed at intervals round the stele. The median bundles of the trace are typically the largest, and at any given level of the stem the bundles destined for the next leaf above are as a whole larger than the others which are destined to supply higher leaves. *Leaf-gaps* are formed in essentially the same way as in the ferns, but when in the case of a plurifascicular trace the bundles are distributed at intervals round the cylinder it is obvious that several gaps must be formed as the different bundles leave the stele. The gaps, are, however, often filled as they are formed by the development of external conjunctive tissue immediately above the points at which the bundles begin to bend out of the stele, so that sharply defined open gaps such as occur in fern-stemes but rarely met with in flowering plants. The constitution of the stele of a flowering plant entirely from endarch collateral bundles, which are either themselves leaf-traces or will form leaf-traces after junction with other similar bundles, is the great characteristic of the stem-stele of flowering plants. These collateral bundles are obviously highly individualized. The external conjunctive tissue is often arranged in relation to each bundle separately, the pericycle fibres for instance, already referred to, being often confined to the bands of pericycle tissue abutting on the pith of each bundle, while the cortex and pith frequently form rays in the intervals between the adjacent bundles.

In some cases this individualization is carried further, the cortex and pith becoming continuous between the bundles which appear

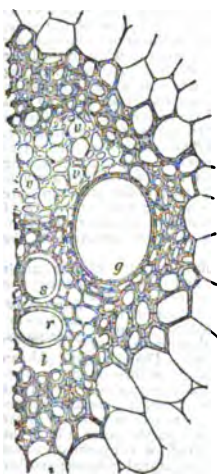

(Sachs.)
FIG. 16.—Transverse section of the closed vascular bundle of a monocotyledon.

a. Annular vessel.
b. Spiral vessel.
c. Inter-cellular canal.
d. Pitted vessel.
e. Sieve-tubes with accompanying companion-cells.
f. Sclerotized periderm.
g. Surrounding parenchyma. Outer cells of the bundle are parichymatous, f marks the inner side of the bundle.

is often fibrous (fig. 16). It is possible to suppose that this condition is derived from the astelic condition already referred to, but the evidence on the whole leads to the conclusion that it has arisen by an increase in the number of the bundles within the stele, the individuality of the bundle asserting itself after its escape from the original bundle-ring of the primitive cylinder.

as isolated strands embedded in a general ground-tissue. Each bundle has its own investment of tissue corresponding with external conjunctive, and now called *periderm*. The bundles sometimes keep their arrangement in a ring corresponding with the stele, though the continuous cylinder no longer exists (species of *Ranunculus*). This condition is known as *astely*. In some astelic stems (Nymphaeaceae) the number of bundles is greatly increased and they are scattered throughout the ground tissue. A "polytelic" condition arises in some members of this order by the association of collateral bundles round common centres. A similar phenomenon is seen in two widely separated genera of flowering plants: *Primula* § *Auricula* and *Gunnera* (Haloragaceae).

The monocotyledons, one of the primary divisions of angiosperms, typically possess large leaves with broad sheathing bases containing a very great number of bundles. This results in the number of bundles present at any given level of the stem being enormously increased. These bundles are scattered in a definite though not superficially obvious order through the conjunctive tissue of the stele, which occupies nearly the whole diameter of the stem, the cortex being reduced to a very narrow layer, or disappearing altogether (fig. 3). The mass of conjunctive tissue is developed as a large-celled "ground-tissue," and round each bundle there is a "periderm" which

In the stems of many water-plants various stages of reduction of the vascular system, especially of the xylem, are met with, and very often this reduction leads to the formation of a compact stele in which the individuality of the separate bundles may be suppressed, so that a closed cylinder of xylem surrounds a pith. The pith is generally unreduced, and there is normally a well marked endodermis (fig. 17).

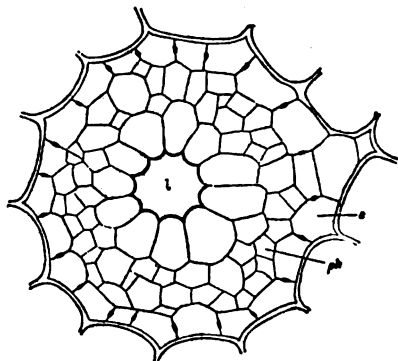

FIG. 17.—Transverse section of the stele of the stem of a water-plant (*Najas*); l. intercellular channel representing xylem; ph. pith; e. endodermis.

In other cases the reduction goes much further, till the endodermis eventually comes to surround nothing but an intercellular channel formed in place of the stele tissue.

In the blade of a typical leaf of a vascular plant—essentially a thin plate of assimilating tissue—the vascular system takes the form of a number of separate, usually branching and anastomosing strands. These, with their associated stereom, form a kind of framework which is of great importance in supporting the mesophyll; but also, and chiefly, they provide a number of channels, penetrating every part of the leaf, along which water and dissolved salts are conveyed to, and elaborated food-substances from, the mesophyll cells. The bundle-system is of course continuous with that of the petiole and stem.

The leaf-bundles are always collateral (the pith being turned downwards and the xylem upwards), even in Ferns, where the petiolar strands are concentric, and they have the ordinary mesoderm and periderm of the collateral bundle. The latter is often sclerotized, especially opposite the pith, and to a less extent opposite the xylem, as in the stem. As a bundle is traced towards its blind termination in the mesophyll the peridermic stereom first disappears, the sieve-tubes of the pith are replaced by narrow elongated parenchyma cells, which soon die out, and the bundle ends with a strand of tracheids covered by the phlootermic sheath.

The structure of the stele of the primary root as it is found in most Pteridophytes and many Phanerogams has been already described. The radial structure is characteristic of all root-steles, which have in essential points a remarkably uniform structure throughout the vascular plants, a fact no doubt largely dependent on the very uniform conditions under which they live. While the stele of the primary root in both Gymnosperms and Angiosperms is usually diarch or tetrarch, the large primary root-steles of many adventitious roots are frequently polyarch, sometimes with a very large number of protoxylems. Such a stele seldom has the centre filled up with xylem, this being replaced by a large-celled pith, so that a siphonostelic structure is acquired (fig. 15). Sometimes, however, the centre of a bulky root stele has strands of metaxylem (to which may be added strands of metapith) scattered through it, the interstices being filled with conjunctive. The conjunctive of a root-stele possessing a pith is often sclerotized between the pith and the pericycle. Sometimes all the parenchyma within the stele undergoes this change. In the roots of some palms and orchids a "polytelic" structure obtains.

In certain families of Angiosperms a peculiar tissue, called *leuciferous tissue* is met with. This takes the form of long usually



FIG. 18.—Vertical section of a Palm-stem, showing the vascular bundles, fr. curved inwards and then outwards.

richly branched tubes which penetrate the other tissues of the plant mainly in a longitudinal direction. They possess a delicate *laticiferous* layer of protoplasm, with numerous small nuclei lining the walls, while the interior of the tube (corresponding with the cell-vascule) contains a fluid called *latex*, consisting of an emulsion of fine granules and drops of very various substances suspended in a watery medium in which various other substances (salts, sugars, rubber-producers, tannins, alkaloids and various enzymes) are dissolved. Of the suspended substances, grains of caoutchouc, drops of resin and oil, proteid crystals and starch grains may be mentioned. Of this varied mixture of substances some are undoubtedly *plastic* (i.e. of use in constructing new plant-tissue), others are apparently end-products of metabolism, in other words *excreta*, though they are not actually cast out from the plant-body. The relation of the laticiferous tissue to the assimilating cells under which they often end, and the fact that where this tissue is richly developed the conducting parenchyma of the bundles, and sometimes also the sieve-tubes, are poorly developed, as well as various other facts, point to the conclusion that the laticiferous system has an important function in conducting plastic substances, in addition to acting as an excretory reservoir. As a secondary function we may recognize, in certain cases, the power of closing wounds, which results from the rapid coagulation of exuded latex in contact with the air. The use of certain plants as rubber-producers (notably *Hevea brasiliensis*, the Para rubber-tree) depends on this property. The trees are regularly tapped and the coagulated latex which exudes is collected and worked up into rubber. Opium is obtained from the latex of the opium poppy (*Papaver somniferum*), which contains the alkaloid morphine.

Laticiferous tissue is of two kinds: (1) *laticiferous cells* (coenocytes) (fig. 19) which branch but do not anastomose, and the apices of which keep pace in their growth with that of the other tissues of the plant (Apocynaceae, most Euphorbiaceae, &c.); (2) *laticiferous vessels* (fig. 20) which are formed from rows of meristemetic cells, the walls separating the cells breaking down, so that a network of laticiferous tubes arises (Papaveraceae, *Hevea*, &c.). In some cases (*Allium*, Convolvulaceae, &c.) rows of cells with latex-like contents occur, but the walls separating the individual cells do not break down.

(After Haberlandt. From Vines' *Text-Book of Botany*, by permission.)

FIG. 19.—A portion of a laticiferous coenocyte dissected out of the leaf of a Euphorbia

Convolvulaceae, &c.) rows of cells with latex-like contents occur, but the walls separating the individual cells do not break down.

The body of a vascular plant is developed in the first place by repeated division of the fertilized egg and the growth of the products of division. The body thus formed is called the *embryo*, and this develops into the adult plant, not by continued growth of all its parts as in an animal, but by localization of the regions of cell-division and growth, such a localized region being called a *growing-point*. This localization takes place first at the two free ends of the primary axis, the descending part of which is the primary root, and the ascending the primary shoot. Later, the axis branches by the formation of new growing-points, and in this way the complex system of axes forming the body of the ordinary vascular plant is built up. In the flowering plants the embryo, after developing up to a certain point, stops growing and rests, enclosed within the *seed*. It is only on "germination" of the latter that the development of the embryo into the free plant is begun. In the Pteridophytes, on the other hand, development from the egg is continuous.

The triple division of tissues is laid down in most cases at a very early period of development—in the flowering plants usually before the resting stage is reached. In many Pteridophytes the first leaf is formed very early, and the first vascular strand is developed at its base, usually becoming continuous with the cylinder of the root; the strand of the second leaf is formed in a similar way and runs down to join that of the first, so that the stem stele is formed by the joined bases of the leaf-traces. In other cases, however, a continuous primitive stele is developed, extending from the primary stem to the primary root, the leaf-traces arising later. This is

correlated with the comparatively late formation and small development of the first leaves. The evidence scarcely admits of a decision as to which of these methods is to be regarded as primitive in descent. In the seed-forming plants (*Phanerogams*) one or more primary leaves (*cotyledons*) are already formed in the resting embryo. In cases where the development of the embryo is advanced at the resting period, traces run from the cotyledons and determine the symmetry of the stele of the primitive axis, the upper part of which often shows stem-structure, in some respects at least, and is called the hypocotyledonary stem or *hypocotyl*, while the lower part is the primary root

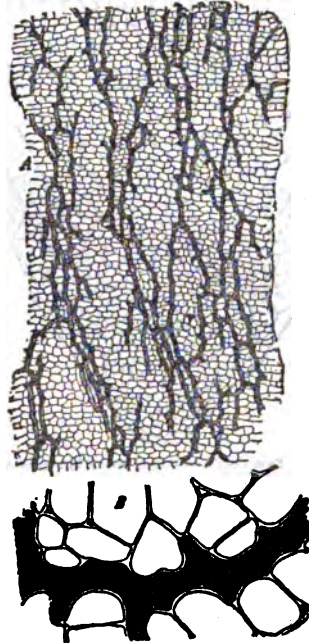

(After Sachs. From Vines' *Text-Book of Botany*, by permission.)

FIG. 20.—Laticiferous Vessels from the cortex of the root *Scorsoneria hispidica*, tangential section

A, Slightly magnified. B, A small portion highly magnified.

(*radicle*). In other cases the root structure of the stele continues up to the cotyledonary node, though the hypocotyl is still to be distinguished from the primary root by the character of its epidermis. On germination of the seed the radicle first grows out, increasing in size as a whole, and soon adding to its tissues by cell division at its apical growing-point. The hypocotyl usually elongates, by its cells increasing very greatly in the longitudinal direction both in number and size, so that the cotyledons are raised into the air as the first foliage-leaves. Further growth in length of the stem is thenceforward confined to the apical growing point situated between the cotyledons. In other cases this growing-point becomes active at once, there being little or no elongation of the hypocotyl and the cotyledon or cotyledons remaining in the seed.

The structure of the growing-points or apical meristems varies much in different cases. In most Pteridophytes there is a single large *apical cell* at the end of each stem and root axis. This usually has the form of a tetrahedron, with its *Growing-point* base occupying the surface of the body of the axis and its apex pointing towards the interior. In the stem, segments are successively cut off from the sides of the tetrahedron, and by their subsequent division the body of the stem is produced. In the root exactly the same thing occurs, but segments are cut off also from the base of the tetrahedron, and by the division of these the root-cap is formed (fig. 21). In both stem and root early walls separate the cortex from the stele. The epidermis in the stem and the surface layer of the root soon becomes differentiated from the underlying tissue. In some Pteridophyte stems the apical cell is wedge-shaped, in others prismatic; in the latter case segments are cut off from the end of the prism turned towards the body of the stem. In other cases, again, a group of two or four prismatic cells takes the place of the apical cell. Segments are then cut off

from the outer sides of these *initial cells*. In most of the Phanerogams the *apical* (or *primary*) *meristem*, instead of consisting of a single apical cell or a group of initials, is stratified—i.e. there is

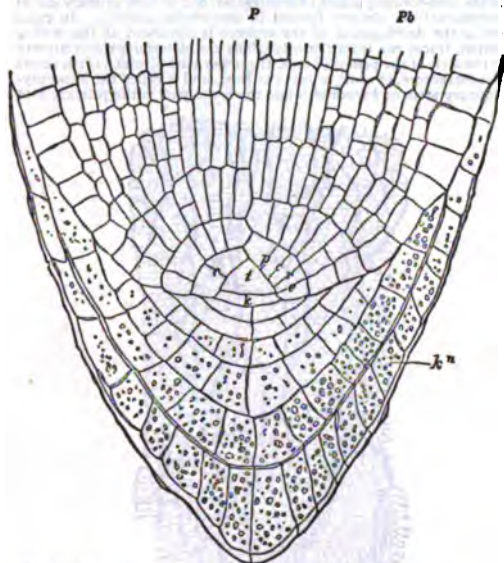

(After Strasburger. From *Vines' Text-Book of Botany*, by permission.)

FIG. 21.—Median Longitudinal Section through the Apex of the Root of *Pteris caesia*.

- i*, Apical cell
k, Initial segment of root-cap.
kn, Outermost layer of root-cap.
β, Wall marking limit between the periblem *P* and the pericycle *Pb*
c, Wall marking the inner limit of the outer cortex.

more than one layer of initials (fig. 22). Throughout the Angiosperms the epidermis of the shoot originates from separate initials, which never divide tangentially, so that the young shoot is covered by a single layer of dividing cells, the *dermatogen*. Below this are

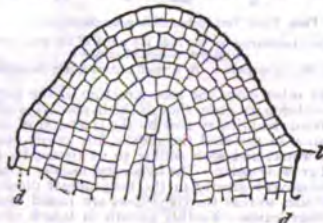

(After De Bary. From *Vines' Text-Book of Botany*, by permission.)

FIG. 22.—Median Longitudinal Section of the Growing Point of the Stem of *Hippuris vulgaris*, showing a many-layered meristem.

- i*, Rudiment of leaf, *d*, dermatogen.

the initials of the cortex and central cylinder. Whether these are always in layers which remain separate is not known, but it is certain that in many cases such layers cannot be distinguished. This, however, may be due to irregularity of division and displacement of the cells by irregular tensions destroying the obvious layered arrangement. In some cases there is a perfectly definite line of separation between the young cylinder (*plerome*) and young cortex (*periblem*), the latter having one or more layers of initials at the actual apex. This clear separation between periblem and plerome is mostly found in plants whose stem-apex forms a naked cone, the leaves being produced relatively late, so that the stele of the young stem is obvious above the youngest leaf-traces (fig. 22). Where the leaves are developed early, they often quite overshadow the actual apex of the stem, and the rapid formation of leaf-tissue disturbs the obviousness of, and perhaps actually destroys, the stratified arrangement of the shoot initials. In this case also,

the differentiation of leaf-bundles, which typically begins at the base of the leaf and extends upwards into the leaf and downwards into the stem, is the first phenomenon in the development of vascular tissue, and is seen at a higher level than the formation of a stele. The latter is produced (except in cases of complete astely where a cylinder is never formed) after a number of leaf-traces have appeared on different sides of the stem so as to form a circle as seen in transverse section, the spaces intervening between adjacent bundles becoming bridged by small-celled tissue closing the cylinder. In this tissue fresh bundles may become differentiated, and what remains of it becomes the rays of the fully-formed stele. Many cases exist which are intermediate between the two extreme types described. In these the stele becomes obvious in transverse section at about the same level as that at which the first leaf-traces are developed. Where a large-celled pith is developed this often becomes obvious very early, and in some cases it appears to have separate initials situated below those of the hollow vascular cylinder. In some cases where there is apparently a well-marked plerome at the apex, this is really the young pith, the distinction between the stelar and cortical initials, if it exists, being, as is so often the case, impossible to make out. The young tissue of the stelar cylinder, in the case of the modified siphonostele characteristic of the dicotyledonous stem, differs from the adjoining pith and cortex in its narrow elongated cells, a difference produced by the stopping of transverse and the increased frequency of longitudinal divisions. This is especially the case in the young vascular bundles themselves (*desmogen strands*). The protoxylem and protophloem are developed a few cells from the inner and outer margins respectively of the desmogen strand, the desmogenic tissue left over giving rise to the segments of endocycle and pericycle capping the bundle. Differentiation of the xylem progresses outwards, of the phloem inwards, but the two tissues never meet in the centre. Sometimes development stops altogether, and a layer of undifferentiated parenchyma (the *mesodem*) is left between them; or it may continue indefinitely, the central cells keeping pace by their tangential division with the differentiation of tissue on each side. In this case the formation of the primary bundle passes straight over into the formation of secondary tissue by a cumbium, and no line can be drawn between the two processes. The differentiation of the stelar stereom, which usually takes the form of a sclerized pericycle, and may extend to the endocycle and parts of the rays, takes place in most cases later than the formation of the primary vascular strand. In the very frequent cases where the bundles have considerable individuality, the fibrous "pericyclic" cap very clearly has a common origin from the same strand of tissue as the vascular elements themselves. In such cases it is part of the peridem or sheath of elongated narrow-celled tissue surrounding the individual bundle.

The separation of layers in the apical meristem of the root is usually very much more obvious than in that of the stem. The outermost is the *calyptra*, which gives rise to the root-cap, and in Dicotyledons to the piliferous layer as well. The *periblem*, one cell thick at the apex, produces the cortex, to which the piliferous layer belongs in Monocotyledons; and the *plerome*, which is nearly always sharply separated from the periblem, gives rise to the vascular cylinder. In a few cases the boundaries of the different layers are not traceable. The protoxylems and the phloem strands are developed alternately, just within the outer limit of the young cylinder. The differentiation of metaxylem follows according to the type of root-stele, and, finally, any stereom there may be is developed. Differentiation is very much more rapid—i.e. the tissues are completely formed much nearer to the apex, than is the case in the stem. This is owing to the elongating region (in which protoxylem and protophloem alone are differentiated) being very much shorter than in the stem. The root hairs grow out from the cells of the piliferous layer immediately behind the elongating region.

The branches of the stem arise by multiplication of the cells of the epidermis and cortex at a given spot giving rise to a protuberance, at the end of which an apical meristem is established. The vascular system is connected in various ways with that of the parent axis by the differentiation of bundle-connexions across the cortex of the latter. This is known as *exogenous* branch-formation. In the root, on the other hand, the origin of branches is *endogenous*. The cells of the pericycle, usually opposite a protoxylem strand, divide tangentially and give rise to a new growing-point. The new root thus laid down burrows through the cortex of the mother-root and finally emerges into the soil. The connexions of its stele with that of the parent axis are made across the pericycle of the latter. Its cortex is never in connexion with the cortex of the parent, but with its pericycle. *Adventitious roots*, arising from stems, usually take origin in the pericycle, but sometimes from other parts of the conjunctive.

In most of the existing Pteridophytes, in the Monocotyledons, and in annual plants among the Dicotyledons, there is no further growth of much structural importance in the tissues after differentiation from the primary meristem. But in nearly all perennial Dicotyledons, in all dicotyledonous and gymnospermous trees and shrubs,

Secondary
 Trunks.

and in fossil Pteridophytes belonging to all the great groups, certain layers of cells remain meristematic among the permanent tissues, or after passing through a resting stage reacquire meristematic properties, and give rise to *secondary tissues*. Such meristematic layers are called *secondary meristems*. There are two chief secondary meristems, the *cambium* and the *phellogen*. The formation of secondary tissues is characteristic of most woody plants, to whatever class they belong. Every great group or phylum of vascular plants, when it has become dominant in the vegetation of the world, has produced members with the tree habit arising by the formation of a thick woody trunk, in most cases by the activity of a cambium.

The *cambium* in the typical case, which is by far the most frequent, continues the primary differentiation of xylem and phloem in the desmogen strand (see above), or arises in the resting mesoderm or mesocycle and adds new (secondary) xylem and phloem to the primary tissues. New tangential walls arise in the cells which are the seat of cambial activity, and an *initial layer* of cells is established which cuts off *tissue mother-cells* on the inside and outside, alternately contributing to the xylem and to the phloem. A tissue mother-cell of the xylem may, in the most advanced types of Dicotyledons, give rise to—(1) a tracheid, (2) a segment of a vessel; (3) a xylem-fibre, or (4) a vertical file of xylem-parenchyma cells. In the last case the mother-cell divides by a number of horizontal walls. A tissue mother-cell of the phloem may give rise to (1) a segment of a sieve-tube with its companion cell or cells; (2) a phloem fibre; (3) a single phloem-parenchyma (cambiform) cell, or a vertical file of short parenchyma cells. At certain points the cambium does not give rise to xylem and phloem elements, but cuts off cells on both sides which elongate radially and divide by horizontal walls. When a given initial cell of the cambium has once begun to produce cells of this sort it continues the process, so that a radial plate of parenchyma cells is formed stretching in one plane through the xylem and phloem. Such a cell-plate is called a *medullary ray*. It is essentially a living tissue, and serves to place all the living cells of the secondary vascular tissues in communication. It conducts plastic substances inwards from the cortex, and its cells are frequently full of starch, which they store in winter. They are accompanied by intercellular channels serving for the conduction of oxygen to, and carbon dioxide from, the living cells in the interior of the wood, which would otherwise be cut off from the means of respiration. The xylem and phloem parenchyma consist of living cells, fundamentally similar in most respects to the medullary ray cells, which sometimes replace them altogether. The parenchyma is often arranged in tangential bands between the layers of sieve-tubes and tracheal elements. The xylem parenchyma is often found in strands associated with the tracheal elements. These strands are not isolated, but form a connected network through the wood. The xylem parenchyma cells are connected, as are the medullary ray cells, with the tracheal elements by one-sided bordered pits—*s.e.* pits with a border on the tracheal element side, and simple on the parenchyma cell side. The fibres are frequently found in tangential bands between similar bands of tracheae or sieve-tubes. The fibrous bands are generally formed towards the end of the year's growth in thickness. The fibres belong to the same morphological category as the parenchyma, various transitions being found between them; thus there may be thin-walled cells of the shape of fibres, or ordinary fibres may be divided into a number of superposed cells. These intermediate cells, like the ordinary parenchyma, frequently store starch, and the fibres themselves, though usually dead, sometimes retain their protoplasm, and in that case may also be used for starch accumulations. The vessels and tracheids are very various in size, shape and structure in different plants. They are nearly always aggregated in strands, which, like those of the parenchyma, are not isolated, but are connected with one another. In a few cases some of the tracheids have very thick walls and reduced cavities, functioning as mechanical rather than as water-conducting elements. All transitions are found between such forms and typical tracheids. These *fibre-tracheids* are easily confused on superficial view with the true wood-fibres belonging to the parenchymatous system; but their pits are always bordered, though in the extreme type they are reduced to mere slits in the wall. The sieve-tubes of the secondary phloem usually have very oblique end-walls bearing a row of sieve-plates; plates also occur on the radial side-walls.

The tissue-elements just described are found only in the more complicated secondary vascular tissues of certain Dicotyledons. A considerable evolution in complexity can be traced in passing from the simplest forms of xylem and phloem found in the primary vascular tissues both among Pteridophytes and Phanerogams to these highly differentiated types. In the simplest condition we have merely tracheae and sieve-tubes, respectively associated with parenchyma, which in the former case is usually amyloem. *s.e.* consists of starch-containing cells, and in the latter of proteid cells. This type is found in nearly all Pteridophytes and, so far as is known, in Cycadofilices, both in primary and secondary tissue. The stereom

is furnished either by cortical cells or by the tracheal elements, in a few cases by fibres which are probably homologous with sieve-tubes. Among Gymnosperms the secondary xylem is similarly simple, consisting of tracheids which act as stereom as well as hydrom, and a little amyloem; while the phloem-parenchyma sometimes undergoes a differentiation, part being developed as amyloem, part as proteid cells immediately associated with the sieve-tube. In other cases the proteid cells of the secondary phloem do not form part of the phloem-parenchyma, but occupy the top and bottom cell-rows of the medullary rays, the middle rows consisting of ordinary starchy cells. The top and bottom rows of the xylem rays are often developed as irregularly-thickened radially-elongated tracheids which serve for the radial conduction of water, and communicate with the ordinary tracheids of the secondary xylem by large bordered pits. The primary vascular tissues of Angiosperms are likewise nearly always simple, consisting merely of tracheae and sieve-tubes often associated with amyloem. A characteristic peculiarity, both

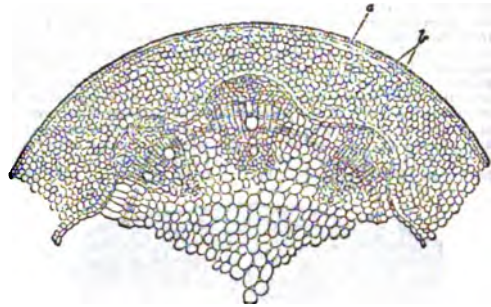

(From Green's *Vegetable Physiology*, by permission.)

FIG. 23.—Section of part of hypocotyledonary stem of *Ricinus communis*.

a, Starch sheath, at the extremities of the figure its cells are represented as empty; b, cambium layer.

in the primary and secondary tissue, is that the proteid cells of the phloem are here always sister-cells of the leptoids and are known as *companion-cells*. In the secondary tissues of Dicotyledons we may have, as already described, considerably more differentiation of the cells, all the varieties being referable, however, on the one hand to the tracheal or sieve-tube type, on the other to the parenchyma type. The main feature is the development of special vascular stereom and storage tissue. In some cases special secreting tissues, resin ducts, oil glands, laticiferous tissue, crystal sacs, &c., may be developed among the ordinary secondary vascular elements.

The limit of each year's increment of secondary wood, in those plants whose yearly activity is interrupted by a regular winter or dry season, is marked by a more or less distinct *Annual Ring* line, which is produced by the sharp contrast between the wood formed in the late summer of one year (characterized by the sparseness or small diameter of the tracheal elements, or by the preponderance of fibres, or by a combination of these characters, giving a denseness to the wood) and the loose spring wood of the next year, with its absence of fibres, or its numerous large tracheae. The abundance of water-conducting channels is in relation to the need for a large and rapid supply of water to the unfolding leaves in the spring and early summer. In Gymnosperms, where vessels and fibres are absent, the late summer wood is composed of radially narrow thick-walled tracheids, the wood of the succeeding spring being wide-celled and thin-walled, so that the limit of the year's growth is very well marked. The older wood of a large tree forming a cylinder in the centre of the trunk frequently undergoes marked changes in character. The living elements die, and the walls of all the cells often become hardened, owing to the deposit in them of special substances. Wood thus altered is known as heart-wood, or *duramen*, as distinguished from the young sap-wood, or *alburnum*, which, forming a cylinder next the cambium, remains alive and carries on the active functions of the xylem, particularly the conduction of water. The heart-wood ceases to be of any use to the tree except as a support, but owing to its dryness and hardness it alone is of much use for industrial purposes. The great hardness of oak is due to the silica deposited in the heart-wood, and the special colouring matters of various woods, such as satinwood, ebony, &c., are confined to the heart-wood. In some cases the heart-wood, instead of becoming specially hard, remains soft and easily rots, so that the trunk of the tree frequently becomes hollow, as is commonly the case in the willow. Heart-wood is first formed at very different epochs in the life of a tree, according to the species—*e.g.* after fifteen to twenty years in the oak, forty years in the ash, &c.

In many annual plants no cambium is formed at all, and the same is true of most perennial Pteridophytes and Monocotyledons.

Cambium in Stems. When the vascular tissue of such plants is arranged in separate bundles these are said to be *closed*. The bundles of plants which form cambium are, on the contrary, called *open*. In stems with open bundles the formation of cambium and secondary tissue may be confined to these, when it is said to be entirely *fascicular*. In that case either very little secondary tissue is formed, as in the gourds, some Ranunculaceae, &c., or a considerable amount may be produced (clematis, barberry, ivy). In the latter event the cells of the primary rays are either merely stretched radially, or they divide to keep pace with the growth of the bundles. If this division occurs by means of a localized secondary meristem connecting the cambial layers of adjacent bundles, an *interfascicular* is formed in addition to the fascicular cambium. The interfascicular cambium may form nothing but parenchymatous tissue, producing merely continuations of the primary rays. Such rays are usually broader and more conspicuous than the secondary rays formed within the wedges of wood opposite the primary bundles, and are distinguished as *principal rays* from these narrower *subordinate* or *fascicular rays* (fig. 24). This is the typical case in most trees where the primary bundles are close together. Where the primary bundles are farther apart, so that the primary rays are wider, the interfascicular cambium may form several fairly broad (principal) secondary rays in continuation of certain radial bands of the primary ray, and between these, wedges of secondary xylem and phloem; or, finally, secondary xylem and phloem may be formed by the whole circumference of the cambium, fascicular and interfascicular alike, interrupted only by narrow secondary rays, which have no relation to the primary ones.

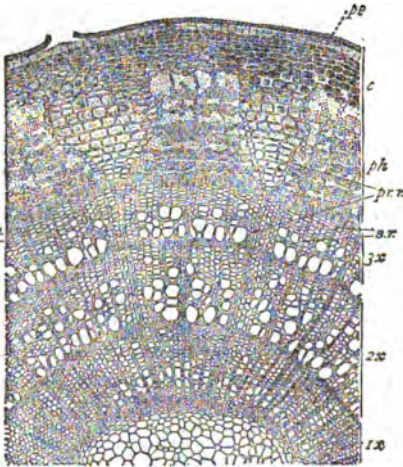

(After Kuy, from Green's *Vegetable Physiology*, by permission.)

FIG. 24.—Section of three-year-old stem of Linnæa.

ca, periderm; c, cortex; ph, phloem with alternating strands of fibres, sieve-tubes and parenchyma, pr, principal ray; sr, subordinate ray; ca, cambium.

In a good many cases, sometimes in isolated genera or species, sometimes characteristic of whole families, so-called *anomalous cambial layers* are formed in the stem, either as an extension of, or in addition to, the original cambial cylinder. They are frequently associated with irregularities in the activity of the original cambium. Irregularity of cambium occurs in various families of woody dicotyledonous plants, mostly among the woody climbers, known as *lianes*, characteristic of tropical and sub-tropical forests. In the simplest cases the cambium produces xylem more freely along certain tracts of the circumference than along others, so that the stem loses its original cylindrical form and becomes elliptical or lobed in section. In others the secondary phloem is produced more abundantly in those places where the secondary xylem is deficient, so that the stem remains cylindrical in section, the phloem occupying the bays left in the xylem mass. Sometimes in such cases the cambium ceases to be active round these bays and joins across the outside of the bay, where it resumes its normal activity, thus isolating a phloem strand, or, as it is sometimes called, a *phloem island*, in the midst of the xylem. The significance of these phenomena, which present many minor modifications in different cases, is not fully understood, but one purpose of the formation of phloem promontories and islands seems to be the protection of the sieve-tubes from crushing by the often considerable peripheral pressure that is exercised on the

stems of these lianes. Sometimes the original cambial ring is broken into several arcs, each of which is completed into an independent circle, so that several independent secondary vascular cylinders are formed. The formation of additional cambial cylinders or bands occurs in the most various families of Dicotyledons and in some Gymnosperms. They may arise in the pericycle or endocycle of the stele, in the cortex of the stem, or in the parenchyma of the secondary xylem or phloem. The activity of the new cambium is often associated with the stoppage of the original one. Sometimes the activity of the successive cambiums simply results in the formation of concentric rings or arcs of secondary xylem and phloem. In other cases a most intricate arrangement of secondary tissue masses is produced, quite impossible to interpret unless all stages of their development have been followed. Sometimes in lianes the whole stem breaks up into separate woody strands, often twisted like the strands of a rope, and running into one another at intervals. An ordinary cambium is scarcely ever found in the Monocotyledons, but in certain woody forms a secondary meristem is formed outside the primary bundles, and gives rise externally to a little secondary cortex, and internally to a secondary parenchyma in which are developed numerous zones of additional bundles, usually of concentric structure, with phloem surrounded by xylem.

The cambium in the root, which is found generally in those plants which possess a cambium in the stem, always begins in the conjunctive tissue internal to the primary phloems, and **Cambium in Roots,** forms new (secondary) phloem in contact with the primary, and secondary xylem internally. In roots which thicken but slightly, whose cambium usually appears late, it is confined to these regions. If the development of secondary tissues is to proceed further, arcs of cambium are formed in the pericycle external to the primary xylems, and the two sets of cambial arcs join, forming a continuous, wavy line on transverse section, with bays opposite the primary phloems and promontories opposite the primary xylems. Owing to the resistance offered by the hard first-formed secondary xylem, the bays are pushed outwards as growth proceeds, and the wavy line becomes a circle. Opposite the primary xylems, the cambium either (a) forms parenchyma on both sides, making a broad, secondary (principal) ray, which interrupts the vascular ring and is divided at its inner extremity by the islet of primary xylem; or (b) forms secondary xylem and phloem in the ordinary way, completing the vascular ring. In either case, narrow, secondary rays are formed at intervals, just as in the stem. Thus the structure of an old thickened root approximates to that of an old thickened stem, and so far as the vascular tissue is concerned can often only be distinguished from the latter by the position and orientation of the primary xylems. The cambium of the primary root, together with the tissues which it forms, is always directly continuous with that of the primary stem, just in the same way as the tissues of the primary stele. The so-called anomalous cambiums in roots follow the same lines as those of the stem.

In nearly all plants which produce secondary vascular tissues by means of a cambium there is another layer of secondary meristem arising externally to, but in quite the same fashion as, the cambium, and producing like the latter an external and an internal secondary tissue. This is the **phellogen**, and the whole of the tissue it gives rise to is known as **phellogen**, **Periderm**. The phellogen derives its name from the fact that its external product is the characteristic tissue known as **cork**. This consists typically of close-fitting layers of cells with completely suberized walls, intended to replace the epidermis as the external protective layer of the plant when the latter, incapable as it is of further growth after its original formation, is broken and cast off by the increase in thickness of the stem through the activity of the cambium. Cork is also formed similarly in the root after the latter has passed through its primary stage as an absorptive organ, and its structure is becoming assimilated to that of the stem. The internal tissue formed by the phellogen is known as **phellogen**, and consists usually of ordinary parenchyma. The phellogen may arise, in the first place, in any tissue of the axis external to the actual vascular tissues—i.e. in the epidermis itself (rarely), in any layer of the cortex, or in the pericycle. Its most usual seat of origin in the stem is the external layer of the cortex immediately below the epidermis, in the root, the pericycle. All the tissues external to the cork are cast off by the plant. The extent of development of the phellogen is dependent upon whether the phellogen has a superficial or a deep-seated origin. In the former case the formation of phellogen is trivial in amount; in the latter, considerable, since this tissue has to replace the cast-off cortex, as a metabolic and particularly a storage tissue.

Provision is made for gaseous interchange between the internal tissues and the external air after the formation of cork, by the development of **lenticels**. These are special organs which interrupt the continuity of the impermeable layer of **Lenticels**, ordinary cork-cells. A lenticel is formed by the phellogen at a given spot dividing very actively and giving rise to a loose tissue of rounded cells which soon lose their contents, and between which air can pass to the tissues below (fig. 25). A lenticel appears to the naked eye as a rounded or elongated scar, often forming a distinct prominence on the surface of the organ. The lenticels of the stem are usually formed beneath stomata, whose function they take up after the

stomata have been ruptured and cast off with the rest of the epidermis. Both cork and phelloderm may be differentiated in various ways. The former often has its cells lignified, and may consist of alternate layers of hard and soft cells. The latter may develop stereom, and may also be the seat of origin of new formations of various kinds—e.g. supplementary vascular bundles, anomalous cambial zones, &c. It is often enormously developed and forms a very important tissue in roots. In the stem of a tree the original

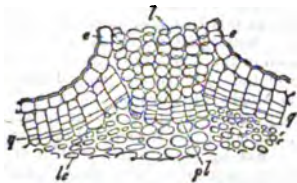

(From Vines' *Text-Book of Botany*, by permission.)

FIG. 25.—Lenticel in the transverse section of a twig of Elder.

e, epidermis; *g*, phellogen; *f*, cells, and *M*, the phellogen of the lenticel; *k*, cortical parenchyma, containing chlorophyll.

phellogen is replaced by successive new phellogenic layers of deeper and deeper origin, each forming its own layer of cork. Eventually the new phellogens reach the level of the secondary phloem, and are formed in the parenchyma of the latter, keeping pace in their inward march with the formation of fresh secondary phloem by the cambium. The complex system of dead and dying tissues cut off by these successive periderms, together with the latter themselves—in fact, everything outside the innermost phellogen, constitutes what is often known botanically as the *bark* of the tree. *Rhytidome* is, however, a preferable term, as the word bark has long been established in popular usage to mean all the tissue that can easily be peeled off—i.e. everything down to the wood of the tree. The rough surface of the bark of many trees is due to the successive phellogens not arising in regular concentric zones, but forming in arcs which join with the earlier-formed arcs, and thus causing the bark to come off in flakes or thick chunks. A layer of cork is regularly formed in most Phanerogams across the base of the petiole before leaf fall, so as to cover the wound caused by the separation of the leaf from the stem. Special "wound-cork" is also often formed round accidental injuries so as to prevent the rotting of the tissues by the soaking in of rain and the entrance of fungal spores and bacteria. A peculiar modification of periderm is formed by the phellogen in the submerged organs (roots or stems) of many aquatic or marsh-loving plants. This may take various forms and may cover the whole of the organ or be localized in special regions; but its cells are always living and are separated by very large intercellular spaces containing air. This tissue is called *aerenchyma*, and no doubt its function is to facilitate the respiration of the organs on which it is formed and to which the access of oxygen is difficult. In other cases, a similar formation of spongy but dead periderm tissue may occur for the same purpose in special patches, called *pneumatodes*, on the roots of certain trees living in marshy places, which rise above the soil in order to obtain air.

History and Bibliography.—The study of plant anatomy was begun in the middle of the seventeenth century as a direct result of the construction of microscopes, with which a clear view of the structure of plant tissues could be obtained. The Englishman Grew and the Italian Malpighi almost simultaneously published illustrated works on the subject, in which they described, for the most part very accurately, what they saw with the new instruments. The subject was practically dormant for nearly a century and a half, largely owing to the dominance of classificatory botany under the influence of Linnæus. It was revived by several German workers, prominent among whom were Treviranus and Link, and later Moldenhawer, as well as by the Frenchmen Mirbel, at the beginning of the 19th century. The new work largely centred round a discussion of the nature and origin of *vessels*, conspicuous features in young plant tissues which thus acquired an importance in the contemporary literature out of proportion to their real significance in the construction of the vascular plant. The whole of the writings of this time are dominated by a preoccupation with the functions of the different tissues, in itself an excellent standpoint for investigation, but frequently leading in the case of these early investigators to one-sided and distorted views of the facts of structure. The pioneer of modern plant anatomy was Hugo von Mohl (*fl.* 1840), who carefully investigated and

described the facts of anatomical structure without attempting to fit them into preconceived views of their meaning. He produced a solid body of accurately described facts which has formed the secure groundwork of subsequent advance. From Mohl down to the eighth decade of the century the study of anatomy was entirely in the hands of a group of German investigators, prominent among whom were several of the most eminent founders of modern scientific botany—such, for instance, as Nägeli, Sanio and De Bary. To the first we owe the secure foundation of our knowledge of the structure and course of the vascular strands of the higher plants ("Ueber den Bau und die Anordnung der Gefäßbündel bei den Stamm und Wurzel der Phanerogamen," *Beiträge zur wissenschaftlichen Botanik*, Heft i., Leipzig, 1859); to the second the establishment of the sound morphological doctrine of the central cylinder of the axis as the starting-point for the consideration of the general arrangement of the tissues, and the first clear distinction between primary and secondary tissues (*Botanische Zeitung*, 1861 and 1863); to the last the putting together of the facts of plant anatomy known up to the middle of the eighth decade of the century in that great encyclopaedia of plant anatomy, the *Vergleichende Anatomie der Vegetationsorgane bei den Phanerogamen und Farnen* (Stuttgart, 1876; Eng. trans., *Comparative Anatomy of the Vegetative Organs of the Phanerogams and Ferns*, Oxford, 1882). In 1870-1871 Van Tieghem published his great work, "Sur la Racine," *Ann. sci. nat.* (Paris). This was not only in itself an important contribution to plant anatomy, but served as the starting-point of a series of researches by Van Tieghem and his pupils, which has considerably advanced our knowledge of the details of histology, and also culminated in the foundation of the doctrine of the stele (Van Tieghem and Douliot, "Sur la polystélie," *Ann. sci. nat. bot.*, 1887; Van Tieghem, *Traité de botanique* (2nd ed. Paris, 1880-1891). This has had a most important effect on the development in recent years of morphological anatomy.

In the progress of the last three decades, since the publication of De Bary's great work, five or six main lines of advance can be distinguished. First, the knowledge of the details *Modern* of histology has of course advanced greatly in the *Progress* of direction through the ceaseless activity of very *the Subject* numerous, mainly German, workers, though no fundamentally new types of tissue have been discovered. Secondly, the histology of fossil plants, particularly woody plants of the carboniferous period, has been placed on a sound basis, assimilated with general histological doctrine, and has considerably enlarged our conceptions of plant anatomy as a whole, though again without revealing any entirely new types of structure. This branch of the subject, founded by Corda, Göppert, Stenzel and others in Germany, was enormously advanced by Williamson's work on the Coal Measures plants, recorded in the magnificent series of memoirs, "Researches on the Organization of Fossil Plants of the Coal Measures" (*Phil. Trans. Roy. Soc.*, vols. i.-xix., 1871-1893). The work of Solms Laubach in Germany, Renault and Bertrand in France, and in recent years, of Zeiller in France, and Scott, Seward and others in England, has advanced our knowledge of the anatomy of fossil plants in an important degree. While convincing us that the plants of past ages in the earth's history were exposed to very similar conditions of life, and made very much the same adaptive responses as their modern representatives, one of the main results of this line of work has been to reveal important data enabling us to fill various gaps in our morphological knowledge and to obtain a more complete picture of the evolution of tissues in the vascular plants. One of the most striking incidents in the progress has been the recognition within the last few years of the existence of an extinct group of plants lying on the borderland between Filicales and Gymnosperms, and known as the Cycadoflites, a group in which, curiously enough, the reproductive organs remained undiscovered for some time after the anatomy of the vegetative organs was sufficiently well known to afford clear evidence of their true affinities. Thirdly, we have to record very considerable

progress in our knowledge of distinctively morphological anatomy, *i.e.* the study of tissues from the standpoint of evolution. The Russian plant-anatomist, Russow, may be said to have founded the consideration of plant tissues from the point of view of descent (*Vergleichende Untersuchungen über die Leitbündelkryptogamen*, St Petersburg, 1872, and *Betrachtungen über Leitbündel und Grundgewebe*, Dorpat, 1875). He was ably followed by Strasburger (*Ueber den Bau und die Verrichtungen der Leitungsbahnen in den Pflanzen*, Jena, 1891), Haberlandt and others. The explicit adoption of this point of view has had the effect of clearing up and rendering definite the older morphological doctrines, which for the most part had no fixed criterion by which they could be tested.

Since about 1895 this branch has been most actively pursued in England, where the work of Boodle and of Gwynne-Vaughan especially on Ferns) has been the most important, leading to a coherent theory of the evolution of the vascular system in these plants (Tansley, *Evolution of the Filicanean Vascular System*, Cambridge, 1908); and in America, where Jeffrey has published important papers on the morphology of the vascular tissues of the various groups of Pteridophytes and Phanerogams and has sought to express his conclusions in a general morphological theory with appropriate terminology. As a result of this activity Van Tieghem's so-called "Stelar theory" has been revised and modified in the light of more extended and detailed anatomical and developmental knowledge. Schoute's *Die Stelr-Theorie* (Gröningen, 1902), gives an important critical account of this subject.

Fourthly, attention must be called to the great development of what is called "Systematic Anatomy," *i.e.* the study of the anatomical features characteristic of the smaller groups of flowering plants, *i.e.* the orders, families, genera and species. Radlkofer (1883) was the first to call attention to the great importance of this method in systematic botany, as providing fresh characters on which to base a natural classification. Solereder's great work, *Systematische Anatomie der Dicotyledonen* (Stuttgart, 1898-1908; Eng. trans., *Systematic Anatomy of Dicotyledons*, Oxford, 1908), brings together so many of the facts as are at present known in an orderly arrangement. Theoretically this branch of the subject should connect with and form the completion of "morphological anatomy," but the field has not yet been sufficiently explored to allow of the necessary synthesis. The true relation of "systematic" to "ecological" anatomy (see below) also awaits proper elucidation.

Fifthly, we have to record the foundation of the modern study of "physiological anatomy" (*i.e.* the study of the specific functions of the various tissues) by Schwendener (*Das mechanische Princip im Bau der Monocotylen*, 1874, and other works), followed by numerous pupils and others, among whom Haberlandt (*Physiologische Pflanzen-Anatomie*, Leipzig, 1st ed., 1884, 4th ed., 1909, and other works) is pre-eminent. The pursuit of this study has not only thrown valuable light on the economy of the plant as a whole, but forms an indispensable condition of the advance of morphological anatomy. A great deal of work still remains to be done in this department, which at the present time affords one of the most promising fields of anatomical investigation.

Finally we may mention "ecological anatomy," *i.e.* the study of anatomical features directly related to the habitat. A very considerable body of knowledge relating to this subject already exists, but further work on experimental lines is urgently required to enable us to understand the actual economy of plants growing under different conditions of life and the true relation of the hereditary anatomical characters which form the subject matter of "systematic anatomy" to those which vary according to the conditions in which the individual plant is placed. On these lines the future of anatomical study presents almost inexhaustible possibilities.

(A. G. T.)

PHYSIOLOGY OF PLANTS

The so-called *vegetable physiology* of a generation ago was in arrears of *animal*, and particularly of *human*, physiology, the

study of the latter being followed by many more observers, and from its relative degree of advancement being the more capable of rapid development. It was fully recognized by its followers that the dominating influence in the structure and working of the body was the protoplasm, and the division of labour which it exhibited, with the accompanying or resulting differentiation into various tissues, was the special subject of investigation. Many who followed the study of vegetable structure did not at that time give an equal prominence to this view. The early histological researches of botanists led them to the recognition of the vegetable cell, and the leading writers in the middle of the 19th century pointed out the probable identity of Von Mohl's "protoplasm" with the "sarcode" of zoologists. They laid great stress on the nitrogenous nature of protoplasm, and noted that it preceded the formation of the cell-membrane. But by the ordinary student of thirty years later their work was to some extent overlooked, and the *cell-wall* assumed a prominence to which it was not entitled. The study of the *differentiation* of protoplasm was at that time seldom undertaken, and no particular attention was paid either to fixing it, to enable staining methods to be accurately applied to it, or to studying the action of chemical reagents upon it. It is only comparatively recently that the methods of histological investigation used by animal physiologists have been carefully and systematically applied to the study of the vegetable organisms. They have, however, been attended with wonderful results, and have revolutionized the whole study of vegetable structure. They have emphasized the statements of Von Mohl, Cohn, and other writers alluded to, that the protoplasm is here also the dominant factor of the body, and that all the peculiarities of the cell-wall can only be interpreted in the light of the needs of the living substance.

The Nature of the Organization of the Plant, and the Relations of the Cell-Membrane and the Protoplasm.—This view of the structure of the plant and this method of investigation lead us to a greatly modified conception of its organization, and afford more completely an explanation of the peculiarities of form found in the vegetable kingdom.

The study of simple organisms, many of which consist of nothing but a little mass of protoplasm, exhibiting a very rudimentary degree of differentiation, so far as our methods enable us to determine any at all, shows that the duties of existence can be discharged in the absence of any cell-wall. Those organisms which possess the latter are a little higher in the scale of life than those which remain unclothed by it, but a comparison of the behaviour of the two quickly enables us to say that the membrane is of but secondary importance, and that for those which possess it, it is nothing more than a protective covering for the living substance. Its physical properties, permeability by water, extensibility and elasticity, receive their interpretation in the needs of the latter. We come, accordingly, to regard it as practically an exoskeleton, and its functions as distinctly subordinate to those of the protoplasm which it clothes. If we pass a little higher up the scale of life we meet with forms consisting of two or more cells, each of which contains a similar minute mass of living substance. A study of them shows that each is practically independent of the others; in fact, the connexion between them is so slight that they can separate and each become free without the slightest disadvantage to another. So long as they are connected together mechanically they have apparently the power of influencing one another in various ways, and of passing liquid or gaseous materials from one to another. The conjoined organism is, in fact, a colony or association of the protoplasmic units, though each unit retains its independence. When we pass, again, from these to examine more bulky, and consequently more complex, plants, we find that the differences which can be observed between them and the simple lowly forms are capable of being referred to the increased number of the protoplasmic units and the consequent enlarged bulk of the mass or colony. Every plant is thus found to be composed of a number of these protoplasmic units, or, as they may preferably be termed,

protoplasts, all of which are at first exactly alike in appearance and in properties. This is evident in the case of such plants as have a body consisting of filaments or plates of cells, and is little less conspicuous in those whose mass is but small, though the cells are evidently capable of computation in three dimensions. It does not at first appear to be the same with the bulkier plants, such as the ordinary green herbs, shrubs or trees, but a study of their earlier development indicates that they do not at the outset differ in any way from the simple undifferentiated forms. Each commences its existence as a simple naked protoplast, in the embryo-sac or the archegonium, as the case may be. After the curious fusion with another similar protoplast, which constitutes what we call fertilization, the next stage in complexity already noted may be observed, the protoplasm becoming clothed by a cell-membrane. Very soon the single cell gives rise to a chain of cells, and this in turn to a cell mass, the individual units of which are at first quite uniform. With increase of number, however, and consequently enlargement of bulk in the colony, differentiation becomes compulsory. The requirements of the several protoplasts must be met by supplies from without, and, as many of them are deep seated, varieties of need arise, so that various members of the colony are set apart for special duties, masses of them being devoted to the discharge of one function, others to that of another, and so on. Such limitations of the powers and properties of the individuals have for their object the well-being of the community of which those individuals are constituents.

Physiological and Morphological Differentiation.—The first indication of this differentiation in the vegetative body of the plant can be seen not only in the terrestrial green plants which have been particularly referred to, but also in the bulkier seaweeds. It is an extension of the first differentiation which was observable in the simple protoplasts first discussed, the formation, that is, of a protective covering. *Fucus* and its allies, which form conspicuous members of the larger Algae, have their external cells much smaller, more closely put together, and generally much denser than the rest of their tissue. In the lowly as well as the higher green plants we have evidence of specialization of the external protoplasts for the same purpose, which takes various shapes and shows different degrees of completeness, culminating in the elaborate barks which clothe our forest trees.

The second prominent differentiation which presents itself takes the form of a provision to supply the living substance with water. This is a primal necessity of the protoplast, and every cell gives evidence of its need by adopting one of the various ways in which such need is supplied. What little differentiation can be found to exist in the protoplasm of the simple unicellular organism shows the importance of an adequate water-supply, and indeed, the dependence of life upon it. The naked cells which have been alluded to live in water, and call therefore for no differentiation in connexion with this necessity; but those which are surrounded by a cell-wall always develop within themselves a *vacuole* or cavity which occupies the greater part of their interior, and the hydrostatic pressure of whose contents keeps the protoplasm in contact with the membrane, setting up a condition of turgidity.

The need for a constant supply of water is partly based upon the constitution of protoplasm, so far as we know it. The apparently structureless substance is saturated with it; and if once a cell is completely dried, even at a low temperature, in the enormous majority of cases its life is gone and the restoration of water fails to enable it to recover. Besides this intimate relationship, however, we can point to other features of the necessity for a constantly renewed water supply. The protoplasm derives its food from substances in solution in the water; the various waste products which are incident to its life are excreted into it, and so removed from the sphere of its activity. The raw materials from which the food is constructed are absorbed from the exterior in solution in water, and the latter is the medium through which the gaseous constituents necessary for life reach the protoplasm. Moreover, growth is essentially

dependent upon water-supply. There is little wonder, then, that in a colony of protoplasts such as constitute a large plant a considerable degree of differentiation is evident, bearing upon the question of water supply. Certain cells of the exterior are set apart for absorption of water from the soil, this being the source from which supplies are derived. Others are devoted to the work of carrying it to the protoplasts situated in the interior and at the extremities of the plant, a *conducting system* of considerable complexity being the result.

Other collections of cells are in many cases set apart for giving rigidity and strength to the mass of the plant. It is evident that as the latter increases in bulk, more and more attention must be paid to the dangers of uprooting by winds and storms. Various mechanisms have been adopted in different cases, some connected with the subterranean and others with the sub-aerial portions of the plant. Another kind of differentiation in such a cell-mass as we are dealing with is the setting apart of particular groups of cells for various metabolic purposes. We have the formation of numerous mechanisms which have arisen in connexion with the question of food supply, which may not only involve particular cells, but also lead to differentiation in the protoplasm of those cells, as in the development of the chloroplastids of the leaves and other green parts.

The inter-relations of the members of a large colony of protoplasts such as constitute a tree, demand much adjustment. Relations with the exterior are continually changing, and the needs of different regions of the interior are continually varying, from time to time. Two features which are essentially protoplasmic assume a great importance when we consider these relations. They are the power of receiving impressions or stimuli from the exterior, and of communicating with each other, with the view of co-ordinating a suitable response. We have nothing structural which corresponds to the former of these. In this matter, differentiation has proceeded very differently in animals and plants respectively, no nerves or sense organs being structurally recognizable. Communication between the various protoplasts of the colony is, however, carried on by means of fine protoplasmic threads, which are continuous through the cell-walls.

All the peculiarities of structure which we encounter consequently support the view with which we started, that the protoplasm of the plant is the dominant factor in vegetable structure, and that there need be but one subject of physiology, which must embrace the behaviour of protoplasm wherever found. There can be no doubt that there is no fundamental difference between the living substance of animals and plants, for many forms exist which cannot be referred with certainty to either kingdom. Free-swimming organisms without cell-membranes exist in both, and from them series of forms can be traced in both directions. Cellulose, the material of which vegetable cell-walls are almost universally composed, at any rate in their early condition, is known to occur, though only seldom, among animal organisms. Such forms as *Volvox* and the group of the *Myxomycetes* have been continually referred to both kingdoms, and their true systematic position is still a subject of controversy. All physiology, consequently, must be based upon the identity of the protoplasm of all living beings.

This method of study has to a large extent modified our ideas of the relative importance of the parts of such an organism as a large tree. The interest with which we regard the latter no longer turns upon the details of the structure of its trunk, limbs and roots, to which the living substance of the more superficial parts was subordinated. Instead of regarding these as only ministering to the construction of the bulky portions, the living protoplasts take the first place as the essential portion of the tree, and all the other features are important mainly as ministering to their individual well-being and to their multiplication. The latter feature is the *growth* of the tree, the well-being of the protoplasts is its *life* and *health*. The interest passes from the bulky dense interior, with the elaborate features of its cell-walls, to the superficial parts, where its life is in evidence. We see herein the reason for the great subdivision of the body, with its

finely cut twigs and their ultimate expansions, the leaves, and we recognize that this subdivision is only an expression of the need to place the living substance in direct relationship with the environment. The formation and gradually increasing thickness of its bark are explained by the continually increasing need of adequate protection to the living cortex, under the strain of the increasing framework which the enormous multiplication of its living protoplasts demands, and the development of which leads to continual rupture of the exterior. The increasing development of the wood as the tree grows older is largely due to the demands for the conduction of water and mineral matters dissolved in it, which are made by the increased number of leaves which from year to year it bears, and which must each be put into communication with the central mass by the formation of new vascular bundles. Similar considerations apply to the peculiar features of the root-system. All these points of structure can only be correctly interpreted after a consideration of the needs of the individual protoplasts, and of the large colony of which they are members.

Gaseous Interchanges and their Mechanism.—Another feature of the construction of the plant has in recent years come into greater prominence than was formerly the case. The organism is largely dependent for its vital processes upon gaseous interchanges. It must receive a large constituent of what ultimately becomes its food from the air which surrounds it, and it must also take in from the same source the oxygen of its respiratory processes. On the other hand, the aerial environment presents considerable danger to the young and tender parts, where the protoplasts are most exposed to extremes of heat, cold, wet, &c. These must in some way be harmonized. No doubt the primary object of the cell-wall of even the humblest protoplast is protection, and this too is the meaning of the coarser tegumentary structures of a bulkier plant. These vary considerably in completeness with its age; in its younger parts the outer cells wall undergoes the change known as *cuticularization*, the material being changed both in chemical composition and in physical properties. The corky layers which take so prominent a share in the formation of the bark are similarly modified and subserv the same purpose. But these protective layers are in the main impermeable by gases and by either liquid or vapour, and prevent the access of either to the protoplasts which need them. Investigations carried out by Blackman, and by Brown and Escombe, have shown clearly that the view put forward by Boussingault, that such absorption of gases takes place through the cuticular covering of the younger parts of the plant, is erroneous and can no longer be supported. The difficulty is solved by the provision of a complete system of minute intercellular spaces which form a continuous series of delicate canals between the cells, extending throughout the whole substance of the plant. Every protoplast, except in the very young regions, has part of its surface abutting on these, so that its wall is accessible to the gases necessary for its vital processes. There is no need for cuticularization here, as the external dangerous influences do not reach the interior, and the processes of absorption which Boussingault attributed to the external cuticularized cells can take place freely through the delicate cell-walls of the interior, saturated as these are with water. This system of channels is in communication with the outer atmosphere through numerous small apertures, known as *stomata*, which are abundant upon the leaves and young twigs, and gaseous interchange between the plant and the air is by their assistance rendered constant and safe. This system of intercellular spaces, extending throughout the plant, constitutes a reservoir, charged with an atmosphere which differs somewhat in its composition from the external air, its gaseous constituents varying from time to time and from place to place, in consequence of the interchanges between itself and the protoplasts. It constitutes practically the exterior environment of the protoplasts, though it is ramifying through the interior of the plant.

The importance of this provision in the case of aquatic vascular plants of sturdy bulk is even greater than in that of terrestrial organisms, as their environment offers considerable obstacles

to the renewal of the air in their interior. They are without stomata on their submerged portions, and the entry of gas can only take place by diffusion from the water through their external cells, which are not cuticularized. Those which are only partially submerged bear stomata on their exposed portions, so that their environment approximates towards that of a terrestrial plant, but the communication even in their case is much less easy and complete, so that they need a much larger reservoir of air in their interior. This is secured by the development of much larger intercellular spaces, amounting to lacunae or passages of very considerable size, which are found ramifying in different ways in their interior.

Transpiration.—In the case of terrestrial plants, the continual renewal of the water contained in the vacuoles of the protoplasts demands a copious and continuous evaporation. This serves a double purpose, bringing up from the soil continually a supply of the soluble mineral matters necessary for their metabolic processes, which only enter the plant in solutions of extreme dilution, and at the same time keeping the plant cool by the process of evaporation. The latter function has been found to be of extreme importance in the case of plants exposed to the direct access of the sun's rays, the heat of which would rapidly cause the death of the protoplasts were it not employed in the evaporation of the water. Brown and Escombe have shown that the amount of solar energy taken up by a green leaf may often be fifty times as much as it can utilize in the constructive processes of which it is the seat. If the heat were allowed to accumulate in the leaf unchecked, they have computed that its temperature would rise during bright sunshine at the rate of more than 12° C. per minute, with of course very rapidly fatal results. What is not used in the constructive processes is employed in the evaporation of the water, the leaf being thus kept cool. Whether the leaf is brightly or only moderately illuminated, the same relative proportions of the total energy absorbed are devoted to the purposes of composition and construction respectively. This large evaporation, which constitutes the so-called *transpiration* of plants, takes place not into the external air but into this same intercellular space system, being possible only through the delicate cell-walls upon which it abuts, as the external coating, whether bark, cork or cuticle, is impermeable by watery vapour. The latter ultimately reaches the external air by diffusion through the stomata, whose dimensions vary in proportion as the amount of water in the epidermal cells becomes greater or less.

Mechanism and Function of Stomata.—It is not quite exact to speak of either the gaseous interchanges or the transpiration as taking place through the stomata. The entry of gases into, and exit from, the cells, as well as the actual exhalation of watery vapour from the latter, take place in the intercellular space system of which the stomata are the outlets. The opening and closing of the stomata is the result of variation in the turgidity of their guard cells, which is immediately affected by the condition of turgidity of the cells of the epidermis contiguous to them. The amount of watery vapour in the air passing through a stoma has no effect upon it, as the surfaces of the guard cells abutting on the air chamber are strongly cuticularized, and therefore impermeable. The only way in which their turgidity is modified is by the entry of water into them from the contiguous cells of the general epidermis and its subsequent withdrawal through the same channel. This opening and closing of the stomata must be looked upon as having a direct bearing only on the emission of watery vapour. There is a distinct advantage in the regulation of this escape, and the mechanism is directly connected with the greater or smaller quantity of water in the plant, and especially in its epidermal cells. This power of varying the area of the apertures by which gases enter the internal reservoirs is not advantageous to the gaseous interchanges—indeed it may be directly the reverse. It may lead to an incipient asphyxiation, as the supply of oxygen may be greatly interfered with and the escape of carbon dioxide may be almost stopped. It may at other times lead to great difficulties in the supply of the gaseous constituents which are used in the

manufacture of food. The importance of transpiration, is, however, so great, that these risks must be run.

The Ascent of Water in Trees.—The supply of water to the peripheral protoplasts of a tree is consequently of the first importance. The means by which such a supply is ensured are by no means clearly understood, but many agencies are probably at work. The natural source of the water is in all cases the soil, and few plants normally obtain any from elsewhere. The water of the soil, which in well-drained soil is met with in the form of delicate films surrounding the particles of solid matter, is absorbed into the plant by the delicate hairs borne by the young roots, the entry being effected by a process of modified osmosis. Multitudes of such hairs on the branches of the roots cause the entry of great quantities of water, which by a subsequent similar osmotic action accumulates in the cortex of the roots. The great turgidity which is thus caused exerts a considerable hydrostatic pressure on the stele of the root, the vessels of the wood of which are sometimes filled with water, but at other times contain air, and this often under a pressure less than the ordinary atmospheric pressure. This pressure of the turgid cortex on the central stele is known as *root pressure*, and is of very considerable amount. This pressure leads to the filling of the vessels of the wood of both root and stem in the early part of the year, before the leaves have expanded, and gives rise to the exudation of fluid known as *bleeding* when young stems are cut in early spring.

Root pressure is one of the forces co-operating in the forcing of the water upwards. The evaporation which is associated with transpiration is no doubt another, but by themselves they are insufficient to explain the process of lifting water to the tops of tall trees. There is at present also a want of agreement among botanists as to the path which the water takes in the structural elements of the tree, two views being held. The older is that the water travels in the woody cell-walls of the vascular bundles, mainly under the action of the forces of root pressure and transpiration, and that the cavities of the vessels contain only air. The other is that the vessels are not empty, but that the water travels in their cavities, which contain columns of water in the course of which are large bubbles of air. On this view the water flows upwards under the influence of variations of pressure and tension in the vessels. These forces however fail to furnish a complete explanation of the ascent of the current, and others have been thought to supplement them, which have more or less weight. Westermaier and Godlewski put forward the view that the living cells of the medullary rays of the wood, by a species of osmosis, act as a kind of pumping apparatus, by the aid of which the water is lifted to the top of the tree, a series of pumping-stations being formed. Though this at first met with some acceptance, Strasburger showed that the action goes on in great lengths of stem the cells of which have been killed by poison or by the action of heat. More recently, Dixon and Joly in Dublin and Askenasy in Germany have suggested the action of another force. They have shown that columns of water of very small diameter can so resist tensile strain that they can be lifted bodily instead of flowing along the channel. They suggest that the forces causing the movement are complex, and draw particular attention to the pull upwards in consequence of disturbances in the leaves. In these we have (1) the evaporation from the damp delicate cell-walls into the intercellular spaces; (2) the imbibition by the cell-wall of water from the vacuole; (3) osmotic action, consequent upon the subsequent increased concentration of the cell sap, drawing water from the wood cells or vessels which abut upon the leaf parenchyma. They do not, of course, deny the co-operation of the other forces which have been suggested, except so far as these are inconsistent with the motion of the water in the form of separate columns rather than a flowing stream. This view requires the existence of certain anatomical arrangements to secure the isolation of the separate columns, and cannot be said to be fully established.

Nature of the Food of Plants.—The recognition of the fundamental identity of the living substance in animals and plants has directed attention to the manner in which plants are nourished, and especially to the exact nature of their food. The idea was till recently generally accepted, that anything which plants absorbed from without, and

which went to build up their organic substance, or to supply them with energy, or to exert some beneficial influence upon their metabolism, constituted their food. Now, as the materials which plants absorb are carbon dioxide from the air, and various inorganic compounds from the soil, together with water, it is clear that if this view is correct, vegetable protoplasm must be fed in a very different way from animal, and on very different materials. A study of the whole vegetable kingdom, however, negatives the theory that the compounds absorbed are in the strict sense to be called food. Fungal and phanerogamic parasites can make no use of such substances as carbon dioxide, but draw elaborated products from the bodies of their hosts. These Fungi which are saprophytic can only live when supplied with organic compounds of some complexity, which they derive from decomposing animal or vegetable matter. Even in the higher flowering plants, in which the processes of the absorption of substances from the environment has been most fully studied, there is a stage in their life in which the nutritive processes approximate very closely to those of the group last mentioned. When the young sporophyte first begins its independent life—when, that is, it exists in the form of the embryo in the seed—its living substance has no power of utilizing the simple inorganic compounds spoken of. Its nutritive pabulum is supplied to it in the shape of certain complex organic substances which have been stored in some part or other of the seed, sometimes even in its own tissues, by the parent plant from which it springs. When the tuber of a potato begins to germinate the shoots which it puts out derive their food from the accumulated store of nutritive material which has been laid up in the cells of the tuber. If we examine the seat of active growth in a young root or twig, we find that the cells in which the organic substance, the protoplasm, of the plant is being formed and increased, are not supplied with carbon dioxide and mineral matter, but with such elaborated material as sugar and proteid substances, or others closely allied to them.

Identity of the Food of Animals and Plants.—It is evidently to the actual seats of consumption of food, and of consequent nutrition and increase of living substance, that we should turn when we wish to inquire what are the nutritive materials of plants. If we go back to the first instance cited, the embryo in the seed and its development during germination, we can ascertain what is necessary for its life by inquiring what are the materials which are deposited in the seed, and which become exhausted by consumption as growth and development proceed. We find them to consist of representatives of the great classes of foodstuffs on which animal protoplasm is nourished, and whose presence renders seeds such valuable material for animal consumption. They are mainly carbohydrates such as starch and sugar, proteids in the form of globulins or albumoses, and in many cases fats and oils, while certain other bodies of similar nutritive value are less widely distributed.

The differences between the nutritive processes of the animal and the plant are not therefore fundamental, as they were formerly held to be. The general vegetable protoplasm has not the capacity of being nourished by inorganic substances which are denied to the living substance of the animal world. Differences connected with the mode of supply of nutritive material do exist, but they are mainly correlated with the structure of the organisms, which makes the method of absorption different. The cell-walls of plants render the entry of solid material into the organism impossible. The food must enter in solution in order to pass the walls. Moreover, the stationary habit of plants, and the almost total absence of locomotion, makes it impossible for them to seek their food.

The Special Apparatus of Plants for Constructing Food.—The explanation of the apparent difference of food supply is very simple. Plants are furnished with a constructive mechanism by which they are enabled to fabricate the food on which they live from the inorganic, gaseous and liquid matters which they absorb. The fact of such absorption does not render these substances food; they are taken in not as food, but as raw materials to be subjected to the action of this constructive mechanism, and by it to be converted into substances that can nourish protoplasm, both vegetable and animal. It is sometimes forgotten, when discussing questions of animal nutrition, that all the food materials of all living organisms are prepared originally from inorganic substances in exactly the same way, in exactly the same place, and by the same machinery, which is the *chlorophyll apparatus* of the vegetable kingdom. A consideration of these facts emphasizes still more fully the view with which we set out, that all living substance is fundamentally the same, though differentiated both anatomically and physiologically in many directions and in different degrees. All is nourished alike on materials originally prepared by a mechanism attached to the higher vegetable organism, and capable of being dissociated, in theory at least, from its own special means of nutrition, if by the latter term we understand the appropriation by the protoplasm of the materials so constructed.

The chlorophyll apparatus of plants demands a certain description. It consists essentially of a number of minute corpuscles or plastids, the protoplasmic substance of which is impregnated with a green colouring matter. These bodies, known technically as *chloroplasts*, are found embedded in the protoplasm of the cells of the mesophyll of foliage leaves, of certain of the cells of some of the leaves of the flower, and of the cortex of the young twigs and petioles. Usually

they are absent from the cells of the epidermis, though in some of the lower plants they are met with there also. The plastids are not rigidly embedded in the cytoplasm, but are capable of a certain amount of movement therein. Each is a small protoplasmic body, in the meshes of whose substance the green colouring matter chlorophyll is contained in some form of solution. Various solvents, such as benzene, alcohol and chloroform, will dissolve out the pigment, leaving the plastid colourless. Chlorophyll is not soluble in water, nor in acids or alkalis without decomposition.

These plastids are especially charged with the duty of manufacturing carbohydrates from the carbon dioxide which the air contains, and which is absorbed from it after it has entered the intercellular passages and has so reached the cells containing the plastids. This action is found to take place only in the presence of light, preferably moderate sunlight. The reason for the distribution of the chloroplasts described above is consequently seen. The relation of the chlorophyll to light has been studied by many observers. If a solution of the pigment is placed in the path of a beam of light which is then allowed to fall on a prism, the resulting spectrum will be found to be modified. Instead of presenting the appearance of a continuous band in which all the colours are represented, it is interrupted by seven vertical dark spaces. The rays which in the absence of the solution of chlorophyll would have occupied those spaces have no power to pass through it, or in other words chlorophyll absorbs those particular rays of light which are missing.

The absorption of these rays implies that the pigment absorbs radiant energy from the sun, and gives us some explanation of its power of constructing the carbohydrates which has been mentioned as the special work of the apparatus. The working of it is not at all completely understood at present, nor can we say exactly what is the part played by the pigment and what is the rôle of the protoplasm of the plastid. It is not certain either whether the action of the chlorophyll apparatus is confined to the manufacture of carbohydrates or whether it is concerned, and if so how far, with the construction of protoids also.

As the action of the chlorophyll apparatus is directly dependent upon light, and the immediate result of its activity is the building up of complex compounds, it has become usual to speak of the processes it sets up under the name of *photosynthesis*.

Photosynthesis.—In the presence of light and when the plant is subjected to a suitable temperature, photosynthesis commences, provided that the plant has access to air containing its normal amount of carbon dioxide, about 3 parts, or rather less, in 10,000. The process involves the inter-action of water also, and this, as we have seen, is always present in the cell. In addition, certain inorganic salts, particularly certain compounds of potassium, are apparently necessary, but they seem to take no part in the chemical changes which take place. The original hypothesis of Baeyer suggested that the course of events is the following: the carbon dioxide is decomposed into carbon monoxide and oxygen; while water is simultaneously split up into hydrogen and oxygen; the hydrogen and the carbon monoxide unite to form formaldehyde and the oxygen is exhaled. This explanation is unsatisfactory from many points of view, but till quite recently no acceptable alternative has been advanced. There is no evidence that carbon monoxide is ever produced, indeed there are strong reasons for disbelieving in its occurrence. The formation of formaldehyde has till recently not been satisfactorily proved, though it has been obtained from certain leaves by distillation. Certain Algae have been found capable of forming nutritive carbohydrates in darkness, when supplied with a compound of this body with sodium-hydrogen-sulphite. But it is certain that it can only be present in a cell in very small amount at any moment, for an extremely dilute solution acts as a poison to protoplasm. If formed, as it probably is, it is immediately changed into some more complex combination, and so rendered incapable of exerting its poisonous action.

Baeyer's hypothesis was entertained by botanists partly because it explained the gaseous interchanges accompanying photosynthesis. These show that a definite intake of carbon dioxide is always accompanied by an exhalation of an equal volume of oxygen.

Recent investigations have confirmed Baeyer's view of the formation of formaldehyde, but a different explanation has been recently advanced. The first chemical change suggested is an interaction between carbon dioxide and water, under the influence of light acting through chlorophyll, which leads to the simultaneous formation of formaldehyde and hydrogen peroxide. The formaldehyde at once undergoes a process of condensation or polymerization by the protoplasm of the plastid, while the hydrogen peroxide is said to be decomposed into water and free oxygen by another agency in the cell, of the nature of one of the enzymes of which we shall speak later.

Polymerization of the aldehyde was also a feature of Baeyer's hypothesis, so that this view does not very materially differ from those he advanced. More emphasis is, however, now laid on the action of the plastid in polymerization, while the initial stages are still not definitely explained.

The steps which lead from the appearance of formaldehyde to that of the first well-defined carbohydrate are again matters of speculation. There are many possibilities, but no definite body of simpler composition than a sugar has so far been detected. Nor

is the nature of the first formed sugar certain; the general opinion has been that it is a simple hexose such as glucose or fructose, $C_6H_{12}O_6$. Brown and Morris in 1892 advanced strong reasons for thinking that cane-sugar, $C_{12}H_{22}O_{11}$, is the first carbohydrate synthesized, and that the hexoses found in the plant result from the decomposition of this. The whole story of the different sugars existing in the plant—their relations and their several functions—requires renewed investigation.

The first visible carbohydrate formed, one which appears so rapidly on the commencement of photosynthesis as to have been regarded as the first evidence of the setting up of the process, is starch. This is met with in the form of small granular specks in the substance of the chloroplast, specks which assume a blue colour when treated with a solution of iodine. Its very prompt appearance, as soon as the apparatus became active, led to the opinion formerly held, that the work of the latter was complete only when the starch was formed. We have seen that the starch is preceded by the formation of sugar, and its appearance is now interpreted as a sign of surplus manufacture. As much sugar as is produced in excess of the immediate requirements of the cell is converted into the insoluble form of starch by the plastids of the chlorophyll apparatus, and is so withdrawn from the sphere of action, thereby enabling the construction of further quantities of sugar to take place. The presence of too much sugar in solution in the sap of the cell inhibits the activity of the chloroplasts; hence the necessity for its removal. Starch, indeed, wherever it appears in the plant seems to be a reserve store of carbohydrate material, deposited where it is found for longer or shorter periods till it is needed for consumption. The readiness with which it is converted into sugar fits it especially to be a reserve or stored material.

Proteid Formation.—We have seen that it has been suggested that the chlorophyll apparatus may perhaps be concerned in the manufacture of proteids as well as of carbohydrates. If not, there must exist in the green plant, side by side with it, another mechanism which is concerned with the manufacture of the complex compounds in which nitrogen is present. The independence of the two is suggested by the fact that fungi can live, thrive and grow in nutritive media which contain carbohydrates together with certain salts of ammonia, but which are free from proteids. It is certain that their protoplasm cannot be nourished by inorganic compounds of nitrogen, any more than that of animals. We must therefore surmise their possession of a mechanism which can construct proteids, if supplied with these compounds of nitrogen together with sugar.

The probability is that this mechanism is to be found in green plants in the leaves—at any rate there is a certain body of evidence pointing in this direction. It may be, however, that there is no special mechanism, but that this power is a particular differentiation of a physiological kind, existing in all vegetable protoplasm, or in that of certain cells. The idea of an identity of protoplasm does not involve a denial of special powers developed in it in different situations, and the possession of such a power by the vegetable cell is not more striking than the location of the powers of co-ordination and thought in the protoplasm of cells of the human brain.

But if we accept either view we have still to examine the process of construction in detail, with a view to ascertaining the stages by which proteid is built up. Here unfortunately we find ourselves in the region of speculation and hypothesis rather than in that of fact. The nitrogen is absorbed by the plant in some form of combination from the soil. The green plant prefers as a rule nitrates of various metals, such as calcium, magnesium or potassium. The fungus seems to do better when supplied with compounds of ammonia. The nitrogen of the atmosphere is not called into requisition, except by a few plants and under special conditions, as will be explained later. The fate of these inorganic compounds has not been certainly traced, but they give rise later on to the presence in the plant of various amino acid amides, such as leucine, glycine, asparagine, &c. That these are stages on the way to proteids has been inferred from the fact that when proteids are split up by various means, and especially by the digestive secretions, these nitrogen-containing acids are among the products which result.

While we know little of the processes of proteid-construction, we are almost completely in the dark also as to what are the particular proteids which are first constructed.

Opinions are conflicting also as to the conditions under which proteids are formed. There is a certain amount of evidence that at any rate in some cases light is necessary, and that the violet rays of the spectrum are chiefly concerned. But the subject requires elucidation from both chemical and biological points of view.

The normal green plant is seen thus to be in possession of a complete machinery for the manufacture of its own food. The way in which such food when manufactured is incorporated into, and enabled to build up, the living substance is again hidden in obscurity. This is, however, also the case with the nutrition of animal protoplasm.

The building up and nutrition of the living substance by the foods manufactured or absorbed is properly spoken of as the assimilation of such food. Up to very recently the original absorption and subsequent treatment of the carbon dioxide and the compounds of nitrogen has been called by the same term. We frequently find the expression used, 'the assimilation' of carbon dioxide, or of

nitrogen." As this is not the incorporation of either into the living substance, but is only its manufacture into the complex substances which we find in the plant, it seems preferable to limit the term "assimilation" to the processes by which foods are actually taken into the protoplasm.

Symbiosis.—Though green plants thus possess a very complete mechanism for the manufacture of their different foodstuffs, it is not always exercised to the fullest extent. Many of them are known to supplement it, and some almost entirely to replace it, by absorbing the food they need in a fully prepared condition from their environment. It may be that they procure it from decomposing organic matter in the soil, or they may get it by absorption from other plants to which they attach themselves, or they may in rare cases obtain it by preying upon insect life. The power of green plants, not even specialized in any of these directions, to absorb certain carbohydrates, particularly sugars, from the soil was demonstrated by Acton in 1869. Similar observations have been made in the case of various compounds of nitrogen, though these have not been so complex as the proteins. It was formerly the custom to regard as parasites all those plants which inserted roots or root-like organs into the tissues of other plants and absorbed the contents of the latter. The most conspicuous case, perhaps, of all these is the mistletoe, which flourishes luxuriantly upon the apple, the poplar and other trees. Bonnier has drawn attention to the fact that the mistletoe in its turn, remaining green in the winter, contributes food material to its host when the latter has lost its leaves. The relationship thus existing he showed to be mutually beneficial, each at one time or another supplying the necessities of the other. Such a relationship is known as *symbiosis*, and the large majority of the cases of so-called parasitism among green plants can be referred to it. Bonnier showed that the same relationship could be proved in the case of such plants as the rattle (*Rhinanthus*), the eye-bright (*Epiphrasia*), and other members of the Natural Orders, Scrophulariaceae and Santalaceae, which effect a union between their roots and the roots of other plants growing near them. The union taking place underground, while the bulk of both partners in the symbiosis rises into the air, renders the association a little difficult to see, but there is no doubt that the plants in question do afford each other assistance, forming, as it were, a kind of partnership. The most pronounced case of parasitism, that of *Cuscuta*, the dodder, which infests particularly clover fields, appears to differ only in degree from those mentioned, for the plant, bare of leaves as it is, yet contains a little chlorophyll. The advantages it can offer to its host are, however, infinitesimal when compared with the injury it does it. Many other cases of symbiosis have been investigated with some completeness, especially those in which lower plants than the Phanerogams are concerned. The relations of the Alga and the Fungus, which have formed a close association in the structure known as the Lichen, were established many years ago. Since about 1880 our knowledge of the species which can enter into such relationships has been materially extended, and the fungal constituents of the Lichens are known to include Basidiomycetes as well as Ascomycetes.

Mycorrhizas.—The most interesting cases, however, in which Fungi form symbiotic relationships with green plants have been discovered in connexion with forest trees. The roots of many of the latter, while growing freely in the soil are found to be surrounded with a dense feltwork of fungal mycelium, which sometimes forms a mass of considerable size. The plants showing it are not all forest trees, but include also some Pteridophytes and some of the prothallia of the Ferns, Club-mosses, Liverworts and Horsetails. The true nature of the relationship was first recognized by Pfeffer in 1877, but few cases were known till recent years. Very complete examination, however, has now been made of many instances, and the name *mycorrhiza* has been given to the symbiotic union. Two classes are recognized. In the first, which are called *ectotropic*, the fungal filaments form a thick felt or sheath round the root, either completely enclosing it or leaving the apex free. They seldom penetrate the living cells, though they do so in a few cases. The root-hairs penetrate between masses of the hyphae of the Fungus. This type of mycorrhiza is found among the Poplars, Oaks and Fir trees. The other type is called *endotropic*. The fungal filaments either penetrate the epidermis of the root, or enter it from the stem and ramify in the interior. Some make their way through the cells of the outer part of the cortex towards the root-tip, and form a mycelium or feltwork of hyphae, which generally occupies two or three layers of cells. From this branches pass into the middle region of the cortex and ramify through the interior half of its cells. They often cause a considerable hypertrophy of the tissue. From the outer cortical mycelium, again, branches pass through the epidermis and grow out in the soil. In such cases the roots of the plants are usually found spreading in soils which contain a large amount of humus, or decaying vegetable matter. The organic compounds of the latter are absorbed by the protruding fungal filaments, which take the place of root-hairs, the tree ceasing to develop the latter. The food so absorbed passes to the outer cortical mycelium, and from this to the inner hyphae, which appear to be the organs of the interchange of substance, for they are attracted to the neighbourhood of the nuclei of the cells, which they enter, and in which they form agglomerations of interwoven filaments. The prothalli of the Pterido-

phytes, which form similar symbioses, show a somewhat different mode of arrangement, the Fungi occupying the external or the lower layers of the thalloid body.

The discovery of the widespread occurrence of this mycorrhizal symbiosis must be held to be one of the most important results of research upon the nutritive processes of plants during the closing decade of the 19th century. Among green plants the symbionts include Conifers, Orchids, Heath, Oaks, Poplars and Beeches, though all do not derive equal advantages from the association. *Mosses* afford an extreme case of it, having lost their chlorophyll almost entirely, and come to depend upon the Fungi for their nutriment. The fungal constituents vary considerably. Each species of green plant may form a mycorrhiza with two or three different Fungi, and a single species of Fungus may enter into symbiosis with several green plants. The Fungi that have been discovered taking part in the union include *Esarotium*, *Pythium*, *Boletus*, *Agaricus*, *Lactarius*, *Penicillium* and many others of less frequent occurrence. All the known species belong to the Oomycetes, the Pyrenomycetes, the Hymenomycetes or the Gasteromycetes. The habit of forming mycorrhizas is found more frequently in warm climates than cold; indeed, the percentage of the flora exhibiting this peculiarity seems to increase with a certain regularity from the Arctic Circle to the equator.

Fixation of Nitrogen.—Another, and perhaps an even more important, instance of symbiotic association has come to the front during the same period. It is an alliance between the plants of the Natural Order Leguminosae and certain bacterium-like forms which find a home within the tissues of their roots. The importance of the symbiosis can only be understood by considering the relationship in which plants stand with regard to the free nitrogen of the air. Long ago the view that this gas might be the source of the combined nitrogen found in different forms within the plant, was critically examined, particularly by Boussingault, and later by Lawes and Gilbert and by Pugh, and it was ascertained to be erroneous, the plants only taking nitrogen into their substance when it is presented to their roots in the form of nitrates of various metals, or compounds of ammonia. Many writers in recent years, among whom may be named especially Hellriegel and Willarth, Lawes and Gilbert, and Schlesing and Laurent, have shown that the Leguminosae as a group form conspicuous exceptions to this rule. While they are quite capable of taking up nitrates from the soil where and so long as these are present, they can grow and thrive in soil which contains no combined nitrogen at all, deriving their supplies of this element in these cases from the air. The phenomena have been the subject of very careful and critical examination for many years, and may be regarded as satisfactorily established. The power of fixing atmospheric nitrogen by the higher plants seems to be confined to this solitary group, though it has been stated by various observers with more or less emphasis that it is shared by others. Frank has claimed to have found oats, buckbeans, spurry, turnips, mustard, potatoes and Norway maples exercising it; Nobbe and others have imputed its possession to *Elaeagnus*. There is little direct evidence pointing to this extension of the power, and many experimenters directly contradict the statements of Frank.

The power exercised by the Leguminosae is associated with the presence of curious tubercular swellings upon their roots, which are developed at a very early age, as they are cultivated in ordinary soil. If experimental plants are grown in sterilized soil, these swellings do not appear, and the plant can then use no atmospheric nitrogen. The swellings have been found to be due to a curious hypertrophy of the tissue of the part, the cells being filled with an immense number of minute bacterium-like organisms of V or Y shape. The development of these structures has been studied by many observers, both in England and on the continent of Europe. They appear to be present in large numbers in the soil, and to infect the Leguminous plant by attacking its root-hairs. One of these hairs can be seen to be penetrated at a particular spot, and the entering body is then found to grow along the length of the hair till it reaches the cortex of the root. It has the appearance of a delicate tube which has granular contents, and is provided with an apex that appears to be open. The wall of the tube is very thin and delicate, and does not seem to be composed of cellulose or any modification of it. Careful staining shows that the granular substance of the interior really consists of a large number of delicate rod-like bodies. As the tube grows down the hair it maintains its own independence, and does not fuse with the contents of the root-hair, whose protoplasm remains quite distinct and separate. After making its way into the interior, the intruder sets up a considerable hyper trophy of the tissue, causing the formation of a tubercle, which soon shows a certain differentiation, branches of the vascular bundles of the root being supplied to it. The rod-like bodies from the interior of the tube, which has considerable resemblance to the zoogloea of many Bacteria, are liberated into the interior of the cells of the tubercle and fill it, increasing by a process of branching and fission. When this stage is reached the invading tubes and their ramifications frequently disappear, leaving the cells full of the bacterioids, as they have been called. When the root dies later such of these as remain are discharged into the soil, and are then ready to infect new plants. In some cases the zoogloea thread or tube has not been seen, the organism consisting entirely of the bacterioids.

This peculiar relationship suggests at once a symbiosis, the Fungus gaining its nutriment mainly or entirely from the green plant, while the latter in some way or other is able to utilize the free nitrogen of the air. The exact way in which the utilization or fixation of the nitrogen is effected remains undecided. Two views are still receiving certain support, though the second of them appears the more probable. These are: (1) That the green plant is so stimulated by the symbiotic association which leads to the hypertrophy, that it is able to fix the nitrogen or cause it to enter into combination. (2) That the fixation of the gas is carried out by the fungal organism either in the soil or in the plant, and the nitrogenous substance so produced is absorbed by the organism, which is in turn consumed by the green plant. Certain evidence which supports this view will be referred to later.

Whichever opinion is held on this point, there seems no room for doubt that the fixation of the nitrogen is concerned only with the root, and that the green leaves take no part in it. The nodules, in particular, appear to play the important part in the process. Marshall Ward has directed attention to several points of their structure which bear out this view. They are supplied with a regular system of conducting vascular bundles communicating with those of the roots. Their cells during the period of incubation of the symbiotic organism are abundantly supplied with starch. The cells in which the fungoid organism is vigorously flourishing are exceedingly active, showing large size, brilliant nuclei, protoplasm and vacuole, all of which give signs of intense metabolic activity. The sap in these active tissues is alkaline, which has been interpreted as being in accordance with Lew's suggestion that the living protoplasm in presence of an alkali and free nitrogen can build up ammonium nitrate, or some similar body. It is, however, at present entirely unknown what substances are formed at the expense of the atmospheric nitrogen.

The idea that the atmospheric nitrogen is gradually being made use of by plants, although it is clearly not easily or commonly utilized, has been growing steadily. Besides the phenomena of the symbiosis just discussed, certain experiments tend to show that we have a constant fixation of this gas in the soil by various Bacteria. Researches which have been carried out since 1885 by Berthelot, André, Laurent and Schloesing, and more recently by Kossowitsch, seem to establish the fact, though the details of the process remain undiscovered. Berthelot imputes it to the action of several species of soil Bacteria and Fungi, including the Bacterium of the Leguminosae, when the latter is cultivated free from its ordinary host. Laurent and Schloesing affirm that the free nitrogen of the air can be fixed by a number of humble green plants, principally lowly green Algae. They must be exposed freely to light and air during the process, or they fail to effect it. Frank has stated that *Penicillium cladosporioides* can flourish in a medium to which no nitrogen but that of the atmosphere has access. Kossowitsch claims to have proved that fixation of nitrogen takes place under the influence of a symbiosis of certain Algae and soil Bacteria, the process being much facilitated by the presence of sugar. The Algae include *Nostoc*, *Cystococcus*, *Cylindrospermum* and a few other forms. In the symbiosis the Algae are supplied with nitrogen by the bacteria, and in turn they construct carbohydrate material, part of which goes to the microbes. This is supported by the fact that if the mixed culture is placed in the light there is a greater fixation than when it is left in darkness. If there is a plentiful supply of carbon dioxide, more nitrogen is fixed.

Nitrification and Denitrification in the Soil.—Another aspect of the nitrogen question has been the subject of much investigation and controversy since 1877. The round of changes which nitrogenous organic matter undergoes in the soil, and how it is ultimately made use of again by plants, presents some curious features. We have seen that when nitrogenous matter is present in the condition of humus, some plants can absorb it by their roots or by the aid of mycorrhizas. But the changes in it in the usual course of nature are much more profound than these. It becomes in the soil the prey of various microbes. Ammonia appears immediately as a product of the disruption of the nitrogen-containing organic molecule. Later, oxidation processes take place, and the ammonia gives rise to nitrates, which are absorbed by plants. These two processes go on successively rather than simultaneously, so that it is only towards the end of the decomposition of the organic matter that nitrification of the ammonia which is formed is set up. In this process of nitrification we can distinguish two phases, first the formation of nitrites, and secondly their oxidation to nitrates. The researches of Warington in England and Winogradsky on the Continent have satisfactorily shown that two distinct organisms are concerned in it, and that probably more than one species of each exists. One of them comprising the genera *Nitrosomonas* and *Nitrosococcus*, has the power of oxidizing salts of ammonium to the condition of compounds of nitrous acid. When in a pure culture this stage has been reached no further oxidation takes place. The oxidation of the nitrites into nitrates is effected by another organism, much smaller than the first. The name *Nitrobacter* has been given to this genus, most of our knowledge of which is due to the researches of Winogradsky.

The two kinds of organism are usually both present in the same soil, those of the second type immediately oxidizing the nitrites which those of the first form from ammonium salts. The *Nitro-*

bacter forms not only cannot oxidize the latter bodies, but they are very injuriously affected by the presence of free ammonia. When cultivated upon a suitable nutritive material in the laboratory, the organism was killed by the presence of -0.15 % of this gas, and seriously inconvenienced by one-third as much. Except in this respect, however, the two classes show great similarity. A very interesting peculiarity attaching to them is their distaste for organic nutriment. They can be cultivated most readily on masses of gelatinous silt impregnated with the appropriate compounds of nitrogen and their growth takes place most copiously in the absence of light. They need a little carbonate in the nutrient material, and the source of the carbon which is found in the increased bulk of the plant is partly that and partly the carbon dioxide of the air.

We have in these plants a power which appears special to them, in the possession of some mechanism for the construction of organic substance which differs essentially from the chlorophyll apparatus of green plants, and yet brings about substantially similar results. The steps by which this carbon dioxide is built up into a compound capable of being assimilated by the protoplasm of the cells are not known. The energy for the purpose appears to be supplied by the oxidation of the molecules containing nitrogen, so that it is dependent upon such oxidation taking place. Winogradsky has investigated this point with great care, and he has come to the conclusion that about 35 milligrammes of nitrogen are oxidized for each milligramme of carbon absorbed and fixed.

Deposition and Digestion of Reserve Materials in Plants and Animals.—As we have seen, the tendency of recent research is to prove the identity of the mode of nutrition of vegetable and animal organisms. The material on which they feed is of the same description and its treatment in the body is precisely similar. In both groups we find the presence of nutritive material in two forms, one specially fitted for transport, the other for storage. We have seen that in the plant the processes of construction go on in the seats of manufacture faster than those of consumption. We have the surplus sugar, for instance, deposited as starch in the chloroplasts themselves. The manufacture goes on very actively so long as light shines upon the leaves, and we find towards night a very great surplus stored in the cells. This excess of manufacture is one of the features of plant life, and is exhibited, though in various degrees, by all green plants. The accumulated material is made to minister to the need of the plant in various ways; it may be by increasing the bulk of the plant, as by the formation of the wood of the trunk, branches and roots; or it may be by laying up a store of nutritive materials for purposes of propagation, as in tubers, corms, seeds, &c. In any case the surplus is continuously being removed from the seats of its construction and deposited for longer or shorter periods in other parts of the structure, usually near the regions at which its ultimate consumption will take place. We have the deposition of starch, aleurone grains, amorphous proteids, fats, &c., in the neighbourhood of growing points, cambium rings and phellogens; also the more prolonged storage in tubers, seeds and other reproductive bodies. Turning to the animal, we meet with similar provisions in the storage of glycogen in the liver and other parts, of fat in various internal regions, and so on. In both we find the reserve of food, so far as it is in excess of immediate need, existing in two conditions, the one suitable for transport, the other for storage, and we see continually the transformation of the one into the other. The formation of the storage form at the expense of the travelling stream is due to the activity of some protoplasmic structure—it may be a plastid or the general protoplasm of the cell—and is a process of secretion. The converse process is one of a true digestion, which deserves the name no less because it is intracellular. We find processes of digestion strictly comparable to those of the alimentary canal of an animal in the case of the insectivorous *Nepenthes*, *Drosera* and other similar plants, and in the saprophytic Fungi. Those which now concern us recall the utilization of the glycogen of the liver, the stored fats and proteids of other parts of the animal body being like them intracellular.

Enzymes.—The agents which effect the digestive changes in plants have been studied with much care. They have been found to be mainly enzymes, which are in many cases identical with those of animal origin. A vast number of them have been discovered and investigated, and the majority call for a brief notice. Their number, indeed, renders it necessary to classify them, and rather to look at groups of them than to examine them one by one. They are usually classified according to the materials on which they work, and we may here notice especially four principal groups, the members of which take part in the digestion of reserve materials as well as in the processes of external digestion. These decompose respectively carbohydrates, glucosides, proteids and fats or oils. The action of the enzyme in nearly every case is one of hydration, the body acted on being made to take up water and to undergo a subsequent decomposition.

Among those which act on carbohydrates the most important are: the two varieties of *diastase*, which convert starch into maltose or malt sugar; *inulase*, which forms fructose from inulin; *amylase*, which converts cane sugar into glucose (grape sugar) and fructose; *glucose* or *maltase*, which produces grape sugar from maltose; and *cellase*, which hydrolyses cellulose. Another enzyme which does

not appear to be concerned with digestion so directly as the others is *pectase*, which forms vegetable jelly from pectic substances occurring in the cell-wall.

The enzymes which act upon glucosides are many; the best known are *emulsin* and *myrosin*, which split up respectively *amygdalin*, the special glucoside of certain plants of the Rosaceae; and *sativin*, which has a wide distribution among those of the Cruciferae. Others of less frequent occurrence are *erythrozym*, *rhamnase* and *gaultherase*.

The proteolytic enzymes, or those which digest proteids, are usually divided into two groups, one which breaks down ordinary proteids into diffusible bodies, known as peptones, which are themselves proteid in character. Such an enzyme is the *pepsin* of the stomach of the higher animals. The other group attacks these peptones and breaks them down into the amino-acids of which we have spoken before. This group is represented by the *erepsin* of the pancreas and other organs. A third enzyme, the *trypsin* of the pancreas, possesses the power of both pepsin and erepsin. The relationships existing between these enzymes are still the subjects of experiment, and we cannot regard them as exhaustively examined. It is not quite certain whether a true pepsin exists in plants, but many trypsin have been discovered, and one form of erepsin, at least, is very widespread. Among the trypsin we have the *papain* of the Papaw fruit (*Carica Papaya*), the *brasin* of the Pine-apple, and the enzymes present in many germinating seeds, in the seedlings of several plants, and in other parts. Another enzyme, *rennet*, which in the animal body is proteolytic, is frequently met with in plants, but its function has not been ascertained.

The digestion of fat or oil has not been adequately investigated, but its decomposition in germinating seeds has been found to be due to an enzyme, which has been called *lipase*. It splits it into a fatty acid and glycerine, but seems to have no further action. The details of the further transformations have not yet been completely followed.

Oxidases.—Another class of enzymes has been discovered in both animals and plants, but they do not apparently take any part in digestion. They set up a process of oxidation in the substances which they attack, and have consequently been named *oxidases*. Very little is known about them.

In many cases the digestion of reserve food materials is effected by the direct action of the protoplasm, without the intervention of enzymes. This property of living substance can be proved in the case of the cells of the higher plants, but it is especially prominent in many of the more lowly organisms, such as the Bacteria. The processes of putrefaction may be alluded to as affording an instance of such a power in the vegetable organisms. At the same time it must be remembered that the secretion of enzymes by Bacteria is of widespread occurrence.

Supply and Distribution of Energy in Plants.—It is well known that one of the conditions of life is the maintenance of the process which is known as *respiration*. It is marked by the constant and continuous absorption of a certain quantity of oxygen and by the exhalation of a certain volume of carbon dioxide and water vapour. There is no direct connexion between the two, the oxygen is absorbed almost immediately by the protoplasm, and appears to enter into some kind of chemical union with it. The protoplasm is in a condition of instability and is continually breaking down to a certain extent, giving rise to various substances of different degrees of complexity, some of which are again built up by it into its own substances, and others, more simple in composition, are given off. Of these carbon dioxide and water are the most prominent. These respiratory processes are associated with the liberation of energy by the protoplasm, energy which it applies to various purposes. The assimilation of complex foods consequently may be regarded as supplying the protoplasm with a potential store of energy, as well as building up its substance. Whenever complex bodies are built up from simple ones we have an absorption of energy in some form and its conversion into potential energy; whenever decomposition of complex bodies into simpler ones takes place we have the liberation of some or all of the energy that was used in their construction.

Since about 1880 considerable attention has been directed to the question of the supply, distribution and expenditure of energy in the vegetable kingdom. This is an extremely important question, since the supply of energy to the animal world has been found to depend entirely upon the vegetable one. The supply of energy to the several protoplasts which make up the body of a plant is as necessary as is the transport to them of the food they need; indeed, the two things are inseparably connected. The source of energy which is the only one accessible to the ordinary plant as a whole is the radiant energy of the rays of the sun, and its absorption is mainly due to the properties of chlorophyll. This colouring matter, as shown by its absorption spectrum, picks out of the ordinary beam of light a large proportion of its red and blue rays, together with some of the green and yellow. This energy is obtained especially by the chloroplasts, and part of it is at once devoted to the construction of carbohydrate material, being thus turned from the kinetic to the potential condition. The other constructive processes, which are dependent partly upon the oxidation of the carbohydrates so formed, and therefore upon an expenditure of part of such energy, also mark the storage of energy in the potential form. Indeed, the construction of protoplasm itself indicates the same thing. Thus even in

these constructive processes there occurs a constant passage of energy backwards and forwards from the kinetic to the potential condition and vice versa. The outcome of the whole round of changes, however, is the fixation of a certain part of the radiant energy absorbed by the chlorophyll. The rays of the visible spectrum do not supply all the energy which the plant obtains. It has been suggested by several botanists, with considerable plausibility, that the ultra-violet or chemical rays can be absorbed and utilised by the protoplasm without the intervention of any pigment such as chlorophyll. There is some evidence pointing to the existence of this power in the cells of the higher plants. Again, we have evidence of the power of plants to avail themselves of the heat rays. There is, no doubt, a direct interchange of heat between the plant and the air, which in many cases results in a gain of heat by the plant. Indeed, the tendency to absorb heat in this way, either from the air or directly from the sunlight, has already been pointed out as a danger which needs to be averted by transpiration.

There is probably but little transformation of one form of kinetic energy into another in the plant. It has been suggested that the red pigment *Anthocyan*, which is found very commonly in young developing shoots, petioles and midribs, effects a conversion of light rays into heating ones, so facilitating the metabolic processes of the plant. This is, however, rather a matter of speculation. The various electrical phenomena of plants also are obscure.

Certain plants possess another source of energy which is common to them and the animal world. This is the absorption of elaborated compounds from their environment, by whose decomposition the potential energy expended in their construction can be liberated. Such a source is commonly met with among the Fungi, the insectivorous plants, and such of the higher plants as have a saprophytic habit. This source is not, however, anything new, for the elaborated compounds so absorbed have been primarily constructed by other plants through the mechanism which has just been described.

The question of the distribution of this stored energy to the separate protoplasts of the plant can be seen to be the same problem as the distribution of the food. The material and the energy go together, the decomposition of the one in the cell setting free the other, which is used at once in the vital processes of the cell, being in fact largely employed in constructing protoplasm or storing various products. The actual liberation in any cell is only very gradual, and generally takes the form of heat. The metabolic changes in the cells, however, concern other decompositions side by side with those which involve the building up of protoplasm from the products of which it feeds. So long as food is supplied the living substance is the seat of transformations which are continually proceeding, being partially decomposed and again constructed, the new food being incorporated into it. The changes involve a continual liberation of energy, which in most cases is caused by the respiration of the protoplasm and the oxidation of the substances it contains. The need of the protoplasm for oxygen has already been spoken of: in its absence death soon supervenes, respiration being stopped. Respiration, indeed, is the expression of the liberation of the potential energy of the protoplasm itself. It is not certain how far substances in the protoplasm are directly oxidized without entering into the composition of the living substance, though this appears to take place. Even their oxidation, however, is effected by the protoplasm acting as an oxygen carrier.

The supply of oxygen to a plant is thus seen to be as directly connected with the utilization of the energy of a cell as is that of food concerned in its nutrition. If the access of oxygen to a protoplast is interfered with its normal respiration soon ceases, but frequently other changes supervene. The partial asphyxiation or suffocation stimulates the protoplasm to set up a new and perhaps supplementary series of decompositions, which result in the liberation of energy just as do those of the respiratory process. One of the constant features of respiration—the exhalation of carbon dioxide—can still be observed. This comes in almost all such cases from the decomposition of sugar, which is split up by the protoplasm into alcohol and carbon dioxide. Such decompositions are now generally spoken of as *anaerobic* respiration. The decomposition of the complex molecule of the sugar liberates a certain amount of energy, as can be seen from the study of the fermentation set up by yeast, which is a process of this kind, in that it is intensified by the absence of oxygen. The liberated energy takes the form of heat, which raises the temperature of the fermenting wort. It has been ascertained that in many cases this decomposition is effected by the secretion of an enzyme, which has been termed *zymase*. This body has been prepared from active yeast, and from fruits and other parts which have been kept for some time in the absence of oxygen. The protoplasm appears to be able also to bring about the change without secreting any enzyme.

Expenditure of Energy by Plants.—The energy of the plant is, as we have seen, derived originally from the kinetic radiant energy of the sun. In such cells as are capable of absorbing it, by virtue of their chlorophyll apparatus, the greater part of it is converted into the potential form, and by the transport from cell to cell of the compounds constructed every part of the plant is put into possession of the energy it needs. The store of energy thus accumulated and distributed has to subservise various purposes in the economy of the plant. A certain part of it is devoted to the maintenance of

the framework of the fabric of the cell, and the construction of a continuously increasing skeleton; part is used in maintaining the normal temperature of the plant, part in constructing various substances which are met with in the interior, which serve various purposes in the working of the vital mechanism. A great part again is utilized in that increase of the body of the plant which we call growth.

Growth, as usually spoken of, includes two essentially different processes. The first of these, which may be regarded as growth proper, is the manufacture of additional quantities of living substance. The second, which is usually included in the term, is the increase of such accessories of living substance as are necessary for its well-being. These include cell walls and the various stored products found in growing cells. There is clearly a difference between these two categories. The formation of living substance is a process of building up from simple or relatively simple materials; the construction of its cellulose framework and supporting substance is done by the living substance after its own formation is completed, and is attended by a partial decomposition of such living substance.

Growth is always going on in plants while they are alive. Even the oldest trees put out continually new leaves and twigs. It does not, of course, follow that increase of bulk is always conspicuous; in such trees death is present side by side with life, and the one often counterbalances the other. As, however, we can easily see that the constructive processes are much greater than those which lead to the disappearance of material from the plant-body, there is generally to be seen a conspicuous increase in the substance of the plant. This is, in nearly all cases, attended by a permanent change in form. This is not perhaps so evident in the case of axial organs as it is in that of leaves and their modifications, but even in them it can be detected to a certain extent.

In the lowest plants growth may be co-extensive with the plant-body; in all plants of any considerable size, however, it is localized in particular regions, and in them it is associated with the formation of new protoplasts or cells. These regions have been called *growing points*. In such stems and roots as increase in thickness there are other growing regions, which consist of cylindrical sheaths known as *cambium layers* or *phellogen*s. By the multiplication of the protoplasts in these merismatic areas the substance of the plant is increased. In other words, as these growing regions consist of cells, the growth of the entire organ or plant will depend upon the behaviour of the cells or protoplasts of which the merismatic tissues are composed.

The growth of such a cell will be found to depend mainly upon five conditions: (1) There must be a supply of nutritive or plastic materials, at the expense of which the increase of its living substance can take place, and which supply the needed potential energy. (2) There must be a supply of water to such an extent as to set up a certain hydrostatic pressure in the cell, for only turgid cells can grow. (3) The supply of water must be associated with the formation of osmotic substances in the cell, or it cannot be made to enter it. (4) The cell must have a certain temperature, for the activity of a protoplast is only possible within certain limits, which differ in the case of different plants. (5) There must be a supply of oxygen to the growing cell, for the protoplast is dependent upon this gas for the performance of its vital functions, and particularly for the liberation of the energy which is demanded in the constructive processes. This is evident from the consideration that the growth of the cells is attended by the growth in surface of the cell wall, and as the latter is a secretion from the protoplasm, such a decomposition cannot readily take place unless oxygen is admitted to it.

When these conditions are present, the course of the growth of a cell appears to be the following: The young cell, immediately it is cut off from its fellow, absorbs water, in consequence of the presence in it of osmotically active substances. With the water it takes in the various nutritive substances which the former contains in solution. There is set up at once a certain hydrostatic pressure, due to the turgidity which ensues upon such absorption, and the extensible cell wall stretches, at first in all directions. The growth or increase of the protoplasm at the expense of the nutritive matter for a time keeps pace with the increased size of the cell, but by and by it becomes vacuolated as more and more water is attracted into the interior. Eventually the protoplasm usually forms only a lining to the cell wall, and a large vacuole filled with cell sap occupies the centre. The growth of the protoplasm, though considerable, is therefore not commensurate with the increase in the size of the cell. The stretching of the cell wall by the hydrostatic pressure is fixed by a secretion of new particles and their deposition upon the original wall, which as it becomes slightly thicker is capable of still greater extension, much in the same way as a thick band of india-rubber is capable of undergoing greater stretching than a thin one. The increase in surface of the cell wall is thus due—firstly to the stretching caused by turgidity, and secondly to the formation and deposition of new substance upon the old. When the limit of extensibility is reached the cell wall increases in thickness from the continuation of the latter of the two processes.

The rate of growth of a cell varies gradually throughout its course: it begins slowly, increases to a maximum, and then becomes slower till it stops. The time during which these regular changes in the rate can be observed is generally spoken of as the *grand period* of growth.

If we consider the behaviour of a growing organ such as a root, we find that, like a cell, it shows a grand period of growth. Just behind its apex the cells are found to be all in process of active division. Growth is small, and consists mainly in an increase of the quantity of protoplasm, for the cells divide again as soon as they have reached a certain size. As new cells are continually formed in the merismatic mass those which are farthest from the apex gradually cease to divide and a different process of growth takes place in them, which is associated more particularly with the formation of the vacuoles, consequent upon the establishment of considerable hydrostatic pressure in them, thus causing the bulk of the cells to be greatly enlarged. Here it is that the actual extension in length of the root takes place, and the cells reach the maximum point of the grand period. They then gradually lose the power of growth, the oldest ones or those farthest from the apex parting with it first, and they pass gradually over into the condition of the permanent tissues.

The same order of events may be ascertained to take place in the stem; but in this region it is complicated by the occurrence of nodes and internodes, growth in length being confined to the latter, many of which may be growing simultaneously. The region of growth in the stem is, as a rule, much longer than that of the root. The growth of the leaf is at first apical, but this is not very prolonged, and the subsequent enlargement is due to an intercalary growing region near the base.

The turgidity in the cells of a growing member is not uniform, but shows a fairly rhythmical variation in its different parts. If the member is one which shows a difference of structure on two sides, such as a leaf, the two sides frequently show a difference of degree of turgidity, and consequently of rate of growth. If we consider a leaf of the common fern we find that in its young condition it is closely rolled up, the upper or ventral surface being quite concealed. As it gets older it gradually unfolds and expands into the adult form. This is due to the fact that while young the turgidity and consequent growth are greater in the dorsal side of the leaf, so that it becomes rolled up. As it develops the maximum turgidity and growth change to its upper side, and so it becomes unfolded or expanded. These two conditions are generally described under the names of *hyponasty* and *epinasty* respectively.

Cylindrical organs may exhibit similar phenomena. One side of a stem may be more turgid than the opposite one, and the maximum turgidity, with its consequent growth, may alternate between two opposite sides. The growing apex of such a stem will alternately incline, first to one side and then to the other, exhibiting a kind of nodding movement in the two directions. More frequently the region of maximum turgidity passes gradually round the growing zone. The apex in this case will describe a circle, or rather a spiral, as it is elongating all the time, pointing to all points of the compass in succession. This continuous change of position has been called *circumnutation*, and is held to be universal in all growing cylindrical organs. The passage of the maximum turgidity round the stem may vary in rapidity in different places, causing the circle to be replaced by an ellipse. The bending to two sides alternately, described above, often called *simple nutation*, may be regarded as only an extreme instance of the latter.

Nervous System of Plants.—So far we have considered the plant almost exclusively as an individual organism, carrying out its own vital processes, and unaffected by its surroundings except in so far as these supply it with the materials for its well-being. When we consider, however, the great variability in those surroundings and the consequent changes a plant must encounter, it appears obvious that interaction and adjustment between the plant and its environment must be constant and well balanced. That such adjustment shall take place postulates on the part of the plant a kind of perception or appreciation of the changing conditions which affect it.

Careful examination soon shows an observer that such perceptions exist, and that they are followed by certain purposeful changes in the plant, sometimes mechanical, sometimes chemical, the object being evidently to secure some advantage for the plant, to ward off some danger, or to extricate it from some difficulty. We may speak, indeed, of the plant as possessed of a rudimentary nervous system, by the aid of which necessary adjustments are brought about. The most constantly occurring changes that beset a plant are connected with illumination, temperature, moisture, and contact with foreign bodies. Setting aside other susceptibilities, we have evidence that most plants are sensitive to all these.

If a growing stem receives stronger illumination on one side than another, its apex slowly turns from the vertical in the direction of the light source, continuing its change of position until it is in a direct line with the incident rays. If a root is similarly illuminated, a similar change of direction of growth follows, but

in this case the organ grows away from the light. These movements are spoken of as *heliotropic* and *apheliotropic* curvatures. The purpose of the movements bears out the contention that the plant is trying to adjust itself to its environment. The stem, by pointing directly to the light source, secures the best illumination possible for all of its leaves, the latter being distributed symmetrically around it. The root is made to press its way into the darker cracks and crannies of the soil, so bringing its root-hairs into better contact with the particles round which the hygroscopic water hangs. Leaves respond in another way to the same influence, placing themselves across the path of the beam of light.

Similar sensitiveness can be demonstrated in other cases. When a root comes in contact at its tip with some hard body, such as might impede its progress, a curvature of the growing part is set up, which takes the young tip away from the stone, or what-not, with which it is in contact. When a sensitive tendril comes into contact with a foreign body, its growth becomes so modified that it twines round it. Many instances might be given of appreciation of and response to other changes in the environment by the growing parts of plants; among them we may mention the opening and closing of flowers during the days of their expansion. One somewhat similar phenomenon, differing in a few respects, marks the relation of the plant to the attraction of gravity. Observation of germinating seedlings makes it clear that somehow they have a perception of direction. The young roots grow vertically downwards, the young stems vertically upwards. Any attempt to interfere with these directions, by placing the seedlings in abnormal positions, is frustrated by the seedlings themselves, which change their direction of growth by bringing about curvatures of the different parts of their axes, so that the root soon grows vertically downward again and the stem in the opposite direction. Other and older plants give evidence of the same perception, though they do not respond all in the same way. Speaking generally, stems grow upwards and roots downwards. But some stems grow parallel to the surface of the soil, while the branches both of stems and roots tend to grow at a definite angle to the main axis from which they come. These movements are spoken of as different kinds of *geotropic* curvatures. This power of perception and response is not by any means confined to the growing organs, though in these it is especially striking, and plays a very evident part in the disposition of the growing organs in advantageous positions. It can, however, be seen in adult organs, though instances are less numerous.

When the pinnate leaf of a *Mimosa pudica*, the so-called sensitive plant, is pinched or struck, the leaf droops rapidly and the leaflets become approximated together, so that their upper surfaces are in contact. The extent to which the disturbance spreads depends on the violence of the stimulation—it may be confined to a few leaflets or it may extend to all the leaves of the plant.

The leaves and leaflets of many plants, e.g. the telegraph plant, *Desmodium gyrans*, behave in a similar way under the stimulus of approaching darkness.

A peculiar sensitiveness is manifested by the leaves of the so-called insectivorous plants. In the case of *Dionaea muscipula* we find a two-lobed lamina, the two lobes being connected by a midrib, which can play the part of a kind of hinge. Six sensitive hairs spring from the upper surface of the lobes, three from each; when one of these is touched the two lobes rapidly close, bringing their upper surfaces into contact and imprisoning anything which for the moment is between them. The mechanism is applied to the capture of insects alighting on the leaf.

Drosera, another of this insectivorous group, has leaves which are furnished with long glandular tentacles. When these are excited by the settling of an insect on the leaf they slowly bend over and imprison the intruder, which is detained there, meanwhile by a sticky excretion poured out by the glands.

In both these cases the stimulation is followed, not only by movement, but by the secretion of an acid liquid containing a digestive juice, by virtue of which the insect is digested after being killed.

The purposeful character of all these movements or changes of position indicates that they are of nervous origin. We have in them evidence of two factors, a perception of some features of the environment and following this, after a longer or shorter interval, a response calculated to secure some advantage to the responding organ. We find on further investigation that these two conditions are traceable to different parts of the organs concerned. The perception of the changes, or, in other words, the reception of the stimulus, is associated for example, with the tips of roots and the apices of stems. The first recognition of a specially receptive part was made by Charles Darwin, who identified the perception of stimulation with the tip of the young growing root. Amputation of this part involved the cessation of the response, even when the conditions normally causing the stimulation were maintained. Francis Darwin later demonstrated that the tips of the plumules of grasses were sensitive parts. The responding part is situated some little distance farther back, being in fact the region where growth is active. This bending part has been proved to be insensitive to the stimuli. There is consequently a transmission of the stimulus from the sensitive organ to a kind of motor mechanism situated some little way off. We find thus three factors of a nervous mechanism present, a receptive, a conducting, and a responding part. The differentiation of the plant's substance so indicated is, however, physiological only; there is no histological difference between the cells of these regions that can be associated with the several properties they possess. Even the root tip, which shows a certain differentiation into root cap and root apex, cannot be said to be a definite sense organ in the same way as the sense organs of an animal. The root is continually growing and so the sensitive part is continually changing its composition, cells being formed, growing and becoming permanent tissue. The cells of the tip at any given moment may be sensitive, but in a few days the power of receiving the stimulus has passed to other and younger cells which then constitute the tip. The power of appreciating the environment is therefore to be associated with the protoplasm only at a particular stage of its development and is transitory in its character.

What the nature of the stimulation is we are not able to say. The protoplasm is sensitive to particular influences, perhaps of vibration, or of contact or of chemical action. We can imagine though perhaps only vaguely, the way in which light, temperature, moisture, contact, &c., can affect it. The perception of direction or the influence of gravity presents greater difficulty, as we have no clear idea of the form which the force of gravity takes. Recently some investigations by Haberlandt, Noll, Darwin and others have suggested an explanation which has much to recommend it. The sensitive cells must clearly be influenced in some way by weight—not the weight of external organs but of some weight within them. This may possibly be the cell sap in their interior, which must exercise a slightly different hydrostatic pressure on the basal and the lateral walls of the cells. Or more probably it may be the weight of definite particulate structures in their vacuoles. Many experiments point to certain small grains of starch which are capable of displacement as the position of the cell is altered. Such small granules have been observed in the sensitive cells, and there is an evident correlation between these and the power of receiving the geotropic stimulus. It has been shown that if the organ containing them is shaken for some time, so that the contact between them and the protoplasm of the cells is emphasized, the stimulus becomes more efficient in producing movement. This reduces the stimulus to one of contact, which is in harmony with the observations made upon roots similarly stimulated from the exterior. The stimulating particles, whether starch grains in all cases, or other particles as well, have been termed *statoliths*.

We have spoken of the absence of structural differentiation in the sense organs. There is a similar difficulty in tracing the paths by which the impulses are transmitted to the growing and curving regions. The conduction of such stimulation to parts removed some distance from the sense organ suggests paths of transmission comparable to those which transmit nervous

impulses in animals. Again, the degree of differentiation is very slight anatomically, but delicate protoplasmic threads have been shown to extend through all cell-walls, connecting together all the protoplasts of a plant. These may well serve as conductors of nervous impulses. The nervous mechanism thus formed is very rudimentary, but in an organism the conditions of whose life render locomotion impossible great elaboration would seem superfluous. There is, however, very great delicacy of perception or appreciation on the part of the sense organ, stimuli being responded to which are quite incapable of impressing themselves upon the most highly differentiated animal.

The power of response is seen most easily in the case of young growing organs, and the parts which show the motor mechanism are mainly the young growing cells. We do not find their behaviour like that of the motor mechanism of an animal. The active contraction of muscular tissue has no counterpart in the plant. The peculiarity of the protoplasm in almost every cell is that it is especially active in the regulation of its permeability by water. Under different conditions it can retain it more strongly or allow it to escape more freely. This regulation of turgor is as characteristic of vegetable protoplasm as contraction is of muscle. The response to the stimulus takes the form of increasing the permeability of particular cells of the growing structures, and so modifying the degree of the turgidity that is the precursor of growth in them. The extent of the area affected and of the variation in the turgor depends upon many circumstances, but we have no doubt that in the process of modifying its own permeability by some molecular change we have the counterpart of muscular contractibility.

The response made by the adult parts of plants, to which reference has been made, is brought about by a mechanism similar in nature though rather differently applied. If the leaf of *Mimosa* or *Desmodium* be examined, it will be seen that at the base of each leaflet and each leaf, just at the junction with the respective axes, is a swelling known as a *pulvinus*. This has a relatively large development of succulent parenchyma on its upper and lower sides. In the erect position of the leaf the lower side has its cells extremely turgid, and the pulvinus thus forms a cushion, holding up the petiole. On stimulation these cells part with their water, the lower side of the organ becomes flaccid and the weight of the leaf causes it to fall. The small pulvini of the leaflets, by similar changes of the distribution of turgidity, take up their respective positions after receiving the stimulus. In some cases the two sides of the pulvini vary their turgidity in turns; in others only the lower side becomes modified.

Similar turgescence changes, taking place with similar rapidity in the midrib of the leaf of *Dionaea*, explain the closing of the lobes upon their hinge. More slowly, but yet in the same way, we may note the change in turgidity of certain cells of the *Drosera* tentacles, as they close over the imprisoned insect.

Organic Rhythm.—It is a remarkable fact that during the process of growth we meet with rhythmic variation of such turgidity. The existence of rhythm of this kind has been observed and studied with some completeness. It is the immediate cause of the phenomena of circumnutation, each cell of the circumnating organ showing a rhythmic enlargement and decrease of its dimensions, due to the admission of more and less water into its interior. The restraint of the protoplasm changes gradually and rhythmically. The sequence of the phases of the rhythm of the various cells are co-ordinated to produce the movement. Nor is it only in growing organs that the rhythm can be observed, for many plants exhibit it during a much longer period than that of growth. It is easy to realize how such a rhythm can be modified by the reception of stimuli, and can consequently serve as the basis for the movement of the stimulated organ. This rhythmic affection of vegetable protoplasm can be observed in very many of its functions. What have been described as "periodicities," such as the daily variations of root-pressure, afford familiar instances of it. It reminds us of a similar property of animal protoplasm which finds its expression in the rhythmic beat of the heart and other phenomena.

AUTHORITIES.—Sachs, *Lectures on the Physiology of Plants*, translated by Marshall Ward; Vines, *Lectures on the Physiology of Plants*; Pfeffer, *The Physiology of Plants*, trans. by Ewart; Reynolds Green, *Introduction to Vegetable Physiology*; *The Soluble Ferments and Fermentation*; Detmer, *Practical Plant Physiology*, trans. by Moor; Darwin and Acton, *Practical Physiology of Plants*; Davenport, C.B., *Experimental Morphology*, vols. i. and ii.; Verworn, *General Physiology*, trans. by Lee; Bütschli, *Investigation on Microscopic Forms and on Protoplasm*, trans. by Minchin. (J. R. GL.)

PATHOLOGY OF PLANTS

"Phytopathology" or plant pathology (Gr. *φύτις*, plant), comprises our knowledge of the symptoms, course, causes and remedies of the maladies which threaten the life of plants, or which result in abnormalities of structure that are regarded, whether directly injurious or not to life, as unsightly or undesirable. In its systematized form, as a branch of botanical study, it is of recent date, and, as now understood, the subject first received special attention about 1850, when the nature of parasitism began to be intelligible; but many disjointed references to diseased conditions of plants had appeared long before this. The existence of blights and mildews of cereals had been observed and recorded in very ancient times, as witness the Bible, where half a dozen references to such scourges occur in the Old Testament alone. The epidemic nature of wheat-rust was known to Aristotle about 350 B.C., and the Greeks and Romans knew these epidemics well, their philosophers having shrewd speculations as to causes, while the people held characteristic superstitions regarding them, which found vent in the dedication of special festivals and delicias to the pests. Pliny knew that flies emerge from galls. The few records during the middle ages are borne out by what is known of famines and pestilence. Shakespeare's reference in *King Lear* (Act III, sc. iv.) may be quoted as evincing acquaintance with mildew in the 17th century, as also the interesting Rouen law of Loverdo (1660). Malpighi in 1679 gave excellent figures and accounts of leaf-rolling and gall insects, and Grew in 1682 equally good descriptions of a leaf-mining caterpillar. During the 18th century more academic treatment of the subject began to replace the scattered notes. Hales (1727-1733) discussed the rotting of wounds, cankers, &c., but much had to be done with the microscope before any real progress was possible, and it is easily intelligible that until the theory of nutrition of the higher plants had been founded by the work of Ingenhousz, Priestley and De Saussure, the way was not even prepared for accurate knowledge of cryptogamic parasites and the diseases they induce. It was not till De Bary (1866) made known the true nature of parasitic Fungi, based on his researches between 1853-1863, that the vast domain of epidemic diseases of plants was opened up to fruitful investigation, and such modern treatises as those of Frank (1880 and 1895), Sorauer (1886), Kirchner (1890), were gradually made possible.

Plant pathology embraces several branches of study, and may be conveniently divided as follows:—

1. The observation and accurate description of symptoms (*Diagnosis*).
2. The study of causes or agencies inducing disease (*Ätiology*).
3. The practise of preventive and remedial measures (*Therapeutics*).

In plants, however, the *symptoms of disease* are apt to exhibit themselves in a very general manner. Our perceptions differentiate but imperfectly symptoms which are due to very different causes and reactions, probably because the organization of the plant is so much less highly specialized than that of higher animals. The yellowing and subsequent casting of leaves, for instance, is a very general symptom of disease in plants, and may be induced by drought, extremes of temperature, insufficient or excessive illumination, excess of water at the roots, the action of parasitic Fungi, insects, worms, &c., or of poisonous gases, and so forth; and extreme caution is necessary in dealing with amateur descriptions of such symptoms, especially when the untrained eye has taken no cognisance of, or has only vaguely observed, the numerous collateral circumstances of the case.

The *causes of disease* may be provisionally classified somewhat as follows, but it may be remarked at the outset that no one of

these proximal causes, or agents, is ever solely responsible; and it is very easy to err in attributing a diseased condition to any of them, unless the relative importance of primary and subordinate agencies is discoverable. For instance, a Fungus epidemic is impossible unless the climatic conditions are such as to favour the dispersal and germination of the spores; and when plants are killed off owing to the supersaturation of the soil with water, it is by no means obvious whether the excess of water and dissolved materials, or the exclusion of oxygen from the root-hairs, or the lowering of the temperature, or the accumulation of foul products of decomposition should be put into the foreground. In every case there are chains of causation concerned, and the same factors will be differently grouped in different cases.

Bearing in mind these precautions, we may classify the proximal causal agents of disease as—

I.—External agencies.

A. Non-living.

a. Material.

1. Physical—
 - Water.
 - Atmosphere.
2. Chemical—
 - Soil.
 - Water.
 - Atmosphere.

b. Non-material.

1. Temperature.
2. Illumination.
3. Other agencies.

B. Living.

- a. Animals.
 1. Vertebrata.
 2. Invertebrata.
- b. Plants.
 1. Phanerogams.
 2. Cryptogams.

II.—Internal agencies.

While such a classification may serve its purpose as a sort of index, it must be confessed that the limits of its usefulness are soon reached. In the first place, the so-called "internal causes" of disease is probably a mere phrase covering our ignorance of the factors at work, and although a certain convenience attaches to the distinction between those cases where tender breeds of plants apparently exhibit internal predisposition to suffer more readily than others from parasites, low temperatures, excessive growth, &c.—as is the case with some grafted plants, cultivated hybrids, &c.—the mystery involved in the phrase "internal causes" only exists until we find what action of the living or non-living environment of the essential mechanism of the plant has upset its equilibrium.

I.—Passing to the recognized *external agencies*, the physical condition of the *soil* is a fruitful source of disease. If too closely packed, the soil particles present mechanical obstacles to growth; if too retentive of moisture, the root-hairs suffer, as already hinted; if too open or over-drained, the plant succumbs to drought. All those properties of soil known as texture, porosity, depth, inclination to the horizon, &c., are concerned here. Many maladies of plants are traceable to the chemical composition of soils—e.g. deficiency of nutritive salts, especially nitrates and phosphates; the presence of poisonous salts of iron, copper, &c., or (in the soil about the roots of trees in towns) of coal-gas and so forth. But it is worthy of special attention that the mere chemical composition of agricultural and garden soils is, as a rule, the least important feature about them, popular opinion to the contrary notwithstanding. Ordinary soils will almost always provide the necessary chemical ingredients if of proper physical texture, depth, &c. (see FUNGI and BACTERIOLOGY).

As regards *water*, its deficiency or excess is a relative matter, and although many of the minor maladies of pot-plants in windows and greenhouses controlled by amateurs depend on its misuse, water alone is probably never a primary cause of disease. Its over-supply is, however, a frequent cause of predisposition to the attacks of parasitic Fungi—e.g. the damping off of seedlings—and in saturated soils not only are the roots and root-hairs killed by asphyxiation, but the whole course of soil fermentation is altered, and it takes time to "sweeten" such by draining, because not only must the noxious bodies be gradually washed out and the lost salts restored, but the balance of suitable bacterial and fungal life must be restored.

The *atmosphere* is a cause of disease in the neighbourhood of chemical works, large towns, volcanoes, &c., in so far as it carries acid gases and poisons to the leaves and roots; but it is usual to associate with it the action of excessive humidity which brings about those tender watery and more or less etiolated conditions which favour parasitic Fungi, and diminish transpiration and therefore nutrition. It is customary to speak of the disastrous effects of cold winds, snow, hail and frost, lightning, &c., under the heading of atmospheric influences, which only shows once more how impossible it is to separate causes individually.

Turning to the *non-material external agents*, probably no factors are more responsible for ill-health in plants than *temperature* and

light. Every plant is constrained to carry out its functions of germination, growth, nutrition, reproduction, &c., between certain limits of temperature, and somewhere between the extremes of these limits each function finds an optimum temperature at which the working of the living machinery is at its best, and, other things being equal, any great departure from this may induce pathological conditions; and many disasters are due to the failure to provide such suitable temperatures—e.g. in greenhouses where plants requiring very different optimum temperatures and illumination are kept together. Equally disastrous are those climatic or seasonal changes which involve temperatures in themselves not excessive but in wrong sequence; how many more useful plants could be grown in the open in the United Kingdom if the deceptively mild springs were not so often followed by frosts in May and June! The indirect effects of temperature are also important. Trees, of which the young buds are "nipped" by frost, would frequently not suffer material injury; were it not that the small frost-cracks serve as points of entry for Fungi; and numerous cases are known where even high temperatures can be endured on rich, deep, retentive soils by plants which at once succumb to drought on shallow or non-retentive soils.

All chlorophyll plants require *light*, but in very different degrees, as exemplified even in the United Kingdom by the shade-bearing beech and yew contrasted with the light-demanding larch and birch; and as with temperature so with light, every plant and even every organ has its optimum of illumination. The "drawn" or etiolated condition of over-shaded plants is a case in point, though here again the soft, watery plant often really succumbs to other disease agents—e.g. parasitic Fungi—supervening on its non-resistant condition.

Animals and plants as agents of disease or injury form part of the larger subject of the struggle for existence between living organisms, as is recognized even by those who do not so readily apprehend that diseased conditions in general are always signs of defeat in the struggle for existence between the suffering organism and its environment, living and non-living.

The Vertebrata come within the scope of our subject, chiefly as destructive agents which cause wounds or devour young shoots and foliage, &c. Rabbits and other burrowing animals injure roots, squirrels and birds nip off buds, horned cattle strip off bark, and so forth. It is among the Invertebrata that epidemics of destruction are referred to, though we should bear in mind that it is only the difference in numerical proportion that prevents our speaking of an epidemic of elephants or of rabbits, though we use the term when speaking of blight insects; there is little consistency in the matter, as it is usual to speak of an invasion or scourge of locusts, caterpillars, &c. Insect injuries are very varied in degree and in kind. Locusts devour all before them; caterpillars defoliate the plant, and necessitate the premature utilization of its reserves; other insects (e.g. *Grapholita*) eat the buds or the roots (e.g. wire-worms), and so main the plant that its foliage suffers from want of water and assimilation is diminished, or actual withering follows. Many aphides, &c., puncture the leaves, suck out the sap, and induce various local deformations, arrest of growth, pustular swellings, &c., and if numerous all the evils of defoliation may follow. Others (e.g. miners) tunnel into the leaf parenchyma, and so put the assimilating areas out of action in another way.

It should be remembered that a single complete defoliation of a herbaceous annual may so incapacitate the assimilation that no stores are available for seeds, tubers, &c., for another year, or at most so little that feeble plants only come up. In the case of a tree matters run somewhat differently; most large trees in full foliage have far more assimilatory surface than is immediately necessary, and if the injury is confined to a single year it may be a small event in the life of the tree, but if repeated the cambium, bud-stores and fruiting may all suffer. Many larvae of beetles, moths, &c., bore into bark, and injure the cambium, or even the wood and pith; in addition to direct injury, the interference with the transpiration current and the access of other parasites through the wounds are also to be feared in proportion to the numbers of insects at work. Various local hypertrophies, including galls, result from the increased growth of young tissues irritated by the punctures of insects, or by the presence of eggs or larvae left behind. They may occur on all parts, buds, leaves, stems or roots, as shown by the numerous species of *Cynips* on oak, *Phylloxera* on vines, &c. The local damage is small, but the general injury to assimilation, absorption and other functions, may be important if the numbers increase. In addition to insects, various kinds of worms, molluscs, &c., are sometimes of importance as pests. The so-called eel-worms (*Nematodes*) may do immense damage on roots and in the grains of cereals, and every one knows how predatory slugs and snails are. (See ECONOMIC ENTOMOLOGY.)

Plants as agents of damage and disease may be divided into those larger forms which as weeds, epiphytes and so forth, do injury by dominating and shading more delicate species, or by gradually exhausting the soil, &c., and true parasites which actually live on and in the tissues of the plants. It must be remembered that phanerogams also include parasitic species—e.g. *Cuscuta*, *Loranthus*, *Viscum*, *Thesium*, *Rhinanthus*, &c.—with various capacities for injury. These enemies are as a rule so conspicuous that

we do not look on their depredations as diseases, though the gradual deterioration of hay under the exhausting effects of root-parasites like *Rhizanihus*, and the onslaught of *Cuscuta* when unduly abundant, should teach us how unimportant to the definition the question of size may be.

It is, however, among the Fungi that we find the most disastrous and elusive agents of disease. *Parasitic Fungi* may be, as regards their direct action, purely local—e.g. *Schisnia*, which forms gall-like swellings on the roots of rushes; *Gymnosporangium*, causing excrescences on juniper stems; numerous leaf fungi such as *Puccinia*, *Aecidium*, *Septoria*, &c., causing yellow, brown or black spots on leaves; or *Ustilago* in the anthers of certain flowers. In such cases the immediate damage done may be slight; but the effects of prolonged action and the summation of numerous attacks at numerous points are often enormous, certain of these leaf-diseases costing millions sterling annually to some planting and agricultural communities. In other cases the Fungus is virulent and rampant, and, instead of a local effect, exerts a general destructive action throughout the plant—e.g. *Phyium*, which causes the "damping off" of seedlings, reducing them to a putrid mass in a few hours, and *Phytophthora*, the agent of the potato disease. Many Fungi, in themselves not very aggressive, slowly bring about important and far-reaching secondary effects. Thus, many Hymenomyces (Agaricia, Polyporei, &c.) live on the wood of trees. This wood is in great part already dead substance, but the mycelium gradually invades the vessels occupied with the transmission of water up the trunk, cuts off the current, and so kills the tree; in other cases such Fungi attack the roots, and so induce rot and starvation of oxygen, resulting in "fouling." Numerous Fungi, though conspicuous as parasites, cannot be said to do much individual injury to the host. The extraordinary malformations known as "Witches' Brooms," caused by the repeated branching and tufting of twigs in which the mycelium of *Exoascus* (on birch) or *Aecidium* (on silver fir) are living, may be borne in considerable numbers for years without any very extensive apparent injury to the tree. Again, the curious distortions on the stems of nettles attacked by the *Aecidium* form of the heteroecious *Puccinia Caricis* (see FUNGI, for Heteroecism), or on maize stems and leaves attacked by *Ustilago Maydis*; or on the inflorescence of crucifers infested with *Cystopus*, &c., are not individually very destructive; it is the cumulative effects of numerous attacks or of extensive epidemics which eventually tell. Some very curious details are observable in these cases of malformation. For instance, the *Aecidium alatinum* first referred to causes the new shoots to differ in direction, duration and arrangement, and even shape of foliage leaves from the normal; and the shoots of *Euphorbia* infested with the acedia of *Uromyces Pisi* depart so much from the normal in appearance that the attacked plants have been taken for a different species. Similarly with *Anemone* infested with *Puccinia* and *Vaccinium* with *Calyptospora*, and many other cases of deformations due to hypertrophy or atrophy. Instances of what we may term tolerated parasitism, where the host plant seems to accommodate itself very well to the presence of the Fungus, paying the tax it extorts and nevertheless not succumbing but managing to provide itself with sufficient material to go on with, are not rare; and these seem to lead to those cases where the mutual accommodation between host and guest has been carried so far that each derives some benefit from the association—symbiosis (see FUNGI).

II. The *kinas of disease* due to these various agencies are very different. A plant may be diseased as a whole, because nearly all its tissues are in a morbid or pathological condition, owing to some Fungus pervading the whole—e.g. *Phyium* in seedlings—or to a poison diffusing from cell to cell; in the case of unicellular plants—e.g. an alga infested with a *Cyrtidium*—indeed, matters can hardly be otherwise. But the case is obviously different where a plant dies because some essential organ or tissue tract has been destroyed, and other parts have suffered because supplies are cut off—e.g. when the upper parts of a tree die off owing to destruction of the roots, or to the ringing of the stem lower down, and consequent interference with the transpiration current. In a large number of cases, however, the disease is purely local, and does not itself extend far into the organ or tissue affected.

If a mass of living plant-tissue is cut, the first change observed is one of colour: the white "flesh" of a potato or an apple turns brown as the air enters, and closer examination shows that cell walls and contents are alike affected. The cut cells die, and oxidized products are concerned in the change of colour, the brown juices exuding and soaking into the cell-walls. The next change observable after some hours is that the untouched cells below the cut grow larger, push up the dead surface, and divide by walls tangential to it, with the formation of tabloid cork-cells. The layer of cork thus formed cuts out the dead debris and serves to protect the uninjured cells below. Such healing by cork formation is accompanied by a rise of temperature: the active growth of the dividing cells is accompanied by vigorous metabolism and respiration, and a state of "wound fever" supervenes until the healing is completed. The phenomena described occur in all cases of cicatrization of wounds in nature—e.g. leaf-tissue, young stems, roots, &c., when cut or pierced by insects, thorns and so forth. They are concerned in the occlusion of broken twigs and of falling leaves, and

it is from the actively growing "callus" developed at the surface of the wounded tissues of cuttings, buddings, prunings, &c., that the healing and renewal of tissues occur of which advantage is taken in the practice of what might well be termed plant surgery. A third phenomenon observable in such healing tissues is the increased flow and accumulation of plastic materials at the seat of injury. The enhanced metabolism creates a current of draught on the supplies of available food-stuffs around. The phenomenon of irritability here concerned is well shown in certain cases where a parasitic organism gains access to a cell—e.g. *Plectoachetes* causes the invaded *Pisobolus* to swell up, and changes the whole course of its cell metabolism, and similarly with *Plasmiodiophora* in the roots of turnips, and many other cases.

Irritation and hypertrophy of cells are common signs of the presence of parasites, as evinced by the numerous malformations, galls, witches'-brooms, &c., on diseased plants. The now well-known fact that small doses of poisonous substances may act as stimuli to living protoplasm, and that respiratory activity and growth may be accelerated by chloroform, ether and even powerful mineral poisons, such as mercuric chloride, in minimal doses, offers some explanation of these phenomena of hypertrophy, "wound fever," and other responses to the presence of irritating agents. Still further insight is afforded by our increasing knowledge of the enzymes, and it is to be remarked that both poisons and enzymes are very common in just such parasitic Fungi as induce discolorations, hypertrophies and the death of cells—e.g. *Botrytis*, *Ergot*, &c. Now it is clear that if an organism gains access to all parts of a plant, and stimulates all or most of its cells to hypertrophy, we may have the latter behaving abnormally—i.e. it may be diseased throughout; and such actually occurs in the case of *Euphorbia* pervaded with *Uromyces Pisi*, the presence of which alters the whole aspect of the host-plant. If such a general parasite carries its activities farther, every cell may be killed and the plant forthwith destroyed—e.g. *Phytophthora* in potatoes. If, on the other hand, the irritating agent is local in its action, causing only a few cells to react, we have the various pimples, excrescences, outgrowths, &c., exhibited in such cases as *Ustilago Maydis* of the maize, various galls, witches'-brooms, &c.

It must not be overlooked that the living cells of the plant react upon the parasite as well as to all external agencies, and the nature of disease becomes intelligible only if we bear in mind that it consists in such altered metabolism—deflected physiology—as is here implied. The reaction of the cells may be in two directions, moreover. For instance, suppose the effect of a falling temperature is to so modify the metabolism of the cells that they fill up more and more with watery sap; as the freezing-point is reached this may result in destructive changes, and death from cold may result. If, on the contrary, the gradual cooling is met by a corresponding depletion of the cells of water, even intense cold may be sustained without injury.

Or, take another case. If the attack of a parasite is met by the formation of some substance in the protoplasm which is chemotactically repulsive to the invader, it may be totally incapable of penetrating the cell, even though equipped with a whole armoury of cytaes, diastatic and other enzymes, and poisons which would easily overcome the more passive resistances offered by most cell-walls and cell-contents of other plants, the protoplasm of which forms bodies chemotactically attractive to the Fungus.

The various degrees of parasitism are to a certain extent explained by the foregoing. In order that a Fungus may enter a plant, it must be able to overcome not merely the resistance of cell-walls, but that of the living protoplasm; if it cannot do this, it must remain outside as a mere epiphyte, e.g. *Fumago Heterosporia*, &c., or, at most, vegetate in the intercellular spaces and anchor itself to the cell-walls, e.g. *Trichosphaeria*. The inability to enter the cells may be due to the lack of chemotactic bodies, to incapacity to form cellulose-dissolving enzymes, to the existence in the host-cells of antagonistic bodies which neutralize or destroy the acids, enzymes or poisons formed by the hyphae, or even to the formation and excretion of bodies which poison the Fungus. But even when inside it does not follow that the Fungus can kill the cell, and many cases are known where the Fungus can break through the cell's first lines of defence (cell-wall and protoplasmic lining); but the struggle goes on at close quarters, and various degrees of hypertrophy, accumulation of plastic bodies or secretions, discolorations, &c., indicate the suffering of the still living cell. Finally, cases occur where the invaded cell so adapts itself to the presence of the intruder that life in common—symbiosis—results.

The dissemination of plant parasites is favoured by many circumstances not always obvious, whence an air of mystery regarding epidemics was easily created in earlier times. The spores of Rusts, Erysipheae and other Fungi may be conveyed from plant to plant by snails; those of tree-killing polypores, &c., by mice, rabbits, rats, &c., which rub their fur against the hymenophores. Bees carry the spores of *Sclerotinia* as they do the pollen of the bilberries, and flies convey the conidia of ergot from grain to grain. Insects, indeed, are largely concerned in disseminating Fungi, either on their bodies or via the alimentary canal. Worms bring spores to the surface of soil, ducks and other birds convey them on their muddy feet, and, as is well-known, wind and other physical

agencies are very efficient in dissemination. The part played by man also counts for much. Gardeners and farm labourers convey spores from one bed or field to another; carted soil, manure, &c., may abound in spores of *Smuts*, *Fusarium*, *Polyporei* and in sclerotia; and articles through the post and so forth often carry infective spores. Every time a carpenter saws fresh timber with a saw recently put through wood attacked with dry-rot, he risks infecting it with the Fungus; and similarly in pruning, in propagating by cuttings, &c.

The annual losses due to epidemic plant diseases attain proportions not easily estimated. As regards money value alone the following figures may serve in illustration. In 1882 the United States was calculated to have lost £40,000,000 to £60,000,000 from insect and other pests. The wheat-rust costs Australia £2,000,000 to £3,000,000 annually, and in 1891 alone the loss which Prussia suffered from grain-rusts was estimated at £20,000,000 sterling.

The terrible losses sustained by whole communities of farmers, planters, forsters, &c., from plant diseases have naturally stimulated the search for remedies, but even now the search is too often conducted in the spirit of the believer in quack medicines, although the agricultural world is awakening to the fact that before any measures likely to be successful can be attempted, the whole chain of causation of the disease must be investigated. Experience with epidemics, dearly bought in the past, has shown that one fruitful cause is the laying open to the inroads of some Fungus or insect, hitherto leading a quiet endemic life in the fields and forests, large tracts of its special food, along which it may range rampant without check to its dispersal, nutrition and reproduction. Numerous wild hypotheses as to changes in the constitution of the host-plant, leading to supposed vulnerability previously non-existent, would probably never have seen the light had the full significance of the truth been grasped that an epidemic results when the external factors favour a parasite somewhat more than they do the host. It may be that in particular cases particular modes of cultivation disfavour the host; or that the soil, climate or seasons do so; but overwhelming evidence exists to show that the principal causes of epidemics reside in circumstances which favour the spread, nutrition and reproduction of the pest, and the lesson to be learnt is that precautions against the establishment of such favouring conditions must be sought. Nevertheless, epidemics occur, and practical measures are devised to meet the various cases and to check the ravages already begun. The procedure consists in most cases in spraying the affected plants with poisonous solutions or emulsions, or in dusting them with fungicidal or insecticidal powders, or applying the fumes of lethal gases. For the composition of the numerous liquids and powders special works must be consulted, but the following principles apply generally. The poison must not be strong enough to injure the roots, leaves, &c., of the host-plant, or allowed to act long enough to bring about such injury. Care and intelligence are especially needful with certain insecticides such as poisonous gases, or the operators may suffer. It is worse than useless to apply drastic remedies if the main facts of the life-history of the pest are not known; e.g. the application of ordinary antiseptic powders to leaves inside which a Fungus, such as a *Uredia* or *Ustilago*, is growing can only result in failure, and similarly if tobacco dusts or sprays are applied when the insects concerned are hibernating in the ground beneath. Such applications at the moment when spores are germinating on the leaves, e.g. *Peronospora*, or to the young mycelia of epiphytic parasites, e.g. *Erysiphe*, or the steeping in hot water of thoroughly ripe hard grains to which spores are attached, e.g. *Ustilago*, and filling a greenhouse with hydrocyanic acid gas when young insects are commencing their ravages, e.g. Red-spider—all these and similar procedures timed to catch the pest at a vulnerable stage are intelligent and profitable prophylactic measures, as has been repeatedly shown. Numerous special methods of preventing the spread of Fungi, or the migrations of insects, or of trapping various animals; of leaving infested ground fallow, or of growing another crop useless to the pest, &c., are also to be found in the practical treatises. More indirect methods, such as the grafting of less resistant scions on more vigorous stocks, of raising special late or early varieties by crossing or selection, and so on, have also met with success; but it must be understood that "resistant" in such cases usually means that some peculiarity of quick growth, early ripening or other life-feature in the plant is for the time being taken advantage of. Among the most interesting modern means of waging war against epidemic pests is that of introducing other epidemics among the pests themselves—e.g. the infection of rats and mice with disease bacilli, or of locusts with insect-killing Fungi, and signs of the successful carrying out of such measures are not wanting. That the encouragement of insectivorous birds has been profitable is well-established, and it is equally well-known that their destruction may lead to disastrous insect plagues.

Diseases and Symptoms.—The symptoms of plant diseases are, as already said, apt to be very general in their nature, and are sometimes so vaguely defined that little can be learned from them as to the causes at work. We may often distinguish between primary symptoms and secondary or subordinate

symptoms, but for the purposes of classification in an article of this scope we shall only attempt to group the various cases under the more obvious signs of disease exhibited.

1. **Discolorations** are among the commonest of all signs that a plant is "sickly" or diseased. The principal symptom may show itself in general pallor, including all cases where the normal healthy green hue is replaced by a sickly yellowish hue indicating that the chlorophyll apparatus is deficient. It may be due to insufficient illumination (*Etiolation*), as seen in geraniums kept in too shaded a situation, and is then accompanied by soft tissues, elongation of internodes, leaves usually reduced in size, &c. The laying of wheat is a particular case. False etiolation may occur from too low a temperature, often seen in young wheat in cold springs. Cases of pallor due to too intense illumination and destruction of chlorophyll must also be distinguished. *Chlorosis* is a form of pallor where the chlorophyll remains in abeyance owing to a want of iron, and can be cured by adding ferrous salts. Lack of other ingredients may also induce chlorotic conditions. Yellowing is a common sign of water-logged roots, and if accompanied by wilting may be due to drought. Over-transpiration in bright wintry weather, when the roots are not absorbing, often results in yellowing. In other cases the presence of insects, Fungi or poisons at the roots may be looked for. *Albinism*, with which variegated foliage may be considered, concerns a different set of causes, still obscure, and usually regarded as internal, though experiments go to show that some variegations are infectious.

2. **Spotted Leaves, &c.**—Discoloured spots or patches on leaves and other herbaceous parts are common symptoms of disease, and often furnish clues to identification of causes, though it must be remembered that no sharp line divides this class of symptoms from the preceding. By far the greater number of spot-diseases are due to Fungi, as indicated by the numerous "leaf-diseases" described, but such is by no means always the case. The spot or patch is an area of injury; on (or in) it the cell-tissues are suffering destruction from shading, blocking of stomata, loss of substance or direct mechanical injury, and the plant suffers in proportion to the area of leaf surface put out of action. It is somewhat artificial to classify these diseases according to the colour of the spots, and often impossible, because the colour may differ according to the age of the part attacked and the stage of injury attained; many Fungi, for instance, induce yellow spots which become red, brown or black as they get older, and so on. White or grey spots may be due to *Peronospora*, *Erysiphe*, *Cystopus*, *Entyloma* and other Fungi, the mycelium of which will be detected in the discoloured area; or they may be scale insects, or the results of punctures by Red-spider, &c. Yellow spots, and especially bright orange spots, commonly indicate Rust Fungi or other Uredineae; but *Phyllosticta*, *Exoascus*, *Clasterosporium*, *Synchytrium*, &c., also induce similar symptoms. Certain Aphides, Red-spider, Phylloxera and other insects also betray their presence by such spots. It is a very common event to find the early stages of injury indicated by pale yellow spots, which turn darker, brown, red, black, &c., later, e.g. *Dilophia*, *Rhizisma*, &c. Moreover, variegations perceptibly like these disease spots are known, e.g. *Senecio*, *Kalmia*, &c. Red spots may indicate the presence of Fungi, e.g. *Polystigma*, or insects, e.g. *Phytolius*. Brown spots are characteristic of *Phytophthora*, *Peronospora*, &c. and black ones of *Fusicladium*, *Ustilago*, *Rhizisma*, &c. Both are common as advanced symptoms of destruction by Fungi and insects. Brilliantly coloured spots and patches follow the action of acid fumes on the vegetation near towns and factories, and such parti-coloured leaves often present striking resemblance to autumn foliage. Symptoms of scorching owing to abnormal insolation—e.g. in greenhouses where the sun's rays are concentrated on particular spots—and a certain class of obscure diseases, such as "silver-leaf" in plums, "foxy leaves" in various plants, may also be placed here.

3. **Wounds.**—The principal phenomena resulting from a simple wound, and the response of the irritated cells in healing by cork and in the formation of callus, have been indicated above. Any clean cut, fracture or bruise which injures the cambium over a limited area is met with the same response. The injured cells die and turn brown; the living cells beneath grow out, and form cork, and under the released pressure bulge outwards and repeatedly divide, forming a mass of succulent regenerative tissue known as *callus*. Living cells of the pith, phloem, cortex, &c., may also co-operate in this formation of regenerative tissue, and if the wound is a mere knife-cut in the "bark," the protruding lips of callus formed at the edges of the wound soon meet, and the slit is healed over—occluded. If a piece of bark and cortex are torn off, the occlusion takes longer, because the tissues have to creep over the exposed area of wood; and the same is true of a transverse cut severing the branch, as may be seen in any properly pruned tree. Wounds may be artificially grouped under such heads as the following: Burrows and excavations in bark and wood due to boring insects, especially beetles. Breakages and abrasions due to wind, snow, lightning, and other climatic agents. Cuts, breakages, &c., due to man and other vertebrate animals. Erosions of leaves and herbaceous parts by caterpillars, slugs, earwigs and so forth. Frost-cracks, scorching of bark by sun and fire, &c., and

wounds due to plants which entwine, pierce or otherwise materially injure trees, &c., on a large scale.

4. *Excrescences*.—Outgrowths, more or less abnormal in character, are frequent signs of diseased organs. They are due to hypertrophy of young tissues, which may undergo profound alterations subsequently, and occur on all parts of the plants. The injury which initiates them may be very slight in the first place—a mere abrasion, puncture or Fungus infection—but the minute wound or other disturbance, instead of healing over normally, is frequently maintained as a perennial source of irritation, and the regenerative tissues grow on month after month or year after year, resulting in extraordinary outgrowths often of large size and remarkable shape. Excrescences may be divided into those occurring on herbaceous tissues, of which *Galls* are well-known examples, and those found on the woody stem, branches, &c., and themselves eventually woody, of which *Burs* of various kinds afford common illustrations. Among the simplest examples of the former are the hairs which follow the irritation of the cells by mites. These hairs often occur in tufts, and are so coloured and arranged that they were long taken for Fungi and placed in the "genus" *Erineum*.

Cecidias or galls arise by the hypertrophy of the subepidermal cells of a leaf, cortex, &c., which has been pierced by the ovipositor of an insect, and in which the egg is deposited. The irritation set up by the hatching egg and its resulting larva appears to be the stimulus to development, and not a poison or enzyme injected by the insect. The extraordinary forms, colours and textures of the true galls have always formed some of the most interesting of biological questions, for not only is there definite co-operation between a given species of insect and of plant, as shown by the facts that the same insect may induce galls of different kinds on different plants or organs, while different insects induce different galls on the same plant—e.g. the numerous galls on the oak—but the gall itself furnishes well adapted protection and abundant stores of nutriment to its particular larva, and often appears to be borne without injury to the plant. This latter fact is no doubt due to the production of an excess of plastic materials over and above what the tree requires for its immediate needs. Galls in the wide sense—technically *Cecidias*—are not always due to insects. The nodules on the roots of leguminous plants are induced by the presence of a minute organism now known to do no injury to the plant. Those on turnips and other Cruciferæ are due to the infection of *Plasmiodiophora*, a dangerously parasitic Myxomycete. Nodules due to "eel-worms" (Nematodes) are produced on numerous classes of plants, and frequently result in great losses—e.g. tomatoes, cucumbers, &c.; and the only too well known Phylloxera, which cost France and other vine-growing countries many millions sterling, is another case in point. Fungus-galls on leaves and stems are exemplified by the "pocket-plums" caused by the *Exoascæ*, the black blistering swellings of *Ustilago Maydis*, the yellow swellings on nettles due to *Aecidium*, &c.

In many cases the swellings on leaves are minute, and may be termed *puistules*—e.g. those due to *Synchytrium*, *Protomyces*, *Cystopus*, many *Ustilagineæ*, &c. These cases are not easily distinguished superficially from the pustular outgrowth of actual mycelia and spores (stromata) of such Fungi as *Nectria*, *Puccinia*, &c. The cylindrical stem-swellings due to *Calyptospora*, *Epichloe*, &c., may also be mentioned here, and the tyro may easily confound with these the layers and cushions of eggs laid on similar organs by moths. There is a class of gall-like or pustular outgrowths for which no external cause has as yet been determined, and which are therefore often ascribed to internal causes of disease. Such are the cork-warts on elms, maples, &c., and the class of outgrowths known as *Intumescences*. Recent researches point to definite external conditions of moisture, affecting the processes of respiration and transpiration, &c., as being responsible for some of these. The "scab" of potatoes is another case in point. Frost blisters are pustular swellings due to the up-growth of callus-tissue into cavities caused by the uprising of the superficial cortex under the action of intense cold.

Turning now to outgrowths of a woody nature, the well-known *burs* or "knours," so common on elms and other trees are cases in point. They are due to some injury—e.g. bruising by a cart-wheel, insects—having started a callus on which adventitious buds arise, or to the destruction of buds at an early stage. Then, stores of food-material being accumulated at the injured place, other buds arise at the base of or around the injured one. If matters are propitious to the development of these buds, then a tuft of twigs is formed and no burr; but if the incipient twigs are also destroyed at an early stage, new buds are again formed, and in larger numbers than before, and the continued repetition of these processes leads to a sort of conglomerate woody mass of fused bud-bases, not dead, but unable to grow out, and thus each contributing a crowded portion of woody material as it slowly grows. There are many varieties of burs, though all woody outgrowths of old trees are not to be confounded with them, e.g. the "knees" of *Taxodium*, &c. Many typical burs might be described as witches'-brooms, with all the twigs arrested to extremely short outgrowths. Witches'-brooms are the tufted bunches of twigs found on silver firs, birches and other trees, and often present resemblances to birds' nests or clumps of mistletoe if only seen from a distance.

They are branches in which a perennial Fungus (*Aecidium*, *Exoascæ*, &c.) has obtained a hold. This Fungus stimulates the main twig to shoot out more twigs than usual; the mycelium then enters each incipient twig and stimulates it to a repetition of the process, and so in the course of years large broom-like tufts result, often markedly different from the normal.

But undoubtedly the most important of the woody excrescences on trees are *cankers*. A canker is the result of repeated frustrated attempts on the part of the callus to heal up a wound. If a clean cut remains clean, the cambium and cortical tissues soon form callus over it, and in this callus—regenerative tissue—new wood, &c. soon forms, and if the wound was a small one, no trace is visible after a few years. But the occluding callus is a mass of delicate succulent cells, and offers a dainty morsel to certain insects—e.g. Aphides—and may be easily penetrated by certain Fungi such as *Botrytis*, *Nectria*; and when thus attacked, the repeated conflicts between the cambium and callus, on the one hand, trying to heal over the wound, and the insect or Fungus, on the other, destroying the new tissues as they are formed, results in irregular growths; the still uninjured cambium area goes on thickening the bark, the dead parts, of course, remain unthickened, and the portion in which the Fungus is at work may for the time being grow more rapidly. Such cankers often commence in mere insect punctures, frosted buds, cracks in the cortex, &c., into which a germinating spore sends its hypha. The seriousness of the damage done is illustrated by the ravages of the larch disease, apple canker, &c.

5. *Exudations and Rotting*.—The outward symptoms of many diseases consist in excessive discharges of moisture, often accompanied by bursting of over-turgid cells, and eventually by putrefactive changes. Conditions of hyper-turgescence are common in herbaceous plants in wet seasons, or when overcrowded and in situations too moist for them. This unhealthy state is frequently combined with etiolation: what is termed rankness is a particular case, and if the factors concerned are removed by drainage, weeding out, free transpiration, &c., no permanent harm may result. With seedlings and tender plants, however, matters are frequently complicated by the onslaughts of Fungi—e.g. *Pythium*, *Peronospora*, *Comptosia*, *Volvella*, *Botrytis*, &c. That such over-turgescence should lead to the bursting of fleshy fruits, such as gooseberries, tomatoes and grapes, is not surprising, nor can we wonder that fermentation and mould Fungi rapidly spread in such fruits; and the same is true for bulbs and herbaceous organs generally. The rotting of rhizomes, roots, &c., also comes into this category; but while it is extremely difficult in given cases to explain the course of events in detail, certain Fungi and bacteria have been so definitely associated with these roots—e.g. beet-rot, turnip disease, wet-rot of potatoes—that we have to consider each case separately. It is, of course, impossible to do this here, but I will briefly discuss one or two groups of cases.

Honey-dew.—The sticky condition of leaves of trees—e.g. lime—in hot weather is owing to exudations of sugar. In many cases the punctures of Aphides and Coccidæ are shown to be responsible for such exudations, and at least one instance is known where a Fungus—*Claviceps*—causes it. But it also appears that honey-dew may be excreted by ordinary processes of over-turgescence pressing the liquid through water-pores, as in the tropical *Coccolpina*, *Calliandra*, &c. That these exudations on leaves should afterwards serve as pabulum for Fungi—e.g. *Pumego*, *Antennaria*—is not surprising, and the leaves of limes are often black with them.

Flux.—A common event in the exudation of turbid, frothing liquids from wounds in the bark of trees, and the odours of putrefaction and even alcoholic fermentation in these are sufficiently explained by the coexistence of albuminous and saccharine matters with fungi, yeasts and bacteria in such fluxes. It is clear that in these cases the obvious symptom—the flux—is not the primary one. Some wound in the succulent tissues has become infected by the organisms referred to, and their continued action prevents healing. At certain seasons the wound "bleeds," and the organisms—some of which, by the bye, are remarkable and interesting forms—multiply in the nutritious sap and ferment it. The phenomenon is, in fact, very like that of the fermentation of palm wine and pulque, where the juices are obtained from artificial cuts.

Comparable with these cases is that of *Cuckoo-spit*, due to the juices sucked out by *Aphrophthora* on herbaceous plants of all kinds. Outflows of resin—*Resinosis*—also come under this general heading; but although some resin-fluxes are traced to the destructive action of *Agaricus melleus* in Conifers, others, as well as certain forms of Gummosis, are still in need of explanation.

Bacteriosis.—Many of the plant diseases involving rot have been ascribed to the action of bacteria, and in some cases—e.g. cabbage-rot, bulb-rot of hyacinths, &c., carnation disease—there is evidence that bacteria are causally connected with the disease. It is not sufficient to find bacteria in the rotting tissues, however, nor even to be successful in infecting the plant through an artificial wound, unless very special and critical precautions are taken, and in many of the alleged cases of bacteriosis the saprophytic bacteria in the tissues are to be regarded as merely secondary agents.

6. *Necrosis*.—A number of diseases the obvious symptoms of which are the local drying up and death of tissues, in many cases

with secondary results on organs or parts of organs, may be brought together under this heading. No sharp line can be drawn between these diseases and some of the preceding, inasmuch as it often depends on the external conditions whether necrosis is a dry-rot, in the sense I employ the term here, or a wet-rot, when it would come under the preceding category. The "dying back" of the twigs of trees and shrubs is a frequent case. The cortical tissues gradually shrink and dry up, turning brown and black in patches or all over, and when at length the cambium and medullary ray tissues dry up the whole twig dies off. This may be due to frost, especially in "thin-barked" trees, and often occurs in beeches, pears, &c.; or it may result from bruising by wind, hailstones, gun-shot wounds in coverts, &c., the latter of course very local. It is the common result of fires passing along too rapidly to burn the trees; and "thin-barked" trees—hornbeam, beech, fir, &c.—may exhibit it as the results of sunburn, especially when exposed to the south-west after the removal of shelter. The effects of frost and of sunburn are frequently quite local. The usual necrosis of the injured cortex occurs—drying up, shrivelling, and consequent stretching and cracking of the dead cortex on the wood beneath. Such frost-cracks, sun-cracks, &c., may then be slowly healed over by callus, but if the conditions for necrosis recur the crack may be again opened, or if Fungi, &c., interfere with occlusion, the healing is prevented; in such cases the local necrosis may give rise to cankers. The dying back of twigs may be brought about by many causes. General attacks of leaf-diseases invariably lead to starvation and necrosis of twigs, and similarly with the ravages of caterpillars and other insects. Drought and consequent defoliation result in the same, and these considerations help us to understand how old-established trees in parks, &c., apparently in good general health, become "stag-headed" by the necrosis of their upper twigs and smaller branches; the roots have here penetrated into subsoil or other unsuitable medium, or some drainage scheme has deprived them of water, &c., and a drier summer just turns the scale. Such phenomena are not uncommon in towns, where trees with their roots under pavement or other impervious covering do well for a time, but suddenly fail to supply the crown sufficiently with water during some hot summer.

7. *Monstrosities*.—A large class of cases of departure from the normal form, depending on different and often-obscure causes, may be grouped together under this heading; most of them are of the kind termed *Teratological*, and it is difficult to decide how far they should be regarded as pathological if we insist that a disease threatens the existence of the plant, since many of these malformations—e.g. double flowers, phyllody of floral parts, contortions and fascinations, dwarfing, malformed leaves, &c.—can not only be transmitted in cultivation, but occur in nature without evident injury to the variety. In many cases, however, monstrosities of flowers have been shown to be due to the irritating action of minute insects or Fungi, and others are known which, although induced by causes unknown to us, and regarded as internal, would not be likely to survive in the wild condition. This subject brings the domain of pathology, however, into touch with that of variation, and we are profoundly ignorant as to the complex of external conditions which would decide in any given case how far a variation in form would be prejudicial or otherwise to the continued existence of a species. Under the head of malformations we place cases of atrophy of parts or general dwarfing, due to starvation, the attacks of Fungi or minute insects, the presence of unsuitable food-materials and so on; as well as cases of transformation of stamens into petals, carpels into leaves, and so forth. Roots are often flattened, twisted and otherwise distorted by mechanical obstacles; stems by excess of food in rich soils, the attacks of minute parasites, overgrowth by climbing plants, &c. Leaves are especially apt to vary, and although the formation of crests, pitchers, puckers, &c., must be put down to the results of abnormal development, it is often difficult to draw the line between teratological and merely varietal phenomena. For instance, the difference between the long-stalked and finely-cut leaves of *Anemone* attacked with rust and the normal leaves with broad segments, or between the urceolate leaves occasionally found on cabbages and the ordinary form—in these cases undoubtedly pathological and teratological respectively—is nothing like so great as between the upper and lower normal-leaves of many Umbelliferae or the submerged and floating leaves of an aquatic *Ranunculus* or *Cabomba*. When we come to phenomena such as proliferations, vivipary, the development of "Lammas shoots," adventitious buds, epicormic branches, and to those malformations of flowers known as peloria, phyllody, virescence, &c. while assured that definite, and in many cases recognizable, physiological disturbances are at work, we find ourselves on the borderland between pathological and physiological variation, where each case must be examined with due regard to all the circumstances, and no generalization seems possible beyond what has been sketched. This is equally true of the phenomena of gemmacy and apomorphy in the light of recent researches into the effects of external conditions on reproduction.

This sketch of an enormous subject shows us that the pathology of plants is a special department of the study of variations which threaten injury to the plant, and passes imperceptibly into the

study of variations in general. Moreover, we have good reasons for inferring that different constellations of external causes may determine whether the internal physiological disturbances induced by a given agent shall lead to pathological and dangerous variations, or to changes which may be harmless or even advantageous to the plant concerned.

AUTHORITIES.—General and Historical.—Berkeley, "Vegetable Pathology," *Gardener's Chronicle* (1855) p. 4; Flourens, *British Uredineae and Ustilagineae* (1889); Eriksson and Henning, *Die Getreideroste* (Stockholm, 1896); De Bary, *Comparative Morph. and Biol. of the Fungi, &c.* (1887); Frank, *Die Krankheiten der Pflanzen* (1895-1896); Sorauer, *Handbuch der Pflanzenkrankheiten* (1906); Ward, *Disease in Plants* (1901). Causes of Disease, &c.—Pfeffer, *Physiology of Plants* (Oxford, 1900); Sorauer, *Treatise on the Physiology of Plants* (1895); Bailey, *The Principles of Agriculture* (1898); Lolar, *Technical Mycology* (1898); Hartig, *Diseases of Trees* (1894); Marshall Ward, *Proc. Roy. Soc.* (1890) xvii. 394; and *Timber and some of its Diseases* (London, 1889). Fungi.—See FUNGI and BACTERIA; also Marshall Ward, *Diseases of Plants* (Romance of Science Series), S.P.C.K.; Massee, *Text-Book of Plant Diseases* (1899); Tübel, *Diseases of Plants* (London, 1897); Insects.—Ormerod, *Manual of Injurious Insects* (1890); C. V. Riley, *Insect Life*, U.S. Department of Agriculture (1888-1895); Judeich and Mitsche, *Lehrbuch der mittel-europäischen Forstinsektenkunde* (Vienna, 1899). Healing of Wounds, &c.—Shattock, "On the Reparatory Processes which occur in Vegetable Tissues," *Journ. Linn. Soc.* (1882) xix. 1; Richards, "The Respiration of Wounded Plants," *Ann. of Bot.* (1896), x. 531; and "The Evolution of Heat by Wounded Plants," *Ann. of Bot.* (1897), xi. 29. Enzymoses.—Green, *The Soluble Ferments and Fermentation* (1899). Chemotaxis, &c.—Miyoshi, "Die Durchbohrung von Membranen durch Pilzfäden," *Pflanzsch. Jahrb.*, B. (1895), xxviii. 269, and literature. Parasitism, &c.—Marshall Ward, "On some Relations between Host and Parasite, &c.," *Proc. Roy. Soc.* xvii. 393; and "Symbiosis," *Ann. of Bot.* (1899), xiii. 549, with literature. Specialization of Parasitism.—Salmon, in Massee's *Text-Book of Fungi* (1906), pp. 146-157. Statistics.—See Wyatt, *Agricultural Ledger* (Calcutta, 1895), p. 71; Balfour, *The Agricultural Pests of India* (1887), p. 13; Eriksson and Henning, *Die Getreideroste*; the publications of the U.S. Agricultural Department; the *Kew Bulletin*; *Zeitschrift für Pflanzenkrankheiten*, and elsewhere. Spraying, &c.—See Lodeleman, *The Spraying of Plants* (1896), and numerous references in the publications of U.S. Agricultural Department, *Zeitschr. f. Pflanzenkrankheiten*, the *Gardener's Chronicle*, &c. Etiology, &c.—Pfeffer, *Physiology of Plants*, and other works on physiology. Albinism, &c.—Church, "A Chemical Study of Vegetable Albinism," *Journ. Chem. Soc.* (1879, 1880 and 1886); Beijerinck, "Ueber ein Contagium," &c., in *Verhandl. d. kön. Acad. v. Wet.* (Amsterdam, 1898); Koning in *Zeitschr. f. Pflanzenkrankh.* (1899), ix. 65; Baur, *Ber. deutschen bot. Ges.* (1904), xii. 453; *Sitzungsber. berlin. Akad.* (Jan. 6, 1906); Hunger, *Zeitschr. f. Pflanzenkrankheiten* (1905) xv. Heft. 5. Wounds, &c.—Marshall Ward, *Timber and some of its Diseases*, p. 210; Hartig, *Diseases of Trees* (London, 1894). Coccidia and Galls.—Küster, "Beiträge zur Kenntnis der Gallen-anatomie," *Flora* (1900), p. 117; *Pathologische Pflanzenanatomie* (1903); Molliard, *Revue générale de bot.* (1900), p. 157. Canker.—Frank, *Krankheiten der Pflanzen*, and papers in *Zeitschr. f. Pflanzenkrankh.* Rotting, &c.—Migula, *Krit. Uebersicht derjenigen Pflanzenkrankheiten, welche angeblich durch Bakterien verursacht werden* (1892); Smith, "Pseudomonas campestris," *Cent. f. Bakt.* B. iii. 284 (1897); Arthur and Bolley, *Bacteriosis of Carnations*, Purdue Univ. Agr. Station (1896), vii. 17; A. F. Woods, "Stigmoneose, a Disease of Carnations," *Vegetable, Physiol. and Pathol. Bull.* 19 U.S. Department of Agriculture (1900); Sorauer, *Handbuch der Pflanzenkrankheiten* (1905), 18-93. Frost, Drought, &c.—Hartig, *Lehrbuch der Anat. und Phys. der Pflanzen*; Fischer, *Forest Protection*, iv. of Schlich's *Manual of Forestry*. Teratology, &c.—Masters, *Vegetable Teratology*, Ray Society (1869); Molliard, "Cécidies florales," *Ann. Sci. Nat.* sér. 8, i. (bot.) p. 67 (1895). (H. M. W.)

ECOLOGY OF PLANTS

Introduction.—The word *ecology* is derived from *oikos*, a house (habitat), and *logos*, a discourse. As a botanical term, *ecology* denotes that branch of botany which comprises the study of the relations of the individual plant, or the species, or the plant community with the habitat. Following Schröter¹ (Flahault and Schröter, 1910 : 24), the term *autecology* may be used for the study of the habitat conditions in relation to the single species, and the term *synecology* for this study in relation to plant communities.

From the phytogeographical standpoint, *ecology* is frequently termed *ecological plant geography*. Thus Warming² (1901 : 1 and 2)

¹ Flahault and Schröter, *Phytogeographical Nomenclature: reports and propositions* (Zurich, 1910).

² Warming, *Oecology of Plants* (Oxford, 1909).

subdivided plant geography into floristic plant geography and ecological plant geography. The former is concerned with the division of the earth's surface into major districts characterized by particular plants or taxonomic groups of plants, with the subdivision of these floristic districts, and with the geographical distribution (both past and present) of the various taxonomic units, such as species, genera, and families. On the other hand, ecological plant geography seeks to ascertain the distribution of plant communities, such as associations and formations, and enquires into the nature of the factors of the habitat which are related to the distribution of plants—plant forms, species, and communities. In a general way, floristic plant geography is concerned with species, ecological plant geography with vegetation. The study of the distribution of species dates back to the time of the early systematists, the study of vegetation to the time of the early botanical travellers. Humboldt,¹ for example, defined his view of the scope of plant geography as follows: "C'est cette science qui considère les végétaux sous les rapports de leur association locale dans les différents climats" (1807: 14).

The Habitat.—The term *habitat*, in its widest sense, includes all the factors of the environment which affect a plant or a plant community, though the term is frequently used to signify only some of these factors. The factors of the habitat may be grouped as follows: geographical, physical, and biological.

Geographical Factors.—Geographical position determines the particular species of plants which grow in any particular locality. This matter is bound up with the centres of origin and with the past migrations of species; and such questions are usually treated as a part of floristic plant geography. Here, therefore, floristics and ecology meet. Flahault and Schröter,² in defining the term *habitat*, appear to exclude all geographical factors. They state that "the term *habitat* is understood to include everything relating to the factors operative in a geographically defined locality, so far as these factors influence plants" (1910: 24); but the exclusion of geographical and historical factors from the concept of the *habitat* does not appear to be either desirable or logical.

Physical Factors.—These are frequently classified as edaphic or soil factors and climatic factors; but there is no sharp line of demarcation between them. Edaphic factors include all those relating to the soil. The water content of the soil, its mineral content, its humus content, its temperature, and its physical characteristics, such as its depth and the size of its component particles are all edaphic factors. Climatic factors include all those relating to atmospheric temperature, rainfall, atmospheric humidity, and light and shade. Factors connected with altitude, aspect, and exposure to winds are also climatic: such are often spoken of as *physiographical factors*. The difficulty of sharply delimiting edaphic and climatic factors is seen in the case of temperature. Soil temperature is partly dependent on the direct rays of the sun, partly on the colour and constitution of the soil, and partly on the water content of the soil. Again, the temperature of the air is affected by radiation from the soil; and radiation differs in various soils.

Biological Factors.—These include the reactions of plants and animals on the habitat. Here again, no sharp boundary-line can be drawn. In one sense, the accumulation of humus and peat is a biological factor, as it is related to the work of organisms in the soil; but the occurrence or otherwise of these organisms in the soil is probably related to definite edaphic and climatic conditions. Again, the well-known action of earthworms may be said to be a biological work; but the resulting aeration of the soil causes edaphic differences; and earthworms are absent from certain soils, such as peat. The pollination of flowers and the dispersal of seeds by various animals are biological factors; but pollination and dispersal by the wind cannot be so regarded. The influence of man on plants and vegetation is also a biological factor, which is frequently ignored as such, and treated as if it were a thing apart.

When the nature and effect of ecological factors have become more fully understood, it will be possible to dispense with the above artificial classification of factors, and to frame one depending on the action of the various factors; but such a classification is not possible in the present state of knowledge.

Ecology and Physiology.—Whilst our knowledge of the nature and effect of habitat is still in a very rudimentary condition, much progress has been made in recent years in the study of plant communities; but even here the questions involved in relating the facts of the distribution of plant communities to the

factors of the habitat are very imperfectly understood. This is due to a lack of precise knowledge of the various habitat factors and also of the responses made by plants to these factors. Until much more advance has been made by ecologists in the investigation of the nature of habitat factors, and until the effect of the factors on the plants has been more closely investigated by physiologists, it will remain impossible to place ecology on a physiological basis: all that is possible at present is to give a physiological bias to certain aspects of ecological research. Obviously no more than this is possible until physiologists are able to state much more precisely than at present what is the influence of common salt on the plants of salt-marshes, of the action of calcium carbonate on plants of calcareous soils, and of the action of humous compounds on plants of fens and peat moors.

Ecological Classes.—Many attempts have been made to divide plants and plant communities into classes depending on habitat factors. One of the best known classifications on these lines is that by Warming.³ Warming recognized and defined four ecological classes as follows:—

Hydrophytes.—These live in a watery or wet substratum, with at least 80% of water. Warming included plants of peat-bogs among his hydrophytes.

Xerophytes.—These are plants which live in very dry places, where the substratum has less than 10% of water.

Halophytes.—These are plants living in situations where the substratum contains a high proportion of sodium chloride.

Mesophytes.—These are plants which live in localities which are neither specially dry nor specially wet nor specially salty.

Such terms as hydrophytes, xerophytes, and halophytes had been used by plant geographers before Warming's time e.g., by Schouw,⁴ and the terms evidently supply a want felt by botanists as they have come into general use. However, the terms are incapable of exact definition, and are only useful when used in a very general way. The above classification by Warming, although it was without doubt the best ecological classification which had, at the time, been put forward, has not escaped criticism. The criticisms were directed chiefly to the inclusion of sand dune plants among halophytes, to the exclusion of halophytes from xerophytes, to the inclusion of "bog xerophytes" among hydrophytes, to the inclusion of all conifers among xerophytes and of all deciduous trees among mesophytes, and to the group of mesophytes in general.

Schimper⁵ made a distinct advance when he distinguished between physical and physiological dryness or wetness of the soil. A soil may be physically wet; but if the plants absorb the water only with difficulty, as in a salt marsh, then the soil is, as regards plants, physiologically dry. All soils which are physically dry are also physiologically dry; and hence only the physiological dryness or wetness of soils need be considered in ecology.

Schimper used the term *xerophytes* to include plants which live in soils which are physiologically dry, and the term *hygrophytes* those which live in soils which are physiologically wet or damp. Schimper recognized that the two classes are connected by transitional forms, and that it is useless to attempt to give the matter a statistical basis. It is only in a general sense like Schimper's that such ecological terms as xerophytes have any value; and it is not possible, at least at present, to frame ecological classes, which shall have a high scientific value, on a basis of this nature. Whilst Schimper objected to the constitution of a special category, such as mesophytes, to include all plants which are neither pronounced xerophytes nor pronounced hygrophytes, he recognized the necessity of a third class in which to place those

¹ Warming, *Plantensamfund*, Kjöbenhavn, 1895. (See German trans. by Knoblauch, "Lehrbuch der ökologischen Pflanzengeographie" (Berlin, 1896); new German ed. by Graebner (Berlin, 1902).)

² Schouw, *Grundtracé til en almindelig Plantegeografi* (Kjöbenhavn, 1822); German trans., "Grundzüge einer allgemeinen Pflanzengeographie" (Berlin, 1823).

³ Schimper, *Pflanzengeographie auf physiologischer Grundlage* (Berlin, 1898); Eng. trans. by Fisher, "Plant Geography upon a Physiological Basis" (Oxford, 1903-1904).

¹ Humboldt and Bonpland, *Essai sur la géographie des plantes* (Paris, 1807).

² Flahault and Schröter (*op. cit.*).

plants which, like deciduous trees and bulbous plants, are hydrophytes during one season of the year and xerophytes during another season of the year. Such plants, which comprise the great majority of the species of the central European flora, Schimper termed *tropophytes*.

Recently, Warming¹ (1909 : 136), assisted by Vahl, has modified his earlier classification, and adopted the following:—

A. The soil (in the widest sense) is very wet, and the abundant water is available to the plant (at least in hydrophytes).

1. *Hydrophytes*.—These include plants of the *plankton*, or microphytes that float free on water, of the *pleuston*, or macrophytes which float on or are suspended in water, and of the *benthos*, or all aquatic plants which are fixed to the substratum.

2. *Helophytes*.—These are marsh plants which normally have their roots in soaking soil but whose branches and foliage are more or less aerial. Warming admits there is no sharp limit between marsh plants and land plants; and it seems equally obvious that there is no sharp limit between some of his helophytes and some of his hydrophytes. For example, the difference between aquatic plants with floating leaves, such as the yellow water-lily (*Nymphaea lutea*) and those with erect leaves, such as *Typha angustifolia*, is probably more apparent than real. Among helophytes, Warming places plants of the reed swamp, and includes such trees as the alder (*Alnus rotundifolia*), willows (e.g. *Salix alba*, *S. fragilis*, *S. cinerea*, *S. pentandra*), birch, and pine, when these grow in marshy places.

B. The soil is physiologically dry.

3. *Oxylophytes*.—These plants, sometimes spoken of as "bog xerophytes," grow in soils which contain an abundance of free humous compounds, and include plants which grow on fens and moors.

4. *Psychrophytes*.—These include the plants which grow on the cold soils of subnival and polar districts.

5. *Halophytes*.—These are plants which grow on saline soils.

C. The soil is physically dry.

6. *Lithophytes*.—These are plants which grow on "true rock," but not "on the loose soil covering rock, even though this may entertain species that are very intimately associated with the rock. Still to this limitation an exception must be made in favour of the vegetation growing in clefts and niches" (Warming, 1909 : 240). Many Algae, lichens, and mosses are included among lithophytes, and also *Saxifraga Atrovirens*, *S. oppositifolia*, *Silene acaulis*, and *Gnaphalium luteo-album*.

7. *Psammophytes*.—These are plants which grow on sand and gravel. Plants of sand-dunes, whether in maritime or inland localities, are psammophytes, as well as plants (such as *Calluna vulgaris*) of dune heaths, dune "bushland" or scrub, and dune forest.

8. *Chersophytes*.—Here are placed certain "xerophytic perennial herbs" which occur on "particular dry kinds of soil, such as limestone rocks, stiff clay, and so forth" (Warming, 1909 : 289).

D. The climate is very dry, and the properties of the soil are decided by climate.

9. *Eremophytes*.—Under this term, are placed plants of deserts and steppes.

10. *Psilophytes*.—Here are placed plants found in "savannah-vegetation," viz. (i.) "thorny savannah-vegetation, including: (a) orchard-scrub, (b) thorn-bushland and thorn-forest; (ii.) true savannah: tropical and sub-tropical savannah; (iii.) savannah-forest, including bush-forest in Africa and 'campos serrados' in Brazil" (Warming, 1909 : 293 et seq.).

11. *Sclerophyllous formations*, e.g., garigues, maquis, and forests of evergreen oaks (*Q. ilex*, *Q. Ballota*, *Q. Suber*), and of *Eucalyptus* spp.

E. The soil is physically or physiologically dry.

12. *Coniferous forest formations*, e.g., of *Pinus sylvestris*, *Picea excelsa*, *Abies pectinata*, *Larix sibirica*, *L. decidua*.

F. "Soil and climate favour the development of mesophilous formations."

13. *Mesophytes*.—Warming defines mesophytes as "plants that show a preference for soil and air of moderate humidity, and avoid soil with standing water or containing a great abundance of salts" (1909 : 317). Under mesophytes, Warming places plants occurring in "Arctic and Alpine mat-grassland and mat-herbage," in "mat-vegetation of the Alps," in meadows, in pasture on cultivated soil, in "mesophytic bushland," in deciduous dicotyledonous forests, and in evergreen dicotyledonous forests.

This new system of Warming's, whilst probably too involved ever to come into general use, must be taken as superseding his older one;² and perhaps the best course open to botanists is to select such terms as appear to be helpful, and to use the selected terms in a general kind of way and without demanding any precise definitions of them: it must also be borne in mind that the

various classes are neither mutually exclusive nor of equivalent rank. From this point of view, the following terms will perhaps be found the most serviceable:—

Hydrophytes (submerged aquatic plants).—Plants whose vegetative organs live wholly in water; e.g., most Algae, many mosses, such as *Fontinalis* spp., and liverworts, such as *Jungermannia* spp.; a few Peridophytes, such as *Pulsalaria* spp., *Soetes* spp., several flowering plants, such as *Potamogetion pectinatus*, *Ceratophyllum* spp., *Hottonia palustris*, *Utricularia* spp., *Littorella lacustris*, *Hemi-hydrophytes* (swamp plants, marsh plants, &c.).—Plants whose vegetative organs are partly submerged and partly aerial; *Vaschiera terrestris*, *Philotomis fontana*, *Scapsaria undulata*, *Marsilia* spp., *Salvinia natans*, *Azolla* spp., *Equisetum limosum*, *Typha angustifolia*, *Phragmites communis*, *Scirpus lacustris*, *Nymphaea lutea*, *Oenanthe fistulosa*, *Bidens cernua*.

Hygrophytes.—Plants which are sub-evergreen or evergreen but not sclerophyllous, and which live in moist soils; e.g., *Lastraea Fütz-mas*, *Poa pratensis*, *Carex ovalis*, *Plantago lanceolata*, and *Achillea Millefolium*.

Xerophytes.—Plants which grow in very dry soils; e.g., most lichens, *Amomphila (Psamma) arenaria*, *Elymus arenarius*, *Anabasis arietinis*, *Zilla macroptera*, *Sedum acre*, *Bupleurum spinosum*, *Artemisia herba-alba*, *Zollikoferia arborescens*.

Halophytes.—Plants which grow in very saline soils; e.g., *Triglochin maritimum*, *Salicornia* spp., *Zygophyllum cornutum*, *Aster Tripolium*, *Artemisia maritima*. It should be recognized, however, that "a halophyte, in fact, is one form of xerophyte" (Warming, 1909 : 219).

Sclerophyllous Plants.—These are plants with evergreen leathery leaves, and typical of tropical, sub-tropical, and warm temperate regions; e.g., *Quercus Suber*, *Ilex Aquifolium*, *Hedera Helix*, *Eucalyptus Globulus*, *Rosmarinus officinalis*. Sclerophyllous leaves are usually characterized by entire or sub-entire margins, a thick cuticle, small but rarely sunken stomata, a well-developed and close-set palisade tissue and a feeble system of air-spaces.

Hydro-xerophytes ("bog xerophytes").—Plants which live in wet, peaty soils, and which possess aeration channels and xerophilous leaves; e.g., *Cladium Mariscus*, *Eriophorum angustifolium*, *Rubus Chamaemorus*, and *Vaccinium Vitis-Idaea*. The term "oxylophyte" is open to the objection that some peaty waters are alkaline, and not acidic as the term implies. Many plants of peaty soils are sclerophyllous.

Tropophytes.—Plants which are hydrophytes during some favourable part of the year and xerophytes during the rest of the year; e.g., deciduous trees and shrubs, deciduous herbaceous plants with underground perennating organs, and annuals and ephemerals.

Plant Communities.—The study of plant communities (*Formationslehre* or *synecology*) has made much progress in recent years. Even here, however, general agreement has not been reached; and the questions involved in relating the facts of the distribution of plant communities to the factors of the habitat are very imperfectly understood. Plant communities may be classified as follows:—

A *plant association* is a community of definite floristic composition; it may be characterized by a single dominant species; or, on the other hand, it may be characterized by a number of prominent species, one of which is abundant here, another there, whilst elsewhere two or more species may share dominance. The former are *pure associations*, and are well illustrated by a heather moor, where *Calluna vulgaris* is the dominant plant. The latter are *mixed associations*, such as fens, where different *facies* are produced by the varying abundance of characteristic plants, such as *Cladium Mariscus*, *Phragmites communis*, *Molinia coerulea*, *Calamagrostis lanceolata*, and *Juncus obtusiflorus*. The different *facies* are possibly related to slight differences in a generally uniform habitat: it is unscientific to regard them as due to chance; still, in the majority of cases, the causes of the different *facies* have not been demonstrated. A local aggregation of a species other than the dominant one in an association brings about a *plant society*; for example, societies of *Erica Tetralix*, of *Scirpus caespitosus*, of *Molinia coerulea*, of *Carex curia*, of *Narthecium ossifragum*, and others may occur within an association of *Calluna vulgaris*. The plant societies are also doubtless due to slight variations of the habitat.

The plant association is sometimes referred to in technical language;³ the termination *-etum* is added to the stem of the generic name, and the specific name is put in the genitive. Thus

¹ See Moss, "The Fundamental Units of Vegetation: historical development of the concepts of the plant association and the plant formation." *Botany School* (Cambridge, 1910).

² Warming (1909, *op. cit.*).

³ *Ibid.* (1894, *op. cit.*).

an association of *Quercus sessiliflora* may be referred to as a *Quercetum sessiliflorae*.

A *plant formation* is a group of associations occupying habitats which are in essentials identical with each other. Thus, associations of *Agropyrum (Triticum) junceum*, of *Carex arcnaria*, of *Ammophila (Psamma) arenaria*, and of other plants occur on sand dunes: the associations are related by the general identity of the habitat conditions, namely, the physiological dryness and the loose soil; but they are separated by differences in floristic composition, especially by different dominant species, and by minor differences of the common habitat. The whole set of associations on the sand dunes constitutes a plant formation.

The plant formation may be designated in technical language by the termination *-ion* added to a stem denoting the habitat. Thus, a sand dune formation may be termed an *Arenarion*. The associational term, in the genitive, may be added to the formational term to indicate the relationship of the formation and the association; thus, a plant association of *Ammophila arenaria* belonging to the plant formation of the sand dunes may be designated an *Arenarion Ammophilae-arenariae* (cf. Moss, *op. cit.*, 1910: 43).

The question of universal names for vegetation units is bound up with that of the universality or otherwise of particular formations. "Remote regions which are floristically distinct . . . may possess areas physically almost identical and yet be covered by different formations" (Clements, 1905: 203). For example, the sand dunes of North America and those of western Europe are widely separated in geographical position and therefore in floristic composition, yet they are related by common physical factors. This relationship may be indicated by the addition of some prefix to the formational name. For example, an *Arenarion* in one climatic or geographical region might be termed an α -*Arenarion* and one in a different region a β -*Arenarion*, and so on (Moss, *loc. cit.*).

It is, however, frequently desirable to consider such allied formations as a single group. Such a group of formations may be designated a *plant federation*: and this term may be defined as a group of formations, which are characterized by common edaphic factors of the habitat, and which occur in any geographical region. Thus, different geographical or climatic regions are characterized by salt marshes. The latter all agree in their edaphic characteristics; but they differ climatically and in floristic composition. The salt marshes of a given region constitute a single plant formation: the salt marsh formations of the whole world constitute a plant federation.

Again, it is possible to arrange plant associations into groups related by a common plant form. Thus woodland associations may be classified as deciduous forests, coniferous forests, sclerophyllous forests, &c. These, in a general way, are the "formations" of Warming,³ and (in part) the "climatic formations" of Schimper.² Thus the various reed-swamps of the whole world constitute a "formation" in Warming's sense (1909: 187).

There is much difference of opinion among ecologists and plant geographers as to which of these points of view is the most fundamental. Among British authorities, it is now customary to adopt the position of Clements, who states (1905: 202) that "the connexion between formation and habitat is so close that any application of the term to a division greater or smaller than the habitat is both illogical and unfortunate," and that (1905: 18) "habitats are inseparable from the formations which they bear" (cf. Moss, 1910).

From the standpoint of plant communities, it is convenient to divide the earth's surface into (1) tropical districts;⁴ (2) sub-

¹ F. E. Clements, *Research Methods in Ecology* (1905), Lincoln, Neb., U.S.A.

² Warming (1909, *op. cit.*). ³ Schimper (1898, *op. cit.*).

⁴ The nomenclature of the terms (floristic as well as ecological) used in geographical botany is in a very confused state. In the present article, the term "district" is used in a general sense to indicate any definite portion of the earth's surface. For a discussion of such phytogeographical terms, see Flahault, "Premier essai de nomenclature phytogéographique," in *Bull. Soc. Linguistique de Géogr.* (1901); and also in *Bull. Torr. Bot. Club* (1901).

tropical and warm temperate districts; (3) temperate districts; (4) cold temperate and frigid districts.

1. *Tropical Districts*.—The vegetation of tropical districts has been subdivided by Schimper (1903: 260, et seq.) as follows:—(i.) Tropical woodland: (a) rain forest, (b) monsoon forest, (c) savana forest, (d) thorn forest. (ii.) Tropical grassland: (e) savana, (f) steppe. (iii.) Tropical desert: (a) scrub, (b) succulent plants, (c) perennial herbs.

Schimper regards the minor divisions as groups of "climatic formations"; and he also distinguishes certain tropical "edaphic formations," such as mangrove swamps. He states that rain forests and high monsoon forests in the tropics occur when the average rainfall is over 70 in. (178 cm.) per annum, and that tropical thorn forest may prevail when the mean annual rainfall is below 35 in.

A tropical rain forest exhibits great variety both of species of plant and of plant forms. There is great diversity in the trees and masses of tangled lianes, and a wealth of flowers in the leafy forest crown. Humboldt⁵ points out that whilst temperate forests frequently furnish pure associations, such uniformity of association is usually absent from the tropics. Some tropical forests exhibit dense foliage from the forest floor to the topmost leafy layer; and the traveller finds the mass of foliage almost impenetrable. Other tropical forests afford a free passage and a clear outlook. It is obvious that tropical forests will eventually be subdivided into plant associations; but the difficulties of determining the relative abundance of the species of plants in the upper layers of tropical rain and monsoon forests are very great. One of the best known results of the great struggle for light which takes place in tropical forests is the number of epiphytic plants which grow on the high branches of the trees.

The leaves of the trees are frequently of leathery consistency, very glossy, usually evergreen, entire or nearly so, and seldom hairy; and thus they agree closely with the leaves of sclerophyllous forest generally.

Monsoon forests are characteristic of localities with a seasonal rainfall. The trees usually lose their foliage during the dry season and renew it during the monsoon rains. With a less abundant rainfall, savana forest and thorn forest occur. Less precipitation induces tropical grassland, which, according to Schimper (1903: 346) is of the savana type; but Warming (1909: 327) thinks that all grassland in the tropics is artificial. Still greater drought induces desert vegetation; but, as deserts are more characteristic of subtropical districts, they are discussed later on.

Mangrove swamps, or tropical tidal forests, occur in saline or brackish swamps on flat, muddy shores in the tropics; and, being almost independent of atmospheric precipitations, Schimper regards them as "edaphic formations." However, they are climatic communities in the sense that they occur only in hot districts. Cases such as this illustrate the difficulty of regarding the distinction between "climatic formations" and "edaphic formations" as absolute. The plants exhibit markedly xerophilous structures; and many of the fruits and seeds of the mangrove trees and shrubs are provided with devices to enable them to float and with curious pneumatophores or "prop roots." The latter serve as supports and also as a means of supplying air to the parts buried in the mud. The seedlings of characteristic species of Rhizophoraceae germinate on the trees, and probably perform some assimilatory work by means of the hypocotyl.

Other tropical "edaphic formations" occur on sandy shores, where the creeping *Ipomoea biloba (Pes-caprae)* and trees of *Barringtonia* form characteristic plant associations.

The succession of associations on new soils of a tropical shore has recently been described by Ernst.⁶

2. *Warm Temperate and Subtropical Districts*.—In subtropical and warm temperate districts, characterized by mild and rainy winters and hot and dry summers, we find two types of forests. First, there are forests of evergreen trees, with thick, leathery leaves. Such forests are known as sclerophyllous forests, and they occur in the Mediterranean region, in south-west Africa, in north and south-west Australia, in central Chile, and in western California. In the Mediterranean district, forests of this type are sometimes dominated by the Cork Oak (*Quercus Suber*), sometimes by the Holm Oak (*Q. Illex*). When these forests become degenerate, mæquis and garigues respectively are produced. Mæquis and garigues are characterized by the abundance of shrubs and under-shrubs, especially by shrubby Leguminous plants, and by species *Cistus* and *Lavandula*. Secondly, there are forests of coniferous trees. In the Mediterranean region, even at comparatively low altitudes, forests occur of the maritime pine (*Pinus maritima*) and of the Aleppo pine (*P. halepensis*); and these forests are also related to mæquis and garigues respectively in the same way as the evergreen oaks. The occurrence of forests of this type in the Mediterranean and in Arctic regions, whose dominant species belong to the same genus (*Pinus*) and to the same plant form, renders it

⁵ Humboldt, Eng. trans. by Sabine, *Aspects of Nature* (London, 1849).

⁶ Eng. trans. by Seward, *The New Flora of the Volcanic Island of Krakatau* (Cambridge, 1908).

difficult to regard "coniferous forests" as a natural ecological group. At much higher altitudes, in the south-west of the Mediterranean region, forests occur of the Atlantic cedar (*Cedrus atlantica*). These occur from about 4000 ft. (1219 m.) to about 7000 ft. (2133 m.) on the Atlas Mountains. Some sclerophyllous forests of the eastern Atlas Mountains are, owing to a comparatively high rainfall, characterized by many deciduous trees, such as *Fraxinus oxyphylla*, *Ulmus campestris* (auct. alg.), *Alnus rotundifolia*, *Salix pedicellata*, *Prunus avium*, &c.; and thus they have some elements in common with the deciduous forests of central Europe.

The forests of these subtropical and warm temperate regions are situated near the sea or in mountainous regions, and (as already stated) are characterized by winter rains. In inland localities, where the rainfall is much lower, *steppe* occur. For example, in southern Algeria, a region of steppes is situated on a flat plateau, about 3000 ft. (914 metres) high, between the southern slopes of the Tell Atlas and the northern slopes of the Saharan Atlas. The rainfall, which occurs chiefly in winter, only averages about 10 in. (254 mm.) per annum. Here we find open plant associations of *Halla* or *Eparto* Grass (*Stipa tenacissima*) alternating with steppes of *Chih* (*Artemisia herba-alba*); and each plant association extends for several scores of miles. In the hollows of this steppe region, salt water lakes occur, known as *Chotts*; and on the saline soils surrounding the *Chotts*, a salt marsh formation occurs, with species of *Salicornia*, some of which are undershrubs.

Where the rainfall is still lower, *deserts* occur. At Ghardaia, in south-eastern Algeria, the mean annual rainfall, from 1887 to 1892, was about 4½ in. (114 mm.). In 1890, it fell as low as 2 in. (53 mm.) (Schimper, 1903: 606). At Beni Ounif and Colomb Béchar, in south-western Algeria, I was informed, in March 1910, that there had been no rain for about three years. Here the gravelly desert is characterized by "cushion plants," such as *Anabasis arctioides*; by "switch plants," such as *Retama Retam*; and specially by spiny plants, such as *Zizyphus Lotus* and *Zilla macropteris*; whereas succulent plants are rare. Both in the steppe and in the desert, small ephemeral species occur on the bare ground away from the large plants and especially in the wadis. Steppe and desert formations are of the open type.

3. *Temperate Districts*.—Temperate districts are characterized by forests of deciduous trees and of coniferous trees, the latter being of different species from those of the warm temperate districts, but frequently of the same plant form. The identity of plant form of many of the conifers of both temperate and of warm temperate districts is probably a matter of phylogenetic and not of ecological importance.

Britain is fairly typical of the west European district. In these islands, we find forests¹ of woods of oak (*Quercus Robur* and *Q. sessiliflora*), of birch (*Betula tomentosa*), of ash (*Fraxinus excelsior*), and of beech (*Fagus sylvatica*). In central Scotland, forests occur of *Pinus sylvestris*; and, in south-eastern England, extensive plantations and self-sown woods occur of the same species.

Just as in the Mediterranean region, the degeneration of forests has given rise to maquis and garigues, so in western Europe, the degeneration of forests has brought about different types of grassland, heaths, and moors.

4. *Cold Temperate and Frigid Districts*.—In the coldest portion of the north temperate zone, forests of dwarfed trees occur, and these occasionally spread into the Arctic region itself (Schimper, 1904: 685). Schimper distinguishes *moss tundra*, *Polytrichum tundra*, and *lichen tundra*; and the lichen tundra is subdivided into *Cladonia tundra*, *Platysma tundra*, and *Alectoria heath*. Where the climate is most rigorous, *rock tundra* occurs (p. 685).

The types of vegetation (tropical forests, sclerophyllous forests, temperate forests, tundra, &c.) thus briefly outlined are groups of Schimper's "climatic formations." Such groups are interesting in that they are vegetation units whose physiognomy is, in a broad sense, related more to climatic than to edaphic conditions. For example, Schimper, after describing the sclerophyllous woodland of the Mediterranean district and of the Cape district, says: "The scrub of West and South Australia in its ecological aspect resembles so completely the other sclerophyllous formations that a description of it must seem a repetition." This resemblance, however, only has reference to the general aspect or physiognomy of the vegetation and to the plant forms: the floristic composition of the various sclerophyllous—and other physiognomically allied—associations in the various geographical districts is very different; and indeed it is true that, just as the general physiognomy of plant associations is related to climate, so their floristic composition is related to geographical position. Hence, in any cosmopolitan treatment of vegetation, it is necessary to consider the groups of plant communities from the standpoint of the climatic or geographical district in which they occur; and this

indeed is consistently done by Schimper. Finally, within any district of constant or fairly constant climatic conditions, it is possible to distinguish plant communities which are related chiefly to edaphic or soil conditions; and the vegetation units of these definite edaphic areas are the plant formations of some writers, and, in part, the "edaphic formations" of Schimper.

When a district like England is divided into edaphic areas, a general classification such as the following may be obtained:—

1. *Physically and physiologically wet habitats*, with the accompanying plant communities of *lakes, reed swamps, and marshes*.

2. *Physically wet but physiologically dry habitats*,² with the accompanying plant communities of *fens, moors, and salt marshes*.

3. *Physically and physiologically dry habitats*, with the accompanying plant communities of *sand dunes and sandy heaths* with little-humus in the soil.

4. *Habitats of medium wetness*, with the accompanying plant communities of *woodlands and grasslands*. This class may be subdivided as follows:—

a. *Habitats poor in mineral salts*, especially calcium carbonate, often rich in acidic humous compounds, and characterized by oak and birch woods, siliceous pasture, and heaths with much acidic humus in the sandy soil.

b. *Habitats rich in mineral salts*, especially calcium carbonate, poor in acidic humous compounds, and characterized by ash woods, beech woods, and calcareous pasture.

Ecological Adaptations.—It is now possible to consider the ecological adaptations which the members of plant communities show in a given geographical district such as western Europe, of which England of course forms a part. In the present state of knowledge, however, this can only be done in a very meagre fashion; as the effect of habitat factors on plants is but little understood as yet either by physiologists or ecologists.

Hydrophytes and hemi-hydrophytes (aquatic plants).—Of marine hydrophytes, there are, in this country, only the grass-wracks (*Zostera marina* and *Z. nana*) among the higher plants. Even these species are sometimes left stranded by low spring tides, though the mud in which they are rooted remains saturated with sea-water. Although many plants typical of fresh water are able to grow also in brackish water, there are only a few species which appear to be quite confined to the latter habitats in this country. Such species perhaps include *Ruppia maritima*, *R. spiralis*, *Zannichellia maritima*, *Z. polycarpa*, *Polamogeton interruptus* (= *P. flabellatus*), and *Najas marina*.

In freshwater lakes and ponds, especially if the water is stagnant, aquatic plants are abundant. Aquatic vegetation may be conveniently classified as follows:—

Aquatic plants with submerged leaves: *Chara* spp., *Najas* spp., *Polamogeton pectinatus*, *Ceratophyllum* spp., *Myriophyllum* spp., *Hottonia palustris*, *Utricularia* spp.

Aquatic plants with submerged and floating leaves: *Glyceria fluitans*, *Ranunculus peltatus*, *Nymphaea* (*Nuphar*) *lutea*, *Callitriche stagnalis*, *Polamogeton polygonifolius*.

Aquatic plants with floating leaves: *Lemna* spp., *Hydrocharis morsus-ranae*, *Cassula* (*Nymphaea*) *alba*.

Aquatic plants with submerged leaves and erect leaves or stems: *Sagittaria sagittifolia*, *Scirpus lacustris*, *Ilypusis vulgaris*, *Sium latifolium*.

Aquatic plants with erect leaves or stems (reed swamp plants): *Equisetum palustre*, *Phragmites communis*, *Glyceria aquatica*, *Carex riparia*, *Iris Pseudacorus*, *Rumex Hydrodactylum*, *Oenanthe fistulosa*, *Bidens* spp.

Marsh plants: *Alopecurus geniculatus*, *Carex disticha*, *Juncus* spp., *Callitha palustris*, *Nasturtium palustre*.

In many aquatic plants, the endosperm of the seed is absent or very scanty. The root-system is usually small. Root-hairs are frequently missing. The submerged stems are slender or hollow. Strengthening tissue of all kinds (and sometimes even the pith) is more or less rudimentary. The stems are frequently characterized by aeration channels, which connect the aerial parts with the parts which are buried in practically airless mud or silt. Submerged leaves are usually filamentous or narrowly ribbon-shaped, thus exposing a large amount of surface to the water, some of the dissolved gases of which they must absorb, and into which they must also excrete certain gases. Stomata are often absent, absorption and excretion of gases in solution being carried on through the epidermal layer. Chloroplasts are frequently present in the epidermal cells, as in some shade plants. Very few aquatic plants are pollinated under water, but this is well-known to occur in species of *Zostera* and of *Najas*. In such plants, the pollen grains are sometimes filiform and not spheroidal in shape. In the case of aquatic plants with aerial flowers, the latter obey

¹As very little experimental work has been done with regard to physiological dryness in physically wet habitats, any classification such as the above must be of a tentative nature.

¹See Moss, Rankin, and Tansley, "British Woodlands." *Botany School* (Cambridge, 1910).

the ordinary laws of pollination. Heterophily is rather common among aquatic plants, and is well seen in several aquatic species of *Ranunculus*, many species of *Polamogeton*, *Sagittaria sagittifolia*, *Scirpus lacustris*, *Castalia* (*Nymphaea*) *alba*, *Hippuris vulgaris*, *Callitriche* spp., *Stium latifolium*.

Insectivorous species occur among aquatic plants; e.g. *Utricularia* spp., which are locally abundant in peaty waters, are insectivorous.

Xerophytes.—These plants have devices (a) for procuring water, (b) for storing water, (c) or for limiting transpiration; and these adaptations are obviously related to the physically or physiologically dry habitats in which the plants live. Plants of physiologically dry habitats, such as deserts and sand dunes, have frequently long tap-roots which doubtless, in some cases, reach down to a subterranean water supply. The same plants have sometimes a superficial root system in addition, and are thus able to utilize immediately the water from rain showers and perhaps also from dew, as Volkens¹ maintains. Root-hairs give an enlarged superficial area to the roots of plants, and thus are related to the procuring of water.

The stems of some xerophytes, e.g. Cactaceae and Crasulaceae plants, may be succulent, i.e. they have tissues in which water is stored. Some deserts, like those of Central America, are specially characterized by succulents; in other deserts, such as the Sahara, succulents are not a prominent feature. Other xerophytes again are spinous. "Switch plants," such as *Retama Retam* and broom (*Cytisus scoparius*), have reduced leaves and some assimilating tissue in their stems; and stomata occur in grooves on the stem.

The transpiring surface of xerophytes is frequently reduced. The ordinary leaves may be small, absent, or spinous. In "cushion plants" the leaves are very small, very close together, and the low habit is protective against winds. The latter, of course, greatly increase transpiration. A "cushion plant" (*Anabasis arctoides*) of the north-western Sahara, frequently shows dead leaves on the exposed side whilst the plant is in full vigour on the sheltered side. The buds and leaves on the exposed side are probably killed by sand blasts. Many xerophytes are hairy or have sunken stomata which may be further protected by partial plugs of wax: the stomata are frequently in grooves: the leaves are frequently rolled—sometimes permanently so, whilst sometimes the leaves roll up only during unfavourable weather. These adaptations tend to lessen the amount of transpiration by protecting the stomata from the movements of the air. In species of *Eucalyptus*, the leaves are placed edge-wise to the incident rays of light, and heat. The coriaceous leaves of "sclerophyllous plants" also, to some extent, are similarly protective. In such leaves, there are a well-marked cuticle, a thick epidermis, a thick hypodermis at least on the upper side of the leaf, well-developed palisade tissue, and a poorly developed system of air-spaces. Such adaptations are well seen in the leaf of the holly (*Ilex aquifolium*). Warming, however, states that "*Ilex aquifolium* is undoubtedly a mesophyte" (1909: 135).

Halophytes, or plants which live in saline soils, have xerophytic adaptations. A considerable proportion of halophytes are succulents, i.e. their leaves and, to some extent, their stems have much water-storing tissue and few intercellular spaces. Some halophytes tend to lose their succulence when cultivated in a non-saline soil; and some non-halophytes tend to become succulent when cultivated in a salty soil; there is, it need scarcely be stated, little or no evidence that such characters are transmitted. British salt marshes furnish few instances of spiny plants, though such occur occasionally on the inland salt marshes of continental districts. *Salsola Kali* is British, and a hemi-halophyte at least; and it is rather spiny. Warming states that "the stomata of true, succulent, littoral halophytic herbs, in cases so far investigated, are not sunken" (1909: 221). It is possible, however, that the absence of sunken stomata, and the occurrence of some other halophytic features, are related merely to the succulent habit and not to halophytism, for succulent species often occur on non-saline soils. Similarly, the small amount of cuticular and of epidermal protection, and of lignification in succulent halophytes may also be related to the same circumstance. Forms of "stone cells" or "steroids" occur in some of the more suffruticose halophytes, as in *Arthrocnemum glaucum*. The interesting occurrence of certain halophytes and hemi-halophytes on sea-shores and also on mountains is probably to be explained by the vast distribution of the species in question. At one time, such plants were probably of more general occurrence; now they have been extirpated in the intermediate localities, chiefly owing to the cultivation of the land in these places by man. In the west of Ireland and in the Faröes, where certain inland and lowland localities are still uncultivated, *Plantago maritima* and other halophytes occur in quantity and side by side with some "Alpine species," such as *Dryas octopetala*.

The effect of common salt on the metabolism of plants is not understood. Lesage² has shown that the height of certain plants is decreased by cultivation in a saline soil, and that the leaves of

plants under such conditions become smaller and more succulent. He showed further, that the increase of common salt in the soil is correlated with a reduction in the number and size of the chloroplasts, and therefore in the amount of chlorophyll. On the other hand, some plants did not respond to the action of common salt, whilst others were killed. Warming (1909: 220) quotes Griffes (1898), to the effect that "the assimilatory activity is less in the halophytic form than in the ordinary form of the same species." Schimper had previously maintained that the action of common salt in the cell-sap is detrimental as regards assimilation. Many marine Algae appear to be able to regulate their osmotic capacity to the surrounding medium; and T. G. Hill³ has shown that the root-hairs of *Salicornia* possess this property. There has, however, been performed upon halophytes very little physiologically experimental work which commands general acceptance.

Bog Xerophytes live in the peaty soil of fens and moors which are physically wet, but which are said to be physiologically dry. Related to the physiological drought, such plants possess some xerophytic characters; and, related to the physical wetness, the plants possess the aeration channels which characterize many hydrophytes and hemi-hydrophytes. The occurrence of xerophytic characters in plants of this type has given rise to much difference of opinion. It is sometimes maintained, for example, by Schimper, that these xerophytic characters are related to the physiological dryness of the habitat; this, however, is denied by others who maintain (Clements, 1905: 127) that the xerophytism is due to the persistence of ancestral structures. It is possible, of course, that each explanation is correct in particular cases, as the views are by no means mutually exclusive. With regard to the occurrence of plants, such as *Juncus effusus*, which possess xerophytic characters and yet live in situations which are not ordinarily of marked physiological dryness, it should be remembered that such habitats are liable to occasional physical drought; and a plant must eventually succumb if it is not adapted to the extreme conditions of its habitat. The xerophytic characters being present, it is not surprising that many marsh plants, like *Juncus effusus* and *Iris pseudacorus*, are able to survive in dry situations, such as banks and even granite rockeries.

Tropophytes.—These plants are characterized by being xerophytic during the unfavourable season. For example, deciduous trees shed their leaves in winter; geophytes go through a period of dormancy by means of bulbs, rhizomes, or other underground organs with buds; whilst annuals and ephemerals similarly protect themselves by means of the seed habit. All such plants agree in reducing transpiration to zero during the unfavourable season, although few or no xerophytic characters may be demonstrable during the period favourable to growth.

Hygrophytes.—Living, as these plants do, under medium conditions as regards soil, moisture and climate, they exhibit no characters which are markedly xerophytic or hydrophytic. Hence, such plants are frequently termed mesophytes. Assimilation goes on during the whole year, except during periods of frost or when the plants are buried by snow. An interesting special case of hygrophytes is seen with regard to plants which live in the shade of forests. Such plants have been termed sciophytes. Their stomata are frequently not limited to the underside of the leaves, but may occur scattered all over the epidermal surface. The epidermal cells may contain chlorophyll. Strengthening tissue is feebly developed. Many sciophytes are herbaceous tropophytes, and are dormant for more than half the year, usually during late summer, autumn and early winter. It may be that this is a hereditary character (cf. "bog xerophytes"), or that the physical drought of summer is unfavourable to shade-loving plants. In this connexion, it is interesting that in the east of England with the lowest summer rainfall of this country, many common sciophytes are absent or rare in the woods, such, for example, as *Melica nutans*, *Allium ursinum*, *Lychnis dioica*, *Oxalis acetosella*, and *Asperula odorata*. However, the cause of the absence or presence of a given species from a given locality is a department of ecology which has been studied with little or no thoroughness.

Calcicole and Calcifuge Species.—Plants which invariably inhabit calcareous soils are sometimes termed calcicoles; calcifuge species are those which are found rarely or never on such soils. The effect of lime on plants is less understood even than the effect of common salt. Doubtless, the excess of any soluble mineral salt or salts interferes with the osmotic absorption of the roots; and although calcium carbonate is insoluble in pure water, it is slightly soluble in water containing carbon dioxide. In England, the following species are confined or almost confined to calcareous soils: *Asplenium Ruta-muraria*, *Melica nutans*, *Carex digitata*, *Aceras anthriscifolium*, *Ophrys apifera*, *Thalictrum minus*, *Helianthemum Chamaecrista*, *Viola hirta*, *Linum perenne*, *Geranium lucidum*, *Hippocrepis comata*, *Potentilla verna*, *Viburnum Lantana*, *Galium asperum* (= *G. sylvestre*), *Asperula cynanchica*, *Senecio campestris*. The following plants, in England, are calcifuge: *Lastraea Oreopteris*, *Holcus mollis*, *Carex echinata*, *Spergula arvensis*, *Polygala serpyllacea*, *Cytisus*

¹ Volkens, *Die Flora der ägyptisch-arabischen Wüste* (Berlin, 1887).

² Lesage, "Recherches expérimentales sur les modifications des feuilles chez les plantes maritimes," in *Rev. gén. de bot.* (1890), vol. ii.

³ T. G. Hill, "Observations on the Osmotic Properties of the Root-Hairs of certain Salt Marsh Plants," in *The New Phytologist* (1908), vol. vii.

separius, *Potentilla procumbens*, *Galium hercynicum* (= *G. saxatile*), *Gnaphalium sylvaticum*, *Digitalis purpurea*. Other plants occur indifferently both on calcareous and on non-calcareous soils.

It is sometimes said that lime acts as a poison on some plants and not on others, and sometimes that it is the physiological dryness of calcareous soils that is the important factor. In relation to the latter theory, it is pointed out that some markedly calcicole species occur on sand dunes; but this may be due to the lime which is frequently present in dune sand as well as to the physical dryness of the soil. Further, no theory of calcicolous and calcifugous plants can be regarded as satisfactory which fails to account for the fact that both kinds of plants occur among aquatic as well as among terrestrial plants. Schimper (1903: 102) thinks that in the case of aquatic plants, the difference must depend on the amount of lime in the water, for the physical nature of the substratum is the same in each case. Again, acidic humus does not form in calcareous soils; and hence one does not expect to find plants characteristic of acidic peat or humus on calcareous soils. Some such species are *Blechnum boreale*, *Aira flexuosa*, *Calluna vulgaris*, *Vaccinium*, *Myrtillus*, *Rubus*, *Chamaemorus*, *Empetrum nigrum*, *Drosera* spp. Some, at least, of these species possess mycorrhiza in their roots, and are perhaps unable to live in soils where such organisms are absent.

In England, the number of calcicole species is greater than the number of silicolous species. It would therefore be curious if it were proved that lime acts on plants as a poison. It is said that some plants may be calcicoles in one geographical district and not in another. However, until more is known of the exact chemical composition of natural—as contrasted with agricultural—soils, and until more is known of the physiological effects of lime, it is impossible to decide the vexed question of the relation of lime-loving and lime-shunning plants to the presence or absence of calcium carbonate in the soil. From such points of view as this, it is indeed true, as Warming has recently stated, "that ecology is only in its infancy." (C. E. M.)

CYTOLOGY OF PLANTS

The elementary unit of plant structure, as of animal structure, is the cell. Within it or its modifications all the vital phenomena of which living organisms are capable have their origin. Upon our knowledge of its minute structure or cytology, combined with a study of its physiological activities, depends the ultimate solution of all the important problems of nutrition and growth, reception and conduction of stimuli, heredity, variation, sex and reproduction.

The Cell Theory.—For a general and historical account of the cell theory see CYTOLOGY. It is sufficient to note here that cells were first of all discovered in various vegetable tissues by Robert Hooke in 1665 (Micrographia); Malpighi and Grew (1674-1682) gave the first clear indications of the importance of cells in the building up of plant tissues, but it was not until the beginning of the 19th century that any insight into the real nature of the cell and its functions was obtained. Hugo von Mohl (1846) was the first to recognize that the essential vital constituent of the plant cell is the slimy mass—protoplasm—inside it, and not the cell wall as was formerly supposed. The nucleus was definitely recognized in the plant cell by Robert Brown in 1831, but its presence had been previously indicated by various observers and it had been seen by Fontana in some animal cells as early as 1781. The cell theory so far as it relates to plants was established by Schleiden in 1838. He showed that all the organs of plants are built up of cells, that the plant embryo originates from a single cell, and that the physiological activities of the plant are dependent upon the individual activities of these vital units. This conception of the plant as an aggregate or colony of independent vital units governing the nutrition, growth and reproduction of the whole cannot, however, be maintained. It is true that in the unicellular plants all the vital activities are performed by a single cell, but in the multicellular plants there is a more or less highly developed differentiation of physiological activity giving rise to different tissues or groups of cells, each with a special function. The cell in such a division of labour cannot therefore be regarded as an independent unit. It is an integral part of an individual organization and as such the exercise of its functions must be governed by the organism as a whole.

General Structure and Differentiation of the Vegetable Cell.—The simplest cell forms are found in embryonic tissues, in reproductive cells and in the parenchymatous cells, found in various parts of the plant. The epidermal, conducting and strengthening tissues show on the other hand considerable modifications both in form and structure.

The protoplasm of a living cell consists of a semifluid granular substance, called the cytoplasm, one or more nuclei, and sometimes centrosomes and plastids. Cells from different parts of a plant differ very much in their cell-contents. Young cells are

full of cytoplasm, old cells generally contain a large vacuole or vacuoles, containing cell-sap, and with only a thin, almost invisible layer of cytoplasm on their walls. Chlorophyll grains, chromatophores, starch-grains and oil-globules, all of which can be distinguished either by their appearance or by chemical reagents, may also be present. Very little is known of the finer structure of the cytoplasm of a vegetable cell. It is sometimes differentiated into a clearer outer layer, of hyaloplasm, commonly called the ectoplasm, and an inner granular endoplasm. In some cases it shows, when submitted to a careful examination under the highest powers of the microscope, and especially when treated with reagents of various kinds, traces of a more or less definite structure in the form of a meshwork consisting of a clear homogeneous substance containing numerous minute bodies known as *microsomes*, the spaces being filled by a more fluid *ground-substance*. This structure, which is visible both in living cells and in cells treated by reagents, has been interpreted by many observers as a network of threads embedded in a homogeneous ground-substance. Bütschli, on the other hand, interprets it as a finely vacuolated foam-structure or emulsion, comparable to that which is observed when small drops of a mixture of finely powdered potash and oil are placed in water, the vacuoles or alveoli being spaces filled with liquid, the more solid portion representing the mesh-work in which the microsomes are placed. Evidence is not wanting, however, that the cytoplasm must be regarded as, fundamentally, a semifluid, homogeneous substance in which by its own activity, granules, vacuoles, fibrils, &c., can be formed as secondary structures. The cytoplasm is largely concerned in the formation of spindle fibres and centrosomes, and such structures as the cell membrane, cilia, or flagella, the coenocentrum, *nematoplasts* or *vibrionids* and *physodes* are also products of its activity.

Protoplasmic Movements.—In the cells of many plants the cytoplasm frequently exhibits movements of *circulation* or *rotation*. The cells of the staminal hairs of *Tradescantia virginica* contain a large sap-cavity across which run, in all directions, numerous protoplasmic threads or bridges. In these, under favourable conditions, streaming movements of the cytoplasm in various directions can be observed. In other forms such as *Elodea*, *Nitella*, *Chara*, &c., where the cytoplasm is mainly restricted to the periphery of the sap vacuole and lining the cell wall, the streaming movement is exhibited in one direction only. In some cases both the nucleus and the chromatophores may be carried along in the rotating stream, but in others, such as *Nitella*, the chloroplasts may remain motionless in a non-motile layer of the cytoplasm in direct contact with the cell wall.¹

Desmids, Diatoms and *Oscillaria* show creeping movements probably due to the secretion of slime by the cells; the swarm-spores and plasmodium of the Myxomycetes exhibit amoeboid movements; and the motile spores of Fungi and Algae, the spermatozooids of mosses, ferns, &c., move by means of delicate prolongations, cilia or flagella of the protoplast.

Chromatophores.—The chromatophores or plastids are protoplasmic structures, denser than the cytoplasm, and easily distinguishable from it by their colour or greater refractive power. They are spherical, oval, fusiform, or rod-like, and are always found in the cytoplasm, never in the cell-sap. They appear to be permanent organs of the cell, and are transmitted from one cell to another by division. In young cells the chromatophores are small, colourless, highly refractive bodies, principally located around the nucleus. As the cell grows they may become converted into *leucoplasts* (starch-formers), *chloroplasts* (chlorophyll-bodies), or *chromoplasts* (colour-bodies). And all three structures may be converted one into the other (Schimper). The chloroplasts are generally distinguished by their green colour, which is due to the presence of chlorophyll; but in many Algae this is masked by another colouring matter—*Phycocerythrin* in the Florideae, *Phycophaein* in the Phaephyceae, and *Phycocyanin*

¹ Ewart, *On the Physics and Physiology of Protoplasmic Streaming in Plants*. (Oxford, 1903), gives an excellent account of the phenomena of protoplasmic streaming with a full discussion of the probable causes to which it is due.

in the Cyanophyceae. These substances can, however, be dissolved out in water, and the green colouring matter of the chloroplast then becomes visible. The chloroplast consists of two parts, a colourless ground substance, and a green colouring matter, which is contained either in the form of fibrils, or in more or less regular spherical masses, in the colourless ground-mass. The chloroplasts increase in number by division, which takes place in higher plants when they have attained a certain size, independent of the division of the cell. In *Spirogyra* and allied forms the chloroplast grows as the cell grows, and only divides when this divides. The division in all cases takes place by constriction, or by a simultaneous splitting along an equatorial plane. Chloroplasts are very sensitive to light and are capable in some plants of changing their position in the cell under the stimulus of a variation in the intensity of the light rays which fall upon them. In the chromatophores of many Algae and in the Liverwort *Anthoceros* there are present homogeneous, highly refractive, crystal-like bodies, called *pyrenoids* or starch-centres, which are composed of proteid substances and surrounded by an envelope of starch-grains. In *Spirogyra* the pyrenoids are distinctly connected by cytoplasmic strands to the central mass of cytoplasm, which surrounds the nucleus, and according to some observers, they increase exclusively by division, followed by a splitting of the cytoplasmic strands. Those chromatophores which remain colourless, and serve simply as starch-formers in parts of the plant not exposed to the light, are called leucoplasts or amyloplasts. They are composed of a homogeneous proteid substance, and often contain albuminoid or proteid crystals of the same kind as those which form the pyrenoid. If exposed to light they may become converted into chloroplasts. The formation of starch may take place in any part of the leucoplast. When formed inside it, the starch-grains exhibit a concentric stratification; when formed externally in the outer layers, the stratification is excentric, and the hilum occurs on that side farthest removed from the leucoplast. As the starch-grains grow, the leucoplasts gradually disappear.

Chromoplasts are the yellow, orange or red colour-bodies found in some flowers and fruits. They arise either from the leucoplasts or chloroplasts. The fundamental substance or stroma is colourless and homogeneous. The colour is due to the presence of xanthophyll, or carotin or both. The colouring matters are not dissolved in the stroma of the chromoplast, but exist as amorphous granules, with or without the presence of a protein crystal, or in the form of fine crystalline needles, frequently curved and sometimes present in large numbers, which are grouped together in various ways in bundles and give the plastids their fusiform or triangular crystalline shape. Such crystalline plastids occur in many fruits and flowers (e.g. *Tamus communis*, *Asparagus*, *Lonicera*, berries of Solanaceae, flowers of *Cactalia coccinea*, *Tropaeolum*, bracts of *Streptizia*, &c.), and in the root of the carrot. In some cases the plastid disappears and the crystalline pigment only is left. In the red variety of *Cucurbita pepo* these crystals may consist of rods, thin plates, flat ribbons or spirals. Starch grains may often be seen in contact with the pigment crystals. The crystalline form appears to be due entirely to the carotin, which can be artificially crystallized from an alcohol or ether solution. In addition to the plastids, there are found in some plant-cells, e.g. in the epidermal cells of the leaf of species of *Vanilla* (Wakker), and in the epidermis of different parts of the flower of *Funkia*, *Ornithogalum*, &c. (Zimmermann), highly refractive bodies of globular form, *elaioplasts*, which consist of a granular protein ground-substance containing drops of oil. They are stained deep red in dilute solution of alkalin.

Substances contained in the Protoplasm.—Starch may be found in the chlorophyll bodies in the form of minute granules as the first visible product of the assimilation of carbon dioxide, and it occurs in large quantities as a reserve food material in the cells of various parts of plants. It is highly probable that starch is only produced as the result of the activity of chromatophores, either in connexion with chromoplasts, chloroplasts or leucoplasts. Starch exists, in the majority of cases, in the form of grains, which are composed of stratified layers arranged around a nucleus or hilum. The stratification, which may be concentric or excentric, appears to be due to a difference in density of the various layers. The outer layers are denser than the inner, the density decreasing more or less uniformly from the outside layers to the centre of hilum. The outermost, newly formed layer is composed of a more homogeneous, denser substance than the

inner one, and can be distinguished in all starch-grains that are in process of development. The separate layers of the starch-grain are deposited on it by the activity of the chromatophore, and according to Meyer the grain is always surrounded by a thin layer of the chromatophore which completely separates it from the cytoplasm. The layers appear to be made up of elements which are arranged radially. These are, according to Meyer, acicular crystals, which he calls *trichites*. The starch grain may thus be regarded as a crystalline structure of the nature of a spherulite-crystal, as has been suggested by many observers.

Whether the formation of the starch grain is due to a secretion from the plastid (Meyer, 1895) or to a direct transformation of the proteid of the plastid (Timberlake, 1901) has not been definitely established.

Aleurone.—Aleurone is a proteid substance which occurs in seeds especially those containing oil, in the form of minute granules or large grains. It may be in the form of an albumen crystal sometimes associated with a more or less spherical body—globoid—composed of a combination of an organic substance with a double phosphate of magnesium and calcium. Albumen crystals are also to be found in the cytoplasm, in leucoplasts and rarely in the nucleus.

Glycogen, a substance related to starch and sugar, is found in the Fungi and Cyanophyceae as a food reserve. It gives a characteristic red-brown reaction with iodine solution. In the yeast cell it accumulates and disappears very rapidly according to the conditions of nutrition and is sometimes so abundant as to fill the cell almost entirely (Ererra, 1882, 1895; Wager and Peniston, 1910).

Volutin occurs in the cytoplasm of various Fungi, Bacteria, Cyanophyceae, diatoms, &c., in the form of minute granules which have a characteristic reaction towards methylene blue (Meyer). It appears to have some of the characteristics of nucleic acid, and according to Meyer may be a combination of nucleic acid with an unknown organic base.

Numerous other substances are also found in the cytoplasm, such as tannin, fats and oil, resins, mucilage, caoutchouc, gutta-percha, sulphur and calcium oxalate crystals. The cell sap contains various substances in solution such as sugars, inulin, alkaloids, glucosides, organic acids and various inorganic salts. The colour of flowers are due to colouring matters contained in the sap of which the chief is anthocyanin.

Reference must also be made here to the enzymes or unorganized ferments which occur so largely in the cytoplasm. It is probable that most, if not all, the metabolic changes which take place in a cell, such as the transformation of starch, proteid, sugar, cellulose, and the decomposition of numerous other organic substances which would otherwise require a high temperature or powerful reagents is also due to their activity. Their mode of action is similar to that of ordinary mechanical catalytic agents, such as finely divided platinum (see Bayliss, *The Nature of Enzyme Action*, and J. R. Green, *The Soluble Ferments*).

The Nucleus.—The nucleus has been demonstrated in all plants with the exception of the Cyanophyceae and Bacteria, and even here structures have been observed which resemble nuclei in some of their characteristics. The nucleus is regarded as a controlling centre of cell-activity, upon which the growth and development of the cell in large measure depends, and as the agent by which the transmission of specific qualities from one generation to another is brought about. If it is absent, the cell loses its power of assimilation and growth, and soon dies. Haberlandt has shown that in plant cells, when any new formation of membrane is to take place in a given spot, the nucleus is found in its immediate vicinity; and Klebs found that only that portion of the protoplasm of a cell which contains the nucleus is capable of forming a cell-wall; whilst Townsend has further shown that if the non-nucleated mass is connected by strands of protoplasm to the nucleated mass, either of the same cell or of a neighbouring cell, it retains the power of forming a cell-membrane.

The Structure of the Nucleus.—In the living condition the resting nucleus appears to consist of a homogeneous ground substance containing a large number of small chromatin granules and one or more large spherical granules—nucleoli—the whole being surrounded by a limiting membrane which separates it from the cytoplasm. When fixed and stained this granular mass is resolved into a more or less distinct granular network which consists of a substance called *Linin*, only slightly stained by the ordinary nuclear stains, and, embedded in it, a more deeply stainable substance called *Chromatin*. The nucleolus appears to form a part of the *Linin* network, but has usually also a strong affinity for nuclear stains. The staining reactions of the various

parts of the nucleus depend to some extent upon their chemical constitution. The chromatin is practically identical with nuclein. This has a strong attraction for basic aniline dyes, and can usually be distinguished from other parts of the cell which are more easily coloured by acid anilines. But the staining reactions of nuclei may vary at different stages of their development; and it is probable that there is no method of staining which differentiates with certainty the various morphological constituents of the nucleus.

Our knowledge of the chemical constitutions of the nucleus is due to the pioneer researches of Sir Lauder Brunton, Ploz, Miescher, Kossel and a host of more recent investigators. Nuclein is a complex albuminoid substance containing phosphorus and iron in organic combination (Macallum). It appears to be a combination of a protein with nucleic acid. Recent researches have shown that the nucleic acid can be broken up by chemical means into a number of different compounds or bases. The results at first obtained were very confusing and seemed to show that nucleic acid is very variable in constitution, but thanks to the work of Schmieberg and Stendel (Germany), Ivar Bang (Sweden) and Walter Jones and Levene (America), the confusion has been reduced to some sort of order, and it now seems probable that all ordinary nucleic acids yield two purine bases, adenine and guanine, two pyrimidine bases, cytosine and thymine and a hexose carbohydrate, the identity of which is uncertain.

The Nucleolus—In the majority of plant-nuclei, both in the higher and lower plants, there is found, in addition to the chromatin network, a deeply stained spherical or slightly irregular body (sometimes more than one) called the nucleolus (fig. 2, A to D). It is often vacuolar, sometimes granular, and in other cases it is a homogeneous body with no visible structure or differentiation. The special function of this organ has been a source of controversy during the past few years, and much uncertainty still exists as to its true nature. It forms a part of the linin or plastin network of the nucleus and may become impregnated with varying quantities of chromatin stored up for use in the formation of the chromosomes and other nuclear activities. The relation of the nucleolus to the chromosomes is clearly seen in the reconstruction of the daughter nuclei after division in the cells of the root-apex of *Phaseolus* (fig. 1, A to F). The chromosomes (fig. 1, A) unite to form an irregular mass (fig. 1, B) out of which is evolved the nucleolus and nuclear network (figs. 1, B, F) by a fusion of the chromosomes (fig. 1, C, D).

Centrosome.—The centrosome is a minute homogeneous granule found in the cytoplasm of some cells in the neighbourhood of the nucleus. It is generally surrounded by a granular or radiating cytoplasmic substance. In plant cells its presence has been demonstrated in the Thallophtyes and Bryophytes. In the higher plants the structures which have been often described as centrosomes are too indefinite in their constitution to allow of this interpretation being placed upon them, and many of them are probably nothing more than granules of the fragmented nucleolus. The centrosomes in plants do not appear to be permanent organs of the cell. They are prominent during cell-division, but many disappear in the resting stage. They are more easily seen, when the nucleus is about to undergo mitosis, at the ends of the spindle, where they form the centres towards which the radiating fibres in the cytoplasm converge (see fig. 7, E G). The centrosome or centrosphere is usually regarded as the dynamic centre of the cell and a special organ of division; but its absence in many groups of plants does not lend support to this view so far as plant-cells are concerned.

Nuclear Division.—The formation of new cells is, in the case of uninucleate cells, preceded by or accompanied by the division of the nucleus. In multinucleate cells the division of the nucleus is independent of the division of the cell. Nuclear division may be indirect or direct, that is to say it may either be accompanied by a series of complicated changes in the nuclear structures called *mitosis* or *karyokinesis* (fig. 2), or it may take place by simple direct division, *amitosis*, or fragmentation. Direct division is a much less common phenomenon than was formerly supposed to be the case. It occurs most frequently in old cells, or in cells which are placed under abnormal conditions.

¹ See Halliburton. *Science Progress in the 20th Century* (1909), vol. iv.

It may also take place where rapid proliferation of the cell is going on, as in the budding of the Yeast plant. It takes place in the internodal cells of Characeae; in the old internodal cells of

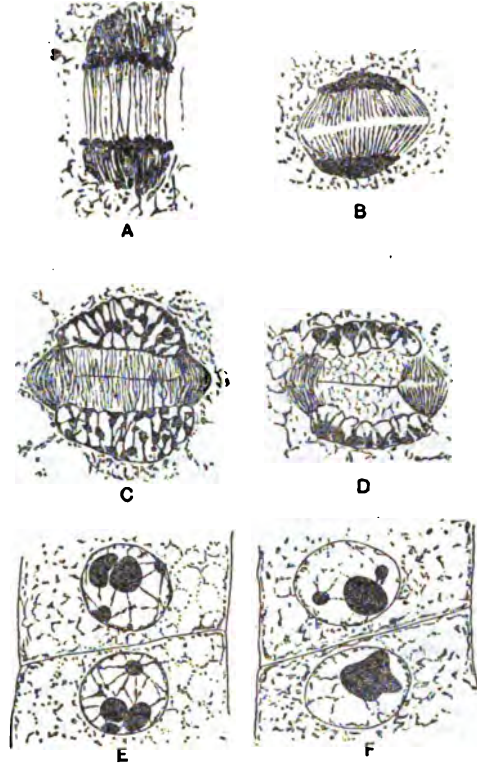

FIG. 1.—Reconstruction of the daughter nuclei of *Phaseolus*.

Tradescantia; and in various other cells which have lost their power of division. It has been shown that, in cells of *Spirogyra* placed under special conditions, amitotic division can be induced, and that normal mitosis is resumed when they are placed again under normal conditions. Amitosis is probably connected by a series of intermediate gradations with karyokinesis.

Mitosis.—In indirect nuclear division the nucleus undergoes a series of complicated changes, which result in an equal division of the chromatic substance between the two daughter nuclei. Four stages can be recognized. (1) *Prophase*.—The nucleus increases in size; the network disappears, and a much convoluted thread takes its place (fig. 2, B). The chromatin substance increases in amount; the thread stains more deeply, and in most cases presents a homogeneous appearance. This is commonly called the spirem-figure. The chromatin thread next becomes shorter and thicker, the nucleoli begin to disappear, and the thread breaks up into a number of segments—*chromosomes*—which vary in number in different species, but are fairly constant in the same species (fig. 2, C, D). Coincident with these changes the nuclear membrane disappears and a spindle-shaped or barrel-shaped group of threads makes its appearance in the midst of the chromosomes, the longitudinal axis of which is at right angles to the plane of the division (fig. 2, F). At each pole of this spindle figure there often occur fibres radiating in all directions into the cytoplasm, and sometimes a minute granular body, the *centrosome*, is also found there. (2) *Metaphase*.—The chromosomes pass to the equator of the spindle and become attached to the

spindle-fibres in such a way that they form a radiating star-shaped figure—*Aster*—when seen from the pole of the spindle. This is called the nuclear plate (fig. 2, E, F, G, H). As they pass into this position they undergo a longitudinal splitting by which the chromatin in each chromosome becomes divided into equal halves. (3) *Anaphase*.—The longitudinal division of the chromosomes is completed by the time they have taken up their position in the nuclear plate, and the halves of the chromosomes then begin to move along the spindle-fibres to opposite poles of the spindle (fig. 2, I, J). Many observers hold the view that the chromosomes are pulled apart by the contraction of the fibres to which they are attached. (4) *Telophase*.—When they reach the poles the chromosomes group themselves again in the form of stars—*Diaster*—with spindle-fibres extending between them (fig. 2, K). The chromosomes then fuse together again to form a single thread (fig. 2, L), a nucleolus appears, a nuclear membrane is formed, and daughter nuclei are thus constituted which possess the same structure and staining reactions as the mother nucleus.

The spindle figure is probably the expression of forces which are set up in the cell for the purpose of causing the separation of the daughter chromosomes. Hartog has endeavoured to show that it can only be formed by a dual force, analogous to that of magnetism, the spindle-fibres being comparable to the lines of force in a magnetic field and possibly due to electrical differences in the cell. The spindle arises partly from the cytoplasm, partly from the nucleus, or it may be derived entirely from the nucleus—intranuclear spindle—as occurs in many of the lower plants (Fungi, &c.). The formation of the spindle begins in the prophase of division. A layer of delicate filamentous cytoplasm—*kinoplasm*—may collect around the nucleus, or at its poles, out of which the spindle is formed. As division proceeds, the filamentous nature of this cytoplasm becomes more prominent and the threads begin either to converge towards the poles of the nucleus, to form a bipolar spindle, or may converge towards, or radiate from, several different points, to form a multipolar spindle. The wall of the nucleus breaks down, and the cytoplasmic spindle-fibres become mixed with those derived from the nuclear network. The formation of the spindle differs in details in different plants.

The significance of this complex series of changes is very largely hypothetical. It is clear, however, that an equal quantitative division and distribution of the chromatin to the daughter cells is brought about; and if, as has been suggested, the chromatin consists of minute particles or units which are the carriers of the hereditary characteristics, the nuclear division also probably results in the equal division and distribution of one half of each of these units to each daughter cell.

Reduction Divisions (Meiosis).—The divisions which take place leading to the formation of the sexual cells show a reduction in the number of chromosomes to one-half. This is a necessary consequence of the fusion of two nuclei in fertilization, unless the chromosomes are to be doubled at each generation. In the vascular cryptogams and phanerogams it takes place in the spore mother cells and the reduced number is found in all the cells of the gametophyte, the full number in those of the sporophyte. We know very little of the details of reduction in the lower plants, but it probably occurs at some stage in the life history of all plants in which sexual nuclear fusion takes place. The reduction is brought about simply by the segmentation of the spirem thread into half the number of segments instead of the normal number. In order to effect this the individual chromosomes must become associated in some way, for there is no diminution in the actual amount of nuclear substance, and this leads to certain modifications in the division which are not seen in the vegetative nuclei. The two divisions of the spore mother cell in which the reduction takes place, follow each other very rapidly and are known as *Heterotype* and *Homotype* (Flemming), or according to the terminology of Farmer and Moore (1905) as the *meiotic phase*. In the heterotype division the spirem thread is divided longitudinally before the segmentation occurs (fig. 2, B), and this is preceded by a peculiar contraction of the thread around the nucleolus which has been termed *synapsis* (fig. 1, A). A second contraction may take place later, immediately preceding the segmentation of the thread. It has been suggested that synapsis may be connected with the early longitudinal splitting of the thread, or with the pairing of the chromosomes, but it is possible

that it may be connected with the transference of nuclear substance to the nuclear thread. The segments of each chromosome are usually twisted upon each other and may be much contorted (fig. 2, C, D), and appearances are observed which suggest a second longitudinal division, but which are more

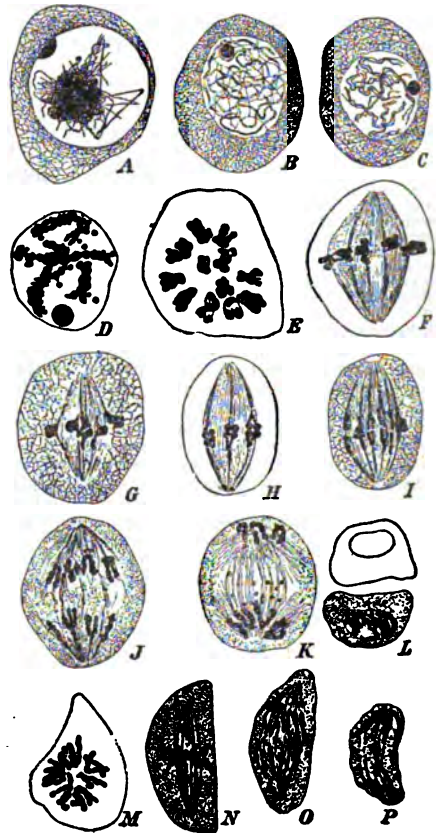

(After Geisole.)

FIG. 2.—Various Stages in the Nuclear Division of the Poles Mother-cells of *Lilium*.

probably due to a folding of the segment by which the two halves come to lie more or less parallel to each other, and form variously shaped figures of greater or less regularity (fig. 2, E). The chromosomes now become attached to the spindle-fibres (fig. 2, F, G) and as the daughter chromosomes become pulled asunder they often appear more or less V-shaped so that each pair appears as a closed ring of irregular shape, the ends of the V's being in contact thus—<> (fig. 2, H, I, J, K). This V has been variously interpreted. Some observers consider that it represents a longitudinal half of the original segment of the spirem, others that it is a half of the segment produced by transverse division by means of which a true qualitative separation of the chromatin is brought about. The problem is a very difficult one and cannot be regarded as definitely settled, but it is difficult to understand why all this additional complexity in the division of the nucleus should be necessary if the final result is only a quantitative separation of the chromatin. It seems to be fairly well established that in the meiotic phase there is a true qualitative division brought about by the pairing of the chromosomes during synapsis, and the subsequent separation of whole

chromosomes to the daughter nuclei. The method by which this is brought about is, however, the subject of much controversy. There are two main theories: (1) that the chromosomes which finally separate are at first paired side by side (Allen, Grégoire, Berghs, Strasburger and others), and (2) that they are joined together or paired end to end (Farmer and Moore, Gregory, Mottier and others). Good cytological evidence has been adduced in favour of both theories, but further investigation is necessary before any definite conclusion can be arrived at. The second or homotype division which immediately follows reverts to the normal type except that the already split chromosomes at once separate to form the daughter nuclei without the intervention of a resting stage.

Cell Division.—With the exception of a few plants among the Thallophytes, which consist of a single multinucleate cell, *Caulerpa*, *Vascheria*, &c., the division of the nucleus is followed by the division of the cell either at once, in uninucleate cells, or after a certain number of nuclear divisions, in multinucleate cells. This may take place in various ways. In the higher plants, after the separation of the daughter nuclei, minute granular swellings appear, in the equatorial region, on the connecting fibres which still persist between the two nuclei, to form what is called the cell-plate. These fuse together to form a membrane (fig. 1, C, D) which splits into two layers between which the new cell-wall is laid down. In the Thallophytes the cytoplasm may be segmented by constriction, due to the in-growth of a new cell wall from the old one, as in *Spirogyra* and *Cladophora*, or by the formation of cleavage furrows in which the new cell-wall is secreted, as occurs in the formation of the spores in many Algae and Fungi. Cell budding takes place in yeast and in the formation of the conidia of Fungi.

In a few cases both among the higher and the lower plants, of which the formation of spores in the ascus is a typical example, new cells are formed by the aggregation of portions of the cytoplasm around the nuclei which become delimited from the rest of the cell contents by a membrane. This is known as free cell formation.

In *Fucus* and allied forms the spindle-fibres between the daughter nuclei disappear early and the new cell-wall is formed in the cytoplasm.

Cell Membrane.—The membrane which surrounds the protoplasts in the majority of plants is typically composed of cellulose, together with a number of other substances which are known as pectic compounds. Some of these have a neutral reaction, others react as feeble acids. They can be distinguished by their insolubility in cuprammonia, which dissolves cellulose, and by their behaviour towards stains, some of which stain pectic substances but not cellulose. Cellulose has an affinity for acid stains, pectic substances for basic stains. The cell-membrane may become modified by the process of lignification, suberization, cuticularization or gelatinization. In the Fungi it is usually composed of a modified form of cellulose known as fungus cellulose, which, according to Mangin, consists of callose in combination either with cellulose or pectic compounds. The growth of the cell-wall takes place by the addition of new layers to those already formed. These layers are secreted by the protoplasm by the direct apposition of substances on those already in existence; and they may go on increasing in thickness, both by apposition and by the intussusception of particles probably carried in through the protoplasmic fibres, which penetrate the cell-wall as long as the cell lives. The growth of the cell-wall is very rarely uniform. It is thickened more in some places than in others, and thus are formed the spiral, annular and other markings, as well as the pits which occur on various cells and vessels. Besides the internal or centripetal growth, some cell-walls are thickened on the outside, such as pollen grains, oospores of Fungi, cells of Peridinae, &c. This centrifugal growth must apparently take place by the activity of protoplasm external to the cell. The outer protective walls of the oospores of some Fungi are formed out of protoplasm containing numerous nuclei, which is at an early stage separated from the protoplasm of the oospore. In the Peridinae,

Diatoms and Desmids, according to recent researches, the thickenings on the outer walls of the cells are due to the passage of protoplasm from the interior of the cell to the outside, through pores which are found perforating the wall on all sides.

Cell-walls may become modified by the impregnation of various substances. Woody or lignified cell-walls appear to contain substances called *coniferin* and *vanillin*, in addition to various other compounds which are imperfectly known. Lignified tissues are coloured yellow by aniline sulphate or aniline chloride, violet with phloroglucin and hydrochloric acid, and characteristic reactions are also given by mixtures containing phenol, indol, skatol, thallin, sulphate, &c. (see Zimmermann's *Microtechnique*). Staining reagents can also be used to differentiate lignified cell-walls. Cuticularized or suberized cell-walls occur especially in those cells which perform a protective function. They are impervious to water and gases. Both cuticularized and suberized membranes are insoluble in cuprammonia, and are coloured yellow or brown in a solution of chlor-iodide of zinc. It is probable that the corky or suberized cells do not contain any cellulose (Gilson, Wisselingh); whilst cuticularized cells are only modified in their outer layers, cellulose inner layers being still recognizable. The suberized and cuticularized cell-walls appear to contain a fatty body called suberin, and such cell-walls can be stained red by a solution of alcamin, the lignified and cellulose membranes remaining unstained.

Fertilisation.—The formation of the zygote or egg-cell takes place usually by the fusion of the contents of two cells,

and always includes, as an essential feature, the fusion of two germ nuclei. In many of the lower plants the fusing cells—*gametes*—are precisely similar so far as size and general appearance are concerned; and the whole contents of the two cells fuse together, cytoplasm with cytoplasm, nucleus with nucleus, nucleolus with nucleolus and plastid with plastid. The gametes may be motile (some Algae) or non-motile, as in *Spirogyra*, *Mucor*, *Basidiobolus*, &c. In many of the lower plants and in all higher plants there is a difference in size in the fusing cells, the male cell being the smaller. The reduction in size is due to the absence of cytoplasm, which is in some cases so small in amount that the cell consists mainly of a nucleus. In all cases of complete sexual differentiation the egg-cell is quiescent; the male cell may be motile or non-motile. In many of the Fungi the non-motile male cell or nucleus is carried by means of a fertilizing tube actually into the interior of the egg-cell, and is extruded through the apex in close proximity to the egg nucleus. In the Floridaceae, Lichens and Laboulbeniaceae the male cell is a non-motile spermatium, which is carried to the female organ by movements in the water. In *Monoblepharis*, one of the lower Fungi, in some Algae, in the Vascular Cryptogams, in Cycads (*Zamia* and *Cycas*), and in *Ginkgo*, an isolated genus of Gymnosperms, the male cell is a motile spermatozoid with two or more cilia. In the Algae, such as *Fucus*, *Volvox*, *Oedogonium*, *Bulbochaete*, and in the Fungus *Monoblepharis*, the spermatozoid is a small oval or elongate cell containing nucleus, cytoplasm and sometimes plastids. In the Characeae, the Vascular Cryptogams, in *Zamia* and *Cycas*, and in *Ginkgo*, the spermatozoids are more or less highly modified cells with two or more cilia, and resemble in many respects, both in their

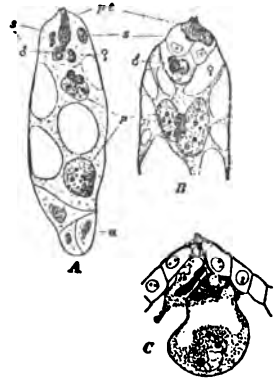

(From Willson. After Guignard and Mottier.)

FIG. 3.—Fertilization in the Lily.

a, Antipodal cell; sp, polar nuclei; pt, pollen tube.

A, Two vermiform nuclei in the embryo sac; one approaching the egg nucleus, the other uniting with the upper polar nucleus.

B, Union of the vermiform nuclei with the egg-nucleus and the two polar nuclei.

C, Fusion of the germ nuclei in the egg-cell.

the male cell may be motile or non-motile. In many of the Fungi the non-motile male cell or nucleus is carried by means of a fertilizing tube actually into the interior of the egg-cell, and is extruded through the apex in close proximity to the egg nucleus. In the Floridaceae, Lichens and Laboulbeniaceae the male cell is a non-motile spermatium, which is carried to the female organ by movements in the water. In *Monoblepharis*, one of the lower Fungi, in some Algae, in the Vascular Cryptogams, in Cycads (*Zamia* and *Cycas*), and in *Ginkgo*, an isolated genus of Gymnosperms, the male cell is a motile spermatozoid with two or more cilia. In the Algae, such as *Fucus*, *Volvox*, *Oedogonium*, *Bulbochaete*, and in the Fungus *Monoblepharis*, the spermatozoid is a small oval or elongate cell containing nucleus, cytoplasm and sometimes plastids. In the Characeae, the Vascular Cryptogams, in *Zamia* and *Cycas*, and in *Ginkgo*, the spermatozoids are more or less highly modified cells with two or more cilia, and resemble in many respects, both in their

structure and mode of formation, the spermatozooids of animals. In Characeae and Muscineae they are of elongate spiral form, and consist of an elongate dense nucleus and a small quantity of

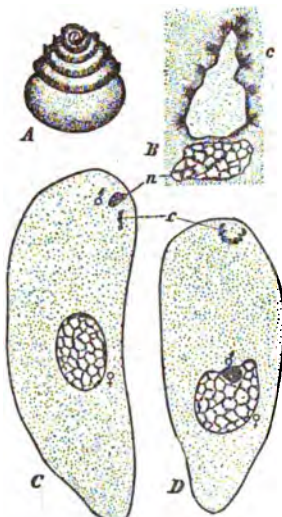

(After Webber.)

FIG. 4.—Spermatozoid and Fertilization in *Zamia*.

by means of a pollen tube. In the spermatozooids of *Chara*, Vascular Cryptogams, and in those of *Cycas*, *Zamia* and *Ginkgo*, the cilia arise from a centrosome-like body which is found on one side of the nucleus of the spermatozoid mother-cell. This body has been called a *blepharoplast*, and in the Pteridophytes, Cycads and *Ginkgo* it gives rise to the spiral band on which the cilia are formed. Belajeff regards it as a true centrosome; but this is doubtful, for while in some cases it appears to be connected with the division of the cell, in others it is independent of it. The egg-cell or oosphere is a large cell containing a single large nucleus, and in the green plants the rudiments of plastids. In plants with multinucleate cells, such as *Albugo*, *Peronospora* and *Vaucheria*, it is usually a uninucleate cell differentiated by separation of the nuclei from a multinucleate cell, but in *Albugo blüti* it is multinucleate, and in *Sphaeroplea* it may contain more than one nucleus. In some cases the region where the penetration of the male organ takes place is indicated on the oosphere by a hyaline receptive spot (*Oedogonium*, *Vaucheria*, &c.), or by a receptive papilla consisting of hyaline cytoplasm (*Peronospora*). Fertilization is effected by the union of two nuclei in all those cases which have been carefully investigated. Even in the multinucleate oosphere of *Albugo blüti* the nuclei fuse in pairs; and in the oospheres of *Sphaeroplea*, which may contain more than one nucleus, the egg nucleus is formed by the fusion of one only of these with the spermatozoid nucleus (Klebahn). In the higher Fungi nuclear fusions take place in basidia or asci which involve the union of two (fig. 7, A) nuclei, which may be regarded as physiologically equivalent to a sexual fusion. The union of the germ nuclei has now been observed in all the main groups of Angiosperms, Gymnosperms, Ferns, Mosses, Algae and Fungi, and presents a striking resemblance in all. In nearly all cases the nuclei appear to fuse in the resting stage (fig. 3, C). In many Gymnosperms the male nucleus penetrates the female nucleus before fusing with it (Blackman, Ikeno). In other cases the two nuclei place themselves side by side, the nuclear membrane between them disappears, and the contents fuse together—nuclear thread

with nuclear thread, and nucleolus with nucleolus—so completely that the separate constituents of the nuclei are not visible. It was at one time thought that the centrosomes played an important part in the fertilization of plants, but recent researches seem to indicate that this is not so. Even in those cases where the cilia band, which is the product of the centrosome-like body or blepharoplast, enters the ovum, as in *Zamia* (c in fig. 4, B, C, D), it appears to take no part in the fertilization phenomena, nor in the subsequent division of the nucleus. During the process of fertilization in the Angiosperms it has been shown by the researches of Nawaschin and Guignard that in *Lilium* and *Fritillaria* both generative nuclei enter the embryo sac, one fusing with the oosphere nucleus, the other with the polar nuclei (fig. 3, A, B). A double fertilization thus takes place. Both nuclei are elongated vermiform structures, and as they enter the embryo sac present a twisted appearance like a spermatozoid without cilia (fig. 3, A, B). It has since been shown by other observers that this double fertilization occurs in many other Angiosperms, both Dicotyledons and Monocotyledons, so that it is probably of general occurrence throughout the group (see ANGIOSPERMS).

The Nucleus in Relation to Heredity.—There is a certain amount of cytological evidence to show that the nucleus is largely concerned with the transmission of hereditary characters. Whether this is entirely confined to the nucleus is, however, not certain. The strongest direct evidence seems to be that the nuclear substances are the only parts of the cells which are always equivalent in quantity, and that in the higher plants and animals the male organ or spermatozoid is composed almost entirely of the nucleus, and that the male nucleus is carried into the female cell without a particle of cytoplasm.¹

Since, however, the nucleus of the female cell is always accompanied by a larger or smaller quantity of cytoplasm, and that in a large majority of the power plants and animals the male cell also contains cytoplasm, it cannot yet be definitely stated that the cytoplasm does not play some part in the process. On the other hand, the complex structure of the nucleus with its separate units, the chromosomes, and possibly even smaller units represented by the chromatin granules, and the means taken through the complex phenomena of mitosis to ensure that an exact and equal division of the chromosomes shall take place, emphasizes the importance of the nucleus in heredity. Further, it is only in the nucleus and in its chromosomes that we have any visible evidence to account for the Mendelian segregation of characters in hybrids which are known to occur. Visible differences in the chromosomes have even been observed, especially in insects, which are due apparently to an unequal division by which an additional or accessory chromosome is produced, or in some cases one or two extra chromosomes which differ in size from the others. These differences indicate a separation of different elements in the formation of the chromosomes and have been definitely associated with the determination of sex. It is possible, however, that the segregation of characters in the gametes may depend upon something far more subtle and elusive than the chromosomes or even of possible combinations of units within the chromosomes, but so far as we can see at present these are the only structures in the cell with which it can be satisfactorily associated. Boveri in fact has put forward the view that the chromosomes are elementary units which maintain an organic continuity and independent existence in the cell. The cytological evidence for this appears to be much stronger for animal than for plant cells. From numerous investigations which have been made to trace the chromosomes through the various stages of the nuclear ontogeny of plant cells, it appears that the individuality and continuity of the chromosomes can only be conceived as possible if we assume the existence of something like chromosome centres in the resting nucleus around which the chromosomes become organized for purposes of division. Rosenberg (1909) adduces evidence for

¹ Strasburger (1909) states very definitely that he has observed the entrance of the male nucleus into the egg without a trace of cytoplasm.

the existence of chromosomes or "prochromosomes" in resting nuclei in a large number of plants, but most observers consider that the chromosomes during the resting stage become completely resolved into a nuclear network in which no trace of the original chromosomes can be seen.

Special Cell-Modifications for the Reception of Stimuli.—In studying the physiology of movement in plants certain modifications of cell-structure have been observed which appear to have been developed for the reception of the stimuli by which the response to light, gravity and contact are brought about. Our knowledge of these structures is due mainly to Haberlandt.

Organs which respond to the mechanical stimulus of contact are found to possess special contrivances in certain of their cells—(1) sensitive spots, consisting of places here and there on the epidermal cells where the wall is thin and in close contact with protoplasmic projections. These occur on the tips of tendrils and on the tentacles of *Drosera*; (2) sensitive papillae found on the irritable filaments of certain stamens; and (3) sensitive hairs or bristles on the leaves of *Dionaea muscipula* and *Mimosa pudica*—all of which are so constructed that any pressure exerted on them at once reacts on the protoplasm.

Response to the action of gravity appears to be associated with the movements of starch grains in certain cells—statolith cells—by which pressure is exerted on the cytoplasm and a stimulus set up which results in the geotropic response.

The response to the action of light in diatropic leaves is, according to Haberlandt, due to the presence of epidermal cells which are shaped like a lens, or with lens-shaped thickenings of the cuticle, through which convergence of the light rays takes place and causes a differential illumination of the lining layer of protoplasm on the basal walls of the epidermal cells, by which the stimulus resulting in the orientation of the leaf is brought about. Fig. 5, A, shows the

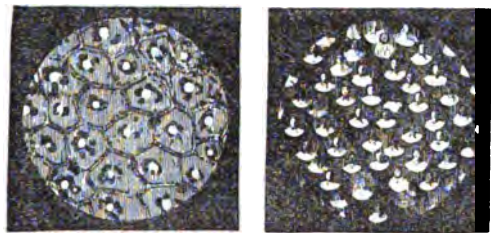

FIG. 5. A, Epidermal cells of *Saxifraga hirsutum*. B, of *Tradescantia fluminensis*.

convergence of the light to a bright spot on the basal walls of the epidermal cells of *Saxifraga hirsutum* and fig. 5, B, shows a photograph taken from life through the epidermal cells of *Tradescantia fluminensis*. Notwithstanding the fact, however, that these cells are capable of acting as very efficient lenses the explanation given by Haberlandt has not been widely accepted and evidence both morphological and physiological has been brought forward against it.

The presence of an eye-spot in many motile unicellular Algae and swarm spores is also probably concerned with the active response to light exhibited by these organisms. In *Euglena viridis*, which has been most carefully studied in this respect, the flagellum which brings about the movement bears near its base a minute spherical or oval refractive granule or swelling which is located just in the hollow of the red pigment-spot (fig. 6); and it has been suggested that the association of these two is analogous to the association of the rods and cones of the animal eye with their pigment layer, the light absorbed by the red pigment-spot setting up changes which react upon the refractive granule and being transmitted to the flagellum bring about those modifications in its vibrations by which the direction of movement of the organism is regulated.

The Nuclei of the Lower Plants.—It is only in comparatively recent times that it has been possible to determine with any degree of certainty that the minute deeply stainable bodies described more especially by Schmitz (1870) in many Algae and Fungi could be regarded as true nuclei. The researches of the last twenty years have shown that the structure of the nucleus and the phenomena of nuclear division in these lower forms conforms in all essential details to those in the higher plants. Thus in the Basidiomycetes (fig. 7) the nuclei possess all the structures found in the higher plants, nuclear membrane, chromatin network and nucleolus (fig. 7, B), and in the process

of division, chromosomes, nuclear spindle and centrosomes are to be seen (fig. 7, C-G). The investigations of Dangeard, Harper, Blackman, Miss Fraser and many others have also



(From the *Journal of the Linnean Society, "Zoology" vol. xxvii.*)
FIG. 6.—A, Eye-spots of *Euglena viridis*. B, Anterior end of *Euglena* showing the flagellum with its swelling just in the hollow of the eye-spot.

shown that in the Ascomycetes, Rust Fungi, &c., the same structure obtains so far as all essential details are concerned.

The only groups of plants in which typical nuclei have not been found are the Cyanophyceae, Bacteria and Yeast Fungi.

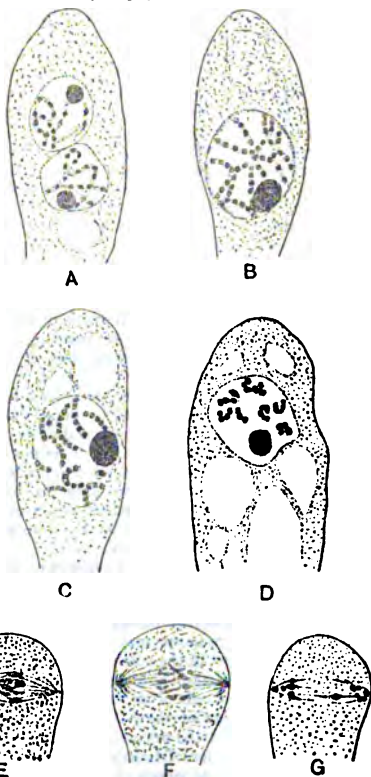

(From the *Annals of Botany*, vols. vii. and viii.)
FIG. 7.—Nuclei and Nuclear Division in the Basidiomycetes. A to D, *Amanita muscaria*; E to G, *Myceena galericulatus*. A, Basidium with two nuclei. B, single nucleus due to the fusion of the two pre-existing nuclei. C, Nuclear thread segmenting. D, Nuclear cavity with chromosomes. E, Chromosomes on the spindle. F, Separation of the chromosomes into two groups. G, Chromosomes grouped at opposite ends of the spindle to form the daughter nuclei.

In the Cyanophyceae the contents of the cell are differentiated into a central colourless region, and a peripheral layer containing the chlorophyll and other colouring matters together with granules of a reserve substance called cyanophycin. Chromatin is contained in the central part together with granules known as volutin, the function of which is unknown. The central body probably plays the part of a nucleus and some observers consider that it has the characters of a typical nucleus with mitotic division. But this is very doubtful. The central body seems to consist merely of a spongy mass of slightly stainable substance, more or less impregnated with chromatin, which divides by constriction. At a certain stage in the division figures are produced resembling a mitotic phase (fig. 8, 1), which are not, in

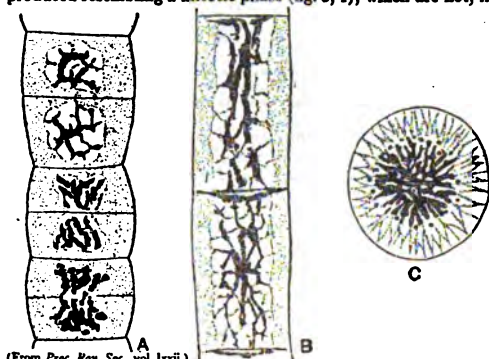

(From Proc. Roy. Soc., vol. Lxxii.)

FIG. 8.—Cell Structure of the Cyanophyceae.
A and B, *Tolypothrix lanata*: (1) Young, (2) Old cells.
C, *Oscillatoria limosa*: transverse microtome section.

the opinion of the writer, to be interpreted as a true mitosis. It is interesting to note that in many species the formation of new cell-walls is initiated before any indication of nuclear division is to be seen.

The bacteria, in most cases, have no definite nucleus or central body. The chromatin is distributed throughout the cytoplasm in the form of granules which may be regarded as a distributed nucleus corresponding to what Hertwig has designated, in protozoa, *chromidia*.

In the yeast cell the nucleus is represented by a homogenous granule, probably of a nucleolar nature, surrounded and perhaps to some extent impregnated by chromatin and closely connected with a vacuole which often has chromatin at its periphery, and contains one or more volutin granules which appear to consist of nucleic acid in combination with an unknown base. Some observers consider that the yeast nucleus possesses a typical nuclear structure, and exhibits division by mitosis, but the evidence for this is not very satisfactory.

Tissues.—The component parts of the tissues of which plants are composed may consist of but slightly modified cells with copious protoplasmic contents, or of cells which have been modified in various ways to perform their several functions. In some the protoplasmic contents may persist, in others they disappear. The formation of the conducting tubes or secretory sacs which occur in all parts of the higher plants is due either to the elongation of single cells or to the fusion of cells together in rows by the absorption of the cell-walls separating them. Such cell-fusions may be partial or complete. Cases of complete fusion occur in the formation of laticiferous vessels, and in the spiral, annular and reticulate vessels of the xylem. Incomplete fusion occurs in sieve tubes. Tubes formed by the elongation of single cells are found in bast fibres, tracheides, and especially in laticiferous cells.

Laticiferous Tissue.—The laticiferous tissue consists of a network of branching or anastomosing tubes which contain a coagulable fluid known as latex. These tubes penetrate to all parts of the plant and occur in all parts of the root, stem and leaves. A protoplasmic lining is found on their walls which contains nuclei. The

walls are pitted, and protoplasmic connexions between the laticiferous tubes and neighbouring parenchyma-cells have been seen. There are two types of laticiferous tissue—non-articulate and articulate. The non-articulate tissue which occurs in Euphorbiaceae, Apocynaceae, Urticaceae, Asclepiadaceae, consists of long tubes, equivalent to single multinucleate cells, which ramify in all directions throughout the plant. Laticiferous vessels arise by the coalescence of originally distinct cells. The cells do not only fuse together in longitudinal and transverse rows, but put out transverse projections, which fuse with others of a similar nature, and thus form an anastomosing network of tubes which extends to all parts of the plant. They are found in the Compositae (*Cichoriaceae*), Campanulaceae, Papaveraceae, Lobeliaceae, Papayaceae, in some Aroidaceae and Musaceae, and in Euphorbiaceae (*Manihot*, *Hewea*). The nuclei of the original cells persist in the protoplasmic membrane. The rows of cells from which the laticiferous vessels are formed can be distinguished in many cases in the young embryo while still in the dry seed (Scott), but the latex vessels in process of formation are more easily seen when germination has begun. In the process of cell-fusion the cell-wall swells slightly and then begins to dissolve gradually at some one point. The opening, which is at first very small, increases in size, and before the cross-wall has entirely disappeared the contents of the two cells become continuous (Scott). The absorption of the cell-walls takes place very early in the germinating seedling.

Sieve Tubes.—The sieve tubes consist of partially fused rows of cells, the transverse or lateral walls being perforated by minute openings, through which the contents of the cells are connected with each other, and which after a certain time become closed by the formation of callus on the sieve plates. The sieve tubes contain a thin lining layer of protoplasm on their walls, but no nuclei, and the cell sap contains albuminous substances which are coagulable by heat. Starch grains are sometimes present. In close contact with the segments of the sieve tubes are companion cells which communicate with the sieve tubes by delicate protoplasmic strands; they can be distinguished from ordinary parenchymatous cells by their small size and dense protoplasm. Companion cells are not found in the Pteridophyta and Gymnosperms. In the latter their place is taken by certain cells of the medullary rays and bast parenchyma. The companion cells are cut off from the same cells as those which unite to form the sieve tube. The mode of formation of the sieve plate is not certainly known; but from the fact that delicate connecting threads of protoplasm are present between the cells from their first development it is probable that it is a special case of the normal protoplasmic continuity, the sieve pores being produced by a secondary enlargement of the minute openings through which these delicate strands pass. According to Lecomte, the young wall consists partly of cellulose and partly of a substance which is not cellulose, the latter existing in the form of slight depressions, which mark the position of the future pores. As the sieve plate grows these non-cellulose regions swell and gradually become converted into the same kind of mucous substance as that contained in the tube; the two cells are thus placed in open communication. If this is correct it is easy to see that the changes which take place may be initiated by the original delicate protoplasmic strands which pass through the cell-wall. (For further information regarding tissues, see the section on *Anatomy* above.)

Protoplasmic Continuity.—Except in the unicellular plants the cell is not an independent unit. Apart from their dependence in various ways upon neighbouring cells, the protoplasts of all plants are probably connected together by fine strands of protoplasm which pass through the cell-wall (Tangl, Russow, Gardiner, Kienitz-Gerloff and others) (fig. 9). In *Pinus* the presence of connecting threads has recently been demonstrated throughout all the tissues of the plant. These protoplasmic strands are, except in the case of sieve tubes, so delicate that special methods have to be employed to make them visible. The basis of these methods consists in causing a swelling of the cell-wall by means of sulphuric acid or zinc chloride, and subsequent staining with Hoffmann's blue or other aniline dyes. The results so far obtained show that the connecting threads may be either "pit-threads" which traverse the closing membrane of the pits in the cell-walls (fig. 9, B), or "wall-threads" which are present in the wall of the cell (fig. 9, A). Both



(After Gardiner.)

FIG. 9.—Continuity of protoplasm of cells of *Taxus canadensis* (A) and endosperm of *Lilium Martagum* (B).

pit-threads and wall-threads may occur in the same cell, but more often the threads are limited to the pits. The pit-threads are larger and stain more readily than the wall-threads. The threads vary in size in different plants. They are very thick in *Viscum album*, and are well seen in *Phaseolus multiflorus* and *Lilium Martagon*. They are present from the beginning of the development of the cell-wall, and arise from the spindle fibres, all of which may be continued as connecting threads (endosperm of *Tamus communis*), or part of them may be overlaid by cellulose lamellae (endosperm of *Lilium Martagon*), or they may be all overlaid as in pollen mother-cells and pollen grains of *Helloborus foetidus*. The presence of these threads between all the cells of the plant shows that the plant body must be regarded as a connected whole; the threads themselves probably play an important part in the growth of the cell-wall, the conduction of food and water, the process of secretion and the transmission of impulses.

LITERATURE.—The following is a list of a few of the more important papers in which further information and a more complete list of literature will be found: Allen, "Nuclear Division in the Pollen Mother-cells of *Lilium canadense*," *Annals of Botany* (1905), vol. xix.; Berghs, "La Formation des chromosomes hétérotypiques dans la sporogénèse végétale," *La Cellule* (1904), vol. xxi.; Blackman, "On the Fertilization, Alternation of Generations, and General Cytology of the Uredineae," *Ann. of Bot.* (1904), vol. xviii.; Büttlich, *Untersuchungen über mikroskopische Schäume und das Protoplasma* (Leipzig, 1892; Eng. trans. by Minchin, London, 1893); also *Untersuchungen über Struktur* (Leipzig, 1898); Courchet, "Recherches sur les Chromolucites," *Ann. d. sci. nat. (bot.)*; (1888); Delage, *L'Année biologique: comptes rendus annuels des travaux de biologie générale* (Paris, 1895), &c.; Farmer, "Recent Advances in Vegetable Cytology," *Science Progress* (1896), vol. v.; "The Cell and some of its Constituent Structures," *Science Progress* (1897); Farmer and Moore, "On the Meiotic Phase in Animals and Plants," *Quart. Journ. Microsc. Sci.* (1905), vol. xlviii.; Farmer and Digby, "Studies in Apospory and Apogamy in Ferns," *Ann. of Bot.* (1907), vol. xxi.; "On the Cytological Features exhibited by certain Varietal and Hybrid Ferns," *Ann. of Bot.* (1910), vol. xxiv.; Fischer, *Fixierung, Färbung und Bau des Protoplasmas* (Jena, 1899); Flemming, "Morphologie der Zelle," *Ergebnisse der Anatomie und Entwicklungsgeschichte* (1866); Gardiner, "The Histology of the Cell-Wall, with Special Reference to the Mode of Connexion of Cells," *Proc. Roy. Soc.* (1897-1898), lxiii. and his earlier papers there cited; see also *Proc. Camb. Phil. Soc.* (1908), vol. ix.; "The Genesis and Development of the Wall and Connecting Threads in the Plant Cell. Preliminary Communication," *Proc. Roy. Soc.* (1909), lxvi.; Gates, "A Study of Reduction in *Oenothera rubrinervis*," *Bot. Gaz.* (1908), vol. xlvii.; Green, "The Cell Membrane," *Science Progress* (1897), new series, vol. i.; Grégoire, "Les Cinèses polliniques chez les Liliacées," *La Cellule* (1899), vol. xvi.; "Les Résultats acquis sur les cinèses de maturation dans les deux règnes," *La Cellule* (1905), vol. xxii. and (1910) vol. xxvi.; Grégoire and Wygaerts, "La Reconstitution du noyau et la formation des chromosomes dans les cinèses somatiques," i. *La Cellule* (1903), vol. xxi.; Guignard, "Sur les anthérozoïdes et la double copulation sexuelle chez les Liliacées," *Comptes rendus* (1899), 128; Haberlandt, *Physiologische Pflanzenanatomie* (Leipzig, 1909); *Die Lichtsinnesorgane der Laubbätter* (Leipzig, 1905); R. A. Harper, *Sexual Reproduction and the Organization of the Nucleus in certain Mildews* (pub. Carnegie Institution, 1905); H. Hartog, "The Dual Force of the Dividing Cell," *Proc. Roy. Soc.*, B. lxxvi.; Heneguy, *Leçons sur la cellule, morphologie et reproduction* (Paris, 1896); O. Hertwig, *Die Zelle und die Gewebe* (Jena, 1893 and 1898; see Eng. ed., London, 1894); Hirase, "Etudes sur la fécondation et l'embryogénie du *Ginkgo biloba*," *Journ. Coll. Sci. Imp. Univ.* (Japan, 1895); Ikono, "Untersuchungen über die Entwicklung der Geschlechtsorgane und den Vorgang der Befruchtung bei *Cycas revoluta*," *Jahr. f. wiss. Botanik* (1898), 32; Lee, *The Microtome's Vade Mecum* (London, 1900); Macallum, "On the Detection and Localization of Phosphorus in Animal and Vegetable Cells," *Proc. Roy. Soc.* (1898), vol. lxiii.; "On the Distribution of Assimilated Iron Compounds other than Haemoglobin and Haematins, in Animal and Vegetable Cells," *Quart. Journ. Microsc. Sci.* (1896), vol. xxxviii.; Meyer, *Untersuchungen über die Stärke-Körner* (Jena, 1895); Montgomery, "Comparative Cytological Studies, with especial regard to the Morphology of the Nucleolus," *Journ. of Morphology*, vol. xv. (Boston, 1899); D. M. Mottier, "The Development of the Heterotype Chromosomes in Pollen Mother-cells," *Ann. of Bot.* (1907), vol. xxi.; "On the Prophases of the Heterotype Mitosis in the Embryo-sac Mother-cell of *Lilium*," *Ann. of Bot.* (1909), vol. xxiii.; *Fecundation in Plants* (Carnegie Institution, 1904); Nawaschin, "Resultate einer Revision der Befruchtungsvorgänge bei *Lilium Martagon* und *Fritillaria tenella*," *Bull. de l'acad. des sci. de St. Pétersbourg* (1898); "Ueber die Befruchtungsvorgänge bei einigen Dicotyledoneen," *Ber. d. deutsch. bot. Gesell.* (1900), vol. 18; Rosenber,

"Cytologische und morphologische Studien an *Drosera longifolia* X. *rotundifolia*," *Kungl. svenska vetenskapsakad. handl.* (1909), vol. xlv.; Salter, "Zur näheren Kenntniss der Stärkekörner," *Pringsh. Jahrb.* (1898), Sargant, "The Formation of the Sexual Nuclei in *Lilium Martagon*, I. and II.," *Ann. of Bot.* (1896-1897), vols. x. and xi.; "Recent Work on the Results of Fertilization in Angiosperms," *Ann. of Bot.* (1900), vol. xiv.; Schimper, "Sur l'Amidon et les Leucites," *Ann. des sci. nat.* (bot.) (1887); Scott, "Development of Articulated Laticiferous Vessels," *Quart. Journ. Microsc. Sci.* (1882); "On the Laticiferous Tissue of *Mantel Glassium* (the Ceara Rubber)," *Quart. Journ. Microsc. Sci.* (1884); Strasburger, "Chromosomenzahlen, Plasmastrukturen, Vererbungssträger und Reduktionsteilung," *Jahrb. wiss. Bot.* (1908), vol. xlv.; *Histologische Beiträge* vols. i. to vii. (Jena); Strasburger and others, "Cytologische Studien aus dem Bonner botanischen Institut," *Jahrb. für wissensch. Botanik* (1897), vol. 30; Wager, "On Nuclear Division in the Hymenomyces," *Ann. of Bot.* (1893), vol. vii.; "On the Structure and Reproduction of *Cystopus candidus*," *Ann. of Bot.* (1896), vol. x.; "The Cell Structure of the Cyanophyceae," *Proc. Roy. Soc.* (1903), vol. lxxiii.; Wager and Peniston, "Cytological Observations on the Yeast Plant," *Ann. of Bot.* (1910), vol. xxiv.; Webber, "The Development of the Antherozoids of *Zamia*," *Bot. Gaz.* (1897), vol. xxiv.; Wilson, *The Cell in Development and Inheritance* (New York and London, 1900); Zimmermann, "Sammel-Referate aus dem Gesamtgebiete der Zellenlehre," *Beihfte zum bot. Centralbl.* (1893 and 1894); *Die Morphologie und Physiologie des pflanzlichen Zellkernes* (Jena, 1898). (H. W.)

MORPHOLOGY OF PLANTS

The term *morphology*, which was introduced into science by Goethe (1817), designates, in the first place, the study of the form and composition of the body and of the parts of which the body may consist; secondly, the relations of the parts of the same body; thirdly, the comparison of the bodies or parts of the bodies of plants of different kinds; fourthly, the study of the development of the body and of its parts (*ontogeny*); fifthly, the investigation of the historical origin and descent of the body and its parts (*phylogeny*); and, lastly, the consideration of the relation of the parts of the body to their various functions, a study that is known as *organography*.

It is this last department of morphology that was the first to be pursued. The earliest scientific result of the study of plants was the recognition of the fact that the various parts of the body are associated with the performance of different kinds of physiological work; that they are, in fact, *organs* discharging special functions. The origin of the organography of the present day may be traced back to Aristotle, who described the parts of plants as "organs, though very simple ones." It was not until many centuries had passed that the parts began to be regarded from the point of view of their essential nature and of their mutual relations; that is, morphologically instead of organographically. Joachim Jung, in his *Isagoge phytoscopica* (1678), recognized that the plant-body consists of certain definite members, root, stem and leaf, and defined them by their different form and by their mutual relations. This point of view was further developed in the following century by Caspar Friedrich Wolff (*Theoria generationis*, 1759), who first followed the development of the members at the growing-point of the stem. He observed that the "appendicular organs," as he called the leaves, are developed in the same way, whether they be foliage-leaves, or parts of the flower, and stated his conclusions thus: "In the entire plant, whose parts we wonder at as being, at the first glance, so extraordinarily diverse, I finally perceive and recognize nothing beyond leaves and stem (for the root may be regarded as a stem). Consequently all parts of the plant, except the stem, are modified leaves." Similar views were arrived at by Goethe, though by the deductive rather than the inductive method, and were propounded in his famous pamphlet, *Versuch die Metamorphose der Pflanzen zu erklären* (1790), from which the following is a quotation: "The underlying relationship between the various external parts of the plant, such as the leaves, the calyx, the corolla, the stamens, which develop one after the other and, as it were, out of one another, has long been generally recognized by investigators, and has in fact been specially studied, and the operation by which one and the same organ presents itself to us in various forms has been termed *Metamorphosis of Plants*."

Pure Morphology.—Thus it became apparent that the many

and various organs of plants are, for the most part, different forms of a small number of *members* of the body, which have been distinguished as follows, without any reference to function. The *thallus* (thallome) is a plant-body which is not differentiated into the members root, stem and leaf; it is the morphologically simplest body, such as is of common occurrence in the lower plants (e.g. *Thallophyta*). In a differentiated body the *stem* (caulome) is an axis capable of bearing leaves and (directly or indirectly) the proper reproductive organs. The *leaf* (phyllome) is an appendicular member only borne by a stem, but differing from it more or less obviously in form and development, though co-ordinate with it in complexity of structure. The *root* is an axis which never bears either leaves or the proper reproductive organs (whether sexual or asexual) of the plant. The *hair* (trichome) is a superficial appendage of simple structure, which may be borne by any of the other members. The *emergence* is also an appendicular member of more complex structure than the hair (e.g. the prickles of the rose). Further, it has been found convenient to designate the leaf-bearing stem as a whole by the term *shoot*, so that the body may, as Sachs suggested, be primarily analysed into shoot and root.

At the present time some objection is being taken to this purely morphological conception of the body and its parts as being too abstract. It is urged that the various parts are, as a matter of fact, organs; and that it is therefore inadmissible to ignore their functions, as is done in the foregoing definitions. To this it may be replied that pure morphology and organography are not alternatives, but are two complementary and equally necessary modes of considering the composition of the plant-body. Moreover, the abstract terms "stem," "leaf," "root," &c., are absolutely indispensable; and are continually used in this sense by the most ardent organographers. It has not yet been suggested that they should be replaced by organographical terms; were this accomplished, descriptive botany would become impossible.

It is also urged against these definitions that they are not of universal applicability; that there are exceptional structures which cannot be brought within the limits of any one of them. But admitting the validity of this criticism, and even going so far as to question the possibility of ever devising absolutely inclusive and, at the same time, exclusive definitions, no sufficient reason is adduced for giving up all attempt at morphological analysis.

Homology.—All members belonging to the same morphological category are said to be *homologous*, however diverse their functions. Thus, in a phanerogam, the sepals, petals, stamens and foliage-leaves all come under the category *leaf*, though some are parts of the perianth, others are spore-bearing organs (*sporophylls*), and others carry on nutritive processes. The homology of members was based, in the first instance, upon similarity of development and upon similar relations to the other parts of the body, that is, upon *ontogeny*. But since the general adoption of the theory of evolution, similarity of descent, that is of *phylogeny*, has come to form an essential part of this conception; in other words, in order that their homology may be established the parts compared must be proved to be *homogenetic*.

The introduction of the phylogenetic factor has very much increased the difficulty of determining homologies; for the data necessary for tracing phylogeny can only be obtained by the study of a series of allied, presumably ancestral, forms. One of the chief difficulties met with in this line of research, which is one of the more striking developments of modern morphology, is that of distinguishing between organs which are "reduced," and those which are really "primitive." The object of the phylogenetic study of any organ is to trace it back to its primitive form. But, as will be pointed out later, organs are often found to have undergone "degeneration" or "reduction," and such reduced or degenerate structures may easily be mistaken for primitive structures, and so the investigator may be misled.

The effect of the phylogenetic factor in homology may be illustrated in the following cases. The leaves of the true mosses

and those of the club-mosses (*Lycopodium*, *Selaginella*) being somewhat alike in general appearance and in ontogeny, might be, and indeed have been, regarded as homologous on that ground. However, they belong respectively to two different forms in the life-history of the plants; the leaves of the mosses are borne by the gametophyte, those of the club-mosses by the sporophyte. In accordance with the prevalent antithetic view of the alternation of generations in these plants (see PLANTS, REPRODUCTION OF), the forms distinguished as sporophyte and gametophyte are not homogenetic; consequently their leaves are not homologous, but are only functionally similar (homoplastic; see *infra*).

Another effect is that different degrees of homology have to be recognized, just as there are different degrees of relationship or affinity between individual plants. When two organs can be traced along the same line of descent to one primitive form, that is when they are found to be *monophyletic*, their homology is *complete*; when, however, they are traceable to two primitive forms, though these forms belong to the same morphological series, they are *polyphyletic* and therefore only *incompletely* homologous. For instance, all the leaves of the Bryophyta are *generally homologous* inasmuch as they are all developments of the gametophyte. But there is reason to believe that they have been differentiated quite independently in various groups, such as the Marchantiaceae, the Jungermanniaceae, and the mosses proper; consequently their phylogeny is not the same, they are polyphyletic, and therefore they are not completely homologous, but are *parallel developments*.

Analogy.—Considering the parts of the body in relation to their functions, that is as *organs*, they are found to present peculiarities of form and structure which are correlated with the functions that they have to discharge; in other words, the organ shows adaptation to its functions. All organs performing the same function and showing similar adaptations are said to be *analogous* or *homoplastic*, whatever their morphological nature may be; hence organs are sometimes both homologous and analogous, sometimes only analogous. The tendrils of a vetch and of a cucumber are analogous, and also homologous because they both belong to the category *leaf*; but they are only analogous to the tendrils of the vine and of the passion-flower, which belong to the category *stem*.

Metamorphosis.—It has already been pointed out that each kind of member of the body may present a variety of forms. For example, a *stem* may be a tree-trunk, or a twining stem, or a tendril, or a thorn, or a creeping rhizome, or a tuber; a *leaf* may be a green foliage-leaf, or a scale protecting a bud, or a tendril, or a pitcher, or a floral leaf, either sepal, petal, stamen or carpel (sporophyll); a *root* may be a fibrous root, or a swollen tap-root like that of the beet or the turnip. All these various forms are organs discharging some special function, and are examples of what Wolff called "modification," and Goethe "metamorphosis." It may be inquired what meaning is to be attached to these expressions, and what are the conditions and the nature of the changes assumed by them. The leaf of the higher plants will be taken as the illustrative case because it is the most "plastic" of the members, the one, that is, which presents the greatest variety of adaptations, and because it has been most thoroughly studied.

In this, as in all morphological inquiries, two lines of investigation have to be followed, the phylogenetic and the ontogenetic. Beginning with its phylogeny, it appears, so far as present knowledge goes, that the differentiation of the shoot of the sporophyte into stem and leaf first occurred in the Pteridophyta; and, in accordance with the views of Bower (*Origin of a Land-Flora*), the primitive leaf was a reproductive leaf, a sporophyll, from which the foliage-leaf was derived by progressive sterilization. From the nature of the case, this view is not, and could not be, based upon actual observation, nor is it universally accepted; however, it seems to correspond more closely than any other to the facts of comparative morphology. It was formerly assumed, and the view is still held, that the foliage-leaf was the primitive form from which all others were derived, mainly on

the ground that, in ontogeny, the foliage-leaf generally precedes the sporophyll. The phylogeny of the various floral leaves, for instance, was generally traced as follows: foliage-leaf, bract, sepal, petal, stamen and carpel (sporophylls)—in accordance with what Goethe termed "ascending metamorphosis." Recent researches, however, more especially those of Celakovsky, tend to prove that the perianth-leaves have been derived from the stamens (*i.e.* from sporophylls); that is, they are the result of "descending metamorphosis." Moreover there is the fact that the flowers of nearly all the primitive phanerogams, such as the Gymnosperms, consist solely of sporophylls, having no perianth. There is thus a considerable body of evidence to support Bower's view of the primitive nature of the sporophyll.

Accepting this view of the phylogeny of the leaf, the perianth-leaves (sepals and petals) and the foliage-leaves may be regarded as "modified" or "metamorphosed" sporophylls; that is, as leaves which are adapted to functions other than the bearing of spores. The sepals are generally organs for the protection of the flower-bud; the petals, for attracting insects by their conspicuous form and colour; the foliage-leaves, for the assimilation of carbon dioxide and other associated functions. But this phylogenetic differentiation of the organs was not what Wolff and Goethe had in mind; what they contemplated was an ontogenetic change, and there is abundant evidence that such changes actually occur. Taking first the conversion of members of one morphological category into those of another, this has been actually observed, though rarely. Goebel (*Organography*) gives several instances of the conversion of the root into a shoot in ferns, and a few in phanerogams (*Listera ovalis*, *Neottia nidus-avis*, *Anthurium longifolium*). Much more common is the conversion of one form of a member into another form. The most varied changes of this kind have been described, and are generally familiar as "monstrosities"; the study of them constitutes, under the name of *teratology*, a distinct department of biology. A simple case is that of "double" flowers, in which the number of the petals is increased by the "metamorphosis" of stamens; or again the conversion of floral leaves into green leaves, a change known as "chloranthly." These changes may be brought about by external causes, such as the attacks of insects or of fungi, alterations in external conditions, &c., or by some unexplained internal disturbance of the morphological equilibrium. They can also be effected experimentally. Goebel has shown that if the developing foliage-leaves of the fern *Onoclea striuliopteris* be removed as they are formed, the subsequently developed sporophylls assume more or less completely the habit of foliage-leaves, and may be sterile. Similarly bud-scales can be caused to develop into foliage-leaves, if the buds to which they belong are caused to grow out in the year of their formation by the removal of the existing foliage-leaves.

Useful and suggestive as they often are, teratological facts played, at one time, too large a part in the framing of morphological theories; for it was thought that the "monstrous" form gave a clue to the essential nature of the organ assuming it. There is, however, no sufficient reason for regarding the monstrous form as necessarily primitive or ancestral, nor even as a stage in the ontogeny of the organ. For when the older morphologists spoke of a stamen as a "metamorphosed" leaf, it was implied that it originated as a foliage-leaf and subsequently became a stamen. As a matter of fact, a stamen is a stamen and nothing else, from the very beginning. The development of the organ is already determined at its first appearance upon the growing-point; though, as already explained, the normal course of its ontogeny may be interfered with by some abnormal external or internal condition. The word "metamorphosis" cannot, in fact, be used any longer in its original sense, for the change which it implied does not normally occur in ontogeny, and in phylogeny the idea is more accurately expressed by the term "differentiation." However, it may still be useful in describing "monstrosities," and perhaps also those cases in which an organ serves first one purpose and then another, as when a leafy shoot eventually becomes a thorn, or the base of a foliage-leaf becomes a bud-scale.

Differentiation.—Any account of the general morphology of living organisms is incomplete if it does not include some attempt at an explanation of its causation; though such an attempt cannot be carried far at the present time. A survey of the vegetable kingdom indicates that evolution has proceeded, on the whole, from the simple to the complex; at the same time, as has been already mentioned, evidence of reduction or degeneration is common. Thus in the series Bryophyta, Pteridophyta, Phanerogamia, whilst the sporophyte presents progressive development, the gametophyte presents continuous reduction.

Evolution means the gradual development of "highly organized" from "lowly organized" forms; that is, of forms in which the "physiological division of labour" is more complete, from those in which it is less complete; of forms possessing a variety of organs, from forms possessing but few. Differentiation means the development and the specialization as organs of various parts of the body. It presents itself in two aspects: there is morphological differentiation, which can be traced in the distinction of the members of the body, root, stem, leaf, &c.; there is physiological differentiation, which can be traced in the adaptation of these members to various functions. But, in actual operation, these two processes are simultaneous; every member is developed as an organ for the performance of some special function.

Factors in Evolution.—Evolution in the race involves progressive differentiation in the individual; hence the causes of evolution and of differentiation must be the same. The evolution of higher from lower plants, it is generally assumed, has proceeded by variation. With regard to the causation of variation Darwin says (*Origin of Species*, ch. v.): "In all cases there are two factors, the nature of the organism, which is much the most important of the two, and the nature of the conditions. The direct action of changed conditions leads to definite or indefinite results. In the latter case the organization seems to become plastic, and we have much fluctuating variability. In the former case the nature of the organism is such that it yields readily, when subjected to certain conditions, and all or nearly all the individuals become modified in the same way."

In spite of the statement that the "nature of the organism" is the most important factor in variation, the tendency amongst evolutionists has been to take much more account of the influence of external conditions. Exceptions to this attitude are Lamarck, who speaks with regard to animals (but not to plants!) of "la composition croissante de l'organisation" (*Philosophie zoologique*, t. i.), and Nägeli, who attributes variation to causes inherent in the "idioplasm," and has elaborately worked out the view in his *Abstammungslehre*.

The position assumed in this article is in agreement with the views of Lamarck and of Nägeli. All but the lowest plants visibly tend towards or actually achieve in various degrees the differentiation of the body, whether sporophyte or gametophyte, into stem, leaf, root, &c., that is, the differentiation of parts not previously present. It is inconceivable that external conditions can impart to an organism the capacity to develop something that it does not already possess: can impart to it, that is, the capacity for variation in the direction of higher complexity. The alternative, which is here accepted, is that differentiation is essentially the expression of a developmental tendency inherent in the protoplasm of plants. Just as every crystallizable chemical substance assumes a definite and constant crystalline form which cannot be accounted for otherwise than by regarding it as one of the properties of the substance, so every living organism assumes a characteristic form which is the outcome of the properties of its protoplasm. But whereas the crystalline form of a chemical substance is stable and fixed, the organized form of a living organism is unstable and subject to change.

Influence of External Conditions.—This position does not, however, exclude the influence of external conditions; that influence is undeniable. Darwin's expression "the nature of the organism" has been interpreted in the preceding paragraph to mean an inherent tendency towards higher organization; that interpretation may now be completed by adding that the

organism is susceptible to, and can respond to, the action of external conditions. There is every reason to believe that plants are as "irritable" to varying external conditions as they are to light or to gravity. A change in its external conditions may act as a "stimulus," evoking in the organism a response of the nature of a change in its form. As Darwin has pointed out, this response may be direct or indirect. In illustration of the indirect response, the evolution of the Bryophyta and of more highly organized plants may be briefly considered. It is generally admitted that life originated in water, and that the earliest plants were Algae. The study of existing Algae, that is of plants that have continued to live in water, shows that under these conditions no high degree of organization has been reached, though some of them have attained gigantic dimensions. The primitive water-plants were succeeded by land-plants, a land-flora being gradually established. With the transition from water to land came the progressive development of the sporophyte which is the characteristic feature of the morphology of the Bryophyta and of all plants above them in the scale of life (see Bower, *Origin of a Land-Flora*). This evolution of the sporophyte is no doubt to be correlated with the great change in the external conditions of life. There is no conclusive ground for regarding the action of this change as having been direct, it is more reasonable to regard it as indirect, having acted as a general stimulus to which the ever-increasing complexity of the sporophyte was the response.

Adaptation.—The morphological and physiological differentiation of the plant-body has, so far, been attributed to (1) "the nature of the organism," that is to its inherent tendency towards higher organization, and (2) to the "indefinite results" of the external conditions acting as a stimulus which excites the organism to variation, but does not direct the course of variation. The "definite results" of the action of external conditions have still to be considered.

It is a familiar observation that climatic and edaphic (nature of soil) conditions exert an influence upon the form and structure of plants (see PLANTS: Ecology of). For instance, some xerophytes are dry and hard in structure, whilst others are succulent and fleshy. This so-called *direct* effect of external conditions upon the form and structure of the body differs from the *indirect* effect in that the resulting variations bear a relation, of the nature of adaptation, to those conditions; the effect of the conditions is not only to cause variation, but to cause variation in a particular direction. Thus all existing hygrophytes (excepting the Algae) are considered to have been derived from land-plants which have adapted themselves to a watery habitat. The effect can also be demonstrated experimentally: thus it has been observed that a xerophyte grown in moist air will lose its characteristic adaptive features, and may even assume those of a hygrophyte.

Climatic and edaphic conditions are not, however, the only ones to affect the structure and composition of the body or its parts; other conditions are of importance, particularly the relations of the plant to animals and to other plants. For instance, the "animal traps" of carnivorous plants (*Drosera*, *Nepenthes*, &c.) did not, presumably, originate as such; they began as organs of quite another kind which became adapted to their present function in consequence of animals having been accidentally caught. It is also probable that the various forms of the angiospermous flower, with its many specialized mechanisms for pollination, may be the result of insect-visits, the flowers becoming adapted to certain kinds of insects, and the insects having undergone corresponding modification. Parasites, again, were derived from normal autotrophic plants, which, as the parasitic habit became more pronounced, acquired the corresponding characteristics of form and structure; there is, in fact, the group of hemi-parasites, plants which still retain autotrophic characters though they are root-parasites.

Though adaptation to the environment seems sometimes to be considered, especially by neo-Lamarckians, as equivalent to, or at least as involving, the evolution of higher forms from lower, there does not appear to be any evidence that this is the

case. The effect of external conditions is confined to the modification in various directions of members or organs already existing, and one very common direction is that of reduction or entire disappearance of parts: for instance, the foliage-leaves of certain xerophytes (e.g. Cactaceae, Euphorbiaceae), of parasites, and of saprophytes. Moreover, had the evolution of plants proceeded along the line of adaptation, the vegetable kingdom could not be subdivided, as it is, into the morphological groups Thallophyta, Bryophyta, Pteridophyta, Phanerogamia, but only into physiological groups, Xerophyta, Hygrophyta, Tropophyta, &c.

In endeavouring to trace the causation of adaptation, it is obvious that it must be due quite as much to properties inherent in the plant as to the action of external conditions; the plant must possess adaptive capacity. In other words, the plant must be irritable to the stimulus exerted from without, and be capable of responding to it by changes of form and structure. Thus there is no essential difference between the "direct" and the "indirect" action of external conditions, the difference is one of degree only. In the one case the stimulus induces indefinite variation, in the other definite; but no hard-and-fast line can be drawn between them.

Adaptive characters are often hereditary, for instance, the seed of a parasite will produce a parasite, and the same is true of a carnivorous plant. On the other hand, adaptations, especially those evoked by climatic or edaphic conditions, may only be shown by the seedling if grown under the appropriate external conditions; here what is hereditary is not the actual adaptation, but the capacity for responding in a particular way to a certain set of external conditions.

Summary.—The general theory of differentiation propounded in this article is an attempt at an analysis of the factors termed by Darwin "the nature of the organism" and "the nature of the conditions." It is assumed, as an inevitable conclusion from the facts of evolution, that plant-protoplasm possesses (1) an inherent tendency towards higher organization, and (2) that it is irritable to external conditions, or to changes in them, and can respond to them by changes of form which may be either indefinite or definite (adaptive). Thus it is that the variations are produced upon which natural selection has to work.

Material Cause of Differentiation.—It may be inquired, in conclusion, if there are any facts which throw light upon the internal mechanism of differentiation, whether spontaneous or induced; if it is possible to refer it to any material cause. It may be replied that there are such facts, and though they are but few as yet, they suffice to suggest an hypothesis that may eventually prove to be a law. Sachs was the first to formulate the theory that morphological differences are the expression of differences in material composition. He considered, for instance, that stems, leaves, roots and flowers differ as they do because the plastic substances entering into their structure are diverse. This view he subsequently modified to this—that a relatively small proportion of diverse substance in each of these parts would suffice to account for their morphological differences. This modification is important, because it transfers the formative influence from the plastic substances to the protoplasm, suggesting that the diverse constituents are produced (whether spontaneously or as the result of stimulation) as secretions by the protoplasm. It is an obvious inference that if a small quantity of a substance can affect the development of an entire organ it probably acts after the manner of an enzyme. Beyerinck has, in fact, gone so far as to speak of "formative enzymes."

It is not possible to go into all the facts that might be adduced in support of this view: one case, perhaps the most pregnant, must suffice. Beyerinck was led to take up the decided position just mentioned by his researches into the conditions determining the formation of plant-galls as the result of injury by insects. He found that the development of a gall is due to a temporary modification of the part affected, not, as is generally thought, in consequence of the deposition of an egg by the insect, but of the injection of a poisonous substance which has the effect of stimulating the protoplasm to develop a gall instead of normal

structure. If this be so, it may justifiably be inferred that both normal and abnormal morphological features may be due to the presence of enzymatic substances secreted by the protoplasm that determine the course of development. At any rate this hypothesis suggests an explanation of many hitherto inexplicable facts. For instance, it has been pointed out in the article on the reproduction of plants that the effect of the fertilization of the female cell in the ovule of a phanerogam is not confined to the female cell, but extends more or less widely outside it, inducing growth and tissue-change. The ovule develops into the seed; and the gynaeceum and even more remote parts of the flower, develop into the fruit. The facts are familiar, but there is no means of explaining them. In the light of Sachs's theory the interpretation is this, that the act of fertilization causes the formation in the female cell of substances which are transmitted to adjacent structures and stimulate them to further development.

LITERATURE.—As the scope of this article limits it to the general principles of the morphology of plants, comparatively few facts have been adduced. Full morphological and organographical details are given in the articles on the various groups of plants, such as those on the Algae, Bryophyta, Pteridophyta, Angiosperms, Gymnosperms, &c. The following works may also be consulted. Schimper, *Plant-Geography* (Clarendon Press, Oxford); Goebel, *Organography* (Clarendon Press, Oxford); Bower, *The Origin of a Land-Flora* (Macmillan); Beyerinck, "Ueber Coccidien," (*Bot. Zeitung*, 1888). (S. H. V.)

DISTRIBUTION OF PLANTS

Common experience shows that temperature is the most important condition which controls the distribution of plants. Those of warmer countries cannot be cultivated in British gardens without protection from the rigours of winter; still less are they able to hold their own unaided in an unfavourable climate. Temperature, then, is the fundamental limit which nature opposes to the indefinite extension of any one species. Buffon remarked "that the same temperature might have been expected, all other circumstances being equal, to produce the same beings in different parts of the globe, both in the animal and vegetable kingdoms." Yet lawns in the United States are destitute of the common English daisy, the wild hyacinth of the woods of the United Kingdom is absent from Germany, and the foxglove from Switzerland. We owe to Buffon the recognition of the limitation of groups of species to regions separated from one another by "natural barriers." When by the aid of man they surmount these, they often dominate with unexpected vigour the native vegetation amongst which they are colonists. The cardoon and milk thistle, both European plants, cover tracts of country in South America with impenetrable thickets in which both man and beast may be hopelessly lost. The watercress blocks the rivers of New Zealand into which it has been introduced from Europe. The problem, then, which plant-distribution presents is twofold: it has first to map out the earth's surface into "regions" or "areas of vegetation," and secondly to trace the causes which have brought them about and led to their restriction and to their mutual relations.

The earliest attempts to deal with the first branch of the inquiry may be called physiognomical. They endeavoured to define "aspects of vegetation" in which the "forms" exhibited an obvious adaptation to their climatic surroundings. This has been done with success and in great detail by Grisebach, whose *Vegetation der Erde* from this point of view is still unsurpassed. With it may be studied with advantage the unique collection at Kew of pictures of plant-life in its broadest aspects, brought together by the industry and munificence of Miss Marianne North. Grisebach declined to see anything in such "forms" but the production by nature of that which responds to external conditions and can only exist as long as they remain unchanged. We may agree with Schimper that such a point of view is obsolete without rejecting as valueless the admirable accumulation of data of which it admittedly fails to give any rational explanation. A single example will be sufficient to illustrate this. The genus *Senecio*, with some 1000 species, is practically cosmopolitan. In external habit these exhibit

adaptations to every kind of climatic or physical condition: they may be mere weeds like groundsel or ragworts, or climbers masquerading like ivy, or succulent and almost leafless, or they may be shrubs and even trees. Yet throughout they agree in the essential structure of their floral organs. The cause of such agreement is, according to Grisebach, shrouded in the deepest obscurity, but it finds its obvious and complete explanation in the descent from a common ancestor which he would unhesitatingly reject.

From this point of view it is not sufficient, in attempting to map out the earth's surface into "regions of vegetation," to have regard alone to adaptations to physical conditions. We are compelled to take into account the actual affinity of the plants inhabiting them. Anything short of this is merely descriptive and empirical, and affords no rational basis for inquiry into the mode in which the distribution of plant-life has been brought about. Our regions will not be "natural" unless they mark out real discontinuities both of origin and affinity, and these we can only seek to explain by reference to past changes in the earth's history. We arrive thus at "the essential aim of geographical botany," which, as stated by Schimper, is "an inquiry into the causes of differences existing among the various floras." To quote further: "Existing floras exhibit only one moment in the history of the earth's vegetation. A transformation which is sometimes rapid, sometimes slow, but always continuous, is wrought by the reciprocal action of the innate variability of plants and of the variability of the external factors. This change is due partly to the migrations of plants, but chiefly to a transformation of the plants covering the earth." This transformation is due to new characters arising through variation. "If the new characters be useful, they are selected and perfected in the descendants, and constitute the so-called 'adaptations' in which the external factors acting on the plants are reflected." The study of the nature of these adaptations, which are often extremely subtle and by no means merely superficial, is termed *Ecology* (see above).

The remark may conveniently find its place here that plants which have reached a high degree of adaptive specialization have come to the end of their tether: a too complicated adjustment has deprived them of the elasticity which would enable them to adapt themselves to any further change in their surroundings, and they would pass away with conditions with which they are too inextricably bound up. Vast floras have doubtless thus found their grave in geologic change. That wrought by man in destroying forests and cultivating the land will be no less effective, and already specimens in our herbaria alone represent species no longer to be found in a living state. Extinction may come about indirectly and even more surely. This is easy to happen with plants dependent on insects for their fertilization. Kronfeld has shown that aconites are dependent for this on the visits of a *Bombus* and cannot exist outside the area where it occurs.

The actual and past distribution of plants must obviously be controlled by the facts of physical geography. It is concerned with the land-surface, and this is more symmetrically disposed than would at first sight appear from a glance at a map of the world. Lyell points out that the eye of an observer placed above a point between Pembroke and Wexford, lat. 52° N. and long. 6° W., would behold at one view the greatest possible quantity of land, while the opposite hemisphere would contain the greatest quantity of water. The continental area is on one side of the sphere and the oceanic on the other. Love has shown (*Nature*, Aug. 1, 1907, p. 328) that this is the result of physical causes and that the existence of the Pacific Ocean "shows that the centre of gravity of the earth does not coincide with the centre of figure." One half of the earth has therefore a greater density than the other. But "under the influence of the rotation the part of greater density tend to recede further from the axis than the parts of less density . . . the effect must be to produce a sort of furrowed surface." The furrows are the great ocean basins, and these would still persist even if the land surface were enlarged to the 1,000 fathoms contour. These considerations

preclude the possibility of solving difficulties in geographical distribution by the construction of hypothetical land-surfaces, an expedient which Darwin always stoutly opposed (*Life and Letters*, ii. 74-78). The furrowed surface of the earth gives the land-area a star-shaped figure, which may from time to time have varied in outline, but in the main has been permanent. It is eccentric as regards the pole and sends tapering extensions towards the south. Sir George Darwin finds a possible explanation of these in the screwing motion which the earth would suffer in its plastic state. The polar regions travelled a little from west to east relatively to the equatorial, which lagged behind.

The great primary divisions of the earth's flora present themselves at a glance. The tropics of Cancer and Capricorn cut off with surprising precision (the latter somewhat less so) the tropical from the north and south temperate zones. The north temperate region is more sharply separated from the other two than the south temperate region from the tropical.

I. NORTH TEMPERATE REGION (*Holarctic*).—This is the largest of all, circumpolar, and but for the break at Bering Straits, would be, as it has been in the past, continuous in both the old and new worlds. It is characterized by its needle-leaved Coniferae, its catkin-bearing (Amentaceae) and other trees, deciduous in winter, and its profusion of herbaceous species.

II. SOUTH TEMPERATE REGION.—This occupies widely separated areas in South Africa, Australia, New Zealand and South America. These are connected by the presence of peculiar types, Proteaceae, Restiaceae, Rutaceae, &c., mostly shrubby in habit and on the whole somewhat intolerant of a moist climate. Individual species are extremely numerous and often very restricted in area.

III. TROPICAL REGION.—This is characterized by the presence of gigantic Monocotyledons, palms, Musaceae and bamboos, and of evergreen polytapal trees and figs. Herbaceous plants are rare and mostly epiphytic.

A consideration of these regions makes it apparent that they are to a large extent adaptive. The boreal is cold, the austral warm, and the tropical affords conditions of heat and moisture to which the vegetation of the others would be intolerant. If we take with Drude the number of known families of flowering plants at 240, 92 are generally dispersed, 17 are more restricted, while the remainder are either dominant in or peculiar to separate regions. Of these 40 are boreal, 22 austral and 69 tropical. If we add to the latter figure the families which are widely dispersed, we find that the tropics possess 161 or almost exactly two-thirds of the large groups comprised in the world's vegetation. M. Casimir de Candolle has made an independent investigation, based on Hooker and Bentham's *Genera Plantarum*. The result is unfortunately (1910) unpublished, but he informs the present writer that the result leads to the striking conclusion: "La végétation est un phénomène surtout intertropical, dont nous ne voyons plus que restes affaiblis dans nos régions tempérées." In attempting to account for the distribution of existing vegetation we must take into account palaeontological evidence. The results arrived at may be read as a sequel to the article on PALAEOBOTANY.

The vegetation of the Palaeozoic era, till towards its close, was apparently remarkably homogeneous all over the world. It was characterized by arborescent vascular Cryptogams and Gymnosperms of a type (Cordaiteae) which have left no descendants beyond it. In the southern hemisphere the Palaeozoic flora appears ultimately to have been profoundly modified by a lowering of temperature and the existence of glacial conditions over a wide area. It was replaced by the *Glossopteris* flora which is assumed to have originated in a vast continental area (Gondwana land), of which remnants remain in South America, South Africa and Australia.

The *Glossopteris* flora gradually spread to the northern hemisphere and intermingled with the later Palaeozoic flora which still persisted. Both were in turn replaced by the Lower Mesozoic flora, which again is thought to have had its birth in the hypothetical Gondwana land, and in which Gymnosperms played the leading part formerly taken by vascular Cryptogams. The abundance of Cycadean plants is one of its most striking features. They attained the highest degree of structural complexity in the Bennettitaceae, which have been thought even to foreshadow a floral organization. Though now on the way to extinction, Cycadeae are still widely represented in the southern hemisphere by genera which, however, have no counterpart in the Mesozoic era. Amongst Conifers the archaic genera, *Ginkgo* and *Araucaria* still persist. Once widely distributed in the Jurassic period throughout the world, they are now dying out: the former is represented by the solitary maiden-hair tree of China and Japan; the latter by some ten species confined to the southern hemisphere, once perhaps their original home. With them may be associated the anomalous *Sciadopitys* of Japan.

So far the evolution of the vegetable kingdom has proceeded without any conspicuous break. Successive types have arisen in ascending sequence, taken the lead, and in turn given way to others. But

the later period of the Mesozoic era saw the almost sudden advent of a fully developed angiospermous vegetation which rapidly occupied the earth's surface, and which it is not easy to link on with any that preceded it. The closed ovary implies a mode of fertilization which is profoundly different, and which was probably correlated with a simultaneous development of insect life. This was accompanied by a vegetative organization of which there is no obvious foreshadowing. As Clement Reid remarked: "World-wide floras, such as seem to characterize some of the older periods, have ceased to be, and plants are distributed more markedly according to geographical provinces and in climatic zones." The field of evolution has now been transferred to the northern hemisphere. Though Angiosperms become dominant in all known plant-bearing Upper Cretaceous deposits, their origin dates even earlier. In Europe Heer's *Populus primaeva* from the Lower Cretaceous in Greenland was long accepted as the oldest dicotyledonous plant. Other undoubted Dicotyledons, though of uncertain affinity, of similar age have now been detected in North America. The Cenomanian rocks of Bohemia have yielded remains of a sub-tropical flora which has been compared with that existing at present in Australia. Upper Cretaceous formations in America have yielded a copious flora of a warm-temperate climate from which it is evident that at least the generic types of numerous not closely related existing dicotyledonous trees had already come into existence. It may be admitted that the identification of fragmentary leaf-remains is at most precarious. Even, however, with this reservation, it is difficult to resist the mass of evidence as a whole. And it is a plausible conjecture that the vegetation of the globe had already in its main features been constituted at this period much as it exists at the present moment. There were oaks, beeches (scarcely distinguishable from existing species), birches, planes and willows (one closely related to the living *Salix candida*), laurels, represented by *Sassafras* and *Cinnamomum*, magnolias and tulip trees (*Liriodendron*), myrtles, *Liquidambar*, *Diospyros* and ivy. This is a flora which, thinned out by losses, practically exists to this day in the southern United States. And one essentially similar but adapted to slightly cooler conditions existed as far north as the latitude of Greenland.

The tertiary era opens with a climate in which during the Eocene period something like existing tropical conditions must have obtained in the northern hemisphere. The remains of palms (*Sabal* and *Nipa*) as well as of other large-leaved Monocotyledons are preserved. *Sepoia* (which had already appeared in the American Upper Cretaceous) and the deciduous cypress (*Taxodium distichum*) are found in Europe. Starkie Gardner has argued with much plausibility that the Tertiary floras which have been found in the far north must have been of Eocene age. That of Grinnell Land in lat. 81° consisted of Conifers (including the living spruce), poplars and willows, such as would be found now 25° to the south. The flora of Disco Island in lat. 70° contained *Sepoia*, planes, maples and magnolias, and closely agrees with the Miocene flora of central Europe. Of this copious remains have been found in Switzerland and have been investigated with great ability by O. Heer. They point to cooler conditions in the northern hemisphere; palms and tropical types diminish; deciduous trees increase. *Sepoia* and the tulip-tree still remain; figs are abundant; laurels are represented by *Sassafras* and camphor; herbaceous plants (Ranunculaceae, Cruciferae, Umbelliferae) are present, though, as might be expected, only fragmentarily preserved.

We may draw with some certainty the conclusion that a general movement southward of vegetation had been brought about. While Europe and probably North America were occupied by a warm temperate flora, tropical types had been driven southward, while the adaptation of others to arctic conditions had become accentuated. A gradual refrigeration proceeded through the Pliocene period. This was accompanied in Europe by a drastic weeding out of Miocene types, ultimately leaving the flora pretty much as it now exists. This, as will be explained, did not take place to anything like the same extent in North America, the vegetation of which still preserves a more Miocene facies. *Torreya*, now confined to North America and Japan, still lingered, as did *Ocotea*, now profusely developed in the Canaries, the evergreen oaks, so characteristic of the Miocene, were reduced to the existing *Quercus ilex*. At the close of the Pliocene the European flora was apparently little different from that now existing, though some warmer types such as the water-chestnut (*Tropa natans*) had a more northern extension. The glacial period effected in Europe a wholesale extermination of temperate types accompanied by a southern extension of the arctic flora. But its operation was in great measure local. The Pliocene flora found refuges in favoured localities from which at its close the lowlands were restocked while the arctic plants were left behind on the mountains. During the milder interglacial period some southern types, such as *Rhododendron ponticum*, still held their own, but ultimately succumbed.

The evidence which has thus been briefly summarized, points unmistakably to the conclusion that existing vegetation originated in the northern hemisphere and under climatic conditions corresponding to what would now be termed sub-tropical. It occupied a continuous circumpolar area which allowed free communication between the old and new worlds. The gradual differentiation of their floras

has been brought about rather by extermination than specialization, and their distinctive facies by the development and multiplication of the surviving types.

The distribution of mountain barriers in the Old and New Worlds is in striking contrast. In the former they run from east to west; in the latter from north to south. In the Old World the boreal zone is almost sharply cut off and afforded no means of escape for the Miocene vegetation when the climate became more severe. Thus in the Mediterranean region the large groups of palms, figs, myrtles and laurels are each only represented by single surviving species. The great tropical family of the Gesneriaceae has left behind a few outliers: *Ramondia* in the Pyrenees, *Haberlea* in the Balkans, and *Jankaea* in Thessaly; the Pyrenees also possess a minute *Dioscorea*, sole European survivor of the yams of the tropics.

In North America there is no such barrier: the Miocene flora has been able to escape by migration the fluctuations of climate and to return when they ameliorated. It has preserved its characteristic types, such as *Magnolia*, *Liriodendron*, *Liquidambar*, *Torreya*, *Taxodium* and *Sequoia*. While it has been customary to describe the Miocene flora of Europe as of a North American type, it would be more accurate to describe the latter as having in great measure preserved its Miocene character.

If mountains serve as barriers which arrest the migration of the vegetation at their base, their upper levels and summits afford lines of communication by which the floras of colder regions in the northern hemisphere can obtain a southern extension even across the tropics. They doubtless equally supply a path by which southern temperate types may have extended northwards. Thus the characteristic assemblage of plants to which Sir Joseph Hooker has given the name Scandinavian "is present in every latitude of the globe, and is the only one that is so" (*Trans. Linn. Soc.* xxiii. 253). In the mountains of Peru we find such characteristic northern genera as *Draba*, *Alchemilla*, *Saxifraga*, *Valeriana*, *Genkiana* and *Bartsia*. High elevations reproduce the physical conditions of high latitudes. The aqueous vapour in the atmosphere is transparent to luminous but opaque to obscure heat-rays. The latter are retained to warm the air at lower levels, while it remains cold at higher. It results that besides a horizontal distribution of plants, there is also an altitudinal: a fact of cardinal importance, the first observation of which has been attributed to Tournefort.

Speaking generally, all plants tend to exhaust particular constituents of the soil on which they grow. Nature therefore has provided various contrivances by which their seeds are disseminated beyond the actual position they occupy. In a large number of cases these only provide for migration within sufficient but narrow limits; such plants would be content to remain local. But other physical agencies come into play which may be briefly noticed. The first of these is wind: it cannot be doubted that small seeds can be swept up like dust and transported to considerable distances. This is certainly the case with fern-spores. The vegetation of Krakatoa was completely exterminated in 1883 by a thick coat of red-hot pumice. Yet in 1886 Treub found that it was beginning to cover itself again with plants, including eleven species of ferns; but the nearest source of supply was 10 m. distant. Seeds are carried with more facility when provided with plumes or wings. Treub found on Krakatoa four species of composites and two grasses. Water is another obvious means of transport. The littoral vegetation of coral islands is derived from sea-borne fruits. The seeds of West Indian plants are thrown on the western shores of the British Isles, and as they are capable of germination, the species are only prevented from establishing themselves by an uncongenial climate. Travers picked up a seed of *Edwardia* in the Chatham Islands, evidently washed ashore from New Zealand (*Linn. Soc. Journ.* ix. 1865). Rivers bring down the plants of the upper levels of their basins to the lower: thus species characteristic of the chalk are found on the banks of the Thames near London. Birds are even more effective than wind in transporting seeds to long distances. Seeds are carried in soil adhering to their feet and plumage, and aquatic plants have in consequence for the most part an exceptionally wide range. Fruit-pigeons are an effective means of transport in the tropics by the undigested seeds which they void in their excrement. Quadrupeds also play their part by carrying seeds or fruits entangled in their coats. *Xanthium spinosum* has spread from the Russian steppes to every stock-raising country in the world, and in some cases has made the industry impossible. Even insects, as in the case of South African locusts, have been found to be a means of distributing seeds.

The primary regions of vegetation, already indicated, and their subordinate provinces may now be considered more in detail.

I. NORTH TEMPERATE REGION.—Many writers on the distribution of animals prefer to separate this into two regions of "primary rank": the Palearctic and the Nearctic. But to justify such a division it is necessary to establish either an exclusive possession or a marked predominance of types in the one which are correspondingly deficient in the other. This cannot apparently be done for insects or for birds; Newton accordingly unites the two into the Holarctic region. It equally fails for plants. To take, for example, one of the most characteristic features of the Palearctic region, its catkin-bearing deciduous trees: in North America we find precisely the same genera

as in the Old World—oaks, chestnuts, beeches, hazels, hornbeams, birches, alders, willows and poplars. Or to take the small but well-defined group of five-leaved pines, all the species of which may be seen growing side by side at Kew under identical conditions: we have the Weymouth pine (*Pinus Strobus*) in eastern North America, *P. monticola* and the sugar pine (*P. Lambertiana*) in California, *P. Avicennae* in Mexico, the Avella pine (*P. Cembra*) in Switzerland and Siberia, *P. Peuce* in Greece, the Bhutan pine (*P. exaltata*) in the Himalayas, and two other species in Japan. Amongst broad-leaved trees *Juglans* has a similar Holarctic range, descending to the West Indies; so has *Asculus*, were it not lacking in Europe; it becomes tropical in South America and Malaya. If we turn to herbaceous plants, Hemsley has pointed out that of the thirteen genera of Ranunculaceae in California, eleven are British.

While the tropics preserve for us what remains of the pre-Tertiary or, at the latest, Eocene vegetation of the earth, which formerly had a much wider extension, the flora of the North Temperate region is often described as the survival of the Miocene. Engler therefore calls it Arcto-Tertiary. We must, however, agree with Starkie Gardner that it is only Miocene as regards its present position, which was originally farther north, and that its actual origin was much earlier. There has been in effect a successive shifting of zones of vegetation southwards from the pole. Their distinctive and adaptive characteristics doubtless began to be established as soon as the phanerogamic flora was constituted. There is no reason to suppose that the peculiarities of the arctic flora are more modern than those of any other, though there is no fossil evidence to prove that it was not so.

The North Temperate region admits of subdivision into several well-marked sub-regions. The general method by which this is effected in this and other cases is statistical. As A. de Candolle, however, points out, exclusive reliance on this may be misleading unless we also take into account the character and affinities of the plants dealt with (*Geogr. Bot.* i. 1166). The numerical predominance of certain families or their absence affords criteria for marking out boundary lines and tracing relationships. The analysis of the flora of the British Isles will afford an illustration. This was first attempted in 1835 by H. C. Watson, and his conclusions were enforced ten years later by Edward Forbes, who dealt also with the fauna. Watson showed that Scotland primarily, and to a less extent the north of England, possessed species which do not reach the south. Such are the crowberry (*Empetrum nigrum*), *Trientalis europæa*, *Rubus saxatilis* and the globe-flower (*Trollius europæus*). He further found that there was an element which he termed "boreal . . . in a more intense degree," which amounted to about "a fifteenth of the whole flora." This was not confined to the north but may occur on the mountains of England and Wales: *Salix herbacea*, *Silene acaulis* and *Dryas octopetala* will serve as examples. Even so small an area as that of Britain illustrates what has already been pointed out, that the species of a flora change both with latitude and altitude. Watson further brought out the striking fact that the west and east of Britain each had species peculiar to it; the former he characterized as Atlantic, the latter as Germanic. The Cornish heath (*Erica vagans*) and the maiden-hair fern (*Adiantum Capillus-Veneris*) may serve as instances of the one, the man-orchis (*Aceras anthropophora*) and *Reseda lutea* of the other. Ireland illustrates the same fact. It possesses about 1000 species, or about two-thirds the number of Britain. On its western shores there are some twenty, such as *Saxifraga umbrosa*, *Erica mediterranea* and *Arbutus unedo*, which are not found in Britain at all. The British Phanerogamic flora, it may be remarked, does not contain a single endemic species, and 38% of the total number are common to the three northern continents.

The analysis of larger areas yields results of the same kind. Within the same region we may expect to find considerable differences as we pass from one meridian to another. Assuming that in its circum-polar origin the North Temperate flora was fairly homogeneous, it would meet in its centrifugal extension with a wide range of local conditions; these would favour the preservation of numerous species in some genera, their greater or less elimination in others. Thus comparing the Nearctic and Palearctic floras we find striking differences overlying the points of agreement already indicated. The former is poor in Cruciferae, Caryophyllaceae, Umbelliferae, Primulaceae and Labiatae; but for the occurrence of *Calluna* in Newfoundland it would have no heaths. On the other hand, it is rich in Compositae, especially *Solidago* and *Aster*, Polemoniaceae, Aclepiadaceae, Hydrophyllaceae and Cyperaceae, and it has the endemic *Sarracenia*, type of a family structurally allied to poppies, of which of the remaining genera *Darlingtonia* is Californian, and *Heliophora* Venezuelan. These distinctions led Sir Joseph Hooker to claim for the two divisions the rank of primary regions. Darwin doubted, however, whether they ought to be separated (*Life*, iii. 230). Lyell, discussing the facts of zoological distribution, admits that "the farther we go north . . . the more the discordance in genera and species diminishes" (*Principles*, ii. 340); and Hemsley finds that not less than 75% of the genera in the flora of eastern North America "are represented in the old world," and, according to Asa Gray, 50% in Europe.

Latitudinally the region subdivides naturally into several well-marked sub-regions which must be briefly discussed.

1. The *Arctic-Alpine* sub-region consists of races of plants belonging originally to the general area, and recruited by subsequent additions which have been specialized in low stature and great capacity of endurance to survive long dormant periods, sometimes even unbroken in successive years by the transitory activity of the brief summer. It is continuous round the pole and roughly is bounded by the arctic circle. Mature seeds are highly tolerant of cold and have been shown to be capable of withstanding the temperature even of liquid hydrogen. Arctic plants make their brief growth and flower at a temperature little above freezing-point, and are dependent for their heat on the direct rays of the sun. Characteristic representatives are *Papaver nudicaule*, *Saxifraga oppositifolia*, which forms a profuse carpet, and *Dryas octopetala*. Such plants perhaps extend to the most northern lands at present known. On May 30th, in Ward Hunt's Island, lat. 83° 5', Sir George Nares found that "vegetation was fairly represented as regards quantity in the poppy, saxifrage and small tufts of grass." We may compare this with extreme alpine conditions: on a spot above the Aletsch glacier at a height of 10,700 ft. Ball found the temperature one inch below the surface to be 83°, and he collected "over forty species in flower." Taking the whole arctic flora at 762 species, Hooker found that 616 occurred in arctic Europe, and of these 586 are Scandinavian. Beyond the arctic circle some 200, or more than a quarter, are confined to the mountains of the northern hemisphere and of "still more southern regions." This led Hooker to the striking observation already quoted. The arctic flora contains no genus that is peculiar to it, and only some fifty species that are so. Christ has objected to terming the arctic flora Scandinavian, but the name implies nothing more than that Scandinavia has been its chief centre of preservation.

A detailed examination of mountain floras shows that a large local element is present in each besides the arctic. The one is in fact the result of similar physical conditions to that which has produced the other. Thus *Saxifraga cernua* is regarded as an alpine form of the lowland *S. granulata*. Comparing the Alps with the Pyrenees, according to Ball, each has about half its flora common to the other: "the Alps have 172 endemic species and at least 15 genera that are not found in the Pyrenees, while the latter range counts about 100 endemic species with several (six or seven) genera not found in the Alps." Drude has accordingly suggested the substitution of the term "High-mountain floras" for Alpine, which he regards as misleading. Its meaning has, however, become synonymous and is consecrated by usage.

The repetition of the same species in the arctic regions and in the high mountains of the North Temperate region is generally attributed to the exchange which took place during the glacial period. This was first suggested by Edward Forbes in 1846, though the idea had earlier suggested itself to Darwin (*Life*, l. 88). It took place southwards, for the arctic flora is remarkably uniform, and, as Chodat points out, it shows no evidence of having been recruited from the several mountain floras. That the arctic flora was driven south into Central Europe cannot be contested in the face of the evidence collected by Nathorst from deposits connected with the boulder-clay. And Reid has shown that during the glacial period the existing flora was replaced by an arctic one represented by such plants as *Salix polaris*, *S. herbacea*, *S. reticulata* and *Betula nana*. At the same time the then existing alpine floras descended to lower levels, though we may agree with Ball that they did not necessarily become extinct at higher ones as long as any land-surface remained uncovered by ice. At the close of the glacial period the alpine floras retreated to the mountains accompanied by an arctic contingent, though doubtless many species of the latter, such as *Salix polaris*, failed to establish themselves. Christ, while admitting an ancient endemic element, such as *Campanula excisa* in the arctic-alpine flora of Europe, objects that a Scandinavian colonization could not furnish such characteristic plants as the larch and edelweiss. He traces the original home of the bulk of existing alpine plants to northern Asia, the mountains of which appear to have escaped glaciation. At the close of the glacial epoch the north Asiatic flora spread westwards into Europe and intermingling with the surviving vegetation. Some species, such as *Anemone alpina*, which are wanting in the Arctic flora of the Old World, he thinks must have reached Europe by way of Greenland from north-east America.

2. The *Intermediate sub-region* comprises the vegetation of the large area occupied by the steps of the Old World, the prairies of the new and the forest region of both. The former support a copious herbaceous flora, the characteristics of which in the Old and New Worlds have been already briefly summarized. In the former that of Europe and of Central Asia are continuous. Of species common to the two, Maximowicz finds that Manchuria possesses 40% and scarcely less than are endemic. Of a collection of about 800 species made in that country by Sir Henry James nearly a third are British. This confirms the theory of Christ that Europe was restocked mainly from Asia after the close of the glacial epoch, the south being closed to it. In the new world no southern barriers existed and it is more difficult to draw the line between contiguous sub-regions.

The dominant characteristics of the arboreal vegetation are, besides deciduous and amerciferous trees, Coniferae, especially the more recent tribe of Abietineae—pines, silver-firs, hemlocks, spruces and larches, of which, unlike the older types, no representative

crosses the tropic. The prominent deciduous trees of Europe appear to be of eastern origin, and the progress of western migration has continued to historic times. The evidence of the peat bogs shows that the Scots fir, which is now extinct, was abundant in Denmark in the Roman period. It was succeeded by the sessile-fruited oak, which was in turn supplanted by the pedunculate form of the same tree. *Quercus Robur* has left no trace in the Tertiary deposits of Europe and it is most nearly allied to east Asiatic species. The oak in turn has been almost superseded in Denmark by the beech, which, if we may trust Julius Caesar, had not reached Britain in his time, though it existed there in the pre-glacial period, but is not native in either Scotland or Ireland. Its eastern limit in Europe is a line from Königsberg to the Caucasus; thence through China it is continued by varietal forms to Japan. It has a solitary representative in North America.

Broadly speaking, the American portion of the sub-region consists of an Atlantic and Pacific forest area and an intervening non-forest one, partly occupied by the Rocky Mountains, partly by intervening plains. Its arboreal vegetation is richer both in genera and species than that corresponding to it in the Old World. Glacial climatic has been less severe, or rather there has been, at any rate on the Atlantic side, an unimpeded return of Miocene types. The Atlantic area has five magnolias, a tulip tree, an Anonaceae (*Asimina*), two Ternstroemiaceae (*Swarbia* and *Gordonia*), *Liquidambar*, *Vitis* (the fox-grape, *V. Labrusca*, reappears in Japan), and others; an assemblage, as long ago pointed out by Asa Gray, which can only be paralleled in the Chino-Japanese region, another centre of preservation of Miocene types. All these are wanting in the Pacific area, though there are indications in its gold-bearing gravels that it once possessed them. On the other hand, Japan is rich in coniferous types beyond any country except Japan" (A. Gray), but till we reach California these are boreal in type. The Atlantic flora has also numerous oaks and maples, signalled by their autumnal coloration. These were abundant in Tertiary Europe, as they are now in Japan, and represent perhaps a cooler element in the flora than that indicated above. The highlands of Central America and the West Indies have preserved a number of Chino-Japanese types—*Baccharis*, *Deutzia*, *Abelia*, &c.—not met with elsewhere in the New World.

3. The *Mediterranean-Oriental sub-region* contrasts no less vividly with the Intermediate than the Arctic-Alpine. It includes the Azores and Canaries, the Mediterranean basin, northern Africa as far as the Atlas and Sahara, Asia Minor, Persia and the countries eastward as far as Sind, being bounded to the north by the mountains which run from the Caucasus to the Hindu-Kush. Its extreme richness in number of species (it comprises six-sevenths of the European flora) and the extremely restricted areas of many of them point to a great antiquity. The Mediterranean basin has been a centre of preservation of Miocene vegetation: the olivander is said to have been found in local deposits of even earlier age, and the holm oak (*Quercus Ilex*) is the living representative of a Miocene ancestor. Extensions of the flora occur southwards of the high mountains of tropical Africa; *Adenocarpus*, a characteristic Mediterranean genus, has been found on Kilimanjaro and 2000 m. distant on the Cameroons. Two British plants may be added which both reach North Africa: *Senecio* *eximius* extends from Abyssinia to the Cameroons and southwards to Cape Colony and Madagascar; *Samolus Eburni* reaches Uganda. The Mediterranean, however, has apparently been a barrier to the southward passage of the arctic-alpine flora which is totally wanting on the Atlas. The vegetation of the sub-region is rich in shrubs: myrtle, bay, *Gistus*, *Pistacia*, *Arbutus*, heaths in its western portion, and the ground-palm (*Chamaerops*). It is even richer in more herbaceous plants, especially of a hot summer; giant Umbelliferae (such as *Ferula*) are especially characteristic and yield gum-resins which have long been reckoned valuable. Of the 1000 known species of *Astragalus* it possesses 800. Evergreen oaks and Conifers form the forests. Asia Minor has a *Liquidambar*. The Argan tree (*Argania Sideroxylon*), which forms forests in Morocco, is a remarkable survivor of a tropical family (Sapotaceae). Amongst Conifers *Cedrus* is especially noteworthy; it is represented by geographical races in the north-west Himalaya, in Syria, Cyprus and North Africa.

This well-marked sub-region has a deeper interest than the botanical. It has been the cradle of civilization, and to it is due the majority of cultivated plants. Such are the date in Mesopotamia (a second species of *Phoenix* occurs in the Canaries); most European fruits, e.g. the vine, fig, mulberry, cherry, apricot, walnut; peas, e.g. the bean, pea and lentil; pot-herbs, e.g. lettuce, endive, beet, radish, cress; cereals; and fodder plants such as lucerne and carob.

4. The *Chino-Japanese sub-region*.—Of the vegetation of China till recently very little has been known. In 1873 Ehren pointed out that the Himalayan ariflora extended into north-west China and established the Himo-Chinese sub-region. Shortly afterwards the collections of Prejwalski confirmed it for the flora. And we now know that, excluding the southern tropical area, it has the same character throughout the whole of China proper. We may therefore regard the Himalayan flora as a westward extension of the Chinese rather than the latter as a development of the former. Of four genera which Hooker singles out as the largest in Sikkim, in China *Corydalis* has 76 species, *Saxifraga* 58, *Pedicularis* 129, and *Prinos* 77. Of *Rhododendron* there are 134 species. Upwards of 8000

species are known out of a probable total of not less than 12,000, and of these more than half are endemic. The number of species to a genus, 3, is only half that found in other large areas. This aggregation of genera and of endemic species is characteristic of the circumferential portions of the earth's land surface. The expansion of the one and the further advance of the other is arrested. The sub-region is probably sharply cut off from the Intermediate. Maximowicz finds that 40% of the plants of Manchuria are common to Europe and Asia, but the proportion falls sharply to 16% in the case of Japan. Its connexion with the Mediterranean-Oriental sub-region is still more remote. China has no *Cistus* or heath, only a single *Ferula*, while *Astragalus* is reduced to 35 species. There are two species of *Pistacia* and four of *Liquidambar*. The affinity to Atlantic North America is strongly marked as it has long been known to be in Japan. China has 66 species of *Quercus*, 35 of *Vitis*, 2 of *Aesculus*, 42 of *Acer*, 33 Magnoliaceae (including two species of *Liriodendron*), 12 Anonaceae, 71 Ternstroemiaceae (including the tea-plant), and 4 of *Clethra*, which has a solitary western representative in Madras. *Trachycarpus* and *Rhopis* are characteristic palms, and Cycadeae are represented by *Cycas*.

5. The Mexico-American sub-region has as its northern boundary the parallel of lat. 36° as far as New Mexico and then northwards to the Pacific coast as far as lat. 40°. The eastern and western halves are contrasted in climate—the former being moist and the latter dry—and have been distinguished by some zoologists as distinct sub-regions. They are in fact in some degree comparable to sub-regions 3 and 4 in the Old World. The absence of marked natural boundaries makes any precise north and south limitation difficult. But it has been a centre of preservation of the Taxodiaceae, a tribe of Coniferae of great antiquity. *Taxodium* (with single species in China and Mexico) is represented by the deciduous cypress (*T. distichum*), which extends from Florida to Texas. The two species of *Sequoia*, the "Wellingtonia" (*S. gigantea*) and the redwood (*S. sempervirens*), are confined to California. In the eastern forests the prevalence of Magnoliaceae and of *Clethra* and *Rhododendron* continues the alliance with eastern Asia. Florida derives a tropical element from the Antilles. Amongst palms the Corypheae are represented by *Sabal* and *Thrinax*, and there is a solitary *Zamia* amongst Cycads. The western dry areas have the old-world leguminous *Astragalus* and *Prosopis* (Mesquit), but are especially characterized by the northward extension of the new-world tropical *Cactaceae*, *Mammillaria*, *Cereus* and *Opuntia*, by succulent *Amaryllidaceae* such as *Agave* (of which the so-called "American aloe" is a type), and by arborescent Liliaceae (*Yucca*). Amongst palms *Washingtonia*, *Brahea* and *Erythea* (all Corypheae) replace the eastern genera. On the west coast *Cupressus Lawsoniana* replaces the northern *Thuja gigantea*, and a laurel (*Umbellularia* of isolated affinity) forms forests. California and Arizona have each a species of *Platanus*, a dying-out genus. Elsewhere it is only represented by *P. occidentalis*, the largest tree of the Atlantic forests from Maine to Oregon, and by *P. orientalis* in the eastern Mediterranean. Otherwise the Californian flora is entirely deficient in the characteristic features of that of eastern North America. Nor, with perhaps the interesting exception of *Castanopsis chrysophylla*, the solitary representative in the New World of an east Asiatic genus, which ranges from Oregon to California, has it any affinity with the Chino-Japanese sub-region. Its closest connexion is with the South American Andine.

II. THE TROPICAL REGION.—The permanence of continents and great oceans was first insisted upon by J. D. Dana, but, as already stated, has later received support on purely physical grounds. It precludes the explanation of any common features in the dis severed portions of the tropical area of vegetation by lateral communications, and throws back their origin to the remotest geological antiquity. In point of fact, resemblance is in the main confined to the higher groups, such as families and large genera; the smaller genera and species are entirely different. No genus or species of palm, for example, is common to the Old and New Worlds. The ancient broad-leaved Gymnosperm *Gnetum* has a few surviving species scattered through the tropics of both worlds, one reaching Polynesia.

1. African sub-region.—Western Arabia must be added to the African continent, which, with this exception and possibly a former European connexion in the far west, has had apparently from a very early period an almost insular character. Bentham remarks (*Journ. Linn. Soc.* xiii. 492): "Here, more perhaps than in any other part of the globe, in Compositae as in so many other orders, we may fancy we see the scattered remains of ancient races dwindling down to their last representatives." It is remarkable that the characteristic features of the Miocene flora, which in other parts of the world have spread and developed southwards, are conspicuously absent from the African tropical flora. It has no Magnoliaceae, no maples, Pomaceae, or Vacciniaceae, no *Rhododendron* and no Abietineae. Perhaps even more striking is the absence of Cupuliferæ; *Quercus*, in particular, which from Tertiary times has been a conspicuous northern type and in Malayan tropical conditions has developed others which are widely divergent. Palms are strikingly deficient: there are only three out of 79 genera of Arceaceae, and the Corypheae are entirely absent. But including the Mascarene Islands and Seychelles the Boraceae are exclusively African. Aroidae are poorly represented compared with either South

America or Malaya. A peculiar feature in which tropical Africa stands alone is that at least one-fifth and probably more of the species are common to both sides of the continent and presumably stretch right across it. An Indian element derived from the north-east is most marked on the eastern side: the Himalayan *Glossora* will suffice as an example, and of more tropical types *Phoenix* and *Calamus* amongst palms. The forest flora of Madagascar, though including an endemic family *Chaenaceae*, is essentially tropical African, and the upland flora south temperate.

2. The Indo-Malayan sub-region includes the Indian and Malayan peninsulas, Cochin-China and southern China, the Malayan archipelago, and Philippines, with New Guinea and Polynesia; excluding the Sandwich Islands. Probably in point of number of species the preponderant family is Orchideae, though, as Hemsley remarks, they do not "give character to the scenery, or constitute the bulk of the vegetation." In Malaya and eastward the forests are rich in arborescent figs, laurels, myrtles, nutmegs, oaks and bamboos. Dipterocarpeae and Nepenthaceae only extend with a few outliers into the African sub-region. Screw pines have a closer connexion. Compositae are deficient. Amongst palms Arceaceae and Calameae are preponderant. Cycads are represented by *Cycas* itself, which in several species ranges from southern India to Polynesia. In India proper, with a dry climate, grasses and Leguminosae take the lead in the number of species. But it has few distinctive botanical features. In the north-west it meets the Mediterranean-Oriental and in the north-east the Chino-Japanese sub-regions, while south India and Ceylon have received a Malayan contribution. Bengal has no *Cycas*, oaks or nutmegs. Apart from the occurrence of *Cycas*, the Asiatic character of the Polynesian flora is illustrated by the distribution of Meliaceae. C. de Candolle finds that with one exception the species belong to genera represented in one or other of the Indian peninsulas.

3. The South American sub-region is perhaps richer in peculiar and distinctive types than either of the preceding. As in the Indo-Malayan sub-region, epiphytic orchids are probably most numerous in point of species, but the genera and even sub-tribes are far more restricted in their range than in the Old World; 4 sub-tribes with 74 genera of Vandeeae are confined to South America, though varying in range of climate and altitude. Amongst arboreal families Leguminosae and Euphorbiaceae are prominent; *Hevea* belonging to the latter is widely distributed in various species in the Amazon basin, and yields Para and other kinds of rubber. Amongst Rubiaceae, Cinclocheae with some outliers in the Old World have their headquarters at cooler levels. In Brazil the myrtles are represented by "monkey-pots" (Lecythydeae). Nearly related to myrtles are Melastomaceae which, poorly represented in the Old World, have attained here so prodigious a development in genera and species, that Ball looks upon it as the seat of origin of the family. Amongst Ternstroemiaceae, the singular Marcgraviaceae are endemic. So also are the Vochysiaceae allied to the "milkworts." *Cactaceae* are widely spread and both northwards and southwards extend into temperate regions. Screw pines are replaced by the nearly allied Cyclanthaceae. The Amazon basin is the richest area in the world in palms, of which the Coccolaeae are confined to South America, except the coco-nut, which has perhaps spread thence into Polynesia and eastward. The singular shrubby *Amaryllid*, *Velloziaceae*, are common to tropical and South Africa, Madagascar and Brazil; Aroids, of which the tribes are not restricted in their distribution, have two large endemic genera, *Philodendron* and *Anthurium*. Amongst Cycads, *Zamia* is confined to the New World, and amongst Conifers, *Araucaria*, limited to the southern hemisphere, has scarcely less antiquity; *Pinus* reaches as far south as Cuba and Nicaragua.

The flora of the Hawaiian Islands has complicated relations. Out of the 860 indigenous plants, 80% are endemic, but Hillebrand finds that a large number are of American affinity.

III. THE SOUTH TEMPERATE REGION contrasts remarkably with the northern. Instead of large continuous areas, in which local characteristics sometimes blend, it occupies widely dis severed territories in which specialization, intensified by long separation, has mostly effaced the possibility of comparing species and even genera, and compels us to seek for points of contact in groups of a higher order. The resemblances consist, in fact, not so much in the existence of one general facies running through the regions, as in the case with the northern flora, but in the presence of peculiar types, such as those belonging to the families Restiaceae, Proteaceae, Ericaceae, Mutisiaceae and Rutaceae.

1. The South African sub-region has a flora richer perhaps in number of species than any other; and these are often extremely local and restricted in area. It exhibits in a marked degree the density of species which, as already pointed out, is explicable by the arrest of further southern expansion. Hemsley remarks that "the northern genus *Erica*, which covers thousands of square miles in Europe with very few species, is represented by hundreds of species in a comparatively small area in South Africa." There is an interesting connexion with Europe through the so-called Iberian flora. Bentham (*Pres. addr. Linn. Soc.*, 1869, p. 25) points out that "the west-European species of *Erica*, Genisteae, *Lobelia*, *Gladiolus*, &c., are some of them more nearly allied to corresponding Cape species than they are to each other; and many of the somewhat higher races, groups of species and genera, have evidently diverged from stocks

now unrepresented anywhere but in South Africa." This flora extends from Ireland to the Canaries and reappears on the highlands of Angola. On the eastern side the southern flora finds representatives in Abyssinia, including *Protea*, and on the mountains of equatorial Africa, *Calodemonon capense* occurring on Kilimanjaro. This is the most northern representative of the Rutaceae Diomeae, which are replaced in Australia by the Boronaceae. The Proteaceae genus, *Fesera*, occurs in Angola and Madagascar. The characteristic genus *Pelargonium* has a few Mediterranean representatives, and one even occurs in Asia Minor. In all these cases it is a nice question whether we are tracing an ascending or descending stream. Darwin thought that the migration southwards would always be preponderant (*Origin of Species*, 5th ed., 458). Other characteristic features of the flora are the abundance of Compositae, Asclepiadeae, and petaloid Monocotyledons generally, but especially Orchideae (terrestrial species predominating) and Liliaceae. There is a marked tendency towards a succulent habit. The nearly related Ficoideae replace the new-world Cactaceae, but the habit of the latter is simulated by fleshy Euphorbiads and Asclepiads, just as that of *Agave* is by the liliaceous *Aloe*. South Africa has only two palms (*Phoenix* and *Erythea*). In the Gaetaceae *Hebe* possesses a vegetable type whose extraordinary peculiarities make it seem amongst contemporary vegetation much as some strange and extinct animal form would if suddenly endowed with life. Conifers are scantily represented by *Callitris* and *Podocarpus*, which is common to all three sub-regions; and Cycads by the endemic *Encephalartos* and *Stangeria*.

2. The Australian sub-region consists of Australia, Tasmania, New Caledonia and New Zealand, and, though partly lying within the tropic is most naturally treated as a whole. They are linked together by the presence of Proteaceae and of Epacridae, which take the place of the nearly allied hebes in South Africa. The most dominant order in Australia is Leguminosae, including the acacias with leaf-like phyllodes (absent in New Zealand). Myrtaceae comes next with *Eucalyptus*, which forms three-fourths of the forests, and *Melaleuca*; both are absent from New Caledonia and New Zealand; a few species of the former extend to New Guinea and one of the latter to Malaya. Cupuliferae are absent except *Fagus* in Australia and New Zealand. The so-called "oaks" of Australia are *Casuarina*, which also occurs in New Caledonia, but is wanting in New Zealand. The giant rushes *Xanthorrhoea* and *Kingia* are peculiar to Australia. Palms are poorly represented in the sub-region and are of an Indo-Malaya type. Amongst Conifers, *Podocarpus* is found throughout, *Agathis* is common to Australia, New Zealand and New Caledonia; *Aracaria* to the first and last. Of Cycads, Australia and New Caledonia have *Cycas*, and the former the endemic *Macrozamia* and *Bowenia*. The Australian land-surface must be of great antiquity, possibly Jurassic, and its isolation scarcely less ancient. In lower Eocene times its flora appears to have been distinctly related to the existing one. Little confidence can, however, be placed in the identification of Proteaceae or, indeed, of any distinctively Australian plants in Tertiary deposits in the northern hemisphere. The Australian flora has extensions at high levels in the tropics; such exists on Kinalabu in Borneo under the equator. The Proteaceae genus *Hedicia* reaches as far north as China, but whether it is starting or returning must as in other cases be left an open question.

While the flora of New Caledonia is rich in species (3000), that of New Zealand is poor (1400). While so many conspicuous Australian elements are wanting in New Zealand, one-eighth of its flora belongs to South American genera. Especially noteworthy are the Andine *Acaena*, *Gumera*, *Fuchsia* and *Calceolaria*. By the same path it has received a remarkable contribution from the North Temperate region; such familiar genera as *Ranunculus*, *Epilobium* and *Veronica* form more than 9% of the flowering plants. And it is interesting to note that while the tropical forms of *Quercus* failed to reach Australia from Malaya, the temperate *Fagus* crept in by a back door. Three-quarters of the native species are endemic; they seem, however, to be quite unable to resist the invasion of new-comers, and already 600 plants of foreign origin have succeeded in establishing themselves.

3. The Andine sub-region extends from Peru to the Argentine and follows roughly the watershed of the Amazon. In the New World, as already explained, the path of communication between the northern and southern hemispheres has always been more or less open, and the temperate flora of southern America does not exhibit the isolation characteristic of the southern region of the Old World. Taking, however, the Andean flora as typical, it contains a very marked endemic element; Ball finds that half the genera and four-fifths of the species are limited to it; on the other hand, that half the species of Gamopetalae belong to cosmopolitan genera such as *Valeriana*, *Gentiana*, *Bartsia* and *Gnaphalium*. The relation to the other sub-regions is slight. Ericaceae are wholly absent, and it has but a single Epacrid in Fuegia. Proteaceae are more marked in *Guevina* and *Embothrium*. Of Restiaceae, a single *Leptocarpus* has been found in Chile. On the other hand, it is the headquarters of Mutisiaceae, represented in South Africa by such genera as *Oldenburgia* and *Gerbera* and by *Trichocline* in Australia. *Tropaeolum* takes the place of the nearly allied South African *Pelargonium*. There has been an interchange between it and the Mexico-American sub-region, but as usual the northern has been preponderant. *Prosopis* extends

to the Argentine; other characteristic genera are *Oenothera*, *Galdia*, *Collomia*, *Heliotropium* and *Eribrichium*. In the ascending orders may be mentioned—*Larrea*, a small genus of Zygophyllae with headquarters in Paraguay and Chile, of which one species, *L. succulosa*, is the creosote plant of the Colorado desert, where it forms dense scrub; *Acacia*; the Loasaceae, of which *Mentzelia* reaches North America, *Petunia* and *Lippia*. Compositae compose a quarter of the Andean flora, which is a greater proportion than in any in the world. *Baccharis*, with some 250 species, ranges over the whole continent from the Straits of Magellan and, with seven species, to California. Melastomaceae, copiously represented in tropical America, are more feebly so in Peru and wholly wanting in Chile. A few Cactaceae extend to Chile. Of Cupuliferae, *Quercus* in three species only reaches Colombia, but *Fagus*, with only a single one in North America, is represented by several from Chile southwards and thence extends to New Zealand and Tasmania. The Magnoliaceae genus *Drimys*, with a single species in the new world, follows the same track. Bromeliaceae are represented by *Rhodostachys* and the temperate *Psyche*. Palms as usual are few and not nearly related. *Wattinia* occurs in Peru; *Trillium* in Chile with the monotypic *Jubaea*, *Juncus*, also monotypic, is confined to Juan Fernandez. Amongst Coniferae *Podocarpus* is common to this and preceding sub-regions; *Libocedrus* extends from California to New Zealand and New Caledonia; *Fitzroya* is found in Chile and Tasmania; and *Aracaria* in its most familiar species occurs in Chile.

4. The Antarctic-Alpine region is the complement of the Arctic-Alpine, but unlike the latter, its scattered distribution over numerous isolated points of land, remote from great continental areas, from which, during migrations like those attending the glacial period in the northern hemisphere, it could have been recruited, at once accounts for its limited number of species and their contracted range in the world. On the whole, it consists of local species of some widely distributed northern genera, such as *Carex*, *Poa*, *Ranunculus*, &c., with alpine types of strictly south temperate genera, characteristic of the separate localities. The monotypic *Pringlea antiscorbutica*, the "Kerguelen Island cabbage," has no ally in the southern hemisphere, but is closely related to the northern *Cochlearia*.

Such a summary of the salient facts in the geographical distribution of plants sufficiently indicates the tangled fabric of the earth's existing floral covering. Its complexity reflects the corresponding intricacy of geographical and geological evolution.

If the surface of the globe had been symmetrically divided into sea and land, and these had been distributed in bands bounded by parallels of latitude, the character of vegetation would depend on temperature alone; and as regards its aggregate mass, we should find it attaining its maximum at the equator and sinking to its minimum at the poles. Under such circumstances the earth's vegetation would be very different from what it is, and the study of plant distribution would be a simple affair.

It is true that the earth's physical geography presents certain broad features to which plants are adapted. But within these there is the greatest local diversity of moisture, elevation and isolation. Plants can only exist, as Darwin has said, where they *must*, not where they can. New Zealand was poorly stocked with a weak flora; the more robust and aggressive one of the north temperate region was ready at any moment to invade it, but was held back by physical barriers which human aid has alone enabled it to surpass.

Palaeontological evidence conclusively proves that the surface of the earth has been successively occupied by vegetative forms of increasing complexity, rising from the simplest algae to the most highly organized flowering plant. We find the ultimate explanation of this in the facts that all organisms vary, and that their variations are inherited and, if useful, perpetuated. Structural complexity is brought about by the superposition of new variations on preceding ones. Continued existence implies perpetual adaptation to new conditions, and, as the adjustment becomes more refined, the corresponding structural organization becomes more elaborate. Inheritance preserves what exists, and this can only be modified and added to. Thus Asclepiadeae and Orchideae owe their extraordinary floral complexity to adaptation to insect fertilization.

All organisms, then, are closely adapted to their surroundings. If these change, as we know they have changed, the organisms must change too, or perish. In some cases they survive by migration, but this is often prohibited by physical barriers.

These, however, have often protected them from the competition of more vigorous invading races. *Fagus*, starting from the northern hemisphere, has more than held its own in Europe and Asia, but has all but died out in North America, finding conditions favourable for a fresh start in Australasia. The older types of Gymnosperms are inelastic and dying out. Even *Pinus* has found the task of crossing the tropics insuperable.

The whole story points to a general distribution of flowering plants from the northern hemisphere southwards. It confirms the general belief on geological grounds that this was the seat of their development at the close of the Mesozoic era. It is certain that they originally existed under warmer conditions of climate than now obtain, and that progressive refrigeration has supplied a powerful impulse to migration. The tropics eventually became, what they are now, great areas of preservation. The Northern Temperate region was denuded of its floral wealth, of which it only retains a comparatively scanty wreck. High mountain levels supplied paths of communication for stocking the South Temperate region, the floras of which were enriched by adapted forms of tropical types. Such profound changes must necessarily have been accompanied by enormous elimination; the migrating hosts were perpetually thinned by falling out on the way. Further development was, however, not stopped, but in many cases stimulated by migration and settlement in new homes. The northern *Quercus*, arrested at the tropic in the new world, expanded in that of the old into new and striking races. And it cannot be doubted that the profusion of Melastomaceae in South America was not derived from elsewhere, but the result of local evolution. There is some evidence of a returning stream from the south, but as Hooker and A. de Candolle have pointed out, it is insignificant as compared with the outgoing one. Darwin attributes this to the fact that "the northern forms were the more powerful" (*Origin of Species*, 5th ed., p. 458).

The result of migration is that races of widely different origin and habit have had to adapt themselves to similar conditions. This has brought about superficial resemblance in the floras of different countries. At first sight a South African *Euphorbia* might be mistaken for a South American *Cactus*, an *Aloe* for an *Agave*, a *Senecio* for ivy, or a New Zealand *Veronica* for a European *Salicornia*. A geographical botany based on such resemblances is only in reality a study of adaptations. The investigation of these may raise and solve interesting physiological problems, but throw no light on the facts and genetic relationship which a rational explanation of distribution requires. If we study a population and sort it into soldiers, sailors, ecclesiastics, lawyers and artisans, we may obtain facts of sociological value but learn nothing as to its racial origin and composition.

In the attempt that has been made to map out the land surface of the earth, probable community of origin has been relied upon more than the possession of obvious characters. That sub-regions framed on this principle should show inter-relations and some degree of overlapping is only what might have been expected, and, in fact, confirms the validity of the principle adopted. It is interesting to observe that though deduced exclusively from the study of flowering plants, they are in substantial agreement with those now generally adopted by zoologists, and may therefore be presumed to be on the whole "natural."

AUTHORITIES.—A. de Candolle, *La Géographie botanique raisonnée*, (Paris and Geneva, 1855); A. Grisebach, *La Végétation du globe*, transl. by P. de Tchihatchef (Paris, 1875); Engler, *Versuch einer Entwicklungsgeschichte der Pflanzenwelt* (Leipzig, 1879-1882); Oscar Drude, *Manuel de géographie botanique*, transl. by G. Poirault (Paris, 1897); A. F. W. Schimper, *Plant Geography*, transl. by W. R. Fisher, (Oxford, 1903).

PLANUDES, MAXIMUS (c. 1260-1330), Byzantine grammarian and theologian, flourished during the reigns of Michael VIII. and Andronicus II. Palaeologus. He was born at Nicomedia in Bithynia, but the greater part of his life was spent in Constantinople, where as a monk he devoted himself to study

and teaching. On entering the monastery he changed his original name Manuel to Maximus. Planudes possessed a knowledge of Latin remarkable at a time when Rome and Italy were regarded with hatred and contempt by the Byzantines. To this accomplishment he probably owed his selection as one of the ambassadors sent by Andronicus II. in 1327 to remonstrate with the Venetians for their attack upon the Genoese settlement in Pera. A more important result was that Planudes, especially by his translations, paved the way for the introduction of the Greek language and literature into the West.

He was the author of numerous works; notably a Greek grammar in the form of question and answer, like the *Enchiridion* of Moschopolus, with an appendix on the so-called "political" verse; a treatise on syntax; a biography of Aesop and a prose version of the fables; scholia on certain Greek authors; two hexameter poems, one a eulogy of Claudius Ptolemaeus, the other an account of the sudden change of an ox into a mouse; a treatise on the method of calculating in use amongst the Indians (ed. C. J. Gerhardt, Halle, 1865); and scholia to the first two books of the *Arithmetica* of Diophantus. His numerous translations from the Latin included Cicero's *Sonnum Scipionis* with the commentary of Macrobius; Caesar's *Gallia*; Ovid's *Heroides* and *Metamorphoses*; Boetius, *De consolations philosophiae*; Augustine, *De trinitate*. These translations were very popular during the middle ages as textbooks for the study of Greek. It is, however, as the editor and compiler of the collection of minor poems known by his name (see **ANTHOLOGY: Greek**) that he is chiefly remembered.

See Fabricius, *Bibliotheca graeca*, ed. Harles, xi. 682; theological writings in Migne, *Patrologia graeca*, cxlvii; correspondence, ed. M. Treu (1890), with a valuable commentary; K. Krumbacher, *Geschichte der byzantinischen Litteratur* (1897); J. E. Sandys, *Hist. of Class. Schol.* (1906), vol. 1.

PLAQUE, a French term for a small flat plate or tablet, applied particularly to rectangular or circular ornamental plates or tablets of bronze, silver, lead or other metal, or of porcelain or ivory. Small plaques, *plaquettes*, in low relief in bronze or lead, were produced in great perfection in Italy at the end of the 15th and beginning of the 16th centuries, and were usually copies of ancient engraved gems, earlier goldsmith work and the like.

PLASENCIA, a city of Spain and an episcopal see, in the north of the province of Cáceres. Pop. (1900), 8208. Plasencia is situated on the river Jerte, a tributary of the Tagus, and at the foot of the sierras of Bejar and Vera. The place has some interest on account of its fine walls, built in 1197 by Alphonso VIII. of Castile, and its cathedral, begun in 1408, a favourable specimen of the ornate Gothic of its period. The Hieronymite convent of Yuste, the scene of the last years of the emperor Charles V. (1500-1558), is 24 m. east.

PLASSEY (*Palassi*), a village of Bengal on the river Bhagirathi, the scene of Clive's victory of the 23rd of June 1757, over the forces of the nawab Suraj-ud-Dowlah. The fall of Calcutta and the "Black Hole" atrocity led to instant action by the East India Company, and Clive, with as many troops as could be spared, undertook a campaign against the nawab, and soon reoccupied Calcutta. Long and intricate negotiations, or rather intrigues, followed, and at the time of the battle the loyalty of most of the nawab's generals had been effectually undermined, though assistance, active or passive, could hardly be counted on. With this doubtful advantage, Clive, with 1100 European and 2100 native soldiers, and 10 field-pieces, took the field against the nawab, who had 50,000 men, 53 heavy guns, and some French artillery under M. de St Frais. Only the river Bhagirathi separated Clive's little force from the entrenched camp of the enemy, when the English leader, for once undecided, called a council of war. Clive and the majority were against fighting, Major Eyre Coote, of the 39th Foot, and a few others for action. Coote's soldierly advice powerfully impressed Clive, and after deep consideration he altered his mind and issued orders to cross the river. After a fatiguing march, the force bivouacked in a grove near Plassey early on the 23rd. The nawab's host came out of its lines and was drawn up in a huge semicircle almost enclosing the little force in the grove, and St Frais' gunners on the right wing opened fire. Clive replied, and was soon subjected to the converging fire of 50 heavy guns. For hours the unequal fight was maintained,

until a rainstorm stopped it. The English covered up their guns, but the enemy took no such precaution. Mir Mudin, the only loyal general of the nawab's army, thinking that Clive's guns were as useless as his own, made a disastrous cavalry charge upon them; he lost his own life, and his colleagues then had the game in their hands. Mir Jagar persuaded the nawab to retire into the entrenchments. St Frai's stood fast until one of Clive's officers, Major Kilpatrick, successfully drove him in. Clive followed up this success by cannonading the camp at close range. But the rank and file of the native army, ignorant of the treachery of their leaders, made a furious sortie. For a time Clive was hard pressed, but his cool generalship held its own against the undisciplined valour of the enemy, and, noticing Mir Jagar's division in his rear made no move against him, he led his troops straight against the works. After a short resistance, made chiefly by St Frai's, the whole camp fell into his hands. At a cost of 23 killed and 49 wounded this day's work decided the fate of Bengal. The historic grove of mangoes, in which Clive encamped on the previous night, has been entirely washed away by changes in the course of the river; but other relics of the day remain, and a monument has recently been erected.

PLASTER. A mixture of lime, hair and sand, used to cover rough walling of lathwork between timbers (see **PLASTER-WORK**); also a fine white plaster of gypsum, generally known as "plaster of Paris." The word (also as "plaister") is used in medicine of adhesive mixtures employed externally for the protection of injured surfaces, for support of weak muscular or other structures, or as counter-irritants, soothing applications &c. The ultimate derivation of the word is the Gr. *ἔμπλαστον* or *ἐμπλαστον* in the medical sense, from *ἐν*, on, and *πλάσσειν*, to daub or smear.

PLASTER OF PARIS, a variety of calcined gypsum (calcium sulphate) which forms a hard cement when treated with water (see **CEMENT**). The substance obtained its name in consequence of being largely manufactured in the neighbourhood of Paris.

PLASTER-WORK, in building. Plastering is one of the most ancient of handicrafts employed in connexion with building operations, the earliest evidence showing that the dwellings of primitive man were erected in a simple fashion with sticks and plastered with mud. Soon a more lasting and slightly material was found and employed to take the place of mud or slime, and that perfection in the compounding of plastering materials was approached at a very remote period is made evident by the fact that some of the earliest plastering which has remained undisturbed excels in its scientific composition that which we use at the present day. The pyramids in Egypt contain plaster-work executed at least four thousand years ago (probably much earlier) and yet existing, hard and durable, at the present time. From recent discoveries it has been ascertained that the principal tools of the plasterer of that time were practically identical in design, shape and purpose with those used to-day. For their finest work the Egyptians used a plaster made from calcined gypsum just like the "plaster of Paris" of the present time, and their methods of plastering on reeds resemble in every way our "lath, plaster, float and set" work. Hair was introduced to strengthen the "stuff," and the whole finished somewhat under an inch thick. Very early in the history of Greek architecture we find the use of plaster of a fine white lime stucco. Such has been found at Mycenae. The art had reached perfection in Greece more than five centuries before Christ, and plaster was frequently used to cover temples externally and internally, in some cases even where the building was of marble. It formed a splendid ground for decorative painting, which at this period of Grecian history had reached a very high degree of beauty. The temple of Apollo at Bassae, built of yellow sandstone about 470 B.C., is an excellent example. Pavements of thick, hard plaster, stained with various pigments, were commonly laid in Greek temples. The Roman architect Vitruvius, in his book on architecture written about 16 B.C., gives detailed information concerning the methods of making plaster and the manner of using it. "The lime used for stucco," he writes, "should be

of the best quality and tempered a long time before it is wanted for use. The Greeks, besides making their stucco work hard with thin coats of marble-dust plaster polished with chalk or marble, caused the plaster when being mixed to be beaten with wooden staves by a great number of men. Some persons cutting slabs of such plaster from ancient walls use them for tables and mirrors." Pliny the elder tells us that "no builder should employ lime which had not been slaked at least three years," and that "the Greeks used to grind their lime very fine and beat it with pestles of wood." In England the walls of large houses and mansions were formerly plastered above the wainscoting and coloured, while the ornamented plaster ceilings of the time of Henry VIII., Elizabeth and James I., are still the admiration of lovers of the art. Still earlier specimens of the plasterer's skill are extant in the pargeted and ornamented fronts of half-timbered houses. With regard to the smaller buildings, comprising small dwelling-houses and cottages, the general application of plaster is of comparatively late date; for wainscoted walls and boarded ceilings or naked joists alone are frequently found in houses of not more than a century old both in England and on the Continent.

In the more common operations of plastering, comparatively few tools and few materials are required, but the workman efficient in all branches of the craft will possess a very large variety of implements. The materials of the workman are laths, lath nails, lime, sand, hair, plaster of Paris, and a variety of cements, together with various ingredients to form colouring washes, &c.

Wood laths are narrow strips of some straight-grained wood, generally Baltic or American fir, in lengths of from two to four or five feet to suit the distances at which the timbers of a floor or partition are set. Laths are about an inch wide, and are made in three thicknesses: "single" ($\frac{1}{2}$ to $\frac{3}{4}$ in. thick), "lath and a half" ($\frac{3}{4}$ in. thick), and "double" ($\frac{1}{2}$ to $\frac{3}{4}$ in. thick). The thicker laths should be used in ceilings, to stand the extra strain, and the thinner variety in vertical work such as partitions, except where the latter will be subjected to rough usage, in which case thicker laths become necessary. Laths are usually nailed with a space of about $\frac{1}{2}$ in. between them to form a key for the plaster. Laths were formerly all made by hand. A large quantity, however, are now made by machinery and are known as sawn laths, those made by hand being called rent or riven laths. Rent laths give the best results, as they split in a line with the grain of the wood, and are stronger and not so liable to twist as machine-made laths, some of the fibres of which are usually cut in the process of sawing. Laths must be nailed so as to break joint in bays three or four feet wide with ends butted one against the other. By breaking the joints of the lathing in this way the tendency for the plaster to crack along the line of joints is diminished and a better key is obtained. Every lath should be nailed at each end and wherever it crosses a joist or stud. All timbers over three inches wide should be counter-lathed, that is, have a fillet or double lath nailed along the centre upon which the laths are then nailed. This is done to preserve a good key for the plaster. Walls liable to damp are sometimes battened and lathed in order to form an air cavity between the damp wall and the plastering.

Lathing of metal, either of wire or in the form of perforated sheets, is now extensively used on account of its fire-proof and lasting quality. There are very many kinds of this material made in different designs under various patents, the best-known in England being the Jhilmil, the Bostwick, and the Expanded Metal lathing. The two last-named are also widely used in America.

Lathing nails are usually of iron, cut, wrought or cast—and in the better class of work they are galvanized to prevent rusting. Zinc nails are sometimes used, but are costly.

The lime principally used for internal plastering is that calcined from chalk or other nearly pure limestone, and is known as fat, pure, chalk or rich lime. Hydraulic limes, which are referred to in the articles **BRICKWORK** and **MORTAR**, are also used by the plasterer, chiefly for external work. Perfect slaking of the calcined lime before being used is very important as, if used in a partially slaked condition, it will "blow" when in position and blister the work. Lime should therefore be run as soon as the building is begun, and at least three weeks should elapse between the operation of running the lime and its use.

Hair is used in plaster as a binding medium, and gives tenacity to the material. Ox-hair, which is sold in three qualities, is the kind usually specified; but horsehair, which is shorter, is sometimes substituted in its stead or mixed with the ox-hair in the lower qualities. Good hair should be long, strong, and free from grease and dirt, and before use must be well beaten to separate the lumps. In America, goats' hair is frequently used,

though it is not so strong as ox-hair. The quantity used in good work is one pound of hair to two or three cubic feet of coarse stuff.

Manila hemp fibre has been used as a substitute for hair. As a result of experiments to ascertain its strength as compared with that of other materials, it was found that plaster slabs made with Manila hemp fibre broke at 195 lb, plaster mixed with Sisal hemp at 150 lb, jute at 145 lb, and goats' hair at 144 lb. Another test was made in the following manner. Two barrels of mortar were made up of equal proportions of lime and sand, one containing the usual quantity of goats' hair, and the other Manila fibre. After remaining in a dry cellar for nine months the barrels were opened. It was found that the hair had been almost entirely eaten away by the action of the lime, and the mortar consequently broke up and crumbled quite easily. The mortar containing the Manila hemp, on the other hand, showed great cohesion, and required some effort to pull it apart, the hemp fibre being apparently quite uninjured. Sawdust has been used as a substitute for hair and also instead of sand as an aggregate. It will enable mortar to stand the effects of frost and rough weather. It is useful sometimes for heavy cornices and similar work, as it renders the material light and strong. The sawdust should be used dry.

Some remarks are made on the ordinary sands for building in the articles on BRICKWORK and MORTAR. For fine plasterer's work special sands, not hitherto referred to, are used, such as silver sand, which is used when a light colour and fine texture are required. In England this fine white sand is procured chiefly from Leighton Buzzard.

For external work Portland cement is undoubtedly the best material on account of its strength, durability, and weather resisting properties. The first coat or rendering is from $\frac{1}{2}$ to $\frac{3}{4}$ in. thick, and is mixed in the proportions of from one part of cement to two of sand to one part to five of sand. The finishing or setting coat is about $\frac{1}{4}$ in. thick, and is worked with a hand float on the surface of the rendering, which must first be well wetted.

Stucco is a term loosely applied to nearly all kinds of external plastering, whether composed of lime or of cement. At the present time it has fallen into disfavour, but in the early part of the 19th century a great deal of this work was done.

The principal varieties of stucco are common, rough, trowelled and bastard. Cement has largely superseded lime for this work. Common stucco for external work is usually composed of one part hydraulic lime and three parts sand. The wall should be sufficiently rough to form a key and well wetted to prevent the moisture being absorbed from the plaster.

Rough stucco is used to imitate stonework. It is worked with a hand float covered with rough felt, which forms a sand surface on the plaster. Lines are ruled before the stuff is set to represent the joints of stonework. **Trowelled stucco**, the finishing coat of this work, consists of three parts sand to two parts fine stuff. A very fine smooth surface is produced by means of the hand float. **Bastard stucco** is of similar composition, but less labour is expended on it. It is laid on in two coats with a skimming float, scoured off at once, and then trowelled. **Coloured stucco**: lime stucco may be executed in colours, the desired tints being obtained by mixing with the lime various oxides. Black and greys are obtained by using forge ashes in varying proportions, greens by green enamel, reds by using litharge or red lead, and blues by mixing oxide or carbonate of copper with the other materials.

Rough-cast or Pebble-dash plastering is a rough form of external plastering in much use for country houses. In Scotland it is termed "harling." It is one of the oldest forms of external plastering. In Tudor times it was employed to fill in between the woodwork of half-timbered framing. When well executed with good material this kind of plastering is very durable. Rough-casting is performed by first rendering the wall or laths with a coat of well-haired coarse stuff composed either of good hydraulic lime or of Portland cement. This layer is well scratched to give a key for the next coat, which is also composed of coarse stuff knocked up to a smooth and uniform consistency. While this coat is still soft, gravel, shingle or other small stones are evenly thrown on with a small scoop and then brushed over with thin lime mortar to give a uniform surface. The shingle is often dipped in hot lime paste, well stirred up, and used as required.

Sgraffito (Italian for "scratched") is scratched ornament in plaster. Scratched ornament is the oldest form of surface decoration, and at the present day it is much used on the continent of Europe, especially in Germany and Italy, in both external and internal situations. Properly treated, the work is durable, effective and inexpensive. The process is carried out in this way: A first coat or rendering of Portland cement and sand, in the proportion of one to three, is laid on about $\frac{1}{2}$ in. thick; then follows the colour coat, sometimes put on in patches of different tints as required for the finished design. When this coat is nearly dry, it is finished with a smooth-skimming, $\frac{1}{2}$ to $\frac{3}{4}$ in. thick, of Parian, selenitic or other fine cement or lime, only as much as can be finished in one day being laid on. Then by pouncing through the pricked cartoon, the design is transferred to the plastered surface. Broad spaces

of background are now exposed by removing the finishing coat, thus revealing the coloured plaster beneath, and following this the outlines of the rest of the design are scratched with an iron knife through the outer skimming to the underlying tinted surface. Sometimes the coats are in three different colours, such as brown for the first, red for the second, and white or grey for the final coat. The pigments used for this work include Indian red, Turkey red, Antwerp blue, German blue, umber, ochre, purple brown, bone black or oxide of manganese for black. Combinations of these colours are made to produce any desired tone.

Lime plastering is composed of lime, sand, hair and water in proportions varying according to the nature of the work to be done. In all cases good materials, well mixed and skillfully applied, are essential to a perfect result. Plaster is applied in successive coats or layers on walls or lathing; and gains its name from the number of these coats. "One coat" work is the coarsest and cheapest class of plastering, and is limited to inferior buildings, such as outhouses, where merely a rough coating is required to keep out the weather and draughts. This is described as "render" on brickwork, and "lath and lay" or lath and plaster one coat" on studwork. "Two coat" work is often used for factories or warehouses and the less important rooms of residences. The first coat is of coarse stuff finished fair with the darby float and scoured. A thin coat of setting stuff is then laid on, and trowelled and brushed smooth. "Two coat" work is described as "render and set" on walls, and "lath, plaster and set," or "lath, lay and set" on laths. "Three coat" work is usually specified for all good work. It consists, as its name implies, of three layers of material, and is described as "render, float and set" on walls and "lath, plaster, float and set," or "lath, lay, float and set," on lathwork. This makes a strong, straight, sanitary coating for walls and ceilings. The process for "three coat" work is as follows: For the first coat a layer of well-haired coarse stuff, about $\frac{1}{2}$ in. thick, is put on with the laying trowel. This is termed "pricking up" in London, and in America "scratch coating." It should be laid on diagonally, each trowel overlapping the previous one. When on laths the stuff should be plastic enough to be worked through the spaces between the laths to form a key, yet so firm as not to drop off. The surface while still soft is scratched with a lath to give a key for the next coat, which is known as the second or "floating coat," and is $\frac{3}{4}$ to 1 in. thick. In Scotland this part of the process is termed "straightening" and in America "browning," and is performed when the first coat is dry, so as to form a straight surface to receive the finishing coat. Four operations are involved in laying the second coat, namely, forming the screeds; filling in the spaces between the screeds; scouring the surface; keying the face for finishing. Wall screeds are plumbbed and ceiling screeds levelled. Screeds are narrow strips of plastering, carefully plumbbed and levelled, so as to form a guide upon which the floating rule is run, thus securing a perfectly horizontal or vertical surface, or, in the case of circular work, a uniform curve.

The "filling in," or "flanking," consists of laying the spaces between the screeds with coarse stuff, which is brought flush with the level of the screeds with the floating rule. The "scouring" of the floating coat is of great importance, for it consolidates the material, and, besides hardening it, prevents it from cracking. It is done by the plasterer with a hand float which he applies vigorously with a rapid circular motion, at the same time sprinkling the work with water from a stock brush in the other hand. Any small holes or inequalities are filled up as he proceeds. The whole surface should be uniformly scoured two or three times, with an interval between each operation of from six to twenty-four hours. This process leaves the plaster with a close-grained and fairly smooth surface, offering little or no key to the coat which is to follow. To obtain proper cohesion, however, a roughened face is necessary, and this is obtained by "keying" the surface with a wire brush or nail float, that is, a hand float with the point of a nail sticking through and projecting about $\frac{1}{2}$ in.; sometimes a point is put at each corner of the float. After the floating is finished to the walls and ceiling, the next part of internal plastering is the running of the cornice, followed by the finishing of the ceiling and walls.

The third and final coat is the "setting coat," which should be about $\frac{1}{4}$ in. thick. In Scotland it is termed the "finishing," and in America the "hard finish" or "putty coat." Considerable skill is required at this juncture to bring the work to a perfectly true finish, uniform in colour and texture. Setting stuff should not be applied until the floating is quite firm and nearly dry, but it must not be too dry or the moisture will be drawn from the setting stuff. The coarse stuff applied as the first coat is composed of sand and lime, usually in proportions approximating to two to one, with hair mixed into it in quantities of about a pound to two or three cubic feet of mortar. It should be mixed with clean water to such a consistency that a quantity picked up on the point of a trowel holds well together and does not drop. Floating stuff is of finer texture than that used for "pricking up," and is used in a softer state, enabling it to be worked well into the keying of the first coat. A smaller proportion of hair is also used.

Fine stuff mixed with sand is used for the setting coat. Fine

stuff, or lime putty, is pure lime which has been slaked and then mixed with water to a semi-fluid consistency, and allowed to stand until it has developed into a soft paste. For use in setting it is mixed with fine washed sand in the ratio of one to three.

For cornices and for setting when the second coat is not allowed time to dry properly, a special compound must be used. This is often "gauged" stuff, composed of three or four parts of lime putty and one part of plaster of Paris, mixed up in small quantities immediately before use. The plaster in the material causes it to set rapidly, but if it is present in too large a proportion the work will crack in setting.

The hard cements used for plastering, such as Parian, Keene's, and Martin's, are laid generally in two coats, the first of cement and sand $\frac{1}{2}$ in. in thickness, the second or setting coat of neat cement about $\frac{1}{4}$ in. thick. These and similar cements have gypsum as a base, to which a certain proportion of another substance, such as alum, borax or carbonate of soda, is added, and the whole baked or calcined at a low temperature. The plaster they contain causes them to set quickly with a very hard smooth surface, which may be painted or papered within a few hours of its being finished.

The by-laws made by the London County Council under § 31 of the London Council (General Powers) Act 1890 set forth the description and quality of the substances of which plastering is to be made for use in buildings erected under its jurisdiction.

Plain, or unenriched, mouldings are formed with a running mould of zinc cut to the required profile. Enrichments may be added after the main outline moulding is set, and are cast in moulds made of gelatine or plaster of Paris. For a cornice moulding two running rules are usual, one on the wall, the other on the ceiling, upon which the mould is worked to and fro by one workman, while another man roughly lays on the plaster to the shape of the moulding. The mitres at the angles are finished off with joint rules made of sheet steel of various lengths, three or four inches wide, and about one-eighth inch thick, with one end cut to an angle of about 30°. In some cases the steel plate is let into a "stock" or handle of hardwood.

Cracks in plastering may be caused by settlement of the building, and by the use of inferior materials or by bad workmanship, but apart from these causes, and taking the materials and labour as being of the best, cracks may yet ensue by the too fast drying of the work, caused through the laying of plaster on dry walls which suck from the composition the moisture required to enable it to set, by the application of external heat or the heat of the sun, by the laying of a coat upon one which has not properly set, the cracking in this case being caused by unequal contraction, or by the use of too small a proportion of sand.

For partitions and ceilings, plaster slabs are now in very general use when work has to be finished quickly. For ceilings they require simply to be nailed to the joists, the joints being made

Slabs. with plaster, and the whole finished with a thin setting coat. In some cases, with fire-proof floors, for instance, the slabs are hung up with wire hangers so as to allow a space of several inches between the soffit of the concrete floor and the ceiling. For partitions the slabs frequently have the edges tongued and grooved to form a better connexion; often, too, they are holed through vertically, so that, when grouted in with semi-fluid plaster, the whole partition is bound together, as it were, with plaster dowels. Where very great strength is required the work may be reinforced by small iron rods through the slabs. This forms a very strong and rigid partition which is at the same time fire-resisting and of light weight, and when finished measures only from two to four inches thick. The slabs may be obtained either with a keyed surface, which requires finishing with a setting coat when the partition or ceiling is in position, or a smooth finished face, which may be papered or painted immediately the joints have been carefully made. Partitions are also formed with one or other of the forms of metal lathing previously referred to, fixed to iron uprights and plastered on both sides. So strong is the result that partitions of this class only two or three inches thick were used for temporary cells for prisoners at Newgate Gaol during the rebuilding of the new sessions house in the Old Bailey, London.

Fibrous plaster is given by plasterers the suggestive name "stick and rag," and this is a rough description of the material, for it is composed of plaster laid upon a backing of canvas stretched on wood. It is much used for mouldings, circular and enriched casings to columns and girders and ornamental work, which, being worked in the shop and then nailed or otherwise fixed in position, saves the delay often attendant upon the working of ornament in position.

Desachy, a French modeller, took out in 1856 a patent for "producing architectural mouldings, ornaments and other works of art, with surfaces of plaster," with the aid of plaster, glue, wood, wire, and canvas or other woven fabric. The modern use of this material may be said to have started then, but the use of fibrous plaster was known and practised by the Egyptians long before the Christian era; for ancient coffins and mummies still preserved prove that linen stiffened with plaster was used for decorating coffins and making masks. Cennino Cennini, writing in 1437, says that fine linen soaked in glue and plaster and laid on wood was used for forming grounds for painting. Canvas and mortar were in general

use in Great Britain up to the middle of the last century. This work is also much used for temporary work, such as exhibition buildings.

The principal books of reference on the subject are: W. Miller, *Plastering, Plain and Decorative*; G. R. Burnell, *Limes, Cements, Mortars and Mastics*; Rivington, *Notes on Building Construction*, Part III., "Building Materials"; the works on architecture of Robert and James Adam. (J. Br.)

PLATA, RIO DE LA, or RIVER PLATE, a funnel-shaped estuary, on the east side of South America, extending W.N.W. from the sea about 170 m. The discovery of the South Sea by Balboa, then governor of Castilla del Oro, of which Darien formed a part, created a lively desire to learn something of its coast-line, and the year following (in 1514), the Spanish monarch concluded a navigation contract with Juan Diaz de Solis, then Piloto Mayor, to search for a strait connecting the Atlantic with the newly found ocean, explore the coasts of the latter and communicate with Pedrarias de Avila, the new governor of Castilla del Oro; and, if it were found to be an island, to report to the superior authorities of Cuba. De Solis set sail from the port of Lepe on the 8th of October 1515, reached the Bay of Rio de Janeiro on the 1st of January 1516, and continuing southward to lat. 35° entered the great estuary now known as the Plata, which, for a short period of time, was called the de Solis and the Mar Dulce. Ascending it to the vicinity of the island of Martin Garcia, near the mouth of the Paraná river, de Solis was ambushed and killed in the early part of 1516 by Guarani Indians while attempting to capture some of them. In the first months of 1520 Magellan explored the Rio de la Plata, and afterwards, in the same year, discovered and navigated the straits which bear his name. This discovery led to the voyage of Sebastian Cabot, who fitted out an expedition in 1526 to reach the Spice Islands by the Magellan route. Owing, however, to shortness of provisions and the insubordination of his men Cabot abandoned his proposed voyage to the Moluccas, and, ascending the Mar Dulce, discovered the Paraná river and reached a point on the Paraguay near the site of the present city of Asuncion. Here he met many Guarani Indians wearing silver ornaments, probably obtained in trade across the Gra Chaco, from the frontier of the Inca Empire. In exchange for beads and trinkets Cabot acquired many of these ornaments and sent them to Spain as evidence of the richness of the country in precious metals and the great importance of his discoveries. The receipt of these silver baubles caused the name of Rio de la Plata to be applied to the third (perhaps the second) greatest river of the Western Continent.

The extreme breadth of the river at its mouth is 138 m. It narrows quickly to 57 m. at Montevideo, and at its head, where it receives the united Paraná and Uruguay rivers, its width is about 25 m. Its northern or Uruguayan shore is somewhat elevated and rocky, while the southern or Buenos Airean one is very low. The whole estuary is very shallow, and in no place above Montevideo exceeds 36 ft. in depth when the river is low. The bottom generally consists of enormous banks of sand covered with from 10 to 20 ft. of water, and there is a continuous and intricate channel, of about 22 ft. depth only, to within 14 m. of the port of Buenos Aires. The remaining distance has a depth of 18 ft. in the uncertain channel. The Plata is simply the estuarine receptacle of two mighty streams, the Uruguay and Paraná, which drain the Plata basin. This has an area of 1,198,000 sq. m., or over two and one-half times that of the Pacific slope of the Andes, and comprises the most fertile, healthiest and best part of Brazil, a large portion of the Argentine Republic, the whole of Paraguay and south-eastern Bolivia, and most of Uruguay.

The Uruguay river has a length of about 1000 m. Many small streams from the western slope of the Brazilian Serra do Mar unite, in about 27° 45' S., to form this river, which then flows W.N.W., serving as the boundary between the states of Santa Catharina and Rio Grande do Sul, as far as 52° W., near which it receives a considerable tributary from the north, called the Papir-guaçu. Between 27° 58' and 33° 34' S. three important tributaries join it from the east—the Ipu-guaçu, the Ibicui and the Negro, the last being its main affluent.

The *Pepiri-guaçu* was one of the limits between the possessions of Portugal and Spain. Its lower course is about 250 ft. wide, but higher up it narrows to about 30 ft., and runs with great violence between high wooded banks. It is navigable for canoes for about 70 m. above its mouth, as far as its first fall. The Rio Negro has a delta of several large islands at its confluence with the Uruguay. Its head-waters are in the southern part of Rio Grande do Sul, but the main river belongs entirely to the state of Uruguay, which it cuts midway in its course from north-east to south-west. Its lower reaches are navigable for craft of moderate draught.

From the time the Uruguay leaves the coast range of Brazil it runs for a long distance through a beautiful, open, hilly country, but afterwards enters a forest belt of high lands. At the river *Pepiri-guaçu* it turns suddenly to the south-west, and continues this course to its junction with the Paraná and Plata. Near Fray Bentos, 61 m. before reaching the Plata, it forms a great lake, about 56 m. long and from 4 to 6 m. wide. At Punta Gorda, where it debouches into the Plata, it is only 1 m. to 1½ m. wide, but is 90 ft. deep. From the *Pepiri-guaçu* junction its banks are high and covered with forest as far down as 27° 30' S., where the river is 2300 ft. wide and from 10 to 40 ft. deep. The Uruguay is much obstructed by rocky barriers. Four miles below its confluence with the *Pepiri-guaçu* it has a cataract, about 8 m. long, with a total fall of 26 ft. at low water. The river near the *Pepiri-guaçu* is 1550 ft. wide, but about 1½ m. before reaching the cataract its width is reduced to 600 ft. Along the cataract it is closed in between high precipitous walls of black rock only 70 ft. apart. Above Punta Gorda, 212 m., is the Salto Grande, which has a length of 15 m. of rapids, the greatest single fall being 12 ft., and the difference of level for the entire length of the reefs 25 ft. These cross the river diagonally, and during floods all, excepting a length of 1½ m. of them, are submerged. Nine miles below the Salto Grande is the Salto Chico, which bars navigation during six months of the year, but in flood-time may be passed in craft drawing 5 ft. of water. The Uruguay can be navigated at all seasons by vessels of 4½ ft. draught as far up as the Salto Chico, and of 14 ft. up to Paysandú for a greater part of the year. Fray Bentos may be reached all the year round by any vessel that can ascend the Paraná. Above the navigable lower river there is launch and canoe navigation for many hundreds of miles upon the main artery and its branches, between the rapids which are met with from time to time. The Uruguay has its annual floods, due to the rains in its upper basin. They begin at the end of July and continue to November, attaining their maximum during September and October. At the narrow places the river rises as high as 30 ft., but its average rise is 16 ft. It flows almost for its entire course over a rocky bed, generally of red sandstone, at times very coarse and then again of extremely fine composition. Except in floods, it is a clear-water stream, and even at its highest level carries comparatively little silt.

The Paraná (the "Mother of the Sea" in Guarani) drains a vast area of southern Brazil. It is formed by the union of the Rio Grande and Paranáhyba, and is about 1600 m. long from its extreme source in Goyaz to its junction with the Paraguay, and thence 600 more to the Plata estuary. Its average width for the latter length is from 1 to 3 m. Its Rio Grande branch descends from the slope of the Serra de Mantiqueira, in the region where the orographic system of Brazil culminates near the peak of Itatiaia-ássú, almost in sight of Rio de Janeiro. It is about 680 m. long, but only navigable in the stretches between the many reefs, falls and rapids which interrupt its regular flow. Among its numerous affluents the principal one is the Rio das Mortes, rising in the Serra Mantiqueira. It is 180 m. long, with two sections, of a total of 120 m., which are navigable for launches. The main branch of the Paraná, the Paranáhyba, rises in about 15° 30' S., on the southern slopes of the Pyrenean Mountains. It drains a little-known region of Goyaz and western Minas Geraes, lying upon the immediate southern watershed of Brazil.

Besides these rivers, the Paraná has many long and powerful affluents from the Brazilian states of São Paulo and Paraná. Most of them, although obstructed by rapids, are navigable for launches and canoes. Among the eastern tributaries are the *Tiété*, the *Paraná-panema*, formerly known as the *Aneuby*, and the *Iguazú*. The *Tiété*, over 700 m. long, rises in the Serra Paranápicaba and flows in a north-west direction. Its course is broken by fifty-four rapids, and the lower river by two falls, the *Avanhandava*, 44 ft. drop, and the *Itapurá*, 65 ft.

The *Paraná-panema* is about 600 m. long, and rises in a ramification of the Serra Paranápicaba which overlooks the Atlantic Ocean. Its general course is north-west. It is navigable for a distance of only about 30 m. above its mouth, and for its whole course it has so many obstructions that it is useless for commercial purposes.

The *Iguazú*, also called the *Rio Grande de Curitiba*, has its sources on the slopes of the Serra do Mar of Brazil, and flows nearly west, through thick forests, along the line of 26° S. Its navigation is difficult even for small craft, as it is full of reefs, rapids and cataracts. Sixteen miles above its mouth is the magnificent Salto del Iguazú, sometimes called the *Victoria Fall*, round which canoes have to be transported 37 m. before quiet water is reached again. The width

of the falls, measured along their crest or edge, is 2½ m.; part of the river takes two leaps of about 100 ft. each, but a portion of it plunges down the whole depth in unbroken mass. Its mouth is about 800 ft. wide, and the depth in mid-river 40 ft.

The Paraná, at a point 28 m. above the mouth of the *Tiété*, is interrupted by the falls of *Urubupunga*, but below these it has unobstructed navigation for about 400 m., as far down as the falls of *Guaíra*, in 24° 3' S., where the river forms a lake 41 m. long and 2½ m. wide, preparatory to breaching the Serra de Mbaracayú, which there disputes its right of way. It has torn a deep gorge through the mountains for a length of about 2 m., where it is divided into several channels, filled with rapids and cataracts. It finally gathers its waters into a single volume, to plunge with frightful velocity through a long cañon only about 200 ft. wide. From these so-called falls of *Guaíra*, or "Sete Quedas," as far as its confluence with the Paraguay river, the Paraná has carved a narrow bed through an immense cap of red sandstone, along which it sometimes flows with great rapidity, occasionally being interrupted by dangerous narrows and rapids, where the banks in some places close in to a width of 450 to 600 ft., although the average is from 1200 to 1600 ft. At the south-east angle of Paraguay the Paraná is prevented from continuing its natural southern course to the river Uruguay by the highlands which cross the Argentine province of Misiones, and connect those of Rio Grande do Sul with the *Caa-guaçu* range of Paraguay. Here, therefore, it is turned westwards; but before escaping from its great sandstone bed it is obstructed by several reefs, notably at the rapids of *Apipe*, which are the last before it joins the *placid* Paraguay, 130 m. farther on. From the *Apipe* rapids there is a vast triangular space at the south-western corner of Paraguay but little above sea-level, consisting of low, sandy ground and morasses, at times flooded by the Paraguay river. This district, united to the equally enormous area occupied by the *Yberá* lagoon and its surrounding morasses, in the northern part of the Argentine province of Corrientes, was probably the delta of the Paraná river when it emptied into the ancient Pampean Sea.

The river Paraguay, the main affluent of the Paraná, rises in *Matto Grosso*, in the vicinity of the town of *Diamantino*, about 14° 24' S. It flows south-westwards, as far as *Villa Maria*, along the foot of the high plateau which divides it from the *Cuyabá* River to the east, and then, turning southwards, soon reaches the morass expansion of *Xarayes*, which it traverses for about 100 m. A few miles below *Villa Maria* it receives an affluent from the north-west, the *Jaurá*, which has its source nearly in contact with the head-waters of the *Guaporé* branch of the river *Madeira*. The *Cuyabá*, which is known as the *São Lourenço* for 90 m. above its confluence with the Paraguay, has its sources in 13° 45' S., almost in touch with those of the *Tapajos* branch of the Amazon. Above the town of *Cuyabá* it is from 150 to 400 ft. wide, and may be navigated up stream by canoes for 150 m.; but there are many rapids. The town may be reached from the Paraguay River, at low water, by craft drawing 18 in. According to the observations of *Claus*, *Cuyabá* is only 660 ft. above sea-level. From the junction of the *São Lourenço* (or *Cuyabá*) with the river Paraguay, the latter, now a great stream, moves sluggishly southwards, spreading its waters, in the rainy season, for hundreds of miles to the right and left, as far south as 20°, turning vast swamps into great lakes—in fact, temporarily restoring the region, for thousands of square miles, to its ancient lacustrine condition.

On the west side of the upper Paraguay, between about 17° 30' and 19° S., are several large, shallow *lagunas* or lakes which receive the drainage of the southern slopes of the *Chiquitos* sierras, but represent mainly the south-west overflow of the vast morass of *Xarayes*. The principal of these lakes, naming them from north to south, are the *Uberaba*, the *Gaiba*, *Mandioré* and the "Bahia" de *Caceres*. The *Uberaba* is the largest. The northern division of the lake belongs entirely to Brazil, but the southern one, about two-thirds of its area, is bisected from north to south by the boundary line between Brazil and Bolivia, according to the treaty of 1867. It is in great part surrounded by high ground and hills, but its southern coast is swampy and flooded during the rainy season. The west shore is historic. Here, in 1543, the *conquistador*, *Martinez de Irala*, founded the "Puerto de los Reyes," with the idea that it might become the port for Peru; and from *Lake Gaiba* several expeditions, in Spanish colonial days, penetrated 500 m. across the Chaco to the frontier of the empire of the Incas. At the *Puerto de los Reyes* Bolivia laid out a town in December 1900, in the form of hope that the "Port" may serve as an outlet for that commercially suffocated country, there being no other equally good accessible point for Bolivia on the Paraguay River.

South of the *São Lourenço*, the first river of importance which enters the Paraguay from the east is the *Taquary*, about 19° S. It rises in the Serra *Cayapó*, on the southern extension of the *Matto Grosso* table-land. South of this stream about 50 m. a considerable river, the *Mondego*, with many branches, draining a great area of extreme southern *Matto Grosso*, also flows into the Paraguay; and still farther south, near 21°, is the *Apá* tributary, which forms the boundary between Paraguay and Brazilian *Matto Grosso*.

Course of the Paraná.

The Paraguay.

Lagoons of Upper Paraguay.

Affluents of the Paraguay.

The Pilcomayo is of more importance from its length than from its volume. It rises among the Bolivian Andes north of Potosi and north-west of Sucre, races down the mountains to their base, crosses the Chaco plains, and pours into the river Paraguay near Asuncion. Nor does it receive any branch of importance until it reaches about 21° S., where it is joined from the south-west by the river Pelaya, upon which Tupiza, the most southerly city of Bolivia, is situated. The Pelaya rises upon the lofty inter-Andean plateau, and, taking an easterly course, saws its way across the inland Andean range, turns northwards and then eastwards to unite with the Pilcomayo, which it is said at least to equal in volume. Just below the junction is the fall of Guarapendi, 23 ft. high. From this point to the mouth of the Pilcomayo the distance in a straight line is 480 m., although by the curves of the river, which is extremely tortuous, it is about double that distance. According to Storm, who quotes Captain Baldrich, the river bifurcates at 21° 51' S., but again becomes a single stream at 23° 43', the right channel being the greater in volume. It is probable that between 23° and 24° S. it throws E.S.E. three great arms to the river Paraguay, the upper portions of which have yet to be explored, but the lower parts have been examined for 100 to 200 m. up from the Paraguay. Enumerating from north to south, they are called the Esperanza, the Montelindo and the Macá. From 180 to 200 m. above its mouth the Pilcomayo filters through a vast swamp about 100 m. in diameter, through which there is no principal channel. This swamp, or perhaps shallow lagoon, is probably partly drained by the river Confuso, which reaches the Paraguay between the Pilcomayo and Macá. A northern branch of the Pilcomayo, the Fontana, the junction being at 24° 56' S., is probably also a drainage outlet of the same great swamp.

For the first 100 m. below the fall of Guarapendi the Pilcomayo is from 600 to 1000 ft. wide, but it so distributes its waters through its many bifurcations, and loses so much from infiltration and in swamps, and by evaporation from the numerous lagoons it forms on either side of its course, that its channel is greatly contracted before it reaches the Paraguay. From Sucre to the Andean margin of the Chaco, a distance of about 350 m. by the river, the fall is at least 8000 ft.—a sufficient indication that its upper course is useless for purposes of navigation.

The missionaries in 1556 first reported the existence of the Pilcomayo, which for a long period of time was known as the Araguay. In 1721 Patiño and Rodriguez partially explored it, and since then numerous attempts have been made to test its navigability, all of which have been failures; and several of them have ended in disaster and loss of life, so that the Pilcomayo now has a sinister reputation.

The Bermejo river flows parallel to the Pilcomayo, and enters the Paraguay a few miles above the junction of this with the Paraná.

Its numerous sources are on the eastern frontage of the inland Andes, between the Bolivian town of Tarija and the Argentine city of Jujuy. Its most northerly tributary is the San Lorenzo, which, after being augmented by several small streams, takes the name of Rio de Tarija. This running east, and then taking a general south-easterly course, joins the Bermejo in 22° 50' S. at a point called the Juntas de San Antonio. Thence, flying southwards, the Bermejo finally, in 23° 50' S., receives its main affluent, the San Francisco, from the south-west. The latter has its source in about 22° 30' S., and, under the name of Rio Grande, runs directly southwards, in a deep mountain valley, as far as Jujuy. It then turns eastwards for 50 m., and is joined by the Lavayen from the south-west. These two streams form the San Francisco, which, from their junction, runs north-eastwards to the Bermejo. The average width of the San Francisco is about 400 ft.; it is seldom over 2 ft. deep, and has many shoals and sandbanks. From its junction with the latter stream the Bermejo flows south-eastwards to the Paraguay with an average width in its main channel of about 650 ft., although narrowing at times to 160 and even 100. In its course, however, it bifurcates and ramifies into many channels, forming enormous islands, and frequently leaves old beds for new ones.

Since the exploration of the Bermejo by Patiño in 1721, it has often been examined from its sources to its mouth, with a view to ascertain its navigability. Captain Page in 1854 and 1859 found it impracticable to ascend it over 135 m. in the dry season, with a little steamer drawing 23 in. of water; but in flood-time, in December 1871, he succeeded, in 10 days, in reaching a point 720 m. from its mouth, in the steamer "Alpha," 53 ft. long and 30 in. draught. He afterwards penetrated another 100 m. up stream. The round voyage took a year, owing to the swift currents, shoals, quicksands, snags and fallen trees.

The Salado, about 250 m. south-west of and approximately parallel to the Bermejo, is the only great tributary which the Paraná receives from the west below its confluence with the Paraguay.

Its extreme head-waters are in the Argentine province of Salta, and they drain a much broken Andean region lying between 24° and 26° 30' south. The most westerly sources are the rivers Santa Maria and Calchaqui, which unite near the town of San Carlos and form the river Guáchipas. Having received the Arias, the Guáchipas runs north-eastwards about 50 m., and then it changes its name to the Juramento, which is retained until the river reaches the Chaco plains at the base of the foot-hills of the Andes.

Here it becomes the Salado, a name it preserves for the remainder of its course. It joins the Paraná near Santa Fé in 31° 39' south and 60° 41' west. Explorers of the Salado, inclusive of Captain Page in 1855, claim that its lower half is navigable, but the many efforts which have been made to utilize it as a commercial route have all resulted in failure.

As the Pilcomayo, the Bermejo and the Salado wander about the country, ever in search of new channels, they erode and tear away great quantities of the Pampean material, dissolve it into silt, and pour it into the Paraguay and Paraná rivers. The engineer Pellacci estimates that "the soil annually subtracted from the territory of the Chaco by the Bermejo alone equals 6,400,000 cubic yards."

South of its confluence with the river Paraguay, the Paraná washes the western foot of a series of sandstone bluffs for 30 miles. Thence for 240 m. the bordering hills are about 80 ft. high, but at Goya the country is almost on a level with the river. Near the boundary-line between Corrientes and Entre Rios the banks are very low on both sides of the river, and continue so for nearly 100 m.; but farther down, for 150 m., the left bank is marginated, as far as Diamante, by a range of hills from 125 to 160 ft. high, at times boldly escarped. At Diamante they trend inland, south-eastwards, for about 50 m., and probably once bordered an ancient channel of the river. From 31° 30' south to the head of the Plata estuary the western bank of the Paraná is a precipitous bluff of reddish clay, varying from 25 to 75 ft. above mean river level. It is being gradually undermined, and tumbles into the water in great blocks, adding to the immense volume of silt which the river carries. According to Ramon Lista, "the lowest level of the Paraná is in October and November, and, save an occasional freshet, it remains stationary until the beginning of summer, when its water begin to rise, reaching their maximum about the middle of February in the lower part of their course." The difference between low and high river is generally about 12 ft., depending upon the varying quantity of rains in Brazil and the melting of the Andean snows. Below its junction with the Paraguay the Paraná has an average current of 24 m. an hour, and the river varies in width from 1 to 3 m., at low water; but in floods it seems almost a continuous lake, broadening to 10 and 30 m. and burying many of its numerous islands and marginal swamps under a vast sheet of water, and obliterating its many parallel lateral channels and intricate systems of connecting canals.

In the middle Paraná, from the mouth of the Iguazú to the mouth of the Paraguay river, there are many islands, some of them large, rocky and high above the river. From Paraguay to the city of Rosario, islands are numerous, many of them of great area; and again below Rosario they soon increase in number and size until the Plata estuary is reached. In flood-time the upper portion of the trees being out of water, they have the appearance of floating forests. Then the river often makes wild work with its banks, and builds up or sweeps away entire islands, leaving deep channels instead. Mouchez in 1857, searching for two islands the position of which he had fixed in the previous year, found in their place 25 and 32 ft. of water. The lower delta of the Paraná does not share in these phenomena; its islands and main channels appear more fixed. This probably is due to the less elevation attained by the waters in flood-time, and the numerous branches which distribute them into the Plata estuary. This must have extended, in a very recent geological period, inland from its present head to at least 32° S.; but the enormous quantity of silt which the Paraná receives from its Paraguay affluent, and from the tributaries which reach it from the Andes, has filled this length of about 220 m. with these muddy islands, which rest upon a sandy bed of great depth.

The frontage of the Paraná delta is 40 m. across, almost in a straight line from north to south. Through this the river finds its way to the Plata by eleven outlets, large and small, the two principal ones being the Paraná-guaraní and the Paraná de las Palmas.

The mean flow of the Mississippi river at New Orleans is 675,000 cub. ft. per second, and its flood maximum about 1,000,000 ft. The minimum of the Plata past Buenos Aires is 534,000, the maximum 2,145,000. It may therefore be fairly assumed that the yearly discharge of the great North American river is not superior, and is inferior, to that of the Plata.

The Paraná is navigable at all times as far up as the São Lourenço river by craft drawing 3 ft. of water, and to within a few miles of Asuncion, the capital of Paraguay, by vessels drawing 9 ft. The city of Paraná may always be reached with a draught of 12 and Rosario with 15 ft. of water.

The commercial development of the Plata basin may be conveniently illustrated by statistics for the year 1822, which marks the beginning of independent rule in its republics; for 1854, when the steamboat and the railway first began to play a part in this quarter of the world; and in 1898 and 1899, as indicating approximately the state of affairs at the end of the 19th century. In Buenos Aires, for example, the foreign trade (entered and cleared) in 1822 aggregated 107,170 tons; in 1854, 342,463 tons; and in 1899, 5,046,847 tons. The coasting and river trade of the same port increased from 150,741 tons in 1854 to 3,695,088 tons in 1899. But taking into account all the Argentine ports, except

South-
country
Course of
Paraná.

Islands of
Paraná.

Paraná
Delta.

Commerce.

those which lie to the south of the Plata, there was for the six years ending with 1899 an annual average of 14,000,000 tons for the overseas commerce and 11,000,000 tons for the river and coasting trade. On the other, or northern, bank of the stream the chief port is Montevideo; and its foreign commerce increased from an aggregate of 50,000 tons in 1822 to 150,000 tons in 1854 and to 4,069,870 tons in 1898, the river and coasting trade having increased from 50,000 tons in 1822 to 150,000 tons in 1854 and to 3,915,421 tons in 1898. The total foreign trade of the Plata valley thus increased from over 157,000 tons in 1822 to nearly 18,100,000 tons in 1898-1899. Its growth since the opening of the 20th century has been phenomenal and promises to become gigantic. The Andes on the west, the interior of South America on the north, great rivers, and the Brazilian mountains on the east of the Plata basin are obstacles which compel the rich and varied products of at least 1,500,000 sq. m. of fertile country to seek access to the ocean by a single avenue—the Plata estuary. (G. E. C.)

PLATAEA, or **PLATAEAE**, an ancient Greek city of Boeotia, situated close under Mt Cithaeron, near the passes leading from Peloponnesus and Attica to Thebes, and separated from the latter city's territory by the river Asopus. Though one of the smallest Boeotian towns, it stubbornly resisted the centralizing policy of Thebes. In 519 B.C. it invoked Sparta's help against its powerful neighbour, but was referred by king Cleomenes to Athens (for the date, see Grote's *History of Greece*, ed. 1907, p. 82, note 4). The Athenians secured Plataea's independence, and thus secured its enduring friendship. In 490 the Plataeans sent their full levy to the assistance of the Athenians at Marathon, and during the invasion of Xerxes they joined eagerly in the national defence. At Artemisium they volunteered to man several Athenian ships, and subsequently abandoned their town to be burnt by Xerxes. In 479 they fought against the Persians under Mardonius in the decisive battle which bears the name of the city. In this campaign the Persian commander, retiring from Attica before the combined Peloponnesian and Athenian levy, had encamped in the Asopus plain in order to give battle on ground suited to his numerous cavalry. The Greeks under the Spartan regent Pausanias at first did not venture beyond the spurs of Cithaeron, but, encouraged by successful skirmishing, advanced towards the river and attempted a flanking movement so as to cut Mardonius off from his base at Thebes. The operation miscarried, and in their exposed condition the Greeks were severely harassed by the enemy's horse, which also blocked the Cithaeron passes against their supply columns. Pausanias thereupon ordered a night retreat to the hilly ground near Plataea, but the movement was badly executed; for whereas the Peloponnesians in the centre retired beyond their proper station, the Spartans and Athenians on the wings were still in the plain at daybreak. The Persians immediately fell upon these isolated contingents, but the Spartan infantry bore the brunt of the attack with admirable steadiness, and both wings ultimately rolled back their opponents upon the camp. When this was stormed the enemy's resistance collapsed, and Mardonius's army was almost annihilated. This great victory was celebrated by annual sacrifices and a Festival of Liberation (*Eleutheria*) in every fourth year at Plataea, whose territory moreover was declared inviolate.

In spite of this guarantee Plataea was attacked by Thebes at the beginning of the Peloponnesian War (431) and formally besieged by the Peloponnesians (429-27). The garrison after capitulating was put to death, and the city razed by the Thebans. The remaining Plataeans received a qualified franchise in Athens, and in 421 were settled on the territory of Scione. Expelled by Lysander in 404 they returned to Athens, until in 387 Sparta restored them in their native town as a check upon Thebes. The city was again destroyed by Thebes in 373, and the inhabitants once more became citizens of Athens. Plataea was rebuilt by Philip and Alexander of Macedon, and during the rest of antiquity enjoyed a safe but obscure existence. It continued to flourish in Byzantine and Frankish times. The walls of the town, which at various periods occupied different portions of the triangular ledge on which it stood, remain partly visible. Recent excavations have discovered the Heraeum; but the temple of Athena the Warlike, built from the Persian spoils and adorned by the most famous artists, has not been identified.

AUTHORITIES.—Strabo p. 411; Pausanias ix. 1-4; Herodotus vi. 108, viii. 1, ix. 25-85; Plutarch, *Aristides*, 11-21; Thucydides ii. 1-16, 71-78, iii. 20-24, 52-68; Isocrates, *Plataicus*; G. B. Grundy, *The Topography of the Battle of Plataea* (London, 1894) and *Great Persian War* (London, 1901), ch. xi.; W. Woodhouse in *Journal of Hellenic Studies* (1898), pp. 33-59; H. B. Wright, *The Campaign of Plataea* (New Haven, 1904); R. W. Macan, *Herodotus*, vii.-ix. (London, 1908), appendix; W. M. Leake, *Travels in Northern Greece*, ch. xvi., pp. 323-367 (London, 1835); *Amer. Journ. of Archaeology*, 1890, pp. 445-475; 1891, pp. 390-405; B. V. Head, *Historia numorum*, p. 294 (Oxford, 1887).

PLATE. The word "plate" (connected with Gr. *πλατῆς*, flat, Late Lat. *plata*=*lamina*, and Span. *plata*, silver), in the sense to which it is restricted in the following article, is employed to denote works in silver or gold which belong to any class other than those of personal ornaments or coins.¹ As implying a thin sheet of metal, the term has come to be used in various technical connexions, and has been transferred by analogy to other materials (e.g. glass). A "plate," as the common name for the table utensil (of whatever material), derives its usage partly from the metal prototype and partly from an etymological connexion with French *plat*, dish, Latin *plattus*, flat. (See also PEWTER; SHEFFIELD PLATE; METAL-WORK.)

On account of the ease with which gold can be worked and the pure state in which it is generally found, it is probable that this was the first metal used by man; and it is certain that, in some countries at least, he attained to the most marvellous skill in its manipulation at a time when the other arts were in a very elementary condition. As an instance of this we may mention a sword of the bronze age, found in a barrow near Stonehenge, and placed in the museum at Devizes.² The hilt of this sword is covered with the most microscopically minute gold mosaic. A simple design is formed by fixing tesserae, or rather pins, of red and yellow gold into the wooden core of the handle. Incredible as it may appear, there are more than two thousand of these gold tesserae to the square inch. The use of silver appears to belong to a rather later period, probably because, though a widely spread metal in almost all parts of the world, it is usually found in a less pure state than gold, and requires some skill to smelt and refine it. Though both these precious metals were largely and skilfully used by prehistoric races, they were generally employed as personal ornaments or decorations for weapons. Except in Scandinavian countries, but little that can be called "plate" has been discovered in the early barrows of the prehistoric period in western Europe.

Ancient Egypt.—An enormous amount of the precious metals was annually brought as tribute to the Egyptian kings; according to Diodorus, who quotes the authority of Hecataeus, the yearly produce of the royal gold and silver mines amounted to 32 millions of minae—that is, about 133 millions sterling of modern money. Though this estimate is probably an exaggeration, the amount must have been very great. The gold chiefly came from the Nubian mines in the western desert in the Wadi 'Alākī and the neighbouring valleys. A map of these mines, dating from the time of Rameses II. (1300 B.C.), has been preserved. Silver was not mined in Egypt itself, and came mostly from Asia Minor even at the earliest period. Then gold was comparatively common, silver a great rarity. Later, gold appears to have been relatively more abundant than silver, and the difference in value between them was very much less than it is now.

In the language of the hieroglyphs silver is called "white gold," and gold is the generic name for money—unlike most languages, in which silver usually has this special meaning—a fact which points strongly to the priority of the use of gold, which archaeological discoveries have rendered very probable. Among the treasures of the "royal tombs" at Abydos, dating to the 1st and 11th Dynasties, much gold was found, but no

¹In medieval English the term "a plate" was occasionally used in the sense of a silver vessel. A curious survival of this use of the word still exists at Queen's College, Oxford, where the servants may yet be heard asking at the buttery for so many "plates of beer," that is, silver tankards.

²Hoare, *Ancient Wiltshire* (1840).

silver. On the walls of one of the tombs at Beni Hassan there is an interesting representation of a gold- and silver-smith's workshop, showing the various processes employed—weighing, melting, or soldering with the blow-pipe, refining the metal, and polishing the almost finished bowl or vase. Owing to the Egyptian practice of burying with their dead personal ornaments and jewelry, rather than other possessions less intimately connected with the person of the deceased, but few specimens of either gold or silver plate have survived to our times, whereas the amount of gold jewelry that has been discovered is very large, and shows the highest degree of skill in working the precious metals. We can, however, form some notion of what the larger works, such as plates and vases in gold and silver, were like from the frequent representations of them in mural sculpture and paintings. In many cases they were extremely elaborate and fanciful in shape, formed with the bodies or heads of griffins, horses, and other animals real or imaginary. Others are simple and graceful in outline, enriched with delicate surface ornament of leaves, wave and guilloche patterns, hieroglyphs, or sacred animals. Fig. 1 shows a

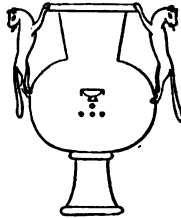

FIG. 1.—Gold Vase, from wall-paintings at Thebes.

as early as the time of Tethmosis III., when, as we know, the Phoenician cities had already existed for centuries, we find the ships of Arvad, of Byblos and of Tyre well known in the harbours of the Delta, and even bringing tribute of foreign vases to the river quays of Thebes itself. We cannot doubt that much of the precious plate of gold and silver used by the Egyptians at this time and specifically described as foreign tribute was made in Egyptian or egyptizing style by Phoenician artists. But plate of really foreign type as well as origin was also brought to Egypt at this time by the Phoenician "Kefiti ships" from Kefiti, the island of Crete, where the "Minoan" culture of Cnossos and Phaestus was now at its apogee. Ambassadors from Kefiti also brought gold and silver vases as presents for the Egyptian king, and on the walls of the tomb of Senmut, Queen Hatshepsut's architect, at Thebes, we see a Kefitian carrying a vase of gold and silver which is the duplicate of an actual vase discovered at Cnossos by Dr Arthur Evans. The art of the "Minoan" and "Mycenaean" goldsmiths exercised considerable influence upon that of the Egyptians; under the XXth Dynasty, about 1150 B.C., we find depicted on the tomb of Rameses III. golden stirrup-vases (*Bügelkannen*) of the well-known Mycenaean type, and in that of Imadua, an officer of Rameses IX., golden vases imitating the ancient Cretan shape of the cups of Vaphio. In fact, it is more than probable that the Egyptians and Phoenicians manufactured plate of "Minoan" and "Mycenaean" types long after the ancient culture of Crete and the Aegean had come to an end. In the time of Rameses III., about 1300 B.C., a clearly defined Asiatic influence appears in the decoration of some of the gold plate. A gold basket represented in the tomb of this king at Thebes, has on its side a relief of the sacred tree between two beasts, an Asiatic idea.

The chief existing specimens of Egyptian plate are five silver *phiaeae* (bowls), found at the ancient Thmuïs in the Delta, and now in the Cairo Museum (Nos. 482-486 in the catalogue). These are modelled in the form of a lotus blossom, most graceful in design, but are apparently not earlier than the 4th century B.C. Of the splendid toreutic art of a thousand years before,

of which we gain an idea from the wall-paintings mentioned above, but few actual specimens have survived. The Louvre possesses a fine gold patera, 6½ in. across, with figures of fishes within a lotus border in *repoussé* work; an inscription on the rim shows it to have belonged to Thutii, an officer of Tethmosis III. (*Mém. soc. ant. de France*, xxiv. 1858). Thutii's bowl is a typical specimen of the Egyptian plate of the XVIIIth Dynasty, and its design is precisely that of the hundreds of blue glazed falence bowls which were made at the time, and of which some perfect specimens and many fragments (especially from Deir el-Bahri) are in our museums. These were imitated from metal originals, just as most of the early Cretan pottery vessels were.

A splendid bronze bowl, which shows us what some of the finer gold and silver plate was like, was found in the tomb of Hetaai, a dignitary of the XVIIIth Dynasty, at Thebes a few years ago, and is now in the Cairo Museum (No. 3553 in von Bissing's catalogue). The engraved decoration, representing birds and animals in the papyrus-marshes, is very fine and evidently of native Egyptian work. The silver bowl at Berlin, said by di Cesnola to have come from Athienou in Cyprus, is certainly of XVIIIth Dynasty date, but, though purely Egyptian in style, more probably of Phoenician than Egyptian workmanship.

Assyrian and Phoenician Plate.—The art of making gold and silver plate, whether it originated in Egypt and passed thence to Crete or not, was evidently on its own ground in Egypt and in Minoan Crete. In Asia it was an exotic art, introduced from Egypt through the Phoenicians. In fact, it may be doubted whether any of the bronze imitations of plate found in Assyria are of Assyrian manufacture; they are probably Phoenician imports. The British Museum possesses a fine collection of these bowls, mostly found in the palace at Nimrud, and so dating from the 9th and 8th centuries (reigns of Assur-nazir-pal to Sargon). Though they are made of bronze, and only occasionally ornamented with a few silver studs, they are evidently the production of artists who were accustomed to work in the precious metals, some of them in fact being almost identical in form and design with the silver phialae found at Curium and elsewhere in Cyprus. They are ornamented in a very delicate and minute manner, partly by incised lines, and partly by the *repoussé* process, finally completed by chasing. Their designs consist of a central geometrical pattern, with one or more concentric



FIG. 2.—Silver Bowl, about 7 in. in diameter, found in a tomb in Cyprus, with *repoussé* reliefs of Egyptian and Assyrian style.

bands round it of figures of gods and men, with various animals and plants, such as antelopes amid papyrus, which are derived from the Egyptian designs of the XVIIIth Dynasty. Often there is a strange admixture of Assyrian and Egyptian style.

Bulls, for instance, are usually represented as with a single mighty horn, curving to the front (in the style of the ancient Babylonian seals), rather than with both horns showing, in Egyptian fashion. When figures of gods and men are shown, the principal groups are purely Assyrian imitations of Assyrian temple-reliefs, in fact—such as the sacred tree between the two attendant beasts, or the king engaged in combat and vanquishing a lion single-handed; while mingled with these are figures and groups purely Egyptian in style, such as the hawk-headed deity, or a king slaying a whole crowd of captives at one blow. Occasionally one sees traces of the ancient Mycenaean influence, or perhaps rather of the young Ionian art which had now arisen out of the ashes of that of Mycenae. These Phoenician imitative designs are still good imitations. But a century or so later we meet with them again on the silver bowls and dishes from Cyprus, in which the imitations have become bad. The same mixture of subjects was still in vogue, but confusion has been superadded to mixture, and we find kings in Assyrian robes and Egyptian wigs slaying Syrian dragons with Egyptian wings, and so on. Fig. 2 gives a silver dish from Curium containing examples of the above-mentioned subjects. It is a characteristic specimen of this mixed Phoenician art, of which di Cesnola seems to have collected a remarkable number of examples. In addition to the numerous silver phialae some were found, with similar decoration, made of pure gold. To the same period as these bowls from Cyprus belong the similar specimens of Phoenician plate from Etruscan graves at Praeneste and Cervetri in Italy. Those from the Regolini-Galassi tomb can hardly be earlier than the 6th century, so that this peculiar *Mischkunst* of the later type may well be dated to the 7th-5th centuries.

REFERENCES.—Von Bissing, "Metallgefäße" *Cairo Museum Catalogue* (1901); "Eine Bronzeschale mykenischer Zeit," *Jahrb. Inst.* (1898); L. P. di Cesnola, *Cyprus*; Layard, *Nineveh*, &c.

(H. R. H.)

Prehistoric Greece: "Minoan" and "Mycenaean" Periods.—In the early history of the goldsmith's art no period is more important than that of the Greek Bronze age, the period of the prehistoric civilization which we call "Minoan" and "Mycenaean," which antedated the classical civilization of Greece by many centuries, and was in fact contemporary and probably coeval with the ancient culture of Egypt. In Greece during this, her first, period of civilization, metal-work was extensively used, perhaps more extensively than it ever was in the history of later Greek art. So generally was metal used for vases that even as early as the "Middle Minoan" period of Cretan art (some 2000 years B.C.) the pottery forms are obvious imitations of metal-work. The art of the metal-worker dominated and influenced that of the potter, a circumstance rarely noted in Egypt, where, in all probability, the toreutic art was never so much patronized as in Minoan Greece, although beautiful specimens of plate were produced by Egyptian and Phoenician artists. Also but few of these have come down to us, and we are forced to rely upon pictured representations for much of our knowledge of them. It is otherwise in early Greece. We possess in our museums unrivalled treasures of ancient toreutic art in the precious metals from Greece, which date from about 2500 to 1400 B.C., and as far as mass and weight of gold are concerned are rivalled only by the Scythian finds. These are the well-known results of the excavations of Schliemann at Troy and Mycenae and of others elsewhere. They do not by any means suffer in point of additional interest from the fact that they were made and used by the most ancient Greeks, the men of the Heroic age, probably before the Greek language was spoken in Greece.

The most ancient of these "treasures" is that discovered by Schliemann in 1873 buried, apparently in the remains of a box, deep in the fortification wall of Hissarlik the ancient Troy. It consists of vases and dishes of gold and silver, and of long tongue-shaped ingots of silver. In consonance with the early date (perhaps about 2500 B.C.) to which they are probably to be assigned (Schliemann ascribes them to the second Trojan city) these objects are all of simple type, some of the vases being

unornamented jugs with tubular suspension-handles on the sides. Here we have metal imitating stonework, as, later, pottery imitates metal. These are of silver. A unique form in gold is a boat-shaped cup with handles at the sides (Plate I., fig. 23), at Berlin, which weighs 600 grammes. One vase is of electrum (one part of silver to four of gold).

A treasure of much the same date (the second "Early Minoan" period, about 2500 B.C. or before) was discovered in May 1908 in graves on the island of Mochlos, off the coast of Crete, by R. B. Seager. This is, however, of funerary character, like part of the treasures discovered in the shaft-graves of Mycenae, and, while including diadems, golden flowers, olive branches, chains, and so forth, for the adornment of the dead, does not include much gold used by the deceased during life.

The much later Mycenaean treasures include both funerary objects of thin gold and objects of plate that had actually been used. Among the former should be especially noted the breast-plates, diadems and masks which were placed on the bodies of the chieftains whom Schliemann, great in faith as in works, honestly believed to be Agamemnon and his court (and he may not have been very far wrong). Among the latter we may mention the small flat objects of gold plate, little sphinxes and octopuses modelled in relief, small temples with doves, roundels with spiral designs, and so on, which were ornaments for clothing, and the golden plate decorations of weapon-handles. The great cast-silver bull's head with the gold rosette on its forehead may perhaps have been regarded simply as a beautiful object of price, and buried with its owner. Similar *protomae* of bulls (of gold or silver) were brought by Minoan ambassadors as presents to the Egyptian court in the reign of Thothmes III. Gold and silver vases were found both in the shaft-graves, in the treasure-pit close by, and in chamber tombs at Mycenae. The most usual shape in the shaft-tombs is that well known to us from the vases of Vaphio, described below; among other types may be mentioned specially the *δέρας ἀμφικύπελλον* with doves feeding above its handles (Plate I., fig. 21; from a restored reproduction)—*δοιαί δὲ τελειάδες ἀμφὶς ἑκαστον χρύσειαι νεμήθοντο*; the golden jug with spiral decoration from the fourth grave; and the cup with lions of Egyptian appearance chasing each other round its bowl, found in grave 5. The fragment of a silver vase with a scene in high relief of slingers and bowmen defending their town against besiegers from grave 4 (Plate I., fig. 22), is an object unrivalled in ancient art. On this, as on the bull's head, we have gold overlaid on silver (with an intermediate plating of copper); on a silver cup from the same grave we find gold inlay, and on another silver cup, from a chamber-tomb, enamel and gold inlay. How the Minoan goldsmith could combine silver with gold and the two with bronze we see on the marvellous inlaid dagger-blades from Mycenae, with their pictures in many-coloured metals of lion-hunts, cats chasing birds, and so forth, which show that he was perhaps the greatest master of all time in this art.

We speak of him as "Minoan," because most of the metal objects found at Mycenae are, if not of actual Minoan workmanship and imported from Crete, at any rate designed in accordance with the Minoan taste of the "Great Palace Period" (Late Minoan i. and ii.) at Cnossus. They are only "Mycenaean" in the sense that they were found at Mycenae. Of the art of the gold vase maker in the Mycenaean period properly speaking (Late Minoan iii.) we obtain an idea from the pictures of golden *Bügelkannen* with incised designs of zigzags, &c., represented on the walls of the tomb of Ramses III. at Egyptian Thebes. The objects from the Mycenaean shaft-graves are much older than this, as are also those from the next treasure we shall mention, that from Aegina, now in the British Museum. The gold cups and other objects of this treasure, with their fine but simple decoration, are certainly to be ascribed to the best Minoan period, although when first published Dr A. J. Evans was inclined to assign them to so late a date as c. A.D. 800. They are surely some seven hundred years older, having no characteristic of the decadent "sub-Mycenaean" period, as

Dr Evans would doubtless now agree. These objects were probably found in a tomb.

Dr Evans's excavations at Cnossus, those of the Italians at Phaestos and Hagia Triada and those of the British school at Palaikastro have not produced any very striking examples of the Minoan goldsmith's art in his own country, though splendid bronze bowls and vases have been found, which give us a good idea of what the plate must have been like, as do also the gilt steatite imitations of plate mentioned below. One of the bronze vases from Cnossus exactly resembles one of gold and silver which was brought to Egypt by the ambassadors in Queen Hatshepsut's time (fresco in the tomb of Senmut). But we possess a fine silver cup (of the Middle Minoan period) from the American excavations at Gournia, and two examples of the finest Minoan gold plate, which were discovered outside Crete, in the famous "Vaphio cups," with their embossed representations of bull-netting, which have been illustrated so often as triumphs of ancient art (Plate I., figs. 24, 25). These are of Cretan workmanship, though found in Laconia, and are no doubt contemporary with the vases of black steatite with reliefs showing a harvest-home procession, gladiatorial combats, and a king receiving or bidding farewell to a warrior with his armed followers, which have been found by the Italians at Hagia Triada in Crete. These were originally overlaid with gold leaf, and are undoubtedly imitations in a cheap material of golden embossed vases of the same style as those found at Vaphio.

Next in order of time came the objects of gold and silver plate found by the expedition of the British Museum at Enkomi in Cyprus, which perhaps represent a somewhat later phase of Minoan art, but certainly cannot now any longer be regarded as belonging to the very late period to which they were at first assigned. One silver vase found at Enkomi is of the "Vaphio" shape, which first appears in Cretan pottery as early as the Middle Minoan period, contemporary with the XIIth Egyptian Dynasty (c. 2000 B.C.), and even then is clearly an imitation of a metal original. Slightly modified, this type remained late in use, as we find it represented among other golden vases on the walls of the tomb of Imisib or Imadua, an Egyptian official of the time of Ramesses IX. (c. 1100 B.C.) at Thebes. But some, at least, of the Enkomi finds must be earlier than this.

The Egyptian representations of Minoan vases of gold and silver in the tomb of Senmut at Thebes (c. 1500 B.C.) and of later Mycenaean golden *Bügelkannen* in that of Ramesses III. (c. 1150 B.C.) have been mentioned already. During the age of Mycenaean and sub-Mycenaean decadence the art of the Greek goldsmith necessarily passed through a period of eclipse, to arise again, with the other arts, in rich and luxurious Ionia probably. The Homeric poems preserved for later days a traditional echo of the glorious works of the metal-workers of the Heroic age.

REFERENCES.—Troy and Mycenae: Schuchhardt, *Schiemann's Excavations*; Tsountas-Manatt, *The Mycenaean Age*, passim. Vaphio: Tsountas-Manatt, *Aigina*; A. J. Evans in *Journ. Hell. Stud.*, xiii. 195-226. Cnossus: Evans, *Ann. Sch. Ath.* (1901-1907). Hagia Triada: Savignoni, Pernier and others, *Rendiconti della R. Accademia dei Lincei* (Rome, 1902-1906); Gournia: Mrs Boyd Hawes, *Gournia* (Philadelphia, 1908), pl. c.; Mochlos (unpublished). For Egyptian references see Hall, *Ann. Sch. Ath.* (1904), "Keftiu and the Peoples of the Sea" (1905); "The Keftiu-fresco in the Tomb of Senmut." (H. R. H.)

Etruscan Plate.—The Etruscans were specially renowned for their skill in working all the metals, and above all in their gold work. Large quantities of exquisite gold jewelry have been found in Etruscan tombs, including, in addition to smaller objects, sceptres, wreaths of olive, and plates decorated with filigree-work and animal figures, which were used as personal ornaments (breastplates, girdles, diadems, &c.). In the Museo Kircheriano in Rome is a magnificent specimen of the last form of ornament; it is covered with nearly a hundred little statuettes of lions arranged in parallel rows; and the Vatican (Musco Gregoriano) possesses a very fine collection of similar objects from the "Regulini-Galassi" tomb at Caere. Little, however, that can be classed under the head of plate has yet been found.

Hellenic Plate.—The period of "geometrical" art which followed the Mycenaean age was one of decline in material prosperity and artistic skill. We possess some specimens of the work then produced in the precious metals in the gold diadems placed on the head of corpses interred at Athens (*Archäologische Zeitung*, 1884, pls. viii., ix.; cf. *Athenische Mittheilungen*, 1866,



FIG. 3.—Silver Cantharus from Rhodes, with gold mounts. Possibly the form of the Homeric *κίρας ἀμφικύπελλον*.

p. 367; and G. Perrot and C. Chipiez, *Histoire de l'art dans l'antiquité*, vii. 245). The period of Oriental influence is represented by the finds of gold ornaments made at Camirus in Rhodes (see GREEK ART, fig. 111). Fig. 3 shows a silver cup, with gold mounts, also found at Camirus, apparently a work of the same early date. A remarkable find of gold objects was made in 1882 at Vetterfelde in Brandenburg; the principal piece was a gold fish (see GREEK ART, fig. 10) with ornaments in relief. These objects recall by their style early Ionic art, but were probably produced in one of the Black Sea colonies, since similar objects have been found, together with later work, in Crimean graves (see below), and exchanged for the amber of the Baltic coasts. Croesus especially encouraged the art, and paid enormous sums for silver vases and cups to the most renowned artists of his time, such as Glaucus and Theodorus the Samian. The British Museum possesses a fine specimen of archaic Greek plate, found at Agrigentum in Sicily. This is a gold phiale or bowl, about 5 in. across, with central boss or



FIG. 4.—Archaic Gold Phiale, found at Agrigentum, now in the British Museum. It is shown in section below. It is 5 in. in diameter.

omphalos (*φάλη μεσομφαλος*) which seems once to have contained a large jewel. Round the inside of the bowl are six figures of oxen *repousés* in relief, and at one side a crescent, formed by punched dots. A delicate twisted moulding surrounds the edge; the workmanship of the whole is very skilful (see fig. 4).

Pliny (*N. H.* xxxiii. 154 sqq.) gives a brief valuable account of the art of silver chasing (*caelatura*, Gr. *τορυρισμός*).

In the best times of Greek art the chief works in gold and silver seem to have been dedicated to religious purposes, and to have been seldom used for the ostentation of private individuals. Vessels for the use of the temples, tripods in gold or silver

of the richest work, and statues of the gods were the chief objects on which the precious metals were lavished.¹

The gold used by the Greeks probably came from Asia Minor or Egypt, while the mines of Laurium, in the mountains which form the promontory of Sunium in Attica, supplied an abundant amount of silver for many centuries. According to Pliny,

of Ulysses and Diomedes carrying off the Palladium. Enormous prices were given by wealthy Romans for ancient silver plate made by distinguished Greek artists; according to Pliny, the last-mentioned cup, which weighed 2 oz., was sold for 10,000 denarii (£350). It is worthy of note that a large number of the artists named by Pliny were natives of Asia Minor, and

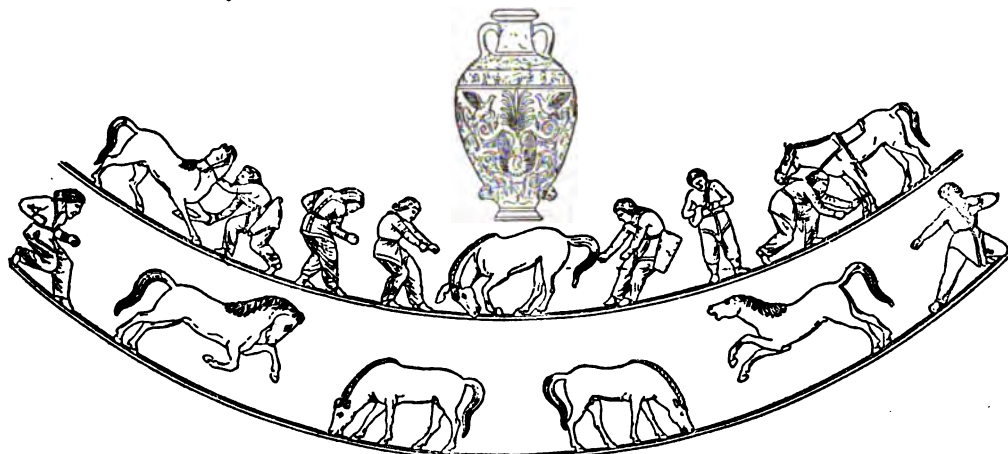

FIG. 5.—Greek Silver Vase, 4th century B.C., from South Russia.

Pheidias was the first sculptor who produced works of great merit in the precious metals; he mentions a number of other Greek artists who were celebrated for this class of work, but does not give their dates. The chief of these were Mentor and Mys (both of the 5th century B.C.), Acragas, Boethus, the sculptors Myron

and Stratoniceus, as well as the well-known Praxiteles and Scopas. In Pliny's time many works in gold and silver by these artists still existed in Rhodes and elsewhere. Among later workers he specially mentions Zopyrus, who made two silver cups, embossed with the scene of the judgment of Orestes by the Areopagite court,² and Pytheas, who made a bowl with reliefs



FIG. 6.—Silver Crater, found in Ithaca. (3½ in. high.)

of Ulysses and Diomedes carrying off the Palladium. Enormous prices were given by wealthy Romans for ancient silver plate made by distinguished Greek artists; according to Pliny, the last-mentioned cup, which weighed 2 oz., was sold for 10,000 denarii (£350). It is worthy of note that a large number of the artists named by Pliny were natives of Asia Minor, and

it is very probable that the Asiatic school of silversmiths had at least as much influence on Roman *caelatura* as that of Alexandria, whose importance has been overrated by Schreiber.

The finest extant examples of Greek plate are those found in the tumuli of south Russia, especially in the neighbourhood of Kerch, the ancient Panticapaeum. Fig. 5 shows a silver vase found in 1862 at Nikopol in the tomb of a native Scythian prince. The native horse-tamers of the steppes are represented on the shoulder with wonderful naturalism, and the work is beyond doubt that of an Athenian artist of the 4th century B.C. Splendid examples of goldwork were found in the tumulus of Kuloba, about 6½ kilometres from Kerch, which was excavated in 1830 and found to be the burial-place of a Scythian prince and his wife. The jewelry and plate found in this tomb, which were clearly of Greek origin, comprised (amongst other objects) an electrum vase 13 cm. high, representing Scythians in their native costume, one of whom is extracting a neighbour's tooth, another binding up a wound, a third stringing a bow, besides several silver vases and two gold medallions with reproductions of the head of the Athena Parthenos of Pheidias. In these Crimean tombs are often found golden crowns in the form of oak leaves, some of which belong to late Roman times. The finest extant example of a gold wreath, however, is that discovered at Armento in south Italy and preserved in the Antiquarium at Munich, it bears an inscription of the 4th century B.C., showing that it was dedicated by a certain Kreithonios. In 1812 Dr Lee discovered at Ithaca a beautiful crater, 3½ in. high (see fig. 6), and a phiale or patera, 9½ in. across, both of silver, *repoussé* and chased, with very rich and graceful patterns of leaves and flowers picked out with gilding.³ These are probably not later than the 5th century B.C. Many silver mirror-cases, with *repoussé* figure-subjects in high relief, have been found at various places; as, for instance, one with a beautiful seated figure of Aphrodite found at Tarentum and now in the British Museum.⁴

at Rome (Michaelis, *Das corinthische Silbergefäß*, 1859; cf. W. Amelung, in *Römische Mitteilungen*, 1906, pp. 289 sqq.) may reproduce the design of Zopyrus.

² See *Archaeologia*, xxxiii. 36-54.

⁴ *Ibid.* xxxiv. 265-272.

¹ The gold eagles on the sacred omphalos at Delphi were notable examples of this; see Pindar, *Pyth.* iv. 4.

² It has been thought that a silver cup in the Coraini collection

The Victoria and Albert Museum contains an exquisite little silver vase, found in the baths of Apollo at Vicarillo in Italy (fig. 7), enriched with a band in low relief of storks devouring serpents executed with gemlike minuteness and finish—probably not later than the 3rd century B.C. The British Museum has a little vase of similar form and almost equal beauty, though perhaps later in date, it is decorated with bands of vine branches in a graceful flowing pattern, and is partly gilt.

Graeco-Roman Plate.—During the last century of the Republic the growing luxury and ostentation of the wealthy Romans found expression in the collection of elaborate specimens of plate.



FIG. 7.—Greek Silver Vase, 5 in. high, c. 3rd century B.C. The ornamental band is shown below in plano. (Victoria and Albert Museum.)

The works of the old Greek masters were the most highly prized, but contemporary artists, such as Pasiteles, also attained distinction in this branch of art. Amongst the numerous finds of silver plate made in modern times we may distinguish

(a) temple treasures made up of votive offerings, such as the treasure of Bernay in France (dep. Eure), discovered in 1830 and preserved in the Cabinet des Médailles, which belonged to the shrine of Mercurius Canetonensis, (b) private collections.



FIG. 8.—Silver Crater, 15½ in. high, from the Hildesheim find. (Berlin Museum.)

The most famous of these are the Hildesheim treasure, in the Berlin Museum, discovered in 1869, which has been thought (without adequate reason) to have formed part of the campaigning equipment of a Roman military commander, and the Bosco Reale treasure, found in 1895 in a villa near Pompeii, whence its owner was endeavouring to remove it when buried by the eruption of Vesuvius. These collections contain pieces of various dates. The Bernay treasure, in part belonging to the 2nd century A.D., contains *oenochoi* (ewers) with mythological subjects in relief inspired by classical Greek models—the theft of the Palladium was the subject of a famous cup of Pytheas, mentioned by Pliny—which must belong to the early imperial period. The Hildesheim treasure, again, contains two barbaric vases, without feet or handles, together with such fine pieces as the crater figured (fig. 8),

whose decoration recalls that of the Ara Pacis Augustae (see ROMAN ART), and a cylix with a seated figure of Athena in high relief, soldered on to the centre of the bowl, which appears to be of Greek workmanship. Such detachable figures were termed *emblemata*, in the Bosco Reale treasure is a cup with such a bust, typifying the province of Africa. Great value was also set upon *crustae*, i.e. bands of *repoussé* work forming an outer covering to a smooth silver cup (cf. the Rothschild vases, ROMAN ART). Such works commonly have Latin inscriptions incised on the foot giving the weight of the piece, the cup and *emblema* being weighed separately. The artistic value of Roman plate is discussed under ROMAN ART.

Among later specimens of Roman plate the most remarkable is the gold patera, nearly 10 in. in diameter, found at Rennes in 1777, and now in the Paris Bibliothèque—a work of the most marvellous delicacy and high finish—almost gem-like in its minuteness of detail. Though not earlier than about 210 A.D., a slight clumsiness in the proportion of its embossed figures is the only visible sign of decadence. The outer rim is set with sixteen fine gold coins—*aurei* of various members of the Antonine family from Hadrian to Gete. The central *emblema* or medallion represents the drinking contest between Bacchus and Hercules, and round this medallion is a band of *repoussé* figures showing the triumphal procession of Bacchus after winning the contest. He sits triumphant in his leopard-drawn car, while Hercules is led along, helplessly intoxicated, supported by *bacchanals*. A long line of nymphs, fauns and satyrs complete the circular band.

Late Roman plate is also represented by a series of large silver dishes, to which the name *missorium* is often, though perhaps wrongly, applied. These were used for presentations by emperors (whose portraits they sometimes bear) and distinguished officials. Three are preserved in the Cabinet des Médailles of the Bibliothèque Nationale at Paris—the “shield of Scipio,” found in the Rhone near Avignon, about 26 in. in diameter, with a relief representing the restoration of Briseis to Achilles;¹ the “shield of Hannibal,”² chiefly remarkable for



FIG. 9.—Shield of Theodosius.

its size (it is 72 cms. in diameter and weighs 10 kilogrammes); and a third, decorated with a group of Hercules and the Nemean lion.³ Other well-known examples of this form of art are the

¹ Cf. S. Reinach in *Gazette des beaux-arts* (1896).

² Cf. E. Babelon, in *Bulletin de la société des antiquaires de la France* (1890), p. 228.

³ Cf. E. Frot, in *Gazette archéologique* (1886).

"shield of Theodosius" at Madrid (fig. 9), which represents the emperor seated between Valentinian II. and Arcadius¹; the "shield of Valentinian" at Geneva²; the "shield of Aspar" at Florence³; and a fine dish found at Aquileia, now at Vienna.⁴

The British Museum contains some fine specimens of late Roman silver work, found on the Esquiline in 1793 (cf. Visconti, *Una Suppellettile d'argento*, Rome, 1825; the objects are published and described in Mr Dalton's *Catalogue of the Early Christian Antiquities in the British Museum*, pp. 61 sqq., pls. xiii.-xx.). The most remarkable of these are: (i) a silver casket decorated in *repoussé*, with the inscription SECONDE ET PROJECTA VIVATIS IN CRISTO, doubtless a wedding gift to a couple bearing the names of Secundus and Projecta, whose portraits appear in a medallion on the centre of the lid; (ii) four statuettes representing personified cities—Rome, Constantinople, Antioch and Alexandria (cf. P. Gardiner in *J. H. S.*, 1888, ix. 77 sqq.). This treasure appears to belong in the main to the 5th century A.D., though some minor pieces may be earlier.

BIBLIOGRAPHY.—A general account will be found in Smith's *Dictionary of Antiquities*, 3rd ed. s.v. "Caclatura" (without illustrations), and in Daremberg and Saglio's *Dictionnaire des antiquités*, under the same heading (with several cuts). The passages in ancient writers which refer to the art will be found in Oberbeck's *Antike Schriftquellen* Nos. 2167-2205; Pliny's account is most conveniently studied in K. Jex-Blake and E. Sellers, *The Elder Pliny's Chapters on the History of Art*, pp. 2 sqq. The finds made in southern Russia were published in the *Antiquités du Bosphore cimmérien* (St Petersburg, 1854); the *Comptes rendus de la commission impériale* (St Petersburg, 1859 sqq.); and the *Recueil des antiquités de la Scythie* (1866-1873). The first of these works, which is very rare, has been republished on a reduced scale by M. Salomon Reinach, in his *Bibliothèque des monuments figurés* (Paris, 1892) with notes; and all the more important objects are figured in *Antiquités de la Russie méridionale*, by Kondakoff, Tolstoy and Reinach (Paris, 1891-1892). For Graeco-Roman plate the most important works are Héron de Villefosse's publication of the Bosco Reale treasure in the *Monuments Piot*, vol. v. (cf. the articles by the same author and M. Thédenat on "Les Trésors de vaiscelle d'argent trouvés en Gaule," *Gazette archéologique*, 1883-1884), and *Der hildesheimer Silberfund*, by E. Pernice and F. Winter (Berlin, 1901). Reference should also be made to T. Schreiber, "Die alexandrinische Toreutik," (*Abhandlungen der sächs. Gesellsch. der Wissenschaften*, 1894, vol. xiv.), whose theories are somewhat exaggerated; and A. Odobescu, *Le Trésor de Petrossa* (1889-1900), which deals with a find of barbaric plate and jewelry made in Rumania, but gives much information on the history of the art. For early Greek work, see R. Schneider, "Goldtypen des griechischen Ostens," *Berichte der sächs. Gesellsch. der Wissenschaften* (1891, p. 20), and A. Furtwängler, *Der Goldfund von Vellersfeld* (1893). For Etruscan metal-work, see J. Martha, *L'Art étrusque*, ch. xvii. An interesting popular account of ancient work in precious metals will be found in E. T. Cook's *Popular Handbook to the Greek and Roman Antiquities in the British Museum*, pp. 569 sqq. (H. S. J.).

Oriental, African Plate, &c.—Some very curious pieces of plate, both in gold and in silver, have been found in northern India in which country the goldsmith's art is of great antiquity;⁵ these appear to be of native workmanship, but the subjects with which they are embossed, and the modelling of the figures, show that they were produced under late Roman influence, or in some cases possibly even Greek influence in a highly degraded state, handed down from the time of Alexander's Indian conquests. A fine gold casket (Buddhist relic) said to date from about 50 B.C. is worthy of note.⁶ In the British Museum are an Indian silver dish (3rd-4th century A.D.)⁷ and an earlier one, ascribed to c. A.D. 200.

Under the Sassanian kings of Persia (from the 3rd to 6th centuries) very massive and richly decorated gold vases, bowls,

and bottles were made (fig. 10). Those which still exist show a curious mingling of ancient Assyrian art with that of Rome

in its decline. Reliefs representing winged lions, or the sacred tree between its attendant beasts, alternate with subjects from Roman mythology, such as the rape of Ganymede; but all are treated alike with much originality, and in a highly decorative manner. A fine example of Persian work of the early 10th century (dated 1817) is the circular gold dish, richly enamelled, which is in the Victoria and Albert Museum, where a large collection of Oriental plate may be studied. Here may be seen a gold rose-water sprinkler of gold, entirely covered with richly enamelled flowers, Mogul work, 17th century; fine Burmese gold work found in A.D. 1484-1485 in a Buddhist temple, Rangoon; remarkable gold ornaments of the Burmese regalia; and a large elephant howdah, from the Punjab, made of silver, parcel gilt, the top covered with silver plates of large *repoussé* foliage. Tibetan craftsmen work is represented by numerous vessels for sacred and domestic purposes, mostly of metal, partially mounted in silver, which display the skill of the Tibetans in the 19th century. Of the skill of the Hindus as goldsmiths, abundant evidence is afforded by the *Ramayana* and *Mahābhārata*, though very little of their ancient gold and silver work has survived. In India the people of the Cashmere valley have long been famous for their natural superiority as craftsmen, as was Lucknow for its utensils of gold and silver, much of it richly enamelled in the 18th and 19th centuries. Chanda in the Central Provinces was once celebrated for its skilled goldsmiths, and the plate of Cutch and Gujarat in the Bombay Presidency has enjoyed a well-deserved reputation. The uncontaminated indigenous designs of the Sind goldsmiths' work call for special notice. Indian plate, as is quite natural, has often been influenced by European designs: for instance, the beautiful gold and silver work of Cutch is Dutch in origin, while the ornate throne of wood covered with plates of gold, early 19th century, used by Ranjit Singh (at South Kensington) also displays European influence. Much of the Siamese decorative plate of the 18th and 19th centuries is of silver-gilt and nielloed. In the Rijks museum, Amsterdam, is a collection of silver dishes, boxes of gold and silver, jewelry, &c., all of excellent workmanship, from Lomboc. African goldsmiths' work is represented in the British Museum by the gold ornaments from Ashanti, where there are also some gold ornaments from graves in Central America and Colombia. Ancient Abyssinian work can be studied at the Victoria and Albert Museum in the gold chalice, gold crown of the Abuna of Abyssinia, another more ornate crown of silver-gilt, a fine shield with silver-gilt filigree, and other objects.

FIG. 10.—Sassanian Gold Bottle, about 10 in. high. In the Vienna Museum.



The gold and silver work of Russia resembles in style that of Byzantium at an early period. Shrines and other magnificent pieces of plate in the treasury of the cathedral at Moscow (see Weltmann, *Le Trésor de Moscou*, 1861), though executed at the end of the 15th and 16th century, are similar in design to Byzantine work of the 11th or 12th century, and even since then but little change or development of style has taken place. The caliphs of Bagdad, the sultans of Egypt, and other Moslem rulers were once famed for their rich stores of plate,

¹ Cf. E. Hübnér, *Die antiken Bildwerke in Madrid*, pp. 213 sqq.

² A. Odobescu, *Le Trésor de Petrossa*, pp. 153 sqq., fig. 68.

³ D. Bracci, *Dissertatione sopra un clipeo volitto* (Lucca, 1771).

⁴ See R. v. Schneider, *Album auserlesener Gegenstände der Antikensammlung des allerhöchsten Kaiserhauses* (1895); and cf. *Verhandlungen der 42. Versammlung deutscher Philologen* (1893), pp. 297 sqq.

⁵ Sir G. Birdwood, *Industrial Arts of India* (1880).

⁶ Wilson's *Arcana antiqua* (1841).

⁷ *Archaeologia*, iv. 534.

which was probably of extreme beauty both in design and workmanship. Little or nothing of this Moslem plate now remains, and it is only possible to judge of its style and magnificence from the fine works in brass and other less valuable metals which have survived to our time.

Towards the end of the 10th century the Rhine valley became the centre of a school of goldsmiths, who produced splendid examples of their work—a mixture of Byzantine art with their own original designs. The book-covers, portable altars and other objects, preserved at Trier and Aix-la-Chapelle, are notable examples produced at that centre. The magnificent book-cover from Echternach, now at Gotha, is of the school of Trier.

Early Medieval Plate.—The Gothic, Gaulish and other semi-barbarian peoples, who in the 6th century were masters of Spain, France and parts of central Europe, produced great quantities of work in the precious metals, especially gold, often of great magnificence of design and not without some skill in workmanship. The Merovingians encouraged the art of the goldsmith by spending immense sums of money on plate and jewelry, though only two examples of their great wealth in church vessels have survived—the gold chalice and paten of Gourdon, now at Paris. Fine examples of Carolingian work, which was mainly wrought in the monasteries in the north of the Frankish dominions and on the Rhine, may be studied in the covers for the Gospels, in the Bibliothèque Nationale in Paris. In 1837 a large number of pieces of very massive gold plate were found at Petrossa in Rumania; much of this find was unfortunately broken up and melted, but a considerable portion was saved, and is now in the museum at Bucharest. These magnificent objects are all of solid gold, and consist of large dishes, vases,



FIG. 11.—Gold Ewer, 15 in. high, from the Petrossa treasure.

cwers, baskets of open work, and personal ornaments (fig. 11). Some of them show a strong Roman influence in their design, others are more purely barbaric in style. To the first of these classes belongs a very fine phiale or patera, 10 in. in diameter. In the centre is a seated statuette of a goddess, holding a cup, while all round, in high relief, are standing figures of various male and female deities, purely Roman in style. Though the execution is somewhat clumsy, there is much reminiscence of classical grace in the attitudes and drapery of these figures. A large basket and other pieces, made of square bars of gold arranged so as to form an open pattern of stiff geometrical design, have nothing in common with the vessels in which Roman influence is apparent, and can hardly be the work of the same school of goldsmiths.¹ The date of this Petrossa treasure is supposed to be the 6th century. The celebrated Gourdon gold cup and tray now preserved in Paris belong to about the same date. They are very rich and magnificent, quite free from any survival of classic influence, and in style resemble the Merovingian gold work which was found in the tomb of Childeric I. The cup is 3 in. high, shaped like a miniature two-handled chalice; its companion oblong tray or plate has a large cross in high relief in the centre. They are elaborately ornamented with inlaid work of turquoises and garnets, and delicate filigree patterns in gold, soldered on.

In the 6th century Byzantium was the chief centre for the production of large and magnificent works in the precious metals. The religious fervour and the great wealth of Justinian and his successors filled the churches of Byzantium, not only with enormous quantities of gold and silver chalices, shrines, and other smaller pieces of ecclesiastical plate, but even large altars, with tall pillared baldacchini over them, fonts, massive candelabra, statues, and high screens, all made of the precious metals. The wealth and artistic splendour with which St Peter's

¹ Soden Smith, *Treasure of Petrossa* (1869).

in Rome and St Sophia in Constantinople were enriched is now almost inconceivable. To read the mere inventories of these treasures dazzles the imagination—such as that given in the *Liber pontificalis* of Anastasius Bibliothecarius, which includes the long list of treasures given by Constantine to St Peter before he transferred his seat of empire to Byzantium (330), and the scarcely less wonderful list of gold and silver plate presented to the same basilica by Pope Symmachus (498–514).²

Some early Byzantine plate of the 6th century is in the British Museum; an inscribed paten of the 10th and 11th centuries is in Halberstadt Cathedral in Germany, and numerous ecclesiastical vessels are in the Treasury of St Mark's, Venice.

Early in the medieval period France and other Western countries were but little behind Italy and Byzantium in their production of massive works, both secular and religious, in the precious metals. At this time every cathedral or abbey church in Germany, France and even England began to accumulate rich treasures of every kind in gold and silver, enriched with jewels and enamel; but few specimens, however, still exist of the work of this early period. The most notable are Charlemagne's regalia³ and other treasures at Aix-la-Chapelle, a few preserved at St Peter's in Rome, and the remarkable set of ecclesiastical utensils which still exist in the cathedral of Monza near Milan—the gift of Queen Theodelinda in the early part of the 7th century.⁴ The treasure of Nagy-Szent-Miklos, consisting of several vessels of gold, of Hungarian origin (8th–9th century), is in the Imperial Museum at Vienna.

The existing examples of magnificent early work in the precious metals mostly belong to a somewhat later period. The chief are the gold and silver altar in Sant' Ambrogio at Milan, of the 9th century; the "Pala d'Oro," or gold retable, in St Mark's at Venice, begun in the 10th century; the silver altar-front in St Domenico's Church at Palermo; the shrine of silver-gilt (with later additions) in the church of St Simeon at Zara, Dalmatia, by Francesco di Antonio of Sesto near Milan, 1380; and the gold altar-frontal given by the emperor Henry II. and his wife Cunigunde, at the beginning of the 11th century, to the cathedral at Basel. The last is about 4 ft. high by 6 ft. long, *repoussé* in high relief, with figures of Christ, the three archangels, and St Benedict, standing under an arcade of round arches; it is now in the Musée Cluny in Paris.⁵ A similar gold frontal, of equal splendour, was that made for the archbishop of Sens in 909. This was melted down by Louis XV. in 1760, but fortunately a drawing of it was preserved, and is published by Du Sommerard (*Album*, 9th series, pl. xiii.). Reliquaries of great splendour were made of the precious metals, one of the most notable being that containing the skulls of the three kings in Cologne Cathedral. This shrine, which resembles in form a building of two storeys, was wrought in the 12th century. The covers of the Textus in the Victoria and Albert Museum are highly important examples of goldsmiths' work; they are of gold and silver, decorated with enamel and set with stones, probably dating from the 12th century.

Celtic.—The skill in metal-working of the Celtic people in the British Islands, especially in Ireland, in Pagan and Christian times, is well known, and need hardly be emphasized here. While much has perished, much happily remains in proof of their extraordinary skill in working gold and silver, particularly in jewelry. The most remarkable specimen of their technical skill and artistic perception is the famous Ardagh chalice of the 9th–10th century (in the museum at Dublin) (Plate II., fig. 31), which is composed chiefly of silver, with enrichments of gold and gilt bronze, and with exquisite enamels. The interlaced ornament is a feature of Celtic work, and may further be studied in the celebrated Tara brooch, with its seventy-six varieties of designs as well as in other exquisite examples of jewelry. Further evidence of Celtic skill is forthcoming in the shrines for the sacred bells in Ireland, not to mention other ecclesiastical

² See D'Agincourt, *Histoire de l'Art* (1823).

³ Bock, *Die Kleinodien des heid. römischen Reiches* (1864).

⁴ *Arch. Jour.*, xiv. 8.

⁵ *Archæologia*, xxx. 144–148.

ornaments. These are of great beauty, and the silver shrine of the bell of St Patrick (1091-1105) displays the interlaced scroll ornament in a striking degree. With the introduction of Gothic art into Britain the special characteristics of Christian Celtic art in Ireland gradually died out.

Anglo-Saxon.—Judged by the examples of Anglo-Saxon jewelry discovered, the Anglo-Saxon craftsmen brought their art to a high state of perfection, though hardly equal in merit to the Celtic. A large quantity of their metal-work is of bronze, frequently enriched with gold and enamel. Happily, there is preserved one priceless specimen of the goldsmith's art of this period—namely, the famous Alfred jewel of gold, now in the Ashmolean Museum at Oxford, with a portrait, believed to be of Alfred the Great, in *cloisonné* enamel. Another notable specimen is the Ethelwulf ring in the British Museum. Though ecclesiastical vessels, doubtless of the precious metals, appear in Anglo-Saxon illuminated manuscripts, the only piece of plate of that time at present known is the plain silver cup of the latter part of the 9th century, found with gold and silver jewelry and pennies at Trewiddle in Cornwall, which is now in the British Museum.¹ There is, however, an important example of metal-work embellished with silver plates—namely, the portable altar of St Cuthbert at Durham.

A most valuable description of the various methods of work practised by gold- and silversmiths in the 11th and 12th centuries is given by the monk Theophilus in his *Diversarum artium schedula* (Hendrie's ed., 1847). He minutely describes every possible process that could be employed in making and ornamenting elaborate pieces of ecclesiastical plate—such as smelting, refining, hammering, chasing and *repoussé* work, soldering, casting (by the "cire perdue" process), wire-drawing, gilding with mercury amalgam, and the application of niello, enamel and gems.

The silversmith of those days, as in classical times, was not only a thorough artist with a complete sense of beauty and fitness in his work, but he was also a craftsman of the most varied fertility of resource, and made himself thoroughly responsible for every part of his work and every stage through which it passed—a most striking contrast to the modern subdivision of labour, and eagerness to produce a show of neatness without regard to real excellence of work, which is the curse of all 19th-century handicrafts, and one of the main reasons why our modern productions are in the main neither works of true art nor objects of real lasting utility.

Italian Plate.—Before the latter part of the 15th century, large pieces of silver work were made more for ecclesiastical use than for the gratification of private luxury. The great silver shrine in Orvieto Cathedral, made to contain the blood-stained corporal of the famous Bolsena miracle, is one of the chief of these. It is a very large and elaborate work in solid silver, made to imitate the west front of a cathedral, and decorated in the most sumptuous way with figures cast and chased in relief, and a wonderful series of miniature-like pictures embossed in low relief and covered with translucent enamels of various brilliant colours. This splendid piece of silver work was executed about 1338 by Ugolino da Siena, one of whose other works, a fine reliquary, is also at Orvieto. The other most important pieces of silver work in Italy are the frontal and retablo of St James in the cathedral at Pistoia² and the altar of San Giovanni at Florence. On these two works were employed a whole series of the chief Tuscan artists of the 14th and 15th centuries, many of whom, though of great reputation in other branches of art, such as painting, sculpture on a large scale, and architecture, did not disdain to devote their utmost skill and years of labour, to work which we now as a rule consign to craftsmen of the very smallest capacity. The following celebrated artists were employed upon the altar at Florence: Antonio Pollaiuolo, Michelozzo, Verrocchio, as well as less prominent artificers, Betto Geri, Leonardo di Ser Giovanni and Betto di Francesco Betti.

Among the distinguished names of Florentines who during

the space of one century only, the 15th, worked in gold and silver, the following may be given to suggest the high rank which this class of work took among the arts: Brunelleschi, Ghiberti, Donatello, Luca della Robbia, the two Pollaiuoli, Verrocchio, Michelozzo, Ghirlandalo, Botticelli, Lorenzo di Credi, Baccio Baldini and Francia. The cities of Italy which chiefly excelled in this religious and beautiful class of silver work during the 14th and 15th centuries were Florence, Siena, Arezzo, Pisa, Pistoia, Bologna, where there are fine 14th-century silver reliquaries executed by Jacopo Roseto da Bologna for the heads of St Dominic and St Petronio in the church of St Stefano, Perugia, where Paolo Vanni, Roscetto and others worked in the 14th and early 15th centuries, and Rome.

Owing to the demoralization and increase of luxury which grew in Italy with such startling rapidity during the early years of the 16th century, the wealth and artistic skill which in the previous centuries had been mainly devoted to religious objects were diverted into a different channel, and became for the most part absorbed in the production of magnificent pieces of plate—vases, ewers, dishes, and the like—of large size, and decorated in the most lavish way with the fanciful and over-luxuriant forms of ornament introduced by the already declining taste of the Renaissance. This demand created a new school of metal-workers, among whom Benvenuto Cellini (1500-1571) was perhaps the ablest and certainly the most prominent. His graphic autobiography makes him one of the foremost and most vivid figures of the wonderful 16th century, in which often the most bestial self-indulgence was mingled with the keenest enthusiasm for art. The large salt-cellar made for Francis I., now at Vienna, is the only piece of plate which can be definitely assigned to Cellini. The splendid Farnese casket, with crystal plaques engraved by Giovanni di Bernardi, in the Naples Museum, has been wrongly attributed to Cellini. His influence on the design of plate was very great, not only in Italy and France, but also in Germany.³ During the 17th century fine pieces of plate were produced in Italy, many of them still retaining some of the grace and refinement of the earlier Renaissance.

The papal treasure, containing priceless examples of the goldsmith's art, was almost entirely depleted by Pius VI. to pay the indemnity demanded by Napoleon. The tiara of Julius II. by Caradosso, and the splendid morse of Clement VII. by Benvenuto Cellini, coloured drawings of which are preserved in the Print Room, British Museum, are among the objects then destroyed.

A valuable source of study of Italian plate (now destroyed) is contained in the three volumes of drawings, executed between 1755 and 1764, by Grauenbroch, in the Museo Correr at Venice.

Germany.—From very early times Germany was specially famed for its works in the precious metals, mostly for ecclesiastical use. In the 15th century a large quantity of secular plate was produced of beautiful design and skilful workmanship.

Tall covered cups on with open work, filled in with translucent enamels. German or Flemish, like a pineapple, beakers and tankards, enriched with Gothic cresting and foliage, are



FIG. 12.—Silver Beaker, decorated with open work, filled in with translucent enamels. German or Flemish, of the 15th century. (S. K. M.)

¹ *Victoria History of Cornwall*, i. 375.

² E. Alfred Jones, "The Altar of Pistoia," *The Reliquary* (January, 1906), pp. 19-28.

³ See Eugène Plon, *Benvenuto Cellini, sa vie, &c.* (1883); also Cellini's own work, *Dell'Orfeceria* (1568).

among the most important pieces of plate. During the 16th century Augsburg and Nuremberg, long celebrated for their silver work, developed a school of craftsmen whose splendid productions have often been ascribed to the great Cellini himself. In the first decade of the 16th century, Paul Müller, a Nuremberg goldsmith, furnished Frederick the Wise with several silver-gilt reliquaries for his collection at Wittenberg. Later in the same century came the Jamnitzer family of Nuremberg, chief among them being Wentzel Jamnitzer, one of whose masterpieces, an enamelled silver centre-piece, belongs to the baroness James de Rothschild of Paris. Mathaeus Wallbaum of Augsburg was another celebrated goldsmith of the 16th century. His chief works are religious ornaments of ebony mounted in silver, and the *Pommerscher Kunstschränk* in the Kunstgewerbe Museum, Berlin. But the chief German goldsmith of the 16th century was Anton Eisenhoit¹ of Warburg, who wrought the fine crucifix (1589), the chalice and other ecclesiastical vessels which belong to the Fürstenberg family. Other notable craftsmen of this period were Hans Petzolt and Melchior Bayr, the latter having made the silver altar (with scenes from the Life of Christ after Dürer)



FIG. 13.—Silver Cup, 8½ in. high, usually attributed to Jamnitzer, but more probably by Paul Flint. Made at Nuremberg about the middle of the 16th century. (S. K. M.)



FIG. 14.—Ewer by François Briot, about 10 in. high. Middle of 16th century.

for the king of Poland, which is in the Sigismund chapel in Cracow Cathedral.² Jakob Mores, the elder, of Hamburg, was employed by the royal house of Denmark. A large number of his original designs for plate are in the public art library at Berlin. Jakob Mores, the younger, executed the silver altar at Frederiksberg in the 17th century. In Germany the traditions of earlier Gothic art were less rapidly broken with, and many purely Gothic forms survived there till the end of the 16th century, and Gothic decorative features even later. In the first half of the 17th century, though the technical skill of the German silversmiths reached a high standard of merit, there was some falling off in the execution and in the purity of outline in their designs. Germany is richer in secular plate than any other country. The remarkable royal collections of plate in the green vaults at Dresden, Gotha and Munich, as well as public museums in Germany, including the treasure of Lüneburg at Berlin, afford excellent opportunities for the study of the German goldsmith's art, the remarkable chalice, 12th century, of St Gothard's church, Hildesheim; the celebrated *Kaiserbecher* of Osnabrück

¹ Lessing, *Die Silber-Arbeiten von Anton Eisenhoit* (1880).

² Illustrated by Ordzywolski, in *Renaissance w Polsce*, pls. 11-12.

of the 13th century; the cup given by the emperor Frederick III. and Mathias Corvinus to Vienna in 1462, and the splendid ewer of Goslar, 1477, are notable specimens of early German work. In England the only public collections of German plate worthy of notice are the "Waddesdon" in the British Museum, and the Victoria and Albert Museum. Prior to its dispersal among his five daughters, the late baron Carl von Rothschild's collection at Frankfort-on-Main was the most extensive private collection in existence. The Gutmann collection, acquired by Mr J. Pierpont Morgan, contains many rare pieces, as does that of the baronesses Alphonse and Salomon de Rothschild in Paris.

Many of the most beautiful vessels of crystal, agate, &c., formerly attributed to Italian artists, were carved and engraved and set in beautiful enamelled gold and silver mounts, in southern Germany in the 16th and 17th centuries. At the end of the 17th and the beginning of the 18th centuries household plate and other ornaments were frequently decorated with painted enamels, mostly originating from Augsburg. Dinglinger of Dresden and his school at about this time exercised considerable influence in the production of ornaments in pearl and other materials, elaborately carved, mounted and enamelled.

Several specimens exist of the models of cups required of candidates for the rank of master-craftsmen in the second half of the 16th century. One of these, at the Victoria and Albert Museum, is believed to have been wrought by Martin Rehlein of Nuremberg in 1572-1573.³

Many of the famous 15th and 16th century artists—such as Martin Schön, Israel von Mecken, Aldegrever, Altdorfer, Brosamer, Peter Flötner, the Behams, Hopfer and Hans Holbein the younger, supplied the silversmiths with designs for plate. Several of Holbein's original designs, including one for the gold cup probably wrought by his friend, John of Antwerp, for Queen Jane Seymour, are in the Print Room, British Museum, where there is also an original design for a table fountain by the celebrated artist, Albrecht Dürer. Virgil Solis of Nuremberg (1514-1562) was especially fertile in designing plate, and he executed a large series of etchings of designs for vases, cups, ewers, tazze, &c.⁴ Many of the German silver ewers and basins resemble those made in pewter at the end of the 16th century by François Briot and Gaspar Enderlein, who migrated from Switzerland to Germany.

Switzerland.—This country produced several silversmiths whose work in the main follows that of the German school. The three historical beakers in the national library at Zurich were made in that city from money sent out as gifts from England by the three English bishops, Jewel of Salisbury, Horn of Winchester, and Parkhurst of Norwich, in appreciation of the hospitality afforded them during their exile at Zürich, in the reign of Queen Mary I.⁵ Important plate was wrought at Berne, Rappersweil and other Swiss towns.

Russia.—In no country is the ecclesiastical and secular plate of greater interest than in Russia, where so many different influences have been at work in its designs and decoration—Byzantine, Oriental, Gothic, Renaissance, &c. The "golden age" of ecclesiastical art was undoubtedly the 17th century, when the churches and monasteries were being enriched with many priceless ornaments in the precious metals. Enamels of great richness—which had been introduced there by Hungarian artists—niello and precious stones were employed in the decoration. A drinking-cup or bowl exclusively Russian in form and character, known as *bratina*, was largely made (see the fine one of gold, enamelled and set with precious stones, in the royal collection at Vienna), as was a smaller bowl, called *czarka*, with a single handle. Another secular vessel, peculiarly Russian, is the *kozsh*, a pointed or boat-shaped bowl with a long handle. Much of the domestic plate after Peter the Great's time was influenced by that of western countries, particularly Germany.

Poland.—Though not without a character of its own, the

³ See Rosenberg in *Kunst und Gewerbe* (1885).

⁴ See twenty-one facsimiles of these etchings published by J. Rimel (London, 1862).

⁵ Keller, "Three Silver Cups at Zürich," *Arch. Journ.* xvi. 154.

ecclesiastical plate of Poland¹ came under the influence both of Germany and Hungary. Many of the sacred vessels of late medieval times are decorated with enamels and niello. In the 17th century ecclesiastical vessels encrusted with corals are met with, such as those given by Michael Wisniowiecki, king of Poland, to the church of Czeustochowa. A magnificent 17th-century chalice of gold, beautifully enamelled, given by the bishop of Plock and Breslau, son of Sigismund III., is in Plock cathedral. Many important pieces of plate still exist in churches in Poland, though a Polish origin is not claimed for them; for instance, the 10th-century chalice at Trzemeszno, where there is also another chalice of about the same period. The cathedral of Cracow contains many priceless examples, such as the 14th-century gold cross given by Casimir the Great; the gold crucifix of Mathias Corvinus, and the gold reliquary, 16th century, of St Stanislas, bishop of Cracow.

France.—France, like England, has suffered grievous losses in its plate, though it can show a larger array of medieval church vessels than can England. The chief specimens of medieval plate are the 9th-century casket and the seated statuette of St Foy (10th century) in the treasure of Conques; the cross of Laon (c. 1200) in the Louvre; the ciborium (early 13th century) in the treasury of Sens; the cross of the same period in Amiens Cathedral; the caskets of St Taurin (c. 1250); the reliquary of St Epine, given by St Louis; the virgin of the abbey of Roncevaux (Navarre, 14th century); and the virgin given by Queen Jeanne d'Evreux to St Denis in 1339. One of the most cherished possessions of the British Museum is the celebrated gold and enamel cup of the kings of England, French work of the 14th century. No doubt the visit to Paris of Cellini exercised a great influence in the goldsmith's art there, though, unfortunately, no examples have survived. The extravagances of Louis XIV. and his court led to the destruction of all the royal plate of France, as did the Revolution of 1789 of vast quantities of domestic plate. It was not until the early part of the 18th century that any signs of revival are visible in the art of the silversmith. Chief among the Paris goldsmiths of that time are Claude Ballin the younger, Thomas Germain, and, later in the century, François Thomas Germain, who made the royal plate of Portugal and several pieces for the court of Russia.

The Low Countries.—Flemish silversmiths of the late medieval period were as skilful as they were in the Renaissance. So little Flemish plate remains that pictures of the Flemish school are recommended as the chief sources of study of ecclesiastical vessels. A fine covered silver beaker, decorated with open work and translucent enamel in the South Kensington Museum, and another covered with figures and foliage in niello, in the print room of the British Museum, are notable examples of Flemish work of the 15th century. A large triptych, 13th century, is in the Rothschild bequest to the Louvre. Ornate rosewater ewers and basins, which came in with the Renaissance, such as the important pair dated 1535 in the Louvre, were made at Antwerp and other places.

The Utrecht silversmith, Paul van Vianen (early 17th century) wrought many fine pieces of plate, including the silver bas-reliefs in the Rijks Museum at Amsterdam, where there are five fine bas-reliefs in silver by the Belgian silversmith, Mathias Melin. Two other members of the same family, Adam and Christian van Vianen, were also prominent silversmiths of this time. An earlier Dutch silversmith, Christian van Vianen of Utrecht, made the vessels for the altar of St George's Chapel, Windsor, for Henry VIII.

Two important pieces of Dutch plate are the covered tazza-shaped cup of William the Silent, date about 1573, belonging to the earl of Yarborough,² and another large cup of the same form (1595), known as the "Breda cup," in the possession of the Hohenlohe family. Considerable quantities of plate were produced at Amsterdam (where Johann Lutma the elder—d. 1669—was a well-known silversmith), Haarlem, the Hague and many other places. The numerous 17th-century Dutch pictures

of still-life and other subjects afford opportunities for the study of tazze, beakers and other domestic vessels in silver. Hendrik Janssens, a Dutch engraver of about 1640, executed many designs for goldsmiths and jewellers.

Spain and Portugal.—Spanish plate was largely influenced in the middle ages by that of France and Flanders and the art of the Moors. But little medieval plate exists in Spain, most of it having been destroyed at the time when a taste for more elaborate ornaments sprang up as a result of the introduction of fresh wealth from the colonies in the New World. The following examples may be singled out: a cross of wood, covered with gold filigree work, set with stones (A.D. 808), in Oviedo Cathedral, where there is also a larger cross of wood and gold, dating from later in the same century. A Moorish casket of wood covered with thin silver plates is in Gerona Cathedral. The reliquary of Alphonso III. and his queen (A.D. 866–896) covered with embossed silver plates of the symbols of the evangelists; the 11th-century chalice at Silos; chalices of the 13th and early 14th centuries in the cathedrals of Santiago and Toledo; and Don Martin's great armchair, of wood covered with elaborate silver-gilt plates, in Barcelona cathedral. The Spanish monstrosities of the 15th century are noticeable because of the Flemish influence displayed, while those of the early part of the 16th century, such as that by the celebrated silversmith, Enrique Arfe, in the cathedral of Cordova, is remarkable for its ornate character. The latter's grandson, Juan de Arfe y Villafane (who wrote *De varia consensuacion*, 1585, on silverwork and other arts) became a chief maker of these magnificent monstrosities; for instance, the celebrated example in Seville cathedral. He was associated with Pacheco in executing statues. About the 15th century Barcelona became famed as a centre for the silversmith's art, and the *Libros de pasantia*, or silversmiths' examination books, still preserved in that city, contain a large number of designs for jewel-work. Seville likewise had an important guild of silversmiths, as did the following cities: Toledo, Valladolid, Burgos, Cordova and Salamanca. The celebrated family of Becerril wrought fine plate at Cuenca in the 16th century. Many chalices and some domestic plate of the 16th and early 17th centuries are embellished with small enamelled disks, some of which show Saracenic influence in details. The Victoria and Albert Museum possesses a fine collection of Spanish goldsmith's work.

Portuguese plate displays in its Gothic features a very florid style, in imitation of that adopted by architects in the reign of Don Manuel (1495–1521). A typical example of this extravagance of Gothic motives may be seen in the monstrosity of Belem, which was made from gold brought from the East by Vasco da Gama.

Austria and Hungary.—Austrian plate is, like that of Switzerland, largely based on German models. The ecclesiastical plate of Hungary in the 15th and 16th centuries is celebrated for its enamelled work of a flowered design enclosed in filigree wire—introduced from Italy. This enamelled decoration was continued in the 17th century, but without the filigree wire, and it is then described as "Transylvanian." Much of the secular plate of the 16th and 17th centuries in north and east Hungary is influenced by German plate, while that in Transylvania is frequently inspired by Oriental designs.

English.—There is strong evidence of the importance attached to English medieval plate by Continental peoples, as there was to the magnificent English illuminated MSS., and, later, to the embroidered vestments, *opus anglicanum*. But, unfortunately, the ruthless destruction of plate during the Wars of the Roses, the Reformation and the Great Rebellion has spared but few medieval pieces to which we can point. Under the name of Protestantism every ecclesiastical vessel with a device savouring of "popish superstition" was instantly destroyed. The inventories of the great cathedrals and religious houses plainly reveal their marvellous wealth in gold and silver vessels.

Norfolk is richer than any other county in pre-Reformation chalices and patens.³ The well-known "Gloucester" candlestick,

¹ *Pozdziejce i Rastawiecki, Polish Silver Work* (1853–1869).

² *Archaeologia*, lix. 83.

³ *Norfolk Arch.* xii. 85.

though composed of inferior metal, is an illustration of the fine plate wrought in England in the 12th century, while the ancient anointing spoon of the sovereigns of England at the Tower of London is an historical relic of the end of the 12th century (with the bowl altered for Charles II.). The earl of Carysfort is the fortunate possessor of a silver-gilt censer of about 1375 and an incense ship, of about 1400, found in Whittlesea Mere in 1850, and formerly belonging to Ramsey Abbey.¹ Only one pre-Reformation English gold chalice has survived, which with its paten and a silver crosier was given to Corpus Christi College, Oxford, by its founder, Bishop Foxe (Plate II., fig. 26). Both bear the London date-letter for 1507-1508. Another historical relic which has come down to the present day, though in a restored form, is the gold ampulla of about the end of the 14th century in the Tower of London. The universities of Oxford and Cambridge, though sadly depleted of their plate, can still show some notable pieces. The earliest example at each is a drinking horn, both of the 14th century, at Queen's College, Oxford, and Corpus Christi College, Cambridge. Other notable horns are the Pusey horn²; the celebrated Bruce horn with the seals of John of Gaunt attached, and one at Christ's Hospital.

Mazer bowls, made of wood mounted in silver and even in gold, and frequently engraved with scriptural and other inscriptions (see Plate I., fig. 28), were popular drinking vessels in England in medieval times. Many of these have survived, the earliest specimen being one of Edward II. at Harbledown hospital. They ceased to be made after the reign of Elizabeth (Archaeologia, i. 129). Medieval coco-nut cups, mounted in silver, are of frequent occurrence in England, the best known examples being in the possession of the colleges at Oxford and Cambridge and several of the city companies. As has been mentioned before, but few examples of early plate exist; the following is a brief list of some of the most notable pieces, other than those previously enumerated: the "Sokborn" cup (c. 1450), and the "Anathema" cup (1481-1482) at Pembroke College, Cambridge; the Leigh cup (1490) at Mercers' Hall; the ivory and silver cup (1525-1526) of the duke of Norfolk; the pastoral staff (c. 1367) at New College, Oxford; the Richmond cup (c. 1510) at Armourers' Hall; the "election cup" (c. 1520) at Winchester College; and the Foundress' plate, consisting of a fine covered cup (1435-1440), two salts (c. 1500), a beaker and cover (1507-1508), and a salt (1507-1508) at Christ's College, Cambridge. Of Elizabeth's reign, the finest examples are probably the salt of the Vintners' Company (Plate II., fig. 27), and the rosewater dish and ewer of the duke of Rutland. Stoneware jugs, as the well-known example



FIG. 15.—Silver Cup, 4½ in. high, with embossed gold band; found in a grave in the east of Zealand (Denmark). This cup dates from the earlier part of the Iron Age.

The amount of old jewelry found in Ireland during the past century has been enormous; but, owing to the unfortunate law of "treasure-trove," by far the greater part was immediately

¹ Illustrated in *Old Cambridge Plate*, pp. 102-103.
² *Archaeologia*, iii. 3, xii. 377.

(1581) from West Malling, Kent, and Chinese porcelain vessels were elaborately mounted in Elizabethan times, a goodly proportion of the former having been done by goldsmiths at Exeter.

The Celtic races of both England and Ireland appear to have possessed great wealth in gold and silver, but especially the former. It seems, however, to have been mostly used in the manufacture of personal ornaments, such as torques, fibulae and the like. A magnificent suit of gold armour, *repoussé* with simple patterns of lines and dots, was found some years ago at Mold in Flintshire, and is now in the British Museum.³

melted down by the finders. Little of this period that can be called plate has been discovered in the British Isles—unlike Denmark and other Scandinavian countries, where the excavation of tombs has in many cases yielded rich results in the way of massive cups, bowls, ladles and horns of solid gold, mostly decorated with simple designs of spirals, concentric circles, or interlaced grotesques. Others are of silver, parcel-gilt, and some have figure subjects in low relief (fig. 15). In like manner, during the Saxon period, though gold and silver jewelry was common, yet little plate appears to have been made, with the exception of shrines, altar-frontals and vessels for ecclesiastical use, of which every important church in England must have possessed a magnificent stock. With regard to English secular plate, though but few early examples still exist, we know from various records, such as wills and inventories, that the 14th century was one in which every rich lord or burgher prided himself on his fine and massive collection of silver vessels; on festive occasions this was displayed, not only on the dinner-table, but also on sideboards, arranged with tiers of steps, one above the other, so as to show off to advantage the weighty silver vases, flagons and dishes with which it was loaded. The central object on every rich man's table was the "nef"—a large silver casket, usually (as the name suggests) in the form of a ship, and arranged to contain the host's napkin, goblet, spoon and knife, with an assortment of spices and salt. No old English "nests" are now known. Great sums were often spent on this large and elaborate piece of plate, e.g. one made for the duke of Anjou in the 14th century weighed 348 marks of gold. The English silversmiths of this period were highly skilled in their art, and produced objects of great beauty both in design and workmanship. One of the finest specimens of Edward III.'s plate which still exists is a silver cup belonging to the mayor and corporation of King's Lynn. It is graceful and chalice-like in



FIG. 16.—Silver Cup, with translucent enamels. Probably English work of the 14th century.



FIG. 17.—Silver salt-cellar, 14½ in. high. Given to New College, Oxford, in 1493.

form, skilfully chased, and decorated in a very rich and elaborate way with coloured translucent enamels (fig. 16) of ladies and youths, several with hawks on their wrists. Silver salt-cellars were among the most elaborate pieces of plate produced during the 15th century. Several colleges at Oxford and Cambridge still possess fine specimens of these (fig. 17); a favourite shape was a kind of hour-glass form richly ornamented, made between about 1480 and 1525.



Fig. 21.—Golden *Δέπας ἀμφικύπελλον* from Mycenae (Late Minoan i.; about 1600 B.C.)

Fig. 22.—Fragment of a Silver Vase with Relief Design, showing the Defence of a City; from Mycenae (Late Minoan i.).

Fig. 23.—Golden Cup from Troy (Early Minoan iii.; 2500 B.C. or earlier).

Fig. 24, 25.—Gold Cups of Vaphio (Late Minoan i.).

Greek Plate of the Bronze Age (Prehistoric Period).



Photo, Hills & Saunders, by permission of Corpus Christi College.
 Fig. 26.—Gold Chalice and Paten of Bishop Foxe.



From Jackson, History of English Plate, by permission of C. J. Jackson, F.S.A.
 Fig. 29.—Gold Cup and Cover, Charles II.



Photo, Southwark Photo Eng. Co.
 Fig. 27.—Salt of the Vintners' Company (Elizabethan).



From Gardner, Old Silverwork, by permission of B. T. Batsford.
 Fig. 30.—Tudor Cup.



By permission of Chrichton Bros.
 Fig. 28.—Braikenbridge Mazer Bowl.



By permission of the Royal Irish Academy.
 Fig. 31.—Ardagh Chalice.

But few existing specimens of English plate are older than the beginning of the 15th century. Among the few that remain the principal are chalices—such as the two large silver-gilt ones found in the coffin of an archbishop of York, now used for holy communion in the cathedral, and a fine silver chalice from the church of Berwick St James, Wilts, now in the British Museum. Both this and the York chalices are devoid of ornament, and, judging from their shape, appear to be of the first half of the 13th century, which is the date of the fine medieval chalice and paten found near Dolgelly some years ago (the latter now believed in some quarters to be of German origin). Several Tudor cups are in existence: the celebrated one of 1521 (Plate II., fig. 30), an earlier one, 1500; two covered ones of about 1510 and 1512 at Sandwich and Wymeswold, respectively; one (1515) at Corpus Christi College, Oxford, and the Bodkin cup (1525) of the Corporation of Portsmouth. A very early beaker (1496) is in a private collection, as is also a small Tudor bowl (1525-1526). The earliest known chalices of silver include the Gourdon chalice and paten, the St Gozlin chalice at Nancy (10th century); the 12th-century specimen in the abbey of Wilten in Tirol.

It is interesting to note the various changes of form through which the ecclesiastical chalice passed from early Christian times till the 16th century. It was at first an ordinary *Chalice*, secular cup with two handles, classical in form and of large capacity, because the laity as well as the clergy received the wine. The double handles were of practical use in passing the cup round like a modern "loving cup." The first alteration was the omission of the handles, so that it took the form of a large hemispherical bowl with a round foot, and a knob for security in holding it. For some centuries it appears to have been the custom for the priest to hold the chalice, while the communicant sucked the wine through a silver tube or "fistula." Some of the most magnificent early examples of this form of chalice have the bowl mounted in bands, set with jewels, and enriched with minute filigree work—a design which appears to have been taken from those cups, such as the four magnificent examples in the treasury of St Mark's at Venice, which have their bowl cut out of crystal, onyx or some other precious stone.¹ The finest examples of this class are the Ardagh chalice, now in the Dublin Museum, and the chalice of St Remigius, in Reims cathedral; both are most magnificent specimens of the taste and skill of 10th to 11th century goldsmiths. In the 12th and 13th centuries the design becomes simpler; there is a distinct shaft, extending above and below the knob; and on the foot is marked a cross, not found in the earlier ones, to show which side the priest is to hold towards himself at celebration. The next alteration in the form of chalice, which occurred in the 14th century, was to make the foot not circular in plan but polygonal or lobed, so that the cup might not roll when laid on its side to drain, after it had been rinsed out. This form lasted in most countries till about 1500, and in England till the Reformation. Then the bowl, which in the previous two or three centuries had been slowly reduced in size, owing to the gradually introduced practice of refusing the wine to the laity, was suddenly made more capacious, and the form was altered to the shape shown in fig. 18, in order that the Protestant "communion cup" might bear no resemblance to the old Catholic "massing chalice." This was ordered to be done in 1562 (see *Arch. Journ.* xv. 44-53). The best account of the evolution in the form of English medieval chalices and patens is by W. H. St John Hope and T. M. Fallow, in *Archæologia*, vol. xlii.



FIG. 18.—Elizabethan Chalice.

Secular plate during the 15th and 16th centuries was frequently similar in style to that made in Germany, though the English silversmiths of the latter century never quite equalled the skill or artistic talent of the great Nuremberg and Augsburg silver-workers. In the 17th century, during the reigns of James I. and Charles I., many fine pieces of plate, especially tall cups and tankards, were made of very graceful form and decoration. The greater part of this, and all earlier plate, especially the fine collections belonging to the universities, were melted down during the Civil War. In Charles II.'s reign returning prosperity and the increase of luxury in England caused the production of many magnificent pieces of plate, often on a large scale, such as toilet services, wine-coolers, and even fire-dogs and other furniture. These are very florid in their ornament, much of it

¹ See De Fleury, *La Messe* (Paris, 1882), &c.

under Dutch influence, and mostly have lost the beautiful forms of the century before (fig. 19 and Plate II., fig. 20). In the early part of the 18th century the designs of English plate were to some extent influenced by the introduction of French ornaments by the large band of French silversmiths who sought refuge in England after the revocation of the edict of Nantes. Chief among these Frenchmen (though probably not a refugee himself) was Paul Lamerie, who produced a large number of notable specimens, the largest of which is a fine wine-cooler in the Winter Palace, St Petersburg. Through the greater part of the reign of George III: English plate is more remarkable for its plain solidity than for artistic merit. With the advent, however, of the talented architects, the brothers Adam, came a taste for plate with classical characteristics. The South Kensington Museum has a small, though fine, collection of plate, varying



FIG. 19.—Covered Cup of Solid Gold, 6 in. high, c. 1660-1670. Given to Exeter College, Oxford, by George Hall, Bishop of Chester.

in date from 1770 to 1788, in the Adam style. Many of Flaxman's designs were produced in plate, among the most important being the "Shield of Achilles," in silver-gilt, at Windsor Castle. Thomas Stothard, the painter, executed several designs for goldsmith's work for Rundell and Bridge.

The Assay of Gold and Silver Plate.—The primitive method of testing the purity of the metal was by marking a streak with it on the touchstone, and comparing the colour of the mark with that made by various pieces of gold or silver of known degrees of purity. Assay by cupellation is now employed for silver: a piece of the silver to be tested is melted with some lead in a cupel or bone-ash crucible; the lead is oxidized, and rapidly sinks into the bone-ash, carrying with it any other impurities which are present. The residue of pure silver is then weighed, and by its loss shows how much alloy it contained. Gold is now tested by an elaborate chemical process by which the trial bit is dissolved in acid, and then thrown down in the form of precipitate, which can be examined by a careful quantitative analysis (see ASSAYING).



FIG. 20.—Silver Vase, 11 in. high, dated 1772. Designed by the brothers Adam.

The standard of purity required in the time of Edward I. was, for gold, that it should be of the "Paris touch," i.e. 101 carats out of 24. Before then 22 carats was the standard. Silver was to be "of the sterling alloy," viz. 11 oz. 2 dwt. to the pound. Except for a time during the 16th century this standard of silver has been kept up, and is still required by law.

Hall-marks on Silver.—In the 13th century the English Gold and Silver-smiths had grown into great importance, and had acquired monopolies and many special privileges. In order to keep the standard up to the required purity the system of requiring each article to be stamped with certain marks was introduced by royal command. The first of these was the

king's mark—a leopard's or lion's head crowned. This was introduced in 1300 by Edward I. (29 Edw. I. stat. 3, c. 30). The second, the maker's mark, was instituted in 1363 (37 Edw. III. c. 7). This might be any badge or initial chosen by the master silversmith himself. The third was the Year letter or assayer's mark; this was an alphabet, one letter being used for a year, counting from the day of the annual election of the warden of the Goldsmiths' Company. When one alphabet was exhausted another with differently shaped letters was begun. The earliest existing piece of plate which has the three marks is the chalice (with paten, 1479-1480), at Nettlecombe, Somerset. Other marks, subsequently introduced, were the lion passant, first used in 1544; the lion's head erased; and a full-length figure of Britannia, used only between 1697 and 1719-1720; and, lastly, the portrait of the reigning sovereign, which was used from 1784 to 1890, when the duty on gold and silver plate ceased. In addition to these general hall-marks, the plate made in various provincial towns had certain special assay and hall-marks.

The best work on hall-marked plate and the marks themselves, with the history of the Goldsmiths' Company, is C. J. Jackson's *English Goldsmiths and their Marks* (1905), where will be found illustrations of the marks found on plate wrought in Scotland and Ireland, and at English provincial gilds—York, Norwich, Exeter, Chester, Lincoln, Newcastle, Birmingham, Sheffield and other places. E. Alfred Jones's book, *Old English Gold Plate* (1907), illustrates and describes gold plate only.

Modern Plate in the East.—Though little plate of real artistic merit is now made in Europe, in the East among the Moslem and Hindu races there still survive some real taste in design and skill in execution. Delhi, Benares, Lucknow, Cutch and other places in India and Kashmir still produce a quantity of beautiful silver and gold work—chiefly ewers, basins, rose-water sprinklers, salvers, coffee-pots and the like. These are of graceful form, covered with rich repoussé work, or more often with very delicate chased patterns. Their style in the main is Moslem, but some combine an Arab form with native Indian surface decoration. This class of work is not a revival, but has been practised and handed down by unbroken tradition, and with little or no change in style from the 16th century or even earlier.¹ The silversmiths of Persia, Damascus and other Eastern places are still skillful, and retain some good tradition in their designs. They are, however, more occupied in the production of personal ornaments than in making larger works of silver or gold.

AUTHORITIES.—*Scandinavian and Celtic Plate.*—Worsaae, *Præmønt Antiquities of Denmark* (1849); *Abildningerne fra de Kongelige Museum* (1854); "Industrial Arts of Denmark," *S.K.M. Hand-book* (1882); *Atlas de l'archéologie du nord* (1857); Anderson, *Mindelblade fra de danske kongers Samling* (1867); *Danmarks, Norges, og Sveriges historie* (1867); Madsen, *Abildninger af danske Oldsager* (1868-1876); Montelius, *Antiquités suédoises* (1873-1875); Stralsund, *Der Goldschmuck von Hildensoe* (1881); Hildebrand, "Industrial Arts of Scandinavia," *S.K.M.* (1882); Reeves, *Shrine of St Patrick's Bell* (1850); Wilde, *Catalogue of Antiquities of Gold, Royal Irish Academy* (1862); Margaret Stokes, *Early Christian Art in Ireland* (1875); J. Romilly Allen, *Celtic Art in Pagan and Christian Times* (1904).

Danish.—Nyrop, *Meddelelser om dansk Guldsmedekunst* (1884); Bernhard Olsen, *De kjøbenhavniske Guldsmedes Marker fra Tiden for Aaret, 1800* (1802).

Italian.—L. Caglieri, *Compendio delle vite dei santi orrefici ed argentieri* (1727); *Il Santuario della religione ossia il tesoro della basilica di S. Antonio di Padova* (1851); "Stanziamenti e contratti per opere di orreficeria (XIV-XV. cent.);" Perugia: *R. Commissione Giornale*, i. 333, iii. 206, 225 (1872-1874); Filangieri, *Documenti per la storia, le arti e le industrie delle provincie napoletane* (1883-1891); Antonio Pasini, *Il Tesoro di San Marco, Venezia* (2 vols., 1885-1886); "Orfèvres et l'orfèvrerie en Savoie," Chambery: *Soc. savoisienne mémoires*, xxiv. 329 (1886); A. Guarnieri, *Esposizione di Palermo. Catalogo della collezione di antica orreficeria ed argenteria* (1891); L. Fumi, *Il Santuario del SS. Corporale nel duomo di Orvieto* (1896); *Congresso eucaristico ed esposizione di arte sacra antica in Orvieto* (1897); *Congresso eucaristico di Venezia* (1898); A. Cocchi, *Les Anciens reliquaires de Santa Maria del Fiore et de San Giovanni de Florence* (1903); O. H. Giglioli, *Pistoia, nelle sue opere d'arte* (1904); *Catalogo generale della mostra d'arte antica abruzzese in Chieti* (1905); E. Manceri, *Notizie di Sicilia, arte VIII.* 388 (1905); P. Piccirilli, *Orficeria medievale aquilana: due cimeli nel Victoria and Albert Museum di Londra* (1905); F. Ferrari, *L'Orficeria in Aquila*

(1906); S. J. A. Churchill, "The Goldsmiths of Rome under the Papal Authority," with valuable bibliography, *Papers of British School at Rome*, vol. iv. (1907); *Catalogo della mostra d'antica arte Umbra* (Perugia, 1907); Corrado Ricci, *Il Palazzo pubblico di Siena e la mostra d'antica arte senese*.

Russian, &c.—A. P. Sonzoff, an illustrated book on some Russian plate (1857-1858); A. Maskell, *Russian Art and Art Object in Russia* (1884); C. de Linas, *Les Origines de l'orfèvrerie cloisonné*; Viollet-le-Duc, *Art russe; Antiquities of the Russian Empire*.

Austrian and Hungarian.—B. Czobor and I. Szalay, *Die historischen Denkmäler Ungarns* (1897-1901); E. Radácsics and J. Szendrői, *Treasure of Hungarian Art* (Hung.) (Budapest, 1897-1901); J. Mihalik, "History of Goldsmiths' work at Kassa" (Hung.), in vol. xxi. of *Archæological Proceedings of Hungarian Academy* (1899); "Zur Geschichte der Wiener Gold- und Silberschmiedekunst," by E. Leisching, in *Kunst und Kunsthandwerk*, vii. 343 (1904); "Alt Troppauer Goldschmiedekunst," by E. W. Braun, in *Zeitschrift für Geschichte . . . oesterreichisch-Schlesiens*, i. 24 (1905); J. Hampel, *Alterthümer des frühen Mittelalters in Ungarn* (Brunswick, 1907); *Katalog der Ausstellung von alt-oesterreichischen Goldschmiedearbeiten* (Kaiser Franz Josef Museum in Troppau); A. Ilg, *Wann Schmiedewerk*.

German, &c.—Manuscripts (W. Jamnitzer), "Ein gar künstliche und wolgetzierter Schreibtißsch sampt allerhand künstlichen silbern und verguldeten neuerfinden Instrumenten" (1585), col. drawings; Sibmacher, *Entwürfe für Goldschmiede* (1879); R. Bergau, *Wend Jamnitzer* (1880); *Erzeugnisse der Silber-Schmiede Kunst aus den 16 bis 18 Jahrh.* (1883); Luthmer, *Der Schatz des Freiherrn K. von Rothschild* (2 vols., 1883-1885); Luthmer and Schuermann, *Großherzoglich-hessische Silberkammer* (1884); C. A. von Drach, *Allen Silberarbeiten in den kgl. Sammlungen zu Cassel* (1888); Marc Rosenberg, *Der Goldschmied Merzzeichen* (1890); J. H. Heine-Alteneck, *Deutsche Goldschmiedewerke des 16. Jahrh.* (1890); Marc Rosenberg, *17 Blatt aus dem grossherzoglich sächsischen Silberschatz im Schlosse zu Weimar* (1891); *Die Kunstammer im grossherzoglichen Residenzschlosse zu Karlsruhe* (1892); *Siebzehn Blatt aus dem herzoglich Anhaltischen Silberschatz im Schlosse zu Dessau* (1893); F. Sarre, *Das berliner Goldschmiede Junft* (1895); P. Schuch, "Deux œuvres de Wenzel Jamnitzer," *Der Silber- und Goldschmied der Hohenzollern im kgl. Schlosse zu Berlin* (1895); *Gas des bezant arts*, 3 S., xx. 22 (1898); Eugen von Nottbeck und W. Neumann, *Geschichte u. Kunstschmiederei der Stadt Regal* (1899); Bernhard Olsen, *De hamburgske Guldsmede Jakob Mores d. ældres og d. yngres Arbejder for de danske Konger Frederik II. og Christian IV.* (1903); *Die Arbeiten der Ramburgsichen Goldschmiede Jacob Mores, Vater und Sohn, für die dänischen Könige Frederik II. und Christian IV.*; J. Sembritzki, *Verzeichniss in Memel vorhandener, alterer Erzeugnisse der Edelschmiedekunst* (1904); H. P. Mitchell, "Two works by Wenzel Jamnitzer," *Journal*, p. 105 (1905); W. Neumann, *Verzeichniss baltischer Goldschmiede, ihrer Merzzeichen und Werke* (1905); E. Hintze, *Die breslauer Goldschmied* (1906); E. Alfred Jones, "The gold and silver plate of W. D. von Raitenau, prince-archbishop of Salzburg, in the Pitti Palace," *Connoisseur*, xviii. 20 (1907); "The Plate of the Emperor of Germany," *Connoisseur*, nos. 51 and 54; *Illustrated Catalogue of Early German Art* (Burlington Fine Arts Club, 1908); Richard Graul, *Leipzig's Gold- und Silberschmiedearbeiten des Mittelalters* (1908); A. Weiss, *Das Handwerk der Goldschmiede zu Augsburg bis 1681*; E. von Schauss, *Die Schatzkammer des bayerischen Königs; Duke of Portland's Gold Cup*; *Archæologie*, lix. 233.

French, Burgundian, &c.—J. C. Delafosse, *Nouveaux étonnables historiques*, fol. (1771); E. Aubert, *Trésor de l'abbaye de Saint-Maurice d'Agagne* (1872); Mely, *Le Trésor de Chartrre* (1886); L. Palustré et X. Barbier de Montault, *Le Trésor de Trèves* (1886); J. D'Arbaumont et L. Marchant, *Le Trésor de la Sainte-Chapelle de Dijon d'après ses anciens inventaires* (1887); C. G. Bapst, *Étude sur l'orfèvrerie française au XVIII^e siècle, le Germain, orfèvres-sculpteurs du Roy* (1887); *Album de l'exposition de l'art ancien au pays de Lige: orfèvrerie religieuse* (1888); *Catalogue raisonné des pièces d'orfèvrerie française composant la collection du marquis de Fos (à Lisbonne)* (1889); *L'Orfèvrerie française à la cour de Portugal au XVIII^e siècle* (1892); E. Müntz, *Histoire de l'art pendant la Renaissance* (1891); W. Cripps, *Old French Plate* (1893); H. Havard, *Histoire de l'orfèvrerie française* (1896); *Inventaire de l'orfèvrerie et des bijoux de Louis I.* (1903); E. Molinier, *Un Monument d'orfèvrerie française du XIII^e siècle*, Soc. des antiq. de France, p. 477 (1904); F. Pasquier, "Objets précieux de la maison de Foix au quinzième siècle," *Sociétés des beaux arts, Mémoires* (1904); L. de Farcy, "Croix de la Roche-Foulques," *Revue de l'art chrétien*, p. 337 (1905); J. J. Marquet de Vasselot, *Catalogue raisonné de la collection Martin Le Roy* (1906); *Histoire de l'art*, ii. 988-999 (with bibliography), edited by André Michel (1907), &c.; A. Lefranc, *50 planches d'ancienne orfèvrerie empire*.

Low Countries.—Van Loon, *Histoire métallique des Pays-Bas* (Hague, 1732-1737); Schaepkens, *Trésor de l'art ancien en Belgique* (1846); *Tentoonstelling Amsterdams* (illustrations), (1877); for marks on Dutch plate, see *Nederlandsche Kunstboek* (1879); *Expositio retrospectiva d'objets d'art en or et en argent, Amsterdams* (1880); Roddaz, *L'Art ancien à l'exposition nationale belge* (1882); *L'œuvre Provincial Friesch Genootschap* (1902); *Catalogue of the Exhibition*

¹ See Birdwood, *Industrial Arts of India* (1880), p. 144.

at Bruges (1903); *Catalogue of the Exhibition at Liège (1905)*; J. Helbig, *L'Art Mosan*.

Spanish.—Riano, *Industrial Arts in Spain (1879)*; Davillier, *L'Orfèvrerie en Espagne (1879)*; Museo español de antigüedades (1879); José Villalamil y Castro (on Spanish chalices), *Boletín de la sociedad española de excursiones* (April, 1893); *El Tesoro de la catedral de Santiago*; H. P. Mitchell, *Catalogue of the Silversmiths' Work in the Wyndham Cook Art Collection (1905)*; L. Williams, *Arts and Crafts of Older Spain (1907)*; Don Enrique de Leguina Barón de la Vega de Hoz, *La Plata española*; *Geosano, Diccionario de artefactos sevillanos*.

American.—J. H. Buck, *Old Plate (1903)*; *American Silver (Boston, 1906)*; *Colonial Silversmiths of the 17th and 18th centuries (1907)*; E. Alfred Jones, "Old American Silver Plate," *Connoisseur* (December, 1908).

English.—H. Shaw, *Dresses and Decorations of the Middle Ages (1843)*; *Decorative Arts of the Middle Ages (1851)*; Bray, *Life of Stohard (1851)*; *Catalogue of the Antiquities and Works of Art exhibited at Ironmongers' Hall (1861)*; *Catalogue of the Exhibition of Objects of Art, South Kensington (1862)*; W. Cripps, *College and Corporation Plate (1881)*; *Old English Plate (9th ed., 1906)*; R. S. Ferguson, *The Old Church Plate of the Diocese of Carlisle (1882)*; Atkinson and Foster, *Old Cambridge Plate (1883)*; W. A. Scott Robertson, *Church Plate in Kent (1886)*; R. C. Hope, *Church Plate in Rutland (1887)*; J. E. Nightingale, *The Church Plate of Dorset (1889)*; *The Church Plate of Willis (1891)*; A. Trollope, *The Church Plate of Leicestershire (1890)*; F. G. Hilton Price, *Handbook of London Bankers, with some account of the Early Goldsmiths (1890-1891)*; H. D. Ellis, *The Silver Plate of the Armourers' Company (1892)*; *The Silver Plate of the Merchant Tailors' Company (1892)*; "The Plate of Christ's Hospital," *Trans. of the London and Middlesex Arch. Soc. (1902, new series, vol. 1, pt. 4)*; Sir J. Watney, *The Plate of the Mercers' Company (1892)*; Rev. T. Burns, *Old Scottish Communion Plates (1893)*; J. Starke Gardner, *English Enamels (1894)*; *Old Silver Work, chiefly English, 15th to 18th centuries (1902)*; "Charles II. Silver at Welbeck," *Burlington Mag.* vol. vii, nos. 25 and 26; "Silver Plate of the Duke of Newcastle," *Burlington Mag.* vol. viii, no. 32; "Silver Plate of the Duke of Rutland," *Burlington Mag.* vol. viii, and ix. nos. 36 and 37; C. A. Markham, *The Church Plate of the County of Northampton (1894)*; *Handbook to Foreign Hallmarks (1898)*; E. H. Freshfield, *The Communion Plate of the Churches in the City of London (1894)*; *The Communion Plate of the County of London (1895)*; *The Communion Plate of Middlesex (1897)*; *The Communion Plate of Essex (1899)*; Sir W. Prideaux, *Memorials of the Goldsmiths' Company (1896)*; L. Jewitt and W. H. St John Hope, *The Corporation Plate, &c., of England and Wales (1895)*; W. Chaffers, *Gilda Aurifabrorum (1896)*; *Hall Marks on Gold and Silver Plate (1905)*; Cyril Davenport, *The English Regalia (1897)*; Haslewood, *Church Plate of Suffolk (1897)*; G. E. Halliday, *Llandaff Church Plate (1901)*; A. Butler, "The Old English Silver of the Inholders' Company," *Connoisseur (1901)*, i. 236; "The Old English Silver of the Skinners' Company," *Connoisseur (1903)*, v. 201, vi. 33; Percy McQuoid, "The Plate of Winchester College," *Burlington Mag.* (1903) li. 149; "Evolution in English Plate," *Burlington Mag.* (1903) l. 167, 359; *The History of English Furniture (1904, &c)*; Stanhope and Moffatt, *The Church Plate of the County of Hereford, (1903)*; *Guide to the Early Christian and Byzantine Antiquities, British Museum (1903)*; *General Guide to the Art Collections (Gold and Silver), Science and Art Museum, Dublin (1903)*; Montague Howard, *Old London Silver (1903)*; E. Radford, "The Church Plate of St Lawrence Jewry," *Connoisseur (1904)*, vii. 72; H. F. N. Jourdain, *History of the Mess Plate of the 88th Regiment (1904)*; T. M. Fallow, "Yorkshire Plate and Goldsmiths," *Journal of Arch. Inst. of Great Britain (1904)*, hi. 74; J. T. Evans, *The Church Plate of Pembrokeshire (1905)*; *The Church Plate of Gloucestershire (1906)*; *The Church Plate of Carmarthenshire (1908)*; C. H. Ashdown, *Notes on the Corporation Plate and Insignia of the City of St Alban (1905)*; H. C. Casley, "An Ipswich Worker of Elizabethan Church Plate," *Suffolk Inst. of Arch. and Nat. Hist. (1905)* vol. xii, pt. 2; F. Guy Laking, *The Furniture of Windsor Castle (1905)*; H. C. Moffatt, *Old Oxford Plate (1906)*; J. W. Caldicott, *The Values of Old English Silver and Sheffield Plate (1906)*; E. Alfred Jones, "The Old Silver Sacramental Vessels of English Nonconformity," *Mag. of Fine Arts (1906)*, i. 280, 371; *The Church Plate of the Diocese of Bangor (1906)*; *The Old Church Plate of the Isle of Man (1907)*; *The Old Silver Sacramental Vessels of Foreign Protestant Churches in England (1907)*; *Old English Gold Plate (1907)*; *Illustrated Catalogue of Leopold de Rothschild's Collection of Plate (1907)*; *Two Illustrated Catalogues of J. Pierpont Morgan's Collection of Plate (1907-1908)*; "Old Plate at the Dublin Exhibition, 1907," *Connoisseur (Dec. 1907)*; "English Plate at the Church Congress, Great Yarmouth," *Burlington Mag.* vol. xii, no. 57 (Dec. 1907); *The Old Plate at the Tower of London (1908)*; "The Civic Plate, Regalia, &c., of the Norfolk Boroughs," *Memorials of Old Norfolk (1908)*; *The Old English Plate of the Czar of Russia (1909)*; *The Old Plate of the Cambridge Colleges (1909)*; "Some Old Plate in the possession of Lord Mosely," *Burlington Mag.*; "The Plate of Jesus College, Oxford," *V Cynodolod*, vol. xvii.; *Guide to the Medieval Room, British Museum (1907)*; Nelson Dawson, *Goldsmiths' and Silversmiths' Work (1907)*;

T. S. Ball, *Chester Church Plate (1908)*; R. H. Cocks, *Concerning some Treasures of the Vintners' Company; Hope and Fallow, "English Medieval Chalices and Patens," Arch. Journal, xliii. 140*; C. J. Jackson, "The Spoon and its History," *Archæologia*, vol. liii.; G. R. French, "The Plate of the Vintners' Company," *London and Middlesex Arch. Soc. Trans.* vol. iii.; "The Plate of the Mercers' Company," *London and Middlesex Arch. Soc. Trans.* vol. iv.; J. G. Nichols, "The Plate of the Stationers' Company," *London and Middlesex Arch. Soc. Trans.* vol. ii.; Article on "Drinking and other Horns," in *Chester Arch. Soc. Journal*, new series, vol. xi.; *Somerset Arch. Soc. xlv. 2*; *Oxfordshire Arch. Soc. Proc.* vol. xxv.

xxviii.; *Norfolk Archaeology*.
 Designs, &c.—J. Giardini, *100 Designs for Silversmiths' Work* (pub. in Rome, 1750); A. W. Pugin, *Designs for Gold- and Silversmiths*, (1836); Andronet du cerceau, *Ornements d'orfèvrerie propres pour planquer et emailer: nouveau livre d'ornemens d'orfèvrerie* (pub. Paris, c. 1660, London, 1888); H. Bouchot, *Cent modèles inédits de l'orfèvrerie française des 17^e et 18^e siècles exécutés par les orfèvres-sculpteurs royaux Nic. de Lamoignon, J. J. Roethers, T. Germain, F. T. Germain et reproduits d'après les dessins originaux de la bibliothèque nat.* (1888); *Le Cabinet des estampes de la bibliothèque nationale (1895)*; *Reproductions of Paul Flindt's designs for goldsmiths' work*, published 1888; *Reproductions of ancient graveurs d'orfèvrerie hollandaise (1892-1900)*; Collection of illustrations entitled *Die Schatzkammer des Bayer-Königshaus (1902)*. For an account of the original drawings for silversmiths' work in the museum at Basle see *Jahrbücher der kgl. preuss. Kunstsammlungen (1905)*; Illustrated reproductions of goldsmiths' designs by the Dutch silversmith, Adam Vianen; Etienne Delaune (1519-1583); Reproductions of his goldsmiths' ornaments, Paris; J. F. Forty, *Ouvrages d'orfèvrerie à l'usage des églises; J. C. Reiff (18 Jahrh.)*, *4 Blatt sehr schöne Zierarbeiten für Goldschmiede, &c.*; Giardini, *Promptuarium artis argenteæ (Rome, 1750)*; Holbein, *Original Designs for Plate*, in the Brit. Mus., and in the Bodleian at Oxford (the South Kensington Museum also has a fine collection of original 16th-century designs in pen and ink); Viane, *Models of Silver Vases, &c.* (Utrecht, 17th cent.); Loie, *Breuses, et autres ouvrages de orfèvrerie, et Nouveaux dessins de guerdons, &c.* (Paris, n.d.); Maria, *Livre de dessins de joaillerie, &c.* (Paris, n.d.); *Portefeuille d'ornement (Paris, 1841)*.

MISCELLANEOUS.—Hertfelder, *Barilica SS. Udalrici et Afrae (Augsburg, 1627)*; Maason, *Neue Vorrisse von Sachen die auf allerley Goldsmidts Arbeit, &c.* (Augsburg, 1710); Christy, *Détails des Pays-Bas (1760)*, vol. iii.; Frisi, *Memorie della chiesa Monzese (1774-1780)*; Shaw, *Ancient Plate from Oxford (1837)*; Du Sommerard, *Les Arts au moyen âge (1838-1848)*; Kratz, *Der Dom zu Hildesheim (1840)*; Richardson, *Old English Mansions and their Plate (1841-1848)*; *Drawings and Sketches of Elizabethan Plate (London, n.d.)*; Tarbé, *Trésors des églises de Reims (1843)*; Smith, "Specimens of College Plate," *Cam. Ant. Soc. (1845)*; Cahier and Martin, *Mélanges d'archéologie (1847-1856)*; Filimoroff, *Plate, Jewellery, &c., in the Musée d'Armures at St Petersburg (Moscow, 1849)*; Schotel, *La Coupe de van Nispden (1850)*; H. Emanuel, *Catalogue of the Principal Works of Art in Gold, Silver and Jewels shown at the International Exhibition (1851)*; King, *Metal Work of the Middle Ages (1852)*; Becker and Heiner-Altenack, *Kunstwerke und Gerätschaften* (Frankfort, 1852-1857); Fleury, *Trésor de la cathédrale de Loom (1855)*; Heider, *Mittelalterliche Kunstdenkmäler (1856-1860)*; *Der Altaraufsatz zu Kloster-Abburg (1860)*; Aus' m Weerth, *Kunstdenkmäler des christlichen Mittelalters in den Rheinländern* (Leipzig, 1857-1860); Texier, *Dictionnaire d'orfèvrerie (1857)*; Bock, *Das heilige Köln (1858)*; *Der Reliquienschatz . . . zu Aachen (1860)*; *Der Kranleuchter Kaisers Barbarossa zu Aachen (1864)*; *Die Kleinodien des heyl. römischen Reichs (1864)*; Viollet-le-Duc, *Dictionnaire du mobilier (1858-1875)*; Darcel, articles in *Gaz. des beaux-arts*, "L'Orfèvrerie du moyen-âge" (1850) iv. 224, "La Collection Soltykoff" (1861) ix. 212, "Les Trésors de Cologne" (1861) xxiii. 98, "Les Trésors de la cathédrale de Reims" (1881) xxiii. 98; Wyatt, "Gold Crowns from Toledo, and St Fillan's Crozier," in *Arch. Journ.* (1859), vol. xvi., and "Ancient Ornaments," *ibid.* vol. iii.; F. W. Fairholt, *Illustrated Catalogue of Lord Leedesborough's Collection of Plate (1860)*, De Lasteyrie, *Trésor de Guadazar (Paris, 1860)*; *Histoire de l'orfèvrerie (1875)*; Cousemaker, *Orfèvrerie du XIII^e siècle (Paris, 1861)*; Linas, *Orfèvrerie néo-byzantine (1864)*; Labarte, *Histoire des arts au moyen-âge (1864-1866)*; Baldus, *Recueil d'ornements (Paris, 1866)*, *Quarterly Review*, cxd. 353; Strada, *Entwürfe für Prachtgefässe in Silber und Gold (Vienna, 1869)*; *Zeitschrift des Kunst-Gewerbe-Vereins zu München (1871)*; La Croix, *Arts in the Middle Ages (1870)*; Keller, *Autotypes of Italian Designs for Plate (London, 1871)*; Aubert, *Trésor de l'abbaye d'Agagne (Paris, 1872)*; Kulmer, *Die Kunst des Gold-Arbeiters, &c.* (Weimar, 1872); Schorn, *Kunst und Gewerbe (1874, &c.)*; Fabre, *Trésor . . . des arts de Savoie (1875)*; Jacquemart, *Histoire du mobilier (1876)*; Hirth, *Formenschatz der Renaissance (Leipzig, 1877, seq.)*; Danko, *Grosser Formenschatz (1880)*; Luthmer, *Goldschmuck der Renaissance (Berlin, 1880)*; Wheatley and Delamotte, *Art Work in Gold and Silver (1882)*; A. Heyden, *Das Tafelsilber und Silberarbeiten ihrer kgl. Hohelien des Prinzen u. der Prinzessin Wilhelm v. Preussen. Festgeschenk zu höchstlicher Vermählung am 27. Februar 1881 dargebracht von preussischen Städten (1883-1884)*; J. and C. Jeidels, *Catalogue of Collection*

of Plate, 16th-18th Centuries (1883); Greco and Emanuel, *Arts of the Goldsmith and Jeweller* (1883); I. F. Sick, *Notice sur les ouvrages en or et argent des rois de Danemark* (1884); Julius Lessing, "Der Silber Altar in Rügenwalde," *König. preuss. Kunstsammlungen Jahrbuch* (1885), vi, 58; *Gold und Silber* (1907); C. Pulsley, E. Radisich and E. Molinier, *Chefs-d'oeuvre d'orfèvrerie ayant figuré à l'exposition de Budapest* (2 vols., 1886); R. von Kulmer, *Handbuch für Gold u. Silberarbeiter u. Juweliers* (1887); E. Molinier, "Le Trésor de Saint Marc à Venise," *Gaz. des beaux-arts*, 2nd series, vols. xxxv., xxxvii., xxxviii., 3rd series, vol. i. (1887-1889); *Le Trésor de la cathédrale de Coire* (1895); *Catalogue of Baron Adolphe de Rothschild's collection of Objects of Art* (1902); A. Darcel, "Les Collections Spitzer," *Gaz. des beaux-arts*, 2nd series, xxxviii., 225 (1888); L. Gmelin, *Alle Handzeichnungen nach dem verstorbenen Kirchenschatz der St. Michaels-Hofkirche zu München* (1888); A. Hg. *Kunsthistorisches Hofmuseum*, &c. (1891); *Arbeiten der Goldschmiede u. Steinschleiftechnik* (1895); *Kunsthistorische Sammlungen des allerhöchsten Kaiserhauses: Arbeiten der Goldschmiede- und Steinschleiftechnik* (1895); E. Marchal, *La Sculpture et les chefs-d'oeuvre de l'orfèvrerie belges* (1895); B. Czobor, *Les Insignes royaux de Hongrie* (1896); W. Froehner, *Collections de château de Goluchów: Orfèvrerie* (1897); R. Hausmann, *Der Silberschatz der St. Nikolai-kirche zu Reval* (1899); *Warner Silfersparres nya grafiska aktieböcker* (Stockholm, 1900); F. R. Martin, *Schwedische königliche Geschenke an russische Zaren, 1647-1699* (1900); *Dänische Silberschatze aus der Zeit Christians IV. aufbewahrt in der kaiserlichen Schatzkammer zu Moskau* (1900); J. Starkie Gardner, *Catalogue of the Collection of Silversmiths' work of European Origin* (Burlington Fine Arts Club, 1901); A. Pit, *Het goud en zilverwerk in het Nederlandsch Museum*, &c. (1901); *Kaiserliche Erlässe, St. Petersburg, Führer durch die Peter-Galerie* (1901); *Illustrated Catalogue of the Waddesdon Bequest, British Museum* (1902); H. L. Tilly, *The Silver Work of Burma* (1902); P. Eudel, *L'Orfèvrerie algérienne et tunisienne* (1902); H. Barth, *Das Geschmiede* (1903); H. Wilson, *Silverwork and Jewellery* (1903); H. P. Mitchell, "A Medieval Silver Chalice from Iceland," *Burlington Mag.* (1903) ii, 70, 357; E. Duchaine and P. Violettes, *Manuel de l'orfèvre: la garantie du titre des ouvrages d'or et d'argent* (1904); W. Stengel, *Formalkonographie (Detailaufnahmen) der Gefässe auf den Bildern der Anbetung der Könige* (1904); "Le Musée Willett, Houthuysen et l'orfèvrerie et l'argenterie," *Art flamand et hollandais* (1905), iv, 29; O. M. Dalton, *Treasure of the Oxus* (1905); H. H. Cunyngame, *European Enamels* (1906); Rosenberg, *Geschichte der Goldschmiedekunst auf technischer Grundlage, Abteilung: Niello* (1907); *ibid.* Abteilung: *Aushängebogen* (1908); Nelson Dawson, *Goldsmiths' and Silversmiths' Work* (1907); "Ecclesiastical Goldsmiths' Work in the Coast Towns of Istria and Dalmatia," *The Builder*, xciii, nos. 3384 and 3385; L. Forrer, *Dictionary of Metallists*, &c. (in progress), 8 vols.; T. Örlík, *Drikkehorn* (wassal horns), in progress; Thieme and Becker, *Allgemeines Lexikon der bildenden Künstler von der Antike bis zur Gegenwart*. (E. A. J.)

PLATEAU, JOSEPH ANTOINE FERDINAND (1801-1883), Belgian physicist, was born at Brussels on the 14th of October 1801, and died on the 15th of September 1883 at Ghent, where he had been professor of physics from 1835. He was a pupil and friend of L. A. J. Quetelet, who had much influence on the early part of his career. The more original investigations of Plateau refer chiefly to portions of one or other of two branches of science—physiological optics and molecular forces. We owe to him the "stroboscopic" method of studying the motion of a vibrating body, by looking at it through equidistant radial slits in a revolving disk. In 1820 he imprudently gazed at the midday sun for 20 seconds, with the view of studying the after effects. The result was blindness for some days, succeeded by a temporary recovery, but for the next fourteen years his sight gradually deteriorated, and in 1843 he became permanently blind. This calamity did not interrupt his scientific activity. Aided by his wife and son, and afterwards by his son-in-law G. L. van der Mensbrugge, he continued to the end of his life his researches on vision—directing the course of the experiments which they made for him, and interpreting the bearing of the results. He also published a valuable analytical catalogue of all the more important memoirs which had been written, from the earliest times to the end of the 18th century, on his favourite theme of subjective visual phenomena. But even more extraordinary were this blind man's investigations about molecular forces, embracing hundreds of novel experiments whose results he saw only with others' eyes. These form the subject of his great work *Statique expérimentale et théorique des liquides soumis aux seules forces moléculaires* (2 vols., 1873), a valuable contribution to our knowledge of capillary phenomena. His son, Félix Auguste Joseph Plateau (b. 1841), became professor of zoology and comparative anatomy at Ghent in 1870.

PLATEAU (a French term, older *platé*, for a flat piece of wood, metal, &c., from *plat*, flat), in physical geography, an elevated region of level or gently undulating land-surface, the term being synonymous with "table-land." The most clearly defined plateaus have steep flanks in contrast with their level summits, but the term does not necessarily connote a steep ascent from the surrounding country. Indeed, it is applied to such diverse forms as the high-lying plains encircled by the higher elevations of the Andes, and to those of the west of North America, which rise almost imperceptibly from the low central plains. A plateau may have its origin either in the upheaval of strata which preserve their original horizontal position during the process, or in the prolonged denudation of an originally broken surface. The two forms are distinguished respectively as Plateaus of Deposition and Plateaus of Erosion.

PLATED WARE, articles chiefly intended for table use consisting of an inferior metal or alloy covered by one of the precious metals, with the object of giving them the appearance of gold or silver. Before the introduction of electro-plating the method employed for silver-plating (the invention of which in 1742 is associated with the name of Thomas Boslover, of Sheffield) was to fuse or burn together, by a flux of borax, a thin sheet of silver on each side of an ingot of base metal, generally copper, or German silver, which is an alloy of copper. The silver plates were firmly wired to the ingot, which was then placed in a heated furnace and brought nearly to the fusing-point of the silver. The artisan knew the exact moment to withdraw the ingot. When cold it was rolled down to a sheet, and from such sheets "silver-plated" articles were made. Articles like dish-covers were originally only silver-plated on one side, and after being worked into shape were tinned inside with pure tin. In Birmingham bar-copper was the base metal used; when bare of silver this showed blood-red. The Sheffield manufacturers, on the other hand, used shot-copper mixed with brass (an alloy of copper and zinc) in the proportion of 4 or 6 to 1. In this way they got rid of the redness of the copper and rendered it harder, and their product is the "old Sheffield plate" (q.v.) that has become famous all over the world. This method of plating rapidly declined with the introduction of the newer process of electro-plating (q.v.), by which it has been superseded. Plating with nickel is extensively used for bedsteads and other articles of upholstery, and for various parts of bicycles, steamships, railway carriages, &c. Steel sheets are also plated with nickel for cooking purposes, and iron is plated with brass.

PLATEN-HALLERMUND, AUGUST, GRAF VON (1796-1835), German poet and dramatist, was born on the 24th of October 1796 at Ansbach, the son of the *Oberforstmeister* in the little principality of that name. The latter, together with other Franconian principalities, having shortly after his birth become incorporated with Bavaria, he entered the school of cadets (*Kadettenhaus*) in Munich, where he showed early promise of poetical talent. In 1810 he passed into the royal school of pages (*konigliche Pagerie*), and in 1814 was appointed lieutenant in the regiment of Bavarian life-guards. With it he took part in the short campaign in France of 1815, being in bivouac for several months near Mannheim and in the department of the Yonne. He saw no fighting, however, and returned home with his regiment towards the close of the same year. Possessed of an intense desire for study, and finding garrison life distasteful and irksome, he obtained a long leave of absence, and after a tour in Switzerland and the Bavarian Alps, entered the university of Würzburg in 1818 as a student of philosophy and philology. In the following year he migrated to that of Erlangen, where he sat at the feet of F. W. J. von Schelling, and became one of his most enthusiastic admirers. As a result of his Oriental studies he published a little volume of poems—*Ghaselen* (1821), each consisting of ten to twenty verses, in which he imitates the style of Rückert; *Lyrische Blätter* (1821); *Spiegel der Hasis* (1822); *Vermischte Schriften* (1822); and *Neue Ghaselen* (1823). These productions attracted the attention of eminent men of letters, among them Goethe, both by reason of their contents, which breathe the spirit of the East, and also of the purity and elegance

of their form and diction. Though he was at first influenced by the school of Romanticism, and particularly by Spanish models, yet the plays written during his university life at Erlangen, *Der gläserne Pantoffel*, *Der Schatz des Rhampsiniit*, *Berengar, Treue um Treue*, *Der Turm mit sieben Pforten*, show a clearness of plot and expression foreign to the Romantic style. His antagonism to the literature of his day became more and more pronounced, and he vented his indignation at the want of art shown by the later Romanticists, the inanity of the lyricists, and the bad taste of the so-called fate tragedies (*Schicksalstragödien*), in the witty "Aristophanic" comedies *Die verhängnisvolle Gabel* (1826) and *Der romantische Oedipus* (1828).

The want of interest, amounting even to hostility, with which Platen's enthusiasm for the purity and dignity of poetry was received in many literary circles in Germany increased the poet's indignation and disgust. In 1826 he visited Italy, which he henceforth made his home, living at Florence, Rome and Naples. His means were slender, but, though frequently necessitous, he felt happy in the life he had chosen, that of a "wandering rhapsodist." *Der romantische Oedipus* earned for him the bitter enmity of Karl Immermann and Heinrich Heine, and in the literary feud which ensued Heine launched the most baseless calumnies at the poet, which had the effect of prejudicing public opinion against him. But he retained many staunch admirers, who delighted in the purity of the subject matter of his productions and their beauty of form and diction. In Naples, where he formed the friendship of August Kopisch, the poet and painter, were written his last drama *Die Liga von Cambrai* (1833) and the delightful epic fairy-tale *Die Abbassiden* (1830; 1834), besides numerous lyrical poems, odes and ballads. He also essayed historical work in a fragment, *Geschichten des Königreichs Neapel* (1838), without, however, achieving any marked success. In 1832 his father died, and after an absence of eight years Platen returned to Germany for a while, and in the winter of 1832-1833 lived at Munich, where he revised the first complete edition of his poems, *Gedichte* (1833). In the summer of 1834 he returned to Italy, and, after living in Florence and Naples, proceeded in 1835 to Sicily. Dread of the cholera, which was at that time very prevalent, induced him to move from place to place, and in November of that year he was taken ill at Syracuse, where he died on the 5th of December 1835. Like Heine himself, Platen failed in the drama, but his odes and sonnets, to which must be added his *Polenlieder* (1831), in which he gives vent to his warm sympathy for the Poles in their rising against the rule of the Tsar, are in language and metre so artistically finished as to rank among the best classical poems of modern times.

Platen's *Gesammelte Werke* were first published in one volume in 1839, and have been frequently reprinted; a convenient edition is that edited by K. Goedeke in Cotta's *Bibliothek der Weltliteratur* (4 vols., 1882). His *Tagebuch* (1796-1825), was published in its entirety by G. von Laubmann and L. von Scheffler (2 vols., 1896-1900). See J. Minckwitz, *Graf Platen als Mensch und Dichter* (1838); P. Besnon, *Platen, étude biographique et littéraire* (1894); O. Greulich, *Platens Literaturkomödien* (1901); A. Fries, *Platen-Forschungen* (1903); and R. Unger, *Platen in seinem Verhältnis zu Goethe* (1903).

PLATERSPIEL, BLATERPFEIFE, a medieval simplified bagpipe, consisting of an insufflation tube, a bladder and a chaunter; the double reed in its socket at the top of the chaunter being concealed within the bladder. In the platerspiel we recognize the early medieval *chorus*, a word which in medieval Latin was frequently used also for the bagpipe. In the earlier forms of platerspiels of which we possess illustrations, such as the well-known example of the 13th century reproduced by Martin Gerbert from a MS. at St Blasius, the bladder is unusually large, and the chaunter has, instead of a bell, the grotesque head of an animal with gaping jaws. At first the chaunter was a straight conical tube terminating in a bell, as in the bagpipe. The later instruments have a pipe of larger calibre more or less curved and bent back as in the *chromorne*. One of these appears in the 13th-century Spanish MS., known as the

*Cantigas de Santa Maria*¹ in the Escorial, together with a platerspiel having two pipes, a chaunter and a drone side by side. Another is figured by Virdung (1511).

There was practically no technical difference between the bent platerspiel and the chromorne, the only distinction being the form and size of the air-chamber in which the reed was set in vibration by the compressed air forced into it through the insufflation tube or the raised slit respectively of the two instruments. The earlier form of platerspiel is found at the end of the 15th century, in the magnificent Book of Hours, known as the *Sforza Book*² (Brit. Mus.). An interesting allusion to the platerspiel occurs in an old English ballad.³ Eight shepherds were playing on various instruments: "the fyrst hed ane drone bagpipe, the next hed ane pipe maid of ane bladdir and of ane rrid, the thrid playit on ane trump, &c.," from which it is evident that the platerspiel retained its individuality and did not become merged in the bagpipe. (K. S.)

PLATFORM (Fr. *plateforme*, i.e. ground plan), a word now generally confined to a raised flat structure or stage, temporary or permanent, erected in a building or in the open air, from which speeches, addresses, lectures, &c., can be delivered at a public or other meeting. Similar structures of wood, brick or stone, are used in railway stations at such a level above the rails as to enable passengers to have easy access to the carriages; and in fortification the word is used of the raised level surface on which guns are mounted. The earlier uses of the word, such as for a plane geometrical figure, the ground plan of a building, and figuratively, for a plan, design, scheme, &c., are now obsolete. In a figurative sense the term is applied to a common basis on which members of a political party may agree, and especially in the United States to the declaration made by a party at a national or state convention.

PLATINUM [symbol Pt, atomic weight 195.0 (O=16)], a metallic chemical element. The name, derived from *platina*, the diminutive of Span. *plata* (silver), was first given to a mineral, platinum ore or native platinum, originally discovered in South America, from the resemblance to silver. Russia furnishes about 95% of the world's annual supply of platinum.

Native platinum occurs usually in small metallic scales or flat grains, sometimes in the form of irregular nuggets, and occasionally, though rarely, in small crystals belonging to the cubic system. Grains of platinum have been found embedded, with chromite, in serpentine derived from an olivine-rock, the metal having probably separated out from an original basic magma. It is said to occur also in veins in syenitic and other rocks. Usually, however, platinum is found in detrital deposits, especially in auriferous sands, where it is associated with osmiridium (known also as iridosmine), chromite, magnetite, corundum, zircon, &c. The platinum has a steel grey or silver-white colour and a metallic lustre; is often magnetic, sometimes with polarity; has a hardness of about 4.5 and a specific gravity varying with its composition from 14 to 19. Native platinum usually contains more or less iron and copper, often gold, and invariably a small proportion of some of the allied metals—iridium, osmium, ruthenium, rhodium and palladium. From the associated metals it was named by J. F. L. Hausmann polyxene (Gr. *πολύς*, many, and *ξένος*, a guest), whilst from its occurrence as a white metal in auriferous alluvia it is sometimes known to miners as "white gold."

Platina del Pinto was the name by which native platinum was first introduced into Europe from South America about the middle of the 18th century. Although it appears to have been known locally much earlier, the attention of scientific men in Europe was first directed to it by Antonio de Ulloa y Garcia de La Torre, a Spaniard who joined a French scientific expedition to Peru in 1735, and published in 1748 an account of his journey, in which he refers to platinum, though not under that name, as occurring with gold in New Granada (now Colombia). Sir William Watson, an English physicist, had, however, in 1741 received some grains of the mineral, probably from the

¹ Reproduced by J. F. Riaño, in *Studies of Early Spanish Music* (London, 1887).

² See facsimile edited by Dr George Warner, pl. xxviii. fol. 51.

³ See F. J. Furnivall, *Captain Cox, his ballads and Books*, or *Robert Lancham's Letter A.D. 1575* (London, 1871), clx. 86.

same locality, though brought by way of Jamaica; and it was he who first described it in 1750 as a new metal.

Native platinum was discovered in 1819 in the gold washings of Verkhniy-Isetsk, in the Urals, but it was not until 1822 that its true nature was recognized. The chief Russian localities are in the districts of Nizhne Tagilsk and Goroblagodatsk, where it is found in shallow drift deposits, containing pebbles of serpentine, which represent the original matrix. The Islet district has acquired importance in recent years. Although the platinum-bearing gravels usually contain a very small proportion of the metal, the average in 1895 being only 1½ dwt. to the ton, rich discoveries have occasionally been made in the history of the workings, and nuggets of exceptional size have been unearthed. The largest recorded specimens are one of 310 oz. from Nizhne Tagilsk, and another of 72½ oz. from the Goroblagodatsk district.

In 1831 platinum ore was recognized in the gold-bearing deposits of Borneo, where it had previously been regarded as worthless, being known to the natives as *mas kodok* (frog gold). Although recorded from various parts of the island, its occurrence seems to be definitely known only in Tanah-Laut, in the south-east of Borneo. In Australia platinum ore has been found near Fifield (near Condoberlin), New South Wales; whilst in New Zealand it occurs in sands and gravels in the Thames gold-field, the Takaka River and the Gorge River flowing into Awarua Bay. Many localities in North America have yielded platinum, generally in beach sands or in auriferous alluvia, and in some cases the deposits are of commercial importance. The metal is found in Alaska, British Columbia, Oregon (Douglas county) and California (Butte county, Trinity county, Del Norte county). It has been recorded also from the states of New York and North Carolina. In a nickeliferous sulphide ore worked at Sudbury, in Ontario, platinum has been discovered in the form of an arsenide (Pt As₂), which has been called sperrylite by H. L. Wells, who analysed it in 1889, and named it after F. L. Sperry, of Sudbury. It belongs to the pyrites group, and is interesting as being the only known mineral in which platinum occurs in combination except as alloy.

Native platinum seems to be a mineral of rather wide distribution, but in very sparse quantity. The sands of the Rhine, derived from Alpine rocks, have been found to contain platinum in the proportion of 0.0004%. It has also been found in the sands of the Ivalo River in Lapland; it is recorded from Rösos in Norway; and it was detected by W. Mallet in some of the gold-sands of the streams in Co. Wicklow, Ireland.

The table shows the official amount (in ounces Troy) of platinum produced in Russia for certain years, the actual amounts are much larger:—

Year.	Amount.	Year.	Amount.
1890	116,640	1904	161,950
1895	141,757	1905	167,950
1900	163,060	1906	185,492
1901	203,257	1907	172,758
1902	197,024	1908	157,005
1903	192,976		

(Rothwell's *Mineral Industry*, 1908.)

Platinum is largely used for the manufacture of chemical apparatus, incandescent lamps, thermo-couples; in the manufacture of sulphuric acid by the contact process, in photography, and in jewelry. The price of the metal has risen considerably, not so much on account of the restricted supply, but chiefly because the sources of supply have passed into the hands of a few individuals. The following data show the fluctuations in the average price of platinum ingot per ounce Troy:—

	£	s.	d.	£	s.	d.
1874-1898:	1	5	2	2	2	0
1899-1905:	3	13	6	4	10	4
1906:	4	15	2	7	19	8
1907:	7	0	0	6	18	8
1908:	5	2	6			

Platinum may be extracted from its ore by both wet and dry processes. In the latter method, due to H. Sainte-Claire-Deville and H. J. Debray, the ore is smelted in a furnace constructed of two blocks of lime, and the metallic button so obtained is

re-melted in a reverberatory furnace with galena or litharge, the lead platinum alloy being then cupped, and the platinum fused into an ingot by re-smelting in a lime furnace (see Dingler's *Polytech. Journ.*, 1859, 153, p. 38; 1859, 154, p. 38; 1862, 165, p. 205). The platinum so obtained is not pure. In Wollaston's wet method the ore is dissolved in aqua regia, the osmium, ruthenium and rhodium being left unattacked, and the platinum precipitated as ammonium platinochloride by adding ammonium chloride in the presence of an excess of acid. The double chloride is then washed, dried and ignited, leaving a residue of metal. G. Matthey (*Chem. News*, 1879, 39, p. 175) obtains pure platinum from the commercial metal by fusing the latter with a large excess of lead. The lead alloy is then treated with a dilute nitric acid and the insoluble portion taken up in dilute aqua regia. From the solution so obtained lead is precipitated as sulphate, and platinum and rhodium as double ammonium chlorides. The rhodium ammonium chloride is converted by fusing with potassium and ammonium bisulphates into rhodium sulphate, which is then removed by extraction with water, when a residue of finely divided platinum remains. The German firm of Heräus (in Hanover) heat the raw ore with aqua regia and water under pressure, evaporate the solution to dryness, and heat the residue to 125°C. A clear aqueous extract of the residue is then acidified with hydrochloric acid and precipitated with ammonium chloride. The double chloride is ignited and the finely divided platinum so obtained is fused in the oxyhydrogen blowpipe.

Platinum is a greyish-white metal which is exceedingly malleable and ductile; the addition of a small quantity of iridium hardens it and diminishes its ductility very considerably. Its specific gravity is 20.85 to 21.71, and its mean specific heat from 0 to 100°C. is 0.0323 (J. Violle, *Comptes rendus*, 1877, 85, p. 543); W. P. White (*Amer. Journ. Sci.*, 1909, iv, 28, p. 130) gives the general formula $S_0 = 0.03198 + 3.4 \times 10^{-4} T$, S_0 being the specific heat at $T^\circ C$. Its temperature of fusion is in the neighbourhood of 1700 to 1800°C., various intermediate values having been obtained by different investigators (see J. A. Harker, *Chem. News*, 1905, 91, p. 262; C. Féry and C. Châteaueau, *Comptes rendus*, 1909, 148, p. 401; also C. W. Waidner and G. H. Burgess, *ibid.*, 1909, 148, p. 1177). Its latent heat of fusion is 27.18 calories (Violle, *loc. cit.*). The metal has been obtained in the crystalline condition by distillation in the electric furnace, or by decomposing its fluoride at a red heat (H. Moissan). Platinum, like palladium, absorbs large quantities of hydrogen and other gases, the occluded gas then becoming more "active", for this reason platinum is used largely as a catalytic agent. Several forms of platinum, other than the massive form, may be obtained. *Spongy platinum* is produced when ammonium platinochloride is ignited; *platinum black* on the reduction of acid solutions of platinum salts; and *colloidal platinum* by passing an electric arc between two platinum wires under the surface of pure water (G. Bredig, *Zeit. phys. Chem.*, 1901, 37, pp. 1, 323). Platinum is practically unoxidizable; it combines directly with phosphorus, arsenic, antimony, silicon, boron, and fluorine, and with almost all other metals. It is practically unattacked by all acids, dissolving only in aqua regia or in mixtures which generate chlorine. When fused with alkaline hydroxides in the presence of air it forms platmates. It is readily attacked by fused nitrates, and by potassium cyanide and ferrocyanide. All the platinum compounds when heated strongly decompose, and leave a residue of the metal. Of platinum salts, in the true sense of the word, none exist; there is no carbonate, nitrate, sulphate, &c.; halide salts, however, are known, but are obtained in an indirect manner.

Platinum monoxide, PtO, obtained by heating the corresponding hydrate, is a dark-coloured powder which is easily reduced to the metal (L. Wöhler, *Ber.*, 1903, 36, p. 3475). The hydrated form, PtO·2H₂O, is obtained impure by precipitating the dichloride with caustic soda, or by adding caustic soda to a boiling solution of potassium platinochloride, K₂PtCl₆, the precipitate being rapidly washed and dried *in vacuo* (L. Wöhler, *Zeit. anorg. Chem.*, 1904, 40, p. 423). It is a black powder; when freshly prepared it is soluble in concentrated acids, but when dried it is insoluble. It behaves as a strong oxidizing and reducing agent. C. Engler and L. Wöhler (*Zeit. anorg. Chem.*, 1901, 29, p. 1) have shown that platinum black, containing occluded oxygen, is soluble in dilute hydrochloric acid and also liberates iodine from potassium iodide, and that the ratio between the amount of platinum dissolved and the amount of oxygen occluded agrees with the formation of a compound corresponding to the formula PtO. *Platinum dioxide* (platinic

oxide), $\text{PtO}_2 \cdot 4\text{H}_2\text{O}$, is obtained by adding an excess of caustic soda solution to a boiling solution of chloroplatinic acid, the hot solution being diluted and neutralized with acetic acid. It loses its water of hydration when heated, finally decomposing into platinum and oxygen. When freshly prepared it is soluble in dilute acids. Other hydrated forms of composition, $\text{PtO}_2 \cdot 3\text{H}_2\text{O}$ and $\text{PtO}_2 \cdot 2\text{H}_2\text{O}$, have been described (E. Prost, *Bull. soc. chim.*, 1886, 46, p. 156; H. Topsoë, *Ber.*, 1870, 3, p. 462). The tetrahydrate may be considered as an acid, $\text{H}_2\text{Pt}(\text{OH})_4$, for salts are known (namely the platinites) corresponding to it, those of the alkali metals being soluble in water, and possessing an alkaline reaction (M. Blondel, *Ann. chim. phys.*, 1905 [viii.], 6, p. 81). A similar set of chlorine-holding compounds is also known, the chlorine replacing one or more hydroxyl groups and giving rise to complexes of composition, $\text{H}_2\text{PtCl}_2(\text{OH})_2$, $\text{H}_2\text{PtCl}_2(\text{OH})_3$ and $\text{H}_2\text{PtCl}_2(\text{OH})_4$. The platinitic salts (derived from PtO_2) are yellow or brown solids, which are readily reduced to the metallic condition. They give with sulphuretted hydrogen a dark brown precipitate, soluble in excess of ammonium sulphide. Potassium iodide gives a brown solution with gradual formation of a precipitate. They form characteristic precipitates with potassium and ammonium chlorides. The platinitous salts are brown or colourless solids which, with sulphuretted hydrogen, give a dark brown precipitate of platinum sulphide, and with potassium iodide a gradual precipitation of platinitic iodide, PtI_2 . **Platinum trioxide**, PtO_3 , is obtained as $\text{K}_2\text{O} \cdot 3\text{PtO}_3$, by electrolysis a solution of platinitic hydroxide in potash, this compound with acetic acid giving the oxide as a brown, easily decomposable powder (L. Wöhler and F. Martin, *Ber.*, 1909, 42, p. 1326).

Platinum bichloride, PtCl_2 , is obtained by heating chloroplatinic acid to 300–350° C. (J. J. Berzelius), or mixed with more or less platinum chloride, by passing chlorine over spongy platinum at a temperature of 250° C. (P. Schützenberger, *Comptes rendus*, 1870, 70, pp. 1134, 1287). It may also be obtained by the decomposition of the compound $\text{HCl} \cdot \text{PtCl}_2 \cdot 2\text{H}_2\text{O}$ (see below) at 100° C., this method giving a very pure product (L. F. Nilson, *Journ. prak. Chem.*, 1877 (2), 15, p. 260). It is a brown or greyish green coloured solid, which is soluble in hydrochloric acid. It decomposes into its constituent elements when heated. It combines with many chlorides to form characteristic double salts. Platinum bichloride combines with carbon monoxide, yielding compounds of composition, $\text{PtCl}_2 \cdot \text{CO}$, $\text{PtCl}_2 \cdot 2\text{CO}$, $2\text{PtCl}_2 \cdot \text{CO}$ (P. Schützenberger, *Ann. chim. phys.*, 1870 (4), 21, p. 350). Hydrogen platinochloride or chloroplatinous acid, H_2PtCl_4 , is only known in solution, and as such is obtained when platinum bichloride is dissolved in hydrochloric acid, or by decomposing the barium salt with sulphuric acid, or the silver salt with hydrochloric acid. Its salts, the platinochlorides or chlorplatinites, are obtained by reducing the chlorplatinites or directly from the acid itself. They are mostly soluble in water giving red solutions. They are readily oxidized, and nascent hydrogen reduces them to metallic platinum. **Potassium platinochloride or chlorplatinitis**, K_2PtCl_6 , is prepared by reducing hydrogen platinochloride with sulphur dioxide, or potassium platinochloride with potassium oxalate in the presence of iridium (Klason, *Ber.*, 1904, 37, p. 1360); or by adding potassium chloride to a solution of platinum bichloride in hydrochloric acid. It crystallizes in dark red prisms, is readily soluble in water, but insoluble in alcohol. The solution of the free acid when concentrated *in vacuo* leaves a residue of $\text{HCl} \cdot \text{PtCl}_2 \cdot 2\text{H}_2\text{O}$. When the free acid is reduced by alcohol, or when ethylene is passed into a solution of platinum bichloride in hydrochloric acid, $\text{PtCl}_2 \cdot \text{C}_2\text{H}_4$ is obtained as a brown amorphous mass which decomposes when heated. When the bichloride is heated in a current of carbon monoxide, a sublimate of platino-monocarbonyl dichloride, $\text{PtCl}_2 \cdot \text{CO}$, dicarbonyl dichloride, $\text{PtCl}_2(\text{CO})_2$, and tricarbonyl tetrachloride, $\text{Pt}_2\text{Cl}_4(\text{CO})_3$, is obtained. The first forms bright yellow needles and the second white acicular crystals. The bichloride also combines with phosgene to form $\text{PtCl}_2 \cdot 2\text{COCl}_2$.

Platinic chloride, PtCl_4 , is obtained when chloroplatinic acid is heated in a current of dry hydrochloric acid gas to 165° C. (W. Pullinger, *Journ. Chem. Soc.*, 1892, 61, p. 422) or in a current of dry chlorine at 275° C. (A. Rosenheim and W. Löwenstein, *Zeit. anorg. Chem.*, 1903, 37, p. 394). It forms a reddish brown crystalline mass which is very hygroscopic. Numerous hydrates are known. The chloride is characterized by the readiness with which it forms double salts with the metallic chlorides and with the hydrochlorides of most organic bases. **Chloroplatinic acid**, $\text{H}_2\text{PtCl}_6 \cdot 6\text{H}_2\text{O}$, is obtained by dissolving platinum in aqua regia containing an excess of hydrochloric acid, or by the action of chlorine (dissolved in hydrochloric acid) on platinum sponge. It crystallizes in needles, which are very deliquescent and dissolve easily in water. It melts in its own water of crystallization at 70° C., and when heated *in vacuo* to 100° C. it leaves a residue of composition $\text{HCl} \cdot \text{PtCl}_2 \cdot 2\text{H}_2\text{O}$. The potassium and ammonium salts and the salts it forms with organic bases are characterized by their exceedingly small solubility in water. The aqueous solution of the acid reddens litmus and decomposes the metallic carbonates. Its salts may be prepared by the direct action of the acid on the metallic hydroxides or carbonates, and are usually of an orange or yellow colour and are mostly soluble in water. **Potassium chlorplatinitic**, K_2PtCl_6 , is obtained, in the form of a yellow crystalline precipitate, when a concentrated solution of a potassium salt

is added to a solution of chloroplatinic acid. It crystallizes in octahedra which are scarcely soluble in water, and practically insoluble in absolute alcohol. It decomposes at a red heat into platinum, chlorine and potassium chloride. The corresponding sodium salt, $\text{Na}_2\text{PtCl}_6 \cdot 6\text{H}_2\text{O}$, is much more soluble in water and in alcohol. The ammonium salt, $(\text{NH}_4)_2\text{PtCl}_6$, resembles the potassium salt in its solubility in water and in alcohol. Corresponding bromo- and iodo-compounds are known. **Platinum bisulphide and tetrasulphide**, PtS_2 and PtS_4 , were obtained simultaneously by H. Moissan (*Ann. chim. phys.*, 1894 (6), 24, p. 282) by the action of fluorine on platinum at 500–600° C. They may be separated by taking advantage of their different solubilities in water.

Platinum monosulphide, PtS , is obtained by the direct union of platinum and sulphur; by heating ammonium chlorplatinitic with sulphur; or by the action of sulphuretted hydrogen on the chlorplatinites. It is a dark coloured powder which is almost insoluble in aqua regia. It decomposes when heated strongly leaving a residue of metallic platinum, the same reduction taking place at comparatively low temperatures when it is heated in a current of hydrogen. **Platinic sulphide**, PtS_2 , is formed when the chlorplatinites are heated with sulphuretted hydrogen to 60° C. The precipitate must be rapidly washed and dried *in vacuo*, since it oxidizes rapidly on exposure to air. It is a black powder, which when heated strongly in air decomposes and leaves a residue of platinum, but if heated in absence of air leaves a residue of the monosulphide. It is scarcely affected by acids and is little soluble in solutions of the alkaline sulphides. Sulphides of composition PtS_2 and PtS_4 have been described (R. Schneider, *Pogg. Ann.*, 1869, 138, p. 604; 1870, 148, p. 633; 1873, 149, p. 381). A salt of composition, $\text{Pr}(\text{OH})_2 \cdot \text{H}_2\text{SO}_4 \cdot \text{H}_2\text{O}$, has been prepared by M. Blondel (*Ann. chim. phys.*, 1905 (8), 6, p. 81) by the solution of the hydrate $\text{H}_2\text{Pt}(\text{OH})_4$, *i.e.* $\text{PtO}_2 \cdot 4\text{H}_2\text{O}$, in dilute sulphuric acid (1:1) at 0° C. On the addition of cold concentrated sulphuric acid to the solution so obtained, the above salt is precipitated in the form of minute needles, which readily decompose in the presence of water. **Platinum sulphate**, $\text{Pt}(\text{SO}_4)_2 \cdot 2\text{H}_2\text{O}$, has been obtained by L. Stuchlik (*Ber.*, 1904, 37, p. 2913) by the action of sulphuric acid (s.g. 1.84) on platinum under the influence of an alternating current. A crystalline precipitate is obtained, which is soluble in water and is very hygroscopic.

The **platinochlorides** of composition $\text{M}_2\text{Pt}(\text{NO}_3)_4$ are mostly obtained by double decomposition from the potassium salt, which is formed by adding a warm aqueous solution of potassium nitrite to one of potassium chlorplatinitic. They are mostly colourless or pale yellow solids which are more or less soluble in water (L. F. Nilson, *Ber.*, 1876, 9, p. 1722). The corresponding platino-oxalates $\text{M}_2\text{Pt}(\text{C}_2\text{O}_4)_2$ were first obtained by J. W. Döbereiner (*Pogg. Ann.*, 1833, 104, p. 180) and their constitution was determined by H. G. Söderbaum (*Ber.*, 1888, 21, p. 567 R; *Zeit. anorg. Chem.*, 1894, 6, p. 45). The sodium salt, from which the others are obtained by double decomposition, is formed by adding a warm solution of oxalic acid to sodium platinate. On recrystallization from alkaline solutions the salts are obtained in yellow or orange crystals (see M. Veves, *Bull. soc. chim.*, 1898 (3), 19, p. 875). These salts are scarcely soluble in water and decompose explosively when suddenly heated. The free acid is obtained by decomposing the silver salt with hydrochloric acid, the indigo blue solution so obtained on concentration *in vacuo* yielding a red crystalline mass, which dissolves in water with an indigo blue colour, changing to yellow on dilution.

Platinum cyanide, $\text{Pt}(\text{CN})_2$, is formed by the addition of mercuric cyanide to a solution of a chlorplatinitic, or by the decomposition of mercury or ammonium platino-cyanide by heat. It is an amorphous powder which is insoluble in water, acids or alkalis, but is soluble in a solution of hydrocyanic acid. It burns when heated. The platino-cyanides are derived from the acid $\text{H}_2\text{Pt}(\text{CN})_4$, which is formed by the decomposition of the mercury or copper salt with sulphuretted hydrogen, or of the barium salt with sulphuric acid. It crystallizes from water in cinnabar-red prisms which contain five molecules of water of crystallization; in the anhydrous condition it is of a yellowish green colour. It decomposes carbonates. Its salts, which are characterized by the property of polychroism, may be prepared by the usual methods, or by the solution of metallic platinum in the alkaline cyanides or alkaline earth cyanides under the influence of an alternating current (A. Brochet and J. Petit, *Ann. chim. phys.*, 1904 (8), 3, p. 460; M. Berthelot, *Comptes rendus*, 1904, 138, p. 1130). Those of the alkali and alkaline earth metals are soluble in water. Many combine with the halogen elements to form complex salts of the type $\text{M}_2\text{Pt}(\text{CN})_4 \cdot \text{Cl}_2 \cdot \text{H}_2\text{O}$. By the decomposition of the barium salts of this type, addition products of the free acid, of composition $\text{H}_2\text{Pt}(\text{CN})_4 \cdot \text{Cl}_2 \cdot 4\text{H}_2\text{O}$ and $\text{H}_2\text{Pt}(\text{CN})_4 \cdot \text{Br}_2$, have been obtained (C. Blomstrand, *Ber.*, 1869, 2, p. 202). They are deliquescent solids which are exceedingly soluble in water. **Potassium platino-cyanide**, $\text{K}_2\text{Pt}(\text{CN})_4 \cdot 3\text{H}_2\text{O}$, is obtained by dissolving platinum bichloride in potassium cyanide; by heating potassium ferrocyanide with spongy platinum; or by heating ammonium chlorplatinitic with potassium cyanide. It crystallizes in needles which effloresce readily. The dry salt is exceedingly hygroscopic and is very soluble in water. When boiled with aqua regia it forms the chlorine addition

product, $K_2Pt(CN)_4 \cdot 2Cl_2 \cdot 2H_2O$. It combines directly with iodine. *Barium platinumcyanide*, $BaPt(CN)_4 \cdot 4H_2O$, is prepared by the action of baryta water on the copper salt; by dissolving platinum in barium cyanide under the influence of an alternating current; by the addition of barium cyanide to platinum bichloride; or by the simultaneous action of hydrocyanic and sulphurous acids on a mixture of baryta and chlorplatinic acid (P. Bergsøe, *Zeit. anorg. Chem.*, 1899, 19, p. 318). It crystallizes in yellow monoclinic prisms and is soluble in hot water. It is employed for the manufacture of fluorescent screens used for the detection of X-rays.

The platinum salts combine with ammonia to form numerous derivatives which can be considered as salts of characteristic bases. The first compound of this type was isolated in 1828 by Magnus, who obtained a green salt by the action of ammonia on platinum bichloride. Two series of these salts are known, one in which the metal corresponds to bivalent platinum, the other in which it corresponds to tetravalent platinum. The general formulae of the groups in each series are shown below, the method of classification being that due to Werner.

Divalent (platinous) Salts.		Tetravalent (platinic) Salts.	
Tetrammine salts	$Pt(NH_3)_2X_2$	Hexammine salts	$Pt(NH_3)_4X_2$
Triammine "	$Pt(NH_3)_3X_3$	Tetrammine "	$Pt(NH_3)_2X_4$
Diammine "	$Pt(NH_3)_4X_4$	Triammine "	$Pt(NH_3)_3X_3$
Monammine "	$Pt(NH_3)_5X_5$	Diammine "	$Pt(NH_3)_4X_4$
		Monammine "	$Pt(NH_3)_5X_5$

In the above table X represents a monovalent acid radical and R a monovalent basic radical. For methods of preparation of salts of these series see P. T. Cleve, *Bull. soc. chim.* 1867 et seq.; S. M. Jørgensen, *Journ. prakt. Chem.* 1877 et seq.; C. W. Blomstrand, *Ber.* 1871 et seq.; and A. Werner, *Zeit. anorg. Chem.* 1893 et seq. A very complete account of the method of classification and the general theory of the metal ammonia compounds is given by A. Werner, *Ber.* 1907, 40, p. 15.

Platinum also forms a series of complex phosphorus compounds. At 250° finely divided platinum and phosphorus pentachloride combine to form $PtCl_2 \cdot PCl_5$, as dark claret-coloured crystals. With chlorine this substance gives $PtCl_2 \cdot PCl_3$ as a yellow powder, and with water it yields phosphoplatinic acid, $PtCl_2 \cdot P(OH)_3$, which may be obtained as orange-red deliquescent prisms.

The atomic weight of platinum was determined by K. Seubert (*Ann.* 1888, 207, p. 1; *Ber.* 1888, 21, p. 2179) by analyses of ammonium and potassium platinochlorides, the value 194.86 being obtained.

PLATO, the great Athenian philosopher, was born in 427 B.C., and lived to the age of eighty. His literary activity may be roughly said to have extended over the first half of the 4th century B.C. His father's name was Ariston, said to have been a descendant of Codrus; and his mother's family, which claimed descent from Solon, included Critias, one of the thirty tyrants, and other well-known Athenians of the early 4th century B.C. That throughout his early manhood he was the devoted friend of Socrates, that in middle life he taught those who resorted to him in the grove named Academus, near the Cephissus, and there founded the first great philosophical school, that (with alleged interruptions) be continued to preside over the Academy until his death, are matters of established fact. It is said by Aristotle that he was at one time intimate with Cratylus the Heraclitean. Beyond this we have no authentic record of his outward life. That his name was at first Aristocles, and was changed to Plato because of the breadth of his shoulders or of his style or of his forehead, that he wrestled well,¹ that he wrote poetry² which he burnt on hearing Socrates, fought in three great battles,³ that he had a thin voice, that (as is told of other Greek philosophers) he travelled to Cyrene and conversed with priests in Egypt, are statements of Diogenes Laërtius, which rest on more or less uncertain tradition. The express assertion—which this author attributes to Hermodorus—that after the death of Socrates Plato and other Socratics took refuge with Euclides in Megara, has a somewhat stronger claim to authenticity. But the fact cannot be regarded as certain, still less the elaborate inferences which have been drawn from it. The romantic legend of Plato's journeys to Sicily, and of his relations there with the younger Dionysius and the princely but unfortunate Dion, had obtained some degree

of consistency before the age of Cicero, and at an unknown but probably early time was worked up into the so-called *Epistles of Plato*, now all but universally discredited. Nor is there sufficient ground for supposing, as some have done, that an authentic tradition is perceptible behind the myth.

The later years of the Peloponnesian War witnessed much mental disturbance and restlessness at Athens. More than at any time since the age of Cleisthenes, the city ^{Anticlerical} ^{Conditions.} was divided, and a man's foes were often men of his own tribe or deme. Contention in the law-courts and rivalries in the assembly had for many men a more absorbing interest than questions of peace and war. Hereditary traditions had relaxed their hold, and political principles were not yet formulated. Yet there was not less scope on this account for personal ambition, while the progress of democracy, the necessity of conciliating the people, and the apportionment of public offices by lot had a distracting and, to reflecting persons, often a discouraging effect. For those amongst whom Plato was brought up this effect was aggravated by the sequel of the oligarchical revolution, while, on the other hand, for some years after the restoration of the democracy, a new stimulus had been imparted, which, though of short duration, was universally felt.

These events appear in two ways to have encouraged the diffusion of ideas. The ambitious seem to have welcomed them as a means of influence, while those who turned from public life were the more stimulated to speculative disputation. However this may have been, it is manifest that before the beginning of the 4th century B.C. the intellectual atmosphere was already charged with a new force, which although essentially one may be differently described, according to the mode of its development, as (1) rhetorical and (2) theoretical and "sophistical." This last word indicates the channel through which the current influences were mostly derived. A new want, in the shape both of interested and of disinterested curiosity, had insensibly created a new profession. Men of various fatherlands, some native Athenians, but more from other parts of Hellas,⁴ had set themselves to supplement the deficiencies of ordinary education, and to train men for the requirements of civic life. More or less consciously they based their teachings on the philosophical dogmas of an earlier time, when the speculations of Xenophanes, Heraclitus or Parmenides had interested only a few "wise men." Those great thoughts were now to be expounded, so that "even cobblers might understand."⁵ The self-appointed teachers found a rich field and abundant harvest among the wealthier youth, to the chagrin of the old-fashioned Athenian, who sighed with Aristophanes for the good old days when men knew less and listened to their elders and obeyed the customs of their fathers. And such distrust was not wholly unfounded. For, amidst much that was graceful and improving, these novel questionings had an influence that, besides being unsettling, was aimless and unreal. A later criticism may discern in them the two great tendencies of naturalism and humanism. But it may be doubted if the sophist was himself aware of the direction of his own thoughts. For, although Prodicus or Hippias could debate a thesis and moralize with effect, they do not appear to have been capable of speculative reasoning. What passed for such was often either verbal quibbling or the pushing to an extreme of some isolated abstract notion. That *prudens quaestio* which is *dimidium scientiae* had not yet been put. And yet the hour for putting it concerning human life was fully come. For the men on which men were drifting was profoundly troubled, and would not sink back into its former calm. Conservative reaction was not less hopeless than the dreams of theorists were mischievously wild. In random talk, with gay, irresponsible energy, the youth were debating problems which have exercised great minds in Europe through all after time.

Men's thoughts had begun to be thus disturbed and eager when Socrates (q.v.) arose. To understand him is the most necessary preliminary to the study of Plato. There is no reason to doubt

¹ See *Laws*, vii. 814 c.

² Some epigrams in the *Anthology* are attributed to him.

³ This is told on the authority of Aristoxenus. But Plato cannot have been at Delium.

⁴ It had been the policy of Pericles to invite distinguished foreigners to Athens.

⁵ *Theaet.* 180 D.

the general truth of the assertion, which Plato attributes to him in the *Apologia*, that he felt a divine vocation to examine himself by questioning other men. He was really doing for Athenians, whether they would or no, what the sophist professed to do for his adherents, and what such men as Protagoras and Prodicus had actually done in part. One obvious difference was that he would take no fee. But there was another and more deep-lying difference, which distinguished him not only from the contemporary sophists but from the thinkers of the previous age. This was the Socratic attitude of inquiry. The sceptical movement had confused men's notions as to the value of ethical ideas.¹ If "right is one thing in Athens and another in Sparta, why strive to follow right rather than expediency? The laws put restraint on nature, which is prior to them. Then why submit to law?" And the ingenuities of rhetoric had stirred much unmeaning disputation. Every case seemed capable of being argued in opposite ways. Even on the great question of the ultimate constitution of things, the conflicting theories of absolute immutability and eternal change appeared to be equally irrefragable and equally untenable. Men's minds had been confused by contradictory voices—one crying "All is motion," another "All is rest"; one "The absolute is unattainable," another "The relative alone is real"; some upholding a vague sentiment of traditional right, while some declared for arbitrary convention and some for the law "of nature." Some held that virtue was spontaneous, some that it was due to training, and some paradoxically denied that either vice or falsehood had any meaning. The faith of Socrates, whether instinctive or inspired, remained untroubled by these jarring tones. He did not ask "Is virtue a reality?" or "Is goodness a delusion?" But, with perfect confidence that there was an answer, he asked himself and others "What is it?" (*ti esti*); or, more particularly, as Xenophon testifies, "What is a state? What is a statesman? What is just? What is unjust? What is government? What is it to be a ruler of men?" In this form of question, however simple, the originality of Socrates is typified; and by means of it he laid the first stone, not only of the fabric of ethical philosophy, but of scientific method, at least in ethics, logic and psychology. Socrates never doubted that if men once knew what was best, they would also do it. They erred, he thought, from not seeing the good, and not because they would not follow it if seen. This is expressed in the Socratic *dicta*: "Vice is ignorance," "Virtue is knowledge." This lifelong work of Socrates, in which the germs of ethics, psychology and logic were contained, was idealized, developed, dramatized—first embodied and then extended beyond its original scope—in the writings of Plato, which may be described as the literary outcome of the profound impression made by Socrates upon his greatest follower. These writings (in pursuance of the importance given by Socrates to conversation) are all cast in the form of imaginary dialogue. But in those which are presumably the latest in order of composition this imaginative form interferes but little with the direct expression of the philosopher's own thoughts. The many-coloured veil at first inseparable from the features is gradually worn thinner, and at last becomes almost imperceptible.

Plato's philosophy, as embodied in his dialogues, has at once an intellectual and a mystical aspect; and both are dominated by a pervading ethical motive. In obeying the Socratic impulse, his speculative genius absorbed and harmonized the various conceptions which were present in contemporary thought, bringing them out of their dogmatic isolation into living correlation with one another, and with the life and experience of mankind. His poetical feeling and imagination, taking advantage of Pythagorean and Orphic suggestions, surrounded his abstract reasonings with a halo of mythology which made them more fascinating, but also more difficult for the prosaic intellect to comprehend. Convinced through the conversations of Socrates that truth and good exist and that they are inseparable, persuaded of the unity of virtue and of its dependence upon knowledge, he set forth upon a course of inquiry,

¹ See Caird, *Hegel*, p. 168.

in which he could not rest until the discrepancies of ordinary thinking were not only exposed but accounted for, and resolved in relation to a comprehensive theory. In this "pathway towards reality," from the consideration of particular virtues he passed to the contemplation of virtue in general, and thence to the nature of universals, and to the unity of knowledge and being. Rising still higher on the road of generalization, he discussed the problem of unity and diversity, the one and the many. But in these lofty speculations the facts of human experience were not lost to view. The one, the good, the true, is otherwise regarded by him as the moral ideal, and this is examined as realized both in the individual and in the state. Thus ethical and political speculations are combined. And as the method of inquiry is developed, the leading principles both of logic and of psychology become progressively more distinct and clear. Notwithstanding his high estimate of mathematical principles, to him the type of exactness and certitude, Plato contributed little directly to physical science. Though he speaks with sympathy and respect of Hippocrates, he had no vocation for the patient inductive observation of natural processes, through which the Coan physicians, though they obtained few lasting results, yet founded a branch of science that was destined to be beneficently fruitful. And he turned scornfully aside from the Atomists, Leucippus and Democritus, whose first principle, the basis of so much in modern physics, appeared to him to be tainted with materialism. Yet his discursive thought, as in later years he held high intercourse with Archytas and other contemporary minds, could not fail, unlike his master's, to include a theory of the *Cosmos* in its purview. In this regard, however, the poet-philosopher brought imagination to the aid of reason, thus creating a new mythology, of which the *Timæus* is the most conspicuous example.

Amidst great diversity, both of subject and of treatment, Plato's dialogues are pervaded by two dominant motives, a passion for human improvement and a persistent faith in the power and supremacy of mind. What is commonly known as his doctrine of Ideas is only one phase in a continuous progress towards the realization of a system of philosophy in which the supreme factor is reason guiding will. But the objectivity, which from the first was characteristic of all Greek thinking, and his own power of poetic presentation, obscured for a time, even for Plato himself, the essential spirituality of his conceptions, and at one time even threatened to arrest them at a stage in which the universal was divorced from the particular, the permanent from the transient, being from becoming, and in which the first principles of reality were isolated from one another as well as from the actual world. Gradually the veil was lifted, and the relation between the senses and the intellect, phenomena and general laws, the active and the contemplative powers, came to be more clearly conceived. The true nature of abstraction and generalization, and of predication and inference, began to be discerned, and speculation was verified through experience. The ideas were seen as categories, or forms of thought, under which the infinite variety of natural processes might be comprised. And thus the dialogues present, as in a series of dissolving views, a sort of model or compendium of the history of philosophy. Plato's system is nowhere distinctly formulated, nor are the views put forward in his dialogues always consistent with each other, but much especially of his later thought is systematized, and as it were crystallized in the treatises of Aristotle; by whom the point of view which Plato had approached, but not finally attained, was made the starting-point for more precise metaphysical determinations and carried into concrete theories having the stamp of a more rigid logical method. The departments of ethics and politics, of dialectic and of psychology, of physics and metaphysics, thus came to be more clearly distinguished, but something was lost of the unity and intensity of spiritual insight which had vitalized these various elements, and fused them in a dynamic harmony.

The student of philosophy, whatever may be the modern system to which he is most inclined, sensational, intuitional, conceptional, transcendental, will find his account in returning

to this well-spring of European thought, in which all previous movements are absorbed, and from which all subsequent lines of reflection may be said to diverge. As was observed by Jowett (*St Paul*, 1855), "the germs of all ideas, even of most Christian ones, are to be found in Plato."

Two great forces are persistent in Plato: the love of truth and zeal for human improvement. In the period culminating with the *Republic*, these two motives, the speculative and the practical, are combined in one harmonious working. In the succeeding period, without excluding one another, they operate with alternate intensity. In the varied outcome of his long literary career, the metaphysical "doctrine of ideas" which has been associated with Plato's name underwent many important changes. But pervading all these there is the same constant belief in the supremacy of reason and the identity of truth and good. From that abiding root spring forth a multitude of thoughts concerning the mind and human things—turning chiefly on the principles of psychology, education and political reform—thoughts which, although unverified, and often needing correction from experience, still constitute Plato the most fruitful of philosophical writers. While general ideas are powerful for good or ill, while abstractions are necessary to science, while mankind are apt to crave after perfection, and ideals, either in art or life, have an acknowledged value, so long the renown of Plato will continue. "All philosophic truth is Plato rightly divined; all philosophic error is Plato misunderstood"—is the verdict of one of the keenest of modern metaphysicians.¹

Plato's followers, however, have seldom kept the proportions of his teaching. The diverse elements of his doctrine have survived the spirit that informed them. The pythagorizing mysticism of the *Timaeus* has been more prized than the subtle and clear thinking of the *Theaetetus*. Logical inquiries have been hardened into a barren ontology. Semi-mythical statements have been construed literally and mystic fancies perpetuated without the genuine thought which underlay them. A part (and not the essential part) of his philosophy has been treated as the whole. But the influence of Plato has extended far beyond the limits of the Platonic schools. The debt of Aristotle to his master has never yet been fully estimated. Zeno, Chrysippus, Epicurus borrowed from Plato more than they knew. The moral ideal of Plutarch and that of the Roman Stoics, which have both so deeply affected the modern world, could not have existed without him. Neopythagoreanism was really a crude Neoplatonism. And the Sceptics availed themselves of weapons either forged by Plato or borrowed by him from the Sophists. A wholly distinct line of infiltration is suggested by the mention of Philo and the Alexandrian school (cf. section in *Arabian Philosophy*, li. 26bc, 9th edition), and of Clement and Origen, while Gnostic heresies and even Talmudic mysticism betray perversions of the same influence. The effect of Hellenic thought on Christian theology and on the life of Christendom is a subject for a volume, and has been pointed out in part by E. Zeller and others (cf. NEOPLATONISM). Yet when Plotinus in the 3rd century (after hearing Ammonius), amidst the revival of religious paganism, founded a new spiritualistic philosophy upon the study of Plato and Aristotle combined, this return to the fountain head had all the effect of novelty. And for more than two centuries, from Plotinus to Proclus, the great effort to base life anew on the Platonic wisdom was continued. But it was rather the ghost than the spirit of Plato that was so "unsphered." Instead of striving to reform the world, the Neoplatonist sought after a retired and cloistered virtue. Instead of vitalizing science with fresh thought, he lost hold of all reality in the contemplation of infinite unity. He had skill in dealing with abstractions, but laid a feeble hold upon the actual world.

"Hermes Trismegistus" and "Dionysius Areopagita" are names that mark the continuation of this influence into the middle ages. The pseudo-Dionysius was translated by Erigena in the 9th century.

Two more "Platonic" revivals have to be recorded—

¹ Ferrier, *Institutes of Metaphysics*, p. 169 (§ i. prop. vi. § 12).

Florence in the 15th and at Cambridge in the 17th century. Both were enthusiastic and both uncritical. The translation of the dialogues into Latin by Marsilio Ficino was the most lasting effect of the former movement, which was tinged with the unscientific ardour of the Renaissance. The preference still accorded to the *Timaeus* is a fair indication of the tendency to bring *sumum ex fulgore* which probably marred the discussions of the Florentine Academy concerning the "chief good." The new humanism had also a sentimental cast, which was alien from Plato. Yet the effect of this spirit on art and literature was very great, and may be clearly traced not only in Italian but in English poetry.

The "Cambridge Platonists" have been described by Principal Tulloch in his important work on *Rational Theology in England in the 17th century*, and again by Professor J. A. Stewart in the concluding chapter of his volume on the *Myths of Plato*. Their views were mainly due to a reaction from the philosophy of Hobbes, and were at first suggested as much by Plotinus as by Plato. It is curious to find that, just as Socrates and Ammonius (the teacher of Plotinus) left no writings, so Whichcote, the founder of this school, worked chiefly through conversation and preaching. His pupils exercised a considerable influence for good, especially on English theology; and in aspiration if not in thought they derived something from Plato, but they seem to have been incapable of separating his meaning from that of his interpreters, and Cudworth, their most consistent writer, was once more systematic and less scientific than the Athenian philosopher. The translations of Sydenham and Taylor in the 18th century and the beginning of the 19th are proofs of the continued influence of Platonism in England.

The critical study of Plato begins from Schleiermacher, who did good work as an interpreter, and tried to arrange the dialogues in the order of composition. His attempt, which, like many efforts of constructive criticism, went far beyond possibility, was vitiated by the ground-fallacy of supposing that Plato had from the first a complete system in his mind which he partially and gradually revealed in writing. At a considerably later time Karl Friedrich Hermann, to whom the students of Plato are indebted, renewed the same endeavor as the far more plausible assumption that the dialogues faithfully reflect the growth of Plato's mind. But he also was too sanguine and exaggerated the possibility of tracing a connexion between the outward events of Plato's life and the progress of his thought. This great question of the order of the dialogues, which has been debated by numberless writers, is one which only admits of an approximate solution. Much confusion, however, has been obviated by the hypothesis (first hinted at by Ueberweg, and since supported by Lewis Campbell and others) that the *Sophists* and *Politicus*, whose genuineness had been called in question by Joseph Socher, are really intermediate between the *Republic* and the *Laws*. The allocation of these dialogues, not only on grounds of metaphysical criticism, but also on philological and other evidence of a more tangible kind, supplies a point of view from which it becomes possible to trace with confidence the general outlines of Plato's literary and philosophical development. Reflecting at first in various aspects the impressions received from Socrates, he is gradually touched with an inspiration which becomes his own, and which seeks utterance in half-poetical forms. Then first the ethical and by and by the metaphysical interest becomes predominant. And for a while this last is so absorbing, as he confronts the central problems which his own thoughts have raised. But, again, the hard-won acquisitions of this dialectical movement must be fused anew with imagination and applied to life. And in a final effort to use its intellectual wealth for the subvention of human need the great spirit passed away.

It may not be amiss to recapitulate the steps through which the above position respecting the order of the dialogues has become established. Lovers of Hegel had observed that the point reached in the *Sophists* in defining *Order of Dialogues* "not being" was dialectically in advance of the *Republic*. But Kantian interpreters might obviously have seen

the same of the *Parmenides*: and Grote as a consistent utilitarian looked upon the *Protagoras* as the most mature production of Plato's genius. It seemed desirable to find some criterion that was not bound up with philosophical points of view. Dr Thompson, the Master of Trinity College, Cambridge, had vindicated the genuineness of the *Sophistes* against the objections of Socher, but had not accounted for the peculiarities of language, which that acute critic had perceived. By comparing those peculiarities with the style of the *Laws*, Plato's latest work, and with that of the *Timæus* and *Critias*, which presupposed the *Republic*, Lewis Campbell argued in 1867 that the *Sophistes* and *Politicus*, with the *Philebus*, were in chronological sequence intermediate between the *Republic* and the *Laws*. Thus a further defence of their authenticity was at the same time a long step towards the solution of the problem which Schleiermacher had proposed. Many years afterwards the more detailed stylistic investigations of W. Dittenberger, Constantin Ritter and others arrived independently at the same conclusion. It was vehemently supported by W. Lutoslawski in his work on *Plato's Logic*, and has been frankly accepted with ample acknowledgments by the high authority of Dr Theodor Gomperz (see especially the Notes to his *Greek Thinkers*, iii. 310, 315 of English translation).

THE WORKS OF PLATO

The Platonic dialogues are not merely the embodiment of the mind of Socrates and of the reflections of Plato. They are the portraiture of the highest intellectual life of Hellas in the time of Plato—a life but distantly related to military and political events, and scarcely interrupted by them. Athens appears as the centre of the excitable Hellenic mind, profoundly stirred by the arrival of great sophists, and keenly alive to the questions of Socrates, although in the pages of Plato, even more than in reality, he only "whispers with a few striplings in a corner." For, in the Platonic grouping, the agora, which was the chief scene of action for the real Socrates, retires into the background, and he is principally seen consorting with his chosen companions, who are also friends of Plato, and with the acquaintances whom he makes through them. The scene is narrowed (for the Academy was remote from the bustle of resort, and Plato judged the Hellenic world securely from the vantage-ground of partial retirement)—but the figures are distinct and full of life. In reading the dialogues we not only breathe the most refined intellectual atmosphere, but are also present witnesses of the urbanity, the freedom, the playfulness, the generous warmth of the "best society" in Athens. For Plato has a numerous repertory of *dramatis personæ*, who stand in various relations to his chief character—the impetuous Chaerephon, Apollodorus the inseparable weak brother, old Crito the true-hearted, Phædo the beloved disciple, Simmias and Cebes, who have been with Philolaus, the graceful and ingenuous Phædrus, the petulant Philebus, Theætetus of the philosophic nature, who is cut off in his prime, and the incorrigible Alcibiades; then Plato's own kinsmen—Glaucon the irrepressible in politics, in quarrel and in love; Adeimantus, solid and grave; Critias in his phase of amateur philosopher, and not as what he afterwards became; Charmides, not in fiery manhood, but in his first bloom of diffident youth; and many others who appear as mere acquaintances, but have an interest of their own—the accomplished Agathon, the gay Aristophanes, Eryximachus the all-worthy physician; Meno, light of spirit; Callias, entertainer of sophists; Callicles the wilful man of the world; Cephalus the aged father of Lysis; and Nicias the honoured soldier. All these appear, not as some of them do on the page of history, in sanguinary contention or fierce rivalry, but as peaceful Athenians, in momentary contact with Socrates, whose electric touch now benumbs and now exhilarates, and sometimes goads to frenzy of love or anger. Still more distantly related to him, as it were standing in an outer circle, are the imposing forms of Gorgias and Protagoras, surrounded with the lesser lights of Hippias, Prodicus and Polus. Thrasymachus, Euthydemus, Dionysodorus hang round like comic masks, adding piquancy to the design. The adversaries Anytus and Meletus are allowed

to appear for a moment, but soon vanish. The older philosophers, though Socrates turned away from them, also make their entrance on the Platonic stage. Parmenides with his magnificent depth is made to converse with the imaginary Socrates, who is still quite young. A stranger from Elea plays an important part in some later dialogues, and Timæus the Pythagorean is introduced discoursing of the creation of the world. In these dialogues Socrates is mostly silent; in the *Philebus* he has lost himself in Plato; and in the twelve books of the *Laws*, where an unnamed Athenian is the chief speaker, even the Platonic Socrates finally disappears.

Now, in evolving his philosophy from the Socratic basis, Plato works along three main lines—the ethical and political, the metaphysical or scientific, and the mystical. All three are often intimately blended, as in the close of *Rep.*, bk. vi., and even where one element is uppermost the others are not wholly suppressed. But this distinction, like that sometimes made in modern philosophy between the good, the true and the beautiful, is one which, if not unduly pressed, may be usefully borne in mind.

Having noted this once for all, we pass to the more detailed consideration of the several dialogues.

I. *Laches, Charmides, Lysis*.—In this first group Socrates is dealing tentatively with single ethical notions. The result in each case is a confession of ignorance, but the subject has been so handled as to point the way to more fruitful discussions in the future. And suggestions are casually thrown out which anticipate some of the most far-reaching of Plato's subsequent contemplations.

The *Laches* is a vigorous sketch, in which the characters of the soldier, the aged citizen, and the prudent general are well preserved; and Socrates is seen conversing with his elders, although with reference to the treatment of the young. The question raised is the definition of courage; and the humour of the piece consists in showing that three men, all of whom are unquestionably brave, are unable to give an account of bravery, or to decide whether courage is an animal instinct or a mental accomplishment.

Similarly, in the dialogue which bears his name, the temperate Charmides, of whom all testify that (as Aristophanes has it),¹ he "fills up the gracious mould of modesty," is hopelessly embarrassed when challenged by the Socratic method to put in words his conception of the modesty or temperance which he possesses, and which, as Socrates assures him, is a priceless gift. The *Charmides* contains some hints of Platonic notions, such as that of knowledge as self-consciousness, and of virtue as "doing one's own business."

The graceful little dialogue which bears the name of *Lysis* ends, like the two former, with a confession of failure. Socrates, Lysis and Menexenus are all friends, and think highly of friendship, yet after many efforts they are unable to tell "what friendship is." Yet some of the suggestions which are here laid aside are afterwards allowed to reappear. The notion that "what is neither good nor evil loves the good because of the presence of evil" is expanded and emphasized in the *Symposium*. And the conception of an ideal object of friendship, an *αὐτὸ φίλον* (though rejected as in the criticism of Aristotle by the characteristic *reductio ad infinitum*), is destined to have a wider scope in the history of Platonism.

II. *Protagoras, Io, Meno*.—The previous dialogues have marked the distinction between unconscious and conscious morality, and have also brought out the Socratic tendency to identify virtue with the knowledge of good. Now, the more strongly it is felt that knowledge is inseparable from virtue the more strange and doubtful appears such unconscious excellence as that of Laches, Charmides or Lysis. Hence arises the further paradox of Socrates: "Virtue is not taught, and that which is commonly regarded as virtue springs up spontaneously or is received unconsciously by a kind of inspiration."

Protagoras, in the dialogue named after him, is the professor of popular, unscientific, self-complacent excellence; while

¹ *Nub.*, 995, τῆ ἀλοῦς μίλλης ῥέταλι' ἀνακρίσει.

Socrates appears in his life-long search after the ideal knowledge of the best. The two men are naturally at cross purposes.

Protagoras. Protagoras contends that virtue is taught by himself and others more or less successfully, and is not one but many. Socrates disputes the possibility of teaching virtue (since all men equally profess it, and even statesmen fail to give it to their sons), but affirms that, if it can be taught, virtue is not many, but one. The discussion, as in the former dialogues, ends inconclusively. But in the course of it Plato vividly sets forth the natural opposition between the empiric and scientific points of view, between a conventional and an intellectual standard. He does full justice to the thesis of Protagoras, and it is not to be supposed that he was contented to remain in the attitude which he has here attributed to Socrates. In his ideal state, where the earlier training of the best citizens is a refinement on the actual Hellenic education, he has to some extent reconciled the conceptions which are here dramatically opposed.

The preparations for the encounter and the description of it include many life-like touches—such as the eagerness of the young Athenian gentleman to hear the sophist, though he would be ashamed to be thought a sophist himself; the confusion into which the house of Callias has been thrown by the crowd of strangers and by the self-importance of rival professors; the graceful dignity of the man who has been forty years a teacher, the graphic description of the whole scene, the characteristic speeches of Prodicus and Hippias (from which some critics have elicited a theory of their doctrines), and the continued irony with which Socrates bears them all in hand and soothes the great man after disconcerting him.

In the argument there are two points which chiefly deserve notice. (1) Protagoras, in accordance with his relative view of things (which Plato afterwards criticized in the *Theaetetus*), claims not to teach men principles but to improve them in those virtues which Providence has given in some measure to all civilized men. (2) Socrates in postulating a scientific principle, which he expressly reserves for future consideration, would have it tested by the power of calculating the amount of pleasure. Grote dwells with some complacency on the "utilitarianism" of Socrates in the *Protagoras*. And it is true that a principle of utility is here opposed to conventional sentiment. But this opposition is intended to prepare the way for the wider and deeper contrast between an arbitrary and a scientific standard, or between impressions and conceptions or ideas. And when Plato (in the *Gorgias* and *Philebus*) endeavours to define the art of measurement, which is here anticipated, it is not wonderful that differences here unthought of should come into view, or that the pleasant should be again contradistinguished from the good. In all three dialogues he is equally asserting the supremacy of reason.

On the first vision of that transcendental knowledge¹ which is to be the key at once to truth and good, philosophy is apt to lose her balance, and to look with scorn upon "the trivial round, the common task," and the respectable commonplaces of "ordinary thinking." Yet, as Socrates is reminded by Protagoras, this unconscious wisdom also has a value. And Plato, who, when most ideal, ever strives to keep touch with experience, is fully convinced of the reality of this lower truth, of this unphilosophic virtue. But he is long puzzled how to conceive of it. For, if knowledge is all in all, what are we to make of wisdom and goodness in those who do not know? Protagoras had boldly spoken of honour and right as a direct gift from Zeus, and Socrates, in the *Io* and *Meno*, is represented as adopting an hypothesis of inspiration in order to account for these unaccredited graces of the soul.

Socrates has observed that rhapsodists and even poets have no definite knowledge of the things which they so powerfully represent (cf. *Apol.* 22; *Phaed.*, 245 A.; *Rep.* iii. 398 A).

He brings the rhapsode *Io* to admit this, and to conclude that he is the inspired medium of a magnetic influence. The Muse is the chief magnet, and the poet is the first of a series of magnetic rings. Then follow the rhapsode and the actor, who are rings of inferior power, and the last ring is the hearer or spectator.

The *Meno* raises again the more serious question, Can virtue be taught? Socrates here states explicitly the paradox with which the *Protagoras* ended. "Virtue is knowledge; therefore virtue can be taught. But virtue is not taught. Therefore (in the highest sense) there can be no virtue." And he repeats several of his former reasons—that Athenian

Meno.

statesmen failed to teach their sons, and that the education given by sophists is unsatisfying. (The sophists are here denounced by Anytus, who is angered by Socrates's ironical praise of them.) But the paradox is softened in two ways: (1) the absence of knowledge does not preclude inquiry, and (2) though virtue cannot be taught, yet there is a sense in which virtue exists.

1. Meno begins in gaiety of heart to define virtue, but is soon "benumbed" by the "torpedo" shock of Socrates, and asks "How can one inquire about that which he does not know?" Socrates meets this "eristic" difficulty with the doctrine of reminiscence (*ἀνάμνησις*). All knowledge is latent in the mind from birth and through kindred (or association of) ideas much may be recovered, if only a beginning is made. Pindar and other poets have said that the soul is immortal and that she has passed through many previous states.² And Socrates now gives a practical illustration of the truth that knowledge is evolved from ignorance. He elicits, from a Greek slave of Meno's, the demonstration of a geometrical theorem.³ About the middle of the process he turns to Meno and observes that the slave (who has made a false start) is now becoming conscious of ignorance. He then gradually draws from the man, by leading questions, the positive proof.

2. Though virtue is not yet defined, it may be affirmed "hypothetically" that, if virtue is knowledge, virtue can be taught. And experience leads us to admit two phases of virtue—the one a mode of life based on scientific principle, which hitherto is an ideal only; the other sporadic, springing of itself, yet of divine origin, relying upon true opinion, which it is, however, unable to seize fast through demonstration of the cause or reason. But if there were a virtuous man who could teach virtue he would stand amongst his fellows like Teiresias amongst the shades.⁴

This mystical account of ordinary morality is in keeping with the semi-mythical defence of the process of inquiry—that all knowledge is implicit in the mind from birth.

III. *Euthyphro*, *Apologia*, *Crito*, *Phaedo*.—There is no ground for supposing that these four dialogues were written consecutively, or that they belong strictly to the same period of Plato's industry. But they are linked together for the reader by their common reference to the trial and death of Socrates; no one of them has been proved to be in the author's earliest or latest manner; and they may therefore fitly end the series of dialogues in which the personal traits of the historic Socrates are most apparent, and Plato's own peculiar doctrines are as yet but partially disclosed.

The little dialogue known by the name of *Euthyphro* might have been classed with the *Laches*, *Charmides* and *Lysis*, as dealing inconclusively with a single notion. But, *Euthyphro*, although slight and tentative in form, it has an undertone of deeper significance, in keeping with the gravity of the occasion. Plato implies that Socrates had thought more deeply on the nature of piety than his accusers had, and also that his piety was of a higher mood than that of ordinary religious men.

Euthyphro is a soothsayer, well-disposed to Socrates, but not one of his particular friends. They meet at the door of the king Archon, whither Socrates has been summoned for the "pre-cognition" (*ἀπαγγελία*) preliminary to his trial. Both men are interested in cases of alleged impiety. For *Euthyphro's* business is to impeach his father, who has inadvertently caused the death of a criminal labourer. The prophet feels the duty of purging the stain of blood to be more imperative the nearer home. Socrates is struck by the strong opinion thus evinced respecting the nature of piety and detains *Euthyphro* at the entrance of the court, that he may learn from so clear an authority "what piety is," and so be fortified against Meletus. He leads his respondent from point to point, until the doubt is raised whether God loves holiness because it is holy, or it is holy because loved by God. Does God will what is righteous, or is that righteous which is willed by God? Here they find themselves wandering round and round. Socrates proves himself an involuntary Daedalus who makes opinions move, while he seeks for one which he can "bind fast with reason."

"The holy is a portion of the just." But what portion? "Due service of the gods by prayer and sacrifice." But how does this affect the gods? "It pleases them." Again we are found to be reasoning in a circle.

"Thus far has Socrates proceeded in placing religion on a moral foundation. He is seeking to realize the harmony of religion and

¹ The origin of this traditional belief is very obscure. The Greeks themselves were apt to associate it with Pythagoras and with the "Orphic" mysteries.

² *Euz.* i. 47 (the case where the triangle is isosceles).

³ *Hom. Odys.* x. 495; *Od.* τριπέδιλον, τὰ δὲ κῶλον ἰσοπέδιλον.

morality, which the great poets Aeschylus, Sophocles and Pindar had unconsciously anticipated, and which is the universal want of all men. To this the soothsayer adds the ceremonial element, 'attending upon the gods.' When further interrogated by Socrates as to the nature of this 'attention to the gods,' he replies that piety is an affair of business, a science of giving and asking and the like. Socrates points out the anthropomorphism of these notions. But when we expect him to go on and show that the true service of the gods is the service of the spirit and co-operation with them in all things true and good, he stops short; this was a lesson which the soothsayer could not have been made to understand, and which everyone must learn for himself.¹

In Plato's *Apology* the fate of Socrates is no longer the subject of mere allusions, such as the rage of Anytus at the end of the

Meno, and the scene and occasion of the *Euthyphro*. *Apology*. He is now seen face to face with his accusers, and with his countrymen who are condemning him to death.

What most aggravated his danger (after life-long impunity) is thus stated by James Riddell, in the introduction to his edition of the dialogue: "The *εὐκεία*" (clemency) "of the restored people did not last long, and was naturally succeeded by a sensitive and fanatical zeal for their revived political institutions. Inquiry into the foundations of civil society was obviously rather perilous for the inquirer at such a time. Socrates knew the full extent of his danger. But, according to Xenophon (*Mem.* iv. c. 8, § 14), he prepared no defence, alleging that his whole life had been a preparation for that hour."

The tone of the Platonic *Apology* is in full accordance with that saying; but it is too elaborate a work of art to be taken literally as a report of what was actually said. Jowett well compares it to "those speeches of Thucydides in which he has embodied his conception of the lofty character and policy of the great Pericles." Yet "it is significant that Plato is said to have been present at the defence, as he is also said to have been absent at the last scene of the *Phaedo*. Some of the topics may have been actually used by Socrates, and the recollection of his very words may have rung in the ears of his disciple."

The Platonic *Apology* is in three parts: (1) before conviction, (2) after conviction and before sentence, (3) after the sentence.

1. Socrates cares not for acquittal. But he does care to explain his life. And he selects those aspects of it which there is hope of making his audience understand. That he partly succeeded in this is shown by the large number of those (220 out of 500) who voted for his acquittal.

a. His answer to Meletus, as least important, is reserved for the middle of his speech. He addresses himself first to "other accusers"—comic poets and the rest, who have prejudiced his reputation by falsely identifying him with the physical philosophers and the sophists. But what then is the strange pursuit which has given to Socrates the name of wise? It is the practice of cross-examining, to which he was first impelled by the oracle at Delphi, and which he has followed ever since as a religious mission. The god said "Socrates is wise," when he was conscious of no wisdom great or small. So he went in search of some one wiser than himself, but could find none, though he found many who had conceit of wisdom. And he inferred that the god must mean "He is wisest who, like Socrates, is most aware of his own ignorance." This unceasing quest has left him in great poverty, and has made him enemies, who are represented by Anytus, Meletus and Lycon. And their enmity is further embittered by the pleasure which young men take in seeing pretence unmasked, and in imitating the process of refutation. Hence has arisen the false charge that Socrates is a corrupter of youth.

b. Here he turns to Meletus. "If I corrupt the youth, who does them good?" *Mei.* "The laws, the judges, the audience, the Athenians generally" (cf. *Protagoras* and *Meno*). "Strange, that here only should be one to corrupt and many to improve; or that any one should be so infatuated as to wish to have bad neighbours." *Mei.* "Socrates is an atheist. He believes the sun to be a stone." "You are accusing Anaxagoras. I have said that I knew nothing of such theories. And you accuse me of introducing novel notions about divine things. How can I believe in divine things (*θεῶν βίαια*) and not in divine beings (*θεῶν οὐσίαι*)? and how in divine beings, if not in gods who are their authors?"

c. That is a sufficient answer for his present accuser. He returns to the general long-standing defamation, which may well be his death, as slander has often been and again will be the death of many a man.

Yet if spared he will continue the same course of life, in spite of the danger. As at Potidea and Delium he faced death where the Athenians posted him, so now he will remain at the post where he

is stationed by the god. For to fear death is to assume pretended knowledge.

One thing is certain. A worse man cannot harm a better. But if the Athenians kill Socrates they will harm themselves. For they will lose the stimulus of his exhortations—and his poverty is a sufficient witness that he was sincere. Not that he would engage in politics. If he had done that he would have perished long before, as he nearly did for his independent vote after the battle of Arginusae, and for disobeying the murderous command of the Thirty Tyrants.

But have not Socrates's disciples, Alcibiades, Critias, Charmides, proved bad citizens? He has no disciples. Any one, bad or good, may come and hear him, and the talk which is his life-work is not unamusing. But why are no witnesses brought to substantiate this charge? There are elder friends of his companions, who would be angry if he had used his influence for harm. But these men's confidence in Socrates is unshaken.

He will not appeal *ad misericordiam*. That would be a disgrace for one who (rightly or not) has been reputed wise, and to admit such an appeal in any case is a violation of the juror's oath.

Socrates has told the Athenians the whole truth, so far as a mixed audience of them could receive it. Elaboration and subtlety could have no place in addressing the Heliastic court, nor could that universal truth towards which he was leading men be made intelligible to a new audience while the clogysyria was running. But his tone and attitude must have made a strong appeal to the better nature of his hearers. With Meletus he "played rather than fought," but he has shown clearly that he has no fear of death, that he chooses to obey God rather than man, and that for very love of the Athenians he will not be swayed by their desires.

2. One convicted on a capital charge had the right of pleading before sentence in mitigation of the penalty proposed by his accuser. Socrates was convicted by fewer votes than he himself anticipated. The indictment of Meletus was ineffectual, and if it had not been for the speeches of Anytus and Lycon the defendant would have been triumphantly acquitted. Could he but have conversed with his judges more than once, he might have removed their prejudices. In no spirit of bravado, therefore, but in simple justice to himself, he meets the claim of Meletus that he shall be punished with death by the counterclaim that he shall be maintained in the Prytaneum as a public benefactor. He cannot ask that death, which may be a good, shall be commuted for imprisonment or exile, which are certainly evils. A fine would be no evil: but he has no money—he can offer a mina. Here Plato and others interpose, and with their friendly help he offers thirty minae.

3. He is sentenced to death, and the public business of the court is ended. But while the record is being entered and the magistrates are thus occupied, Socrates is imagined as addressing (a) the majority, and (b) the minority in the court.

a. To those who have condemned him he speaks in a prophetic tone. "For the sake of depriving an old man of the last days of life they have given Athens a bad name. He would not run away, and so death has overtaken him. But his accusers are overtaken by unrighteousness, and must reap the fruits of it.

"Nor will the Athenians find the desired relief. Other reprovers, whom Socrates has hitherto restrained, will now arise, not in a friendly but in a hostile spirit. The only way for the citizens to escape reproof is to reform their lives."

b. To the minority, who would have acquitted him, he speaks with gentle solemnity. "Let them know to their comfort that the divine voice has not once checked him throughout that day. This indicates that death is not an evil. And reason shows that death is either a long untroubled sleep, or removal to a better world, where there are no unjust judges.

"No evil can happen to a good man either in life or after death. Therefore Socrates will not be angry with his condemners, who have done him no harm, although they meant him anything but good. He will only ask of them to do to the sons of Socrates as Socrates has done to them."

Is the love of truth consistent with civic duties? Is the philosopher a good citizen? are questions which are sure to arise where the truth involves practical improvement.

In the *Apology* Socrates appears as an intrepid reformer; the *Crito* gives an impressive picture of him as a loyal and law-abiding Athenian.

Execution had been delayed during the annual mission to Delos (during which no one could be put to death). But the returning vessel had just been reported as desecrated from Sunium. At early dawn Crito, the oldest friend of Socrates, obtained access to his cell, and found him sleeping peacefully. Presently he awoke, and Crito told him of the approach of the fatal ship. Socrates replies by telling his dream. A fair form stood over him and said,

"The third day hence to Ptochia shalt thou come"

And it would seem that the day after to-morrow will really be the day for going home.

¹ Jowett.

² Cf. *Gorg.* 521; *Rep.* vi. 496.

Crito then reveals his plan for an escape. And Socrates argues the question in the old familiar way. "Crito's zeal is excellent, and most men would think his object right. But the few who think soundly say that it is wrong to return evil for evil. The laws of Athens (through the fault of men) are doing Socrates harm. But ought he therefore to infringe the law? Might not the laws of his country plead with him and say: 'You owe to us your birth and breeding; and when grown up you voluntarily submitted to us. For you might have gone elsewhere. But you preferred us to all other laws, and have been the most constant resident in Athens. Even at the last you accepted death rather than exile. If you now break your covenant you will ruin your friends and will be rejected by all well-ordered cities. You might be received in Thessaly, but could only live there by cringing to foreigners for food. Where in that case will be your talk about virtue? You would not take your sons thither. And your friends would be equally kind to them if you were dead. Think not of life and children first and of justice afterwards, but think of justice first, that you may be justified in the world below.'"

Crito admits these arguments to be unanswerable.

The *Meno* referred to the immortality and pre-existence of the soul as a traditional doctrine, and it was there associated with the possibility of inquiry. In the *Phaedo* Plato undertakes to substantiate this belief and base it anew by narrating the last hours of Socrates, who is represented as calmly discussing the question with his friends when his own death was immediately at hand. The argument turns chiefly on the eternity of knowledge, and is far from satisfying. For, granting that eternity of knowledge involves eternity of mind, does the eternity of mind assure continued being to the individual? Yet no unprejudiced reader of the *Phaedo* can doubt that Plato, at the time of writing it, sincerely believed in a conscious personal existence after death. The words of Socrates, when he declares his hope of going to be with other friends, are absolutely unambiguous, and his reply to Crito's question, "How shall we bury you?" has a convincing force beyond all dialectic: "I cannot persuade Crito that I here am Socrates—I who am now reasoning and ordering discourse. He imagines Socrates to be that other, whom he will see by and by, a corpse." This and similar touches not only stamp the *Phaedo* as a marvel of art, but are indisputable evidence of the writer's profound belief. They may be inventions, but they have nothing "mythical" about them, any more than the charge of Socrates to his friends, that they would best fulfil his wishes by attending to their own lives.

The narrative, to be appreciated, must be read in full. But a short abstract of the argument may be given here.

1. Death is merely the separation of soul and body. And this is the very consummation at which philosophy aims. The body hinders thought. The mind attains to truth by retiring into herself. Through no bodily sense does she perceive justice, beauty, goodness and other ideas. The philosopher has a life-long quarrel with bodily desires, and he should welcome the release of his soul. Thus he alone can have true courage, even as temperance and all the virtues are real in him alone.

But does the soul exist after death?

a. An old tradition tells of many successive births, the soul departing to Hades and returning again, so that the living are born from the dead. And if the dead had no existence, this could not be, since from nothing nothing can arise. Moreover, experience shows that opposite states come from their opposites, and that such a process is always reciprocal. Death certainly succeeds to life. Then life must succeed to death. And that which undergoes these changes must exist through all. If the dead came from the living, and not the living from the dead, the universe would ultimately be consumed in death.

This presumption is confirmed by the doctrine (here attributed to Socrates, cf. *Meno*) that knowledge comes from recollection. What is recollected must be previously known. Now we have never since birth had intuition of the absolute equality of which (through association) we are reminded by the sight of things approximately equal. And we cannot have seen it at the moment of birth, for at what other moment can we have forgotten it? Therefore, if ideals be not vain, our souls must have existed before birth, and, according to the doctrine of opposites above stated, will have continued existence after death.

b. To enarm away the fears of the "child within," Socrates adds, as further considerations:—

¹ In the *Timæus* immortality is made to rest on the goodwill of God, because "only an evil being would wish to dissolve that which is harmonious and happy" (*Tim.* 41 A).

i. The soul is uncompounded, incorporeal, invisible, and therefore indissoluble and immutable.

ii. The soul commands, the body serves; therefore the soul is akin to the divine.

iii. Yet even the body holds together long after death, and the bones are all but indestructible.

The soul, if pure, departs to the invisible world, but, if tainted by communion with the body, she lingers hovering near the earth, and is afterwards born into the likeness of some lower form. That which true philosophy has purified alone rises ultimately to the gods. The lesson is impressively applied.

2. A pause ensues; and Simmias and Cebes are invited to express their doubts. For, as the swan dies singing, Socrates would be discoursing.

a. Simmias desires not to rest short of demonstration, though he is willing to make the highest attainable probability the guide of life.

If the soul is the harmony of the body, what becomes of her "when the lute is broken"?

b. Cebes compares the body to a garment which the soul keeps weaving at. The garment in which the weaver dies outlasts him. So the soul may have woven and worn many bodies in one lifetime, yet may perish and leave a body behind. Or even supposing her to have many lives, does even this hypothesis exempt her from ultimate decay?

Socrates warns his friends against losing faith in inquiry. Theories, like men, are disappointing; yet we should be neither misanthropists nor misologists. Then he answers his two friends.

a—i. The soul is acknowledged to be prior to the body. But no harmony is prior to the elements which are harmonized.

ii. The soul has virtue and vice, i.e. harmony and discord. Is there harmony of harmony? Cf. *Rep.* x. 609.

iii. All soul is equally soul, but all harmony is not equally harmonious.

iv. If the soul were the harmony of the body they would be agreed: but, as has been already shown, they are perpetually quarrelling.

v. The soul is not conditioned by the bodily elements, but has the power of controlling them.

b. Cebes has raised the wide question whether the soul is independent of generation and corruption. Socrates owns that he himself (i.e. Plato?) had once been fascinated by natural philosophy, and had sought to give a physical account of everything. Then, hearing out of Anaxagoras that mind was the disposer of all, he had hoped to learn not only how things were, but also why. But he found Anaxagoras forsaking his own first principle and jumbling causes with conditions. ("The cause why Socrates sits here is not a certain disposition of joints and sinews, but that he has thought best to undergo his sentence—else the joints and sinews would have been ere this, by Crito's advice, on the way to Thessaly.") Physical science never thinks of a power which orders everything for good, but expects to find another Atlas to sustain the world more strong and lasting than the reason of the best.

Socrates had turned from such philosophers and found for himself a way, not to gaze directly on the universal reason, but to seek an image of it in the world of mind, wherein are reflected the ideas, as, for example, the idea of beauty, through partaking of which beautiful things are beautiful. Assuming the existence of the ideas, he felt his way from hypothesis to hypothesis.

Now the participation of objects in ideas is in some cases essential and inseparable. Snow is essentially cold, fire hot, three odd, two even. And things thus essentially opposite are inclusive of each other's attributes. (When it was said above that opposite states or conditions of one thing). Snow cannot admit heat, nor fire cold; for they are inseparable vehicles of heat and cold respectively. The soul is the inseparable vehicle of life, and therefore, by parity of reasoning, the soul cannot admit of death, but is immortal and imperishable.

3. What follows is in the true sense *mythological*, and is admitted by Socrates to be uncertain: "Howbeit, since the soul is proved to be immortal, men ought to charm their spirits with such tales."

The earth, a globe self-balanced in the midst of space, has many mansions for the soul,² some higher and brighter, some lower and darker than our present habitation. We who dwell about the Mediterranean Sea are like frogs at the bottom of a pool. In some higher place, under the true heaven, our souls may dwell hereafter, and see not only colours and forms in their ideal purity but truth and justice as they are.

In the *Phaedo*, more than elsewhere, Plato preaches withdrawal from the world. The Delian solemnity is to Socrates

² Cf. Milton, *Il Penseroso*, 88-92—

"To unspere
The spirit of Plato, to unfold
What worlds or what vast regions hold
The immortal mind that hath forsook
Her mansion in this fleshly nook."

and his friends a period of "retreat," in which their eyes are turned from earthly things to dwell on the eternal. The theory of ideas here assumes its most transcendental aspect, and it is from portions of this dialogue and of the *Phaedrus* and *Timaeus* that the popular conception of Platonism has been principally derived. But to understand Plato rightly it is not enough to study isolated passages which happen to charm the imagination; nor should single expressions be interpreted without regard to the manner in which he presents the truth elsewhere.

It has already been shown (1) that Socratic inquiry implied a standard of truth and good, undiscovered but endlessly discoverable, and to be approached inductively; and (2) that in Plato this implicit assumption becomes explicit, in the identification of virtue with knowledge (*Lach.*, *Charm.*) as an art of measurement (*Protag.*), and in the vision (towards the end of the *Lysis*) of an absolute object of desire. The Socratic "self-knowledge" has been developed (*Charm.*) into a science of mind or consciousness, apart from which no physical studies can be fruitful. (3) Co-ordinate with these theoretical tendencies there has appeared in Plato the determination not to break with experience. In the *Phaedo*, a long step is made in the direction of pure idealism. The ordinary virtue, which in the *Protagoras* and *Meno* was questioned but not condemned, is here rejected as unreal, and the task proposed to the philosopher is less to understand the world than to escape from it. The universal has assumed the form of the ideal, which is supposed, as elsewhere in Plato, to include mathematical as well as moral notions. The only function of perception is to awaken in us some reminiscence of this ideal. By following the clue thus given, and by searching for clearer images of truth in the world of mind, we may hope to be emancipated from sensation, and to lay hold upon the sole object of pure reason.

It is obvious that when he wrote the *Phaedo* Plato conceived of universals as objective entities rather than as forms of thought. The notion of "ideal colours" (though occurring in the myth) is an indication of his ontological mood. Yet even here the *ēthē* are not consistently hypostatized. The notion of "what is best" has a distinctly practical side, and the "knowledge through reminiscence" is in one aspect a process of reflection on experience, turning on the laws of association.¹ It is also said that objects "partake" of the ideas, and some concrete natures are regarded as embodiments or vehicles of some of them. Still if regarded as a whole, notwithstanding the scientific attitude of Socrates, the *Phaedo* is rather a meditation than an inquiry—a study of the soul as self-existent, and of the mind and truth as coeternal.

IV. *Symposium*, *Phaedrus*, *Cratylus*.—Socrates is again imagined as in the fullness of life. But the real Socrates is becoming more and more inextricably blended with Platonic thought and fancy. In the *Apology* there is a distinct echo of the voice of Socrates; the *Phaedo* gives many personal traits of him; but the dialogues which are now to follow are replete with original invention, based in part, no doubt, on personal recollections.

The *Symposium* admits both of comparison and of contrast with the *Phaedo*. Both dialogues are mystical, both are *Symposium*. spiritual, but the spirituality in either is of a different order. That is here immanent which was there transcendent; the beautiful takes the place of the good. The world is not now to be annihilated, but rather transfigured, until particular objects are lost in universal light. Instead of flying from the region of growth and decay, the mind, through intercourse with beauty, is now the active cause of production. Yet the life of contemplation is still the highest life, and philosophy the truest *πολιτεία*.

The leading conception of the *Symposium* has been anticipated in the *Lysis*, where it was said that "the indifferent loves the good, because of the presence of evil."

The banqueters (including Socrates), who are met to celebrate the tragic victory of Agathon, happen not to be disposed for hard drinking. They send away the flute-girl and entertain each other with the praise of Love. *Phaedrus* tells how Love inspires to

honourable deeds, and how Alcetas and Achilles died for Love. Pausanias rhetorically distinguishes the earthly from the heavenly Love. The physician Eryximachus, admitting the distinction, yet holds that Love pervades all nature, and that art consists in following the higher Love in each particular sphere. So Empedocles had spoken of Love as overcoming previous discord. For opposites cannot, as Heraclitus fancied, coexist. Aristophanes, in a comic myth, describes the origin of Love as an imperfect creature's longing for completion. The original double human beings were growing impious, and Zeus split them in twain, ever since which act the bereaved halves wander in search of one another. Agathon speaks, or rather sings, of Love and his works. He is the youngest, not the eldest of gods, living and moving delicately wherever bloom is and in the hearts of men—the author of all virtue and of all good works, obeyed by gods, fair and causing all things fair, making men to be of one mind at feasts—pilot, defender, saviour, in whose footsteps all should follow, chanting strains of love.

Socrates will not attempt to rival the poet, and begins by stipulating that he may tell the truth. He accepts the distinction between Love and his works, but points out that, since desire implies want, and the desire of Love is toward beauty, Love, as wanting beauty, is not beautiful. So much being established in the Socratic manner, he proceeds to unfold the mystery once revealed to him by Diotima, the Mantinean wise woman. Love is neither beautiful nor ugly, neither wise nor foolish, neither god nor mortal. Between gods and mortals is the world of mediating spirits (*πρόσφύρα*). And Love is a great spirit, child of Resource (the son of Prudence) and Poverty the beggar maid, who conceived him at the birthday feast of Aphrodite. He is far from living "delicately," but is ragged and shodless, always in difficulties, yet always brimming with invention, a mighty hunter after wisdom and all things fair; sometimes "all full with feasting" on them, the next moment "clean starved" for lack; never absolutely knowing nor quite ignorant. That is to say, he is a "philosopher." For knowledge is the most beautiful thing, and love is of the beautiful.

But what does love desire of the beautiful? The possession is enough. But there is one kind of love—called "being in love"—which desires beauty for a peculiar end. The lover is seeking, not his "other half," but possession of the beautiful and *birth in beauty*. For there is a season of puberty both in body and mind, when human nature longs to create, and it cannot, save in presence of beauty. This yearning is the earnest of immortality. Even in the bird's devotion to its mate and to its young there is a craving after continued being. In individual lives there is a flux, not only of the body, but in the mind. Nay the sciences themselves also come and go (here the contrast to the *Phaedo* is at its height). But in mortal things the shadow of continuity is succession.

The love of fame is a somewhat brighter image of immortality than the love of offspring. Creative souls would bring into being not children of their body, but good deeds. And such a one is readiest to fall in love with a fair mind in a fair body, and then is filled with enthusiasm and begets noble thoughts. Homer, Hesiod, Lycurgus, Solon, were such genial minds. But they stopped at the threshold (cf. *Protag.*, *Meno*), and saw not the higher mysteries, which are reserved for those who rise from noble actions, institutions, laws, to universal beauty. The true order is to advance from one to all fair forms, then to fair practices, fair thoughts, and lastly to the single thought of absolute beauty. In that communion only, beholding beauty with the eye of the mind, one shall bring forth realities and become the friend of God and be immortal, if mortal man may.

Alcibiades here breaks in and is vociferously welcomed. He is crowning Agathon, when, on perceiving Socrates, he declares that he will crown him too. Then he announces himself king of the feast, and insists upon hard drinking (though this will make no difference to Socrates). Eryximachus demands from the newcomer a speech in praise of love. But Alcibiades will praise no one else when Socrates is near. And with the freedom of one who is deep in wine he proceeds with his strange encomium of "this Marsyas." "In face and outward bearing he is like a Satyr or Silenus, and by his voice he charms more powerfully than they do by their pipings. The eloquence of Pericles has no effect in comparison with his. His words alone move Alcibiades to shame, and fascinate him until he stops his ears and runs from him."—"I often wish him dead. Yet that would break my heart. He brings me to my wit's end."

—"And, as carved Sileni are made to encase images of gods, so this Silenus-mask entreasures things divine. He affects ignorance and susceptibility to beauty. Thus he mocks mankind. But he cares nothing for outward shows, and his temperance (*σωφροσύνη*) is wonderful." To prove this Alcibiades reveals his own heart-secret. (He is not ashamed to speak it amongst others who have felt the pang which Socrates inflicts.) And he makes it abundantly manifest that in their widely rumoured intercourse (cf. *Protag.* init.) Socrates had never cared for anything but what was best for his younger friend. Alcibiades then relates as an eyewitness the endurance shown by Socrates at Potidaea, his strange persistence in solitary meditation—standing absorbed in thought for a day and a night together—and his intrepid conduct in the retreat from Delium (cf. *Laches*). "The talk of Socrates is of pack-asses and

¹ Cf. *Theaet.* 184-186.

cobblers, and he is ever saying the same things in the same words; but one who lifts the mask and looks within will find that no other words have meaning." Alcibiades ends by warning his companions against the wiles of Socrates.

Some raillery follows, and they are invaded by another band of revellers, who compel them to drink still more deeply. The sobriety inclined (led by Eryximachus) slink off, and Aristodemus, the reporter of the scene, only remembers further that when he awoke at cock-crow Socrates was still conversing with Agathon and Aristophanes, and showing them that tragedy and comedy were essentially one. He talked them both asleep, and at daybreak went about his usual business.

The philosopher of the *Symposium* is in the world and yet not of it, apparently yielding but really overcoming. In the *Phaedo* the soul was exhorted to "live upon her servant's loss," as in Shakespeare's most religious sonnet; this dialogue tells of a "soul within sense" in the spirit of some more recent poetry. By force of imagination rather than of reason, the reconciliation of becoming (*γένεσις*) with being (*ὄντως*), of the temporal with the eternal, is anticipated. But through the bright haze of fancy and behind the mask of irony, Socrates still appears the same strong, pure, upright and beneficent human being as in the *Apology*, *Crito* and *Phaedo*.

The impressed contemplation of the beautiful is again imagined as the beginning of philosophy. But the "limitless ocean of beauty" is replaced by a world of supra-mundane forms, beheld by unembodied souls, and remembered here on earth through enthusiasm, proceeding by dialectic from multiform impressions to one rational conception, and distinguishing the "lines and veins" of truth. The *Phaedrus* records Plato's highest "hour of insight," when he willed the various tasks hereafter to be fulfilled. In it he soars to a pitch of contemplation from whence he takes a comprehensive and keen-eyed survey of the country to be explored, marking off the blind alleys and paths that lead astray, laying down the main roads and chief branches, and taking note of the erroneous wanderings of others. Reversing the vulgar adage, he flies that he may walk.

The transcendent aspiration of the *Phaedo* and the mystic glow of the *Symposium* are here combined with the notion of a scientific process. No longer asking, as in the *Protagoras*, Is virtue one or many? Plato rises to the conception of a scientific one and many, to be contemplated through dialectic—no barren abstraction, but a method of classification according to nature. This method is to be applied especially to psychology, not merely with a speculative, but also with a practical aim. For the "birth in beauty" of the *Symposium* is here developed into an art of education, of which the true rhetoric is but the means, and true statesmanship an accidental outcome.

Like all imaginative critics, Plato falls to some extent under the influence of that which he criticizes. The art of rhetoric which he so often travestied had a lasting effect upon his style. Readers of his latest works are often reminded of the mock grandiloquence of the *Phaedrus*. But in this dialogue the poetical side of his genius is at the height. Not only can he express or imitate anything, and produce any effect at will, but he is standing behind his creation and disposing it with the most perfect mastery, preserving unity amidst profuse variety, and giving harmony to a wildness bordering on the grotesque.

The person of Socrates is here deliberately modified. He no longer (as in the *Symposium*) teaches positive wisdom under the pretence of repeating what he has heard, but is himself caught by an exceptional inspiration, which is accounted for by the unusual circumstance of his finding himself in the country and alone with Phaedrus. He has been hitherto a stranger to the woods and fields, which would tempt him away from studying himself through intercourse with men. But by the promise of discourse—especially of talk with Phaedrus—he may be drawn anywhere.

Phaedrus has been charmed by a discourse of Lysias, which after some coy excuses he consents to read.

It is a frigid erotic diatribe, in which one not in love pleads for preference over the lover. Socrates hints at criticism, and is challenged to produce something better on the same theme.

1. Distinguishing desire from true opinion, he defines love as

desire prevailing against truth, and then expatiates on the harmful tendencies of love as so defined. But he becomes alarmed at his own unwonted eloquence, and is about to remove, when the "divine token" warns him that he must first recite a "palinode" in praise of love. For no divine power can be the cause of evil.

2. Love is madness; but there is a noble madness, as is shown by soothsayers (called *μάντις* from *μανθάνω*). And of the higher madness there are four kinds.

To explain this it is necessary to understand psychology. The soul is self-existent and self-moving, and therefore eternal. And her form is like a pair of winged steeds with their charioteer. In divine souls both steeds are good, but in human souls one of them is bad. Now before entering the body the soul lost her wings, which in her unembodied state were nourished by beauty, wisdom, goodness, and all that is divine. For at the festival of souls, in which they visit the heaven that is above the heavens, the unwarly steed caused the charioteer to see imperfectly. So the soul cast her feathers and fell down and passed into the human form. And, according to the comparative clearness or dimness of that first vision, her earthly lot is varied from that of a philosopher or artist down through nine grades (including woman) to that of a tyrant. On her conduct in this state of probation depends her condition when again born into the world. And only in ten thousand years can she return to her pristine state, except through a life of philosophy (cf. *Phaedo*) or of pure and noble love (cf. *Symposium*).

The mind of the philosopher alone has wings. He is ever being initiated into perfect mysteries, and his soul alone becomes complete. But the vulgar deem him mad and rebuke him; they do not see that he is inspired.

This divine madness (the fourth kind of those above mentioned) is kindled through the renewed vision of beauty. For wisdom is not seen; her loveliness would have been transporting if she had a visible form. The struggle of the higher passion with the lower is then described with extraordinary vividness, under the image of the two steeds. When the higher impulse triumphs the soul is a philosophic friendship, at once passionate and absolutely pure.

3. From his "palinode" Socrates returns to Lysias, who is advised to leave speech-writing for philosophy.

a. Phaedrus remarks that the speech-writer is despised by the politician. Socrates replies that speech-writing and politics are one concern. The real difference is between those who base their teaching on philosophy and those who are content with rules of art. For example, if the first speech of Socrates is compared with that of Lysias, the one is found to distinguish and define, the other not; the one observes order in discourse, the other "begins when he should end," and his utterance is like a disordered chain. A speech should be an organic whole, a "creature having hands and feet." So in the "palinode" there was a classification of the kinds of madness, which led the way to "a possibly true though partly erring myth." This approximation to truth in the midst of such that was playful was due to the observance of two principles, generalization and division (*γενεσις καὶ διαίρεσις*). Whoever sees the one and many in nature, him Socrates follows and walks in his footsteps, as if he were a god. In comparison of dialectic, as he conceived, the frigid rules of Lysias, Thrasymachus, Theodorus, Evemus, Tisias, Gorgias, Polus and Protagoras are futile and absurd.

b. Another condition of teaching (or true rhetoric) is the extent of mind. Whether the soul be one or many, complex or multiform, and if multiform what are its parts and kinds, are questions which the teacher must have already solved. And he must likewise have classified all arguments and know them in their various applicability to divers souls. An art of speaking that should fulfil this condition is non-existent. Yet how can even verisimilitude be attained without knowledge of truth?

c. The art of writing is kindred to the art of speech. But Socrates maintains that oral teaching through the living contact of mind with mind has many advantages over written composition, which is, comparatively speaking, a dead thing. Men may write for amusement or to record the intercourse that has been. But the serious occupation of the true thinker and teacher is the communication of truth through vital converse with others like-minded—the creation of "thoughts that breathe" in spirits conscious of their value.

In conclusion, a friendly hint is given to Isocrates that he may do better than Lysias if he will but turn his attention to philosophy.

The *Phaedrus* anticipates much that Plato afterwards slowly elaborated, and retains some things which he at last eliminated. (1) The presence of movement or impulse in the highest region is an aspect of truth which reappears in the *Sophistes* and other later dialogues. It has been thought strange that it should be found so early as in the *Phaedrus*. But does not this remark imply an unwarrantable assumption, viz. that Plato's idealism took its departure from the being of Parmenides? Is it not rather the fact that his own theory was formulated before the Megarian ascendancy led him to examine the Eleatic doctrine, and that it was by a tendency from the first inherent in Platonism that that doctrine was modified in his final teaching? (2) The

outlines of method which are thrown out at white heat in the *Phaedrus* are a preparation for the more sober treatment of the ideas in the dialectical dialogues. In these, however, the conception of classification is somewhat altered through contact with Eleaticism. (3) The *Phaedrus* aims, not merely at realizing universals, but at grasping them in and through particulars. This is an ideal of knowledge which was "lost as soon as seen," but one which in some of his latest dialogues, such as the *Politics* and *Philebus*, Plato again endeavoured to work out. (4) The *Phaedrus* contains the elements of that true psychology into which the ontological theory of the ideas is gradually transmuted in Plato's more advanced writings, when the difficulties of his ideal doctrine in its cruder forms have been clearly felt and understood. (5) Plato here appears as a professor of education preferring oral intercourse to authorship. In this paradox he at once exalts the work of Socrates and avows his own vocation as a teacher. The passage throws an interesting light upon the form of dialogue in which his works are cast. But it is not to be supposed that he remained long unconscious of the influence he was destined to wield by writing. In executing a great task like the *Republic*, he practically diverged from the untenable view asserted here; and in the *Laws* he recommends his longest and least dramatic work as a suitable basis for the education of the future. (6) It must always appear strange, even to those most familiar with the conditions of Hellenic life, that in portraying the idealizing power of passionate love Plato should have taken his departure from unnatural feeling.

On this subject he has sung his own "palinode" in the *Laws*, which he intended as his final legacy to mankind.¹ Not that he ceased to exalt genius and originality above mere talent, or to demand for philosophy the service of the heart as well as the head, nor yet that friendship was less valued by him in later years. All this remained unchanged. And in the *Republic* the passion of love is still distantly referred to as the symbol of ideal aspiration. But a time came when he had learned to frown on the aberration of feeling which in the *Symposium* and *Phaedrus* he appears to regard as the legitimate stimulus of intellectual enthusiasm. And already in the *Theaetetus* not love but wonder is described as the only beginning of philosophy.

While calling attention to this change of sentiment, it is right to add that Platonic love in the "erotic" dialogues of Plato is very different from what has often been so named, and that nothing even in the noble passage of the *Laws* above referred to casts the slightest shadow of blame on the Socrates of the *Symposium*. Such changes are, amongst other things, a ground for caution in comparing the two steeds of the *Phaedrus* with the spirit (*θυμὸς*) and desire (*ἐπιθυμία*) of the *Republic* and *Timaeus*. The *Phaedrus*, in common with these dialogues, asserts the existence of higher and lower impulses in human nature, but there is no sufficient ground for supposing that when Plato wrote the *Phaedrus* he would have defined them precisely as they are defined in the *Republic*.

The *Cratylus* is full of curious interest as marking the highest point reached by the "science of language" in antiquity, but, as this dialogue "hardly derives any light from *Cratylus*," Plato's other writings,² so neither does it reflect much light on them. It deals slightly with the contrast between Heracliteanism and Eleaticism, the importance of dialectic, the difficulty about the existence of falsehood, and ends with a brief allusion to the doctrine of ideas—but these topics are all more fully discussed elsewhere.

Three persons maintain different views respecting the nature and origin of language.

Hermogenes affirms that language is conventional, Cratylus (the Heraclitean) that it is natural. Socrates, mediating between these sophistical extremes, declares that language, like other institutions, is rational, and therefore (1) is based on nature, but (2) modified by convention.

In his dialectical treatment of the subject, Socrates displays a fustian of wild etymologies in reliance on the "inspiration" of Euthyphro. Presently a distinction appears between primary and

secondary words. Many primary words convey the notion of movement and change. It follows that the legislator or word-maker held Heraclitean views. Socrates thus far presses on Hermogenes the view of Cratylus. Then turning to Cratylus he asks if there are no false names. "False language," Cratylus argues, "is impossible." Socrates shows that a true image may be inadequate, so that we have a right to criticize the work of the word-maker. And the facts indicate an element of meaningless convention. Nor was the original word-maker consistently Heraclitean. For some important words point not to motion but to rest.

But the question returns—Are we sure that the theory of nature which the word-maker held was true? This difficulty cannot be touched by verbal arguments. In seeking to resolve it we must consider, not words, but things. If there is a true beauty and a true good, which are immutable, and if these are accessible to knowledge, that world of truth can have nothing to do with flux and change.

V *Gorgias, Republic*.—In the *Symposium* and *Phaedrus* Plato largely redeems the promise implied in the *Phaedo*, where Socrates tells his friends to look among themselves for a charmer who may soothe away the fear of death. But he was pledged also to a sterner duty by the warning of Socrates to the Athenians, in the *Apology*, that after he was gone there would arise others for their reproof more harsh than he had been. To this graver task, which he had but partially fulfilled with the light satire upon Lysias and the gentle message to Isocrates, the philosopher now directs his powers, by holding up the mirror of what ought to be against what is, the principles of truth and right against the practice of men. For the good has more than one aspect. The beautiful or noble when realized in action becomes the just. And to the question, What is just? are closely allied those other questions of Socrates—What is a state? What is it to be a statesman?

In the *Gorgias* Plato asserts the absolute supremacy of justice through the dramatic portraiture of Socrates in his opposition to the world; in the *Republic* he strives at greater length to define the nature of justice through the imaginary creation of an ideal community.

In the *Gorgias* the Platonic Socrates appears in direct antagonism with the Athenian world. The shadow of his fate is impending. Chærephon (who is still alive) understands *Gorgias*, him, but to the other interlocutors, Gorgias, Polus, Callicles, he appears perversely paradoxical. Yet he effectively dominates them all. And to the reader of the dialogue this usage of "Socrates contra mundum" is hardly less impressive than that other image of Socrates confronting death.

r. Gorgias asserts that rhetoric is an art concerned with justice, and that persuasion is the secret of power.

a. Socrates, after suggesting some ironical doubts, declares his opinion that rhetoric is no art, but a knack of pleasing, or in other words "the counterfeit of a subsection of statesmanship." This oracular definition rouses the interest of Gorgias, and Socrates proceeds with the following "generalization and division":—

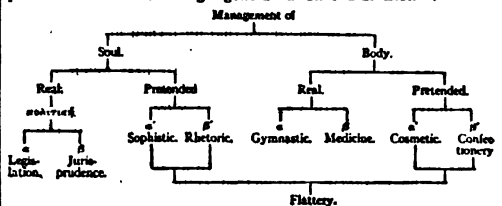

Flattery influences men through pleasure without knowledge. And the rhetor is a kind of confectioner, who can with difficulty be distinguished from the sophist.

b Rhetoric, then, is not an art. And persuasion is not the secret of power. Here Socrates maintains against Polus the three paradoxes:—

The tyrant does what he chooses but not what he wishes;
It is less evil to suffer wrong than to do wrong;

It is better for the wrongdoer to be punished than to escape punishment.

The only use of rhetoric, therefore, is for self-accusation, and (if it is ever permissible to do harm) to prevent the punishment of one's enemy.

c Callicles here loses patience and breaks in. He propounds his theory, which is based on the opposition of nature and custom.

¹ *Laws* viii. 836.

² Jowett—who has, notwithstanding, thrown much light on the *Cratylus* in his brilliant introduction.

"There is no natural right but the right of the stronger. And natural nobility is to have strong passions and power to gratify them. The lawful

is a word that cowards use,
Devised at first to keep the strong in awe."

Socrates entangles him in an argument in which it is proved that pleasure is different from good, and that there are good and bad pleasures.

Now the question is whether the life of philosophy, or the life which Callicles defends, is conducive to good. And it has been shown that rhetoric is one of a class of pursuits which minister to pleasure without discriminating what is good.

Callicles again becomes impatient. Did not Themistocles, Cimon, Pericles labour for their country's good? Socrates then renews his demonstration, proving that if the just man is wronged the evil lies with the wrongdoer, not with him, and that it is worst for the wrongdoer if he escape. And for avoidance of this greatest evil not rhetoric avails anything, nor any of the arts which save life (seeing that life may be used well or ill), nor even such an art of politics as Themistocles, Cimon, or Pericles knew, but another science of politics which Socrates alone of the Athenians practises. The pursuit of it may well endanger him; but his strength lies in having done no wrong. For in the world to come he can present his soul faultless before her judge. Not the show of justice but the reality will avail him there.

This truth is enforced by an impressive myth. And Callicles is invited to leave the life which relies on rhetoric and to follow Socrates in practising the life of philosophic virtue.

The value of justice has been shown. But what is justice? Is the life upheld by Socrates sufficiently definite for practical guidance? The views of Callicles have been overborne; but have they been thoroughly examined? Socrates claims to be the only politician. But how can that deserve the name of policy which results in doing nothing? These and cognate questions may well have haunted Plato when he planned the *Republic*, the greatest of his works. For that which lay deepest in him was not mere speculative interest or poetic fervour, but the practical enthusiasm of a reformer. The example of Socrates had fired him with an ideal of wisdom, courage, temperance and righteousness, which under various guises, both abstract and concrete, has appeared and reappeared in the preceding dialogues. But the more vividly he conceived of this ideal life, the more keenly he felt its isolation in the present world—that of the restored Athenian democracy. For to a Greek mind above all others life was nothing without the social environment, and justice, of all virtues, could least be realized apart from a community. Hence it became necessary to imagine a form of society in which the ideal man might find himself at home, a state to which the philosopher might stand in harmonious relationship, no longer as an alien sojourner, but as a native citizen, not standing aloof in lonely contemplation, but acting with the full consent of other men and ruling in the right of wisdom. Plato did not regard his own republic as a barren dream. He believed that sooner or later in the course of time a state essentially resembling his ideal commonwealth would come into being. Still more firmly was he convinced that until then mankind would not attain their highest possible development. To ignore this real aspect of his most serious work is to lose much of the author's meaning. Yet it is hardly less erroneous to interpret a great imaginative creation *au pied de la lettre*, as if examining a piece of actual legislation. Even in his *Laws*, a far more prosaic writing, Plato himself repeatedly protests against such criticism. In his most aspiring flights he is well aware of the difference between the imaginary and actual embodiment of an ideal, although as a literary artist he gives to his creations, whether in anticipation or retrospect, an air of sober reality and matter-of-fact. He is more in earnest about principles than about details, and if questioned would probably be found more confident with regard to moral than to political truth. He may have been wholly unconscious of the inconsistencies of his scheme, but it would not have greatly disconcerted him to have discovered them, or to have been told that this or that arrangement would not "work." He would have trusted the correction of his own rough draft to the philosopher-kings of the future.

The *Republic* falls naturally into five portions. (1) Bk. I. is preliminary, raising the main question about justice. (2) Bks. II.,

III., IV. contain the outlines of the perfect state, including the education of the "guardians," and leading up to the definition of justice (a) in the state, and (b) in the individual. (3) Bks. V., VI., VII. (which to some critics present the appearance of an afterthought or excrescence on the original design) contain the cardinal provisions (1) of communism (for the guardians only), (2) that philosophers shall be kings, (3) of higher education for the rulers (viz. the philosopher-kings). This third provision occupies Bks. VI. and VII. (which have again, as some think, the appearance of an outgrowth from bk. V.). (4) Bks. VIII. and IX., resuming the general subject from bk. IV., present the reverse of the medal by showing the declension of the state and individual through four stages, until in the life of tyranny is found the image of ideal injustice, as that of justice was found in the life of the perfect state. (5) Bk. X. forms a concluding chapter, in which several of the foregoing enactments are reviewed, and the work ends, like the *Gorgias*, with a vision of judgment.

Thus the main outlines of the scheme are contained in Bks. I., III., IV., VIII., IX. And yet Bks. V., VI., VII. form the central portion, a sort of inner kernel, and are of the highest significance.

In speculating about the composition of the *Republic* (as is the fashion of some interpreters) it is important to bear in mind the general character of Plato's writings.

"The conception of unity," says Jowett,² "really applies in a very different degree to different kinds of art—to a statue, for example, far more than to any kind of literary composition, and to some species of literature far more than to others. Nor does the dialogue appear to be a style of composition in which the requirement of unity is most stringent; nor should the idea of unity derived from one sort of art be hastily transferred to another. . . . Plato subjects himself to no rule of this sort. Like every great artist he gives unity of form to the different and apparently distracting topics which he brings together. He works freely, and is not supposed to have arranged every part of the dialogue before he begins to write. He fastens or weaves together the frame of his discourse loosely and imperfectly, and which is the warp and which the woof cannot always be determined."

It should be added, that as Dialectic was still a "world not realized," and he was continually conscious of using imperfect methods, he was not solicitous to bind himself to any one method, or to watch carefully over the logical coherence of his work. "Sailing with the wind of his argument," he often tacks and veers, changing his method with his subject-matter, much as a poet might adopt a change of rhythm. Absorbed as he is in each new phase of his subject, all that precedes is cancelled for the time. And much of what is to come is deliberately kept out of view, because ideas of high importance are reserved for the place where their introduction will have most effect. Another cause of apparent inconsequence in Plato is what he himself would call the use of hypothesis. He works less deductively and more from masses of generalized experience than Platonists have been ready to admit. And in the *Republic* he is as much engaged with the criticism of an actual as with the projection of an ideal condition of society. If we knew more of the working of Attic institutions as he observed them, we should often understand him better.

These general considerations should be weighed against the inequalities which have led some critics to suppose that the "first sketch of the state" in Bks. II.-IV. is much earlier than the more exalted views of Bks. V.-VII.³ If in these later books new conditions for choosing the future rulers are allowed to emerge, as in discussing the higher intellectual virtues the simple psychology of bk. IV. is lost sight of (it reappears in the *Timæus*), if the "knowledge of the expedient" at first required falls far short of the conception of knowledge afterwards attained, all this is quite in keeping with Plato's manner elsewhere, and may be sufficiently accounted for by artistic and dialectical reserve. It can hardly be an altogether fortuitous circumstance that the culminating crisis, the third and highest "wave" of difficulty—the declaration that philosophers must be kings and king-philosophers—comes in precisely at the central point of the whole long work.

The great principle of the political supremacy of mind, though thus held back through half the dialogue, really dominates the whole. It may be read between the lines all through, even in the institution of gymnastic and the appraisal of the cardinal

¹ Introd. to the *Phædrus*.

² Krohn, *Der platonische Staat* (Halle, 1876).

³ See especially *Rep.* v. 473; *Legg.* v. 746.

virtues. It is a genuine development of Socratic thought. And it is this more than any other single feature which gives the *Republic* a prophetic significance as "an attempt towards anticipating the work of future generations."¹

Other aspects of the great dialogue, the Dorian framework, so inevitable in the reaction from Ionian life, the traces of Pythagorean influence, the estimate of oligarchy and democracy, the characters of the interlocutors in their bearing on the exposition, have been fully treated by recent writers, and for brevity's sake are here passed over.

There are other points, however, which must not be omitted, because they are more intimately related to the general development of Plato's thoughts.

1. The question debated by Proclus has been raised before and since, whether the proper subject of the *Republic* is justice or the state. The doubt would be more suggestive if put in a somewhat different form: Is Plato more interested in the state or the individual? That he is in earnest about both, and that in his view of them they are inseparable, is an obvious answer. And it is almost a truism to say that political relations were prior to ethical in the mind of a Greek. Yet if in some passages the political analogy reacts on moral notions (as in the definition of temperance), in others the state is spoken of in language borrowed from individual life. And it remains questionable whether the ethics or the politics of the *Republic* are less complete. On the whole Plato himself seems to be conscious that the ideal derived from the life-work of Socrates could be more readily stamped on individual lives than on communities of men (see especially *Rep.* vii. 528 A, ix. 592).

2. The analogy of the individual is often used to enforce the requirement of political unity and simplicity (see especially v. 465 C). This is also to be referred, however, to Plato's general tendency to strain after abstractions. He had not yet reached a point of view from which he could look steadily on particulars in the light of universal principles. He recurs often to experience, but is soon carried off again into the abstract region which to him seemed higher and purer.² It has been said that Plato flies as well as walks, but this hardly expresses the whole truth, for he flies and walks at the same time, and is in the air and on firm ground in successive instants" (Jowett). Plato's scheme of communism had been suggested to him partly by Dorian institutions and partly by the Pythagorean rule. But it was further commended by the general consideration that the state is a higher and more abstract unity than the family. The lower obligation must give way to the higher, the universal must overrule the particular bond.

3. Similarly it may be argued that, while the subordination of music to state discipline, and the importance attached to rhythm and harmony in education, had likewise a connexion with Sparta and the Pythagoreans severally, Plato's deliberate attitude towards poetry and art could hardly be other than it is. Philosophy, while still engaged in generalization, could not assign to the imagination its proper function. "Aesthetic" could not enter into her purview. For a moment, in the *Symposium*, the ancient quarrel of poetry and philosophy had seemed to be melted in a dominant tone, but this was only a fond anticipation. Plato, if man ever did so, had felt the siren charm, but he is now embarked on a more severe endeavour, and, until the supreme unity of truth and good is grasped, vagrant fancy must be subdued and silent.

4. In the early education of the guardians a place is found for the unconscious virtues acquired through habit, which the *Protagoras* and *Meno* stumbled over and the *Phaedo* treated with disdain. In the ideal state, however, this lower excellence is no longer a wild plant, springing of itself through some uncovenanted grace of inspiration, but cultivated through an education which has been purified by philosophy so as to be in harmony with reason. But if Plato were cross-questioned as to the intrinsic value of habits so induced as a preservative for his pupils against temptation, he would have replied, "I do not pretend to have removed all difficulties from their path. Enough of evil still surrounds them to test their moral strength. I have but cleared the well-springs of the noxious weeds that have been fatal to so many, in order that they may have little to unlearn, and be exposed only to such dangers as are inevitable."

5. It is a singular fact, and worth the attention of those who look for system in Plato, that the definition of justice here so laboriously wrought out, viz. the right division of labour between the three classes in the state and between the three corresponding faculties in the individual soul, is nowhere else repeated or applied, although the tripartite division of the soul recurs in the *Timaeus*, and the notion of justice is of great importance to the arguments of the *Politics* and the *Laws*.

6. Before leaving the *Republic*, it is important to mark the stage which has now been reached by Plato's doctrine of ideas. The statements of the *Republic* on this subject are by no means everywhere consistent.

¹ Grote.

² See, for example, the admission of luxury and the after-purification through "music," bk. ii. iii.

a. Towards the end of bk. v. philosophers are defined as lovers of the whole, who recognize the unity of justice, goodness, beauty, each in itself, as distinguished from the many just or good or beautiful things. The former are said to be objects of knowledge, the latter of opinion, which is intermediate between knowledge and ignorance. Knowledge is of being, ignorance of the non-existent, opinion of that which is and is not.

b. In bk. vi. there is a more elaborate statement, implying a more advanced point of view. The "contemplation of all time and all existence" is a riper conception than "the love of each thing as a whole." Ignorance and nonentity have now disappeared, and the soul is graduated from the most evanescent impression of sense to the highest reach of absolute knowledge. And in the highest region there is again a gradation, rising to the form of good, and descending from it to the true forms of all things. In the application of this scheme to the theory of education in bk. vii. there are still further refinements. The psychological analysis becomes more subtle, and more stress is laid on the connexion of ideas.

c. The doctrine reverts to a cruder aspect in bk. x., where we are told of an ideal bed, which is one only and the pattern of all the many actual beds.

d. A yet different phase of Idealism presents itself in bk. ix. (*sub fin.*), in the mention of a "pattern" of the perfect state laid up in heaven which the philosopher is to make his rule of life.

What is said above concerning Plato's mode of composition has some bearing on these inconsistencies of expression. And that bks. vi., vii., as being the most important, were finished last is a not untenable hypothesis. But that Plato, in preparing the way for what he had in contemplation, should content himself with provisional expressions which he had himself outgrown, or that in a casual illustration (as in bk. x.) he should go back to a crude or even childish form of his own theory, is equally conceivable and in accordance with his manner elsewhere. Socrates in the *Parmenides* confessedly wavers on this very point. And there are "ideas" of the four elements in the *Timaeus*.

VI. *Euthydemus, Parmenides, Theaetetus, Sophist, Statesman, Philebus* (the dialectical dialogues).—Even in the most advanced metaphysics of the *Republic* there is a hyperbolic, transcendental tendency, from which Plato ultimately to some extent worked himself free. But it was not in conversation with "dear Glaucon," or "between the lines" of an ethico-political writing, that this partial emancipation could be effectually attained. We have now to consider a series of dialogues, probably intended for a narrower circle of readers, in which Plato grapples directly with the central difficulties of his own theory of knowing and being. It is not necessary to assume that all of these are later than the *Republic*. The position of the *Euthydemus* and *Parmenides* in the order of composition is very uncertain. The *Theaetetus* has points of affinity with the *Republic*. The *Sophist, Politicus* and *Philebus* are in a later style. But, on account of their cognate subject-matter, these six dialogues may be conveniently classed together in a group by themselves. And the right place for such a group is intermediate between the *Republic* and the *Laws*.

The unity of the object of definition, the identity of virtue and knowledge, the existence of an absolute good, which would be universally followed if universally known, and of a standard of truth which is implied in the confession of ignorance, were postulates underlying the Socratic process, which in so far made no claim to be a "philosophy without assumptions." These postulates, when once apprehended, drew Plato on to speculate concerning the nature, the object and the method of knowledge. Now, so far as we have hitherto followed him, his speculation has either been associated with ethical inquiry, or has been projected in a poetical and semi-mythical form. In the *Phaedrus* however, the vision of ideas was expressly conjoined with an outline of psychology and a foreshadowing of scientific method. And, while the opposition of ideas to phenomena and of knowledge to opinion has been repeatedly assumed, it has also been implied that there is a way between them, and that the truth can only be approached by man through interrogation of experience. For it is nowhere supposed that the human inquirer is from the first in a position to deduce facts from ideas. Much rather, the light of the ideas is one which fitfully breaks in upon experience as men struggle towards the universal.

But it is not less true that the metaphysical aspirations from which Socrates had seemed to recall men's thoughts had been reawakened in consequence of the impulse which Socrates

himself had given. From asking, Is virtue one? Can virtue be taught? Plato passes on to ask, What is unity? What are knowledge and being? From criticizing imperfect modes of teaching virtue, he has begun to speculate about the right and wrong uses of the intellect, and from dramatic portraits of the individual Protagoras or Gorgias goes on to the ideal delineation of the sophist. He has entered upon the "longer way," and is no longer contented with mere "hypotheses." With this demand for scientific precision his conception of the ideas themselves is modified, and he strives anew to conceive of them in relation to one another, to the mind, and to the world. As the balance of ethical truth was restored by admitting an unconscious (or inspired) conformity to reason, so now a fresh attempt is made on the intellectual side to bridge the gulf between sense and knowledge.

This endeavour involves, not only an expansion of the method of Socrates, but an examination of the earlier philosophies from which Socrates had turned away. Their influence on Plato has been traceable in the preceding dialogues, though, except in the case of Pythagoreanism (*Gorg.*, *Phaed.*, *Rep.*) it has been mostly indirect and casual. But in these dialectical dialogues he manifests his serious conviction that the contemporary fallacies which formed the chief hindrance to inquiry were deeply rooted in forms of thought created by earlier thinkers, above all by Heraclitus and Parmenides. To the exclusiveness of their first principles as held by their followers Plato attributed the barrenness and impracticable unreality of many discussions, which put shadow-fighting and controversy in the place of real investigation, and led men to think that truth was unattainable. He therefore enters into conversation, as it were, with the great minds of former times, and in the spirit of Socrates compels each of them to yield up his secret, and to acknowledge a supplemental truth. To this effort he may very probably have been stimulated by the dialectical activity of his Socratic friends at Megara, whose logical tastes had drawn them towards Eleaticism. But, unlike them, while strengthening his metaphysical theory, he was also led to give to his political speculations a more practical turn.

The *Euthydemus* is a treatise "De Sophisticis Elenchis" in the form of a farce, and may serve to introduce the five other *Euthydemus* dialogues, as the encounter with Thrasymachus introduces the serious part of the *Republic*. Under the mask of mockery there is more of concentrated thought, and also more of bitterness, in this dialogue than in the *Protagoras* or the *Gorgias*.

A sample of educational dialectic—in which Socrates draws out of young Cleinias the admissions (1) that a philosophy is needed, (2) that the highest philosophy is a science of kingcraft, which remains for the present undefined—is contrasted with a series of ridiculous sophisms, propounded by Dionysodorus and his brother Euthydemus, in which absolute and relative notions; whether affirmative or negative, object and subject, universal and particular, substance and attribute, action and modality, are capriciously confused. Crito, to whom Socrates narrates the scene, is moved to contempt. But Socrates warns him not on this account to despair of philosophy. In conclusion, Isocrates, or some one else, who prematurely mixes up philosophy with practical politics, is cautioned against spoiling two good things.

Such puzzles as—How can I learn either what I know or what I do not know? How can things become what they are not? How is falsehood or denial possible?—although treated jocularly here, will be found returning afterwards to "trouble the mind's eye."

Plato appears in the same act to have become aware of his affinity with Parmenides, and to have been led to reconsider the *Parmenides* foundations of his own doctrine. The one being of Parmenides was a more abstract notion than justice, beauty or the good. And the Zenonian method had more pretension to exactness than the Socratic. But it remained barren, because contented to repeat its own first essays in the destructive analysis of experience, without rising to the

examination of its own first principles. For this higher criticism, of which he himself also stood in need, Plato looks up from the disciples to the master Parmenides. The appeal to him is put into the mouth of Socrates, as a very young man, who has framed for himself a theory of ideas, and would gladly see the Zenonian process applied to the notions of sameness, difference, likeness, unlikeness, unity and being.

Parmenides, whom Plato treats with tender reverence not unmixed with irony, proposes to the youth a series of questions which reveal the crudity of the doctrine of *éἶδη*. (1) Are there ideas of trivial things? (2) How do things "partake" of them? (3) Must not idealism proceed in *infinitum*? (4) If ideas are thoughts, do they and their participants think? (5) If they are patterns, and things resemble them, must there not be a pattern of the resemblance, and so on in *infinitum*? (6) If absolute, are they thinkable by man?

These difficulties are real, and yet to deny ideas is to destroy philosophy. (As the paradoxical doubts in the *Protagoras* do not shake the faith of Socrates in the existence of good, so neither does Plato here intend for a moment to derogate from the belief in the existence of the One and the True.)

Parmenides advises Socrates to arm himself for the further pursuit of truth (1) by the higher application and (2) by the extension or completion of the Zenonian method. (1) The method is to be applied to abstractions. (2) It is not enough to show the inferences which may be drawn from the admission of an hypothesis, but account must also be taken of the inferences which follow from its rejection.

Parmenides exemplifies his suggestion by examining his own first principle in conversation with a youth who, while a contemporary of Socrates, is a namesake of Plato's pupil Aristotle.³ Not content with the affirmative and negative hypotheses, he pursues each along two lines, according as either term of the proposition is emphasized, and this not only as regards the hypothesis of unity, but also as applied to the alternative hypothesis of plurality. The result, as in the *Protagoras*, is purely destructive, and the dialogue ends abruptly without a word of reply from Socrates.

The second part of the *Parmenides* may be regarded as an experiment in which Plato "assays to go" in Eleatic armor. Yet the strange web is "shot" with colours of original thought. The mode of conceiving time and becoming, and the vision of nothingness towards the end, may be noted as especially Platonic. These passages may be regarded in the same light as the wise words of Protagoras or the sober truths which occur amidst the wild fancies of the *Cratylus*. They should not mislead the interpreter into a search for recondite meanings.

The Zenonian method has been carried out to the utmost in application to the highest subject, and has led the mind into a maze of contradiction. It remains to call in question *ἴδιον* the method itself, and the notion of absolute identity and difference on which it hinges, and so to lay anew the foundation-stone of thought. Before this can be attempted, however, another set of difficulties have to be met, and another set of philosophers examined. For the current scepticism had undermined the conception of knowledge as well as that of being, and the fame of Heraclitus was hardly second to that of Parmenides: Protagoras appeared in a former dialogue as the champion of ordinary morality; he is now made the exponent of ordinary thinking. His saying "Man the measure" is shown to rest on the unstable basis of the Heraclitean flux. By an elaborate criticism of both theories knowledge is at last separated from the relativity of sense; but the subsequent attempt to distinguish on abstract grounds between true and false opinion, and to define knowledge as true opinion with a reason (*cf. Meno*), proves ineffectual. Plato still shows traces of Megarian influence. But the disjunctive method of the *Parmenides* is not resumed. The indirect proofs are so arranged as to exhibit the skill of Socrates in "bringing to the birth" the genes of thought in a richly endowed and "pregnant" young mind. Theaetetus is the embodiment of the philosophic nature described in *Rep.* bk. vi., and has already been trained by Theodorus of Cyrene in geometry and the other preparatory sciences of

³ *Cf. Rep.* x. 597.

⁴ *Cf.* the younger Socrates of the *Politics*. It would be precarious to draw any inference from this minute fact.

¹ *Cf. Meno.*

Rep. bk. vii. It is in conversation with Theodorus that Socrates impressively contrasts the lives of the lawyer and the philosopher. The *Theaetetus* marks a great advance in clearness of metaphysical and psychological expression. See for example the passage (184-186) in which the independent function of the mind is asserted, and ideas are shown to be the truth of experience. There is also a distinct approach towards a critical and historical method in philosophy, while the perfection of style continues unimpaired, and the person of Socrates is as vividly represented as in any dialogue.

Notwithstanding the persistence of an indirect and negative method, the spirit of this dialogue also is the reverse of sceptical. "Socrates must assume the reality of knowledge or deny himself" (197 A). Perhaps in no metaphysical writing is the balance more firmly held between experience, imagination and reflection. Plato would seem to have made a compact with himself to abstain rigidly from snatching at the golden fruit that has so often eluded his grasp, and to content himself with laboriously "cutting steps" towards the summit that was still unlaboured.

With Plato, as with other inventive writers, a time seems to have arrived when he desired to connect successive works in a series. Thus in planning the *Sophistes* he linked it to the *Theaetetus* (which had been written without any such intention), and projected a whole tetralogy of dialectical dialogues, *Theaetetus*, *Sophistes*, *Politicus*, *Philosophus*, of which the last piece seems never to have been written.

After an interval, of which our only measure is a change of style, the philosopher returns to the great central question of knowledge and being. The obstacle in his path, on which he has often played with light satire, dramatic portraiture and indirect allusion, is now to be made the object of a seriously planned attack. He has made his approaches, and the enemy's fortress is to be forthwith sapped and overthrown. This hostile position is not merely the "Sophistik" which, as some tell us, is an invention of the Germans, and as Plato himself declares is only the reflection or embodiment of the average mind,¹ but the fallacy of fallacies, the prime falsehood (*πρώτον ψεύδος*) of all contemporary thought. This is nothing else than the crude absoluteness of affirmation and negation which was ridiculed in the *Euthydemus*, and has been elsewhere mentioned as the first principle of the art of controversy.² For dramatic purposes this general error is personified. And the word "sophist," which had somehow become the *bête noire* of the Platonic school, thus for the first time fixedly acquires the significance which has since clung to the name. That Plato himself would not adhere pedantically to the connotation here implied is shown by the admission, at the opening of the dialogue, that amongst other disguises under which the philosopher walks the earth the sophist is one.

In the *Sophistes*, as in the *Parmenides*, a new method is introduced, and again by an Eleatic teacher. This method is repeated with improvements in the *Politicus*, and once more referred to in the *Philebus*. It bears a strong resemblance to the "synagogē" and "dieresis" of the *Phaedrus*, but is applied by the "friend from Elea" with a degree of pedantry which Socrates nowhere betrays. And the two methods, although kindred, have probably come through different channels—the classifications of the *Phaedrus* being Plato's own generalization of the Socratic process, while the dichotomies of the *Sophistes* and *Politicus* are a caricature of Socrates cast in the Megarian mould. Plato seems to have regarded this method as an implement which might be used with advantage only when the cardinal principles on which it turned had been fully criticized.

1. After various attempts to "catch the sophist," he is defined as the maker of an unreal likeness of truth. Here the difficulty begins—for the definition implies the existence of the unreal, i.e. of not-being. In our extremity it is necessary to "lay hands on our father Parmenides."

2. The contradictions attendant on the notion of "being," whether as held by Parmenides or his opponents or by the "less exact" thinkers who came after them, are then examined, and in an extremely subtle and suggestive passage (246-249) an attempt

is made to mediate between idealism and materialism. The result is that while consummate being is exempt from change it cannot be devoid of life and motion. "Like children, 'Give us both,' say we."

3. This leads up to the main question (a) are different notions incommunicable, or (b) are all ideas indiscriminately communicable, or (c) is there communion of some kinds and not of others? The last view is alone tenable, and is confirmed by experience. And of the true combination and separation of kinds the philosopher is judge.

4. Then it is asked (in order to "bind the sophist") whether being is predicable of not-being.

Five chief kinds (or categories) are now examined, viz. being, rest, motion, sameness, difference. Rest and motion are mutually incommunicable, but difference is so less universal than being itself. For everything is "other" than the rest, i.e. is not. Thus positive and negative not only coexist but are coextensive.

5. And, in spite of Parmenides, we have discovered the existence, and also the nature, of not-being. It follows that the mere pursuit of contradictions is childish and useless and wholly incompatible with a philosophic spirit.

Negation, falsity, contradiction, are three notions which Plato from his height of abstraction does not hold apart. His position is the converse of the Spinozistic saying, "Omnis determinatio est negatio." According to him, every negative implies an affirmative. And his main point is that true negation is correlative to true affirmation, much as he has said in the *Phaedrus* that the dialectician separates kinds according to the "lines and veins of nature." The *Sophistes* is a standing protest against the error of marring the finely-graduated lineaments of truth, and so destroying the vitality of thought.

The idealists whom the Eleatic stranger treats so gently have been identified with the Megarians. But may not Plato be reflecting on a Megarian influence operating within the Academy?

Here, as partly already in the *Parmenides* and *Theaetetus*, the ideas assume the nature of categories, and being is the sum of positive attributes, while negation, as the shadow of affirmation, is likewise finally comprehended in the totality of being.

The remark made incidentally, but with intense emphasis, that the universe lives and moves "according to God,"¹ is an indication of the religious tone which reappears increasingly in the *Politicus*, *Philebus*, *Timaeus* and *Laws*.

In passing on to consider the statesman, true and false, the Eleatic stranger does not forget the lesson which has just been learned. While continuing his method of dichotomies, he is careful to look on both sides of each alternative, and he no longer insists on dividing between this and not-this when another mode of classification is more natural. A rule not hitherto applied is now brought forward, the rule of proportion or right measure (*τὸ μέτρον*), as distinguished from arbitrary limitations. Nor is formal logical treatment any longer felt to be adequate to the subject in hand, but an elaborate myth is introduced. On the ethico-political side also a change has come over Plato. As he has stripped his ideas of transcendental imagery, so in reconsidering his philosopher-king he turns away from the smiling optimism of the *Republic* and looks for a scientific statesmanship that shall lay a strong grasp upon the actual world. He also feels more bitterly towards the demagogues and other rulers of Hellas. The author of the *Politicus* must have had some great quarrel with mankind. But so far as they will receive it he is still intent on doing them good.

1. The king is first defined as a herdsman of men, who as "slow bipeds" are distinguished from the pig and the ape. But the king is not all in all to his charges, as the herdsman is. The above definition confuses human with divine rule.

2. Now the universe is like a top, which God first winds in one direction and then leaves to spin the other way. In the former or divine cycle all was spontaneous, and mankind who had all things in common, were under the immediate care of gods. They were happy, if they used their leisure in interrogating nature. But in this reign of Zeus it is far otherwise. Men have to order their own ways and try to imitate in some far-off manner the all-but forgotten divine rule.

3. Therefore in our present definition the term "superintendent" must be substituted for "herdsman."

What special kind of superintendence is true statesmanship?

¹ *Rep.* vi 493.

² *ἄσχηματὸς*

¹ *Soph.* 265 D.

4. By way of an example, the art of weaving is defined. The example shows that kingcraft has first to be separated from other kindred arts, both causal and co-operative. Nine categories are adduced which exhaust social functions. Eight are eliminated, and the ninth, the class of ministers, remains. Of these (a) slaves, (b) hirelings, (c) traders, (d) officials, (e) priests are again parted off, although the last are only with difficulty separated from the king, when (f) a strange medley of monstrous creatures come into view. Some are fierce like lions, some crafty like the fox, and some have mixed natures like centaurs and satyrs. These are the actual rulers of mankind, more sophistical and juggling than the sophist himself. And they too must be separated from the true king.

5. The familiar tripartite distinction of monarchy, oligarchy, democracy, is doubled by introducing into each the distinction involved in the presence or absence of wealth, and in the observance or non-observance of law. But no one of the six carries in itself a scientific principle.

The true government is the rule, not of many, but of one or of a few. "And they may govern, whether poor or rich, by free-will or compulsion, and either with or without law, so long as they govern scientifically."

6. The respondent, a youthful namesake of Socrates, is shocked at the remark that the true ruler may govern without law.

This leads to a discussion of the nature of law, which is compared to the prescription left by a physician. If present, he might dispense with his own rule. So the presence of a competent ruler is better than the sovereignty of law, which makes no allowance for nature or circumstance, but tyrannically forces its own way. Imagine medicine, navigation, &c., similarly conducted by time-honoured prescription, with penalties for innovation;—what would become of civilization? Yet if law is disregarded by rulers who are unscientific and warped by self-interest, this leads to far worse evils. For the laws are based on some experience and wisdom. Hence, in the continued absence of the true ruler, the best course, though only second best, is the strict observance of law. And he who so rules in humble imitation of the scientific governor may be truly called a king, although if the divine lawgiver were to appear his living will would supersede the law.

7. As it is, though cities survive many evils, yet many are shipwrecked because of the ignorance of those at the helm. The order of badness in the actual states is—

1. Constitutional monarchy.
2. Constitutional oligarchy.
3. Law-abiding democracy.
4. Law-breaking democracy.
5. Law-defying oligarchy.
6. Tyranny.

8. It remains to separate from the true ruler those who co-operate with him as subordinates, the general, the judge, the orator. His own peculiar function is an art of weaving strength (the warp) with gentleness (the woof), when education has prepared them—and this (1) by administration, (2) by marriage.

The four preceding dialogues have shown (1) the gradual transformation of the Platonic ideas (while still objective) into forms of thought, (2) the tendency to group them into series of categories, (3) a corresponding advance in psychological classification, (4) an increasing importance given to method, (5) the inclination to inquire into processes (*γενεσις*) as well as into the nature of being.

Meanwhile Plato's approach to the Eleatics, though in the way of criticism, has brought into prominence the notions of unity, being, sameness, difference, and has left somewhat in abeyance the idea of good. To this "highest of all studies" Plato now returns, equipped with his improved instruments, and ready to forge new ones in the same laboratory, or in some other, should occasion serve. His converse with Parmenides ended in his assertion of an element of difference pervading all things—in other words, of an indeterminate element underlying all determinations. This brings him again into relation with the Pythagoreans, who had similarly asserted the combination of finite and infinite in the universe. Taking advantage of their help, he gains a more advanced (but still ideal) conception of the concrete harmony of things, and approaches the definition of that which in the *Republic* he but shadowed forth. With this most serious inquiry there is combined (as in the *Sophistes* and *Politicus*) an ironical and controversial use of dialectic, by which the juggler and false pretender (who is in this case the goddess of pleasure), after claiming the highest place, is thrust down to the lowest.

It must be admitted that the style of the *Philebus* is far from brilliant, or even clear. In the effort of connecting abstractions

Plato's movement is more laboured than in his first glad realization of them.

Instead of attempting here to follow the windings of the dialogue, it must suffice to state the main result. Neither pleasure nor knowledge is the highest good, and the good ends definition; but the shrine, or habitation, of the good is a complex life of which the elements are, in order of merit: (1) measure, the cause of all right mixture; (2) (a) beauty, the effect, and (b) reality, the inseparable condition; (3) intellect; (4) science, art and right opinion; (5) pure pleasure unaccompanied with pain. "Not all the animal kingdom shall induce us to put pleasure first."

The *Philebus* introduces us to the interior of the Academy in the lifetime of the master. More than any other of the dialogues it recalls Aristotle's description of Plato's teaching. But, while his followers seem early to have fallen under the dominance of the latest phase of his doctrine, Plato himself, even in the *Philebus*, is still detached from any servitude to the creation of his own mind. He manipulates them as the medium for expressing his fresh thoughts, but they are not yet crystallized into a system.

"I will remind you," Socrates, "of what has been omitted," says Protarchus at the conclusion of this dialogue. The last (presumably) of Plato's metaphysical writings thus fits end with a confession of incompleteness. But if, as Renan says "the most fatal error is to believe that one serves one's country by calumniating those who founded it," neither is it for the interest of science to ignore these imperfect anticipations. By methods elaborated in the course of centuries, and far more than any which Plato had at his command, mankind have gained an extent of knowledge which he dreamt not of.¹ But the Greek metaphysician is none the less a pioneer of knowledge; with the special sciences of ethics and psychology had been carried from infancy to adolescence in a single lifetime.

VII. *Timæus, Critias* [*Hermocrates*].—As the *Sophistes* and *Politicus* were written in continuation of the *Theætetus*, so, at some uncertain time, Plato conceived the design of writing a great trilogy, for which the ideal state depicted in the *Republic* should be the point of departure. The grand outline thus sketched by Socrates was now to be filled up by *Critias* and *Hermocrates*. The form set up by reasoning should be made alive, the "airy burghers" should be seen "making history." As a prelude to this magnificent celebration, *Timæus*, the Pythagorean philosopher, who is present at the Panathenæa, is invited to discourse of the origin of all things, and to bring down the glorious theme to the creation of man. What should have followed this, but is only commenced in the fragment of the *Critias*, would have been the story, not of a fall, but of the triumph of reason in humanity.

In the *Philebus* (59 A, cf. 62 D) Plato speaks with a touch of contempt of the life-long investigation of nature, as being concerned only with this visible universe, and immersed in the study of phenomena, whether past, present or to come, which admit of no stability and therefore of no certainty. "These things have no absolute first principle, and can never be the objects of reason and true science."

Yet even this lower knowledge is there admitted as an element of that life which is the habitation of the good. And there are not wanting signs in his later dialogues that Plato's imagination had again been strongly drawn towards those physical studies which, as the *Phædo* shows, had fascinated him in youth. That nature and the world proceed "according to God and not according to chance" is the belief of the Eleatic stranger, to which he perceives that Theætetus will be irresistibly drawn as he grows older (*Soph.* 265 D). In the midst of dialectical abstractions, the processes of actual production (*γενεσις*) have been increasingly borne in mind. And the myth in the *Politicus* turns on cosmological conceptions which, although differing from those in the *Timæus*, and more accordant with Plato's bitterest mood, yet throw a new light on the deeper current of

¹ See, however, *Polit.* 272 C, D.

² See Jowett, *Intro.* to the *Timæus*.

his thoughts. In the same passage (272 C) there occurs the first clear anticipation of an *interrogatio naturae*.

The impulse in this new direction, if not originated, was manifestly reinforced, through closer intercourse with the Pythagorean school. And the choice of Timaeus the Pythagorean as chief speaker is an acknowledgment of this obvious tendency. If in the course of the dialogue there occur ideas apparently borrowed from the Atomists, whom Plato persistently ignored, this fact ought probably to be referred to some early reaction of Atomic on Pythagorean doctrine. It is important to observe, however, that not only the *Timaeus*, but the unfinished whole of which it forms the introduction, is professedly an imaginative creation. For the legend of prehistoric Athens and of Atlantis, wherof Critias was to relate what belonged to internal policy and Hermocrates the conduct of the war, would have been no other than a prose poem, a "mythological lie," conceived in the spirit of the *Republic*, and in the form of a fictitious narrative. And, therefore, when Timaeus professes to give only a probable account of shadowy truths, he must be taken at his word, and not criticized in too exacting a spirit. His descriptions have much the same relation to the natural philosophy of Plato's time that Milton's cosmology has to the serious investigations of Galileo or Copernicus—except that all physical speculation hitherto partook in some measure of this half-mythological character, and that Plato's mind, although working in an unfamiliar region, is still that of a speculative philosopher.

As Parmenides, after demonstrating the nonentity of growth and decay, was yet impelled to give some account of this non-existent and unintelligible phenomenal world, so

Timaeus. Plato, although warned off by Socrates, must needs attempt to give a probable and comprehensive description of the visible universe and its creation. In doing so he acknowledges an imperfect truth in theories which his dialectic had previously set aside. In examining the earlier philosophers he has already transgressed the limits prescribed by Socrates, and the effort to connect ideas has made him more and more conscious of the gap between the ideal and the actual. He cannot rest until he has done his utmost to fill up the chasm—calling in the help of imagination where reason fails him. His dominant thought is still that of a deduction from the "reason of the best," as in the *Phaedo*, or "the idea of good," as in the *Republic*. But both his abstract idealism and his absolute optimism were by this time considerably modified, and, although not confounding "causes with conditions," as he once accused Anaxagoras of doing, he yet assigns more scope to "second causes" than he would then have been willing to attribute to them. This partly comes of ripening experience and a deepening sense of the persistency of evil, and partly from the feeling—which seems to have grown upon him in later life—of the distance between God and man.

Timaeus begins by assuming (1) that the universe being corporeal is caused and had a beginning, and (2) that its mysterious author made it after an everlasting pattern. Yet, being bodily and visible, it can only be made the subject, humanly speaking, of probable discourse. Thus much being premised, he proceeds to unfold—(a) the work of mind in creation, (b) the effects of necessity, including the general and specific attributes of bodies, (c) the principles of physiology, and (d) an outline of pathology and medicine.

To give a full account of such a comprehensive treatise is beyond our scope, and the *Timaeus*, however great and interesting, has been well described as an out-building of the great fabric of original Platonism. A very few scattered observations are all that there is space for here.

1. In the mythology of the *Timaeus* some of the conceptions which attained logical clearness in the *Sophist* and *Philebus* resume an ontological form. Thus, in compounding the soul-stuff of the universe, the father of all takes of the continuous and discrete and fuses them into an essence (the composite being of the *Philebus*). Again he takes of the same and other (cf. the *Sophist*), overcoming their inherent repugnance by his sovereign act.

2. The notion of an economy or reservation in Plato has been often exaggerated and misapplied. But it is difficult to acquit him of intentional obscurity in speaking of the creation of the Earth. It is clear, though Plato does not say so, that she is meant to have been created together with the Heaven and together with Time, and so before the other "gods within the heaven," i.e. the sun and

moon and five planets, and it is a plausible supposition that she is the "artificer of day and night," by interposing her bulk to the sun's rays. If the word *ἐλλοβίον* in p. 40 implies motion (as Aristotle thought¹), it cannot be, as Grote supposed, a motion contemporaneous with that of the outer sphere, but either some far slower motion, perhaps assumed in order to account for the shifting of the seasons, or an equal retrograde motion which is supposed to neutralize in her case the "motion of the same." She clings to the centre, as her natural abode. And the diurnal motion of the heavens is due not to any mechanical force but to the soul of the world extending from the centre to the poles and comprehending all.

3. Immortality is in the *Timaeus* dependent on the will of the Eternal. And the sublime idea of eternity is here first formulated.

4. The phenomena of vision and hearing are included among the works of reason, because the final cause of these higher senses is to give men perception of number, through contemplation of the measures of time.

5. 1. It has been commonly said that the four elements of the *Timaeus* are geometrical figures, without content. This is not true. For what purpose does Plato introduce, "besides the archetype and the created form, a third kind, dim and hard to conceive, a sort of limbec or matrix of creation," if not to fill up the triangles which are elements of elements, and to be the vehicle of the forms compounded of them? It has been supposed that this "matrix of generation" is identical with "space," and it cannot be said that they are clearly kept apart by Plato. But he had a distinct nomenclature for either, and, although gravity is explained away (so that his molecules, unlike Clerk Maxwell's, may be called imponderable), yet extension, or the property of filling space, is sufficiently implied.

2. The difference of size in the triangles and varying sharpness of their outlines are ingenious though inadequate expedients, adopted in order to account for qualitative difference and physical change.

3. In criticizing the illusory notion of "up and down," Plato, apparently for the first time, broaches the conception of antipodes.

4. More distinctly than in the *Philebus*, bodily pleasure is explained by "a sudden and sensible return to nature" (cf. *Ar. Rhét.* i. 11, § 1; *N.E.*, vii. 10).

5. Natural philosophers are warned against experimenting on the mixture of colours, which is a divine process and forbidden to man (*Tim.* 68D). (Ancient alchemy was at a loss for a theory of colours.)

6. 1. Plato tends more and more in his later writings to account for moral evil by physical conditions, thus arriving at the Socratic principle of the involuntariness of vice by a different road.

Hence in the *Timaeus* not the body only is made by the inferior gods, but they also create the lower and mortal parts of the human soul: the principle of anger which is planted in the breast, within hearing of reason, and that of appetite which is lodged below the diaphragm like an animal tied in a stall, with the stomach for a crib and the liver for a "soothsaying" looking-glass to soothe or terrify it when tempted to break loose.

2. The brain-pan was left base of protecting flesh "because the sons of God who framed us deliberately chose for us a precarious life with capability of reason, in preference to a long secure existence with obstruction of thought."

3. The nails are a rudimentary provision for the lower animals, into which degenerate souls were afterwards to be transformed.

4. Vegetables have sensation but not motion.

5. By way of illustrating the very curious account here given of respiration, it is asserted that what is commonly thought to be the attraction of the magnet is really due to rotatory motion and displacement: a remarkable anticipation (*Tim.* 80C).

6. When the original particles wear out, and the bonds of soul and body in the marrow give way, the soul escapes delightedly and flies away. This is the painless death of natural decay.

7. The dependence of mental disease on bodily conditions is more fully recognized in the *Timaeus* than elsewhere in Plato (contrast the *Charmides*, for example).

8. He has also changed his mind about the treatment of disease, and shows more respect for regimen and diet than in the *Republic*. Diseases are a kind of second nature, and should be treated accordingly.

9. It is also a remark in contrast with the *Republic*, that over-study leads to head complications, which physicians ascribe to chill and find intractable.

Lastly, it is one of the strange irregularities in the composition of the *Timaeus* that the creation of woman and the relation of the sexes² to each other are subjects reserved to the end, because this is the place given to the lower animals, and woman (cf. the *Phaedrus*) is the first transmigration from the form of man. This order is probably not to be attributed to Plato's own thought, but to some peculiarity of Pythagorean or Orphic tradition.

VIII. *The Laws*.—The two series of dialogues, the dialectical and the imaginative—*Sophistes*, *Politicus*, *Philosophus*—*Timaeus*, *Critias*, *Hermocrates*—were left incomplete. For Plato had concentrated his declining powers, in the evening of

¹ Aristotle, however, uses *ἐλλοβίον*, a different word.
² There is an anticipation of microscopic observation in the words *ἀβάρη ἰσὸς εὐσπέρματος καὶ ἀβάρησιν* (*ἴσος* = spermatozoa).

his life,¹ upon a different task. He was resolved to leave behind him, if he could so far overcome the infirmities of age,² a code of laws, conceived in a spirit of concession, and such as he still hoped that some Hellenic state might sanction. The motive for this great work may be gathered from the *Politicus*. The physician in departing is to give a written prescription, adapted as far as possible to the condition of those from whom he goes away. This is the second-best course, in the absence of the philosopher-king. And, as the Hellenic world will not listen to Plato's heroic remedy, he accommodates his counsel to their preconceptions. He returns once more from abstract *Laws* discussions to study the application of ideas to life, and though, by the conditions of the problem, his course is "nearer earth and less in light," this long writing, which is said to have been posthumous,³ has a peculiar interest. The ripeness of accumulated experience and the mellowness of wise contemplation make up for the loss of prophetic insight and poetic charm.

The form of dialogue is still retained, and an aged Athenian is imagined as discoursing of legislation with the Lacedaemonian Megillus and the Cretan Cleinias, who has in view the foundation of a new colony, and is on his way with his two companions from Cnossus to the temple and oracle of Zeus.

Plato now aims at moderating between Dorian and Ionian law, freely criticizing both, and refining on them from a higher point of view. "The praise of obedience, the authority assigned to elders, the prohibition of dowries, the enforcement of marriage, the common meals, the distribution and inalienability of land, the institution of the *Crypteia*, the freedom of bequest to a favourite son, the dislike of city walls—all reflect the custom of Sparta." "The use of the lot, the scrutiny of magistrates, the monthly courses of the council, the pardon of the forgiven homicide, most of the regulations about testaments and the guardianship of orphans, the degrees of consanguinity recognized by law, correspond to Athenian laws and customs" (Jowett).

The philosopher's own thoughts come out most strongly in the "preludes" to the laws,⁴ and in the regulations concerning education, marriage and the punishment of impiety (i.e. 1st, atheism; and, denial of providence; 3rd and worst, immoral superstition). The difficulty which is met in the *Politicus* by the abandonment of the world for a time, and in the *Timaeus* by the lieutenantancy of lower gods, here leads to the hypothesis of an evil soul. The priority of mind (often before asserted) and the increased importance attached to numbers are the chief indications of Plato's latest thoughts about the intelligible world. But it must be remembered that the higher education (answering to *Rep.* vi., vii.) is expressly reserved.⁵ Had Plato written his own *Epinomis*, the proportions of the whole work (not then "acéphalous") might have been vastly changed.

The severity of the penalties attached to the three forms of heresy, especially to the third and worst of them, has led to the remark that Plato, after asserting "liberty of prophesying," had become intolerant and bigoted in his old age (Grote). But the idea of toleration in the modern sense was never distinctly present to the mind of any ancient philosopher. And, if in the *Laws* the lines of thought have in one way hardened, there are other ways in which experience has softened them. Plato's "second-best" constitution contains a provision, which was not admissible in the "perfect state," for possible changes and readaptations in the future. The power of self-reformation is hedged round indeed with extreme precautions; and no young or middle-aged citizen is ever to hear a word said in depreciation of any jot or tittle of the existing law. But that it should be provided, however guardedly, that select commissioners, after

travelling far and wide, should bring back of the fruit of their observations for the consideration of the nocturnal council, and that a power of constitutionally amending the laws should thus be admitted into the state, is sufficiently remarkable, when the would-be finality of ancient legislation is considered. Plato even comes near to the reflexion that "constitutions are not made, but grow" (iv. 709 A).

Plato in the *Laws* desists finally from impersonating Socrates. But he is in some ways nearer to his master in spirit than when he composed the *Phaedrus*. The sympathy with common life, the acceptance of Greek religion, the deepening humanity, are no less essentially Socratic than the love of truth which breathes in every page. And some particular aspects of Socratism reappear, such as the question about courage⁶ and that concerning the unity of virtue.⁷

Doubtful and Spurious Works.—Of the dialogues forming part of the "Platonic canon," and not included in the preceding survey, the *Lesser Hippias*, *First Alcibiades* and *Meneceus* are the most Platonic, though probably not Plato's. The *Greater Hippias* and the *Cleitophon* are also admitted to have some plausibility. The *Second Alcibiades* (on Prayer), the *Hipparchus* (touching on Peisistratus and Homer), *Minos* ("de lege"), *Epinomis*, *Erastus*, *Theages*, are generally condemned, though most of them are very early forgeries or academic exercises.⁸ And the *Arioclus* (though sometimes prized for its subject, "the contempt of death"), the *De justo*, *De virtute*, *Demodocus*, *Sisyphus*, *Eryxias* (a not-uninteresting treatise on the use of money), together with the so-called *Definitions*, were rejected in ancient times, and are marked as spurious in the MSS.

EDITORS.—(1) Complete: Aldine, Ven., 1513; H. Stephani, 3 vols. (1578), with Latin version by Serranus (*de De Serris*, the real editor), (the paging of this edition is preserved for convenience of reference on the margins of most subsequent editions); G. Stallbaum, (12 vols., 1821-1825); G. Stallbaum, the text in 1 vol. (1850); C. F. Hermann (6 vols., 1851-1853); Immanuel Bekker (1816-1822); the Zurich edition by Baier, Orrelli and Winkelmann (1839-1842); Hirschig and Schneider, in Didot's series (1856-1873); M. von Schanz, with critical notes (1875-1887); J. Burnet (Oxford, 1902). (2) Partial: L. F. Heindorf, *Lysis*, *Charmides*, *Hippias Major*, *Phaedrus*, *Gorgias*, *Theaetetus*, *Cratylus*, *Parmenides*, *Euthydemus*, *Phaedo*, *Sophist*, *Protagoras*; *Philebus*, C. Badham, E. Poste (1861); R. G. Bury, *Apologia*, J. Riddell (with *Digest of Platonic Idioms*) (1861); *Protagoras*, Wayte (1854) 1871; *Theaetetus*, L. Campbell (1861) 1883; B. Kennedy; *Sophist* and *Politicus*, L. Campbell (1867); *Phaedo*, W. Geddes, Archer Hind; *Timaeus*, Archer Hind (1888); *Parmenides*, Waddell (1894); *Meno*, J. Adam, Seymer Thompson; *Apologia*, *Crito*, *Meno*, St. G. Stock; *Euthydemus*, Gifford; *Thaetetus*, *Gorgias*, W. H. Thompson; *Symposium*, *Euthydemus*, *Laches*, C. Badham; *Parmenides*, Stallbaum, Maguire, Waddell; *Leges*, F. Ast (1814), C. Ritter (*Commentary*) (1896); *Republic*, Jowett and Campbell (1894), J. Adam (1902).

TRANSLATIONS.—Latin: A Latin version of the *Timaeus* by Chalcidius existed in the middle ages and was known to Dante. It was printed at Paris in 1520 (Teubner, 1876). The complete rendering by Marsiglio Ficino (1496) formed the basis of other Latin translations, such as that of Serranus (*supra*), which accompanied the edition of Stephanus. It was printed in the Basel edition of 1534. English: (1) Complete: Sydenham and Taylor (1804); Jowett (1871-1892). (2) Partial: *Republic*, Davies and Vaughan, Jowett (in a separate volume; 3rd ed., 2 vols., 1908); *Philebus*, E. Poste; *Gorgias*, Cope; *Timaeus*, Archer Hind (in his edition); *Apology*, *Crito*, *Phaedo*, Church, Jowett (reprinted from the complete translation with preface by E. Caird); *Theaetetus*, Paley, Kennedy; German: Schleiermacher (1817-1828); J. H. Müller (1850-1866); French: V. Cousin (12 vols., 1822-1840). Italian: Bonghi.

DISSERTATIONS.—English: F. Schleiermacher's *Introductiones*, translated by W. Dobson (1836); Ed. Zeller's *Plato and the Older Academy*, translated by F. Alleyne, &c. (1876); B. Jowett's *Introductiones*, in his complete translation, final edition (1892); G. Grote, *Plato and the other Companions of Socrates* (1865); F. C. Conybeare on an Armenian version (1891); W. Pater, *Plato and Platonism* (1893); R. L. Nettleship, *Lectures on the Republic*, &c. (1898) (cf. also his essay in *Hellenica*, 1880); Th. Gomperz, *Greek Thinkers*, vols. ii. and iii. in Eng. trans. (1905); W. Lutoslawski, *Plato's Logic*, &c.; L. Campbell on *Plato's Republic* in Murray's "Home and School Series" (1902); L. Campbell, *Religion in Greek Literature* (London, 1898); J. A. Stewart, *The Myths of Plato* (1905); A. E. Taylor, *Plato* (1908); J. A. Stewart, *Plato's Doctrine of Ideas* (1909). German:

¹ Cf. *Laches*.

⁷ Cf. *Protagoras*.

⁸ According to Schaaarschmidt, only nine dialogues are genuine—*Protag.*, *Phaedr.*, *Symp.*, *Apol.*, *Crito*, *Phaedo*, *Rep.*, *Tim.*, *Leges*.

¹ *ἄμεις δ' ἐπὶ θανάτῳ τὸν βίον*, *Legg.* vi. 770 A.
² *ἢ . . . ἄραυς ἐπιπαύσασθαι τῆ ζωῆς*, *Legg.* vi. 752 A.
³ Published by Philippus the Opuntian.
⁴ See especially iv. 716 seq.; v. 727 seq.; 735 seq.; vi. 766; vii. 773 seq.; 777, 794, 803 seq.; 811, 817; viii. 835 seq.; ix. 875; x. 887 seq. 897 seq.; 904 seq.
⁵ *Legg.* xii. 968 E. (Ash). "I am willing to share with you the danger of stating to you my views about education and nurture, which is the question coming to the surface again."

C. F. Hermann, *Geschichte und System*, &c. (1839); A. Boeckh, *Untersuchungen* (1852); Ed. Zeller, *Geschichte der gr. Philosophie*; Fr. Überweg, *Untersuchungen* (1861); S. Ribbing, *Genetische Darstellung* (1863); Fr. Susemihl, *Genetische Entwicklung* (1865-1868); E. Albert, *Zeit und Ordnung* (1864); C. Schaarschmidt, *Die Sammlung der platonischen Schriften* (1866); M. Vermehren, *Plat. Studien* (1870); D. Peipers, *Untersuchungen über das System Platons*, Teil i., "Die Erkenntnistheorie" (Leipzig, 1874); O. Apelt, *Beiträge zur Geschichte der griechischen Philosophie*; L. Spengel, *Socrates und Platon* (1863); A. Krohn, *Die platonische Frage* (1878); E. Teichmüller, *Literarische Fehder* (1881); H. Bonitz, *Platonische Studien* (especially valuable) (1886); E. Pfeleiderer, *Socrates und Platon* (1896); H. Windenband, *Platon* (1900); C. Ritter, *Untersuchungen*; Th. Gomperz, *Platonische Aufsätze: Griechische Denker*, vol. ii.; P. Natorp, *Pl. Ideenlehre* (1903); C. Ritter, *Platon: sein Leben, seine Schriften, seine Lehre* (1909), vol. i.; and *Neue Untersuchungen* (1910). Other references will be found in the volumes named. French: V. Cousin; T. H. Martin, *Études sur la Timée* (1841). Italian: Felice Tocco.

DICTIONARIES AND INDICES.—Mitchell's *Index to Plato*; F. Ast, *Lexicon platonium*; E. Abbott, *Index to Plato* (English, 1875).

ON THE MSS.—See especially Bekker's edition; Gaisford's *Lectioes platonicae* (1820); M. Schanz's edition with critical notes; Jowett and Campbell's *Republic*, vol. ii.; J. Burnet's Oxford edition. The important *Codex Clarkianus* in the Bodleian library has been reproduced in facsimile, with a preface by T. W. Allen (1898-1899). (L. C.)

PLATO, Athenian comic poet of the Old Comedy, flourished between 428-389 B.C. According to Suidas, he was the author of thirty comedies. Some of these deal with political matters. Such were the *Cleophon* and *Hyperbolus*, directed against the well-known demagogues, and the *Symmachia*, referring to a coalition formed by Nicias, Alcibiades and Phaeax to get rid of Hyperbolus by ostracism. His later plays treat the vices and failings of mankind in the spirit of burlesque and parody. Such were the *Sophtistae*, akin to the *Clouds* of Aristophanes; the *Cinesias*, an attack on a contemporary poet; the *Festivals*, satirizing the useless expenditure and extravagance common on such occasions; mythological subjects—*Adonis*, *Europe*, *Io*, the *Ants* (on the Aeginetan legend of the ferry of ants into men); *Phaon*, the story of the Lesbian ferryman, who was presented by Aphrodite with a marvellous ointment, the use of which made women madly in love with him.

See T. Kock, *Comicarum alicorum fragmenta*, I (1880); A. Meineke, *Poetarum comicorum graecorum fragmenta* (1855).

PLATON, LEVSHIN (1737-1812), Russian divine, was born at Chashnikovo near Moscow, and educated in the academy of that city. In 1763 the empress Catherine II. invited him to instruct her son Paul in theology, and he became one of the court chaplains. Three years afterwards Platon was appointed archimandrite of the monastery of the Trinity (Troitskaya Lavra) near Moscow, in 1770 archbishop of Tver, and in 1787 archbishop of Moscow and metropolitan. He died in 1812, one of his last acts having been to write an encouraging letter to the emperor Alexander I. in view of the French invasion. Platon was a brilliant and learned man, and the author of several works which enjoyed a high reputation in their time, including *A Short History of the Russian Church*, which has been translated into English.

PLATONIC LOVE, a term commonly applied to an affectionate relation between a man and a woman into which the sexual element does not enter. The term in English goes back as far as Sir William Davenant's *Platonic Lovers* (1636). It is derived from the conception, in Plato's *Symposium*, of the love of the idea of good which lies at the root of all virtue and truth. *Amor platonicus* was used, e.g. by Marsilio Ficino (15th century), as a synonym for *amor socraticus*, referring to the affection which subsisted between Socrates and his pupils.

PLATOON (Fr. *platoon*, from Fr. *pelote*, a ball or pellet; cf. Ger. *Haufe*, heap), a small group of soldiers. In the early 17th century it was a definite tactical unit of infantry, corresponding to the modern section or half company. In the 18th century the battalion, irrespective of its organization into companies, was told off on parade into six, eight or ten platoons of equal strength. "Platoon fire" was the systematic and regulated fire of platoon volleys, the platoons firing one after the other. Hence a "platoon" sometimes means a volley.

The fire of a long line of infantry was as a rule conducted on the same principles, each battalion of the front line employing platoon fire, which is often picturesquely described as a "rolling platoon fire," or "rolling volleys." The word is obsolete in the British army, but is used in the United States, and, in various forms, in the armies of France and other Latin nations.

PLATT, THOMAS COLLIER (1833-1910), American politician, was born in Owego, Tioga county, New York, on the 15th of July 1833. He studied in 1849-1852 at Yale, from which he received the honorary degree of A.M. in 1876. He made money in lumbering out West, and returning to Owego became a banker and railway director. He helped to organize its Republican party in Tioga county, and in 1873-1877 was a representative in Congress. In 1877 he was chairman of the state Republican Convention at Rochester. On the 18th of January 1881 he was elected United States senator, but resigned, with his colleague, Roscoe Conkling, on the 16th of May following, chiefly because President Garfield, in spite of their protest, had appointed as collector of the port of New York, Judge William H. Robertson, a political opponent. Within ten years he became the acknowledged Republican "boss" of the state, and he again served in the United States Senate from 1897 to 1909. But his power waned steadily after about 1903. He died in New York City on the 6th of March 1910.

PLATTE (so named, from the French, because of its shallowness), or **NEBRASKA**, a river system of Colorado, Wyoming and Nebraska, tributary to the Missouri river, which it enters immediately north of Plattsmouth, Nebraska, 18 m. below Omaha, in about 41° 3' N. lat. Including the North Platte it is about 900 m. long from its headwaters, with a drainage basin for the entire system of 90,000 sq. m. The Platte proper is formed by the junction of the North Platte and the South Platte, sometimes called the North and South Forks of the Platte, immediately below the city of North Platte in Lincoln county, Nebraska. The North Platte and South Platte rise respectively in North Park and South Park in Colorado. The tributaries of the main stream all flow in from the north; the most important being the Loup, which empties immediately east of Columbus in Platte county, and the Elkhorn, which joins the Platte in Douglas county, due west of Omaha.

See J. C. Stevens, *Surface Water Supply of Nebraska* (Washington, 1909).

PLATTNER, KARL FRIEDRICH (1800-1858), German metallurgical chemist, was born at Kleinwaltersdorf, near Freiberg in Saxony, on the 2nd of January, 1800. His father, though only a poor working miner, found the means to have him educated first at the Bergschule and then at the Bergakademie of Freiberg, and after he had completed his courses there in 1820 he obtained employment, chiefly as assayer, in connexion with the royal mines and metal works. Having taken up the idea of quantitative mouth-blowpipe assaying, which was then almost unknown—except that E. Harkort (1797-1835) in 1827, while a student in Freiberg Academy, had worked out a blowpipe assay for silver—he succeeded in devising trustworthy methods for all the ordinary useful metals; in particular his modes of assaying for nickel and cobalt quickly found favour with metallurgists. He also devoted himself to the improvement of qualitative blowpipe analysis, and summed up his experience in a treatise *Die Proberkunst mit dem Löthrohr* (1835), which became a standard authority. In 1840 he was made chief of the royal department of assaying. Two years later he was deputed to complete a course of lectures on metallurgy at the Bergakademie in place of W. A. Lampadius (1772-1842), whom he subsequently succeeded as professor. He died at Freiberg on the 22nd of January 1858.

In addition to many memoirs on metallurgical subjects he also published *Die metallurgischen Rostprocessus theoretisch betrachtet* (1856), and posthumously *Vorlesungen über allgemeine Hüttenkunde* (1860).

PLATTSBURG, a city, port of entry and the county-seat of Clinton county, New York, U.S.A., situated on the west shore of Lake Champlain, at the mouth of the Saranac river, 168 m.

(by rail) N.N.E. of Albany. Pop. (1890, 7010; (1900, 8434, of whom 1053 were foreign-born; (1910, census), 11,138. It is served by the Delaware & Hudson railway, and has steamer connexions with lake ports. Its situation in the region of lakes and mountains and its delightful climate have made it a summer resort. Among its institutions are the Samuel F. Vilas Home (for aged and infirm women); the Home for the Friendless of Northern New York (1874), for the care of homeless children; the Plattsburg State Normal and Training School, the D'Youville Academy for girls (founded in 1860, chartered in 1871), under the direction of the Grey Nuns; the Collège St Pierre (Roman Catholic, 1903), and the Champlain Valley Hospital. The barracks, about a mile away, is an important military post. Cliff Haven, 2 m. south, is the seat of the Catholic summer school. Plattsburg has a fine harbour and is the port of entry of the Champlain customs district; in 1909 its exports were valued at \$15,169,502 and its imports at \$8,167,527. Among the city's manufactures are lumber, wood pulp, paper, shirts, sewing-machines and automobiles. The total value of the factory products in 1905 was \$1,056,702.

Plattsburg was incorporated as a village in 1795, and derived its name from Zephaniah Platt (1740-1807), who had led a colony of settlers to this place from Long Island; it became a city in 1902. About Valcour Island (5 m. south-east of Plattsburg), on the 11th of October 1776, a British fleet under Captain Thomas Pringle and an American flotilla under Benedict Arnold engaged in the first conflict between American and British fleets, the British being victorious. On the outbreak of the War of 1812 the village became the headquarters of the American army on the northern frontier. On the 11th of September 1814, in Plattsburg (or Cumberland) Bay, Captain George Downie, commanding a British flotilla, was defeated by an American flotilla commanded by Commodore Thomas Macdonough, losing his life in the engagement (see CHAMPLAIN, LAKE).

PLATTSMOUTH, a city and the county-seat of Cass county, Nebraska, U.S.A., situated in the valley and on the bluffs of the Missouri river near the mouth of the Platte. Pop. (1900), 4964 (979 foreign-born); (1910) 4287. It is served by the Chicago, Burlington & Quincy, and the Missouri Pacific railway systems. There are railway car-shops, and a considerable trade is done in grain and cattle. A trading-post licensed by the United States government was opened here in 1853, and a town platted in 1854. Plattsburgh was first incorporated as a city in 1855, being one of the oldest settlements and cities of the state.

PLATYELMIA, a phylum of the animal kingdom which comprises three classes, the Planarians, Trematodes (*q.v.*) and Cestodes. It is the group of animals in which the act of creeping has first become habitual. In association with this movement in a definite direction the body has become vermiform and bilaterally symmetrical. One end of the body, through contact, during locomotion, with fresh tracts of medium and other forms of stimuli, has become more specialized than the rest, and here the nervous system and sense-organs are more densely aggregated than elsewhere, forming a means of controlling locomotion and of correlating the activities of the inner organs with the varying stimuli that impinge upon the body. The form and habits of the group vary widely. The Planarians are free-living animals, the Trematodes are parasitic upon and within animals, and the Cestodes are wholly endoparasitic.

Structure.—The chief features which Platyelmlia possess in common are the following. The body is not metamericly segmented and is composed of a muscular tunic covered externally by a more or less modified cellular layer. Within this muscular tube lies a parenchymatous tissue which may be uniform (Cestodes) or differentiated into a central or digestive, and a peripheral portion (some Turbellaria), or finally the central portion becomes tubular and forms the digestive sac (Trematodes), while the peripheral portion is separated from it by a space lined in some forms by a flattened epithelium (most Planarians). It is characteristic of the group that the mouth should be the only means of ingress to and egress from the digestive sac and that no true perivisceral space or coelom exists in the sense in which these terms are used in higher Invertebrates. The peripheral paren-

chyma gives rise to protonephridia, that is to coiled tubes commencing in pyriform cells containing a flame-like bundle of cilia and provided with branched outgrowths, and communicating with the exterior by long convoluted canals which open at the surface of the body. These protonephridia are the excretory organs. The nervous system, though centralized at one end of the body, contains diffused nerve-cells in the course of its tracts, which are disposed in two or more longitudinal bundles interconnected by transverse bands. The Platyelmlia are hermaphrodite and the reproductive organs are complex. The male organs consist of paired testes communicating by delicate canals with a protrusible penis. This organ is generally single but sometimes paired and occasionally multiple. It is frequently armed with spines, hooks or stylets, and is further complicated by the addition of a nutritive secretion (the prostate gland) which may open at its base or pass separately by a special duct to the exterior. There is some reason to believe that this complicated and variable apparatus is used for stabbing the body of another animal and that beginning as a weapon for catching prey it has become modified for hypodermic impregnation and only gradually adapted for insertion into the bursa copulatrix. The female organs are no less complex. They consist of solid or tubular ovaries which may be single, double or multiple. In the majority of Platyelmlia the primitive ovary becomes divided into fertile and sterile portions, i.e. into distinct ovarian and vitellarian regions. The yolk prepared by the latter is conducted by one or more specialized ducts to the oviduct and the point of union is distinguished by the opening of a "shell-gland" which secretes a membrane around the conjoined mass of ovum and yolk. From this junction there proceeds an oviduct or "uterus" (paired or single) which before opening to the exterior expands to form a muscular protrusible pouch—the bursa copulatrix. Frequently also from this junction of the ovaria and the vitellaria a median tube is given off which either opens to the exterior or into the intestine, in the latter case it appears to serve as means of conveying superfluous yolk to the gut, where it may serve as food.

Inter-relationships.—The inter-relationships of the three members of the Platyelmlia are of a more doubtful nature than is the unity of the phylum. The Turbellaria undoubtedly form the most primitive division, as is shown by their free-living habits, ciliation and sense-organs. The Trematodes are somewhat modified in accordance with their ecto- or endoparasitic life, but they exhibit such a close similarity of structure with the Turbellaria that their origin from Planarians can hardly be doubted, and indeed the Temnocephaloidea (see PLANARIANS) form an almost ideal annectant group linking the ectoparasitic Trematodes and Rhabdocoele Planarians. The Cestodes, however, are connected by no such intermediate forms with the other Platyelmlia. Their adaptations to parasitic life in vertebrate animals appear to have involved such modifications of structure and development that their affinities are quite problematical. The entire absence of any trace of a distinct alimentary tract, the loss of true regenerative power, the peculiar gametic segmentation of the body into hundreds of "proglottides" budded off from

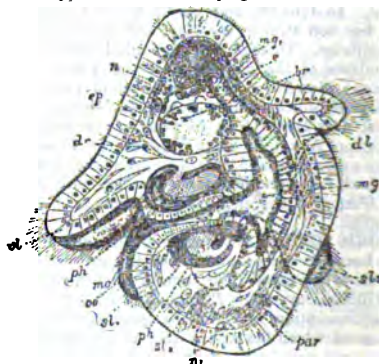

(From Cambridge Natural History, vol. II, "Worms, &c." by permission of Macmillan & Co., Ltd.)

FIG. 1.—Free-swimming Larva (Müller's Larva) of a Polychaete Planarian to illustrate the trochophore-hypothesis of the origin of Platyelmlia. The larva is seen in optical section, and its distinguishing feature is the ciliated lobed band (*cf. d, d'*), which corresponds to the pre-oral ciliated band of a trochophore-larva. It is here drawn out into eight processes, of which six are shown, their continuity being expressed by the dotted line.

<i>br.</i> Brain.	<i>mg.</i> Stomach.
<i>dr.</i> Glands.	<i>n.</i> Nerves.
<i>ep.</i> Epidermis.	<i>ph.</i> Pharynx.
<i>mo.</i> Mouth.	<i>par.</i> Parenchyma.

one extremity, and the absence of any morphologically distinct anterior extremity, are adaptations to the wholly parasitic life of this class. Their structure is similar to that of Trematodes, from which in the opinion of most zoologists they have been derived.

Affinities.—As the Turbellaria (Planarians) are the most primitive division of the Platyelmin, the problem of the affinities of this phylum resolves itself into that of the relationships of the Turbellaria. With regard to the origin of this class two divergent views are still held. On the one hand the Turbellaria are considered to be an offshoot of the early Coelomate stock, on the other they are held to be descendants of a simpler two-layered stock. The former hypothesis with its variants may be called the Trochosphere-hypothesis, the latter the Gastraea-hypothesis. The Trochosphere-hypothesis (2), (3) is based chiefly on the occurrence in certain Polyclad Turbellaria, of a larval form (Müller's larva) which is comparable to a certain stage (pro-trochula) in the development of the Trochosphere-larva. This Trochosphere is the characteristic larva of Mollusca, Annelida

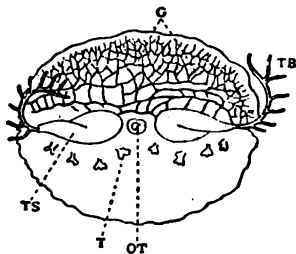

(After Abbott, Tôkyô Zool. Society's *Annot. Zoologicae Japonensis*, iv. 4, 2 and 3.)
 FIG. 2.—Dorsal view of *Cocolopana* to illustrate the similarity between Ctenophora and Turbellaria. The branched intestine (G) is drawn on one side of the animal only, it opens to the exterior by means of a pharynx (not shown). The mouth is shown by the line surrounding the otolith (OT) in the centre. The mouth is ventral, the otolith dorsal. The two branched tentacles (TB) are seen partially extruded from their sheaths (TS); when fully extended they exceed the diameter of the animal five or six times. The short tentacles (T) are drawn on one side only.

Cocolopana has been found in shallow water in the Red Sea and on the coast of Japan. Ctenophora possess two similar long branched tentacles, a ventral mouth and dorsal otolith.

and some Cephyrea; and the Rotifera appear to remain throughout life as modified Trochospheres. It is a top-shaped, free-swimming organism provided with a preoral band of cilia, an apical sense-organ, a simple gut, protonephridia and schizocoel. The importance of this resemblance between the Polyclad larva and the Trochosphere-larva of higher invertebrates is increased if the widely adopted

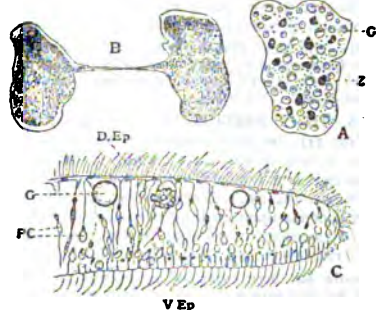

(After F. E. Schultz, *Kgl. Preuss. Abh. der Wissenschaft*, Berlin, 1897.)

FIG. 3.—*Trichoplax adhaerens*, an organism considered, on the Gastraea-hypothesis, to be closely allied to the progenitors of the Platyelminia. (The recent work by Krumbach [*Zoolog. Anzeiger* 1907, xxxi. 450], serves to show that *Trichoplax* is the planular larva of a Hydromedusa.)

- A, a small specimen drawn from life. The spherical granules (G) are probably gland-secretions; the dark bodies (Z) are probably xanthellae, i.e. algal cells living in association with the animal.
- B, a specimen undergoing fission.
- C, part of a vertical section.
- D.Ep, The dorsal epidermis.
- G, Refringent corpuscles.
- PC, Parenchymatous cells.
- V.Ep, Ventral epidermis. The hair-like processes are cilia.

view (held on other grounds) that the Polyclads are the most primitive of the Turbellaria, is soundly based. The grounds for this view are the radial symmetry of several Polyclads and the supposed origin of gonads and excretory flame-cells from the walls of gut, the occurrence of nematocysts in *Acanthymus*, one of the most radially constructed Polyclads, and lastly the presence of two peculiar animals *Ctenoplana* and *Cocolopana*, which suggests a transition from Ctenophora to Polyclads. At the present time, however, none of these grounds can be said to possess so much force as they did some years ago (4). The argument has come to rest on the agreement between the cell-lineage of Polyclads and that of certain Mollusca and Annelids. This resemblance is considered by Hubrecht (5) to give reason for concluding that the Polyclads are an offshoot, and possibly a degenerate offshoot, from the early Coelomate stock.

The Gastraea-hypothesis is founded on quite other considerations. In effect (6) it traces the Turbellaria to small two-layered organisms consisting of an outer ciliated epidermis and a central syncytial tissue. Such an organism is found in the peculiar *Trichoplax*, *Lohmanniella*, &c. The early stages of most animals pass through such a stage, which is known as a "planula." From such beginnings the evolution of the Turbellaria leads first through the Acoelous forms in which the central syncytium is partly differentiated into digestive, muscular and skeletotrophic tissue, then to the more specialized Rhabdocoela, and so through the Allocoela to the Triclad and finally to the Polyclads. The careful study of the development of one Acoelous form and of certain Rhabdocoels has strengthened this hypothesis by showing that no definite enteron or gut is at first laid down, but that certain embryonic syncytial tracts become digestive tracts, others excretory, others again muscular. The study of Rhabdocoels (7) has led to the important discovery that the rudiment of the gonads and that of the pharynx are the first organs to appear, and that the alimentary sac arises independently of them. This segregation of the germ cells and their independence of the intestinal sac is an indication that the origin of these cells is not coelomic nor enteric, and until we possess further information as to the evolution of the complex genitalia of the higher Turbellaria we cannot hope to understand the presence of such highly modified structures in animals of an otherwise low grade of organization.

LITERATURE.—Recent discussions of the affinities of the Platyelminia will be found in (1) A. Sedgwick, *Textbook of Zoology* (1898), i. 212; (2) Hatschek, *Lehrbuch der Zoologie* (1891), pp. 316-326; (3) A. Lang, *Die Trophocel-Theorie* (Jena, 1903); (4) E. Ray Lankester, *Treatise on Zoology* (1900), pt. ii. Introduction and ch. vii. pp. 15-19; (5) A. A. W. Hubrecht, *Jenaische Zeitschrift für Naturwissenschaft* (1905), pp. 151-176; (6) Von Graff, *Die Acoela*, p. 519 (Leipzig, 1891). For the development of Rhabdocoela see (7) Bresslau, *Zeitschrift für wissenschaftliche Zoologie* (1904), vol. 76.

(F. W. GA.)

PLATYPUS. The duck-billed platypus (*Platypus anatinus*) was the name assigned to one of the most remarkable of known animals by George Shaw (1751-1813), who had the good fortune to introduce it to the notice of the scientific world in the *Naturalist's Miscellany* (vol. x., 1799). In the following year it was independently described by Blumenbach (*Voigt's Magazin*, ii. 205) under the name of *Ornithorhynchus paradoxus*. Shaw's generic name, although having priority to that of Blumenbach, could not be retained, as it had been used at a still earlier time (1793) by Herbst for a genus of Coleoptera. *Ornithorhynchus* (Gr. *ōpus*, *ōpυbos*, bird, and *βίρυχος*, bill) is therefore now universally adopted as the scientific designation, although duck-billed platypus (Gr. *πλατις*, flat, and *πός*, foot) may be conveniently retained as a vernacular appellation. By the colonists it is called "water-mole," but its affinities with the true moles are of the slightest and most superficial description.

The anatomical differences by which the platypus, and its only allies the echidnas, are separated from all other mammals, so as to form a distinct sub-class, are described in the article MONOTREMATA, where also will be found the main distinctive characters of the two existing representatives of the group. It is there stated that the early stages of the development of the young are not yet fully known. Sir R. Owen, and later E. B. Poulton, showed that the ovum of the platypus was large compared with that of other mammals, whilst W. H. Caldwell showed that it was filled with yolk, and finally established the fact that *Platypus* as well as *Echidna* is oviparous. Two eggs are produced at a time, each measuring about three-fourths of an inch in its long and half an inch in its short axis, and enclosed in a strong, flexible, white shell.

The platypus is pretty generally distributed in situations suitable to its aquatic habits throughout the island of Tasmania and the southern and eastern portions of Australia.

The length of the animal when full grown is from 18 to 20 in. from the extremity of the beak to the end of the tail, the male being slightly larger than the female. The fur is short, dense and rather soft to the touch, and composed of an extremely fine and close under-fur, and of longer hairs which project beyond this, each of which is very slender at the base, and expanded, flattened and glossy towards the free end. The general colour is deep brown, but paler on the under parts. The tail is short, broad and depressed, and covered with coarse hairs, which in old animals generally become worn off from the under



(From Gould's *Mammals of Australia*.)

Platypus.

surface. There are no true teeth in the adult, although the young possess a set which are shed after being worn down by friction with food and sand, their purposes being afterward served by horny prominences, two on each side of each jaw—those in the front narrow, longitudinal, sharp-edged ridges, and those behind broad, flattened and molariform. The upper surface of the lateral edges of the mandible has also a number of parallel fine transverse ridges, like those on the bill of a duck. In the cheeks are tolerably capacious pouches, which appear to be used as receptacles for food.

The limbs are strong and short, each with five well-developed toes provided with strong claws. In the fore feet the web not only fills the interspaces between the toes, but extends considerably beyond the ends of the long, broad and somewhat flattened nails, giving great expanse to the foot when used for swimming, though capable of being folded back on the palm when the animal is burrowing or walking on the land. On the hind foot the nails are long, curved and pointed, and the web extends only to their base. On the heel of the male is a strong, curved sharply pointed, movable horny spur, directed upwards and backwards, attached by its expanded base to the accessory bone of the tarsus. This spur, which attains the length of nearly an inch, is traversed by a minute canal, terminating in a fine longitudinal slit near the point, and connected at its base with the duct of a large gland situated at the back part of the thigh. The whole apparatus is so exactly analogous in structure to the poison-gland and tooth of a venomous snake as to suggest a similar function, and there is now evidence that it employs this organ as an offensive weapon.

The platypus is aquatic in its habits, passing most of its time in the water or close to the margin of lakes and streams, swimming and diving with the greatest ease, and forming for the purpose of sleeping and breeding deep burrows in the banks, which generally have two orifices, one just above the water level, concealed among long grass and leaves, and the other below the surface. The passage at first runs obliquely upwards in the bank, sometimes to a distance of as much as 50 ft., and

expands at its termination into a cavity, the floor of which is lined with dried grass and leaves, and in which, it is said, the eggs are laid¹ and the young brought up. Their food consists of aquatic insects, small crustaceans and worms, which are caught under water, the sand and small stones at the bottom being turned over with their bills to find them. They appear at first to deposit what they have thus collected in their cheek pouches, and when these are filled they rise to the surface and quietly triturate their meal with the horny teeth before swallowing it. Swimming is effected chiefly by the action of the broad forepaws, the hind feet and tail taking little share in locomotion in the water. When asleep they roll themselves into a ball, as shown in the figure. In their native haunts they are extremely timid and wary, and very difficult to approach, being rarely seen out of their burrows in the daytime. Mr A. B. Crowther, who supplemented the often quoted observations of Dr George Bennett upon the habits of these animals in confinement, states: "They soon become very tame in captivity; in a few days the young ones appeared to recognize a call, swimming rapidly to the hand paddling the water; and it is curious to see their attempts to procure a worm enclosed in the hand, which they greedily take when offered to them. I have noticed that they appear to be able to smell whether or not a worm is contained in the closed hand to which they swim, for they desisted from their efforts if an empty fist was offered." (W. H. F.; H. Sc.)

PLAUCEN, a town of Germany, in the kingdom of Saxony, on the Weisse Elster, 60 m. south of Leipzig, on the railway to Hof and Munich and at the junction of lines to Eger and Gera. Pop. (1890), 47,007; (1900), 73,891; (1905), 105,383. It was formerly the capital of Vogtland, or Voigtland, a territory governed by the imperial vogt, or bailiff, and this name still clings in popular speech to the hilly district in which the town lies. Of its three Evangelical churches the most prominent is the fine Gothic church of St John, with twin spires, which was restored in 1856. Other buildings of note are the town hall, dating from about 1550; and the old castle of Hradtschin, now used as a law court. Plauen is now the chief place in Germany for the manufacture of embroidered white goods of all kinds, for the finishing of woollen cotton fabrics, known as Plauen goods, and for the making of lace.

Plauen was probably founded by the Slavs. First mentioned in 1122, it passed under the authority of Bohemia in 1327 and came to Saxony in 1466, remaining permanently united with the electorate since 1569. The manufacture of white goods was introduced by Swabian, or Swiss, immigrants about 1570. The advance in its material prosperity has been especially rapid since the incorporation of Saxony in the German Zollverein.

See Fiedler, *Die Stadt Plauen im Vogtland* (Plauen, 1874); and *Beiträge zur Geschichte der Stadt Plauen* (Plauen, 1876); Metzner, *Führer durch Plauen* (1903); and the publications of the *Altertumsverein zu Plauen* (1875 seq.).

PLAUTUS, TITUS MACCIUS (originally perhaps *MACCUS*; cf. *Asin. Prol.* 11), the great comic dramatist of ancient Rome, was born at Sarsina in Umbria according to the testimony of Festus, who calls him *Umbro Sarsinas*, and Jerome. The date of his death was 184 B.C. (Cicero, *Brutus*, xv. 60). The date of his birth depends upon an inference based on the statement of Cicero (*De senectute*, xiv. 50) that he was an old man when he wrote his *Truculentus* and *Pseudolus*. The latter play was

¹ Some doubt has been expressed as to whether the eggs are extruded or hatched within the body. At a scientific meeting of the Zoological Society of London, on the 17th of December 1901, Mr Oldfield Thomas read a letter from Mr G. Metcalfe, who had lived many years in a region inhabited by these animals. He had made special inquiries of the authorities of the Sydney, Melbourne, Brisbane and Hobart museums, and published questions in the newspapers, but no evidence has reached him that the eggs of *Ornithorhynchus* have ever been obtained except by the dissection of the mother. Mr Thomas laid stress on what had been advanced on the other side by Mr Caldwell (*Philosophical Transactions*, clxxviii. 463). Professor Spencer (*Nature*, xxxi. 132) and Mr J. Douglas Ogilby (*Catalogue of Australian Mammals*, p. 1, Sydney, 1902), but expressed the hope "that further inquiries might be made by naturalists in Australia as to the actual finding of such eggs in the burrows, so that this most interesting point might be finally settled."

produced in 191 B.C.; hence we get 254-251 B.C. as the approximate date of his birth. The only record that we possess as to his life is that contained in Aulus Gellius iii. 3, 14 (based on Varro), the historical character of which is doubted by Leo (*Plautinische Forschungen*, p. 60, sqq.). According to this statement he left his native town at an early age and settled at Rome, where he got employment in a theatre, though it is not clear in what capacity. The words of Gellius in *operis artificum scenariorum*, are interpreted by F. Marx as indicating that Plautus was a member of the theatrical staff of Livius Andronicus. At Rome he saved a little money, and embarked on some mercantile enterprise, probably abroad. Having lost his money he returned to Rome penniless, and was driven to support himself by manual labour in a mill (*cum . . . ad circumagendas molas quae trusatiles appellantur operam pistori locasset*), and in this *pistrinum* he wrote three of his plays (the *Saturio*, the *Adductus* and another). The main body of his works belongs, so far as can be ascertained from the scanty evidence which we have, to the latter half of his life; 206 B.C. is the approximate date of the *Miles gloriosus*; cf. line 211 seq., *quos bins custodes . . . occubant* (present tense), which alludes to the imprisonment of Naevius, an event which cannot be proved to be earlier than 206 B.C. The defects of construction and the absence of "cantica" in the *Miles* also point to this as one of his early plays. On the other hand it is hardly likely that all his comedies (which greatly exceeded in number the extant twenty) were produced during the last twenty years of his life. Radermacher assigns the *Asinaria* to a date as early as 212 B.C. Of the extant plays the *Cistellaria* and the *Stichus* must be associated with the *Miles* as comparatively early works; for the former was clearly produced before (though not long before) the conclusion of the Second Punic War, see l. 201 seq.; and the *Stichus* is proved by its didascalia to have been produced in 200 B.C. The *Pseudolus* and the *Truculentus* fall within the last seven years of his life. The dates of the rest of the extant plays, here given in alphabetical order, are quite uncertain, namely, *Amphitruo*, *Aulularia*, *Bacchides*, *Captivi*, *Casina*, *Curculio*, *Epidicus*, *Menaechmi*, *Mercator* (probably later than the *Rudens*, as shown by F. Marx), *Mostellaria*, *Persa*, *Poenulus*, *Rudens*, *Trinummus* (later than 194 B.C.; cf. *novi aediles* in l. 990). Of the *Vidularia* we possess only the fragments contained in the Codex Ambrosianus.

The plays of Plautus are all based on Greek originals.¹ To what extent he is dependent on these originals, and how far he departed from them, we shall perhaps never know exactly. But such evidence as we have points to a pretty close imitation on the part of the Roman poet: there are passages in which he does not hesitate to take over from his originals allusions which can hardly have been intelligible to a Roman audience, e.g. the reference to Stratonice, a musician of the time of Alexander the Great (*Rudens*, 932); and in the delineation of character we have no reason to suppose that he improved on his models (cf. Aul. Gell. ii. 23). Even the prologues, which later researches have shown to be in the main by the hand of Plautus himself, though certain passages were clearly added at a later date, e.g. *Cas. prol.* 5-20, may in most cases have formed part of the Greek original. Plautus must therefore be regarded as primarily a translator or adapter, so far as our present knowledge goes. Where he varies his plot on lines of his own by amalgamating the plots of two distinct Greek comedies (e.g. in the *Miles* and the *Poenulus*) the result is generally not happy; and the romanization of the plays by way of allusions to towns in Italy, to the streets, gates and markets of Rome, to Roman magistrates and their duties, to Roman laws and the business of Roman law-courts, banks, comitia and senate, &c., involves the poet in all the difficulties of attempting to blend two different civilizations. The inconsistency of his attitude is shown by his use, side by side, of the contemptuous expressions *barbarus* (applied to the Romans) and *pergraeccari* (applied to the Greeks). In some passages the poet seems to take delight in casting dramatic illusion to the winds (e.g. *Pseudolus*, 720; *Poenulus*, 550).

¹See further P. E. Legrand, *Daes: tableau de la comédie grecque pendant la période dite nouvelle* (1910).

But as a translator Plautus is nothing less than masterly. His command of the art is such that his plays read like original works, and it may be at least said that some of his characters stand out so vividly from his canvas that they have ever served as representatives of certain types of humanity, e.g. Euclio in the *Aulularia*, the model of Molière's miser. Alliteration, assonance, plays upon words and happy coinages of new terms, give his plays a charm of their own. "To read Plautus is to be once for all disabused of the impression that Latin is a dry and uninteresting language" (Skutsch, in *Die Cultur der Gegenwart*; 1905). It is a mistake to regard the Latin of Plautus as "vulgar" Latin. It is essentially a literary idiom, based in the main upon the language of intercourse of the cultivated Roman society of the day (cf. Cic. *De oratore*, iii. 12, 45); though from the lips of slaves and other low persons in the plays we no doubt hear expressions which, while they are quite in keeping with the characters to whom they are allotted, would have shocked the ears of polite society in the 2nd century B.C.

The characters in his plays are the stock characters of the new comedy of Athens, and they remind us also of the standing figures of the *Fabulae attellanae* (Macrus, Bucco, Dossennus, &c.). We may miss the finer insight into human nature and the delicate touch in drawing character which Terence presents to us in his reproductions of Menander, but there is wonderful life and vigour and considerable variety in the Plautine embodiments of these different types. And the careful reader will take note of occasional touches of serious thought, as in the enumeration of the ten deadly political sins (*Persa*, 555 seq.) and allusions to ethical philosophy (*Pseud.* 972 seq.; *Stich.* 124; *Trin.* 305 sqq., 320 sqq., 363 seq., 447; *Rud.* 767, 1235-1248, &c.). Virtue is often held up for admiration, and vice painted in revolting colours or derided. The plots of Plautus also are more varied than those of Terence. We have from him one mythological burlesque, the *Amphitruo*, and several plays dealing with domestic subjects like the *Captivi*, *Cistellaria*, *Rudens*, *Stichus* and *Trinummus*; but most of his plays depend for their main interest on intrigue, such as the *Pseudolus*, *Bacchides*, *Mostellaria*. In the *Menaechmi* and, as a subordinate incident, in the *Amphitruo* we have a "comedy of errors."

In one respect Plautus must be regarded as distinctly original, viz. in his development of the lyrical element in his plays. The new comedy of Greece was probably limited for the most part to scenes written in the metres of dialogue; it remained for Plautus, as Leo has shown, to enliven his plays with *cantica* modelled on the contemporary lyric verse of Greece or Magna Graecia, which was in its turn a development of the dramatic lyrics of Euripides. A new light has been thrown on the *παρὰλαυειθρον* of the *Curculio* (147-155) by the discovery of the Alexandrian erotic fragment published by Grenfell and Hunt (Oxford, 1896). The lyrical metres of Plautus are wonderfully varied, and the textual critic does well not to attempt to limit the possibilities of original metrical combinations and developments in the Roman comedian. Recent investigation has considerably extended the list of his *numeri innumeri*.

Plautus was a general favourite in the days of republican Rome. Cicero, though he found fault with the iambs of the Latin comedians generally as *abieci*, "prosaic" (*Orator*, lv. 184), admired Plautus as *elegans, urbanus, ingeniosus, facetus* (*De offic.* l. 29, 104). To the fastidious critics of the Augustan age, such as Horace, he seemed rude (cf. *Ars Poetica*, 270-274), just as Addison declared Spenser to be no longer fitted to please "a cultivated age." In another passage (*Epist.* ii. 1, 170-176) Horace accuses him of clumsiness in the construction of his plays and the drawing of his characters, and indifference to everything excepting immediate success: *gestit enim nummum in loculos demittere, post hoc securus cadat an recto seti stabula talo*. That there are many inconsistencies and signs of carelessness in his work has been proved in detail by Langen. But that he found many admirers, even in the Augustan age, Horace himself bears witness (*ibid.* l. 58), where he says that Plautus was regarded as a second Epicharmus: *Plautus ad exemplar Siculi proferare Epicharmi*—a passage which is important as suggesting that

Plautus was under some obligation to the Sicilian representatives of the old Dorian comedy; cf. Varro's statement (in Priscian ix. 32), *deinde ad Siculos se applicavit*. It is possible that Plautus may have been working on the lines of the old comedy in the tell-tale names which he is so fond of inventing for his characters, such as Polymaerochoplages (*Pseud.* 988), Pyrgopolinices (*Mil.* 56), Thensaurachryonochrysidēs (*Capt.* 285)—names which stand in remarkable contrast to the more commonplace Greek names employed by Terence.

In the middle ages Plautus was little regarded, and twelve of his plays (*Bacchides-Truculentus*) disappeared from view until they were discovered (in the MS. called *D*) by Nicholas of Trèves in the year 1429. Apparently some early archetype had been divided into two volumes, of which only the first (containing eight plays, *Amphitruo-Epidicus*) had escaped oblivion or destruction. After the revival of learning Plautus was reinstated, and took rank as one of the great dramatists of antiquity; cf. Shakespeare, *Hamlet*, i. ii. 420, where Polonius says, "The best actors in the world . . . Seneca cannot be too heavy nor Plautus too light."

MANUSCRIPTS.—The chief MSS. of Plautus belong to two families, which are proved by the errors which they have in common to be descended from a single source (Sicker, "Novae quaestiones plautinae," in *Philologus* suppl. xi. 2; 1908): (i.) that represented by the fragmentary palimpsest of the Ambrosian Library at Milan (A, 4th century A.D.), discovered in 1815 by Cardinal Mai and now accessible in the *Apograph* of Studemund, edited by Seyffert (1889); (ii.) that represented by the Palatine MSS. (*P*, 10th-12th century), viz. *B*, now in the Vatican, containing all the twenty plays preceded by the spurious *Querolus*; *C*, now at Heidelberg, containing the last twelve plays, i.e. *Bacchides-Truculentus*; *D*, now in the Vatican, containing the *Amphitruo*, *Asinaria*, *Aulularia*, half of the *Capitini* and the last twelve plays to the same family belong the following less important MSS.: *E* (at Milan), *V* (at Leiden), *J* (in the British Museum), *O* (in the Vatican).

EDITIONS.—The *editio princeps*, based mainly on a transcript of *D*, was printed at Venice, 1472; the first scientific text, based on *B*, *C* and *D*, was that of Camerarius, completed 1552, in whose steps followed Lambinus (with a commentary which is still useful), 1576; Taubmann, 1605-1621; Pareus (a meritorious edition), 1619 and 1623; Guyet, edited by Marolles, 1658; Gronovius (the "Vulgate"), 1664-1684; then, after the lapse of more than a century, came the editions of Bothe, 1809-1811; Naudet, 1830; and Weise, 1837-1848. A new era began with the great critical edition of certain plays by Ritschl, 1848-1854, in which a collation of *A* was used; a revised and completed form of this work was commenced by Ritschl himself and continued by his disciples Goetz, Loewe and Schoell, 1871-1894; and of this an entirely rewritten *editio minor* by Goetz and Schoell appeared in 1893-1896 (continued by a 2nd ed. of Fasciculus ii. in 1904), which is still the most useful of modern editions for a critical study of the text, exhibiting, as it does, the MS. tradition with only such emendations as are securely established by the results of modern investigation. The other modern editions of the text are those of Fleckeisen (containing ten plays, excellent for his time), 1859; Using (with a commentary), 1875-1887, 2nd ed. of vol. iii. 1888; Leo (a very important work), 1895-1896; Lindsay, 1904-1905. Among modern editions of separate plays with commentaries the following are probably the most useful: *Amphitruo* by Palmer, 1890, and Havet, 1895; *Asinaria* by Gray, 1894; *Aulularia* by Wagner, 1866 and 1876; *Capitini* by Brix, 6th ed., revised by Niemeier, 1910; an English edition of this work by Sonnenschein (with introduction on prosody), 1880; same play by Lindsay (with metrical introduction), 1900; *Epidicus* by Gray, 1893; *Menaechmi* by Brix, 4th ed., revised by Niemeier, 1891; *Miles gloriosus* by Lorenz, 2nd ed., 1886; by Brix, 3rd ed., revised by Niemeier, 1901; by Tyrrell, 3rd ed., 1894; *Mostellaria* by Lorenz, 2nd ed., 1883; by Sonnenschein, 2nd ed., 1907; *Pseudolus* by Lorenz, 1876; *Rudens* by Sonnenschein, 1891, *editio minor* (with a metrical appendix), 1901; *Trinummus* (with a metrical introduction) by Brix, 5th ed., revised by Niemeier, 1907; by Gray, 1897; *Truculentus* by Spengel and Studemund, 1898.

CRITICISM.—Good characterizations of Plautus, from the literary point of view, are given by Sellar in his *Roman Poets of the Republic*, and Wight Duff, in his *Literary History of Rome* (1909). A summary of recent critical works bearing on the text and interpretation is given by Seyffert in his admirable reports (in Bursian's *Jahresberichte über die Fortschritte der klassischen Altertumswissenschaft*), 1883-1885, 1886-1889, 1890-1894, continued by Lindsay, 1895-1906. Important contributions to textual criticism are contained in Ritschl *Pareus* (1845), *Novae Plautinae Excursus* (1869), and his collected *Opuscula philologica*; Studemund, *Studia in prisca scriptores latinos* (vol. i. 1873, vol. ii. 1891); Langen, *Beiträge* (1877) and *Plautinische Studien* (1886); Leo, *Plautinische Forschungen* (1895); Lindsay, *Codex Turnebi* (1898). Bentley's *Plautine Emendations* were published by Sonnenschein partly in his edition

of the *Capitini* (1880), partly in the *Anecdota ronzoniensis seria* (1883).

METRE AND PROSODY.—The most important treatises (apart from those mentioned under "Editions") are Müller, *Plautinische Prosodie* (1869); Spengel, *Reformorschläge zur Metrik der lyrischen Versarten* (1882); Klotz, *Grundzüge altrömischer Metrik* (1890); Skutsch, *Forschungen zur lateinischen Grammatik und Metrik* (1892), *Jamben-kürzung und Synizesis* (Satura Viadrina) (1896), continued by the author in a work called *Päpas* (1903); Leo, *Die plautinischen Cantus und die hellenistische Lyrik* (1897); Ahrensbröcher, *Haatus und Verschleifung im alten Latein* (1899); Mühlberg, *De proceleusmaticis* (1900), *De correptione iambica plautina* (1901); Jacobsohn, *Quaestiones plautinae* (1904); Radford, on the "Recession of the Latin Accent" (in *Amer. Journ. Phil.*, 1904), "Studies in Latin Accent and Metric" (in *Trans. Amer. Phil. Assoc.*, 1904), "Plautine synizesis" (ibid., 1905, continued in *Amer. Journ. Phil.*, 1906, (a work on cognate subjects is promised by Exon); Sudhaus, *Der Aufbau der plautinischen Cantica* (1909).

SYNTAX.—The most recent works bearing on Old Latin syntax, are Sjögren, *Zum Gebrauch des Futurums im Allateinischen* (1906); Lindsay, *Syntax of Plautus* (1907); Sonnenschein, *The Unity of the Latin Subjunctive* (1910). A work by H. Thomas, entitled *A catalogue raisonné of the Subjunctive in Plautus, in support of the theory of the unity of origin of the Latin Subjunctive*, is announced as in preparation.

LEXICA.—The only completed lexicon (apart from the *Indices* of Naudet, 1832, and Weise, 1838) is that of Pareus (2nd ed., 1634). New lexica have been begun by Waltzing (1900; apparently not to be continued) and Lodge (1901; in progress). The latter work, when completed, will be indispensable.

TRANSLATIONS AND ADAPTATIONS.—A comprehensive view of the influence of Plautus on modern literatures is given by Reinhardt-stoetter, *Spätere Bearbeitungen plautinischer Lustspiele* (1886). Many adaptations for the Italian stage were produced between the years 1486 and 1550, the earliest (the *Menaechmi*) under the direction of Ercole I., duke of Ferrara. From Italy the practice spread to France, Spain, England and other countries.

Of English plays, the interlude called *Jack Juggler* (between 1547 and 1553) was based on the *Amphitruo*, and the lost play called the *Historie of Error* (acted in 1577) was probably based on the *Menaechmi*; Nicholas Udall's *Ralph Royster Doyster*, the first English comedy (acted before 1551, first printed 1566), is founded on the *Miles gloriosus*; Shakespeare's *Comedy of Errors* (about 1591) is an adaptation of the *Menaechmi*; and his Falstaff may be regarded as an idealized reproduction or development of the braggart soldier of Plautus and Terence—a type of character which reappears in other forms not only in English literature (e.g. in Shakespeare's Parolles and Ben Jonson's Captain Bobadil) but also in most of the literatures of modern Europe. Shakespeare's *Taming of the Shrew* has been influenced in several respects (including the names *Tranio* and *Grumio*) by the *Mostellaria*. Ben Jonson produced a skilful amalgamation of the *Aulularia* and the *Capitini* in his early play *The Case is Altered* (written before 1599). Thomas Heywood adapted the *Amphitruo* in his *Silvanus* (c. 1613); the *Rudens* in his *Capitius* (licensed 1624); and the *Mostellaria* in his *English Traveller* (1633). Dryden's *Amphitruo* or the *two Sosias* (1690) is based partly on the *Amphitruo*, partly on Molière's adaptation thereof; Fielding's *Miser* (acted 1732) on Molière's *L'Ancre* rather than on the *Aulularia*, and his *Intriguing Chambermaid* (acted 1733) on Regnard's *Le Retour imprévu* rather than on the *Mostellaria*. There was no English translation, strictly so called, of any play of Plautus in the 16th or 17th century, except that of the *Menaechmi* by W. W. (probably William Warner), first printed in 1595, which Shakespeare may possibly have used (in MS.) for his *Comedy of Errors*. A translation of the whole of Plautus in "familiar blank verse" by Bonnell Thornton and others appeared in 1767 (2nd ed., 1769-1774). Five plays have been translated in the metres of the original by Suggden (1893) (E. A. So.)

PLAY, a word of which the primary meaning is that of free or active movement or exercise. The O. Eng. *plegan* or *plegas*, from which comes the substantive *plega*, play, is apparently cognate with Ger. *pflegen*, to take care or charge of, and *plegen*, care, and the connexion in sense is to be found in the primary meaning, that of exercise or active movement. In its primary meaning "play" is used of the rapid changing movement of light and colour, and also figuratively of thought or fancy, and specifically of the free movement of parts of a mechanism on each other, of a joint or limb, &c. To play a musical instrument is to move the fingers upon it, and until the 18th century the verb was intransitive, and "on" or "upon" was always used with the name of the instrument. The very general use of the word for sport, game or amusement, is an early and easy development from the meaning of active movement or exercise as a recreation after work; that of a dramatic performance (see **DRAMA**) is very early; the *New English Dictionary* quotes from King Alfred's *Orosius* (c. 893).

The primitive play instinct or play impulse in man has been much discussed in recent years by psychologists in connexion with childhood (see CHILD), and with the expression of the emotions (see J. Sully, *On Laughter*, 1902, &c.; also AESTHETICS). See generally Carl Groos, *The Play of Animals* (1898) and *The Play of Man* (1901); and Baldwin's *Dict. of Philosophy*, s.v.

PLAYA (a Spanish word meaning "shore"), the name applied in America to a level plain formed of the deposits of a river which has no outlet to the sea or a lake. If at seasons of high water a river floods any area and temporarily converts it into a lake, which subsequently dries up in hot weather, the tract thus left dry is called a playa. The barren Black Rock Desert in north-western Nevada, about 100 m. in length by 15 in breadth, is typical.

PLAYFAIR, JOHN (1748-1819), Scottish mathematician and physicist, was born at Benvie, Forfarshire, where his father was parish minister, on the 10th of March 1748. He was educated at home until the age of fourteen, when he entered the university of St Andrews. In 1766, when only eighteen, he was candidate for the chair of mathematics in Marischal College, Aberdeen, and, although he was unsuccessful, his claims were admitted to be high. Six years later he made application for the chair of natural philosophy in his own university, but again without success, and in 1773 he was offered and accepted the living of the united parishes of Liff and Benvie, vacant by the death of his father. He continued, however, to carry on his mathematical and physical studies, and in 1782 he resigned his charge in order to become the tutor of Ferguson of Raith. By this arrangement he was able to be frequently in Edinburgh, and to cultivate the literary and scientific society for which it was at that time specially distinguished; and through Maskelyne, whose acquaintance he had first made in the course of the celebrated Schiehallion experiments in 1774, he also gained access to the scientific circles of London. In 1785 when Dugal Stewart succeeded Ferguson in the Edinburgh chair of moral philosophy, Playfair succeeded the former in that of mathematics. In 1802 he published his celebrated volume entitled *Illustrations of the Huttonian Theory of the Earth*. To its publication the influence exerted by James Hutton on the progress of geological knowledge is largely due. In 1805 he exchanged the chair of mathematics for that of natural philosophy in succession to Dr John Robison, whom also he succeeded as general secretary to the Royal Society of Edinburgh. He took a prominent part, on the Liberal side, in the ecclesiastical controversy which arose in connexion with Leslie's appointment to the post he had vacated, and published a satirical *Letter* (1806) which was greatly admired by his friends. He was elected F.R.S. in 1807. He died in Edinburgh on the 20th of July 1819.

A collected edition of Playfair's works, with a memoir by James G. Playfair, appeared at Edinburgh in 4 vols. 8vo. His writings include a number of essays contributed to the *Edinburgh Review* from 1804 onwards, various papers in the *Phil. Trans.* (including his earliest publication, "On the Arithmetick of Impossible Quantities," 1779, and an "Account of the Lithological Survey of Schiehallion," 1811) and in the *Transactions of the Royal Society of Edinburgh* ("On the Causes which affect the Accuracy of Barometrical Measurements," &c.), also the articles "Aepinius" and "Physical Astronomy," and a "Dissertation on the Progress of Mathematical and Physical Science since the Revival of Learning in Europe," in the *Encyclopaedia Britannica* (Supplement to fourth, fifth and sixth editions). His *Elements of Geometry* first appeared in 1795 and have passed through many editions; his *Outlines of Natural Philosophy* (2 vols., 1812-1816) consist of the propositions and formulae which were the basis of his class lectures. Playfair's contributions to pure mathematics were not considerable, his paper "On the Arithmetic of Impossible Quantities," that "On the Causes which affect the Accuracy of Barometrical Measurements," and his *Elements of Geometry*, all already referred to, being the most important. His lives of Matthew Stewart, Hutton, Robison, many of his reviews, and above all his "Dissertation" are of the utmost value.

PLAYFAIR, LYON PLAYFAIR, 1st BARON (1818-1898), was born at Chunar, Bengal province, on the 21st of May 1818. He was sent to Europe by his father at an early age, and received his first education at St Andrews. Subsequently he studied medicine at Glasgow and Edinburgh. A short visit to India (in 1837-1838) was followed by his return to Europe to study

chemistry, which had always attracted him. This he did at University College, London, and afterwards under Liebig at Giessen, where he took his doctor's degree. At Liebig's request, Playfair translated into English the former's work on the *Chemistry of Agriculture*, and represented Liebig at a meeting of the British Association at Glasgow. The outcome of his studies was his engagement in 1841 as chemical manager of the Primrose print-works at Clitheroe, a post which he held for rather more than a year. In 1843 he was elected honorary professor of chemistry to the Royal Institution of Manchester, and soon afterwards was appointed a member of the Royal Commission on the Health of Towns, a body whose investigations may be said to have laid the foundations of modern sanitation. In 1846 he was appointed chemist to the geological survey, and thenceforward was constantly employed by the public departments in matters of sanitary and chemical inspection. The opportunity of his life came with the 1851 Exhibition, of which he was one of the special commissioners. For his services in this connexion he was made C.B., and his work had the additional advantage of bringing him into close personal relations with the Prince Consort, who appointed him gentleman usher in his household. From 1856 to 1869 he was professor of chemistry at Edinburgh University. In 1868 he was elected to represent the universities of Edinburgh and St Andrews in parliament, and retained his seat till 1885, from which date until 1892 he sat as member for Leeds. In 1873 he was made postmaster-general, and in the following year, after the dissolution of parliament, was applied to by the incoming Tory government to preside over a commission to inquire into the working of the civil service. Its report established a completely new system, which has ever since been officially known as the "Playfair scheme." The return of Mr Gladstone to power in 1880 afforded opportunity for Playfair to resume his interrupted parliamentary career, and from that time until 1883 he acted as chairman of committees during a period when the obstructive tactics of the Irish party were at their height. On his retirement from the post he was made K.C.B. In 1892 he was created Baron Playfair of St Andrews, and a little later was appointed lord-in-waiting to the queen. In 1895 he was given the G.C.B. In spite of failing health the last years of his life were full of activity, one of his latest public acts being his suggestion that Queen Victoria's Diamond Jubilee of 1897 should be commemorated by the completion of the South Kensington Museum. He died in London, after a short illness, on the 29th of May 1898, and was buried at St Andrews. He was three times married. He was the author of a number of papers on scientific and social topics, a selection from which he published in 1889 under the title of *Subjects of Social Welfare*.

A memoir by Sir Wemyss Reid was published in 1899.

PLEADING (Fr. *plaidier*, *plaidoyer*), the term applied in English law to the preparation of the statement of the facts on which either party to a criminal prosecution or a civil action founds his claim to a decision in his favour on the questions involved in the proceeding; and also to the document in which these statements are embodied. The term "pleadings" is used for the collected whole of the statements of both parties; the term "pleading" for each separate part of the pleadings. The term "plea" (*placitum*, *plaid*)¹ is now applied in England oftener to the defence made by an accused person. To "plead" is to make a pleading or plea.²

All systems of law agree in making it necessary to bring the grounds of a claim or defence before the court in a more or less definite and technical form.

Roman System.—In Roman law the action passed through three stages (see ACTION), and the manner of pleading changed with the action. In the earliest historical period, that of the *legis actiones*, the pleadings were verbal, and made in court by the parties themselves, the proceedings imitating as far as possible the natural

¹ In Scots and ecclesiastical law the word "plea" is used as to the statements of both parties to a cause.

² In French law *plaidier* and *plaidoyer* are still applied to the oral arguments of counsel, and in English popular speech "to plead" has much the same sense.

conduct of persons who had been disputing, but who suffered their quarrel to be appraised (Maine, *Ancient Law*, ch. x.). The use of technical language in pleading at an early date came to be regarded as so important that, as Gaius tells us, the party who made even the most trifling mistake would lose his suit. This excessive reverence for formality is a universal characteristic of archaic law. In the second period, that of the procedure by *formulae*, the issue which the *iudex* decided was made up by the *praetor* in writing from the statements of the parties before him. The *formula* was a short summary of the facts in dispute in technical language, with instructions to the *iudex*, and corresponded to what would now be called the submission or terms of reference to an arbitrator chosen by the parties. The part of the *formula* which contained the plaintiff's claim was called the *intentio*. Any equitable defence included in the *formula* was set up by means of an *exceptio*, which was either peremptory, denying the right of the plaintiff to recover at all, or dilatory, denying only that the action could be brought at the time or by the particular plaintiff. The plaintiff might meet the *exceptio* by a *replicatio*, the defendant on his side might set up a *duplicatio*, and the plaintiff might traverse the *duplicatio* by a *triplicatio*. The parties might proceed even further, but beyond this point the pleadings had no special names. Actions *bonae fidei* implied every *exceptio* that could be set up; in other actions the *exceptio* must be specially pleaded. From the *formula* the *iudex* derived his whole authority, and he was liable to an action for exceeding it. He could not amend the *formula*: that could only be done by the *praetor*. In the third period the *formula* did not exist, the plaintiff's claim appeared in the summons (*libellus contentiosis*), and the defendant might take any defence that he pleased, all actions being placed on the footing of actions *bonae fidei*. The issue to be tried was determined by the judge from the oral statements of the parties.

English System.—The English system of pleading seems to have drawn largely from, if it was not directly based upon, the Roman. Bracton (*temp.* Henry III.) uses many of the Roman technical terms. Pleading was oral as late as the reign of Henry VIII., but in the reign of Edward III. pleadings began to be drawn up in writing, perhaps at first more for the purpose of entry on the court records than for the instruction of the court (see 2 Reeves, *History of English Law*, p. 398). The French language was used until 1362, after which English was used for oral pleading, but Latin for enrolment, except for a short period during the Commonwealth. Latin was the language of written pleadings at common law until 1731. The period of the Roman *formula* has its analogue in the period of the original writ in England.¹ The writ was at first a formal commission from the Crown to a judicial officer to do justice between the parties, the claim being made by a count (*conte*, narrative). The issue of the writ was part of the prerogative of the Crown, unlimited until the Provisions of Oxford (1258) forbade the issue of fresh writs except "writs of course" (*de cursu*) without the consent of the council. Gradually the writ came to absorb the count and included the plaintiff's claim and sometimes the nature of his evidence. The defendant pleaded to the writ. The writ became the universal form of instituting proceedings in the king's court, irrespective of the method of trial which followed, and probably grew fixed in form about the reign of Henry II. (see Biglow, *History of Procedure*, ch. iv.). At a later date the writ again tended to approach its earlier form and to split into two parts—the writ of summons and the declaration or plaintiff's claim. The writ of summons was addressed to the defendant, and not, as the original writ, to a judicial officer. The pleadings became the act of the party, differing in this from Roman law, in which they were a judicial act. The writs became precedents for the forms of action, which, like the writs, were limited in number. The plaintiff's declaration was a substantial repetition of the writ. In the writ, as in the *formula*, the slightest failure in form was as a rule fatal. "The assigning of a writ of a particular frame and scope to each particular cause of action, the appropriating process of one kind to one action and of a different kind to another, these and the like distinctions rendered proceedings very nice and complex, and made the conduct of an action a matter of considerable difficulty" (1 Reeves, *Hist. of English Law*, p. 147). Fines were levied for mistakes in pleading, non-liability to which was sometimes granted by charter as a

¹ The original writ was so called to distinguish it from the judicial writ, which was a part of the process of the court. The judicial writs still exist, e.g. writs of *certiorari* or *ferri facias*.

special privilege to favoured towns. In both Roman and English law fictions, equity and legislation came to mitigate the rigour of the law. In England this result was largely attained by the framing of the action of trespass on the case under the powers of the Statute of Westminster the Second (1285), and by the extension of the action of *assumpsit* to non-feasance. The difficulties and technicalities of the common law system were met by elaboration of what is known as "special pleading," which became an art of the utmost nicety, depending on numerous rules, some of them highly technical (see Coke upon Littleton, p. 303). Those who made it their business to frame pleadings were called special pleaders. They were not necessarily members of the bar, but might be licensed to practise under the bar. At one time it was usual to practise for a time as a special pleader before call to the bar. Such licences are now rarely sought, and the *Law List* of 1906 contained only one name of a special pleader who was not a barrister. The art became necessary because of the absolute particularity with which claims must be framed, and the narrowness of the powers of amendment possessed by the courts. The result was that substantive law was smothered in procedure, and the practical questions at issue were of less moment than the phraseology in which they were to be stated. As an extreme instance, a learned judge in the 19th century challenged a pleading for putting the year without adding A.D., on the ground that "non constat that A.C. might not be intended."

Some of the difficulties as to amendment were removed by the statutes of Jeofails (*J'ai failli*) beginning in 1340. But until the 19th century the courts of common law and equity worked side by side in Westminster Hall, administering each their own system without due regard to the other; and even in so simple a matter as the right of a defendant to set off against a claim on him a debt due to him from the plaintiff required statutory provision. Many of the defects and technicalities of the common law system were removed by the Common Law Procedure Acts and the general rules of practice made thereunder. Wide powers of amendment were given, and the parties were allowed to raise and try claims which theretofore could have been dealt with only in courts of equity. In the court of chancery the pleadings used were bill (or in certain public matters an information by the attorney-general), answer and replication.² Demurrers were used, or "exceptions" could be taken to the bill or answer. They differed from the common law forms by being much more diffuse, by pleading matters of evidence, and in that the answer was on oath. Beyond the replication chancery proceedings did not go, the place of further pleadings being supplied by amendment. Exceptions might be taken to the bill or answer on various grounds. Equity pleadings were signed by counsel. On the creation of the divorce court the pleadings authorized were (and still are) as follows: petition (which must be verified by oath), answer (which is so verified if it goes beyond a mere denial) and reply; and a special pleading called "act on petition" (derived from the ecclesiastical courts) with answer thereto, generally used for the determination of some preliminary question in the suit, e.g. the domicile of the husband. In the court of admiralty the pleadings used were petition, answer, reply and conclusion. In the probate court the common law terms were used (declaration, plea and replication), but the procedure was not the same as in the common law courts.

Under the old common law system⁴ as modified in the 19th century the pleadings in use were as follows:—

1. Declaration, made up of one or more counts (*contes*), or modes of framing the plaintiff's claim so as to state his grievances in fact in a form suggesting the appropriate remedy at law, and concluding by demand for a plea. The counts were spoken of as common or special according as the facts of the case allowed the use of common

² The ingenuity of the pleader showing itself chiefly in framing special as opposed to general pleas, the term "special pleading" grew to be used for the whole proceedings of which it was the most important part.

³ In Chancery the "English Bill," so called from its being in the English language, had existed, according to G. Spence, as early as the reign of Henry V. (*Equitable Jurisdiction*, i. 348).

⁴ Bullen and Leake, *Precedents of Pleading* (3rd ed., 1868).

forms or required special statement. The declaration corresponds to the Roman *formula* and *intentio*.

2. Plea by the defendant to the counts of the declaration. The plea corresponds to the Roman *exceptio*.

3. Replication by the plaintiff to the plea. In this pleading the plaintiff usually took issue upon the statements in the defence; but he might do what was termed "new assign," e.g. complain of acts in excess of a justification alleged in the plea.

4. Rejoinder by the defendant to the replication, answering to the Roman *duplicatio*.

5. Surrejoinder by the plaintiff to the rejoinder, answering to the Roman *triplicatio*.

6. Rebutter by the defendant to the surrejoinder.

7. Surrebutter by the plaintiff to the rebutter.

Nos. 4, 5, 6 and 7 were rarely necessary, as the parties usually came to a definite issue on the facts in the replication, and the last of them is only kept in legal memory because Lord Wensleydale (the last and best versed of the old common law pleaders) was nicknamed Chief Baron Surrebutter. At any stage of the pleadings after (1), the party might instead of pleading to the preceding document demur, i.e. admit the facts as therein stated and contend that assuming the truth of those facts the document was insufficient in law to found a claim or a defence as the case might be. Demurrers (q.v.) were general or special according as they went to the substance of the claim or plea or to a mere defect in the mode of statement. When the pleadings had reached a stage at which the parties were in flat contradiction on matters of fact, they concluded by joinder of issue, upon which the record was made up and the action was ripe for trial.

Pleas fell into the following classes—

1. In abatement, also described as temporary or dilatory (terms of Roman law), directed either to the jurisdiction of the court or to the abatement or defeat of the action for defects of form.

2. In bar, also described as peremptory, which answered the alleged cause of action by denying facts stated in the declaration which were material, or by confessing their truth, but stating new matter of fact which destroyed their legal effect.

Some of these were by way of justification or excuse, e.g. by setting up the truth of matter alleged to be defamatory, or legal warrant for an arrest complained of as illegal; others were by way of discharge, e.g. of an alleged debt by payment.

Pleas in denial were known (a) as general traverses or general issues, when they denied in a general and appropriate form one or more of the facts alleged (e.g. "never indebted") to a claim in assumpsit or "not guilty" to a claim for tort; (b) as specific traverses of separate and material allegations in the declaration, setting out with particularity the facts relied on.

It was permissible to plead alternatively, i.e. to set up a number of different answers to the facts on which the claim was based. As a general rule a plea must be "issuable," i.e. must put the merits of the cause in issue on the facts or the law, so that the decision of judge and jury thereon would put an end to the action upon the merits.

All the above forms of pleading, except in matrimonial causes, were abolished by the Judicature Acts, and a new system was set up by these acts and the rules of the Supreme Court. Under this system the pleadings proper are "statement of claim," "defence," "reply," and, if need be, "rejoinder."

When pleadings are allowed they must contain, and contain only, a statement in a summary form of the material facts on which the party pleading relies for his claim or defence, as the case may be, but not the evidence by which they are to be proved; and must, when necessary, be divided into paragraphs, numbered consecutively. Dates, sums and numbers are expressed in figures and not in words. Signature of counsel is not necessary; but where pleadings have been settled by counsel or a special pleader they are to be signed by him, and if not so settled they are to be signed by the solicitor or by the party if he sues or defends in person (O. 19, r. 4).¹ There has been a growing disposition to dispense with formal pleadings in the simpler kinds of action. A plaintiff is allowed to proceed to trial without pleadings if the writ of summons is endorsed in a manner sufficient to indicate the nature of his claim and the relief or remedy which he seeks (O. 18a), and contains a notice of his intention. In no case is a statement of claim other than that endorsed on the writ necessary unless the defendant on appearance asks for one, and his right to insist has been cut down by the provisions presently to be stated. In commercial cases a statement by the parties to the points of law and fact which they propose to raise is substituted for ordinary pleadings. In cases where

¹ Before the Judicature Acts equity pleadings were signed by counsel, but common law pleadings were not.

the demand is for a liquidated sum certain, or to recover land from a tenant on expiration of his term or its forfeiture for non-payment of rent, the statement of claim must be endorsed on the writ; and in all other cases no statement of claim beyond that on the writ may be delivered except under order of the master or judge at chambers (Ords. 18a and 30). A statement of defence may not be delivered except under order made on the summons for directions (which must be taken out immediately after the appearance of the defendant in answer to the writ), nor a reply without special leave. The result of the present practice is to substitute "particulars," i.e. specific statement of the details which the parties intend to prove, for the more general terms in which pleadings were formerly framed.

Besides the rules applicable to all pleadings, there are certain rules specially relating to statements of claim, with reference to the nature of the causes of action which may be included and the relief which may be claimed (O. 20). As to the defence proper, there are also special rules intended to prevent evasive, inadequate or unnecessary contradiction of the plaintiff's statements (O. 19, 20). The defendant is allowed to "set off" against the claim sums due to him from the plaintiff or to raise by way of counter-claim any right or claim against the plaintiff or a third party, whether "sounding" as damages or not. The counter-claim is in substance a conjoined action in which the defendant is plaintiff and the plaintiff or third party affected may put in a defence to it. Except in such a case the reply and subsequent pleadings are now seldom permitted. Both the parties and the court or a judge have large powers of amending the pleadings both before and at the trial. Issues are in certain cases settled by the court or a judge. Demurrers are abolished, and a party is now entitled to raise by his pleading any point of law. Where decision of a point of law would put an end to the action steps may be taken for obtaining such decision so as to obviate the necessity of trying the issues of fact raised on the pleadings. Forms of pleading are given in Appendices C, D and E to the *Supreme Court Rules*. In all actions such ground of defence or reply as if not raised would be likely to take the opposite party by surprise, or would raise issues of fact not arising out of the preceding pleadings, must be specially pleaded. Such are compulsory pilotage, fraud, the Statute of Limitations, the Statute of Frauds and the Gaming Act. The *Supreme Court Rules* do not apply to proceedings in Crown suits or in the Crown side of the king's bench division. In actions for damages by collision between ships each party must as a general rule file a sealed document called a *preliminary act* containing details as to the time and place of collision, the speed, tide, lights, &c. The case may be tried on the preliminary act without pleadings, but if there are pleadings the act may not be unsealed until they are completed and certain consents given. The document was peculiar to the court of admiralty, but may now be used in all divisions of the High Court (O. 19, r. 28). The High Court system of pleadings has been adopted in the chancery courts of the counties palatine of Lancaster and Durham. The place of the "record" is supplied by copies of the pleadings delivered for the use of the judge and of the officer entering the judgment (O. 36, r. 30; O. 41, r. 1).

In the county courts proceedings are commenced by a *plaint*, followed by an *ordinary* or *default summons*. No "pleadings" are necessary, but the defendant is precluded from setting up certain special defences such as set-off or infancy, or statutory defences, without the consent of the plaintiff, unless he has given timely notice in writing of his intention to set up the special defence. This system is made workable by insisting on the insertion of adequate details or particulars of the nature of the claim in the *plaint*. But in cases where a special defence is not required considerable inconvenience is caused by uncertainty as to the line of defence.

In some of the local civil courts of record which have survived the creation of the county courts, the pleadings are still in the form recognized by the Common Law Procedure Acts. This is the case in the Mayor's Court of London. In others (e.g. the Liverpool Court of Passage and the Salford Hundred Court) the system of the Judicature Acts has been adopted with or without official sanction. The policy of the lord chancellor and the treasury has been to refuse reform of procedure to all but the most used of these local courts so as to extinguish them in favour of the county courts.

In the ecclesiastical courts the statements of the parties are called generally *pleas*. The statement of the plaintiff in civil suits is called a *libel*; of the promoter in criminal suits *articles*. Every subsequent plea is called an *allegation*. To the responsive allegation of the defendant the promoter may plead a counter-allegation. The cause is concluded when the parties renounce any further allegation. There exists in addition a more short and summary mode of pleading called an *act on petition*.

In Roman criminal procedure the indictment (*inscriptio* or

libellus accusationis) was usually in writing, and contained a formal statement of the offence. In some cases oral accusations were allowed. The pleading of the accused *Criminal* seems to have been informal. In English criminal cases the expression "pleadings" is limited to those tried on indictment or information before a jury. In matters dealt with by justices of the peace there are informations sometimes in writing, but they are never regarded as "pleadings." English criminal pleading has been less affected by legislation than civil pleading, and retains more of what is called the common law system. Cases in which the Crown was a party early became known as "pleas of the Crown" (*placita coronae*), as distinguished from "common pleas" (*communis placita*), or pleas between subject and subject—that is to say, ordinary civil actions. Pleas of the Crown originally included all matters in which the Crown was concerned, such as exchequer cases, franchises and liberties, but gradually became confined to criminal matters, strictly to the greater crimes triable only in the king's courts. In criminal pleading the Crown states the case in an *indictment* or *information*. The answer of the accused is a *plea*, which must be pleaded by the accused in person, except in certain cases of misdemeanour tried in the High Court (*Crown Office Rules*, 1906). The plea, according to Blackstone, is either to the jurisdiction, a demurrer, in abatement, special in bar, or the general issue. The last is the only plea that often occurs in practice; it consists in the answer (usually oral) of "guilty" or "not guilty" to the charge. A demurrer is strictly not a plea at all, but an objection on legal grounds. Pleas to the jurisdiction or in abatement do not go to the merits of the case, but allege that the court has no jurisdiction to try the particular offence, or that there is a misnomer or some other technical ground for stay of proceedings. The powers of amendment given in 1851 (14 & 15 Vict. c. 100) and the procedure by motion in arrest of judgment have rendered these pleas of no practical importance. The special pleas in bar are *autrefois convict* or *autrefois acquit* (alleging a previous conviction or acquittal for the same crime) and pardon (see PARDON). The plea of *autrefois attainé* has fallen out of use since the abolition of attainder by the Forfeitures Act 1870. There are also special pleas of justification to indictments for defamatory libel under the Libel Act 1843; and to indictments for non-repair of highways and bridges the accused may plead that the liability to repair falls upon another person. These special pleas are usually, and in some cases must be, in writing. When there is a special plea in writing the Crown puts in a *replication* in writing.

Ireland.—The practice as to civil and criminal pleading in Ireland is substantially the same as in England, though to some extent based on different statutes and rules of court.

Scotland.—In Scotland an action in the Court of Session begins by a *summons* on the part of the pursuer, to which is annexed a *condescendence*, containing the allegations in fact on which the action is founded. The *pleas in law*, or statement of the legal rule or rules relied upon (introduced by the Court of Session Act 1825), are subjoined to the *condescendence*. The term *libel* is also used (as in Roman law) as a general term to express the claim of the pursuer or the accusation of the prosecutor. The statement of the defender, including his pleas in law, is called his *defences*. They are either dilatory or peremptory. There is no formal joinder of issue, as in England, but the same end is attained by adjustment of the pleadings and the closing of the record. Large powers of amendment and revival are given by the Court of Session Act 1868. In the sheriff court pleadings are very similar to those in the Court of Session. They are commenced by a *petition*, which includes a *condescendence* and a note of the pursuer's pleas in law. The defender may upon notice lodge *defences*. The procedure is now governed by the Sheriff Courts Scotland Act 1876. The term "pleas of the Crown" is confined in Scotland to four offences—murder, rape, robbery and fire-raising. The criminal procedure of Scotland was simplified and amended in 1887. The old procedure by criminal letters has been abolished, and prosecutions for the public interest whether in the high court of justiciary or before the sheriff with a jury are by indictment in the name of His Majesty's advocate. The Scots indictment differs from the English in not being found by a grand jury, except in cases of high treason, and resembles rather the *ex officio* information of English law. Until 1887 it was in the form of a syllogism, the major proposition stating the nature of the crime, the minor the actual offence committed and that it constitutes the crime named in the major, the

conclusion that on conviction of the panel he ought to suffer punishment. Under the present practice it is in the second person addressed to the accused, and follows the forms scheduled to the act of 1887, which also makes specific provisions for simplification, and if need be for amendment (s. 70). A copy of the indictment with a list of the witnesses and the productions must be served on the accused. There are two sittings (diets) to deal with the indictment. At the first, held before the sheriff, the accused (unless the panel) may plead guilty or raise preliminary objections to the relevancy of the indictment, &c., or otherwise (such as want of jurisdiction or *res judicata*); or without taking such objections, or after they are overruled, may plead not guilty. The second diet is the diet of trial. If the trial is before the sheriff his ruling at the first diet are final, if before the court of justiciary his rulings may be reviewed. At the second diet, besides his plea of not guilty, the panel may rely on certain special defences, e.g. insanity or alibi, but only if his special and written plea was tendered and recorded at the first diet or the delay explained, and he cannot call evidence in support of these pleas except on written notice specifying the names of the witnesses and the documents not included in the prosecutor's lists (s. 36). (See Macdonald, *Criminal Law of Scotland*.)

British Dominions Beyond Seas.—In most of the Australian states, and in Ontario and New Zealand, civil pleadings are governed by rules adopted from the English Judicature Acts. In New South Wales a system based on the Common Law Procedure Act is retained. Civil pleadings in India are regulated by the Civil Procedure Code. Indictments, except in India, are based on the English system as modified by the criminal codes or other legislation of the colony. Indictments in India are regulated by the Criminal Procedure Code of 1898.

United States.—In the United States two systems of pleading in civil procedure exist side by side. Up to 1848 the pleading did not materially differ from that in use in England at the same date. But in 1848 the New York legislature made a radical change in the system, and the example of New York has been followed by many states. The New York Civil Code of 1848 established a uniform procedure called the civil action, applicable indifferently to common law and equity. The pleadings are called *complaint*, *answer* (which includes *counterclaim*) and *reply*. The *demurrer* also is still used. In some states which follow this procedure the complaint bears the name of *petition*. In inferior courts, such as courts of justices of the peace, the pleadings are more simple, and in many cases oral. In states which do not adopt the amended procedure the pleading is much the same as it was in the days of Blackstone, and the old double jurisdiction of common law and equity still remains. Criminal pleading is on the lines of the common law system of England. (W. F. C.)

PLEASURE (through Fr. *plaisir* from Lat. *placere*, to please; Gr. *ἡδονή*), a term used loosely in ordinary language as practically synonymous with "enjoyment." As such it is applied equally to what are known as the "higher" or "intellectual" pleasures, and to purely "sensual," "animal" or "lower" pleasures. The conditions under which a man is pleased are the subject both of psychological and of ethical investigation. In general it may be said that pleasure and pain follow respectively upon the success of the failure of some effort, mental or physical (see *PSYCHOLOGY*); they may also attend upon purely passive sensations, e.g. a warm sun, a heavy shower, or upon associations with previous states of mind (i.e. a man may enjoy a sensation which is intrinsically painful, if it has pleasant associations). Recognition of the fact that mankind seeks pleasure and avoids pain has led some moralists to the conclusion that all human conduct is actuated by hedonic considerations: this is the direct antithesis to ethical theories which maintain an absolute criterion of right and wrong (see *HEDONISM*; *ETHICS*). Aristotle took a middle view, holding that pleasure, though not the end of virtuous action yet necessarily follows upon it (*ἡρετὸν ἄριστον τὸ εὖ εἶναι*).

PLEBISCITE (Lat. *plebiscitum*, a decree of the *plebs*), a term borrowed from the French for a vote of all the electors in a country taken on some specific question (see also *REFERENDUM*). The most familiar example of the use of the plebiscite in French history was in 1852, when the *comp. d'état* of 1851 was confirmed and the title of emperor was given to Napoleon III. In Roman constitutional law the *plebiscitum* was a decree enacted in the assembly of the *plebs*, the *comitia tributa*, presided over by a plebeian magistrate.

PLEBS (from the root seen in Lat. *plenus*, full; cf. Gr. *πλήθος*), the "multitude," or unprivileged class in the early Roman state. For the origin and history of this order see *PATRICIANS* and *NOBILITY*. Its disqualifications were originally based on

descent; but after the political equalization of the two orders the name was applied to the lower classes of the population without reference to their descent. Under the empire the word is regularly used of the city proletariat, or of the commons as distinct from knights and senators.

PLEDGE, or **PAWN**, in law "a bailment of personal property as a security for some debt or engagement" (Story on *Bailments*, § 286). The term is also used to denote the property which constitutes the security. Pledge is the *pignus* of Roman law, from which most of the modern law on the subject is derived. It differs from hypothec and from the more usual kind of mortgage in that the pledge is in the possession of the pledgee; it also differs from mortgage in being confined to personal property. A mortgage of personal property in most cases takes the name and form of a bill of sale. The chief difference between Roman and English law is that certain things, e.g. wearing apparel, furniture and instruments of tillage, could not be pledged in Roman law, while there is no such restriction in English law. In the case of a pledge, a special property passes to the pledgee, sufficient to enable him to maintain an action against a wrongdoer, but the general property, that is the property subject to the pledge, remains in the pledgor. As the pledge is for the benefit of both parties, the pledgee is bound to exercise only ordinary care over the pledge. The pledgee has the right of selling the pledge if the pledgor make default in payment at the stipulated time. No right is acquired by the wrongful sale of a pledge except in the case of property passing by delivery, such as money or negotiable securities. In the case of a wrongful sale by a pledgee, the pledgor cannot recover the value of the pledge without a tender of the amount due.

The law of Scotland as to pledge generally agrees with that of England, as does also that of the United States. The main difference is that in Scotland and in Louisiana a pledge cannot be sold unless with judicial authority. In some of the American states the common law as it existed apart from the Factors' Acts is still followed; in others the factor has more or less restricted power to give a title by pledge.

See also **FACTOR** and **PAWNBROKING**.

PLEHVE, VIATSCHELAF KONSTANTINOVICH (1846-1904), Russian statesman, was born of Lithuanian stock in 1846. He was educated at Warsaw and studied law at the university in St. Petersburg before he entered the bureaucracy in the department of justice, in which he rose rapidly to be assistant solicitor-general in Warsaw, then solicitor-general in St. Petersburg, and in 1881 director of the state police. As assistant to the minister of the interior he attracted the attention of Alexander III. by the skill he showed in investigating the circumstances of the assassination of Alexander II. He received the title of secretary of state in 1894, became a member of the council of the empire, and in 1902 succeeded Sipiaguine as minister of the interior. Plehve carried out the "russification" of the alien provinces within the Russian Empire, and earned bitter hatred in Poland, in Lithuania and especially in Finland. He despoiled the Armenian Church, and was credited with being accessory to the Kishinev massacres. His logical mind and determined support of the autocratic principle gained the tsar's entire confidence. He opposed commercial development on ordinary European lines on the ground that it involved the existence both of a dangerous proletariat and of a prosperous middle class equally inimical to autocracy. He was thus a determined opponent of M. de Witte's policy. An attempt was made on his life early in 1904, and he was assassinated on the 28th of July of the same year by a bomb thrown under his carriage, as he was on his way to Peterhof to make his report to the tsar; the assassin, Sazonov, was a member of the fighting organization of the socialist revolutionary party.

PLEIAD (Gr. Πλειάδες), in Greek literature, the name given (by analogy from PLEIADES, below) by the Alexandrian critics to seven tragic poets who flourished during the reign of Ptolemy

¹The word "pledge" is adapted from the O. Fr. *plege*, mod. *pleige*, security, hostage, Med. Lat. *plivium*. This is a formation from Med. Lat. *plivare* or *plivare*, to undertake or engage for someone, cf. "replevin"; it is now considered to be a word of Teutonic origin and connected with Ger. *pflegen* and "plight."

Philadelphus (285-247 B.C.). In French literature, in addition to the Pleiad of Charlemagne, there were two famous groups of the kind. The first, during the reign of Henri III. (1574-1589), the chief member of which was Pierre de Ronsard, sought to improve the French language and literature by enthusiastic imitation of the classics; the second, under Louis XIII. (1610-1643), consisted of authors who excelled in the composition of Latin verse.

PLEIADES, in Greek mythology, the seven daughters of Atlas and Pleione, and sisters of the Hyades. Owing to their grief at the death of their sisters or at the sufferings of their father, they were changed into stars. In another account, the Pleiades and their mother met the hunter Orion in Boeotia, and the sight of them inflamed his passion. For five years he pursued them through the woods, until Zeus translated them all—Pleione and her daughters, Orion, and his dog—to the sky. The Pleiades rose in the middle of May and set at the end of October, and their connexion with spring and autumn explains the legend. As bringers of the fertilizing rains of spring, which have their origin in the west, they are the daughters of Atlas; as the forerunners of the storms of autumn, they are represented as being driven onward by Orion in pursuit. The word is probably connected with *πλεωω*, either in the sense of "many in number," since the stars formed a close group, resembling a bunch of grapes (hence sometimes called *βόρπος*), or as "more in number" than their sisters. Others derive the name from *πλεῖν* (to sail), because navigation began at the time of their rising. They are probably alluded to in Homer (*Odyssey*, xii. 62) as the doves (*πλειάδες*) who brought ambrosia from the west to Zeus. One of these doves was always lost during the passage of the *Planctae* (wandering rocks), referring to the fact that one of the seven Pleiades was always invisible. This was Merope, who hid her light from shame at having had intercourse with a mortal, Sisyphus. All the Pleiades became the ancestresses of divine or heroic families. They were called Vergiliae (probably connected with *ver*, spring) by the Romans.

See Hesiod, *Works and Days*, 383; Apollodorus iii. 10; Diod. Sic. iii. 60; Theocritus xiii. 25; Hyginus, *Astronom.* ii. 21; Ovid, *Fasts*, iv. 169, v. 599.

PLEIADES, **ATLANTIDES** or **VERGILIAE**, in astronomy, a group of stars situated in the constellation Taurus. They are supposed to be referred to in the Old Testament (Job. ix. 9, xxxviii. 31).—This group is particularly rich in bright stars, and is full of nebulosity, but there are fewer faint stars than in equal areas of the surrounding sky; the central star is Alcyone (3rd magnitude); Pleione and Atlas are also of the 3rd magnitude.

PLEISTOCENE, in geology, the epoch which succeeded the Pliocene; it is the last of the Tertiary periods, and hence the lower subdivision of the quaternary or modern era. The name was introduced by Sir C. Lyell in 1839 (from Gr. *πλειστόν*, most, and *καινός*, recent), the rocks of this period containing a higher percentage of living forms than the youngest of the Tertiary formations. By many writers "Pleistocene" has been regarded as synonymous with "Glacial Period" or the "Diluvium" of some geologists. In the northern hemisphere the protracted period of glaciation, with its predominating influence upon modern topography and faunal distribution, was undoubtedly the outstanding feature of the time. The phenomena of the Glacial period (*g.p.*), which was by no means strictly limited to the northern latitudes, are dealt with under that head, but there are certain other characteristics of the Pleistocene period which bear no direct relationship to glaciation, and these will be dealt with here.

The gradual inception of colder conditions in the northern hemisphere which lead up to the more extreme conditions of glaciation clearly began in the latter part of the Pliocene period, and the effects of this cooling are seen not only in northern Europe and America but as far south as the Mediterranean. The result of this is that there is a certain indefiniteness as to the exact base line to be adopted for the Pleistocene formations; thus the Forest Bed of Cromer and certain beds in Sicily and Italy are by some authors placed in this period and by others

in the Pliocene (q.v.). Again it is clear that in parts of northern Europe, Siberia and North America, the conditions characteristic of a glacial period are still existent; even in Scotland and Norway the last traces of glacial action are remarkably fresh, and the last remnants of great glacial centres still linger in the Alps and other lofty southern mountains. Many of the formations of this period can be shown by their fossil contents to belong to early quaternary time, but since so many of these deposits are strictly local in character, and since the fauna and flora present in any one spot have been determined by local geographical conditions which have assisted or retarded the migration of certain forms, it is a matter of extreme difficulty—one may say impossibility—to reduce the Pleistocene formations to any generally applicable chronological order. For similar reasons it is impossible to define strictly the upper limit of the formations of this period, and to say where the Pleistocene ends and where the Recent or Holocene period begins.

The composition and distribution of the Pleistocene fauna and flora present many points of extreme interest. The feature of greatest importance is that man existed somewhere and in some condition before and in this period; but no really satisfactory proof has so far been forthcoming which will set back his first appearance before the beginning of the glacial period (*Pithecanthropus erectus* found by E. Dubois in Java is regarded as of Pliocene age). The presence of the remains of man or of his works might reasonably be taken as a criterion of the Pleistocene age of a deposit—if we omit the remains of historical time. But here again it has to be borne in mind that historical time is continually being set back by archaeological research, and further, the difficulty of employing artefacts of stone as chronological indicators is shown by the fact that even at the present day implements of stone are still in use, and that different local races of early men must have been in diverse stages of development in Pleistocene as in later ages. It is, therefore, only with the utmost caution that chronological subdivisions of the period, such as those mentioned below, based upon the form and degree of finish of stone implements, can be used in anything but local correlations unless the evidence is supported by satisfactory fossils.

Next to the appearance of man the most striking characteristic of the land fauna was the existence of numerous large-bodied mammals; *Elephas antiquus*, for instance, attained a more excessive bulk than any other proboscidean either before or since, the woolly rhinoceros, the great hippopotamus, the cave bear, cave lion and giant deer were all larger than their living representatives. No less striking is the disappearance of these large forms together with highly specialized creatures such as *Machaerodus* within the same period, through the action of the same causes which had removed the bulky and specialized reptiles of an earlier geological period. The Pleistocene mammalia of Europe include *Elephas antiquus*, *E. primigenius* (mammoth), *R. antiquitatis* (*Ucharkhinus*) (the woolly rhinoceros), *R. mercki* (especially in Silesia), *R. leptorhinus* (south-east Europe), *Elasmotherium* (Silesia and south Russia), *Hippopotamus major*, *Bos primigenius* (aurochs, extinct in historical time), *Bison priscus*, *Bison europaeus* (still living in the Caucasus and Lithuania), *Bos* (*Bubalus*) *pallasi* (north Europe), camels in south Russia and Rumania, *Equus fossilis* and varieties, *Cervus* (*Megaceros*) *giganteus* (= *hibernicus*) (the great Irish "elk" and its varieties); *Cervus elaphus*, *C. alces*, *Rangifer tarandus* and *R. groenlandicus* (reindeer), *Capreolus caprea*, *Capra ibex*, *Saiga tatarica*, *Ovis moschatus*, *Felis spelaeus*, *Hyaena spelaea*, *Ursus spelaeus*, badger, weasel, glutton, hare, lemming (*Myodes torquatus* and *M. lemmus*), *Spermophilus*, *Alactaga*, *Arctomys*, *Castor fiber*, *Lagomys*, *Trogontherium*. In North America there were numerous mammals common to Europe and North Asia, including the musk-ox, mammoth and horse; the mastodon held on into this period in America but not in Europe; there were also llamas, tapirs, camels (*Camelus archaicus*), *Machaerodus*, *Myiodon*, *Procyon*, *Aleas*. In South America there was at first a very characteristic endemic fauna including *Megatherium*, *Myiodon*, *Grypotherium*, *Zastodon*, *Toxodon*, *Tylotherium*, *Glyptodon*, *Macrauchenia*, *Capibara*, *Rhea*, to which were added later, *Mastodon*, *Machaerodus*, *Lama* and other North American forms. In Australia a very distinct assemblage of large marsupials and monotremes lived in the Pleistocene period; including *Phascolus*, *Diprotodon*, *Thylacolea*, *Nototherium* and a large extinct *Echidna*; placental mammals were not then known in this region. In Madagascar the *Acepiornis*, *Megaladapis*, and certain extinct lemurid creatures have left their remains.

The advance and retreat of glacial conditions in northern latitudes had a marked influence upon animal and plant life, and was the means of determining the present distribution of many of the living mammalia and plants; some were driven permanently southward, some northern forms still live isolated on the higher mountain regions, others like the reindeer and musk-ox returned northward as soon as the conditions permitted. The apparently curious admixture of what are now often regarded as tropical or sub-tropical

forms (lion, hyena, rhinoceros and elephants) with cold-temperate or arctic genera, presents no real difficulty, since their distribution was doubtless merely a matter of food supply; and some of these, like the woolly rhinoceros and mammoth, were provided with a thick hairy pelt.

Although in the main the arrangement of land and sea was little different from that which obtains at the present time, one or two features existed in the Pleistocene period which had a considerable influence on faunal migration. For instance, the absence of the Bering Straits permitted free communication between Europe and North America, and the absence of the Straits of Dover allowed a similar interchange between Great Britain and France; while an extension of the sea in the Caspian region and of the Arctic Sea in northern Russia acted as a bar to free passage between Europe and Asia in those regions.

The formations of Pleistocene age, other than those of direct glacial origin, include deposits on the floors of caves in limestone and dolomitic rocks, calcareous sinter (travertine or tufa) formed by springs, ancient river and lake alluvial and lacustrine terraces, elevated marine beaches, submerged forests, ancient lake deposits and peat beds, laterite, loess and sand dunes.

Some of the prevalent styles of classifying the deposits of the glacial formations of this period are mentioned in the article GLACIAL PERIOD. The following subdivisions are often employed by European geologists: a younger division, Reindeer time = Magdalénien¹ stage; a middle division, Mammoth time = Chelles² stage; and an older division, *Elephas antiquus* time = Chelles³ stage. While some authors include all the above in the "glacial period," others would place the Magdalénien in a post-glacial division. The terms Magdalénien, &c., are really archaeological, based upon the characters of the implements found in the deposits, and like the similar terms "eolithic" and "palaeolithic" they are of little value in geological chronology unless they are supported by palaeontological evidence.

See E. Geinitz, *Das Quartär von nord Europa* (Stuttgart, 1904), with very full references; T. C. Chamberlin and R. D. Salisbury, *Geology*, vol. iii. (New York, 1906), for references to American authorities. (J. A. H.)

PLEONASM (Gr. *πλεονασμός*, from *πλεονάζω*, to abound or be superfluous, *πλεον*, comparative of *πολύς*, many, great, large, redundancy or superfluity in speaking or writing, hence an unnecessary word or phrase. The word, more usually in the Latin form "pleonasmus," is used in pathology of an abnormal growth or formation.

PLESIOSAURUS, an extinct marine reptile belonging to the Order Sauropterygia, which characterized the Mesozoic period and had an almost world-wide distribution (see REPTILIA). The animal is best known by nearly complete skeletons from the Liás of England and Germany. It was named *Plesiosaurus* (Gr. more-lizard) by W. D. Conybeare in 1821, to indicate that it was much more nearly a normal reptile than the strap-

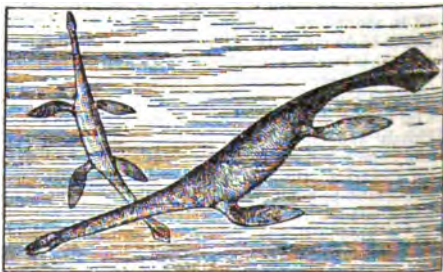

(From a memoir by Professor W. Dames in the *Abhandlungen der k. preuss. Akad. d. Wiss.*)

Plesiosaurus guilelmi-imperatoris, restored.

Ichthyosaurus, which had been found in the same Liassic formation a few years previously. It has a small head, a long and slender neck, a round body, a very short tail, and two pairs of large, elongated paddles. The snout is short, but the gape of the mouth is wide, and the jaws are provided with a series of conical teeth in sockets, much like those of the living garial

¹ Magdalénien from the caves of Madelaine, Périgord.

² Salutré, Bourgogne.

³ Chelles, near Paris. Other subordinate stages are the Messinien from Moustier, Dordogne, and Acheulean, Saint Acheul.

of Indian rivers. The neck, though long and slender, must have been rather stiff, because the bodies of the vertebrae are nearly flat-ended, while they bear short ribs: it could not have been bent in the swan-fashion represented in many restorations. The other vertebrae are similarly almost flat-ended and firmly united, but there is no sacrum. The ribs are single-headed, and in the middle of the trunk, between the supports of the paired limbs, they meet a dense plastron of abdominal ribs. The short tail is straight and rapidly tapering, but one specimen in Berlin suggests that it was provided with a rhomboidal flap of skin in a vertical plane. The bones in the ventral wall of the body which support the paired limbs are remarkably expanded, and those of the pectoral arch have often been compared with the corresponding bones of turtles. The limbs are elongated paddles, with five complete digits, of which the constituent bones (phalanges) are unusually numerous. The only traces of skin hitherto discovered suggest that it was smooth. The reptile must have been almost exclusively aquatic, feeding on cuttle-fishes, fishes and other animal prey. It propelled itself chiefly by the paddles, scarcely by the tail.

The typical species is *Plesiosaurus dolichodeirus*, from the Lower Lias of Lyme Regis, which attains a length of about three metres. Other species from the same formation seem to have measured five to six metres in length, and there are species of allied genera from the Upper Lias which are probably still larger. A fine large skeleton from the Upper Lias of Württemberg, now in the Berlin Museum, is named *Plesiosaurus gueldmiperatoris* (see figure above). *Cryptocidius*, known by complete skeletons from the Oxford Clay of Peterborough, differs very little from *Plesiosaurus*. The Cretaceous *Cimoliosaurus*, found in North and South America, Europe and New Zealand, is also very similar. The fossilized contents of the stomach in some of the later Plesiosaurs show that these reptiles swallowed stones for digestive purposes like the existing crocodiles.

REFERENCES.—R. Owen, *Fossil Reptiles of the Liassic Formations*, pt. iii. (Monogr. Palaeont. Soc., 1865); W. Dames, paper in *Abhandl. d. preuss. Akad. Wiss.* (1895), p. 1. (A. S. Wo.)

PLEURISY, or PLEURITIS (Gr. πλερον=ribs), Inflammation of the pleura, caused by invasion by certain specific micro-organisms. (See RESPIRATORY SYSTEM: Pathology.) Secondary pleuritis may occur from extension of inflammation from neighbouring organs.

The morbid changes which the pleura undergoes when inflamed consist of three chief conditions or stages of progress. (1) Inflammatory congestion and infiltration of the pleura, which may spread to the tissues of the lung on the one hand, and to those of the chest wall on the other. (2) Exudation of lymph on the pleural surfaces. This lymph is of variable consistence, sometimes composed of thin and easily separated pellicles, or of extensive thick masses or strata, or again showing itself in the form of a tough membrane. It is of greyish-yellow colour, and microscopically consists mainly of coagulated fibrin along with epithelial cells and red and white blood corpuscles. Its presence causes roughening of the two pleural surfaces, which, slightly separated in health, may now be brought into contact by bands of lymph extending between them. These bands may break up or may become organized by the development of new blood vessels, and adhering permanently may obliterate throughout a greater or less space the pleural sac, and interfere to some extent with the free play of the lungs. (3) Effusion of fluid into the pleural cavity. This fluid may vary in its characters.

The chief varieties of pleurisy are classified according to the variety of the effusion, should effusion take place. (1) Some pleuritis do not reach the stage of effusion, the inflammation terminating in the exudation of lymph. This is termed *dry pleurisy*. (2) Fibrinous or plastic pleurisy. In this variety the pleura is covered by a thick layer of granular, fibrinous material. Fibrinous pleurisy is usually secondary to acute diseases of the lung such as pneumonia, cancer, abscess or tuberculosis. (3) Sero-fibrinous pleurisy. This is the most common variety, and produces the condition commonly known as pleurisy with effusion. The amount may vary from an

almost inappreciable quantity to a gallon or more. When large in quantity it may fill to distension the pleural sac, bulge out the thoracic wall externally, and compress the lung, which may in such cases have all its air displaced and be reduced to a mere fraction of its natural bulk. Other organs, such as the heart and liver, may in consequence of the presence of the fluid be shifted away from their normal position. In favourable cases the fluid is absorbed more or less completely and the pleural surfaces again may unite by adhesions; or, all traces of inflammatory products having disappeared, the pleura may be restored to its normal condition. When the fluid is not speedily absorbed it may remain long in the cavity and compress the lung to such a degree as to render it incapable of re-expansion as the effusion passes slowly away. The consequence is that the chest wall falls in, the ribs become approximated, the shoulder is lowered, the spine becomes curved and internal organs permanently displaced, while the affected side scarcely moves in respiration. Sometimes the unabsorbed fluid becomes purulent, and an *empyema* is the result.

The symptoms of pleurisy vary; the onset is sometimes obscure but usually well marked. It may be ushered in by rigors, fever and a sharp pain in the side, especially on breathing. Pain is felt in the side or breast, of a severe cutting character, referred usually to the neighbourhood of the nipple, but it may be also at some distance from the affected part, such as through the middle of the body or in the abdominal or iliac regions. On auscultation the physician recognizes sooner or later "friction," a superficial rough rubbing sound, occurring only with the respiratory acts and ceasing when the breath is held. It is due to the coming together during respiration of the two pleural surfaces which are roughened by the exuded lymph. The pain is greatest at the outset, and tends to abate as the effusion takes place. A dry cough is almost always present, which is particularly distressing owing to the increased pain the effort excites. At the outset there may be dyspnoea, due to fever and pain; later it may result from compression of the lung.

On physical examination of the chest the following are among the chief points observed: (1) On inspection there is more or less bulging of the side affected, should effusion be present, obliteration of the intercostal spaces, and sometimes elevation of the shoulder. (2) On palpation with the hand applied to the side there is diminished expansion of one-half of the thorax, and the normal vocal fremitus is abolished. Should the effusion be on the right side and copious, the liver may be felt to have been pushed downwards, and the heart somewhat displaced to the left; while if the effusion be on the left side the heart is displaced to the right. (3) On percussion there is absolute dullness over the seat of the effusion. If the fluid does not fill the pleural sac the floating lung may yield a hyper-resonant note. (4) On auscultation the natural breath sound is inaudible over the effusion. Should the latter be only partial the breathing is clear and somewhat harsh, with or without friction, and the voice sound is aegophonic. Posteriorly there may be heard tubular breathing with aegophony. These various physical signs render it impossible to mistake the disease for other maladies the symptoms of which may bear a resemblance to it, such as pleurodynia.

The absorption or removal of the fluid is marked by the disappearance or diminution of the above-mentioned physical signs, except that of percussion dullness, which may last a long time, and is probably due in part to the thickened pleura. Friction may again be heard as the fluid passes away and the two pleural surfaces come together. The displaced organs are restored to their position, and the compressed lung re-expanded. Frequently this expansion is only partial.

In most instances the termination is favourable, the acute symptoms subsiding and the fluid (if not drawn off) becoming absorbed, sometimes after reaccumulation. On the other hand it may remain long without undergoing much change, and thus a condition of *chronic pleurisy* becomes established.

Pleurisy may exist in a latent form, the patient going about for weeks with a large accumulation of fluid in his thorax, the

ordinary acute symptoms never having been present in any marked degree. Cases of this sort are often protracted, and their results unsatisfactory as regards complete recovery.

In the treatment of early pleurisy, pain may be relieved by a hypodermic of morphia or the application of leeches. A purgative is essential. Fixation of the affected side of the thorax by strapping with adhesive plaster gives great relief. The ice-bag is useful in the early stages, as in pneumonia. The open-air treatment of cases is recommended, as the majority of the cases are of tuberculous origin. When effusion has taken place, counter irritation and the exhibition of iodide of potassium are useful. Dry diet and saline purgatives have been well spoken of. The most satisfactory method of treatment is *early* and if necessary repeated aspiration of the fluid. The operation (*thoracentesis*) was practised by ancient physicians, but was revived in modern times by Armand Trousseau (1801-1867) in France and Henry I. Bowditch (1808-1892) in America, by the latter an excellent instrument was devised for emptying the chest, which, however, has been displaced in practice by the still more convenient aspirator. The chest is punctured in the lateral or posterior regions, and in most cases the greater portion or all of the fluid may be safely drawn off. In many instances not only is the removal of distressing symptoms speedy and complete, but the lung is relieved from pressure in time to enable it to resume its normal function.

In cases of chronic pleurisy after the failure of repeated aspirations, Samuel West reports well of free incision and drainage. He has reported cases of recovery of effusion, fifteen or eighteen months standing. Sir James Barr has advocated the treatment of these cases by the withdrawal of the fluid and the substitution of sterilized air and solution of supra-renal extract; others have introduced physiological salt solution or formalin solution into the cavity, after the removal of the fluid. Vaquez injects nitrogen into the cavity and reports a number of cases in which it prevented recurrence.

PLEURO-PNEUMONIA, or LUNG-PLAGUE, a contagious disease peculiar to cattle, generally affecting the lungs and the lining membrane of the chest, producing a particular form of lobar or lobular pleuro-pneumonia, and, in the majority of cases, transmitted by the living diseased animal, or, exceptionally, by mediate contagion. It cannot be communicated to animals other than those of the bovine race. Inoculation of healthy cattle with the fluid from the diseased lungs produces, after a certain interval, characteristic changes at the seat of inoculation, and though it does not develop the lung lesions always observed in natural infection, yet there is a local anatomical similarity or identity. Though numerous investigations have been made, the nature of the infective agent remains doubtful. In 1888 Arloing, of Lyons, described various bacilli obtained from the lesions, but the pathogenic organism of lung-plague has not been discovered.

The earliest notices of this disease testify that it first prevailed in central Europe, and in the 18th century it was present in certain parts of southern Germany, Switzerland and France, and had also appeared in upper Italy. Though Valentine described an epizooty occurring among cattle in 1693 in Hesse, doubts have been entertained as to whether it was this malady. It was not until 1769 that it was definitely described as prevailing in Franche-Comté by the name of "muric." From that date down to 1789 it appears to have remained more or less limited to the Swiss mountains, the Jura, Dauphiné and Vosges, Piedmont and upper Silesia; it showed itself in Champagne and Bourbonnais about the time of the Revolution, when its spread was greatly accelerated by the wars that followed. In the 19th century its diffusion was accurately determined. It invaded Prussia in 1802, and soon spread over north Germany. It was first described as existing in Russia in 1824; it reached Belgium in 1827, Holland in 1833, the United Kingdom in 1841, Sweden in 1847, Denmark in 1848, Finland in 1850, South Africa in 1854, the United States—Brooklyn in 1843, New Jersey in 1847, Brooklyn again in 1850 and Boston in 1850; it was also carried to Melbourne in 1858, and to New South Wales in 1860; New

Zealand and Tasmania received it in 1864, but it was eradicated in both countries by the sanitary measures adopted. It was carried to Asia Minor, and made its presence felt at Damascus. It prevails in various parts of China, India, Africa and Australia, and until quite recently it existed in every country in Europe, except Scandinavia, Holland, Spain and Portugal. In Great Britain cases occurred in 1897.

Symptoms—The malady lasts from two to three weeks to as many months, the chief symptoms being fever, diminished appetite, a short cough of a peculiar and pathognomonic character, with quickened breathing and pulse, and physical indications of lung and chest disease. Towards the end there is great debility and emaciation, death generally ensuing after hectic fever has set in. Complete recovery is rare.

The pathological changes are generally limited to the chest and its contents, and consist in a peculiar marbled-like appearance of the lungs on section, and fibrous deposits on the pleura membrane, with oftentimes great effusion into the cavity of the thorax.

Willems of Hasselt (Belgium) in 1852 introduced and practised inoculation as a protective measure for this scourge, employing for this purpose the lymph obtained from a diseased lung. Since that time inoculation has been extensively resorted to, not only in Europe, but also in Australia and South Africa, and its protective value has been generally recognized. When properly performed, and when certain precautions are adopted, it would appear to confer temporary immunity from the disease. The usual seat of inoculation is the extremity of the tail, the virus being introduced beneath the skin by means of a syringe or a worsted thread impregnated with the lymph. Protection against infection can also be secured by subcutaneous or intravenous injection of a culture of Arloing's pneumo-bacillus on Martin's bouillon, and by intravenous injection of the lymph from a diseased lung, or from a subcutaneous lesion produced in a calf by previous inoculation.

PLEVNA (Bulgarian *Pleven*), the chief town of the department of Plevna, Bulgaria; 85 m. N.E. of Sofia, on the Tutchiniza, an affluent of Vid, which flows north into the Danube and on the Sofia-Varna railway (opened in 1890). Pop. (1906), 21,208. A branch line, 25 m. long, connects Plevna with Samovit on the Danube, where a port has been formed. After the events of 1877, it was almost entirely forsaken by the Turks, and most of the mosques have gone to ruin; but, peopled now mainly by Bulgarians, it has quite recovered its prosperity, and has a large commerce in cattle and wine.

Battles of 1877—Plevna, prior to the Russo-Turkish War of 1877 (see RUSSO-TURKISH WARS) a small and unknown town without fortifications became celebrated throughout the world as the scene of Osman Pasha's victories and his five months' defence of the entrenched camp which he constructed around the town, a defence which upset the Russians' plans and induced them to devote their whole energies to its capture. Osman Pasha left Vidin on the 13th of July with a column consisting of 19 battalions, 6 squadrons and 9 batteries, a total of 12,000 men and 54 guns. Hearing that he was too late to relieve Nikopol, he pushed on to Plevna, where there was a garrison of 3 battalions and 4 guns, under Atouf Pasha.

Passing through Plevna on the afternoon of the 19th of July he at once took up a position, previously selected by Atouf Pasha, on the hills covering the town to the north and east. The column had been joined *en route* by 3 battalions from the banks of the Danube, so that Osman's command now consisted of 25 battalions. He was none too soon. General Schilder-Schuldner, commanding the 5th division of the ^{The First} IX. corps, which had just captured Nikopol, had ^{Battle of} been ordered to occupy Plevna, and his guns were ^{Plevna.} already in action. The Turkish batteries came into action as soon as they arrived and returned the fire. A desultory artillery duel was carried on till nightfall, but no attack was made by the Russians on the 19th. Osman distributed his troops in three sections: on the Janik Bair, facing north, were 13 battalions and 4 batteries, with advanced posts of 2 battalions

and 1 battery each, at Opanetz and Bukova, facing east and north-east, 5 battalions and 10 guns were posted on the eastern end of the Janik Bair; to the hills south of the Bulgareni road 4 battalions and 2 batteries were allotted, and on either side of the road, under cover, in rear of them, most of the cavalry was placed. The remaining troops formed a general reserve, which was posted on the hill just east of the town. The hills to the north and east of Plevna were perfectly bare. The Turks had covered the 115 m. from Vidin in seven days, in trying heat, and were exhausted, but a few trenches were thrown up. On the 20th of July at 5 a.m., having made no preliminary reconnaissance, the Russian commander brought his guns into action, and, after a short bombardment, advanced his infantry

sent a force of 6 battalions and 1 battery under Rifaat Pasha to occupy Levcha (Lovatz), where they entrenched themselves.

The Plevna garrison now numbered 20,000 (35 battalions, 8 squadrons, 57 guns and 400 mounted irregulars), who were organized in two wings with a general reserve. Adil Pasha commanded the left wing consisting of 12 battalions, 3 batteries and 2 squadrons, and held the ground from the Vid bridge to Grivitza, Hassan Sabri Pasha commanded the right wing, of equal strength, covering from Grivitza to the south. The remainder, as general reserve, was posted on the crest and slopes of the hill east of the town, with one battalion in Plevna itself. The west front was not fortified till October. Trenches were

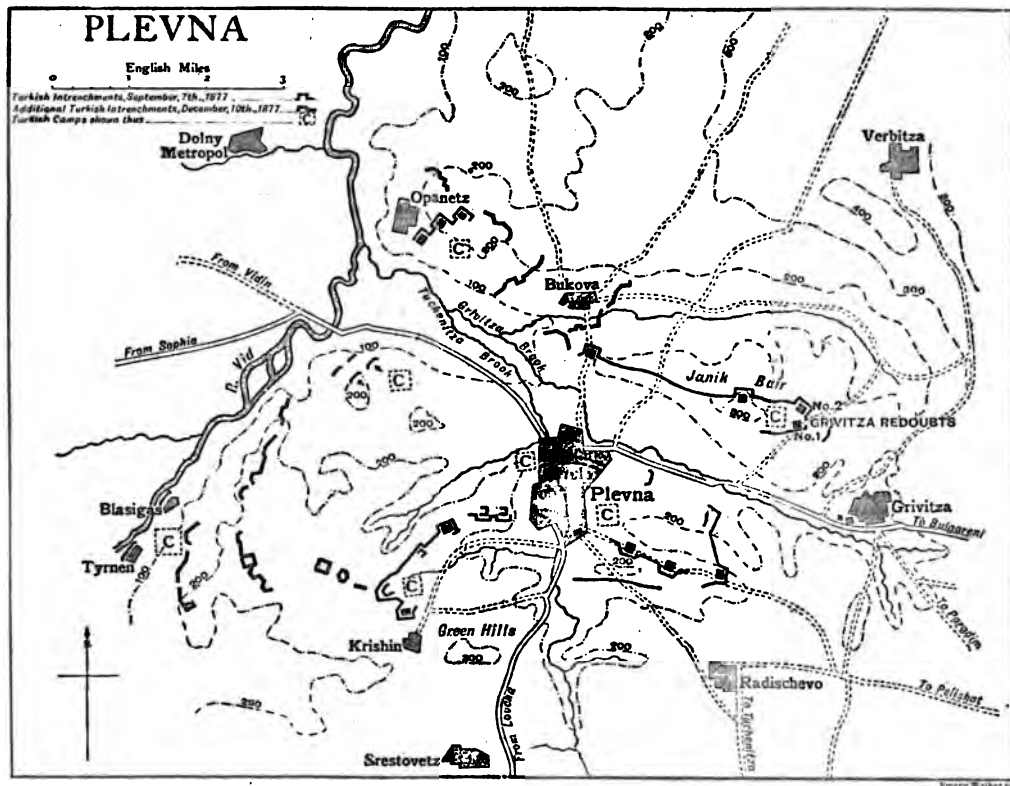

in four separate columns. On the north flank they pressed into Bukova, and also succeeded in driving back the Turkish right wing; but in both cases Turkish reinforcements arrived and with vigorous counter-attacks pressed back the Russians, with the result that by noon they were in full retreat, having lost 2800 men out of a total of 8000. The Turks lost 2000. Osman made no attempt to reap the fruits of his victory by pursuit. He at once drew up plans for the fortification of the position, and the troops were employed night and day constructing redoubts and entrenchments. A plentiful supply of tools and daily convoys of stores reached Plevna from Orchanie, and on the 24th of July Osman's strength was increased by 14 battalions and a battery from Sofia. In order to secure his line of communications, on the 25th of July he

4 ft. deep and the redoubts had a command of 10 to 16 ft., with parapets about 14 ft. thick. In addition to the trenches to the flanks, there were in some cases two lines of trench to the front, thus giving three tiers of fire.

In accordance with orders from the Russian headquarters at Tirnova, a fresh attack was made by General Krüdener on the 30th of July. He had been reinforced by three brigades of infantry and one of cavalry under General Shakovskoi, and his force numbered over 30,000 with 176 guns. After a preliminary cannonade the infantry advanced at 3 p.m., as before in widely spread columns. The columns attacking from the north and north-east were repulsed with heavy loss. Shakovskoi advancing from Radischevo, his left flank safeguarded by Skobelev from

Second
Battle of
Plevna.

the neighbourhood of Kriahin, temporarily occupied two redoubts, but a heavy counter-stroke by the Turkish reserves forced him back with severe loss. The Russians retreated, the northern column to Tristenik and Karagakh, the southern to Poradim. Their losses amounted to 7300, while the Turkish losses exceeded 2000. Had the Turkish garrison of Lovcha been called in, the result would have been still more disastrous to the Russians.

The victory was decisive, but Osman again failed to pursue. His troops were elated by success, the moral of the enemy severely shaken, the undefended Russian bridge over the Danube was within 40 m. of him, but he lost his opportunity, and contented himself with strengthening his defensive works. It is said that he was tied down to Plevna by orders from Constantinople.

The Russians now concentrated all their available forces against Plevna and called in the aid of the Rumanians. By the end of August they had assembled a force of 74,000 infantry, 10,000 cavalry and 440 guns, including 24 siege guns, about 100,000 men in all. On the 30th of August Osman moved out of Plevna with all his cavalry, 3 batteries of artillery and 19 battalions of infantry, and on the 31st attacked the Russians about Pelishat. He returned to Plevna the same evening. The Turks lost 1300 and the Russians 1000 men. The Russians determined to occupy Lovcha, and so cut Osman's communications before again attacking Plevna. After three days' fighting this was accomplished by Skobelev, acting under Imeretinski, with a force of 20,000 men, on the 3rd of September. Osman moved out to the relief of the garrison that day with a strong column, but, finding he was too late, returned to Plevna on the 6th. The survivors from Lovcha were re-formed into 3 battalions, including which Osman had been reinforced by 13 battalions, 2½ batteries of artillery and 11 squadrons of cavalry. His strength was now 30,000, with 72 guns, 46 battalions, 19 squadrons and 12 batteries. This force was organized in 4 approximately equal commands, the northern, south-eastern and southern, and a general reserve.

The Russians moved to their preliminary positions on the night of September 6th-7th. Their plan was for the Rumanians, the IX. and IV. corps and Imeretinski's column to attack the north-east, south-east and south fronts simultaneously. An artillery bombardment began at 6 a.m. on the 7th of September, was carried on till 3 p.m. on the 11th, when the infantry advanced. The Rumanians took one Grivitzta redoubt; Skobelev occupied two redoubts on the south front, but the centre attack on the Radishevo front failed. On the 12th the Turks recaptured the southern redoubts, the Rumanians remained in possession of the Grivitzta redoubt, but the Russian losses already amounted to 18,000 and they withdrew, and entrenched themselves on a line Verbitza-Radishevo, with cavalry on either flank to the Vid. The Turkish losses totalled 5000, of which only a few hundred were caused by the artillery fire of the first few days. There was no question of pursuit. The Russians were greatly superior in numbers and the Turks were completely exhausted.

Several causes contributed to the Russian defeat. The Russian bombardment, at ranges beyond the powers of their guns and lacking the co-operation of the infantry to give them a target, had been useless. No reconnaissance had been made of the position. The infantry attacks were not simultaneous, and were beaten in detail, besides which, they were spread over the whole of a strongly fortified front in equal strength, instead of being pressed home at definite points. The lack of unity of command, in that the commander-in-chief interfered with the dispositions and conduct of the operations as arranged by the commander of the Plevna forces also militated against the Russian success.

This was the last open-force attack on Osman's lines. Investment and Fall of Plevna. General Todleben, the defender of Sevastopol, was now entrusted with the conduct of the siege, and he determined to complete the investment, which was accomplished by the 24th of October, Osman's request to retire

from Plevna having been refused by Constantinople. Supplies eventually gave out and a sortie on the night of the 9th-10th of December failed, with the result that he and his army capitulated.

Plevna is a striking example of the futility of the purely passive defence, which is doomed to failure however tenaciously carried out. Osman Paasha repelled three Russian attacks and practically held the whole Russian army. It remained for the other Turkish forces in the field to take the offensive and by a vigorous counterstroke to reap the fruits of his successes. Victories which are not followed up are useless. War without strategy is mere butchery. The position of Plevna, threatening the Russian bridge and communications, was strategically important, but there was no necessity for the Russians to attack the position. On the eastern flank was an army stronger than Osman's and the fortress of Rustchuk was nearer the bridge than Plevna, but they did not consider it necessary to attack them. They might have contained Osman's force as they did the army under Mehemet Ali, and either awaited his attack or attacked when he evacuated the position. They failed to realize the resisting force of improvised fortifications and the strength conferred by extensive and well-placed entrenchments, and despising their adversary made direct frontal attacks on a well-fortified position, instead of aiming at a flank or the rear. The part played by Plevna in the war was due in the first place to the imaginary importance set by the Russians on its capture, and later to their faulty procedure in attack on the one hand, and to the skill evinced by the Turks in fortifying and defending the position on the other. (J. H. V. C.)

See W. V. Herbert, *The Defence of Plevna, 1877* (London, 1895); F. V. Greene, *The Russian Army and its Campaign in Turkey* (London, 1880); General Kuropatkin (Ger. trans. by Kraumer), *Kritische Rückblicke auf den russisch-türkischen Krieg; Mouzaffar Pacha and Talaat Bey, Défense de Plevna*; Kraumer's German translation of the Russian Official History; General H. Langton, *Lessons of Two Recent Wars* (Eng. trans., War Office, 1910); Th. von Trotha, *Kampf um Plevna* (Berlin, 1878); Vacaresco (Ger. trans.), *Rumänien: Anteil am Kriege, 1877-1878* (Leipzig, 1888).

PLEYEL, IGNAZ JOSEPH (1757-1831), Austrian musician, was born at Rupperthal, near Vienna, on the 1st of June 1757, the twenty-fourth son of a poor village schoolmaster. He studied the pianoforte under Van Hal (known in England as Vanhalla), and in 1772 learned composition from Haydn, who became his dearest friend. He was appointed temporary *maître de chapelle* at Strasburg in 1783, receiving a permanent appointment to the office in 1789. In 1791 he paid a successful visit to London. He narrowly escaped the guillotine on returning to Strasburg, and was only saved by the existence of a cantata which he had written, and in which the inspiration could fairly be claimed to be on the side of liberty; so that he was permitted to remain until 1795, when he migrated to Paris. Here he opened a large music shop, published the first complete edition of Haydn's quartets, and founded, in 1807, the pianoforte manufactory which still bears his name. The latter years of his life were spent in agricultural pursuits. The July revolution of 1830 inflicted upon him a severe shock, and on the 14th of November 1831 he died in Paris.

MARIA PLEYEL, née Moke (1811-1875), the wife of his eldest son, Camille, was one of the most accomplished pianists of her time.

PLIGHT, an homonymous word now used chiefly with two meanings, (1) pledge, and (2) condition or state. The first appears more generally in the verbal form, "to plight one's troth," &c., and the second with a direct or implied sense of misfortune. The derivations of the two words show they are quite distinct in origin. The O. Eng. *plih* meant danger or risk, hence risk of obligation (cf. Ger. *Pflicht*, Du. *plicht*, care, duty). The root *pleh-* or *pleg-* is probably also to be seen in the much disputed word "pledge." The M. Eng. *plii* or *plyt*, on the other hand, is an adaptation of O. Fr. *plait*, fold, and therefore a doublet of "plait," but appears in the 14th century with the neutral sense of condition or state in general.

PLIMER, ANDREW (c. 1763-1837), English miniature painter, was the son of a clock-maker at Wellington. Disliking his father's business, he and his brother Nathaniel joined a party of gypsies and wandered about with them, eventually reaching London, where he presented himself to Mrs Cosway in 1781 and was engaged by her as studio boy. His skill in painting was quickly detected by Cosway, who sent him to a friend to learn drawing, and then received him into his own studio, where he remained until 1785, when he set up for himself in Great Maddox Street. It was of this artist that Cosway said "Andrew will be my Elisha," adding with characteristic vanity, "if I am not constrained to carry my mantle up to Paradise with me." Plimer married Joanna Louisa Knight, whose sister, Mary Ann, was his pupil and a well-known artist. He had five children, only one of whom, Louisa, married. He exhibited many times in the Royal Academy, resided for a while in Exeter, travelled a good deal through England, and died at Brighton and was buried at Hove. His miniatures are of great brilliance and in considerable demand among collectors. They are to be distinguished by the peculiar wiry treatment of the hair and by the large full expressive eyes Plimer invariably gave to his female sitters, eyes resembling those of his own wife and daughters.

See *Andrew and Nathaniel Plimer*, by G. C. Williamson (London, 1903). (G. C. W.)

PLIMER, NATHANIEL (1757-c. 1822), English miniature painter, was the brother of Andrew Plimer (q.v.). He worked for a while with Henry Bone the enameller, eventually entering Cosway's studio. He exhibited at the Royal Academy from 1787 until 1815, when he is lost sight of, although he is said to have lived until 1822. He had four daughters, one of whom married the painter, Andrew Geddes, and left children. He exhibited twenty-six works, and many of his smaller portraits are of extreme beauty.

See *Andrew and Nathaniel Plimer*, by G. C. Williamson (London, 1903). (G. C. W.)

PLIMSOLL, SAMUEL (1824-1898), British politician and social reformer, was born at Bristol on the 10th of February 1824. Leaving school at an early age, he became a clerk, and rose to be manager of a brewery in Yorkshire. In 1853 he endeavoured to set up a business of his own in London as a coal merchant. The venture proved a failure, and Plimsoll was reduced to destitution. He has himself related how for a time he lived in a common lodging-house on 7s. 9½d. a week. Through this experience he learnt to sympathize with the struggles of the poor; and when the success of his enterprise placed him in possession of a competence, he resolved to devote his leisure to the amelioration of their lot. His efforts were directed more especially against what were known as "coffin-ships"—unseaworthy and overloaded vessels, often heavily insured, in which unscrupulous owners were allowed by the law to risk the lives of their crews. Plimsoll entered parliament as Liberal member for Derby in 1868, and endeavoured in vain to pass a bill dealing with the subject. In 1872 he published a work entitled *Our Seamen*, which made a great impression throughout the country. Accordingly, on Plimsoll's motion in 1873, a royal commission was appointed, and in 1875 a government bill was introduced, which Plimsoll, though regarding it as inadequate, resolved to accept. On the 22nd of July, the premier, Disraeli, announced that the bill would be dropped. Plimsoll lost his self-control, applied the term "villains" to members of the house, and shook his fist in the Speaker's face. Disraeli moved that he be reprimanded, but on the suggestion of Lord Hartington agreed to adjourn the matter for a week to allow Plimsoll time for reflection. Eventually Plimsoll made an apology. The country, however, shared his view that the bill had been stifled by the pressure of the shipowners, and the popular agitation forced the government to pass a bill, which in the following year was amended into the Merchant Shipping Act. This gave stringent powers of inspection to the Board of Trade. The mark that indicates the limit to which a ship may be loaded is generally known as Plimsoll's mark. Plimsoll was re-elected for Derby at the general election of 1880 by a great majority, but

gave up his seat to Sir W. Haecourt, in the belief that the latter, as home secretary, could advance the sailors' interests more effectively than any private member. Though offered a seat by some thirty constituencies, he did not re-enter the house, and subsequently became estranged from the Liberal leaders by what he regarded as their breach of faith in neglecting the question of shipping reform. He held for some years the presidency of the Sailors' and Firemen's Union, raised a further agitation, marred by obvious exaggeration, about the horrors of the cattle-ships. Later he visited the United States with the object, in which he did good service, of securing the adoption of a less bitter tone towards England in the historical textbooks used in American schools. He died at Folkestone on the 3rd of June 1898.

PLINLIMMON (*Plynlimmon, Pumlummon, Pumlumon, Penlumon*): Pumlumon is the name used locally; *pump* means five: *lunnon*, chimney, flag or beacon; *pen*, head, a mountain of Wales of the height of 2463 ft., equidistant (about 10 m.) from Machynlleth and Llanidloes. Much inferior in elevation to Snowdon or Cader Idris, Plinlimmon is certainly the most dangerous of the Welsh hills because of its quaking bogs. The scenery is comparatively poor, consisting chiefly of sheep-downs (in Montgomeryshire) and barren turbaries (in Cardiganshire). If the name means "five-beacons," only three of these are high, with a *carnedd* (stone-pile, probably a military or other landmark, rather than the legendary barrow or tomb) on each of the three. Plinlimmon is notable as the source of five streams—three small: the Rheidol, the Llynant and the Clywedog; and two larger and famous: the Wye (*Gwy*) and the Severn (*Hafren*).

The morasses of Plinlimmon saw many a struggle, notably the war to the knife between Owen Cyfeilog (*f. c. 900*), prince of Powys, and Hywel ab Cadogan. Here also Owen Glendower unfurled the banner of Welsh independence; from here, in 1401, he harassed the country, sacking Montgomery, burning Welshpool, and destroying Cwm Hlr (long "combe," or valley) abbey, of which some columns are said to be now in Llanidloes old church. On the side of Plinlimmon, some 2 m. from the Steddfagur inn, is Blaen Gwy (the point of the Wye), the course of the streamlet being traceable up to Pont-rhyd-galed (the hard ford bridge), some 4 m. distant from the inn. Near this bridge are numerous barrows and cairns, on the right from Aberystwyth. There are slate quarries, with lead and copper mines. Machynlleth (perhaps *Maglona* in Roman times) has Owen Glendower's "senate house" (1402), and is known as the scene of Glendower's attempted assassination by Dafydd Gam. Llyn pen rhaiadr (the waterfall-head pool), or Pistyll y llyn (pool spout), is some 6 m. south of Machynlleth. Llanidloes has a trade in Plinlimmon slates and minerals besides flannel and wool manufactures.

PLINTH (Gr. *πλαῖθος*, a square tile), the term in architecture given to the lower mouldings of a podium, pedestal or skirting also to any rectangular block on which a statue or vase is placed and in the Classic Orders to the square block of moderate height under the base mouldings of the column or pedestal.

PLINY, THE ELDER. Gaius Plinius Secundus (c. A.D. 23-79), the author of the *Naturalis historia*, was the son of a Roman *eques* by the daughter of the senator Gaius Caecilius of Novum Comum. He was born at Comum, not (as is sometimes supposed) at Verona: it is only as a native of Gallia-Transpadana that he calls Catullus of Verona his *conterraneus*, or fellow-countryman, not his *municeps*, or fellow-townsmen (*Praef.* § 1). Before A.D. 35 (*N. H.* xxxvii. 81) his father took him to Rome, where he was educated under his father's friend, the poet and military commander, P. Pomponius Secundus, who inspired him with a lifelong love of learning. Two centuries after the death of the Gracchi Pliny saw some of their autograph writings in his preceptor's library (xiii. 83), and he afterwards wrote that preceptor's *Life*. He makes mention of the grammarians and rhetoricians, Remmius Palaemon and Arellius Fuscus (xiv. 49, xxxiii. 152), and he may have been instructed by them. In Rome he studied botany in the garden of the aged Antonius Castor (xxv. 9), and saw the fine old lotus-trees in the grounds that had once belonged to Crassus (xvii. 5). He also viewed the

vast structure raised by Calligula (xxxvi. 111), and probably witnessed the triumph of Claudius over Britain (iii. 119; A.D. 44). Under the influence of Seneca he became a keen student of philosophy and rhetoric, and began practising as an advocate. He saw military service under Corbulo in Lower Germany (A.D. 47), taking part in the Roman conquest of the Chauci and the construction of the canal between the Maas and the Rhine (xvi. 2 and 5). As a young commander of cavalry (*praefectus alae*) he wrote in his winter-quarters a work on the use of missiles on horseback (*de jaculatione equestri*), with some account of the points of a good horse (viii. 162). In Gaul and Spain he learnt the meanings of a number of Celtic words (xxx. 40). He took note of sites associated with the Roman invasion of Germany, and, amid the scenes of the victories of Drusus, he had a dream in which the victor enjoined him to transmit his exploits to posterity (Plin. *Epp.* iii. 5, 4). The dream prompted Pliny to begin forthwith a history of all the wars between the Romans and the Germans. He probably accompanied his father's friend, Pomponius, on an expedition against the Chatti (A.D. 50), and visited Germany for a third time (57) as a comrade of the future emperor, Titus (*Praef.* § 3). Under Nero he lived mainly in Rome. He mentions the map of Armenia and the neighbourhood of the Caspian Sea, which was sent to Rome by the staff of Corbulo in A.D. 58 (vi. 40). He also saw the building of Nero's "golden house" after the fire of 64 (xxxvi. 111). Meanwhile he was completing the twenty books of his *History of the German Wars*, the only authority expressly quoted in the first six books of the *Annals* of Tacitus (i. 60), and probably one of the principal authorities for the *Germania*. It was superseded by the writings of Tacitus, and, early in the 5th century, Symmachus had little hope of finding a copy (*Epp.* xiv. 8). He also devoted much of his time to writing on the comparatively safe subjects of grammar and rhetoric. A detailed work on rhetoric, entitled *Studiosus*, was followed by eight books, *Dubii sermonis* (A.D. 67). Under his friend Vespasian he returned to the service of the state, serving as *procurator* in Gallia Narbonensis (70) and Hispania Tarraconensis (73), and also visiting the Provincia Belgica (74). During his stay in Spain he became familiar with the agriculture and the mines of the country, besides paying a visit to Africa (vii. 37). On his return to Italy he accepted office under Vespasian, whom he used to visit before daybreak for instructions before proceeding to his official duties, after the discharge of which he devoted all the rest of his time to study (Plin. *Epp.* iii. 5, 9). He completed a *History of his Times* in thirty-one books, possibly extending from the reign of Nero to that of Vespasian, and deliberately reserved it for publication after his decease (*N. H.*, *Praef.* 20). It is quoted by Tacitus (*Ann.* xiii. 20, xv. 53; *Hist.* iii. 29), and is one of the authorities followed by Suetonius and Plutarch. He also virtually completed his great work, the *Naturalis historia*. The work had been planned under the rule of Nero. The materials collected for this purpose filled rather less than 160 volumes in A.D. 23, when Larcus Licinius, the praetorian legate of Hispania Tarraconensis, vainly offered to purchase them for a sum equivalent to more than £3000. He dedicated the work to Titus in A.D. 77. Soon afterwards he received from Vespasian the appointment of prefect of the Roman fleet at Misenum. On the 24th of August A.D. 79 he was stationed at Misenum, at the time of the great eruption of Vesuvius, which overwhelmed Pompeii and Herculaneum. A desire to observe the phenomenon from a nearer point of view, and also to rescue some of his friends, from their perilous position on the shore of the Bay of Naples, led to his launching his galleys and crossing the bay to Stabiae (Castellamare), where he perished, in the fifty-sixth year of his age. The story of his last hours is told in an interesting letter addressed twenty-seven years afterwards to Tacitus by the Elder Pliny's nephew and heir, the Younger Pliny (*Epp.* vi. 16), who also sends to another correspondent an account of his uncle's writings and his manner of life (iii. 5).—

"He began to work long before daybreak. . . . He read nothing without making extracts; he used even to say that there was no book so bad as not to contain something of value. In the country

it was only the time when he was actually in his bath that was exempted from study. When travelling, as though freed from every other care, he devoted himself to study alone. . . . In short, he deemed all time wasted that was not employed in study."

The only fruit of all this unwearied industry that has survived to our own times is the *Naturalis historia*, a work which in its present form consists of thirty-seven books, the first book including a characteristic preface and tables of contents, as well as lists of authorities, which were originally prefixed to each of the books separately. The contents of the remaining books are as follows: ii., mathematical and physical description of the world; iii.-vi., geography and ethnography; vii., anthropology and human physiology; viii.-xi., zoology; xii.-xvii., botany, including agriculture, horticulture and *materia medica*; xviii.-xxiii., medical zoology; xxxiii.-xxxvii., mineralogy, especially in its application to life and art, including chasing a silver (xxxiii. 154-157), statuary in bronze (xxxiv.), painting (xxxv. 15-149), modelling (151-158), and sculpture in marble (xxxvi.).

He apparently published the first ten books himself in A.D. 77, and was engaged on revising and enlarging the rest during the two remaining years of his life. The work was probably published with little, if any, revision by the author's nephew, who, when telling the story of a tame dolphin, and describing the floating islands of the Vadimonian Lake, thirty years later (viii. 20, ix. 33), has apparently forgotten that both are to be found in his uncle's work (ii. 209, ix. 26). He describes the *Naturalis historia*, as a *Natura historia*, and characterizes it as a "work that is learned and full of matter, and as varied as nature herself." The absence of the author's final revision may partly account for many repetitions, and for some contradictions, for mistakes in passages borrowed from Greek authors, and for the insertion of marginal additions at wrong places in the text.

In the preface the author claims to have stated 20,000 facts gathered from some 2000 books and from 100 select authors. The extant lists of his authorities amount to many more than 400, including 146 of Roman and 327 of Greek and other sources of information. The lists, as a general rule, follow the order of the subject matter of each book. This has been clearly shown in Heinrich Brunn's *Disputatio* (Bonn, 1856).

Pliny's principal authority is Varro. In the geographical books Varro is supplemented by the topographical commentaries of Agrippa which were completed by the emperor Augustus; for his zoology he relies largely on Aristotle and on Juba, the schachy Mauretanian king, *studiorum claritate memorabilior quam rebus* (v. 16). Juba is also his principal guide in botany. Theophrastus is also named in his *Indices*. In the *History of Art* the original Greek authorities are Duris of Samos (born c. 340 B.C.), Xenocrates of Sicyon (fl. 280), and Antigonos of Carystus (born c. 295 B.C.). The anecdotic element has been ascribed to Duris (xxxv. 61, *Lysippum Sicyonium Duris neque ullius fuisse discipulum*, &c.); the notices of the successive developments of art, and the list of workers in bronze and painters, to Xenocrates; and a large amount of miscellaneous information to Antigonos. The last two authorities are named in connexion with Parrhasius (xxxv. 68, *hanc gloriam concessere Antigonos et Xenocrates, qui de pictura scripserunt*), while Antigonos is named in the *Indices* of xxxiii.-xxxiv. as a writer on the "toreutic" art. Greek epigrams contribute their share in Pliny's descriptions of pictures and statues. One of the minor authorities for books xxxv.-xxxv. is Heliodorus (fl. 150 B.C.), the author of a work on the monuments of Athens. In the *Indices* of xxxiii.-xxxvi. an important place is assigned to Pasiteles of Naples (fl. 88 B.C.), the author of a work in five volumes on famous works of art xxxvi. 40), probably incorporating the substance of the earlier Greek treatises; but Pliny's indebtedness to Pasiteles is denied by Kalkmann, who holds that Pliny used the chronological work of Apollodorus, as well as a current catalogue of artists. Pliny's knowledge of the Greek authorities was probably mainly due to Varro, whom he often quotes (e.g. xxxv. 56, xxxv. 113, 156, xxxvi. 17, 39, 41). Varro probably dealt with the history of art in connexion with architecture, which was included in his *Disciplinæ*. For a number of items relating to works of art near the coast of Asia Minor, and in the adjacent islands, Pliny was indebted to the general statesman, orator and historian, Gaius Licinius Mucianus, who died before A.D. 77. Pliny mentions the works of art collected by Vespasian in the Temple of Peace and in his other galleries (xxxv. 84), but much of his information as to the position of such works in Rome is due to books, and not to personal observation. The main merit of his account of ancient art, the only classical work of its kind, is that it is a compilation ultimately founded on the best textbooks of Xenocrates and on the biographies of Duris and Antigonos.

He shows no special aptitude for art criticism; in several passages, however, he gives proof of independent observation (xxxiv. 38, 46, 63, xxxv. 17, 20, 116 seq.). He prefers the marble *Laocoon* in the palace of Titus to all the pictures and bronzes in the world (xxxvi. 37); in the temple near the Flaminian Circus he admires the *Ares* and the *Aphrodite* of Scopas, "which would suffice to give renown to any other spot." "At Rome indeed (he adds) the works of art are legion; besides, one effaces another from the memory and, however beautiful they may be, we are distracted by the overpowering claims of duty and business; for to admire art we need leisure and profound stillness" (ibid. 26-27).

Like many of the finest spirits under the early empire, Pliny was an adherent to the Stoics. He was acquainted with their noblest representative, Thrasea Pactus, and he also came under the influence of Seneca. The Stoics were given to the study of nature, while their moral teaching was agreeable to one who, in his literary work, was unselfishly eager to benefit and to instruct his contemporaries (*Præf.* 16, xviii. 2, xxix. 1). He was also influenced by the Epicurean and the Academic and the revived Pythagorean schools. But his view of nature and of God is essentially Stoic. It was only (he declares) the weakness of humanity that had embodied the Being of God in many human forms endowed with human faults and vices (ii. 148). The Godhead was really one; it was the soul of the eternal world, displaying its beneficence on the earth, as well as in the sun and stars (ii. 12 seq., 154 seq.). The existence of a divine Providence was uncertain (ii. 19), but the belief in its existence and in the punishment of wrong-doing was salutary (ii. 26); and the reward of virtue consisted in the elevation to Godhead of those who resembled God in doing good to man (ii. 18, *Deus est mortali juvare mortalem, et haec ad aeternam gloriam via*). It was wrong to inquire into the future and do violence to nature by resorting to magical arts (ii. 114, xxx. 3); but the significance of prodigies and portents is not denied (ii. 92, 199, 232). Pliny's view of life is gloomy; he regards the human race as plunged in ruin and in misery (ii. 24, vii. 130). Against luxury and moral corruption he indulges in declamations, which are so frequent that (like those of Seneca) they at last pall upon the reader; and his rhetorical flourishes against practically useful inventions (such as the art of navigation) are wanting in good sense and good taste (xix. 6).

With the proud national spirit of a Roman he combines an admiration of the virtues by which the republic had attained its greatness (xvi. 14, xxvii. 3, xxxvii. 201). He does not suppress historical facts unfavourable to Rome (xxiv. 139), and while he honours eminent members of distinguished Roman houses, he is free from Livy's undue partiality for the aristocracy. The agricultural classes and the old landlords of the equestrian order (Cincinnatus, Curius Dentatus, Serranus and the Elder Cato) are to him the pillars of the state; and he bitterly laments the decline of agriculture in Italy (xviii. 21 and 35, *latifundia perdere Italiam*). Accordingly, for the early history of Rome, he prefers following the *prae-Augustan* writers; but he regards the imperial power as indispensable for the government of the empire, and he lauds the *salutaris aevotus Vespasiani* (xxxiii. 51). At the conclusion of his literary labours, as the only Roman who had ever taken for his theme the whole realm of nature, he prays for the blessing of the universal mother on his completed work.

In literature he assigns the highest place to Homer and to Cicero (xvii. 37 seq.); and the next to Virgil. He takes a keen interest in nature, and in the natural sciences, studying them in a way that was then new in Rome, while the small esteem in which studies of this kind were held does not deter him from endeavouring to be of service to his fellow countrymen (xii. 15). The scheme of his great work is vast and comprehensive, being nothing short of an encyclopaedia of learning and of art so far as they are connected with nature or draw their materials from it. With a view to this work he studied the original authorities on each subject and was most assiduous in making excerpts from their pages. His *indices auctororum* are, in some cases, the authorities which he has actually consulted (though in this respect they are not exhaustive); in other cases, they represent the principal writers on the subject, whose names are borrowed second-hand

for his immediate authorities. He frankly acknowledges his obligations to all his predecessors in a phrase that deserves to be proverbial (*Præf.* 21, *plenum ingenii pudoris fatris per quas profectus*). He had neither the temperament for original investigation, nor the leisure necessary for the purpose. It is obvious that one who spent all his time in reading and in writing, and in making excerpts from his predecessors, had none left for mature and independent thought, or for patient experimental observation of the phenomena of nature. But it must not be forgotten that it was his scientific curiosity as to the phenomena of the eruption of Vesuvius that brought his life of unwearied study to a premature end; and any criticism of his faults of omission is disarmed by the candour of the confession in his preface: *nec dubitamus multa esse quae et nos praeterierint; homines enim sumus et occupati officis*.

His style betrays the unhealthy influence of Seneca. It aims less at clearness and vividness than at epigrammatic point. It abounds not only in antitheses, but also in questions and exclamations, tropes and metaphors, and other mannerisms of the silver age. The rhythmical and artistic form of the sentence is sacrificed to a passion for emphasis that delights in deferring the point to the close of the period. The structure of the sentence is also apt to be loose and straggling. There is an excessive use of the ablative absolute, and ablative phrases are often appended in a kind of vague "apposition" to express the author's own opinion of an immediately previous statement, e.g. xxxv. 80, *dixit (Apelles) . . . uno se praestare, quod manum de tabula sciret tollere, memorabili praecipio nocere saepe nimiam diligentiam*.

About the middle of the 3rd century an abstract of the geographical portions of Pliny's work was produced by Solinus; and, early in the 4th, the medical passages were collected in the *Medicina Plinii*. Early in the 8th we find Bede in possession of an excellent MS. of the whole work. In the 9th Alcuin sends to Charles the Great for a copy of the earlier books (*Epp.* 103, Jaffé); and Dicuili gathers extracts from the pages of Pliny for his own *Mensura orbis terrae* (c. 825). Pliny's work was held in high esteem in the middle ages. The number of extant MSS. is about 200; but the best of the more ancient MSS., that at Bamberg, contains only books xxxii.-xxxvii. Robert of Cricklade, prior of St Frideswide at Oxford, dedicated to Henry II. a *Deformatio* consisting of nine books of selections taken from one of the MSS. of this class, which has been recently recognized as sometimes supplying us with the only evidence for the true text. Among the later MSS. the *codex Vesontinus*, formerly at Besançon (11th century), has been divided into three portions, now in Rome, Paris and Leiden respectively, while there is also a transcript of the whole of this MS. at Leiden.

In modern times the work has been the theme of a generous appreciation in several pages of Humboldt's *Cosmos* (ii. 195-199, E. T., 1848). Jacob Grimm, in the first paragraph of c. 37 of his *Deutsche Mythologie*, writing with his own fellow-countrymen in view, has commended Pliny for condescending, in the midst of his survey of the sciences of botany and zoology, to tell of the folklore of plants and animals, and has even praised him for the pains that he bestowed on his style. It may be added that a special interest attaches to his account of the manufacture of the papyrus (xiii. 68-83), and of the different kinds of purple dye (ix. 130), while his description of the notes of the nightingale is an elaborate example of his occasional felicity of phrase (xxix. 81 seq.). Most of the recent research on Pliny has been concentrated on the investigation of his authorities, especially those which he followed in his chapters on the history of art—the only ancient account of that subject which has survived.

A carnelian inscribed with the letters C. PLIN. has been reproduced by Cades (v. 211) from the original in the Vannutelli collection. It represents an ancient Roman with an almost completely bald forehead and a double chin; and is almost certainly a portrait, not of Pliny the Elder, but of Pompey the Great. Seated statues of both the Plinies, clad in the garb of scholars of the year 1500, may be seen in the niches on either side of the main entrance to the cathedral church of Como. The elder Pliny's anecdotes of Greek artists supplied Vasari with the subjects of the frescoes which still adorn the interior of his former home at Arezzo.

BIBLIOGRAPHY.—Editions by Hermolaus Barbarus (Rome, 1492); Dalecampius (Lyons, 1587); Gronovius (Leiden, 1669); Hardouin (Paris, 1685); Franz (Leipzig, 1778-1791); Sillig, with index by O. Schneider (Gotha, 1853-1855); L. von Jan (Leipzig, 1854-1865); D. Detlefsen (Berlin, 1866-1873), and critical edition of the geographical books (Berlin, 1905); Mayhoff (Leipzig, 1906-); Eng. trans., Philemon Holland (London, 1601); French, Littré (1855); *Chrestomathia Pliniana*, L. Ulrichs, with excellent *Einleitung* (Berlin, 1857); *The Elder Pliny's Chapters on the History*

of *Art*, trans. by K. Jex Blake, with commentary, and historical introduction by E. Sellers (London, 1896). On Pliny's supposed portrait, see Bernoulli, *Röm. Ikonogr.* i. 288; in the *Deformatio Pliniana* of Robert of Cricklade, K. Rück, in *S. Ber. of Munich Acad.*, May 3, 1902, pp. 195-285 (1903). On Pliny's Authorities, see especially F. Münzer, *Beiträge zur Quellenkritik* (Berlin, 1897) and *Detlefsen, Quellen und Forschungen zur alten Gesch. und Geog.* (1904 and 1908); on his *Religion*, Vorhäuser (Innsbruck, 1860); his *Cosmology*, Friese (Breslau, 1862); his *Botany*, Brosig (Gaudenz, 1883); Sprengel (Marburg, 1890, and in *Rhein. Mus.*, 1891); Renjes (Rostock, 1893); Art (Burghausen, 1896); and Stadler (Munich, 1891); his *Mineralogy*, Nies (Mainz, 1884); his *History of Art*, O. Jahn, in *Sächsische Berichte* (Leipzig, 1850); A. Brieger (Greifswald, 1857); Wustmann, *Rhein. Mus.* (1867); H. Brunn (Bonn, 1856, and Munich, 1875); Th. Schreiber (Leipzig, 1872, and in *Rhein. Mus.*, 1876); Furtwängler, in *Fleckeisen's Jahrb., Suppl.* (1877) vol. ix.; Blümner, in *Rhein. Mus.* (1877); L. Ulrichs (Würzburg, 1878); Oehmichen (Erlangen, 1880); Dalstein (Metz, 1885); H. Voigt (Halle, 1887); H. L. Ulrichs (Würzburg, 1887); Holwerda, in *Amenos.* (1889); F. Münzer, in *Hermes* (1895, and Berlin, 1897); Kalkmann (Berlin, 1898).

The fragments of the eight books, *Dubii sermonis*, have been collected by J. W. Beck (Leipzig, 1894). For further bibliographical details, see Mayor, *Litt. Lit.* (1875), 136-138; and Schanz, *Röm. Litt.* (Munich, 1901), §§ 490-494. (J. E. S.)

PLINY, THE YOUNGER. Publius Caecilius Secundus, later known as Gaius Plinius Caecilius Secundus (A.D. c. 61-c. 113), Latin author of the *Letters* and the *Panegyric on Trajan*, was the second son of Lucius Caecilius Cilo, by Plinia, the sister of the Elder Pliny. He was born at Novum Comum, the modern Como, the date of his birth being approximately determined by the fact that he was in his 18th year at the death of his uncle in August A.D. 79 (*Epp.* vi. 20, 5). Having lost his father at an early age, he owed much to his mother and to his guardian, Verginius Rufus, who had twice filled the office of consul and had twice refused the purple (ii. 1, 8). He owed still more to his uncle. When the Elder Pliny was summoned to Rome by Vespasian in A.D. 72, he was probably accompanied by his nephew, who there went through the usual course of education in Roman literature and in Greek, and at the age of fourteen composed a "Greek tragedy" (vii. 4, 2). He afterwards studied philosophy and rhetoric under Nicetes Sacerdos and Quintilian (vi. 6, 3, ii. 14, 9), and modelled his own oratorical style on that of Demosthenes, Cicero and Calvus (l. 2). The Elder Pliny inspired his nephew with something of his own indomitable industry; and in August 79, when the author of the *Historia naturalis* lost his life in the famous eruption of Vesuvius, it was the sister of the Elder and the mother of the Younger Pliny who first descried the signs of the approaching visitation, and, some twenty-seven years later, it was the Younger Pliny who wrote a graphic account of the last hours of his uncle, in a letter addressed to the historian Tacitus (vi. 16). By his will the Elder Pliny had made his nephew his adopted son, and the latter now assumed the *nomen* and *praenomen* of his adoptive father.

A year later he made his first public appearance as an advocate (v. 8, 8), and soon afterwards became a member of the board of *decemviri stilibus iudicandis*, which was associated with the praetor in the presidency of the centumviral court. Early in the reign of Domitian he served as a military tribune in Syria (A.D. 81 or 82), devoting part of his leisure to the study of philosophy under the Stoic Euphrates (l. 10, 2). On returning to Rome he was nominated to the honorary office of *sevir equitum romanorum*, and was actively engaged as a pleader before the *centumviri*, the chancery court of Rome (vi. 12, 2).

His official career began in A.D. 80, when he was nominated by Domitian as one of the twenty quaestors. He thus became a member of the senate for the rest of his life. In December 91 he was made tribune, and, during his tenure of that office, withdrew from practice at the bar (i. 23). Early in 93 he was appointed praetor (iii. 11, 2), and, in his year of office, was one of the counsel for the impeachment of Baebius Massa, the procurator of Hispania Baetica (iii. 4, vi. 29, vii. 33). During the latest and darkest years of Domitian he deemed it prudent to withdraw from public affairs, but his financial abilities were recognized by his nomination in 94 or 95 to the *praefectura aerarii militaris* (ix. 13, 11).

On the death of Domitian and the accession of Nerva he

delivered a speech (subsequently published) in prosecution of Publicius Certus, who had been foremost in the attack on Helvidius Priscus (ix. 13). Early in 98 he was promoted to the position of praefect of the public treasury in the temple of Saturn. After the accession of Trajan in the same year, Pliny was associated with Tacitus in the impeachment of Marius Priscus for his maladministration of the province of Africa (ii. 11). The trial was held under the presidency of the emperor, who had already nominated him *consul suffectus* for part of the year A.D. 100. The formal oration of thanks for this nomination, described by Pliny himself as his *gratiarum actio* (iii. 13, 1 and 18, 1), is called in the MSS. the *Panegyricus Trajano dictus*.

The following year was marked by the death of Silius Italicus and Martial, who are gracefully commemorated in two of his *Letters* (iii. 7 and 21). It is probable that in 103-104 he was promoted to a place in the college of Augurs, vacated by his friend Frontinus (iv. 8), and that in 105 he was appointed curator of the river Tiber (v. 14, 2). In the same year he employed part of his leisure in producing a volume of heptasyllabic verse (iv. 14, v. 10). He usually spent the winter at his seaside villa on the Latian coast near Laurentum, and the summer at one of his country houses, either among the Tuscan hills, near Tifernum, or on the lake of Como, or at Tusculum, Tibur or Praeneste.

It was probably in 104, and again in 106, that he was retained for the defence of a governor of Bithynia, thus becoming familiar with the affairs of a province which needed a thorough reorganization. Accordingly, about 111, he was selected by Trajan as governor of Bithynia, under the special title of "legate propraetor with consular power." He reached Bithynia in September, held office for fifteen months or more, and probably died in 113.

His health was far from robust. He speaks of his delicate frame (*gracilitas mea*); and he was apt to suffer from weakness of the eyes (vii. 21) and of the throat or chest (ii. 11, 15). Frugal and abstemious in his diet (i. 15; iii. 1 and 12), studious and methodical in his habits (i. 6, v. 18, ix. 36 and 40), he took a quiet delight in some of the gentler forms of outdoor recreation. We are startled to find him telling Tacitus of his interest in hunting the wild boar, but he is careful to add that, while the beaters were at work, he sat beside the nets and was busily taking notes, thus combining the cult of Minerva with that of Diana (i. 6). He also tells the historian that, when his uncle left Misenum to take a nearer view of the eruption of Vesuvius, he preferred to stay behind, making an abstract of a book of Livy (vi. 20, 5).

Among his friends were Tacitus and Suetonius, as well as Frontinus, Martial and Silius Italicus; and the Stoics, Musonius and Helvidius Priscus. He was thrice married; on the death of his second wife without issue, Trajan conferred on him the *ius trium liberorum* (A.D. 98), and, before 105, he found a third wife in the accomplished and amiable Calpurnia (iv. 10). He was generous in his private and his public benefactions (i. 19, 2, ii. 4, 2, vi. 32). At his Tuscan villa near Tifernum Tiberinum (iv. 1, 4), the modern Città di Castello, he set up a temple at his own expense and adorned it with statues of Nerva and Trajan (x. 8). In his lifetime he founded and endowed a library at his native place (i. 8, v. 7), and, besides promoting local education (iv. 13), established an institute for the maintenance and instruction of the sons and daughters of free-born parents (vi. 18). By his will he left a large sum for the building and the perpetual repair of public baths, and the interest of a still larger sum for the benefit of one hundred freedmen of the testator and, ultimately, for an annual banquet.

On a marble slab that once adorned the public baths at Comum, his distinctions were recorded in a long inscription, which was afterwards removed to Milan. It was there broken into six square pieces, four of which were built into a tomb within the great church of Sant' Ambrogio. Of these four fragments only one survives, but with the aid of transcripts of the other three made by Cyriacus of Ancona in 1442, the whole was

restored by Mommsen [*C.J.L.* v. 5262]. It is to the following effect:—

Gaius Plinius Caecilius Secundus, son of Lucius, of the Ufentine tribe: consul; augur; legate-propraetor of the province of Pontus and Bithynia, with consular power, by decree of the senate sent into the said province by the emperor Nerva Trajan (Augustus, Germanicus, Dacicus, *pater patriae*); curator of the bed and banks of the Tiber and of the sewers of the city; praefect of the Treasury of Saturn; praefect of the Treasury of War; praetor, tribune of the plebs; emperor's quaestor, sevir of the Roman knights; military tribune of the third Gallic legion; *decemvir* for the adjudication of suits; provided by will for the erection of baths at a cost of . . . adding for the furnishing of the same 300,000 sesterces (£2400) and furthermore, for maintenance, 200,000 sesterces (£1600); likewise, for the support of one hundred of his own freedmen (he bequeathed) to the township 1,866,666 sesterces (c. £15,000), the eventual accretions whereof he devised to the townfolk for a public entertainment; . . . likewise, in his lifetime he gave for the support of sons and daughters of the townfolk 500,000 sesterces (£4000), likewise a library, and, for the maintenance of the library, 100,000 sesterces (£800).

With the exception of two mediocre sets of verses, quoted by himself (vii. 4 and 9), his poems have perished. His speeches were apt to be prolix, and he defended their prolixity on principle (i. 20). He was apparently the first to make a practice of reciting his speeches before a gathering of his friends before finally publishing them (iii. 18). The only speech that has survived is the *Panegyric on Trajan*, first delivered by Pliny in the emperor's presence, next recited to the orator's friends for the space of three days, and ultimately published in an expanded form (*Epp.* iii. 18). It is unduly florid and redundant in style, but it supplies us with the fullest account of the emperor's antecedents, and of his policy during the first two years and a half of his rule.

It describes his entering Rome on foot, amid the rejoicings of the citizens; his liberality towards his soldiers and to the citizens of Rome, a liberality that was extended even to persons under eleven years of age; his charities for the maintenance of the children of the poor; his remission of succession-duties in cases where the property was small, or the heirs members of the testator's family; his establishment of free trade in corn between the various parts of the empire; his abandonment of vexatious and petty prosecutions for "high treason"; his punishment of informers; his abolition of pantomimes; his repairs of public buildings and his extension and embellishment of the Circus Maximus. The speech was discovered by Aurispa at Mainz in 1432, as part of a collection of *Panegyrics*; and was first printed by Fr. Puteolanus at Milan about fifty years later.

Besides the *Panegyric*, we possess the nine books of Pliny's *Letters*, and a separate book containing his *Correspondence with Trajan*.

In the first letter of the first book Pliny states that he has collected certain of his letters without regard to chronological order (*non servato temporis ordine*). Pliny's learned biographer, the Dutch scholar, Jean Masson (1709), wrongly assumed that this statement referred to the whole of the collection. He inferred that all the nine books were published simultaneously; and he also held that Pliny was governor of Bithynia in A.D. 103-105. It was afterwards maintained by Mommsen (1868) that the books were in strictly chronological order, that the *Letters* in each book were in general arranged in order of date, that all of them were later than the probably published in the following order: i. (97); ii. (100); iii. (101-102); iv. (105); v. and vi. (106); vii. (107); viii. (108); and ix. (not later than 109); and, lastly, that Pliny was governor of Bithynia from A.D. 111-112 to 113. The letter which is probably the earliest (ii. 20) has since been assigned to the last part of the reign of Domitian, and it has been suggested by Professor Merrill that the nine books were published in three groups: i.-ii. (97 or 98); iii.-vi. (106); vii.-ix. (108 or 109).

In his *Letters* Pliny presents us with a picture of the varied interests of a cultivated Roman gentleman. The etiquette of the imperial circle, scenes from the law-courts and the recitation-room, the reunions of dilettanti and philosophers, the busy life of the capital or of the municipal town, the recreations of the seaside and of the country—all these he brings vividly before our eyes. He elaborately describes his Laurentine and his Tuscan villa, and frankly tells us how he spends the day at each (ii. 17, v. 6, ix. 36 and 40); expatiates on his verses and his speeches, his holiday-tasks in Umbria (vii. 9, ix. 10), and his happy memories of the Lake of Como (i. 6). He gives an enthusiastic account of a statuette of Corinthian bronze he has recently purchased (iii. 6). He is interested in providing a teacher of

rhetoric for the place of his birth (iv. 13); he exults in the devotion of his wife, Calpurnia (vi. 19); towards his servants he is an indulgent master (viii. 16); he intercedes on behalf of the freedman of a friend (ix. 21), and, when a freedman of his own is in delicate health, sends him first to Egypt and afterwards to the Riviera (v. 19). He consults Suetonius on the interpretation of dreams (i. 18); he presents another of his correspondents with a batch of ghost-stories (vii. 27) or a marvellous tale about a tame dolphin on the north coast of Africa (ix. 33). He discourses on the beauties of the Clitumnus (viii. 8) and the floating islands of the Vadimonian lake (viii. 20). He describes an eruption of Vesuvius in connexion with the last days of the Elder Pliny (vi. 16 and 20), giving elsewhere an account of his manner of life and a list of his writings (iii. 5). He laments the death of Silius Italicus (iii. 7), of Martial (iii. 21), and of Verginius Rufus (ii. 1), and of others less known to fame. He takes as his models Cicero and Tacitus (vii. 20), whose name is so often (to his delight) associated with his own (ix. 23). He rejoices to learn that his writings are read at Lyons (ix. 11). He complains of the inanity of circus-races (ix. 6), of the decay of interest in public recitations (i. 13), of bad taste in matters of hospitality (ii. 6), and of the way in which time is frittered away in the social duties of Rome (i. 9). He lays down the principles that should guide a Roman governor in Greece (viii. 24); he maintains the cause of the oppressed provinces of Spain and Africa; and he exposes the iniquities of the informer Regulus, the only living man whom he attacks in his *Letters*, going so far as to denounce him as *omnium bipedum nequissimus* (i. 5, 14).

The *Letters* are models of graceful thought and refined expression, each of them dealing with a single topic and generally ending with an epigrammatic point. They were imitated by Symmachus (Macrobius v. 1, 7) and by Apollinaris Sidonius (*Epp.* ix. 1, 1). In the middle ages they were known to RATHERIUS of Verona (10th century), who quotes a passage from l. 5, 16 (Migne, cxxxvi. p. 391). Selections were included in a volume of *Flores* compiled at Verona in 1320; and a MS. of bks. i.-vii. and ix. was discovered by Guarino at Venice in 1419. These books were printed in the *editio princeps* (Venice, 1471). Part of bk. viii. appeared for the first time at the end of the next edition (Rome, c. 1474). The whole of bk. viii. was first published in its proper place by Aldus Manutius (Venice, 1508).

Pliny's *Correspondence with Trajan* supplies us with many interesting details as to the government of Bithynia, and as to the relations between the governor and the central authority. It reflects the greatest credit on the strict and almost punctilious conscientiousness of the governor, and on the assiduity and the high principle which animated the emperor.

On reaching the province, Pliny celebrates the emperor's birthday, and proceeds to examine the finances of Prusa. His request for a surveyor to check the outlay on the public works is refused on the ground that the emperor has hardly enough surveyors for the works he is carrying on in Rome. He asks the emperor to sanction the repair of the ancient baths at Prusa, the building of an aqueduct at Nicomedia and a theatre at Nicaea, and the covering in of a stream that has become a public nuisance at Amastria. When he consults the emperor as to the baths at Claudiopolis, the emperor sensibly replies: "You, who are on the spot, will be best able to decide" (40). When Pliny hesitates about a small affair relating to Dio Chrysostom (the Bithynian friend of Nerva and Trajan) the emperor betrays a not unnatural impatience in his response: *potuisti non haerere, mi Secunde carissime* (82). Pliny also asks for a decision on the status and maintenance of deserted children (65), and on the custom of distributing public doles on the occasion of interesting events in the life of a private citizen. The emperor agrees that the custom might lead to "political factions," and should therefore be strictly controlled (117). Owing to a destructive fire at Nicomedia, Pliny suggests the formation of a volunteer fire-brigade, limited to 150 members. The emperor is afraid that the fire-brigade might become a "political club," and cautiously contents himself with approving the provision of a fire-engine (34).

Trajan's fear of factions and clubs in these two last cases has sometimes been connected with the question of his attitude towards the Christians in Bithynia. Pliny (*Epp.* 96) states that he had never taken part in formal trials of Christians, and was therefore unfamiliar with precedents as to the extent of the investigation, and as to the degree of punishment. He felt that a distinction might be drawn between adults and those of tender years; and that

allowance might be made for any one who recanted. There was also the question whether any one should be punished simply for bearing the name of Christian or only if he was found guilty of "crimes associated with that name." Hitherto, in the case of those who were brought before him, he had asked them three distinct times whether they were Christians, and, if they persisted in the admission, had ordered them to be taken to execution. Whatever might be the real character of their profession, he held that such obstinate persistence ought to be punished. There were others no less "demented," who, being Roman citizens, would be sent to Rome for trial. Soon, as the natural consequence of these proceedings, a variety of cases had come under his notice. He had received an anonymous statement giving a list of accused persons. Some of them, who denied that they had ever been Christians, had consented to pray to the gods, to adore the image of the emperor, and to blaspheme Christ; these he had dismissed. Others admitted that they were Christians, but presently denied it, adding that they had ceased to be Christians for some years. All of these worshipped images of the gods and of the emperor, and blasphemed Christ. They averred that the sum and substance of their "fault" was that they had been accustomed to meet on a fixed day before daylight to sing in turns a hymn to Christ as God, and to bind themselves by a solemn oath (*sacramento*) to abstain from theft or robbery, and from adultery, perjury and dishonesty; after which they were wont to separate and to meet again for a common meal. This, however, they had ceased to do as soon as Pliny had published a decree against *collegia*, in accordance with the emperor's edict. To ascertain the truth, he had also put to the torture two maid-servants described as deaconesses, but had discovered nothing beyond a perverse and extravagant superstition. He had accordingly put off the formal trial with a view to consulting the emperor. The question appeared to be worthy of such a consultation, especially in view of the number of persons of all ages and ranks, and of both sexes, who were imperilled. The contagion had spread through towns and villages and the open country, but it might still be stayed. Temples that had been well-nigh deserted were already beginning to be frequented, rites long intermitted were being renewed, and the trade in fodder for sacrificial victims was reviving. It might be inferred from this how large a number might be reclaimed, if only room were granted for repentance.

Trajan in his reply (*Epp.* 97) expresses approval of Pliny's course of action in the case of the Christians brought before him. It was impossible (he adds) to lay down any uniform or definite rule. The persons in question were not to be hunted out, but if they were reported and were found guilty, they were to be punished. If, however, any one denied that he was a Christian, and ratified his denial by worshipping the gods of Rome, he was to receive pardon. But no attention was to be paid to *anonymous* charges. It would be a bad precedent and unworthy of the spirit of the age.

The view that the Christians were punished for being members of a *collegium* or *sodalitas* (once held by E. G. Hardy, and still maintained by Professor Merrill) is hard to reconcile with Pliny's own statement that the Christians had promptly obeyed the emperor's decree against *collegia* (§ 7). Further reasons against this view have been urged by Ramsay, who sums up his main results as follows: (1) There was no express law or formal edict against the Christians. (2) They were not prosecuted or punished for contravening any formal law of a wider character. (3) They were judged and condemned by Pliny (with Trajan's full approval) by virtue of the *imperium* delegated to him, and in accordance with the instructions issued to governors of provinces to search out and punish sacrilegious persons. (4) They had already been classed as outlaws, and the name of Christian in itself entailed condemnation. (5) This treatment was a settled principle of imperial policy, not established by the capricious action of a single emperor. (6) While Trajan felt bound to carry out the established principle his personal view was to some extent opposed to it. (7) A definite form of procedure had been established. (8) This procedure was followed by Pliny (W. M. Ramsay, *The Church in the Roman Empire*, p. 223).

It has been well observed by E. G. Hardy that the "double aspect of Trajan's rescript, which, while it theoretically condemned the Christians, practically gave them a certain security," explains "the different views which have since been taken of it; but by most of the church writers, and perhaps on the whole with justice, it has been regarded as favourable and as rather discouraging persecution than legalizing it" (*Pliny's Correspondence with Trajan*, 63, 210-217).

AUTHORITIES.—The correspondence with Trajan was apparently preserved in a single Paris MS.; *Epp.* 41-121 were first printed by Avantius of Verona (1502); and *Epp.* 1-40 by Aldus Manutius (1508). The original MS. has vanished; but the "copy" supplied

to the printers of the Aldine text was discovered by Mr. E. G. Hardy in the Bodleian in 1888. The two letters on the Christians were known to Tertullian (*Apol.* c. 2). The attacks on the genuineness of the whole or part of the collection have been refuted by Wilde (Leiden, 1889).

For a critical edition of text, see H. Keil (Leipzig, 1870), with full index of names by Mommsen; for plain text, Keil (1853), E. C. F. W. Müller (1903); the best annotated editions are those of Gesner and Schaefer (1805) and G. E. Gierig (1796-1806); of the *Letters* alone, G. Korte (1734), and the less trustworthy edition of M. Döring (1843); of bk. I. and II., Cowan (1886); of M. Mayor (1880), with *Life* by G. H. Rendall; of vi., Duff (1904); of the *Panegyricus*, C. G. Schwarz (1846); of the *Correspondence with Trajan*, E. G. Hardy (1889); of *Selected Letters*, E. T. Merrill (1903); best Eng. trans. by J. D. Lewis (1879).

On Pliny's life, see the works by J. Masson (Amsterdam, 1794); H. Schontag (Hof, 1876); and Gieson (Bonn, 1885). On the chronology of the letters, see Mommsen, in *Hermes*, iii. 31-54 (1868); trans. into French by Morel, 1873; criticized by Stubbs (*Philologus*, 1870); Gemoll (Halle, 1872); C. Peter (*Philologus*, 1873); Asbach (*Rhein. Mus.*, 1881); and Schultz (Berlin, 1890). For style, the works of H. Holstein (1862-1866); K. Kraut (1877); J. P. Lagergren (1872); and Morillot (Grenoble, 1888). On the villas, *Burn's Rome and the Campagna* (1871), 411-415; *Archæologia*, in the *Builder* (Feb. 8, 1890); Winnefeld, in *Jahrb. des arch. Inst.* (1891), pp. 201-217; and Magoun, in *Trans. Amer. Philol. Ass.* (1895).

See also bibliography in Hübner and Mayor's *Lat. Lit.* (1875), pp. 147-149; and in Schanz, *Röm. Lit.* §§ 444-449.

For recent literature on Pliny and the Christians, see C. F. Arnald, *Studien* (Königsberg, 1887); Lightfoot, *Apostolic Fathers*, i.; (ed. 1889); Neumann, *Der römische Staat und die allgemeine Kirche* (1890), vol. i.; Mommsen, in *Hist. Zeitschrift* (1890); W. M. Ramsay, *The Church in the Roman Empire* (ed. 1893), ch. 10, pp. 196-205; and E. G. Hardy, *Christianity and the Roman Government* (1894), reprinted in *Studies in Roman History* (1906), pp. 1-162; with the literature quoted in these works and in Schanz, *Röm. Lit.* § 441. (J. E. S.)

PLIOCENE (from the Gr. πλιότιος, more, and *zōon*, recent), in geology, the name given by Sir C. Lyell to the formations above the Miocene and below the Pleistocene (Newer Pliocene) strata. During this period the great land masses of the earth were rapidly approaching to the configuration which they exhibit at the present day. The marine Pliocene deposits are limited to comparatively few areas; in Europe, in the beginning of the period, the sea washed the shores of East Anglia and parts of the south coast of England; it extended well into Belgium and Holland and just touched here and there on the northern and north-western coasts of France; it sent an arm some distance up the valley of the

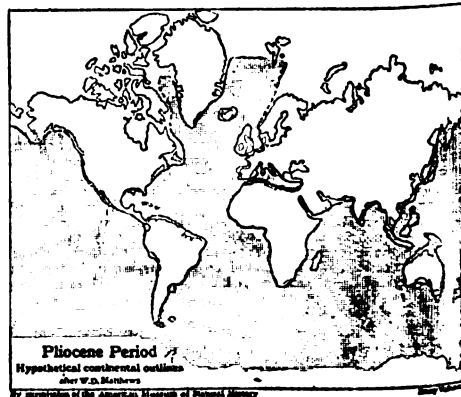

Guadalquivir and formed small bays on several points of the southern coast of France; and up the Rhone basin a considerable gulf reached as far as Lyons. Early in the period the sea covered much of Italy and Sicily; but the eastward extension of the ancient Mediterranean in south-east Europe, through the Danube basin, the Aral, north Caucasian and Caspian regions, continued to suffer the process of coarction in lagoons and large lakes which had begun in the Miocene

Generally all over the world the majority of Pliocene formations are non-marine, and the limited and local nature of the elevations since the inception of the period has exposed to view only the shallow marginal marine deposits. The principal exception to the last statement is to be found in the Pliocene of Italy and Sicily, where a continuous crustal depression permitted the accumulation of great thicknesses of material, which later on, towards the close of the period, were elevated some thousands of feet. With these deformatory movements are associated the Italian volcanoes; Etna certainly began its career beneath the sea, for its older tuffs are found interstratified with marine beds, and possibly some of the others had a similar origin. At the same time volcanic outbursts, some apparently comparable to that of Martinique in recent times, were taking place in central France, while far away in southern Sumatra thousands of feet of submarine tuffs were being thrown out and deposited, and great lava flows were being erupted in Australasia.

Considerable differences of opinion are exhibited among geologists as to the lower limits of the Pliocene formations; this is partly to be accounted for by the absence of widely-spread marine deposits, and partly by the comparatively short time-differences between one deposit and another, and hence the similarity of the faunas of contiguous strata-groups in local vertical series of beds. Following A. de Lapparent (*Traité de géologie*, 5th ed., 1906), we shall regard the Pliocene as divisible into three stages: an upper Sicilian stage, a middle Asian stage, and a lower Plaisancian stage. Other writers, however, have selected a different nomenclature, which often involves a different grouping of the formations; thus E. Kayser in his *Formationskunde* (3rd ed., 1908) distinguishes three stages under the names Arnian (upper), Asian (middle) and Messinian (lower) = Zanclean. The lower stage, however, includes the Pontian, Epplesheim, Pikermi and other formations which are here placed in the Miocene. This stage has been referred to a so-called Mio-Pliocene inter-period.

The Pliocene rocks of Britain now occupy but a small area in Norfolk, Suffolk and part of Essex; but from the presence of small outlying patches in Cornwall (St Erth and St Agnes), Dorsetshire (Dewlish) and Kent (Lenham), it is evident that the Pliocene Sea covered a considerable part of southern England. Moreover, these patches show by their present altitude above the sea that the Downs of Kent must have been elevated more than 850 ft., and the west coast of Cornwall 400 ft. since Pliocene times. The Pliocene rocks rest with strong unconformity upon the older strata in Britain. In the eastern counties the shelly, sandy beds are called "Crag"; this name has come into very general use for all the members of the series, and it is frequently employed as a synonym for Pliocene.

The English Pliocene strata are classified by the Geological Survey of England and Wales as follows:—

	Newer Pliocene	{	<i>Yoldia (Leda) myalis</i> bed (provisionally placed here).
			Forest-bed group and Dewlish gravels with <i>Elephas meridionalis</i> .
			Weybourne crag (and Chillesford clay?).
			Chillesford crag.
			Norwich crag and <i>Scrobicularia</i> crag.
	Older Pliocene	{	Red crag of Butley.
			Red crag of Walton, Newbourn and Oakley.
			St Erth and St Agnes beds.
			Coralline crag.
			Lenham beds (Diestian).
			Box-stones and phosphatic beds with derived early Pliocene and other fossils.

The box-stones are rounded pieces of brown earthy sandstone containing casts of fossils; the phosphatic beds contain the phosphatized bones of whale, deer, mastodon, pig, tapir, rhinoceros, &c., and have been worked as a source of manure. These basal conglomerate deposits underlie the red crag and sometimes the coralline crag. The last-named formation, known also as the "white" or "Suffolk crag," or as the "Bryozoa crag" (it was the presence of Bryozoa which led to the name coralline), is essentially a shell bank, which was accumulated at a depth of from 20 to 40 fathoms. It is best exposed near Aldeburgh and Gedgrave in Suffolk. The Red Crags are sandy, marine, shallow-water deposits, with an abundant fauna; they vary rapidly from point to point, and in general the more southern localities are richer in southern (older) forms than those farther north. The Norwich crag (fluvio-marine or mammaliferous

crag) is not always very clearly marked off from the Red Crags. Marine fresh-water and land shells are found in these beds, together with many mammalian remains, including *Elephas antiquus*, *Mastodon arvernensis*, *Equus stenonis*, *Cervus carnioliarum*, and dolphins, cod and other fish. The Forest-Bed group or Cromer forest-bed is exposed beneath the boulder clay cliffs of the Norfolk coast; it contains transported stumps of trees and many plants still familiar in Britain, many living fresh-water and estuarine molluscs and a large number of mammals, many of which are extinct (*Machaerodus*, *Canis lupus*, *Ursus spelaeus*, *Hyæna crocuta*, *Hippopotamus amphibi-*, *Bison*, *Rhinoceros atricus*, *Elephas antiquus* and *E. meridionalis*, *Bison bonasus*, *Ovis moschatus*, numerous species of deer, *Equus caballus* and *E. stenonis*, *Castor fiber*, *Talpa europæa* and many others). The only record of Pliocene remains in the northern part of England consists of a few teeth of *Elephas meridionalis* found in a fissure in the limestones at Dove Hole, Derbyshire.

The Pliocene deposits of Belgium and Holland and the northern extremity of France are closely related with those of Britain, though as a whole they are very much thicker. The older marine beds may be traced from Lenham across the Channel at Calais and through Cassel to Dieet. The newer marine Pliocene runs in a parallel belt to the north of the older beds through Antwerp. Belgian geologists have divided the local Pliocene into the following groups (from above downwards): Poederlian, Scaldisian, Casterlian, Diestian. F. W. Harmer (*Quart. Journ. Geol. Soc.*, 1898 and 1900) proposed the following scheme for the Pliocene of Britain and the Low Countries:—

- Cromerian = Forest-bed of Cromer.
- Iceno-Cromerian = Chillesford beds and Weybourne crag.
- Iccenian = marine crag of Norwich.
- Amatelian = Red Crag, comprising the Newbournian and Butleyan sub-stages.
- Waltonian = Walton crag and Poederlian and Scaldisian.
- Gedgravian = Coralline crag and Casterlian.
- Lenhamian = Diestian.

In addition to the deposits just mentioned in French Flanders, the early Pliocene sea has left numerous small patches of marls and sands in Brittany and Normandy. In southern France marine sands, gravels and marls of Plaisancian and Astian ages occur in the depression of Roussillon, followed by Sicilian marls and gravels. In Languedoc (Montpellier, Nîmes, Béziers) marine marls and sands are followed by calcareous conglomerate (40 metres) or by marls and lignite; gravels and loams constitute the uppermost beds. In the Rhone basin the earliest deposit is the Congeria beds of Bollene (Vaucluse); this brackish formation differs from the beds of the same name in Vienna, but resembles those of Italy and Rumania. Then followed a marine invasion (*groupe de Saint-Ariès*); these beds are now found at considerable elevations increasing northward and westward. The later formations in this area are fluvial or lacustrine in origin, with remarkable torrential gravel deposits at several horizons. The marine Pliocene of the maritime Alps, consisting of blue and yellow clays and limestone, are now elevated 170 metres above the sea, and even up to 350 m. in the neighbourhood of Nice. In central France no marine beds are found, but many interesting and in some cases highly fossiliferous deposits occur in association with volcanic rocks, such as the lower conglomerate and upper trachytic breccia of Perrier (Isaïre), the fine tuffs (cinerites) with plants of Cantal, the lignitiferous sandstones beneath the basalt of Cézallier, the diatomite of Ceyssac, &c. In Italy, Pliocene rocks form the low ranges of hills on both sides of the Apennines, hence the term "sub-Apennine" given to these rocks by A. d'Orbigny. They are marine marls and sands; the blue marls which crop out near Rome at the base of Mt Mario and Mt Vatican with the succeeding sands and gravels; the conglomerate followed by deep-sea marls of Calabria, and the marls, sands, limestones and blue clay of Sicily, all belong to the Plaisancian stage. To the next stage belong the yellow sands full of massive fossils, including the conglomerate of Castrovillari in Calabria and the white marls of the Val d'Arno. In the final (Sicilian) stage fluvio-lacustrine sands and gravels are found in Italy, except in Calabria and in Sicily where thick marine beds were formed. In Switzerland some of the deposits of *Negetsch* and *Deckenschotter*, glacial plateau gravels, belong to the Sicilian stage. In south-eastern Europe a great series of sands and marls with lignites, termed the Paludina beds, rests directly upon the Pontian formation. From their great development in the Levant, they have been given the rank of a "Levantine stage" by F. von Hochstetter; they are found in Dalmatia, Croatia, Slavonia, Bosnia, Rumania, Bulgaria, southern Russia, the Cyclades, and the Caspian region. On the north coast of Africa marine and brackish sands and marls occur in Morocco, Algeria and Egypt; and the "rifts" of the Red Sea and Suez have been assigned to this period.

In North America marine Pliocene is found fringing the coasts of California and the Gulf of Mexico. In the latter region marine marls, clays and limestones are best developed in Florida and can be traced into the Carolinas and Virginia; they have been classed as the Lafayette group (with lignites), the Florida group, and the Calooshatichis stage. On the Pacific coast the marine beds have attained great thicknesses, notably in the Merced series of San Francisco. In the San Luis Obispo region the non-marine Paso Robles beds, said to be 1000 ft. thick, belong to this period. Other local formations of

marine origin in California are those of San Diego and Wild Cat. In the Rocky Mountains are large lacustrine formations of considerable thickness, and certain conglomerates in Wyoming and Bishop Mountain are assigned to this age. The sands and clays with gypsum of Entre Rios in South America contain fossils of the Atlantic type.

Lignitiferous shale with petroleum and great thickness of volcanic tuffs have been found in southern Sumatra. In New South Wales Pliocene river terraces and alluvial deposits are covered by Mid-Pliocene lavas and from these "deep leads" or buried river beds much gold has been obtained. In Victoria great basaltic and doleritic flows have filled up the Pliocene river valleys, and marine beds have been found at elevations of 1000 ft. above present sea-level. Very similar deposits and volcanic rock, belonging to the Wanganui system of F. W. Hutton, are found in New Zealand.

See C. Reid, "The Pliocene Deposits of Britain" (*Mem. Geol. Survey*, 1890); E. T. Newton, "The Vertebrates of the Pliocene Deposits of Britain" (*Mem. Geol. Survey*, 1891) (both contain a bibliography); C. Reid, *Origin of the British Flora* (1899); and "Geological Literature" (*Geol. Soc. London Annual*, since 1893). (J. A. H.)

PLOCK, or **POŁSK**, a government of Russian Poland, on the right bank of the Vistula, having the Prussian provinces of West and East Prussia on the N. and the Polish governments of Lomza on the E. and Warsaw on the S. Its area is 4760 sq. m. Its flat surface, 350 to 500 ft. above the sea-level, rises gently towards the north, where it merges into the Baltic coast-ridge of the Prussian lake district. Only a few hills reach 600 ft. above

TABLE OF PLIOCENE FORMATIONS.

Stages.	England.	Belgium and Holland.	Rhone Basin.	Languedoc and Roussillon.	Italy.	Eastern Europe.	Other Countries.
Sicilian.	Cromer Forest Bed. Fluvio-marine Norwich crag. Red crag of Suffolk.	Clays of Campine. Amstelian.	Marls of St Cosme. Gravels of Chagny. Conglomerates of Chambaran.	Durfort beds with <i>Elephas meridionalis</i> .	Sands of Val d'Arno. Limestones of Palermo and clays with northern mollusca.	Upper Paludina (<i>Vivipara</i>) beds.	Marine beds of Entre Rios. Volcanic tuffs of S. Sumatra.
Astian.	Base of Red crag.	Poederlian. Scaldisian sands with <i>Trophon antiquum</i> .	Sands of Trevoix and Mollon. Travertine of Meximieux.	Conglomerates of Montpellier and Fourres. Sands of Roussillon with <i>Mastodon arvernensis</i> .	Marls of Val d'Arno with <i>Mastodon arvernensis</i> . Yellow sands of Asti, Plaisantin, Monte Maria and Tuscany. Conglomerates of Castrovillari.	Middle Paludina beds.	Petroleum-bearing beds of Sumatra. Marine sands of Moghara and Mokatta.
Plaisancian.	Coralline crag. Lenham beds.	Sands with <i>Isocardia car.</i> Diestian sandstones.	Marine marls of Bresee, Hauterivea, Congeria beds of Bollene.	Yellow sands of Montpellier. Blue marls of Millas.	Blue marls of Piacenza, Bologna, and Vatican.	Lower Paludina beds.	Marine beds of Florida. Lacustrine beds of Rocky Mountains.

Life of the Pliocene Period.—Sir C. Lyell defined the Pliocene strata as those which contained from 36-95% of living marine mollusca. This rule can no longer be strictly applied to the widely scattered marine deposits, and it is of course inapplicable to the very numerous formations of lacustrine and fluvial origin. On the whole the marine organisms are very like their living representatives, and there is often practically no specific difference; *Nassa*, *Volsia*, *Chenopus*, *Dentalium*, *Fusus*, *Arca*, *Pecten*, *Pectunculus*, *Panopaea*, *Cyprina* and *Macra* may be mentioned among the marine genera; *Congeria* (*Dreysenista*), *Auricula*, *Paludina*, *Melanopsis* and *Helix* are found in the lacustrine deposits. One of the most interesting facts exposed by the study of the mollusca is the gradual lowering of the temperature of Europe during the period. In Britain the early Pliocene was, if anything, warmer than at present, but the percentage of northern forms ascends steadily through the higher beds, and finally arctic forms, such as *Buccinum groenlandicum*, *Trichopteria borealis*, *Mya truncata*, *Cyprina islandica*, &c., appear on the coasts of Norfolk and Suffolk, and some of the northern species even reached the Mediterranean (Sicily) at the close of the period. The flora exhibits the same gradual change, the large palms and camphor trees disappeared from Europe, the sabel palm lingered in Languedoc, and *Chamerops humilis* lived about Marseilles until the end; the sequoias and bamboos held on for some time, and the aspect of the vegetation in mid-Pliocene times was not unlike that of Portugal, Algeria and Japan of to-day. Not a few species that dwell in Pliocene Europe are found in the forests of America. The flora of the Cromer forest beds is very like that of the same district at the present time. The mammals of the British Pliocene show a curious blending of northern and southern forms; they include *Machaerodus* (the sabre-toothed lion), hyenas, dogs, fox, wolf, glutton, marten, bears, *Ursus arvernensis* and the grizzly and cave bear, seals, whales, dolphins, bison, musk ox, gazelle, the red deer and many others now extinct, the roebuck, pigs and wild boar, hippopotamus, hipparion and horse (*Equus caballus* and *E. stenonis*), several species of rhinoceros, tapir, hyrax, elephants (*Elephas meridionalis* and *E. antiquus*), several mastodons, squirrel, beaver, hare, mice, voles, &c. The mastodon disappeared from Europe before the close of the period, but lived much longer in America. No generally accepted fossil man has been found in the Pliocene; *Pithecanthropus erectus*, found by E. Dubois in Java, is the nearest to the human type. Monkeys, *Macacus* and *Semnopithecus*, occur in the Pliocene of Europe. At this time the Pliocene mammals of North America were able to migrate into South America, and a few of the southern forms travelled northwards.

the sea, while the broad valley of the Vistula has an elevation of only 130 to 150 ft. In the west (district of Lipno) broad terraces, covered with forests, small lakes and ponds, and very poor in vegetation, descend from the Baltic lake-district towards the plains of Plock; and in the central district of Mlawa extensive marshes fill the upper basin of the Wkra. The Vistula borders the government on the south, almost all the way from Warsaw to Thorn, receiving the Skrwa and Wkra. The Drwica, or Drewenz, flows along the north-west boundary, while several small tributaries of the Narew drain the north-eastern district of Ciechanow. Peat-bogs, used for fuel, and marshes containing bog-iron, fill many depressions in the north, while the more elevated parts of the plains are covered with fertile clays, or a kind of "black earth." Lacustrine post Glacial deposits fill all the depressions of the thick sheet of boulder clay, with Scandinavian erratic boulders, which extends everywhere over the Tertiary sands and marls—these last containing masses of silicated wood and lignite. Layers of gypsum are found in the hills beside the Vistula.

The estimated population in 1906 was 619,000. About one-third are Jews and 36,000 Germans. The government is divided into seven districts, of which the chief towns are Plock, Ciechanow, Lipno, Mlawa, Prasnysy, Rypin and Sierpc. Agriculture is the chief industry. The principal crops are rye, oats, barley, wheat and potatoes; beetroot is cultivated for sugar, especially on the large estates of the west, where modern machinery is used. Gardening and bee-keeping are extensively practised. In the north the property is much divided, and the landholders, very numerous in Ciechanow, are far from prosperous. The forests have been lavishly cut, but Plock is still one of the best wooded governments (20%) in Poland. Other occupations are provided by shipping on the Vistula, mining and various domestic industries, such as the fabrication of wooden cars, sledges and wheels, and textile industry. The manufactures include flour-mills, saw-mills, sugar factories, distilleries, tanneries, breweries,

agricultural implement works, match factories and ironworks. There is some export trade, especially in the Lipno district; but its development is hampered by lack of communications, the best being those offered by the Vistula. The railway from Warsaw to Danzig, via Ciechanow and Mlawa, serves the eastern part of the government.

After the second dismemberment of Poland in 1793, what is now the government of Plock became part of Prussia. It fell under Russian dominion after the treaty of Vienna (1815), and, in the division of that time into five provinces, extended over the western part of the present government of Lomza, which was created in 1864 from the Östrolenka and Pultusk districts of Plock, together with parts of the province of Augustowo.

PLOCK, or **Plotsk**, a town of Russia, capital of the government of the same name, on the right bank of the Vistula, 67 m. by the Vistula W.N.W. of Warsaw. Pop. 27,073. It has a cathedral, dating from the 12th century, but restored in 1903, which contains tombs of Polish dukes and of Kings Ladislaus and Boleslav (of the 11th and 12th centuries). There is considerable navigation on the Vistula, grain, flour, wool and beetroot being exported, while coal, petroleum, salt and fish are imported.

PLOEN, a town of Germany, in Schleswig-Holstein, beautifully situated between two lakes, the large and the small Ploener-See, 20 m. S. from Kiel by the railway to Eutin and Lubock. Pop. (1905), 3735. It has a palace built about 1630 and now converted into a cadet school, a gymnasium and a biological station. Tobacco, soap, soda, beer and furniture are manufactured, and there is a considerable trade in timber and grain. The lakes afford good fishing, and are navigated in summer by steamboats.

Ploen is mentioned as early as the 11th century as a Wendish settlement, and a fortified place. It passed in 1559 to Duke John the Younger, founder of the line of Holstein-Sonderburg, on the extinction of which, in 1761, it fell to Denmark, and in 1867, with Schleswig-Holstein, to Prussia. The sons of the emperor William II. received their early education here.

See H. Eggers, *Schloss und Stadt Ploen* (Kiel, 1877), and J. C. Kinder, *Urkundenbuch zur Chronik der Stadt Ploen* (Plön, 1890).

PLOENNIES, LUISE VON (1803-1872), German poet, was born at Hanau on the 7th of November 1803, the daughter of the naturalist Philipp Achilles Leisler. In 1824 she married the physician August von Ploennies in Darmstadt. After his death in 1847 she resided for some years in Belgium, then at Jugenheim on the Bergstrasse, but finally at Darmstadt, where she died on the 22nd of January 1872. Between 1844 and 1870 she published several volumes of verse, being particularly happy in eclectic love songs, patriotic poems and descriptions of scenery. She also wrote two biblical dramas, *Maria Magdalena* (1870) and *David* (1873).

As a translator from the English, Luise von Ploennies published two collections of poems, *Britannia* (1843) and *Englische Lyriker des 19ten Jahrhunderts* (1863, 3rd ed., 1867).

PLOËRMEL, a town of western France, capital of an arrondissement in the department of Morbihan, 36 m. N.N.E. of Vannes by rail. Pop. (1906), town, 2492; commune, 5424. The Renaissance church of St Armel (16th century) is remarkable for the delicate carving of the north façade and for fine stained glass. It also possesses statues of John II. and John III., dukes of Brittany, which were transferred to the church from their tomb in an ancient Carmelite monastery founded in 1273 and destroyed by the Protestants in 1592 and again at the Revolution. The lower ecclesiastical seminary has an apartment in which the Estates of Brittany held several meetings. Remains of ramparts of the 15th century and some houses of the 16th century are also of interest. Farm-implements are manufactured, slate quarries are worked in the neighbourhood, and there is trade in cattle, wool, hemp, cloth, &c. Plotrnel (Plou Armel, people of Armel) owes its name to Armel, a hermit who lived in the district in the 6th century.

PLOESCI (*Ploescii*), the capital of the department of Prahova, Rumania; at the southern entrance of a valley among the Carpathian foothills, through which flows the river Prahova; and at the junction of railways to Buzeu, Bucharest and Hermannstadt in

Transylvania. Pop. (1900), 42,687. As the name Ploesci (*Musiens*, rainy) implies, the climate is moist. The surrounding hills are rich in petroleum, salt and lignite. There are cardboard factories, roperies, tanneries and oil mills. Ploesci possesses schools of commerce and of arts and crafts, several banks, and many synagogues and churches, including the Orthodox church of St Mary, built in 1740 by Matthew Bassarab.

PLOMBIÈRES, a town of eastern France, in the department of Vosges, on a branch line of the Eastern railway, 17 m. S. of Epinal by road. Pop. (1906), 1882. The town is situated at a height of 1410 ft. in a picturesque valley watered by the Augroane. It is well known for its mineral springs, containing sodium sulphate and silicic acid, varying from 66° to 166° F. Plombières has a handsome modern church and a statue of the painter Louis François, born in the town in 1814. The waters were utilized by the Romans and during the middle ages. In later times Montaigne, Richelieu, Stanislas, duke of Lorraine and Voltaire were among the distinguished people who visited the place. Napoleon III. built the most important of the bathing establishments and made other improvements.

PLOT, ROBERT (1640-1666), English naturalist and antiquary, was born at Borden in Kent in 1640. He was educated at Wye, and at Magdalen Hall, Oxford, where he graduated B.A. in 1661, and proceeded to M.A. (1664) and D.C.L. (1671). He was distinguished for his folio work *The Natural History of Oxfordshire* (1677), in which various fossils, as well as other objects of interest, were figured and described. It was regarded as a model for many subsequent works. In 1677 Plot was elected F.R.S., and he was secretary for the Royal Society from 1682 to 1684. He was appointed in 1683 the first keeper of the Ashmolean Museum at Oxford, and in the same year he became professor of chemistry. In 1686 he wrote *The Natural History of Staffordshire*. Two years later he became historiographer-royal. He died on the 30th of April 1666.

PLOT, a term originally meaning a space of ground used for a specific purpose, especially as a building site, formerly in frequent usage in the sense of a plan, a surveyed space of ground; hence the literary sense of a plan or design. The word is of doubtful origin; there is a collateral form "plat," which appears in the 16th century, according to the *New English Dictionary*, under the influence of "plat," flat place, surface (Fr. *plat*, Late Lat. *plattus*, probably from Gr. *πλατῆς*, broad). Skeat (*Etym. Dict.*) refers "plot," in the sense of a space of ground, to the O. Eng. *placc*, Mid. Eng. *pleck*, later *platch*, patch. "Plot," in the sense of plan, scheme, would then be identical with "plot," a conspiracy, which may be a shortened form of "complot," a French word, also of doubtful origin, meaning in the 12th century "a compact body of men"; in the 14th century "conspiracy."

PLOTINUS (A.D. 204-270), the most important representative of Neoplatonism, was born of Roman parents at Lycopolis in Egypt. At Alexandria he attended the lectures of Ammonius Saccas (*q.v.*), the founder of the system, until 242, when he joined the Persian expedition of Gordian III., with the object of studying Persian and Indian philosophy on the spot. After the assassination of Gordian in 244, Plotinus was obliged to take refuge in Antioch, whence he made his way to Rome and set up as a teacher there. He soon attracted a large number of pupils, the most distinguished of whom were Amelius, Eustochius and Porphyry. The emperor Gallienus and his wife Salonina were also his enthusiastic admirers, and favoured his idea of founding a Platonic Commonwealth (Platonopolis) in Campania (cf. Bishop Berkeley's scheme for the Bermuda Islands), but the opposition of Gallienus's counsellors and the death of Plotinus prevented the plan from being carried out. Plotinus's wide popularity was due partly to the lucidity of his teaching, but perhaps even more to his strong personality. Assent developed into veneration; he was considered to be divinely inspired, and generally credited with miraculous powers. In spite of ill-health, he continued to teach and write until his death, which took place on the estate of one of his friends near Minturnae in Campania.

Under Ammonius Plotinus became imbued with the eclectic spirit of the Alexandrian school. Having accepted the Platonic metaphysical doctrine, he applied to it the Neo-Pythagorean principles and the Oriental doctrine of Emanation (*q.v.*). The results of this introspective mysticism were collected by him in a series of fifty-four (originally forty-eight) treatises, arranged in six "Enneads," which constitute the most authoritative exposition of Neoplatonism. This arrangement is probably due to Porphyry, to whose editorial care they were consigned. There was also another ancient edition by Eustochius, but all the existing MSS. are based on Porphyry's edition.

The *Enneades* of Plotinus were first made known in the Latin translation of Marsilio Ficino (Florence, 1492) which was reprinted at Basel in 1580, with the Greek text of Petrus Perna. Later editions by Creuzer and Moser ("Didot Series," 1855), A. Kirchoff (1856), H. F. Müller (1878-1880), R. Volkman (1883-1884). There is an English translation of selected portions by Thomas Taylor, re-edited in Bohn's *Philosophical Library* (1895, with introduction and bibliography by C. R. S. Mead).

On Plotinus generally see article in Suidas; *Eunapius vitae sophistarum*; and above all the *Vita Plotini* by his pupil Porphyry. Among modern works, see the treatises on the school of Alexandria by J. F. Simon, i. (1845), and E. Vacherot (1846); A. Richter, *Ueber Leben und Geistesentwicklung des Plotin* (Halle, 1864-1867); T. Whittaker, *The Neoplatonists* (1901); A. Drews, *Plotin und der Uebergang der antiken Weltanschauung* (1907); E. Caird, *Evolution of Theology in the Greek Philosophers* (1904), ii. 210-257; Rufus M. Jones, *Studies in Mystical Religion* (1909). A detailed account of Plotinus's philosophical system and an estimate of its importance will be found in the article NEOPLATONISM, the works above referred to, and the histories of philosophy. For his list of categories, see CATEGORIES; also LOGOS; MYSTICISM; MAGIC.

PLOUGH AND PLOUGHING. To enable the soil to grow good crops the upper layer must be pulverized and weathered. This operation, performed in the garden by means of the spade, is carried on in the field on a larger scale by the plough,¹ which breaks the soil and by inverting the furrow-slice, exposes fresh surfaces to the disintegrating influence of air, rain and frost.

The first recorded form of plough is found on the monuments of Egypt, where it consists simply of a wooden wedge tipped with iron and fastened to a handle projecting backwards and a beam, pulled by men or oxen, projecting forwards. Many references to the plough are found in the Old Testament, notably that in 1 Sam. xiii. 20: "All the Israelites went down to the Philistines to sharpen every man his *share* and his *coulters*." Descriptions of ploughs found in Hesiod's *Works and Days* and in Virgil's *Georgics* i. 169-175, show little development in the implement. The same may be said of the Anglo-Saxon ploughs. These are shown with coulters and share and also with wheels, which had in earlier times been fitted to ploughs by the Greeks and also by the natives of Cis-Alpine Gaul (Pliny, *Hist. nat.* 18, 18). A mattock with which to break the clods is often found represented in Anglo-Saxon drawings as subsidiary to the plough. All these types of plough are virtually hoes pulled through the ground, breaking but not inverting the soil. In the first half of the 18th century a plough with a short convex mould-board of wood was introduced from the Netherlands into England and, as improved at Rotherham in Yorkshire, became known as the Rotherham plough and enjoyed considerable vogue. At this period ploughs were made almost wholly of wood, the mould-board being cased with plates of iron. Small, of Berwickshire, brought out a plough in which beam and handle were of wrought

¹The O. Eng. form is *plōh*, which is usually found in the sense of "plough-land," a unit for the assessment of land (see HIDE), the regular O. Eng. word for the implement being *sūh*, still found in some dialects in the form *sūl*. It appears in many Teutonic languages, cf. Du. *ploeg*, Ger. *Pflug*, Swed. *plög*, Dan. *plow*. The Slavonic forms, such as Russ. or Pol. *plug*, are borrowed from the German. It does not appear in Gothic, where the word used is *hoka*. The ultimate origin of "plough" is unknown. Max-Müller (*Science of Language*, i. 296) connects the word with the Indo-European root meaning "to float," seen in the Gr. *πλοῖον*, a boat or ship; the same word would be applied to the ship "ploughing" through the waves, and to the implement "ploughing" through the earth. A Celtic origin has been suggested, connecting the word with Gael. *plow*, stump of a tree, as forming the original plough. The form "plow" was common in English until the beginning of the 18th century, and is usual in America.

iron, the mould-board of cast iron. The shares, when made of the same material, required constant sharpening; this necessity was removed by the device, patented by Robert Ransome in 1803, of chilling and so hardening the under-surface of the share; the upper surface, which is soft, then wears away more quickly than the chilled part, whereby a sharp edge is always assured. Nowadays the mould-board is of steel with a chilled and polished surface to give greater wearing qualities and to reduce friction. In the latter part of the 19th century there were numerous improvements but no fundamental alterations in the construction of the ordinary plough.

The working parts of the plough are the *coulters*, the *share*, and the *breast* or *mould-board*. These are carried on the *beam*, to which are attached the *handles* or *tilts* at the back, and the *hake* or *clevis* and *draught-chain* at the front. The *hake* is notched so that, by moving the draught-chain higher or lower thereon, the plough is caused to go more or less deeply into the ground. It may also be adjusted to suit the height of the horses used. The *hake* moves laterally on a quadrant and it is thus possible to give the plough a tendency to left or right by moving the *hake* in the reverse direction. A *frame* is bolted to the beam and this carries the breast or mould-board to the fore-end of which the share is fitted. The *side-cap*, a plate of



Newcastle Plough.

iron fixed to the land-side of the frame, is intended to keep the edge of the unploughed soil vertical and prevent it from falling into the furrow. A piece of iron called the *stade* is bolted to the bottom of the frame, and this, running along the sole of the furrow, acts as a base to the whole implement. The *coulters* (cūber knife or disk) and sometimes a *skim-coulters* (or *jointer*) are attached adjustably to the beam, so as to act in the front of the share.

The coulters is a knife or revolving disk which is fixed so that its point clears the point of the share. The skim-coulters is shaped like a miniature plough, substituted for or fixed in front of the coulters; it is used chiefly on lea land, to pare off the surface of the soil together with the vegetation thereon, and turn it into the previous furrow, where it is immediately buried by the furrow slice. Two wheels of unequal height are commonly fitted to the front of the beam. By means of them the depth and width of the furrow are regulated, whereas in the case of "swing" or wheelless ploughs these points depend chiefly on the skill of the ploughman. In the wheeled plough some of the weight and downward pull due to its action on the ground is taken by the wheels; the sliding friction is thus to some extent converted into a rolling friction, and the draught is correspondingly diminished.

In operation the coulters makes a perpendicular cut separating the furrow-slice which is divided from the "sole" of the furrow

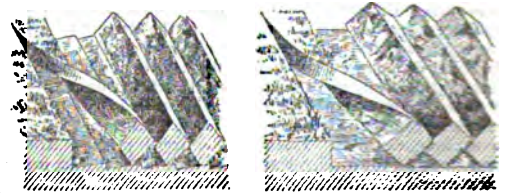

Crested Furrow.

Rectangular Furrow.

by the share and then inverted by the curve of the breast as the plough moves forward. The process is indicated in the illustration of different types of furrow. The form of a furrow is

regulated by the shape and width of the share, working in combination with a proper shaped breast. A "crested" furrow is obtained by the use of a share, the wing of which is set at a higher altitude than the point, but this type of furrow

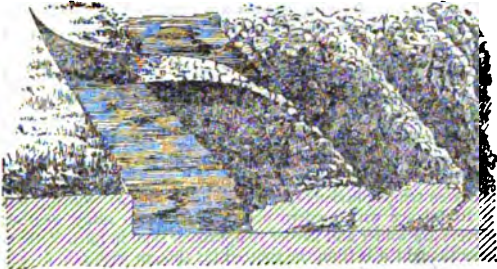

Wide Broken Furrow.

is less generally found than the "rectangular" form obtained by a level-edged share, which leaves a flat bottom.

During the greater part of the 19th century the ideal of ploughing was to preserve the furrow-slice unbroken, and this object was attained by the use of long mould-boards which turned the



Digging Plough.

slices gently and gradually, laying them over against one another at an angle of 45° , thus providing drainage at the bottom of the furrow, and exposing the greatest possible surface to the influences of the weather. Subsequently the digging plough came into vogue; the share being wider, a wider furrow is cut, while the slice is inverted by a short concave mould-board with a sharp turn which at the same time breaks up and pulverizes the soil after the fashion of a spade. Except on extremely heavy soils or on shallow soils with a subsoil which it is unwise to bring upon the surface, the modern tendency is in favour of the digging plough.

A ploughed field is divided into lands or sections of equal width separated by furrows. On light easy draining land 22 yds. is the usual width; on the heaviest lands it may be as little as 5 yds., and in the latter case the furrows will act as drains into which the water flows from the intervening ridges.¹

Certain important variations of the ordinary plough demand consideration. The one-way plough lays the furrows alter-

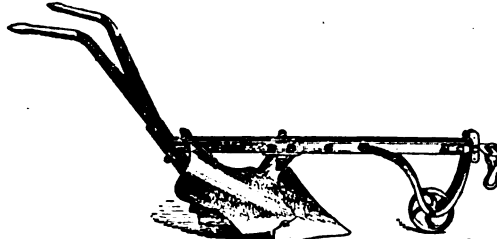

Turnwrest Plough.

nately to its left and right, so that they all slope in the same direction. This is found advantageous on hill-sides where the work is easier if all the furrows are turned downhill; or from another point of view the furrows may be all laid uphill so as to

¹ Methods of the "setting-out" of land to be ploughed together with a full discussion of other technical details relating to ploughing will be found in ch. vii. of W. J. Maiden's *Workman's Technical Instructor* (London, 1905).

counteract the tendency for the soil to work down the slope. One-way ploughs also leave the land level and dispense with the wide open furrows between the ridges which are left by the ordinary plough. They are made on different principles. One type comprises two separate ploughs, one right hand and one left, which revolve on the beam, one working, while the other stands vertically above it. In another the mould-board and

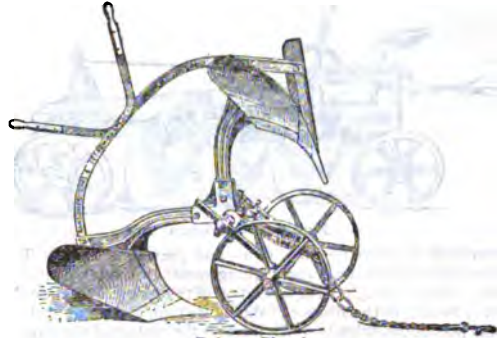

Balance Plough.

share are shaped so that they can be swung on a swivel under the beam when the latter is lifted. A third type is made on the "balance" principle, two plough beams with mould-boards being placed at right angles to one another, so that while the right-hand plough is at work the left-hand is elevated above the ground.

Double-furrow or multiple ploughs are a combination of two or more ploughs arranged in echelon so as to plough two or more furrows. The weight of these implements necessitates some provision for turning them at the headlands, and this is supplied either by a bowl wheel, enabling the plough to be turned on one side, or by a pair of wheels cranked so that they can be raised by a lever when the plough is working. The double-furrow

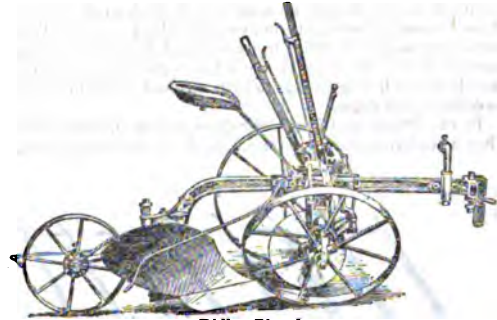

Riding Plough.

plough was known as early as the 17th century, but, till the introduction of the latter device by Ransome in 1873, cannot be said to have been in successful use.

The "sulky" or riding plough is little known in the United Kingdom, but on the larger arable tracts of other countries where quick work is essential and the character of the surface permits, it is in general use. In this form of plough the frame is mounted on three wheels, one of which runs on the land, and the other two in the furrow. The furrow wheels are placed on inclined axles, the plough beam being carried on swing links, operated by a hand lever when it is necessary to raise the plough out of the furrow. The land wheel and the forward furrow wheel are adjustable vertically with reference to the frame, for the purpose of controlling the action of the plough.

In the disk plough, which is built both as a riding and a walking plough, the essential feature is the substitution of a concavo-

convex disk, pivoted on the plough beam, for the mould-board and share of the ordinary plough. This disk is carried on an axle inclined to the line of draught, and also to a vertical plane. As the machine is drawn forward the disk revolves and cuts deeply into the ground, and by reason of its inclination crowds the earth outwards and thus turns a furrow. A scraper is

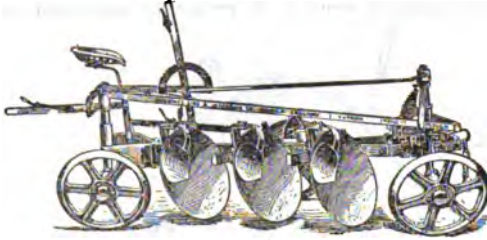

Multiple Disk Plough.

provided to keep the disk clean and prevent sticking. The controlling levers and draught arrangements are similar to those in the "sulky" plough. The advantage of this plough over the ordinary form is in the absence of sliding friction, and in the mellow and porous condition in which it leaves the bottom of the furrow.

Disk ploughs are unsuitable for heavy sticky soils and for stony land, but may be used with effect on stubbles and on land in a dry hard state. Perhaps their most common use is in ploughing on a large scale in conjunction with steam power.

Steam is employed as motive power when it is necessary to plough large areas in a short time. In the United Kingdom steam ploughing is generally carried on on the double-engine system (introduced by Messrs John Fowler about 1865), in which case two sets of ploughs are arranged on the one-way balance principle, so that while one set is at work the other is carried clear of the ground. In this arrangement, a pair of locomotive engines, each having a plain winding drum fixed underneath the boiler, are placed opposite to each other at the ends of the field to be operated upon; the rope of each of the engines is attached to the plough, or other tillage implement, which is drawn to and fro betwixt them by each working in turn. While the engine in gear is coiling in its rope and drawing the plough towards itself, the rope of the other engine is paid out with merely so much drag on it as to keep it from kinking or getting ravelled on the drum.

In the United States and elsewhere engines drawing behind them a number of ploughs, arranged in echelon and taking perhaps

The *sub-soil plough* has the beam and body but not the mould-board of an ordinary plough. Following in the furrow of an ordinary plough it breaks through the sub-soil to a depth of several inches, making it porous and penetrable by plant roots.

Gripping and draining ploughs are employed in opening the grips and trenches necessary both in surface and underground drainage.

See Davidson and Chase, *Farm Motors and Farm Machinery*; articles in L. H. Bailey's *Cyclopaedia of American Agriculture* (New York, 1907) and *Standard Encyclopaedia* (London, 1908), &c.

PLOVER, a bird whose name (Fr. *pluvier*, O. Fr. *pluvier*) doubtless has its origin in the Latin *pluvia*, rain (as witness the German equivalent *Regenpfeifer*, rain-fifer). P. Belon (1555) says that the name *Pluvier* is bestowed "pour ce qu'on le prend mieux en temps pluvieux qu'en nulle autre saison," which is not in accordance with modern observation, for in rainy weather plovers are wilder and harder to approach than in fine. Others have thought it is from the spotted (as though with rain-drops) upper plumage of two of the commonest species of plovers, to which the name especially belongs—the *Charadrius plumbeus* of Linnaeus, or golden plover, and the *Squatarola helvetica* of recent ornithologists, or grey plover. Both these birds are very similar in general appearance, but the latter is the larger and has an aborted hind-toe on each foot.¹ Its axillary feathers are also black, while in the golden plover they are pure white. The grey plover is a bird of almost circumpolar range, breeding in the far north of America, Asia and eastern Europe, frequenting in spring and autumn the coasts of the more temperate parts of each continent, and generally retiring farther southward in winter—examples not unfrequently reaching Cape Colony, Ceylon, Australia and even Tasmania. *Charadrius plumbeus* has a much narrower distribution, though where it occurs it is much more numerous. Its breeding quarters do not extend farther than from Iceland to western Siberia, but include the more elevated tracts in the British Islands, whence in autumn it spreads itself, often in immense flocks, over the cultivated districts if the fields be sufficiently open. Here some will remain so long as the absence of frost or snow permits, but the majority make for the Mediterranean basin, or the countries beyond, in which to winter; and stragglers find their way to the southern extremity of Africa. Two other cognate forms, *C. virginicus* and *C. fulvus*, respectively represent *C. plumbeus* in America and eastern Asia, where they are also known by the same English name. The discrimination of these two birds from one another requires a very acute eye,² but both are easily distinguished from their European ally by their smaller size, their greyish-brown axillary feathers, and their proportionally longer

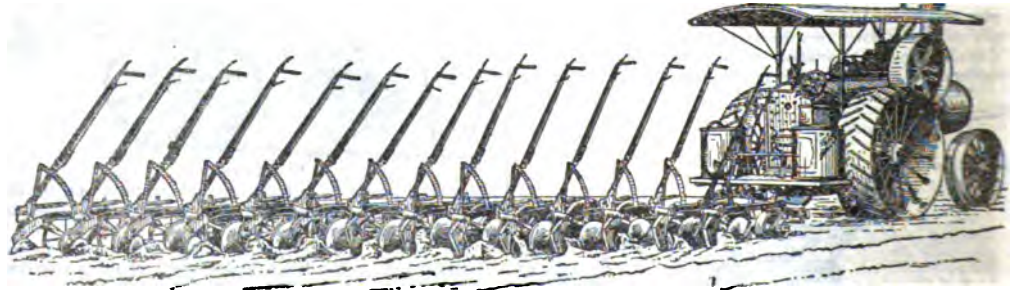

American Steam Plough.

30 ft. at a time, are frequently seen. On smaller areas petrol motors with one or more ploughs attached are sometimes used.

There is a large variety of ploughs which differ in their purpose from the ordinary plough.

The *ridging plough* is an implement with a mould-board on each side, terminating in front in a flat point, and used for moulding up potatoes, and for throwing up the ridge on which to plant roots.

and more slender legs. All, however—and the same is the case with the grey plover—undergo precisely the same seasonal

¹ But for this really unimportant distinction both birds could doubtless have been kept by ornithologists in the same genus, for they agree in most other structural characters.

² Schlegel (*Mus. Pays-Bas, Cursors*, p. 53) states that in some examples it seems impossible to determine the form to which they belong; but ordinarily American specimens are rather larger and stouter, and have shorter toes than those from Asia.

change of colour, greatly altering their appearance and equally affecting both sexes. In spring or early summer nearly the whole of the lower plumage from the chin to the vent, which during winter has been nearly pure white, becomes deep black. A corresponding alteration is at the same season observable in the upper plumage.

Though the birds just spoken of are those most emphatically entitled to be called plovers, the group of ringed plovers (see KILLDEER and LARWING), with its allies, has, according to usage, hardly less claim to the name, which is also extended to some other more distant forms that can here have only the briefest notice. Among them one of the most remarkable is the "Zickzack" (so-called from its cry)—the *τροχιδος* of Herodotus (see HUMMING-BIRD), the *Pluvianus* or *Hyns aegyptius* of ornithologists, celebrated for the services it is said to render to the crocodile—a small bird whose plumage of delicate lavender and cream colour is relieved by markings of black and white. This belongs to the small family *Glaucidae*, of which the members best known are the coursers, *Cursorix*, with some eight or ten species inhabiting the deserts of Africa and India, while one, *C. gallicus*, occasionally strays to Europe and even to England. Allied to them are the curious pratincoles (*q.v.*), also peculiar to the Old World, while the genera *Thinocoris* and *Attagis* form an outlying group peculiar to South America, that is by some systematists regarded as a separate family *Thinocoridae*, near which are often placed the singular Shearwaters (*q.v.*). By most authorities the Stone-curlews (see CURLEW), the Oyster-catchers (*q.v.*) and Turnstones (*q.v.*) are also regarded as belonging to the family *Charadriidae*, and some would add the Avocets (*Recurvirostra*) and Stilts (*q.v.*), among which the Cavalier, or Crab-plover, *Dromas ardeola*—a form that has been banded about from one family and even order to another—should possibly find its resting-place. It frequents the sandy shores of the Indian Ocean and Bay of Bengal from Natal to Aden, and thence to Ceylon, the Malabar coast, and the Andaman and Nicobar Islands—a white and black bird, mounted on long legs, with webbed feet, and a bill so shaped as to have made some of the best ornithologists lodge it among the Terns (*q.v.*).

Though the various forms here spoken of as plovers are almost certainly closely allied, they must be regarded as constituting a very indefinite group, for hardly any strong line of demarcation can be drawn between them and the Sandpipers and Snipes (*q.v.*). United, however, with both of the latter under the name of *Limicolidae*, after the method approved by the most recent systematists, the whole form an assemblage the compactness of which no observant ornithologist can hesitate to admit, even if he be uncertain of the exact kinship.

For "plovers' eggs" see LARWING.

(A. N.)

PLUCK, to pull or pick off something, as flowers from a plant, feathers from a bird. The word in O. Eng. is *plucian* or *ploccian* and is represented by numerous forms in Teutonic languages, cf. Ger. *plücken*, Du. *plukken*, Dan. *plukke*, &c. In sense and form a plausible identification has been found with Ital. *pluccare*, to pick grapes, hair, feathers, cf. Fr. *plucher*, pick. These romanian words are to be referred to Lat. *plūs*, hair, which has also given "peruke" or "periwig" and "plush." Difficulties of phonology, history and chronology, however, seem to show that this close similarity is only a coincidence. "Pluck," in the sense of courage, was originally a slang word of the prize-ring, and Sir W. Scott (*Journal*, Sept. 4, 1827) speaks of the "want of that article blackguardly called *pluck*." In butcher's parlance the "pluck" of an animal is the heart, liver and lungs, probably so called from their being "plucked" or pulled out of the carcass immediately after slaughtering. The heart being the typical seat of courage, the transference is obvious. In university colloquial or slang use, "to pluck" is to refuse to pass a candidate on examination; the more usual colloquial word is now "to plough." At the granting of degrees at Oxford objection to a candidate could be taken for other reasons than failure at examination, and the person thus challenging drew the attention of the proctor in congregation by "plucking" a piece of black silk attached to the back of his gown.

PLÜCKER, JULIUS (1801-1868), German mathematician and physicist, was born at Elberfeld on the 16th of June 1801. After being educated at Düsseldorf and at the universities of Bonn, Heidelberg and Berlin he went in 1823 to Paris, where he came under the influence of the great school of French geometers, whose founder, Gaspard Monge, was only recently dead. In 1825 he was received as *Privatdozent* at Bonn, and after three years he was made professor extraordinary. The title of his "habilitationsschrift," "*Generalem analysos applicationem ad ea quae geometriae aliorum et mechanicis basis et fundamenta sunt a serie Tayloria deductis Julius Plücker* (Bonn, 1824), indicated the course of his future researches. The mathematical influence of Monge had two sides represented respectively by his two great works, the *Glométrie descriptive* and the *Application de l'analyse à la géométrie*. Plücker aimed at furnishing modern geometry with suitable analytical methods so as to give it an independent analytical development. In this effort he was as successful as were his great contemporaries Poncelet and J. Steiner in cultivating geometry in its purely synthetic form. From his lectures and researches at Bonn sprang his first great work, *Analytisch-geometrische Entwicklungen* (vol. I, 1828; vol. II, 1831).

In the first volume of this treatise Plücker introduced for the first time the method of abridged notation which has become one of the characteristic features of modern analytical geometry (see GEOMETRY, ANALYTICAL). In the first volume of the *Entwickelungen* he applied the method of abridged notation to the straight line, circle and conic sections, and he subsequently used it with great effect in many of his researches, notably in his theory of cubic curves. In the second volume of the *Entwickelungen* he clearly established on a firm and independent basis the great principle of duality.

Another subject of importance which Plücker took up in the *Entwickelungen* was the curious paradox noticed by L. Euler and G. Cramer, that, when a certain number of the intersections of two algebraical curves are given, the rest are thereby determined. Gergonne had shown that when a number of the intersections of two curves of the $(p+q)$ th degree lie on a curve of the p th degree the rest lie on a curve of the q th degree. Plücker finally (*Gergonne Ann.*, 1828-1829) showed how many points must be taken on a curve of any degree so that curves of the same degree (infinite in number) may be drawn through them, and proved that all the points, beyond the given ones, in which these curves intersect the given one are fixed by the original choice. Later, simultaneously with C. G. J. Jacobi, he extended these results to curves and surfaces of unequal order. Allied to the matter just mentioned was Plücker's discovery of the six equations connecting the numbers of singularities in algebraical curves (see CURVE). Plücker communicated his formulae in the first place to *Crelle's Journal* (1834), vol. xii., and gave a further extension and complete account of his theory in his *Theorie der algebraischen Curven* (1839).

In 1833 Plücker left Bonn for Berlin, where he occupied a post in the Friedrich Wilhelm's Gymnasium. He was then called in 1834 as ordinary professor of mathematics to Halle. While there he published his *System der analytischen Geometrie, auf neue Betrachtungsweise gegründet, und insbesondere eine ausführliche Theorie der Curven dritter Ordnung enthaltend* (Berlin, 1835). In this work he introduced the use of linear functions in place of the ordinary co-ordinates; he also made the fullest use of the principles of collineation and reciprocity. His discussion of curves of the third order turned mainly on the nature of their asymptotes, and depended on the fact that the equation to every such curve can be put into the form $ppq + ps = 0$. He gives a complete enumeration of them, including two hundred and nineteen species. In 1836 Plücker returned to Bonn as ordinary professor of mathematics. Here he published his *Theorie der algebraischen Curven*, which formed a continuation of the *System der analytischen Geometrie*. The work falls into two parts, which treat of the asymptotes and singularities of algebraical curves respectively; and extensive use is made of the method of counting constants which plays so large a part in modern geometrical researches.

From this time Plücker's geometrical researches practically ceased, only to be resumed towards the end of his life. It is true that he published in 1846 his *System der Geometrie des*

Roumes in neuer analytischer Behandlungsweise, but this contains merely a more systematic and polished rendering of his earlier results. In 1847 he was made professor of physics at Bonn; and from that time his scientific activity took a new and astonishing turn.

His first physical memoir, published in *Poggendorfs Annalen* (1847), vol. lxxii., contains his great discovery of magnecrystalline action. Then followed a long series of researches, mostly published in the same journal, on the properties of magnetic and diamagnetic bodies, establishing results which are now part and parcel of our magnetic knowledge. In 1858 (*Pogg. Ann.* vol. ciii.) he published the first of his classical researches on the action of the magnet on the electric discharge in rarefied gases.

Plücker, first by himself and afterwards in conjunction with J. W. Hittorf, made many important discoveries in the spectroscopy of gases. He was the first to use the vacuum tube with the capillary part now called a Geissler's tube, by means of which the luminous intensity of feeble electric discharges was raised sufficiently to allow of spectroscopic investigation. He anticipated R. W. Y. Bunsen and G. Kirchhoff in announcing that the lines of the spectrum were characteristic of the chemical substance which emitted them, and in indicating the value of this discovery in chemical analysis. According to Hittorf he was the first who saw the three lines of the hydrogen spectrum, which a few months after his death were recognised in the spectrum of the solar protuberances, and thus solved one of the mysteries of modern astronomy.

Hittorf tells us that Plücker never attained great manual dexterity as an experimenter. He had always, however, very clear conceptions as to what was wanted, and possessed in a high degree the power of putting others in possession of his ideas and rendering them enthusiastic in carrying them into practice. Thus he was able to secure from the Sayner Hütte in 1846 the great electromagnet which he turned to such use in his magnetic researches; thus he attached to his service his former pupil the skilful mechanic Fessel; and thus he discovered and fully availed himself of the ability of the great glass-blower Geissler.

Induced by the encouragement of his mathematical friends in England, Plücker in 1865 returned to the field in which he first became famous, and adorned it by one more great achievement—the invention of what is now called "line geometry." His first memoir on the subject was published in the *Philosophical Transactions* of the Royal Society of London. It became the source of a large literature in which the new science was developed. Plücker himself worked out the theory of complexes of the first and second order, introducing in his investigation of the latter the famous complex surfaces of which he caused those models to be constructed which are now so well known to the student of the higher mathematics. He was engaged in bringing out a large work embodying the results of his researches in line geometry when he died on the 22nd of May 1868. The work was so far advanced that his pupil and assistant Felix Klein was able to complete and publish it (see *GZOMSKY, LINE*). Among the very numerous honours bestowed on Plücker by the various scientific societies of Europe was the Copley medal, awarded to him by the Royal Society two years before his death.

See R. F. A. Clebsch's obituary notice (*Abh. d. kön. Ges. d. Wiss. u. Göttingen*, 1871, vol. xvi.), to which is appended an appreciation of Plücker's physical researches by Hittorf, and a list of Plücker's works by F. Klein. See also C. I. Gerhardt, *Geschichte der Mathematik in Deutschland*, p. 282, and Plücker's life by A. Dronke (Bonn, 1871).

PLUM, the English name both for certain kinds of tree and also generally for their fruit. The plum tree belongs to the genus *Prunus*, natural order Rosaceae. Cultivated plums are supposed to have originated from one or other of the species *P. domestica* (wild plum) or *P. insititia* (bullace). The young shoots of *P. domestica* are glabrous, and the fruit oblong; in *P. insititia* the young shoots are pubescent, and the fruit more or less globose. A third species, the common sloe or blackthorn, *P. spinosa*, has stout spines; its flowers expand before the leaves; and its fruit is very rough to the taste, in which particulars it differs from the two preceding. These

distinctions, however, are not maintained with much constancy. *P. domestica* is a native of Anatolia and the Caucasus, and is considered to be the only species naturalized in Europe. *P. insititia* is wild in southern Europe, in Armenia, and along the shores of the Caspian. In the Swiss lake-dwellings stones of the *P. insititia* as well as of *P. spinosa* have been found, but not those of *P. domestica*. Nevertheless, the Romans cultivated large numbers of plums. The cultivated forms are extremely numerous, some of the groups, such as the greengages, the damsons and the egg plums being very distinct, and sometimes reproducing themselves from seed. The colour of the fruit varies from green to deep purple, the size from that of a small cherry to that of a hen's egg; the form is oblong acute or obtuse at both ends, or globular; the stones or kernels vary in like manner; and the flavour, season of ripening and duration are all subject to variation. From its hardihood the plum is one of the most valuable fruit trees, as it is not particular as to soil, and the crop is less likely to be destroyed by spring frosts. Prunes and French plums are merely plums dried in the sun. Their preparation is carried on a large scale in Bosnia and Servia, as well as in Spain, Portugal and southern France.

Plums are propagated chiefly by budding on stocks of the Mussel, Brussels, St Julien and Pear plums. The damson, wine-sour and other varieties, planted as standards, are generally increased by suckers. For planting against walls, trees which have been trained for two years in the nursery are preferred, but maiden trees can be very successfully introduced, and by liberal treatment may be speedily got to a fruiting state. Any good well-drained loamy soil is suitable for plums, that of medium quality as to lightness being decidedly preferable. Walls with an east or west aspect are generally allowed to them. The horizontal mode of training and the fan or half-fan forms are commonly followed; where there is sufficient height probably the fan system is the best. The shoots should be laid in nearly or quite at full length. The fruit is produced on small spurs on branches at least two years old, and the same spurs continue fruitful for several years. Standard plum trees should be planted 25 ft. apart each way, and dwarfs 15 or 20 ft. The latter are now largely grown for market purposes, being more easily supported when carrying heavy crops, fruiting earlier, and the fruit being gathered more easily from the dwarf bush than from standard trees.

The following is a selection of good varieties of plums, with their times of ripening:—

Dessert Plums.

Early Green-gage	e. July	Transparent Gage	b. Sept.
Early Transparent Gage	b. Aug.	Jefferson	b. Sept.
Denniston's Superb	b. Aug.	Kirke	m. Sept.
Oullin's Golden	m. Aug.	Coe's Golden Drop	e. Sept.
Green-gage	m.e. Aug.	Reine Claude de Bayay	e. Sept.
M'Laughlin's	e. Aug.	Ickworth Imperatrice	b. Oct.
Angelina Burdett	b. Sept.	Late Rivers	b. Nov.

Culinary Plums.

Early Prolific	e. July	Victoria	Sept.
Belle de Louvain	Aug.	White Magnum Bonum	Sept.
Belgian Purple	m. Aug.	Pond's Seedling	m. Sept.
Car	e. Aug.	Diamond	m. Sept.
Pershore	e. Aug.	Monarch	e. Sept.
Prince Englebert	e. Aug.	Grand Duke	Oct.
Mitchelsons'	b. Sept.	Wyedale	e. Oct.

Diseases.—The Plum is subject to several diseases of fungal origin. A widespread disease known as pocket-plums or bladder-plums is due to an ascomycetous fungus, *Exosascus pruni*, the mycelium of which lives parasitically in the tissues of the host plant, passes into the ovary of the flower and causes the characteristic malformation of the fruit which becomes a deformed, sometimes curved or flattened, wrinkled dry structure, with a hollow occupying the place of the stone; the bladder plums are yellow at first, subsequently dingy red. The reproductive spores are borne in sacs (*asci*) which form a dense layer on the surface, appearing like a bloom in July; they are scattered by the wind and propagate the disease. The only remedy is to cut off and burn the diseased branches.

Plum-leaf blister is caused by *Polystigma rubrum*, a pyrenomycetous fungus which forms thick fleshy reddish patches on the leaves.

The reproductive spores are formed in embedded flesh-shaped receptacles (perithecia) and scattered

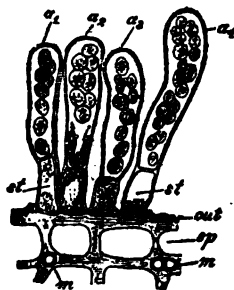

(After Sadebeck. From Strauburger's *Lehrbuch der Botanik*, by permission of Gustav Fischer.)

Taphrina Pruni.—Transverse section through the epidermis of an infected plum. Four ripe asci, *a*₁, *a*₂, *a*₃, with eight spores *a*₁, *a*₂, with yeast-like conidia abstracted from the spores.

st, Stalk-cells of the asci.
m, Filaments of the mycelium cut transversely.
cut, Cuticle.
ep, Epidermis.

after the leaves have fallen. The spots are not often so numerous as to do much harm to the leaves, but where the disease is serious diseased leaves should be collected and burned. Sloes and bird-cherries should be removed from the neighbourhood of plum-trees, as the various disease-producing insects and fungi live also on these species. The branches are sometimes attacked by weevils (*Rhynchites*) and the larvae of various moths, and saw-flies (chiefly *Eriocampa*) feed on the leaves, and young branches and leaves are sometimes invaded by Aphides. Leaf-feeding beetles and larvae of moths are best got rid of by shaking the branches and collecting the insects. Slug-worms or saw-fly larvae require treatment by washing with soapsuds, tobacco and lime-water or hellebore solution, and Aphides by syringing from below and removing all surplus young twigs.

PLUMBAGO (from Lat *plumbum*, lead), a name frequently applied to graphite (*q.v.*), in allusion to its remote resemblance to lead, whence it is popularly called "black-lead." It was formerly held in repute

in medicine, but is now regarded as having no medicinal properties of any value.

PLUMBAGO DRAWINGS. What we should now speak of as pencil drawings were in the 17th and 18th centuries usually known as drawings "in plumbago," and there is a group of artists whose work is remarkable for their exquisite portraits drawn with finely pointed pieces of graphite and upon vellum. In some books of reference they are grouped as engravers, and as such Horace Walpole describes several of them. There is no doubt that many of their fine pencil drawings were prepared for the purpose of engraving, but this is not likely to have been the case with all, and we have evidence of certain commissions executed, by Forster for example, when the portrait was not required for the preparation of a plate. One of the earliest of this group of workers was Simon Van de Pass (1595?-1647), and in all probability his pencil drawings were either for reproduction on silver tablets or counters or for engraved plates. A very few pencil portraits by Abraham Blooteling, the Dutch engraver, have been preserved, which appear to have been first sketches, from which plates were afterwards engraved. They are of exceedingly delicate workmanship, and one in the present writer's collection is signed and dated. By David Loggan (1635-1700), a pupil of Van de Pass, there also remain a few portraits, as a rule drawn on vellum and executed with the utmost dexterity and with marvellous minuteness, the lines expressing the intricacies of a lace ruffle or the curls of a wig being perfectly rendered. It is evident that these were not always prepared for engraving, because there is one representing Charles II., set in a beautiful gold snuff box, which was given by the king to the duchess of Portsmouth and now belongs to the duke of Richmond, and a similar portrait of Cromwell in the possession of Lord Verulam, while several others belong to Lord Caledon, and there are no engravings corresponding to these. On the other hand, a large drawing by Loggan in the writer's collection, representing Charles II., is the sketch for the finished engraving and bears a declaration to that effect. An artist who is better known to the general collector is William Faithorne (1616-1691). He was the pupil of Sir Robert Peake, the engraver, but derived much of his skill from the time he spent with Nanteuil, whose involved minute style he closely followed, triumphing over technical difficulties with great success. There are important drawings by him in the Bodleian, at Welbeck

Abbey and at Montagu House, and two fine portraits in the British Museum. Thomas Forster (b. 1695-1712) was one of the greatest draughtsmen in this particular form of portraiture. His drawings are both on vellum and on paper, as a rule on vellum. Of the details of his life very little is known. He engraved a few prints, but they are of the utmost rarity. His finest portraits are executed with very great refinement and delicacy, the modelling of the face being quite wonderful. It is in fact one of the marvels of this type of portraiture how such exquisite lines could have been drawn with the roughly cut pieces of graphite which were at the disposal of the artists. In some instances in Forster's work the lines representing the modelling of the face are so fine as to be quite indistinguishable without the aid of a glass. His work can be studied at Welbeck Abbey, in the Holburne Museum at Bath, in the Victoria and Albert Museum and elsewhere. Two other Englishmen should be referred to, Robert and George White, father and son. The former (1645-1704) was a pupil of Loggan and a prolific engraver, and most of his drawings, executed on vellum, were for the purpose of engraving. George White (c. 1684-1732) was taught by his father, and finished some of his father's plates. His own pencil drawings are of even finer execution than those of Robert White. These three men, Forster and the two Whites, carefully signed their drawings and dated them. By Robert White there are remarkable portraits of Bunyan and Sir Matthew Hale in the British Museum, and his own portrait at Welbeck; and by him and his son there are other drawings in private collections, depicting Sir Godfrey Kneller, Archbishop Tennyson and others. The two Fabers (1667-1721 and 1695?-1756) were from Holland, the elder having been born at the Hague, as he himself states on his portrait which was in Vertue's collection. In addition to the portraits these two men usually added beautiful drawn inscriptions, often found within circles around the portraits and occasionally extending to many lines below them. The son was the greater artist and a famous mezzotinter. The portrait painter Jonathan Richardson (1665-1745) executed many fine drawings in pencil, examples of which can be seen in the British Museum. One of the best of these plumbago draughtsmen was a Scotsman, whose work is of the utmost rarity, David Paton, who worked in 1670. The chief of his drawings belong to the earl of Dysart and are at Ham House, and two examples of his portraiture are in the possession of the Dalzell family. Of Paton's history nothing is known save that he was a Catholic who worked for more than one Dominican house, a devoted adherent of the Stuart cause, and was attached to the court of Charles II., when the king was in Scotland. At that time he drew his remarkable portrait of the king now at Ham House. There are drawings of the same character as his, the work of George Glover (d. 1618) and Thomas Ceccill (c. 1630), but they are of extraordinary rarity and were evidently first studies for engravings. Of Glover's work the only signed example known is in the writer's collection. A Swiss artist, Joseph Werner (b. 1637) or Waerner, drew well in pencil, adopting brown paper as the material upon which his best drawings were done, and in some cases heightening them with touches of white paint. The most notable of his portraits is one which is in the collection at Welbeck Abbey. The earlier miniature painters also drew in this manner, notably Hilliard in preparing designs for jewels and seals, and Isaac and Peter Oliver in portraits. By Isaac Oliver there is a fine drawing in Lord Derby's collection; and one by Peter, a marvellous likeness of Sir Bevil Grenville, in that of the writer. The later men, Hone, Grimaldi, Lens and Downman, also drew finely in plumbago. Other notable exponents of this delightful art were Thomas Worlidge (1700-1766), F. Steele (c. 1714), W. Robins (c. 1730), G. A. Wolfgang (1692-1775), George Vertue the engraver (1684-1756), Johann Zoffany (1733-1810), and the Swede, Charles Bancks (c. 1748), who resided in England for some years. (G. C. W.)

PLUMBING, properly working in lead (Lat. *plumbum*), now a term embracing all work not only in lead, but also in tin, zinc and other metals, connected with the installation, fitting, repairing, soldering, &c., of pipes for water, gas, drainage, on cisterns, roofs and the like in any building, *i.e.* the general work of a plumber. (See BUILDING and SEWERAGE.)

PLUMPTRE, EDWARD HAYES (1821-1891), English divine and scholar, was born in London on the 6th of August 1821. A scholar of University College, Oxford, he graduated with a double-first class in 1844, and in the same year he was elected fellow of Brasenose College. He was ordained in 1847, and shortly afterwards appointed chaplain, and then professor of pastoral theology, at King's College, London. In 1865 he was given a prebendal stall at St Paul's, and from 1869 to 1874 he was a member of the committee appointed by Convocation to revise the authorized version of the Old Testament. He was Boyle lecturer in 1866-1867 ("Christ and Christendom"), and Grinfield lecturer on the Septuagint at Oxford 1872-1874. After successively holding the livings of Pluckley and Brickley in Kent, he was installed in 1881 as dean of Wells. He died on the 1st of February 1891.

Plumptre was a man of great versatility and attained high reputation as a translator of the plays of Sophocles (1865) and Aeschylus (1868), and of the *Divina Commedia* of Dante (1866). In verse his main achievements were *Lazarus* (1864), and *Master and Scholar* (1866). Among his many theological works may be mentioned *An Exposition of the Epistles to the Seven Churches of Asia* (1877), *The Spirits in Prisons* (1884), "The Book of Proverbs" (which he annotated in the *Speaker's Commentary*), the "Synoptic Gospels, Acts, and II. Corinthians," in *Bishop Ellicott's New Testament Commentary*, and *Life of Bishop Ken* (1888).

PLUNDER, to rob, to pillage, especially in war. The word came into English usage directly from Ger. *plundern* (derived from a substantive *Plunder* meaning "household stuff," bed-clothes, clothing, &c.), particularly with reference to the pillaging of the Thirty Years' War. Thomas May (*History of the Long Parliament*, 1647; quoted in the *New English Dictionary*) says: "Many Townes and Villages he (Prince Rupert) plundered, which is to say robb'd, for at that time first was the word plunder used in England, being borne in Germany." The *New English Dictionary's* earliest quotation is from the *Swedish Intelligencer* (1632).

PLUNKET, OLIVER (1629-1681), Irish Roman Catholic divine, was born at Loughcrew, Co. Meath. He was educated privately and at Rome, whither he went with Father Scarampi in 1645. From 1657 to 1669 he was professor of theology at the College of the Propaganda, enjoyed the friendship of the historian, Pallavicini, and acted as representative of Irish ecclesiastical affairs at Rome. Pope Clement IX. appointed him to the archbishopric of Armagh and primacy of Ireland in July 1669, and in November he was consecrated at Ghent, reaching Ireland in March 1670. Lord Berkeley of Stratton, the viceroy, showed him much kindness and allowed him to establish a Jesuit school in Dublin. Plunket showed amazing diligence in furthering the cause of his Church. He was in very straitened circumstances, the revenue of his see being only £62 in good years. The repressive measures following on the Test Act bore hardly upon him, and in December 1678 he was imprisoned in Dublin Castle for six weeks. Accused of a share in the Irish branch of the "Popish Plot," he was brought to London, and in June 1681 arraigned in the King's Bench, charged with conspiring to bring a French army to Carlingford. He made a good defence, but on the absurdest of evidence the jury convicted him of treason, and on the 1st of July he was hanged, drawn and quartered at Tyburn.

PLUNKET, WILLIAM CONYNGHAM PLUNKET, 1ST BARON (1764-1854), Irish lawyer, orator and statesman, was born in the county of Fermanagh in July 1764.¹ He was educated first by his father, a Presbyterian minister of considerable ability and reputation, and in 1779 he became a student of Trinity College, Dublin. He was conspicuous as the acknowledged leader of the Historical Society, the debating club of Trinity College, then full of young men of remarkable promise. Having entered Lincoln's Inn in 1784, Plunket was called to the Irish bar in 1787. He gradually obtained a considerable practice in equity; and was made a king's counsel in 1797.

¹ The Irish Plunkets are distinguished by the spelling of the name from the Plunketts of the families of the barons Dunany (cr. 1439) and the earls of Fingall (cr. 1628), though the earlier members of these houses are often given the spelling of Plunket.

In 1798 he entered the Irish parliament as member for Charlemont. He was an anti-Jacobin Whig of the school of Burke, not ungracefully filled with a fervent Irish patriotism. But he was a sincere admirer of the constitutional government of England as established in 1688; he even justified the ascendancy it had given to the Established Church, although he thought that the time had arrived for extending toleration to Roman Catholics and dissenters. To transfer it to Ireland as thus modified, and under an independent legislature, was the only reform he sought for his country; he opposed the union because he thought it incompatible with this object.

When Plunket entered the Irish parliament, the Irish Whig party was almost extinct, and Pitt was feeling his way to accomplish the union. In this he was seconded ably by Lord Castlereagh, by the panic caused by a wild insurrection, and by the accession of Grattan from politics. When, however, the measure was brought forward, among the ablest and fiercest of its adversaries was Plunket, whose powers as a great orator were now universally recognized. His speeches raised him immediately to the front rank of his party; and when Grattan re-entered the moribund senate he took his seat next to Plunket, thus significantly recognizing the place the latter had attained.

After the union Plunket returned to the practice of his profession, and became at once a leader of the equity bar. In 1803, after Emmet's rebellion, he was selected as one of the Crown lawyers to prosecute the unfortunate enthusiast, and at the trial, in summing up the evidence, delivered a speech of remarkable power, which shows his characteristic dislike of revolutionary outbursts. For this speech he was exposed to much unmerited obloquy, and more especially to the abuse of Cobbett, against whom he brought a successful action for damages. In 1803, in Pitt's second administration, he became solicitor-general, and in 1805 attorney-general for Ireland; and he continued in office when Lord Grenville came into power in 1806. Plunket held a seat in the Imperial parliament during this period, and there made several able speeches in favour of Catholic emancipation, and of continuing the war with France; but when the Grenville cabinet was dissolved he returned once more to professional life.

In 1812, having amassed a considerable fortune, he re-entered parliament as member for Trinity College, and identified himself with the Grenville or anti-Gallican Whigs. He was soon acknowledged as one of the first orators, if not the first, of the House of Commons. His reverence for the English constitution in church and state, his steady advocacy of the war with Napoleon, and his antipathy to anything like democracy made him popular with the Tory party. In 1822 Plunket was once more attorney-general for Ireland, with Lord Wellesley as lord-lieutenant. One of his first official acts was to prosecute for the "boyle riot," an attempt on his part to put down the Orange faction in Ireland. He strenuously opposed the Catholic Association, which about this time, under the guidance of O'Connell, began its agitation. In 1825 he made a powerful speech against it; thus the curious spectacle was seen of the ablest champion of an oppressed church doing all in his power to check its efforts to emancipate itself.

In 1827 Plunket was made master of the rolls in England; but, owing to the professional jealousy of the bar, who regarded an Irishman as an intruder, he resigned in a few days. Soon afterwards he became chief justice of the common pleas in Ireland, and was then created a peer of the United Kingdom. In 1830 he was appointed lord chancellor of Ireland, and held the office, with an interval of a few months only, until 1834, when he finally retired from public life. He died on the 4th of January 1854, and was succeeded by his eldest son, the bishop of Tuam (1792-1866) as 2nd baron. The 4th baron (1828-1897) was bishop of Meath and afterwards archbishop of Dublin and primate of Ireland, and an active ecclesiastical statesman; and his younger brother David Plunket (b. 1838), solicitor-general for Ireland in 1875-1877, and first commissioner of works in the Unionist administration of 1885-1892, was in 1895 created Baron

Rathmore. William Lee Plunket, 5th baron (b. 1864), was governor of New Zealand from 1904 to 1910.

PLUNKETT, SIR HORACE CURZON (1854-), Irish politician, third son of Edward, 16th baron Dunsany, was born on the 24th of October 1854, and was educated at Eton and University College, Oxford, of which college he became honorary fellow in 1909. He spent ten years (1879-1889) ranching in Montana, U.S.A., where, together with a substantial fortune, he acquired experience that proved invaluable in the work of agricultural education, improvement and development, to which he devoted himself on his return to Ireland in 1889. At first Plunkett resolved to hold himself aloof from party politics, and he set himself to bring together men of all political views for the promotion of the material prosperity of the Irish people. In 1894 he founded the Irish Agricultural Organization Society, which accomplished a work of incalculable importance by introducing co-operation among Irish farmers, and by proving to the latter the benefits obtainable through more economical and efficient management. But already in 1892 he had felt compelled to abandon his non-political attitude, and he entered parliament as Unionist member for south Dublin (county). Continuing, however, his policy of conciliation, Plunkett suggested in August 1895 that a few prominent persons of various political opinions should meet to discuss and frame a scheme of practical legislation. The outcome of this proposal was the formation of the "Recess Committee" with Plunkett as chairman, which included men of such divergent views as the earl of Mayo, Mr John Redmond, The O'Connor Don and Mr Thomas Sinclair. In July 1896 the Recess Committee issued a report, of which Plunkett was the author, containing valuable accounts of the systems of state aid to agriculture and of technical instruction in foreign countries. This report, and the growing influence of Plunkett, who became a member of the Irish Privy Council in 1897, led to the passing of an act in 1899 which established a department of agriculture and technical instruction in Ireland, of which the chief secretary was to be president *ex officio*. Plunkett was appointed vice-president, a position which gave him control of the department's operations. It was intended that the vice-president should be responsible for the department in the House of Commons, but at the general election of 1900 Plunkett lost his seat. An extensively signed memorial, supported by the Agricultural Council, prayed that he might not be removed from office, and at the government's request he continued to direct the policy of the department without a seat in parliament. He was created K.C.V.O. in 1903.

On the accession of the Liberal party to power in 1906, Sir Horace Plunkett was requested by Mr Bryce, the new chief secretary, to remain at the head of the department he had created. But, having sat in the House of Commons as a Unionist, Plunkett had incurred the hostility of the Nationalist party, whose resentment had been further excited by the bold statement of certain unpalatable truths in his book, *Ireland in the New Century* (1904), in which he described the economic condition and needs of the country and the nature of the agricultural improvement schemes he had inaugurated. A determined effort was therefore made by the Nationalists to drive from office the man who had probably done more than any one else of his generation to benefit the Irish people; and in moving a resolution in the House of Commons with this object in 1907, a Nationalist declared that his party "took their stand on the principle that the industrial revival could only go hand in hand with the national movement." The government gave way, and in the summer of 1907 Sir Horace Plunkett retired from office. Since the year 1900 a grant of about £4000 had been made annually by the Department of Agriculture to the Irish Agricultural Organization Society; but the new vice-president, Mr T. W. Russell, who had been himself previously a member of the Unionist administration, withdrew in 1907 this modest support of an association with which Sir Horace Plunkett was so closely identified, and of which he continued to be the guiding spirit. In addition to the publication mentioned, Sir Horace Plunkett published *Noblesse Oblige: An Irish*

Rendering (1908), and *Rural Life Problems of the United States* (1910).

See Sir Horace Plunkett, *Ireland in the New Century* (London, 1904); *Report of the Committee of Inquiry: Department of Agriculture and Technical Instruction (Ireland)*, (Cd. 3372) (1907).

PLURALISM (Lat. *plus*, *plures*, many, several), a term used generally in the sense of plurality (see below), and in philosophy for any theory which postulates more than one absolutely distinct being or principle of being, opposed to monism. Pluralistic systems are based on the difficulty of reconciling with the monistic principle the principles of variety and freewill. The chief difficulty which besets any such view is that if the elements are absolutely independent, the cosmos disappears and we are left with chaos: if, on the other hand, there is interrelation (as in Lotze's system), the elements are not ultimate in any intelligible sense.

PLURALITY (O. Fr. *pluralis*, Late Lat. *plurālis*, plural number), in a general sense, a word denoting more than one; applied particularly to the holding of two or more offices by the same person (called then a *pluralist*). In ecclesiastical law, plurality or the holding of more than one benefice or preferment was always discountenanced, and is now prohibited in England by the Pluralities Act 1838, as amended by the Pluralities Act 1850 and the Pluralities Acts Amendment Act 1885. By the latter act a provision was made that two benefices might be held together, by dispensation of the archbishop on the recommendation of the bishop, if the churches be within four miles of each other, and if the annual value of one does not exceed £200 (see *BENEFICE*). It was formerly a practice to evade enactments against plurality by means of *commendams*, i.e. by committing or commending a benefice to a holder of other benefices until an incumbent should be provided for it. *Commendams* were abolished by the Ecclesiastical Commissioners Act 1836 (6 & 7 Will. IV. c. 77, § 18). See also *Colt v. Bishop of Coventry*, 1613, Hob. 140 seq., where much learning on the subject will be found.

In elections, particularly where there are three or more candidates, and no one candidate receives an absolute majority of votes, the excess of votes polled by the first candidate over the second is often termed plurality, especially in the United States.

PLUSH (Fr. *peluche*), a textile fabric having a cut nap or pile the same as fustian or velvet. Originally the pile of plush consisted of mohair or worsted yarn, but now silk by itself or with a cotton backing is used for plush, the distinction from velvet being found in the longer and less dense pile of plush. The material is largely used for upholstery and furniture purposes, and is also much employed in dress and millinery.

PLUTARCH (Gr. Πλούταρχος) (c. A.D. 46-120), Greek biographer and miscellaneous writer, was born at Chaeronea in Boeotia. After having been trained in philosophy at Athens he travelled and stayed some time at Rome, where he lectured on philosophy and undertook the education of Hadrian.¹ Trajan bestowed consular rank upon him, and Hadrian appointed him procurator of Greece. He died in his native town, where he was archon and priest of the Pythian Apollo. In the *Consolation to his Wife* on the loss of his young daughter, he tells us (§ 2) that they had brought up four sons besides, one of whom was called by the name of Plutarch's brother, Lamprias. We learn incidentally from this treatise (§ 10) that the writer had been initiated in the secret mysteries of Dionysus, which held that the soul was imperishable. He seems to have been an independent thinker rather than an adherent of any particular school of philosophy. His vast acquaintance with the literature of his time is everywhere apparent.

The celebrity of Plutarch, or at least his popularity, is mainly founded on his forty-six *Parallel Lives*. He is thought to have written this work in his later years after his return to Chaeronea. His knowledge of Latin and of Roman history he must have partly derived from some years' residence in Rome and other

¹ There seems no authority for this statement earlier than the middle age.

parts of Italy,¹ though he says he was too much engaged in lecturing (doubtless in Greek, on philosophy) to turn his attention much to Roman literature during that period.

Plutarch's design in writing the *Parallel Lives*—for this is the title which he gives them in dedicating *Theseus* and *Romulus* to Sosius Senecio—appears to have been the publication, in successive books, of authentic biographies in pairs, taking together a Greek and a Roman. In the introduction to the *Theseus* he speaks of having already issued his *Lycurgus* and *Numa*, viewing them, no doubt, as bearing a resemblance to each other in their legislative character. *Theseus* and *Romulus* are compared as the legendary founders of states. In the opening sentence of the life of Alexander he says that "in this book he has written the lives of Alexander and Caesar" (Julius), and in his *Demosthenes*, where he again (§ 1) mentions his friend Sosius, he calls the life of this orator and Cicero the fifth book.² It may therefore fairly be inferred that Plutarch's original idea was simply to set a Greek warrior, statesman, orator or legislator side by side with some noted Roman celebrated for the same qualities, or working under similar conditions. Nearly all the lives are in pairs; but the series concluded with single biographies of Artaxerxes, Aratus (of Sicyon), Galba and Otho. In the life of Aratus, not Sosius Senecio, but one Polycrates, is addressed.

The *Lives* are works of great learning and research, long lists of authorities are given, and they must for this very reason, as well as from their considerable length, have taken many years in compilation. It is true that many of the lives, especially of Romans, do not show such an extent of research. But Plutarch must have had access to a great store of books, and his diligence as an historian cannot be questioned, if his accuracy is in some points impeached. From the historian's point of view the weakness of the biographies is that their interest is primarily ethical. The author's sympathy with Doric characters and institutions is very evident; he delights to record the exploits, the maxims and virtues of Spartan kings and generals. This feeling is the key to his apparently unfair and virulent attack on Herodotus, who, as an Ionian, seemed to him to have exaggerated the prowess and the foresight of the Athenian leaders.

The voluminous and varied writings of Plutarch exclusive of the *Lives* are known under the common term *Opera moralia*. These consist of above sixty essays, some of them long and many of them rather difficult, some too of very doubtful genuineness. Their literary value is greatly enhanced by the large number of citations from lost Greek poems, especially verses of the dramatists, among whom Euripides holds by far the first place. The principal treatises in the *Opera moralia* are the following:—

On the Education of Children (regarded as spurious by some) recommends (1) good birth, and sobriety in the father; (2) good disposition and good training are alike necessary for virtue; (3) a mother ought to nurse her own offspring, on the analogy of all animals; (4) the *paedagogus* must be honest and trustworthy; (5) all the advantages of life and fortune must be held secondary to education; (6) mere mob-oratory is no part of a good education; (7) philosophy should form the principal study, but not to the exclusion of the other sciences; (8) gymnastics are to be practised; (9) kindness and advice are better than blows; (10) over-pressure in learning is to be avoided, and plenty of relaxation is to be allowed; (11) self-control, and not least over the tongue, is to be learned; (12) the grown-up youth should be under the eye and advice of his father, and all bad company avoided, flatterers included; (13) fathers should not be too harsh and exacting, but remember that they were themselves once young; (14) marriage is recommended, and without disparity of rank; (15) above all, a father should be an example of virtue to a son.

How a Young Man ought to Hear Poetry is largely made up of quotations from Homer and the tragic poets. The points of the essay are the moral effects of poetry as combining the true with the false, the praises of virtue and heroism with a mythology depraved and unworthy of gods, *α θεοι τε αληθεα φησιν, οκ ελεν θεοι* (§ 21).

¹ *Demosth.* § 2. Plutarch's orthography of Roman words and names is important as bearing on the question of pronunciation. A curious example (*De fortuna Rom.* § 5) is *Virtutis et honoris*, written *Οὐκ εὐδοκίας τε καὶ ὄνομος*. The Volsci are *Ὀβελδοκίαι*, *ibid.*

² It is quite evident that the original order of the books has been altered in the series of *Lives* as we now have them.

On the Right Way of Hearing (*ἠρωτὸν ἰσχυρῶν*) advocates the listening in silence to what is being said, and not giving a precipitate reply to statements which may yet receive some addition or modification from the speaker (§ 4). The hearer is warned not to give too much weight to the style, manner or tone of the speaker (§ 7), not to be either too apathetic or too prone to praise, not to be impatient if he finds his faults reproved by the lecturer (§ 16). He concludes with the maxim, "to hear rightly is the beginning of living rightly," and perhaps he has in view throughout his own profession as a lecturer.

How a Flatterer may be Distinguished from a Friend is a rather long and uninteresting treatise. The ancient writers are full of warnings against flatterers, who do not seem to exercise much influence in modern society. The really dangerous flatterer (§ 4) is not the parasite, but the pretender to a disinterested friendship—one who affects similar tastes, and so insinuates himself into your confidence. Your accomplished flatterer does not always praise, but flatters by act, as when he occupies a good seat at a public meeting for the express purpose of resigning it to his patron (§ 15). A true friend, on the contrary, speaks freely on proper occasions. A good part of the essay turns on *ὑποψια*, the honest expression of opinion. The citations, which are fairly numerous, are mostly from Homer.

How one may be Conscious of Progress in Goodness is addressed to Sosius Senecio, who was consul in the last years of Nerva, and more than once (99, 102, 107) under Trajan. If, says Plutarch, a man could become suddenly wise instead of foolish, he could not be ignorant of the change; but it is otherwise with moral or mental processes. Gradual advance in virtue is like steady sailing over a wide sea, and can only be measured by the time taken and the forces applied (§ 3). Zeno tested advance by dreams (§ 12); if no excess or immorality presented itself to the imagination of the sleeper, his mind had been purged by reason and philosophy. Whence we love the truly good, and adapt ourselves to their looks and manners, and this even with the loss of worldly prosperity, then we are really getting on in goodness ourselves (§ 15). Lastly, the avoidance of little sins is an evidence of a scrupulous conscience (§ 17).

How to get Benefit out of Enemies argues that, as primitive man had savage animals to fight against, but learnt to make use of their skins for clothing and their flesh for food, so we are bound to turn even our enemies to some good purpose. One service they do to us is to make us live warily against plots; another is, they induce us to live honestly, so as to vex our rivals not by scolding them, but by making them secretly jealous of us (§ 4). Again, finding fault leads us to consider if we are ourselves faultless, and to be found fault with by a foe is likely to be plain truth speaking. *Ανεπισημοὶ κερὶ παρὰ τὸν ἄλλοτρω εἰς ἀλλήλους* (§ 6). Jealousies and strifes, so natural to man, are diverted from our friends by being legitimately expended on our enemies (§ 10).

On Having Many Friends, On Chance, On Virtue and Vice, are three short essays, the first advocating the concentration of one's affections on a few who are worthy (*ποῖν ἕλιπον φίλους ἑαύτου*, § 4), rather than diluting them, as it were, on the many; the second pleads that intelligence, *φρόνησις*, not mere luck, is the ruling principle of all success; the third shows that virtue and vice are but other names for happiness and misery. All these are interspersed with citations from the poets, several of them unknown from other sources.

A longer treatise, well and clearly written, and not less valuable for its many quotations, is the *Consolation addressed to Apollonius* (considered spurious by some) on the early death of his "generally beloved and religious and dutiful son." Equality of mind both in prosperity and in adversity is recommended (§ 4), since there are "ups and downs" (*ἄνω καὶ κάτω*) in life, as there are storms and calms on the sea, and good and bad seasons on the earth. That man is born to reverse he illustrates by citing fifteen fine verses from Menander (§ 5). The uselessness of indulging in grief is pointed out, death being a debt to all and not to be regarded as an evil (§§ 10-12). Plato's doctrine is cited (§ 13) that the body is a burden and an impediment to the soul. Death may be annihilation, and therefore the dead are in the same category as the unborn (§ 15). The hastening a death because it is untimely or premature has something of selfishness in it (§ 19), besides that it only means that one has arrived sooner than another at the end of a common journey. If a death is more grievous because it is untimely, a new-born infant's death would be the most grievous of all (§ 23). One who has died early may have been spared many woes rather than have been deprived of many blessings; and, after all, to die is but to pay a debt due to the gods when they ask for it (§ 28). Examples are given of fortitude and resignation under such affliction (§ 33). If, says the author in conclusion, there is a heaven for the good hereafter, be sure that such a son will have a place in it. The author has borrowed from the *Uepi τῆθους* of Crantor.

Precepts about Health commences as a dialogue, and extends to some length as a lecture. It is technical and difficult throughout, and contains but little that falls in with modern ideas. Milk, he says, should be taken for food rather than for drink, and wine should not be indulged in after hard work or mental effort, for it does but tend to increase the bodily disturbance (§ 17). Better than purges or emetics is a temperate diet, which induces the bodily

functions to act of themselves (§ 20). Another wise saying is that idleness does not conduce to health (ὁδὸς ἀλφειῆς ἰστέρι τὸ μᾶλλον ὑγιαίνει τοῖς θνητοῖς ἐργασίας) (§ 21), and yet another that a man should learn by experience his bodily capabilities without always consulting a physician (§ 26).

Advice to the Married is addressed to his newly wedded friends Pollianus and Eurycleid. It is simply and plainly written, and consists chiefly of short maxims and anecdotes, with but few citations from the poets.

The Banquet of the Seven Wise Men (considered spurious by some) is a longer treatise, one of the several "Symposia" or imaginary conversations that have come down to us. It is supposed to be given by Periander in the public banqueting-room (ἡστιαεῖσιον) near the harbour of Corinth (Lechaum) on the occasion of a sacrifice to Aphrodite. The whole party consisted of "more than twice seven," the friends of the principal guests being also present. Like Plato's *Symposium* this treatise takes the form of a narrative of what was said and done, the narrator being one Diocles, a friend of Periander, who professes to give Nicarchus a correct account as having been present. The dinner was simple, and in contrast with the usual splendour of "tyrants" (§ 4). The conversation turns on various topics; Solon is credited with the remarkable opinion that "a king or tyrant is most likely to become celebrated if he makes a democracy out of a monarchy" (§ 7). There is much playful banter throughout, but neither the wit nor the wisdom seems of a very high standard. Solon delivers a speech on food being a necessity rather than a pleasure of life (§ 16), and one Gorgias, a brother of the host, comes in to relate how he has just shaken hands with Arion, brought across the sea on the back of a dolphin (§ 18), which brings on a discussion about the habits of that creature. Among the speakers are Aesop, Anacharsis, Thales, Chilo, Cleobulus and one Chersias, a poet.

A short essay *On Superstitions* contains a good many quotations from the poets. It opens with the wise remark that ignorance about the gods, which makes the obstinate man an atheist, also begets credulity in weak and pliant minds. The atheist fears nothing because he believes nothing; the superstitious man believes there are gods, but that they are unfriendly to him (§ 2). A man who fears the gods is never free from fear, whatever he may do or whatever may befall him. He extends his fears beyond his death, and believes in the "gates of hell," and its fires, in the darkness, the ghosts, the infernal judges, and what not (§ 4). The atheist does not believe in the gods; the superstitious man wishes he did not, but fears to disbelieve (§ 11). On the whole, this is a most interesting treatise.

On Isis and Osiris is a rather long treatise on Egyptian symbolism, interesting chiefly to students of Egyptology. It gives an exposition of the strange myths and superstitions of this ancient solar cult, including a full account of the great antagonist of Osiris, Typhon, or the Egyptian Satan. Plutarch thus lays down the Zoroastrian theory of good and bad agencies (§ 45): "If nothing can happen without cause, and good cannot furnish cause for evil, it follows that the nature of evil, as of good, must have an origin and principle of its own."

On the Cessation of Oracles is a dialogue, discussing the reasons why divine inspiration seemed to be withdrawn from the old seats of prophetic lore. The real reason of their decline in popularity is probably very simple; when the Greek cities became Roman provinces the fashion of consulting oracles fell off, as unsuited to the more practical influences of Roman thought and Roman politics. The question is discussed whether there are such intermediate beings as *daemones*, who according to Plato communicate the will of the gods to men, and the prayers and vows of men to the gods.

The possibility of a plurality of worlds is entertained, and of the planets being more or less composed of the essence of the five elements, fire, ether, earth, air and water (§ 37). The whole treatise is metaphysical, but it concludes with remarks on the exhalations at Delphi having different effects on different people and at different times. The ancient notion doubtless was that the vapour was the breath of some mysterious being sent up from the under-world.

On the Pythian Responses, why no longer given in Verse, is also a dialogue, the first part of which is occupied mainly with conversation and anecdotes about the statues and other offerings at Delphi. It is rather an amusing essay, and may be regarded as a kind of appendix to the last. The theory propounded (§ 24) is that verse was the older vehicle of philosophy, history and religion; but that plain prose has become the later fashion, and therefore that oracles are now generally delivered "in the same form as laws speak to citizens, and reply to their subjects, and scholars hear their teachers speak." Discredit, too, was brought on the verse-oracle by the facility with which it was employed by impostors (§ 25). Moreover, verse is better suited to ambiguity, and oracles nowadays have less need to be ambiguous (§ 28).

On the E at Delphi is an inquiry why that letter or symbol was written on or in the Delphic temple. Some thought it represented the number five, others that it introduced the inquiry of oracle-seekers. If so-and-so was to be done; while one of the speakers, Ammonius, decides that it means E, "thou art," an address to Apollo containing the predication of existence (§ 17).

On the Face of the Moon's Disk is a long and curious if somewhat trifling speculation, yet not without interest from its calculations

of the sizes and the distance from earth of the sun and moon (§ 10), and from the contrast between ancient lunar theories and modern mathematics. The cause of the moon's light, its peculiar colour, the possibility of its being inhabited and many kindred questions are discussed in this dialogue, the beginning and end of which are alike abrupt. Some of the "guesses at truth" are very near the mark, as when it is suggested (§§ 21-22) that the moon, like the earth, contains deep recesses into which the sun's light does not descend, and the appearance of the "face" is nothing but the shadows of streams or of deep ravines.

On the Late Vengeance of the Deity is a dialogue consequent on a supposed lecture by Epicurus. An objection is raised to the ordinary dealings of providence; that long-delayed punishment encourages the sinner and disappoints the injured, the reply to which is (§ 5) that the god sets man an example to avoid hasty and precipitate resentment, and that he is willing to give time for repentance (§ 6). Moreover, he may wish to await the birth of good progeny from erring parents (§ 7). Another fine reflection is that sin has its own punishment in causing misery to the sinner, and thus the longer the life the greater is the share of misery (§ 9). The essay concludes with a long story about one Theopiscus, and the treatment which he saw, during a trance, of the souls in the other world.

On Fate (probably spurious) discusses the law of chance as against the overruling of providence. This treatise ends abruptly; the point of the argument is that both fate and providence have their due influence in mundane affairs (§ 9), and that all things are constituted for the best.

On the Genius of Socrates is a long essay, and, like so many of the rest, in the form of a dialogue. The experiences of one Timarchus, and his supernatural visions in the cave of Trophonius, are related at length in the Platonic style (§ 22), and the true nature of the *delusions* is revealed to him. They are the souls of the just, who still retain regard for human affairs and assist the good in their efforts after virtue (§ 28). The dialogue ends with an interesting narrative of the concealment of Pelopidas and some of the Theban conspirators against the Spartans in the house of Charon.

On Exile is a fine essay, rendered the more interesting from its numerous quotations from the poets, including several from the *Phoenissae*. Man is not a plant that grows only in one soil; he belongs to heaven rather than to earth, and wherever he goes there are the same sun, the same seasons, the same providence, the same laws of virtue and justice (§ 5). There is no discredit in being driven from one's country; Apollo himself was banished from heaven and condemned to live for a time on earth (§ 18).

The Consolation to his Wife, on the early death of their only daughter Timoxena (§ 7), is a feeling and sensible exhortation to moderate her grief.

Nine books of *Symposiaca* extend to a great length, discussing inquiries (ὑποθέματα) on a vast number of subjects. The general treatment of these, in which great literary knowledge is displayed, is not unlike the style of Athenaeus.

The Astorous Men is a dialogue of some length, describing a conversation on the nature of love held at Helicon, pending a quinquennial feast of the Theopians, who specially worshipped that deity along with the Muses. It is amply illustrated by poetical quotations. In § 24 mention is made of the emperor Vespasian. It is followed by a short treatise entitled *Love Stories*, giving a few narratives of sensational adventures of lovers.

Short Sayings (ἁποθνήσκοντα), dedicated to Trajan, extend to a great length, and are divided into three parts: (1) of kings and commanders (including many Roman); (2) of Spartans; (3) of Spartan women (a short treatise on Spartan institutions being interposed between the last two). The names of the authors are added, and to some of them a large number of maxims are attributed.

A rather long treatise *On the Virtues of Women* contains a series of narratives of noble deeds done by the sex in times of danger and trouble, especially from "tyrants." Many of the stories are interesting, and the style is easy and good.

Another long and learned work bears the rather obscure title *Κοιμητικὴ καὶ ὑπνοποιία*. It is generally known as *Quaestiones Romanae* and *Graecae*, in two parts. In the former, which contains one hundred and thirteen headings, the inquiry (on some matter political, religious or antiquarian) always commences with *ut vi*, usually followed by *utrum*, with alternative explanations. In the *Greek Questions* the form of inquiry is more often *vis* or *vires*, not followed by *utrum*. This treatise is of great interest and importance to classical archaeology, though the inquiries seem occasionally trifling, and sometimes the answers are clearly wrong.

Parallela (spurious) are a series of similar incidents which occurred respectively to Greeks and Romans, the Greek standing first and the Roman counterpart following. Many of the characters are mythological, though Plutarch regards them as historical.

On the Fortune of the Romans discusses whether, on the whole, good luck or valour had more influence in giving the Romans the supremacy. This is followed by two discourses on the same question as applicable to the career of Alexander the Great, and *Whether the Athenians were more renowned for War or for Wisdom?* The conclusion is (§ 7) that it was not so much by the fame of their poets as by the deeds of their heroes that Athens became renowned.

Grillus is a most amusing dialogue; in which Circe, Odysseus and a trilling pig take part. Odysseus wishes that all the human beings that have been changed by the sorceress into bestial forms should be restored; but the pig argues that in moral virtues, such as true bravery, chastity, temperance and general simplicity of life and contentment, animals are very far superior to man.

Whether Land Animals or Water Animals are the Cleverer is a rather long dialogue on the intelligence of ants, bees, elephants, spiders, dogs, &c., on the one hand, and the crocodile, the dolphin, the tunny and many kinds of fish, on the other. This is a good essay, much in the style of Aristotle's *History of Animals*.

On Flesh-eating, in two orations, discusses the origin of the practice, viz. necessity, and makes a touching appeal to man not to destroy life for mere gluttony (§ 4). This is a short but very sensible and interesting argument. *Questions on Plato* are ten in number, each heading subdivided into several speculative replies. The subjects are for the most part metaphysical; the essay is not long, but it concerns Platonists only. *Whether Water or Fire is more Useful* is also short; after discussing the uses of both elements it decides in favour of the latter, since nothing can exceed in importance the warmth of life and the light of the sun. *On Primary Cold* is a physical speculation on the true nature and origin of the quality antithetical to heat. *Physical Reasons (Quæstiones Naturales)* are replies to inquiries as to why certain facts or phenomena occur, e.g. "Why is salt the only flavour not in fruits?"

"Why do fishing-nets rot in winter more than in summer?" "Why does pouring oil on the sea produce a calm?" *On the Opinions accepted by the Philosophers* (spurious), in five books, is a valuable compendium of the views of the Ionic school and the Stoics on the phenomena of the universe and of life. *On the Ill-nature of Herodotus* is a well-known critique of the historian for his unfairness, not only to the Boeotians and Lacedæmonians, but to the Corinthians and other Greek states. It is easy to say that this essay "neither requires nor merits refutation"; but Plutarch knew history, and he writes like one who thoroughly understands the charges which he brings against the historian. The *Lives of the Ten Orators* from Antiphon to Dinarchus (now considered spurious) are biographies of various lengths, compiled, doubtless, from materials now lost.

Two rather long essays, *Should a Man engage in Politics when he is no longer Young*, and *Precepts for Governing* (πολιτικὰ παραγγέλματα), are interspersed with valuable quotations. In favour of the former view the administrations of Pericles, of Agesilaus, of Augustus, are cited (§ 2), and the preference of older men for the pleasures of doing good over the pleasures of the senses (§ 5). In the latter, the true use of eloquence is discussed, and a contrast drawn between the brilliant and risky and the slow and safe policy (§ 10). The choice of friends, and the caution against enemies, the dangers of love, of gain and of ambition, with many topics of the like kind, are sensibly advanced and illustrated by examples.

(F. A. P.; J. M. M.)

BIBLIOGRAPHY.—*Ediitio princeps*, by H. Stephanus (1572); other complete editions by J. J. Reiske (1774-1782), J. G. Hutter (1791-1804), T. Döhner and F. Dübner (1846-1855). Of the *Lives*, there are editions by A. Coray (1809-1814), C. Sintenis (1830-1846; ed. min., 1874-1881), and of many separate lives by Siefert-Blass, Sintenis-Fuhr, Holden, Hardy and others. There are many English translations, of which the most popular is that by John and William Langhorne; also the old French version by Jacques Amyot (1559) from which Sir Thomas North's (1579) was made, newly edited by G. Wyndham (2805); many of the Roman lives have been translated, with notes, by George Long. The *Moralia* has been edited by D. Wyttenbach (1795-1830), and G. N. Bernardakes (1888-1896). The old English translation by Philemon Holland (1603) has been revised by C. W. King and A. R. Shilleto in Bohn's *Classical Library* (1882-1888), and a later translation by various hands (London, 1684-1694), edited by W. W. Goodwin with introduction by R. W. Emerson, has been republished at Cambridge, Massachusetts (1874-1878). Mention may also be made of P. Holland's *Romane Questions*, edited with introductory dissertations by F. B. Jevons (1892); *Roman Problems*, with essay on "Roman Worship and Belief," by G. C. Allen (1904); *De la Musique*, ed. H. Weil and Th. Reinach (1900); J. Oakesmith, *The Religion of Plutarch as expounded in his Ethics* (1902); Archbishop Trench, *A Popular Introduction to Plutarch* (1873); O. Gerard, *De la Morale de Plutarque* (1866); R. Volkmann, *Leben, Schriften und Philosophie des Plutarch* (1866). The earlier literature of Plutarch is very extensive, for which W. Engelmann, *Scriptores graeci* (1881), may be consulted.

PLUTARCH, of Athens (c. 350-430), Greek philosopher, head of the Neoplatonic school at Athens at the beginning of the 5th century, was the son of Nestorius and father of Hierius and Asclepienia, who were his colleagues in the school. The origin of Neoplatonism in Athens is not known, but Plutarch and his followers (the "Platonic Succession") claim to be the disciples of Iamblichus, and through him of Porphyry and Plotinus. Plutarch's main principle was that the study of Aristotle must precede that of Plato, and that the student should be taught to realize primarily the fundamental points of agree-

ment between them. With this object he wrote a commentary on the *De anima* which was the most important contribution to Aristotelian literature since the time of Alexander of Aphrodisias. His example was followed by Syrianus and others of the school. This critical spirit reached its greatest height in Proclus, the ablest exponent of this latter-day syncretism. Plutarch was versed in all the theurgic traditions of the school, and believed in the possibility of attaining to communion with the Deity by the medium of the theurgic rites. Unlike the Alexandrists and the early Renaissance writers, he maintained that the soul which is bound up in the body by the ties of imagination and sensation does not perish with the corporeal media of sensation. In psychology, while believing that Reason is the basis and foundation of all consciousness, he interposed between sensation and thought the faculty of Imagination, which, as distinct from both, is the activity of the soul under the stimulus of unceasing sensation. In other words, it provides the raw material for the operation of Reason. Reason is present in children as an inoperative potentiality, in adults as working upon the data of sensation and imagination, and, in its pure activity, it is the transcendental or pure intelligence of God.

See Marinus, *Vita Procli*, 6, 12; Zeller's *History of Greek Philosophy*; Bouillet, *Ennéades de Plotin*, ii. 667-668; Windelband, *History of Philosophy* (trans. J. H. Tufts, p. 225).

PLUTO (Πλούτων), in Greek mythology, the god of the lower world. His oldest name was Hades, Aides or Aidoneus, "the Unseen." He was the son of Cronus and Rhea, and brother of Zeus and Poseidon. Having deposed Cronus, the brothers cast lots for the kingdoms of the heaven, the sea, and the infernal regions. The last, afterwards known as Hades from their ruler, fell to Pluto. Here he ruled with his wife Persephone over the other powers below and over the dead. He is stern and pitiless, deaf to prayer or flattery, and sacrifice to him is of no avail; only the music of Orpheus prevailed upon him to restore his wife Eurydice. His helmet, given him by the Cyclopes after their release from Tartarus, rendered him invisible (like the Tarn—or Nebelkappe of German mythology). He is hated and feared by gods and men, who, afraid to utter his name, both in daily life and on solemn occasions make use of euphemistic epithets: Polydectes (the receiver of many), Clymenus (the Illustrious), Eubulus (the giver of good counsel). Later, owing to his connexion with Persephone and under the influence of the Eleusinian mysteries, the idea of his character underwent a radical change. Instead of the life-hating god of death, he became a beneficent god, the bestower of grain, minerals, and other blessings produced in the depths of the earth. In this aspect he was called Pluto, the "giver of wealth" (a name that first occurs in the Attic poets of the 5th century), and at most of the centres of his cult he was so worshipped; at Elis alone he was Hades, the god of the dead. The plants sacred to him were the cypress and narcissus; black victims were sacrificed to him, not white, like those offered to the other gods. In art he was represented like Zeus and Poseidon; his features are gloomy, his hair falls over his forehead; his attributes are a sceptre and Cerberus; he carries the key of the world below (cf. the epithet *κυλλάρης*, "keeper of the gate"), and is frequently in company with Persephone. He is sometimes represented as an agricultural god, carrying a cornucopia and a two-pronged fork. Amongst the Romans Hades was usually called Dis pater (the "wealthy father") and Orcus, although the name Pluto is often used. Orcus, however, was rather the actual slayer, the angel of death, while Father Dis was the ruler of the dead. The Etruscan god of death was represented as a savage old man with wings and a hammer; at the gladiatorial games of Rome a man masked after this fashion removed the corpses from the arena. In Romanesque folk-lore Orcus (possibly English "ogre," *g.w.*) has passed into a forest-elf, a black, hairy, man-eating monster, upon whose house children lost in the woods are apt to stumble, and who sometimes shows himself kindly and helpful.

The "house of Hades" was a dreadful abode deep down in the earth, and the god was invoked by rapping on the ground. According

to another view, the realm of Hades was beyond the ocean in the far west, which to the Greek was always the region of darkness and death, as the east of light and life. This is the view of Hades presented in the *Odyssey*. Besides this gloomy region, we find in another passage of the *Odyssey* (iv. 561 seq.) a picture of Elysium, a happy land at the ends of the earth, where rain and snow fall not, but the cool west wind blows and men live at ease. After Homer this happy land, the abode of the good after death, was known as the Isles of the Blest (q.v.).¹ But in the oldest Greek mythology the "house of Hades" was simply the home of the dead, good and bad alike, who led a dim and shadowy reflection of life on earth.

See article "Hades," in Roscher's *Lexikon der Mythologie*; Preller-Robert, *Griechische Mythologie* (1894); L. Farnell, *Cults of the Greek States*, vol. iii., who regards Hades as an evolution from Zeus and his counterpart; according to J. E. Harrison, in *Classical Review* (Feb. 1908), Hades is the under-world sun.

PLUTOGRACY (Gr. *πλουτοκρατία*, from *πλοῦτος*, wealth, and *κράτος*, power), government or power exercised by the possessors of wealth, power obtained by the mere possession of riches; hence a body or ruling class whose influence is due only to their money.

PLUTO MONKEY, a guenon, *Cercopithecus (Mona) leucamphya*, nearly allied to the MONA (q.v.), which takes its name from the black fur of the under-parts, passing into blackish grey on the head and back. The violet-coloured face, which has no beard, is fringed by large bushy whiskers and surmounted by a white band above the brows. The range of the species extends from the Congo and Angola to Nyasaland. (See PRIMATES.)

PLUTUS, in Greek mythology, son of Iasion and Demeter, the personification of wealth (*πλοῦτος*). According to Aristophanes, he was blinded by Zeus because he distributed his gifts without regard to merit. At Thebes there was a statue of Fortune holding the child Plutus in her arms; at Athens he was similarly represented in the arms of Peace; at Thespiae he was represented standing beside Athena the Worker. Elsewhere he was represented as a boy with a *cornu copiosa*. He is the subject of one of the extant comedies of Aristophanes, the *Plutus*.

PLYMOUTH, EARLS OF, a title first borne by Charles (1657-1680), an illegitimate son of the English king Charles II. by Catharine Pegge, who was created earl in 1675. The title became extinct on his death in October 1680. In 1682 Thomas Windsor Hickman-Windsor, 7th Baron Windsor de Stanwell (c. 1627-1687), who had fought for Charles I. at Naseby, was created earl of Plymouth. His father was Dixie Hickman of Kew, Surrey, and his mother, Elizabeth, was a sister of Thomas Windsor, 6th Baron Windsor de Stanwell (1596-1641); having inherited the estates of his uncle and taken the additional name of Windsor, the abeyance of the barony of Windsor de Stanwell was terminated in his favour and he became the 7th baron. From 1661-1663 he was nominally governor of Jamaica. His grandson Other (1670-1725) was the 2nd earl, and the earldom became extinct when Henry, the 8th earl, died in December 1843. Called again out of abeyance, the barony of Windsor came in 1855 to Harriet, a daughter of Other Archer, the 6th earl (1760-1833), and the wife of Robert Henry Clive (1780-1834), a younger son of Edward Clive, 1st earl of Powis. She was succeeded in 1869 by her grandson, Robert George Windsor-Clive, who became the 14th Baron Windsor. After serving as paymaster-general in 1807-1802 and first commissioner of works from 1902-1905, Lord Windsor was created earl of Plymouth in 1905.

¹The Samoan Islanders unite the two conceptions: the entrance to their spirit-land is at the westernmost point of the westernmost island, where the ghosts descend by two holes into the under-world. Long ago the inhabitants of the French coast of the English Channel believed that the souls of the dead were ferried across to Britain, and there are still traces of this belief in the folk-lore of Brittany (Tylor; *Primitive Culture*, ii. 64; Grimm, *Deutsche Mythologie*, ii. 694). In classical mythology the underground Hades prevailed over the western. It was an Etruscan custom at the foundation of a city to dig a deep hole in the earth and close it with a stone; on three days in the year this stone was removed and the ghosts were then supposed to ascend from the lower world. In Asia Minor caves filled with mephitic vapours or containing hot springs were known as Plutonia or Charonia. The most famous entrances to the under-world were at Taenarum in Laconia, Heraclea on the Euxine, and at the Lake Avernus in Italy.

PLYMOUTH, a municipal county (1888, extended 1896) and parliamentary borough and seaport of Devonshire, England, 231 m. W.S.W. of London. Pop. (1910), 726,266. It lies at the head of Plymouth Sound, stretching westward from the river Plym towards the mouth of the Tamar, from which it is separated by the township of East Stonehouse and the borough of Devonport, the two latter constituting with it the "Three Towns." The prince of Wales is lord high steward of the borough, which is divided into 14 wards, under a mayor, 14 aldermen and 42 councillors. The parliamentary borough, returning two members, is not coextensive with the municipal borough, part of the latter being in the Tavistock (county) division of Devon. The water frontage of the Three Towns consists of Plymouth Sound, with its inlets, in order from east to west, the Catwater, Sutton Pool, Mill Bay, Stonehouse Pool and the Hamoaze. The Catwater and Hamoaze are flanked on the east and west respectively by high ground, on which are built forts that command the harbour and its approaches. On the western side of the entrance to Catwater is the Citadel, founded in the reign of Henry VIII. and rebuilt by Charles II. The adjacent Hoe extends along the northern edge of the Sound, and from it can be obtained a splendid view, embracing the rugged Staddon Heights on the east and the wooded slopes of Mount Edgumbe on the west. To the north is seen the town of Plymouth rising up to the hills known as Mannamend. On the site of an old Trinity House obelisk landmark is Smeaton's lighthouse tower, removed from its original position on the Eddystone Reef in 1884. It is now used as a wind-recording station in connexion with the adjoining Meteorological Observatory. On the Hoe there stands the striking Drake statue by Sir Edgar Boehm, and the Armada Memorial, while at the north-east end is an obelisk monument to the memory of troops engaged in the South African War. A municipal bowling-green recalls a probable early use of the Hoe. Adjacent to the Citadel, at its south-west angle, is the Marine Biological Station, and, further west, projects the Promenade Pier. In the Sound is Drake's (formerly St Nicholas's) Island, now strongly fortified, at one time the property of the corporation, and serving in Stuart times as a place of imprisonment of certain Plymouth Baptist ministers. Few evidences, however, of the antiquity of the town remain. Below, and to the north-east of the Citadel, is the Barbican with its "Mayflower" commemoration stone, a large fish-buying trade being done on the adjacent quay, near which is the Custom House. From the Barbican winding streets lead past the old Guildhall (1800) which contained the municipal library, pending its removal to more commodious quarters in the new museum, opposite the technical and art schools, situated in the most northern part of the town. At a short distance west stands the new Guildhall, with the enlarged post office, central police station, law courts and municipal buildings in close proximity. Opened in 1874, the Guildhall is built in a bold, rather exotic, Early Pointed French style. The tower at the south-west end is 190 ft. high, and the building is ornamented with a series of coloured windows relating to events in the history of Plymouth or commemorating men and families connected with the town. The large hall contains a fine organ. In the mayor's parlour is a contemporary portrait of Sir Francis Drake and some interesting prints of the town of Plymouth.

Near the eastern entrance to Guildhall Square is St Andrews, the mother church of Plymouth, erected on the site of a chapel dedicated to the Virgin. The church is typical of the Devonshire Perpendicular style of 1430-1520, but, though large, presents few features of artistic or archaeological interest. It underwent complete restoration in 1874. The burying-ground on the north side has been levelled, and on it erected a stone monument. The church, furnished with one of the finest organs in the west of England, contains the tombs of a son of Admiral Vernon, of Sir John Skelton (a former governor of the Citadel), and of Charles Mathews the comedian, as well as portions of the bodies of Frobisher and Drake. Here Katherine of Aragon returned thanks for a safe voyage from Spain to Plymouth. In 1640 a second parish was formed with Chads

Church (1658) at its head, the last-named being popularly known as New Church, in contradistinction to St Andrews or "Old Church." The New Church is an interesting specimen of Stuart "debased" Gothic architecture. South of Andrews church is the site of a Franciscan Friary with some early 15th-century remains. Near the church are a few old houses scattered along the crooked little streets going down to the water. These houses date from Elizabethan times, but are not of any unusual interest. The Citadel (now used as army headquarters and

foundation, and intermediate day and evening school and numerous primary departments. The philanthropic institutions include the enlarged South Devon and East Cornwall hospital, eye infirmary, homoeopathic hospital, blind institution and female orphan asylum.

The public recreation grounds, other than the Hoe, are few and small; Hartley Reservoir Grounds at the northern extremity of the town commands extensive moorland views; the Freedom Park, by its plain, unfinished monument, recalls the siege of Plymouth by the Royalists in 1646, and the Beaumont Park contains the temporary home of the nucleus for a museum and art gallery. The

Victoria Park, reclaimed from a part of Stonehouse Creek, is under the joint administration of Plymouth, Stonehouse and Devonport.

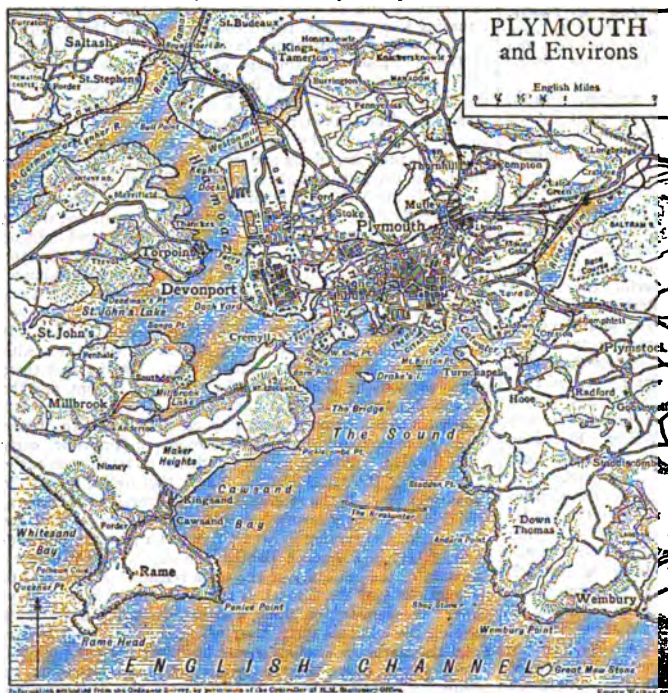

barracks) is a fine specimen of 17th-century military architecture. It is an irregular bastioned pentagon in trace. It possesses a fine florid classical gateway. In the centre stands a dignified Jacobean house, once the residence of the governor of Plymouth.

Plymouth is the seat of a Roman Catholic bishopric founded in 1831, the cathedral, in Wyndham Street, being completed in 1838 through the efforts of Bishop Vaughan, who was the second occupant of the see (until 1902). The building is in the Early English style, and adjoining are the bishop's house and the convent of Notre Dame. In the immediate vicinity is the only Presbyterian church in the Three Towns. Noteworthy among the many Nonconformist places of worship are the Baptist chapel (George Street), with its tablet recording the imprisonment of ministers on Drake's Island; Sherwell (Congregational) on the Tavistock Road, the most ornate in its style of architecture; the Wesleyan Methodist chapel in the main thoroughfare of the residential suburb of Mutley, unique among Methodist edifices in the town in respect of its fine spire. All the principal religious bodies have places for worship or for assembly in the town, and the borough has given, in popular speech, the name of "Plymouth Brethren" to one body.

In addition to the Plymouth College (for boys), there are several educational institutions administered by the borough council, comprising a science, art and technical school, a mixed secondary school replacing the corporation grammar school of Elizabethan

the site of the present church stood the chapel of St George, in which, during the years 1681-1682, worshipped, in addition to the English congregation, one composed, as at Plymouth, of Huguenots who fled from France at the Revocation of the Edict of Nantes.

Facing the Sound are Stone Hall and the Winter Villa. The former, occupied by the lords of the manor before the building of Mount Edgcombe House, was originally a castellated building, and the latter was built primarily as an alternative residence for a countess of Mount Edgcombe. A link with the past is the Mill Bridge Causeway, over what was the "Dead Lake," now a road, which, at the head of Stonehouse Creek, is the second approach to the Stoke Damerel portion of Devonport. Built in 1525, it possesses a toll-gate house at which payment from vehicles is still demanded.

In addition to the Victualling Yard, with its naval ordnance department, repairing shops and armoury, the Barracks, accommodating some 1500 men, and the Naval Hospital of 24 acres, abutting on the Creek, there are within the boundaries a theatre seating over 2000 persons, the Devonport Corporation Electricity Works, a clothing factory and part of the Great Western Railway Docks. The stationary character of the township—which from its situation is incapable of expansion—is seen from the statistics of population: (1881), 15,041; (1901), 15,108; (1910), 15,111.

The "Port of Plymouth" in 1311 embraced Plympton, Modbury and Newton Ferrers, and received a customs grant

from Richard II. In 1435 sixty-five cargoes were imported, and in the reign of Elizabeth it rose to be the foremost port in England. The 18th century saw a great development of trade with Virginia and the West Indies, resulting in the establishment of a sugar-refining industry that was maintained until a recent date.

In 1749 the "town's water" was carried to the Barbican to supply shipping. The port of Plymouth, as at present constituted, embraces "the waters of Plymouth Sound and the Hamoaze, including all bays, creeks, lakes, pools, ponds and rivers as far as the tide flows within or to the northward of a straight line drawn across the entrance of Plymouth Sound from Penlee Point on the west to the Shagstone on the east." The chief water area within the limits of the port is the Sound with its inlets, the Catwater (200 acres), Sutton Pool, Mill Bay, Stonehouse Pool and the Hamoaze. The Sound itself covers an area of 4500 acres and is sheltered from south-west gales by the breakwater completed in 1841 at a cost of 1½ million sterling. It lies 2½ m. south of the Hoe, and is nearly a mile long, 360 ft. wide at the base and 45 ft. at the top. Its banks bend inwards at angles of 120°; at the western end is a lighthouse and at the eastern extremity is a pyramidal beacon with a cage capable of accommodating several men.

The town is served by the Great Western and the London & South-Western railways. The former company has a main line entering from the west through Devonport and going east to Exeter, having Dartmoor on the west; the latter company has a terminal station in the eastern quarter of the town, and its route to Exeter is by way of the Tamar valley, and the western and northern moorland districts.

The industries of Plymouth include soap manufacture, preparation of artificial manure and sulphuric acid and paper staining. The water supply, inaugurated by Drake in 1590, and drawn from the Dartmoor watershed, is the most important municipal undertaking. The service of electricity both for lighting and tramway traction is in the hands of the town, but the gasworks belong to a private company.

Plymouth, the Sutton of Domesday, was afterwards divided into the town of Sutton Prior, the hamlet of Sutton Valletort and the tithing of Sutton Ralph, the greater part belonging to the priory of Plympton. The market, established about 1253, became in 1311 town property, with the mayor as clerk of the market. In 1292 the town first returned members to parliament. In the 14th century it was frequently the port of embarkation and of disembarkation in connexion with expeditions to France, and suffered considerably at the hands of the French. In 1412 the inhabitants petitioned for a charter, which, after strenuous opposition from the priors of Plympton, was granted by Henry VI. in 1439. In the discovery of the New World it played a part of great importance. Cockeram, a native of the town, sailed with John Cabot in 1497. Sir John Hawkins and his father William were also natives, the former being port admiral and (in 1571) M.P. From Plymouth in 1577 Drake set out on his voyage round the world; in 1581 he became mayor and represented the borough in parliament during 1592-1593. Sir Humphrey Gilbert (M.P. 1571) sailed on his second colonizing expedition to America in 1583 from the port, and hither Drake brought the remnant of Raleigh's Virginian colony. Plymouth supplied seven ships against the Armada, and it was in the Sound that the English fleet awaited the sighting of the Spaniards. A stone on a quay at the Barbican records the fact that this was the last port touched by the Pilgrim Fathers on their voyage to America.

During the Civil War Plymouth was closely invested by the Royalists, whose great defeat is commemorated by the monument at Freedom Park. It was the only town in the west that never fell into their hands. It early declared for William of Orange, in whose reign the neighbouring dockyard was begun.

AUTHORITIES.—*Histories of Plymouth* by Jewitt and Worth; *Wright's Plymouth with its Surroundings and Story of Plymouth*; *Whitefield, Plymouth and Devonport, in Times of War and Peace*; *Municipal Records* (Plymouth Corporation); *Worth, "Notes on Early History of Stonehouse"* (*Plymouth Insitt. Prac.*).

(H. G. DE W.)

PLYMOUTH, a township and the county-seat of Plymouth county, Massachusetts, U.S.A., in the south-eastern part of the state, on Plymouth Bay, about 37 m. S.E. of Boston. Pop. (1905) 11,119; (1910) 12,141. It is served by the New York, New Haven & Hartford railway, by inter-urban electric lines and in summer by steamers to Boston. The harbour is well sheltered but generally shallow; it has been considerably improved by the United States government and also by the state, which in 1909 was making a channel 18 ft. deep and 150 ft. wide from deep water to one of the township's wharves. The township has an area of 107.3 sq. m., is 18 m. long on the water front and is from 5 to 9 m. wide. Plymouth is a popular resort for visitors, having, in addition to its wealth of historic associations and a healthy summer climate, thousands of acres of hilly woodland and numerous lakes and ponds well stocked with fish. Morton Park contains 200 acres of woodland bordering the shores of Billington Sea (a freshwater lake).

Few, if any, other places in America contain so many interesting landmarks as Plymouth. The famous Plymouth Rock; a granite boulder on which the Pilgrims are said to have landed from the shallop of the "Mayflower," lies on the harbour shore near the site of the first houses built on Leyden Street, and is now sheltered by a granite canopy. Rising above the Rock is Cole's Hill, where during their first winter in America the Pilgrims buried half their number, levelling the graves and sowing grain over them in the spring in order to conceal their misfortunes from the Indians. Some human bones found on this hill when the town waterworks were built in 1855 have been placed in a chamber in the top of the canopy over the Rock. Burial Hill (originally called Fort Hill, as it was first used for defensive purposes) contains the graves of several Pilgrims and of many of their descendants. The oldest stone bears the date 1681; many of the stones were made in England, and bear quaint inscriptions. Here also are a tablet marking the location of the old fort (1621), which was also used as a place of worship, a tablet showing the site of the watch-tower built in 1643, and a marble obelisk erected in 1825 in memory of Governor William Bradford. Pilgrim Hall, a large stone building erected by the Pilgrim Society (formed in Plymouth in 1820 as the successor of the Old Colony Club, founded in 1766) in 1824 and remodelled in 1880, is rich in relics of the Pilgrims and of early colonial times, and contains a portrait of Edward Winslow (the only extant portrait of a "Mayflower" passenger), and others of later worthies, and paintings illustrating the history of the Pilgrims; the hall library contains many old and valuable books and manuscripts—including Governor Bradford's Bible, a copy of Eliot's Indian Bible, and the patent of 1621 from the Council for New England—and Captain Myles Standish's sword. The national monument to the Forefathers, designed by Hammatt Billings, and dedicated on the 1st of August 1889, thirty years after its corner-stone was laid, stands in the northern part of the town. It is built entirely of granite. On a main pedestal, 45 ft. high, stands a figure, 36 ft. high, representing the Pilgrim Faith. From the main pedestal project four buttresses, on which are seated four monolith figures representing Morality, Education, Law, and Freedom. On the faces of the buttresses below the statues are marble alto-reliefs illustrating scenes from the early history of the Pilgrims. On high panels between the buttresses are the names of the passengers of the "Mayflower." The court-house was built in 1820, and was remodelled in 1857. From it have been transferred to the fireproof building of the Registry of Deeds many interesting historical documents, among them the records of the Plymouth colony, the will of Myles Standish, and the original patent of the 23rd of January 1630 (N.S.).

Modern Plymouth has varied and important manufactures comprising cordage, woollens, rubber goods, &c. In 1905 the total value of the factory products was \$11,115,713, the worsted goods and cordage constituting about nine-tenths of the whole product. The cordage works are among the largest in the world, and consume immense quantities of sisal fibre imported from Mexico and manila from the Philippine Islands; binder-twine

for binding wheat is one of the principal products. From 1900 to 1905 the capital invested in manufactures increased 83% and the value of the product 101%. Large quantities of cranberries are raised in the township. Plymouth is a port of entry, but its foreign commerce is unimportant; it has a considerable coasting trade, especially in coal and lumber. The township owns its waterworks.

Plymouth was the first permanent white settlement in New England, and dates its founding from the landing here from the "Mayflower" shallop of an exploring party of twelve Pilgrims, including William Bradford, on the 21st of December (N.S.) 1620. The Indian name of the place was Patuxet, but the colonists called it New Plymouth, because they had sailed from Plymouth, England, and possibly because they were aware that the name of Plymouth had been given to the place six years before by Captain John Smith. When and how the town and the colony of Plymouth became differentiated is not clear. Plymouth was never incorporated as a township, but in 1633 the General Court of the colony recognized it as such by ordering that "the chief government be tyed to the towne of Plymouth." In 1686 the colony submitted to Sir Edmund Andros, who had been commissioned governor of all New England, and chose representatives to sit in his council. Plymouth remained the seat of government of the colony until 1692, when Plymouth Colony, and with it the town of Plymouth, was united to Massachusetts Bay under the charter of 1691 (see MASSACHUSETTS: History). Part of Plymouth was established as Plympton in 1707, and part as Kingston in 1726.

BIBLIOGRAPHY.—For the sources of the early history of Plymouth consult (George) *Moor's Relation, or Journal of the Plantation of Plymouth* (Boston, 1665, and numerous other editions); William Bradford's *History of the Plymouth Plantation* (Boston, 1858, and several later editions), the most important source of information concerning Plymouth before 1646; the *Plymouth Colony Records* (12 vols., Boston, 1855-1861); the *Records of the Town of Plymouth* (3 vols., Plymouth, 1889-1903); J. A. Young's *Chronicles of the Pilgrim Fathers* (Boston, 1841); and E. Arber's *Story of the Pilgrim Fathers* (London, 1897), the two last containing excerpts from the leading sources. See also James Thacher's *History of the Town of Plymouth* (Boston, 1832); W. T. Davis's *History of the Town of Plymouth* (Philadelphia, 1895); also his *Ancient Landmarks of Plymouth* (Boston, 2nd ed., 1899); and his *Plymouth Memories of an Octogenarian* (Plymouth, 1906); and John A. Goodwin, *The Pilgrim Republic* (Boston, 1888). For accounts in general histories, see J. G. Palfrey's *History of New England*, I. (Boston, 1858); the appreciative sketch by J. A. Doyle, in his *English Colonies in America*, II. (New York, 1899); and, especially, the monograph by Franklin B. Dexter, in Justin Winsor's *Narrative and Critical History of America*, vol. iii. (Boston, 1884). As to the truth of the tradition that the Pilgrims landed on Plymouth Rock, consult the *Proceedings of the Massachusetts Historical Society* (1903), 2nd series, vol. xvii, containing articles by E. Channing and W. W. Goodwin; the article by Herbert B. Adams in the *Magazine of American History*, ix. 31 sqq., and that by S. H. Gay in the *Atlantic Monthly*, xlviii. 612 sqq.

PLYMOUTH, a borough of Luzerne county, Pennsylvania, U.S.A., on the north branch of the Susquehanna river, immediately west of and across the river from Wilkes-Barre, of which it is a suburb. Pop. (1910), 16,996. Plymouth is served by the Delaware, Lackawanna & Western railroad. The borough is finely situated in the Wyoming Valley among the rich anthracite coalfields of eastern Pennsylvania, and its inhabitants are chiefly engaged in the coal industry; in 1906 and 1907 (when it shipped 24,087,491 tons) Luzerne county shipped more anthracite coal than any other county in Pennsylvania. In 1905 the total value of the factory products was \$902,758, 69.4% more than in 1900. Before the coming of white settlers there was an Indian village called Shawnee on the site of the present borough. The township of Plymouth was settled in 1769 by immigrants from New England—many originally from Plymouth, Litchfield county, Connecticut, whence the name—under the auspices of the Susquehanna Company, which claimed this region as a part of Connecticut, and Plymouth became a centre of the contest between the "Pennamites" and the "Yankees" (representing respectively Pennsylvania and Connecticut), which grew out of the conflict of the royal charter of Pennsylvania (granted in 1681) with the

royal charter of Connecticut (granted in 1662), a matter which was not settled until 1799. (See WYOMING VALLEY.) In its earlier history the region was agricultural. Two brothers, Abijah and John Smith, originally of Derby, Conn., settled in Plymouth in 1806 and began shipping coal thence in 1808; this was the beginning of the anthracite coal trade in the United States. The borough was incorporated in 1866, being then separated from the township of Plymouth, which had a population in 1890 of 8363 and in 1900 of 9655.

See H. B. Wright's *Historical Sketches of Plymouth* (Philadelphia, 1873).

PLYMOUTH BRETHERN, a community of Christians who received the name in 1830 when the Rev. J. N. Darby induced many of the inhabitants of Plymouth, England, to associate themselves with him for the promulgation of his opinions. Although small Christian communities existed in Ireland and elsewhere calling themselves *Brethren*, and holding similar views, the accession to the ranks of Darby so increased their numbers and influence that he is usually reckoned the founder of Plymouthism. Darby (born in Nov. 1800 in London; graduated at Trinity College, Dublin, in 1819; died April 29, 1882, at Bournemouth) was a curate in Wicklow 1825-1827, when he laid himself constrained to leave the Anglican communion; going to Dublin, he became associated with several devout people who met stately for public worship, and called themselves "Brethren." Among these were A. N. Groves and J. G. Bellett, who deserve to rank among the founders of the movement. In 1830 Darby at Plymouth won over many people to his way of thinking, among them James L. Harris, a Plymouth clergyman, and the well-known Biblical scholar Samuel Prideaux Tregelles. The Brethren started a periodical, *The Christian Witness*, continued from 1840 as *The Present Testimony*, with Harris as editor and Darby as the most important contributor. During the next eight years the progress of the sect was rapid, and communities were founded in many of the principal towns in England.

In 1838 Darby went to reside in French Switzerland, and made many disciples. Congregations were formed in Geneva & Lausanne, where most of the Methodist and other dissenters joined the Brethren, at Vevey and elsewhere in Vaud. His opinions also found their way into France, Germany, German Switzerland, and Italy; but French Switzerland has always remained the stronghold of Plymouthism on the Continent, and for his followers there Darby wrote two of his most important tracts, *Le Ministere considéré dans sa nature* and *De la Présence et de l'action du S. Esprit dans l'église*. The revolution in the canton Vaud, brought about by Jesuit intrigue in 1845, brought persecution to the Brethren in the canton and in other parts of French Switzerland, and Darby's life was in great jeopardy.

He returned to England, and his reappearance was followed by divisions among the Brethren at home. These divisions began at Plymouth. Benjamin Wills Newton, head of the community there, who had been a fellow of Exeter College, Oxford, was accused of departing from the testimony of the Brethren by reintroducing the spirit of clericalism. Unable to detach the congregation from the teacher, Darby began a rival assembly. The majority of the Brethren out of Plymouth supported Darby, but a minority remained with Newton. The separation became wider in 1847 on the discovery of supposed heretical teaching by Newton. In 1848 another division took place. The Bethesda congregation at Bristol, where George Müller was the most influential member, received into communion several of Newton's followers and justified their action. Out of this came the separation into Neutral Brethren, led by Müller, and Exclusive Brethren or Darbyites, who refused to hold communion with the followers of Newton or Müller. The Exclusives, who were the more numerous, suffered further divisions. An Irish clergyman named Samuel O'Malley had adopted views similar to those of Pearsall Smith, who preached a doctrine of sanctification called "Death to Nature" as an antidote to the supposed prevalent Laodiceanism, and when these were repudiated seceded with his followers. The se-

important division among the Exclusives came to a crisis in 1881, when William Kelly and Darby became the recognized leaders of two sections who separated on a point of discipline. This was followed (1885) by the disruption of the strict Darbyite section, two communions being formed out of it upon points of doctrine.

There were thus six sections of Plymouthists: (1) the followers of B. W. Newton, who promulgated the prophetic views peculiar to their leader; (2) the Neutrals—open brethren, leaning to Baptist views and to the Congregationalist idea that each assembly should judge for itself in matters of discipline, headed by George Müller; (3) the Exclusives, the Darbyites, holding what may be described as a Pauline view of the Church, who claim to be the original Brethren, represented by J. B. Stoney and C. H. Mackintosh; (4) the Exclusives associated in Great Britain with C. E. Stuart, in America with F. W. Grant; (5) the Exclusives who followed W. Kelly, giving a general adhesion to Darby but with a tendency to place conscience above church action, holding the Pauline view of the Church modified by Johannine elements; and (6) the Exclusives who followed Cluff. The fundamental principle of the Exclusives, "Separation from evil God's principle of unity," has led to many unimportant excommunications and separations besides those mentioned.

The theological views of the Brethren differ considerably from those held by evangelical Protestants (for a list of divergences, see Teulon, *History and Doctrines of the Plymouth Brethren*). They make the baptism of infants an open question and celebrate the Lord's Supper weekly. Their distinctive doctrines are ecclesiastical. They hold that all official ministry, whether on Episcopalian, Presbyterian or Congregationalist theories, is a denial of the spiritual priesthood of all believers, and sets aside the Holy Spirit's guidance. The gradual growth of this opinion, and perhaps the reasons for holding it, may be traced in Darby's earlier writings. While a curate in Ireland he was indignant with Archbishop Magee, who had stopped the progress of mission work among Roman Catholics by imposing on all who joined the church the oath of supremacy. This led Darby to the idea that established churches are as foreign to the spirit of Christianity as the papacy is ("Considerations addressed to the Archbishop of Dublin, &c., *Coll. Works*, i. 1). The parochial system, when enforced to the extent of prohibiting the preaching of the gospel within a parish where the incumbent was opposed to it, led him to consider the whole system a hindrance to the proper work of the church and therefore anti-Christian ("Thoughts on the present position of the Home Mission," *Coll. Works*, i. 78). And the waste of power implied in the refusal to sanction lay preaching seemed to him to lead to the conclusion that an official ministry was a refusal of the gifts of the Spirit to the church ("On Lay Preaching," *Coll. Works*, p. 200). The movement, if it has had small results in the formation of a sect, has at least set churches to consider how they might make their machinery more elastic. Perhaps one of the reasons of the comparatively small number of Brethren may be found in their idea that their mission is not to the heathen but to the "awakened in the churches."

The movement has a distinct interest for students of church history: (1) as illustrating again the desire of certain Christians to pass over the faded experience of the centuries, and by going straight to the Bible to make a fresh start without any other authority, precedent or guidance; (2) in its development alongside the Evangelical, Tractarian and Broad Church movements of the 19th century and its affinities with them all. A certain haphazardism that has always marked the Brethren is responsible for the present lack of qualified leaders. The early enthusiasm has waned, and no provision was made for proper theological study.

AUTHORITIES.—Darby, *Collected Works* (32 vols., edited by Kelly, with supplementary volume, 1867-1883); A. Miller, *The Brethren, their Rise, Progress and Testimony* (1879); Rogers, *Church Systems of the Nineteenth Century*; Teulon, *History and Doctrines of the Plymouth Brethren* (1883); article "John Nelson Darby," in *Contemp. Rev.* (Oct. 1885); W. B. Neatby, *A History of the Plymouth Brethren* (London, 1902, 2nd ed.). (T. M. L.; A. J. G.)

PLYMPTON ST MARY and PLYMPTON MAURICE (or EARL'S), two small adjacent towns in the southern parliamentary division of Devonshire, England, 5 m. E.N.E. of Plymouth, on the Great Western railway. Pop. (1901), Plympton St Mary, 1,587; Plympton Maurice, 1,130. Plympton St Mary contains a fine Decorated and Perpendicular church, with a lofty tower of the later period. Near it are remains of the former rich Augustinian priory of Plympton, founded by William Warewast, bishop of Exeter (1107-1136). They include an Early English refectory

with Norman undercroft, the kitchen and other fragments; but there are no remains of the great priory church. At Plympton Maurice are slight ruins of the castle built by Richard de Redvers, 1st earl of Devon (whence the variant of the name), in the time of Henry I. There are several picturesque old houses in the town, together with a guildhall dated 1696, and a grammar school founded in 1658, of which Sir Joshua Reynolds's father was master.

Plympton (*Plintona*) bears traces of very ancient settlement, the earthworks on which in the 12th century Richard de Redvers reared his Norman castle being probably of British origin, while a Saxon document dated 904 records a grant by Edward the Elder to Asser, bishop of Sherborne, of twelve manors in exchange for the monastery of "Plymentun." According to the Domesday survey "Plintona" was a royal manor assessed at 2½ hides, and the fact that the canons of Plympton held two hides apart from these shows the origin of the later division into the priory parish of Plympton St Mary and the secular borough of Plympton Erle. In the 12th century Plympton appears as a mesne borough under the lordship of the Redvers, earls of Devon, and in 1224 the burgesses claimed to have received a charter from William, the 6th earl, of which however nothing further is known, and the first charter of which a copy is extant was issued by Baldwin de Redvers in 1242, granting to the burgesses of Plympton the borough, with fairs and markets, and the liberties enjoyed by the citizens of Exeter, in consideration of a yearly payment of £24, 2s. 2d. In 1437 a charter from Edward IV. granted to the burgesses an eight-days' fair at the Feast of the Nativity of St John the Baptist, but at this period the growing importance of Plymouth was steadily robbing Plympton of its position as head of the district. In 1602, in response to a petition of the burgesses, Elizabeth issued a charter of incorporation, instituting a common council to consist of a mayor and 8 principal burgesses; a Saturday market, and fairs at the Feasts of the Ascension and the Annunciation. A code of by-laws dated 1623 mentions a fair on St Luke's Day in addition to the three above mentioned. The borough surrendered its charter to Charles II. in 1684, and in 1685 received a fresh charter from James II. instituting an additional market on Wednesday and a fair on the 1st of August. This charter was declared invalid in 1690, but its provisions were reaffirmed in 1692, with the addition of an eight-days' fair to begin on the 14th of February. The borough, which had returned two members to parliament since 1205, was disfranchised by the Reform Act of 1832 and from this date the municipal privileges gradually lapsed, and in 1859 were finally abolished.

See *Victoria County History: Devonshire*; William Cotton, *Some Account of the Ancient Borough Town of Plympton St Maurice* (London, 1859); J. Brooking Rowe, *Notes of Plympton Castle* (Plymouth, 1880).

PNEUMATIC DESPATCH, the name given to a system of transport of written despatches through long narrow tubes by the agency of air pressure. It was introduced in 1853 by J. Latimer Clark, between the Central and Stock Exchange stations of the Electric and International Telegraph Company in London. The stations were connected by a tube 1½ in. in diameter and 220 yds. long. Carriers containing batches of telegrams, and fitting piston-wise in the tube, were sucked through it (in one direction only) by the production of a partial vacuum at one end. In 1858 C. F. Varley improved the system by using compressed air to force the carriers in one direction, a partial vacuum being still used to draw them in the other direction. This improvement enables single radiating lines of pipe to be used both for sending and for receiving telegrams between a central station supplied with pumping machinery and outlying stations not so supplied.

Radial System.—In the hands of R. S. Culley and R. Sabine the radial system of pneumatic despatch was in 1870 brought to great perfection in connexion with the telegraphic department of the British post office, since that date the total length of tubes (which are employed for telegrams only) has been very largely increased (in 1909 there was in London a total length of

40 m.), whilst in all large and also in very many smaller provincial towns there are installations; these are constantly being added to, as it is found more economical to transmit local message-work by tube rather than by wire, as skilled telegraphists are not required, but only tube attendants. In some cases only a single tube is necessary, but three or four, or even more, are in use in some towns, according to local circumstances. Short tubes, known as "house tubes" are in use in a great number of offices; such tubes, which are worked either by hand-pumps (when the tubes are very short and the traffic inconsiderable) or by power, are usually $1\frac{1}{2}$ in. in diameter, and are used for the purpose of conveying messages from one part of a telegraph instrument-room to another, or from the instrument-room to the public counter. The underground, or "street" tubes are chiefly $2\frac{1}{2}$ in. in diameter, but there are also a number of 3-in. tubes in use; those in the large provincial towns (Birmingham, Bradford, Cardiff, Edinburgh, Glasgow, Grimsby, Liverpool, Manchester, Newport, Leeds, Newcastle, Southampton and Swansea) are $2\frac{1}{2}$ in. in diameter; but in Dublin, Gloucester, Lowestoft and Milford $1\frac{1}{2}$ -in. tubes are employed. There are fifty street tubes in London, varying in length from 100 to 2000 yds. (central office to the Houses of Parliament), and also seventy-five house tubes; the pumps for the whole system are worked by four 100 horse-power steam-engines. At Cardiff, Edinburgh, Gloucester, Leeds, Lowestoft, Newport, Southampton and Swansea the pumps are driven by electric motors; at Bradford and Grimsby gas-engines are used, and at Milford an oil-engine.

The tubes are in all cases of lead, the $2\frac{1}{2}$ -in. tubes weighing 8 lb per foot run and being made in lengths of 28 ft.; they are enclosed in 3-in. cast-iron pipes made in lengths of 9 ft.

Great care is exercised in making the joints in the lead pipes. Before the tube is placed in its trench a strong chain is passed through it, and a polished steel mandrel, 6 in. long and slightly less in diameter than the diameter of the tube, is heated and attached to the chain, and pushed half its length into the end of the tube already laid; the new length of tube is then forced over the projecting end of the mandrel until the tube ends (which have been previously cut flat) but perfectly together; an ordinary plumber's joint is then made. By this means the tube is made perfectly air-tight, and the mandrel keeps the surface of the tube under the joint as smooth as at any other part of its length. After the joint is completed the mandrel is drawn out by the chain attached to it, the next length is drawn on, and the above process repeated. The tubes are laid about 2 ft. below the surface of the ground.

The tubes radiate from the central to the branch offices, the principal offices having two tubes, one for "inward" and the other for "outward" traffic. At the smaller **Working** offices both the inward and the outward traffic is carried on through one tube. The "carriers" are made with gutta-percha bodies, covered with felt, the front of the carrier being provided with a buffer or piston formed of several disks of felt which closely fit the tube; the messages are prevented from getting out of the carrier by the end being closed by an elastic band, which can be stretched sufficiently to allow the message forms to be inserted. The 3-in. carriers will hold 75 ordinary message forms, the $2\frac{1}{2}$ -in. carriers 25 forms, and the $1\frac{1}{2}$ -in. carriers 20 forms. The carriers are propelled in one direction (from the central office) by "pressure," and drawn in the opposite direction by "vacuum," the standard pressure and vacuum being 10 lb and 6 $\frac{1}{2}$ lb per sq. in. respectively, which values give approximately the same speed.

The time of transit of a carrier through a tube when the air pressure does not exceed 20 lb per square inch is given very approximately by the empirical formula:—

$$t = .00872 \sqrt{\frac{l}{P_1^2}}$$

where l = length of tube in yards, d = diameter of tube in inches, P_1 = effective air-pressure in pounds per square inch, t = transit time in seconds. For vacuum the formula is:—

$$t = \frac{.00825}{1 - .234 \sqrt{15.5 - P_1}} \sqrt{\frac{l}{d}}$$

where P_1 = effective vacuum in pounds per square inch.

The horse-power required to propel a carrier is approximately, for pressure:—

$$\text{H.P.} = (.574 + .0011P) \sqrt{\frac{P_1}{T}}$$

for vacuum:—

$$\text{H.P.} = (.5187 - 1.214 \sqrt{15.5 - P_1}) P_1 \sqrt{\frac{P_1}{T}}$$

For a given transit time the actual horse-power required is much less in the case of vacuum than in the case of pressure working, owing to the density of the air column moved being much less; thus, for example, the transit time for 10 lb pressure is the same as for 6 $\frac{1}{2}$ lb vacuum, but the horse-power required in the two cases is as 1.83 to 1. A tube 1 m. long, $2\frac{1}{2}$ in. in diameter, and worked at 10 lb per square inch pressure, will have a transit time of 2 $\frac{1}{2}$ minutes, and will theoretically require 3.35 horse-power to be expended in working it, although actually 25% more horse-power than this must be allowed for, owing to losses through various causes. The transit time for a $2\frac{1}{2}$ -in. tube is 16% more than for a 3-in. tube of the same length, when both are worked at the same pressure, but the horse-power required is 50% less; it is not advisable, therefore, to use a tube larger than is absolutely necessary to carry the volume of traffic required.

The somewhat complicated pattern of "double sluice valve" originally used at the central stations has been superseded by a simpler form, known as the "D" box—so named **Despatching and Receiving Apparatus** from the shape of its cross section. This box is of cast iron, and is provided with a close-fitting, brass-framed, sliding lid with a glass panel. This lid fits air-tight, and closes the box after a carrier has been inserted into the mouth of the tube; the latter enters at one end of the box and is there bell-mouthed. A supply pipe, to which is connected a "3-way" cock, is joined on to the box and allows communication at will with either the "pressure" or "vacuum" mains, so that the apparatus becomes available for either sending (by pressure) or receiving (by vacuum) a carrier. Automatic working, by which the air supply is automatically turned on on the introduction of the carrier into a tube and on closing of the D box, and is cut off when the carrier arrives, was introduced in 1909.

On the long tubes (over about 1000 yds.) a modification of the "D" box in its simplest form is necessary; this modification consists in the addition of a "sluice" valve placed at a distance of about 9 in. (i.e. rather more than the length of a carrier) from the mouth of the tube. The sluice valve, by means of an interlocking arrangement, is so connected with the sliding lid of the box that the lid cannot be moved to the open position unless the sluice valve has closed the tube, nor can the sluice valve be opened unless the sliding lid is closed. The object of this sluice valve is to prevent the back rush of air which would take place into the tube when the sliding lid is opened to take out a carrier immediately on the arrival of the latter; for although the vacuum may be turned off by the 3-way cock, yet, owing to the great length of the tube, equilibrium does not immediately take place in the latter, and the back rush of air into the vacuum when the lid is opened to extract the carrier will cause the latter to be driven back into the tube. The sluice also prevents a similar, but reverse, action from taking place when pressure working is being carried on.

As a rule, only one carrier is despatched at a time, and no second carrier is inserted in the tube until the arrival of the first one at the farther end is automatically signalled (by an electric apparatus) to the despatching office. On some of the long tubes a carrier, when it passes the midway point in the tube, strikes a trigger and sends back an electrical signal indicating its passage; on the receipt of this signal a second carrier may be despatched. This arrangement has been almost entirely superseded by a signalling apparatus which by a clock movement actuates an indicating hand and moves the latter to "tube clear" a certain definite time (30 to 40 seconds) after a carrier has been inserted in the tube. By this arrangement carriers can be despatched one after the other at comparatively short intervals of time, so that several carriers (separated by distinct intervals) may be travelling through the tube simultaneously. It is necessary that the carriers be separated by a definite interval, otherwise they tend to overtake one another and become jammed

in the tube. Although the stoppage of a carrier in a tube is of exceedingly rare occurrence, it does occasionally take place, through picks being driven into the tube by workmen executing repairs to gas or water pipes, but the locality of such a stoppage is easily determined by a simple inspection along the route of the tube. In no case is any special means of testing for the locality from the central office found necessary.

Circuit System.—Another method of working, extensively used in Paris and other continental cities, is the circuit system, in which stations are grouped on circular or loop lines, round which carriers travel in one direction only. In one form of circuit system—that of Messrs Siemens—a continuous current of air is kept up in the tube, and rocking switches are provided by which carriers can be quickly introduced or removed at any one of the stations on the line without interfering with the movement of other carriers in other parts of the circuit. More usually, however, the circuit system is worked by despatching carriers, or trains of carriers, at relatively long intervals, the pressure or vacuum which gives motive power being applied only while such trains are on the line. On long circuits means are provided at several stations for putting on pressure or vacuum, so that the action may be limited to that section of the line on which the carriers are travelling at any time. In America, in New York, Boston and Philadelphia, tubes (Batcheller system) up to 8 in. in diameter are in use. The tubes are of cast iron made in 12-ft. lengths and are carefully bored; they resemble ordinary water pipe. Short bends are made in seamless brass tube carefully bent to a uniform radius of twelve times the diameter of the tube, the tube being slightly larger in diameter than the main tube. The sending apparatus, or transmitter, is similar to the Siemens switch before described, and consists of two sections of the tube supported in a swinging frame so arranged that either section can be brought into line with the main tube, in which a current of air is constantly flowing. One of these tube sections maintains the continuity of the main tube, while the other is swung to one side to receive a carrier. In despatching, a carrier is placed in an iron trough and then pushed into the open tube section. The frame carrying the two tube sections is then swung until the section containing the carrier is brought into line with the main tube, when the carrier is swept along with the current of air. When the frame is swinging from one position to another the air is prevented from escaping by plates that cover the ends of the tube, and a by-pass is provided so that the current is not interrupted. An air-motor, consisting of a cylinder and piston, furnishes the power to swing the frame, the operation requiring an instant only. When the controlling lever is pulled and latched the frame swings, and as the carrier passes out of the apparatus it trips the lever, and the frame swings back automatically into position to receive another carrier. To prevent carriers from being despatched too frequently and overtaking each other a time lock is attached to the sending apparatus; this locks the controlling valve when a carrier is despatched, and keeps it locked for a given period of time, varying from five to fifteen or twenty seconds, according to the adjustment of the lock. The carrier is received at the farther end of the tube into an air cushion formed by closing the end of the tube with a sluice-gate, and allowing the air to flow out into a branch pipe through slots in the tube located about 4 ft. in the rear of the sluice-gate. When a carrier arrives it passes over the slots, enters the air cushion and is brought to rest without injury or shock. The carriers are thin steel cylinders closed at the front end by a convex disk of the same material carrying a buffer of felt and

leather; the rear end is closed by a hinged lid secured by a lock. The shell of the carrier is 24 in. long and 7 in. in diameter for the 8-in. tube; it is secured by two bearing-rings of woven cotton fabric clasped between metal rings; the rings are renewed after about 2000 m. of travel. The tubes are worked at a pressure of 6 lb per sq. in., and for a distance of 4500 ft. require about 30 horse-power, the transit speed being 30 m. per hour.

In addition to its use for postal and telegraphic purposes the pneumatic despatch is employed for internal communication in offices, hotels, &c., and also in shops for the transport of money and bills between the cashier's desk and the counters.

REFERENCES.—The system as used in the United Kingdom is fully described in a paper by Messrs Culley and Sabine (*Min. Proc. Inst. Civ. Eng.* vol. xliii.). The same volume contains a description of the pneumatic telegraphs of Paris and of experiments on them by M. Bontemps, and also a discussion of the theory of pneumatic transmission by Professor W. C. Unwin. Reference should also be made to a paper, by C. Siemens (*Min. Proc. Inst. Civ. Eng.* vol. xxxiii.), describing the Siemens circuit system; and to *Les Télégraphes*, by M. A. L. Ternant (Paris, 1881); *General Post Office Technical Instructions*, vol. x. "Pneumatic Tubes"; *Kempe's Engineers' Year-Book* (1906 edition). (H. R. K.)

PNEUMATIC GUN. Air as a propellant has in recent years been applied to guns of large calibre, in which its comparatively gentle action has proved advantageous when high explosives contained in their shells are employed as projectiles. In 1883 Mr Mefford of Ohio utilized an air pressure of 500 lb per sq. in. in a 2-in. gun, and succeeded in propelling a projectile 2100 yds. The arrangement was of the simplest form—a hose with an ordinary cock by which the air was admitted into the gun behind the projectile. The question was then taken up by Capt. E. L. Zalinski (1849-1909) of the United States Artillery, who in 1888 reduced the so-called "dynamite gun" to a practical shape and obtained excellent firing results.

The principal features of his system are: (1) An extremely ingenious balanced valve admitting the air pressure into the gun. This valve is opened and closed by a simple movement of the firing lever, and is capable of adjustment so that the propelling force,

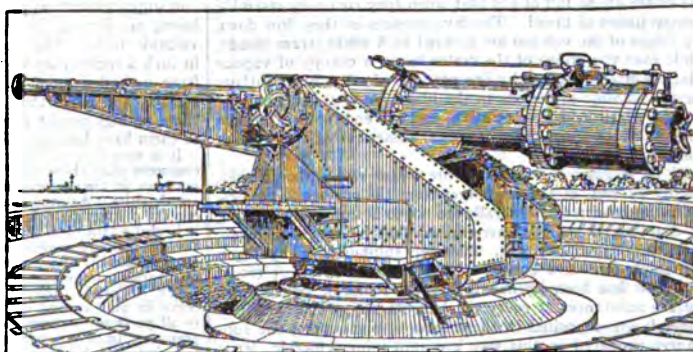

Dynamite gun, mounted at Sandy Hook, New York Harbour.

and consequently the range, can be regulated. (2) A light steel projectile carrying the bursting charge, and provided with a tail to which vanes are attached in order to give rotation. (3) Electric fuses of entirely original design. Each shell carries a wet battery, the current from which fires the charge on impact with any solid object, and a dry battery which becomes active after the charge after diving below the surface of the water, and ignites the charge after delay capable of regulation. For safety all the electric circuits are made to pass through a disconnector, which prevents them from being completed until the shell has been fired. The gun is a built-up smooth-bore tube, 15 in. or less in diameter. The full-calibre shell weighs 1000 lb, and carries a bursting charge of 600 lb of blasting gelatine, cut into the form of cheeses, fitting the steel envelope, and provided with a core of dry gun-cotton as a primer. Sub-calibre projectiles, 10 in. and 8 in., can also be used. In their case rotation is given by vanes or fins attached to the body of the shell. Air at 1000 lb pressure is stored in tubes close to the gun, and is supplied from primary reservoirs, to which it is directly

pumped at a pressure of about 2000 lb. There is always, therefore, a considerable reserve of power available without pumping. Pneumatic guns of this description (see figure) have been mounted for the protection of New York and San Francisco. With a full-calibre shell (1000 lb) these guns have a range of 2400 yds.; with a sub-calibre 8-in. shell (250 lb) the maximum range is 6000 yds. The official trials showed remarkable accuracy. At 5000 yds. 75% of the projectiles fell in an area of 360 X 90 ft. When the gun was tried at Shoeburyness the accuracy was far greater than could be obtained with howitzer shells propelled by explosives. On account of the power of exploding the shell under water, and thus securing a torpedo action, a direct hit upon a ship is not required, and the target offered is largely in excess of the dock plan. The gun is, in fact, capable of replacing systems of submarine mines with economy, and without the great objection of interfering with a waterway.

The only employment of the dynamite gun afloat has been in the case of the U.S. gunboat "Vesuvius," carrying three in the bows. These guns are fixed at a constant angle of elevation, and the range is regulated by the air valve, training being given by the helm. Thus mounted on an unstable platform, the accuracy of fire obtainable must evidently be much less than on shore. The "Vesuvius" was employed during the Spanish-American War of 1898, when on several nights in succession she approached the defences of Santiago under cover of darkness and discharged three projectiles. Fire delivered under such conditions could not be sufficiently accurate to injure coast defences; but the shells burst well, and made large craters. A small dynamite gun on a field-carriage was used in the land operations above Santiago in the same war.

PNEUMATICS (Gr. πνεύμα, wind, air), the branch of physical science concerned with the properties of gases and vapours (see GAS). A pneumatic trough is simply a basin containing water or some other liquid used for collecting gases.

PNEUMATOLYSIS (Gr. πνεύμα, vapour, and λύσις, to set free), in petrology, the discharge of vapours from igneous magmas and the effects produced by them on rock masses. In all volcanic eruptions the gases given off by the molten lavas are powerful agencies. The slaggy clots of lava thrown out from the crater are so full of gas that when they cool they resemble spongy pieces of bread. The lava streams as they flow down the slopes of the volcano are covered with white steam clouds, while over the orifice of the crater hangs a canopy of vapour which is often darkened by fine particles of ash. Most authors ascribe volcanic explosions to the liberation of steam from the magma which held it in solution, and the enormous expansive powers which free water vapour possesses at very high temperatures.

Of these gases the principal are water and carbonic acid, but by analysis of the discharges from the smaller fumaroles, for the active crater is generally too hot to be approached during an eruption, it has been ascertained that hydrogen, nitrogen, hydrochloric acid, boron, fluorine, sulphuretted hydrogen and sulphurous acid are all emitted by volcanoes. A recent lava flow has been likened to a great fumarole pouring out volatile substances at every crack in its slaggy crust. Many minerals are deposited in these fissures, and among the substances produced in this way are ammonium chloride, ferric chloride and oxide, copper oxide (tenorite and cuprite) and sulphur; by reacting on the minerals of the rock many zeolites and other secondary products are formed. These processes have been described as "juvenile" or "post eruptive," and it is believed that the amygdaloids which occupy the cavities of many porous lavas are not due really to weathering by surface waters percolating in from above, but to the action of the steam and other gases set free as the lava crystallizes. The zeolites are the principal group of minerals which originate in this way together with chlorite, chalcodony and calcite. The larger cavities (or geodes) are often lined with beautiful crystal groups of natrolite, scolecite, thomsonite, stilbite, and other minerals of this order.

The active gases were evidently in solution in the magma as it rose to the surface. Some geologists believe it is of subterranean origin like the lava itself, and is an essential or original component of the magma. They point to the exist-

ence of gases in considerable quantity in meteorites, and, comparing the earth to a great aerolite, insist that it should contain gases in solution like the smaller masses of the same kind. Others hold it more probable that the water has percolated in from the surface, or seeing that many volcanoes stand near the sea margin and by their linear disposition may be disposed along fissures or lines of weakening in the crust, they argue that the water of the sea may have filtered down even in spite of the great outward pressure exerted by the steam generated by contact with the intensely heated rock. The abundance of chlorides and hydrochloric acid is appealed to also in favour of a marine origin for the water. Against this we may place the fact that at great depths whence active magmas ascend the rocks are under so great pressures that every fissure is closed up; in fact in some of the deepest mines the quantity of water found in the workings is often exceedingly small. Probably there is some truth in both theories, but the balance of probability seems to incline in favour of the view that the water is an original and essential part of the magma and not an introduction from above.

Long after a lava has cooled down and become rigid the vapours continue to ooze out through its fissures, and around many volcanoes which are believed to be extinct there are orifices discharging gas in great quantities. This state of activity is said to be "solfataric," and a good example of it is the volcano called the Solfatara near Naples. The numerous "Solfidères" of the West Indies are further instances. The prevalent gas is steam with sulphuretted hydrogen and carbonic acid. At the Grotto del Cane in the Phlegrean Fields (Italy) the carbonic acid rising from fissures in the bottom of a cave covers the floor as a heavy layer, and a dog placed in the interior of the cave becomes stupefied by the narcotic gas; such gas-springs have been called "mofettes." Around them there is often a deposit of sulphur, produced by oxidation of the sulphuretted hydrogen, and the rocks are bleached, softened and decomposed. White crusts of alum, various sulphates, and sulphides such as pyrites, also carbonates of soda and other bases, are formed by the action of the acid vapours on the volcanic rocks. The final manifestation of volcanic activity in such a region may be the discharge of heated waters, which have ascended from the deep-seated magma far below the surface, and make their appearance as groups of hot springs; these springs persist long after the volcanoes which give rise to them have become quite extinct.

It is now believed by a large number of geologists and mining engineers that these ascending hot waters are of paramount importance in the genesis of some of the most important types of ore deposits. Analyses have proved that the igneous rocks often contain distinct though very small quantities of the heavy metallic it is also established beyond doubt that veins of gold, silver, lead, tin and mercury most commonly occur in the vicinity of intrusive igneous masses. At Steamboat in Nevada, hot springs, probably of magmatic origin, are forming deposits of cyanbar. At Cripple Creek, Colorado, and in many other places gold-bearing veins occur in and around intrusive plugs of igneous rock. Tin ores in all parts of the world are found in association with tourmaline granites. In all cases the veins bear evidence of having been filled from below by hot waters set free during the cooling of the igneous intrusions. Volcanic rocks are consequently the parent sources of many valuable mineral deposits, and the agency by which they were brought into their present situations is the volatile products discharged as the magma crystallized. The process was no doubt a long one and it is most probable that both steam and water took part in it. Above 365° C. water is a gas under all pressures and the action is strictly *pneumatolytic*; below that temperature steam is changed to water by pressure and the action may be described as *hydrotogenic*. The distinction is unessential, and in our ignorance of the temperatures and pressures prevailing at considerable depths we lack the means of classification. In what condition the metallic ores are dissolved and by what reactions they are precipitated depends on many factors only partly understood. The tin ores are so often associated with minerals containing boron and fluorine that it is quite probable that they were combined with these elements in some way, but they were deposited in nearly all cases as oxides. Other gaseous substances, such as sulphuretted hydrogen, carbonic acid, and hydrochloric acid, probably have an important part in dissolving certain metals; and the alkaline carbonates, sulphides and chlorides have been shown by experiment to act, also as solvents. In these ore deposits not only the heavy

metals are found, but often a much larger quantity of minerals such as calcite, barytes, fluorspar, quartz and tourmaline which serve as a matrix or gangue, and have been deposited by the same agencies, and often at the same time as the valuable minerals.

In their passage upwards and outwards through the rocks of the earth's crust, these gases and liquids not only deposit minerals in the fissures along which they ascend, but attack the surrounding rocks and alter them in many ways. The granite or other plutonic mass from which the vapours are derived is especially liable to these transformations, probably because it is at a high temperature, not having yet completely cooled down. Around the un-bearing veins in granite there is extensive replacement of felspar and biotite by quartz, tourmaline and white micas (the last-named often rich in lithia). In this way certain types of altered granite are produced, such as greisen (*q.v.*) and schorl rock (see SCHORL). In the slates adjacent to the tin veins tourmalinization also goes on, converting them into schorl-schists. The alteration of felspar into kaolin or china clay is also a pneumatolytic process, and is often found along with tin veins or other types of mineral deposit; probably both fluorine and carbonic acid operated in this instance along with water. Equally common and important is the silicification of rocks near mineral veins which carry gold, copper, lead and other metals. Granites and felsites may be converted into hard cherty masses of silica. Limestones undergo this transformation very readily; at the same time they are regarded as rocks very favourable to the deposition of ore. Probably the great frequency with which they undergo silicification and other types of metasomatic replacement is one of the main causes of the abundance of valuable deposits in them. The process known as "propylitization," which has extensively affected the andesites of the Hungarian goldfields, is believed to be also a consequence of the action of pneumatolytic gases. The andesites change to dull, soft, greenish masses, and their original minerals are to a large extent replaced by quartz, epidote, chlorite, sericite and kaolin. Around granites intrusive into serpentine and other rocks containing much magnesia, there is often extensive "steatitization," or the deposit of talc and steatite in place of the original minerals of the rock. Some of the apatite veins of Canada and Norway accompany basic rocks of the gabbrro group; it has been argued that the apatite (which contains phosphorus and chlorine) was laid down by vapours or solutions containing those gases, which may play a similar part in the basic rocks to that taken by fluorine and boron in the pneumatolytic veins around granites. In the country rock around the veins scapolite (*q.v.*), a lime alumina silicate, containing chlorine, often is substituted for lime-felspar.

These extensive changes attending the formation of mineral veins are by no means common phenomena, but in many plutonic masses pneumatolytic action has contributed to the formation of pegmatites (*q.v.*) (J. S. F.)

PNEUMONIA (Gr. *πνεύμων*, lung), a term used for inflammation of the lung substance. Formerly the disease was divided into three varieties: (1) Acute Croupous or lobar pneumonia; (2) Catarrhal or Broncho-pneumonia; (3) Interstitial or Chronic pneumonia.

1. *Acute Croupous or Lobar Pneumonia* (Pneumonic Fever) is now classed as an acute infective disease of the lung, characterized by fever and toxæmia, running a definite course and being the direct result of a specific micro-organism or micro-organisms. The micrococcus lanceolatus (pneumococcus, or diplococcus pneumoniae) of Fränkel and Weichselbaum is present in a large number of cases in the bronchial secretions, in the affected lung and in the blood. This organism is also present in many other infective processes which may complicate or terminate lobar pneumonia, such as pericarditis, endocarditis, peritonitis and empyema. The bacillus pneumoniae of Friedländer is also present in a proportion of cases, but is probably not the cause of true lobar pneumonia. Various other organisms may be associated with these, but they are to be regarded as in the nature of a secondary invasion. Lobar pneumonia may be considered as an acute endemic disease of temperate climates, though epidemic forms have been described. It has a distinct seasonal incidence, being most frequent in the winter and spring. Osler strongly supports the view that it is an infectious disease, quoting the outbreaks reported by W. L. Rodman of Frankfort, Kentucky, where in a prison of 735 inhabitants there were 118 cases in one year; but direct contagion does not seem to be well proved, and it is undoubted that the pneumococcus is present in the fauces of numbers of healthy persons and seems to require a lowered power of resistance or other favouring condition for the production of an attack.

Lobar Pneumonia begins by the setting up of an acute inflammatory process in the alveoli. The changes which take place in the lung are chiefly three. (1) *Congestion*, or engorgement, the blood-vessels being distended and the lung more voluminous and heavier than normal, and of dark red colour. Its air cells still contain air. (2) *Red Hepatization*, so called from its resemblance to liver tissue. In this stage there is poured into the air cells of the affected part an exudation consisting of amorphous fibrin together with epithelial cells and red and white blood corpuscles, the whole forming a viscid mass which occupies not only the cells but also the finer bronchi, and which speedily coagulates, causing the lung to become firmly consolidated. In this condition the cells are entirely emptied of air, their blood-vessels are pressed upon by the exudation, and the lung substance, rendered brittle, sinks in water. The appearance of a section of the lung in this stage has been likened to that of red granite. It is to the character of the exudation, consisting largely of coagulable fibrin, that the term croupous is due. (3) *Grey Hepatization*. In this stage the lung still retains its liver-like consistence, but its colour is now grey, not unlike the appearance of grey granite. This is due to the change taking place in the exudation, which undergoes resolution by a process of fatty degeneration, pus formation, liquefaction and ultimately absorption—so that in a comparatively short period the air vesicles get rid of their morbid contents and resume their normal function. During resolution the changes in the exudate take place by a process of autolysis or peptonization of the inflammatory products by unorganized ferments, absorption taking place into the lymphatics and circulation. The absorbed exudate is mainly excreted by the kidneys, excess of nitrogen being found in the urine during this period. This is happily the termination of the majority of cases of lobar pneumonia. One of the most remarkable phenomena is the rapidity with which the lung tissue clears up, and its freedom from alteration or from infiltration into the connective tissue as frequently takes place after broncho-pneumonia. When resolution does not take place, death may occur from extension of the disease and subsequent toxæmia, from circulatory failure, from the formation of one or more abscesses or more rarely from gangrene of the lung or from the complication mentioned below. Chronic interstitial pneumonia is infrequent, following on the acute variety. The most frequent seat of pneumonia is the base or lower lobes, but occasionally the apices are the only parts affected. The right lung is the most often attacked. Pneumonia may extend to the entire lung or it may affect both lungs. The death rate of acute lobar pneumonia in the chief London hospitals is 20%. With an organism so prevalent as the pneumococcus it follows that alcoholism, diabetes and other general diseases and intoxications must render the body liable to an attack. Males are more commonly attacked than females, and a previous attack seems to give a special liability to another. The incubation period of pneumonia is unknown; it is probably very short.

The symptoms are generally well marked from the beginning. The attack is usually ushered in by a rigor (or in children a convulsion), and the speedy development of the febrile condition, the temperature rising to a considerable degree—101° to 104° or more. The pulse is quickened, and there is a marked disturbance in the respiration, which is rapid, shallow and difficult, the rate being usually accelerated to some two or three times its normal amount. The lips are livid, and the face has a dusky flush. Pain in the side is felt, especially should any amount of pleurisy be present, as is often the case. Cough is an early symptom. It is at first frequent and hacking, and is accompanied with a little tough, colourless expectoration, which soon, however, becomes more copious and of a rusty red colour, either tenacious or frothy and liquid. Microscopically this consists mainly of epithelium, casts of the air cells and fine bronchi, together with granular matter, blood and pus corpuscles and hæmatoïdin crystals. The micro-organisms usually present are the pneumococcus, Friedländer's bacillus, and sometimes the influenza bacillus. The following are the chief physical signs in the various stages of the disease. In the stage of congestion fine crackling or crepitation is heard over the affected area; sometimes there is very little change from the natural breathing. In the stage of red hepatization the affected side of the chest is seen to expand less freely than the opposite side; there is dullness on

percussion, and increase of the vocal fremitus; while on auscultation the breath sounds are tubular or bronchial in character, with, it may be, some amount of fine crepitation in certain parts. In the stage of grey hepatization the percussion note is still dull and the breathing tubular, but crepitations of coarser quality than before are also audible. These various physical signs disappear more or less rapidly during convalescence. With the progress of the inflammation the febrile symptoms and rapid breathing continue. The patient during the greater part of the disease lies on the back or on the affected side. The pulse, which at first was full, becomes small and soft owing to the interruption to the pulmonary circulation. Occasionally slight jaundice is present, due probably to a similar cause. The urine is scanty, sometimes albuminous, and its chlorides are diminished. In favourable cases, however severe, there generally occurs after six or eight days a distinct crisis, marked by a rapid fall of the temperature accompanied with perspiration and with a copious discharge of lithates in the urine. Although no material change is as yet noticed in the physical signs, the patient breathes more easily, sleep returns, and convalescence advances rapidly in the majority of instances. In unfavourable cases death may take place either from the extent of the inflammatory action, especially if the pneumonia is double, from excessive fever, from failure of the heart's action or general strength at about the period of the crisis, or again from the disease assuming from the first a low adynamic form with delirium and with scanty expectoration of greenish or "prune juice" appearance. Such cases are seen in persons worn out in strength, in the aged, and especially in the intemperate.

The complications of acute pneumonia are pleurisy, which is practically inevitably present, empyema (in which the pneumococcus is frequently present and occasionally the streptococcus), pericarditis and endocarditis, both due to septic poisoning, while perhaps the most serious complication is meningitis, which is responsible for a large percentage of the fatal cases. The pneumococcus has been found in the exudate. Secondary pneumonias chiefly follow the specific fevers, as diphtheria, enteric fever, measles and influenza, and are the result of a direct poisoning. Bacteriologically a number of different organisms have been found, together with the specific microbe of the primary disease; the striking features of primary lobar pneumonia are often masked in these types.

The treatment of acute pneumonia has of late undergone a marked change, and may be divided into 3 heads: (1) General hygienic treatment; (2) the treatment of special symptoms; (3) treatment by vaccines and sera. The same treatment of absolute rest should be carried out as in enteric fever; this absolute rest is necessary to limit the auto-inoculation by the absorption of toxins. Fresh air in abundance and even open-air treatment if possible has been attended with good results. Ice poultices over the affected part are useful in the relief of pain, while tepid sponging and tepid or even cold baths may be freely given, and the patient's strength supported by milk, soups and other light forms of nourishment. Stimulants may be called for, and strychnine and digitalin are the most valuable; disinfection of the sputum should be systematically carried out. Many trials have been made with antipneumococcal serum, but it has not been shown to have a very marked effect in cutting short the disease. The polyvalent serum of Römer has given the best results. Much more favourable results have been obtained from the use of a vaccine. The results of vaccine treatment obtained by Boelke in 30 cases of severe pneumonia and one case of pneumococcal endocarditis are encouraging. The vaccine, to produce the best effects, should be made from the patient's own pneumococcus, as it is evident there are different strains of pneumococci, the doses (5 to 50 million dead pneumococci) being regulated by the guidance of the opsonic index. The objection to the preparation of the vaccine from the patient's own organisms is the time (several days) which is required, valuable time being thereby lost; but the results are much more certain than with the use of a "stock" vaccine.

2. *Broncho-Pneumonia* (Catarrhal or Lobular-Pneumonia or Capillary Bronchitis). An acute form of lobular pneumonia has been described, having all the characters of acute lobar pneumonia except that the pneumonic patches are disseminated. The term "broncho-pneumonia" is however here used to denote a widespread catarrhal inflammation of the smaller bronchi which spreads in places to the alveoli and produces consolidation. All forms of broncho-pneumonia depend on the invasion of the lung by micro-organisms. No one organism

has however been constantly found which can be said to be specific, as in lobar pneumonia; the influenza bacillus, micrococcus catarrhalis, pneumococcus, Friedländer's bacillus and various staphylococci having been found. John Eyre, in Albutt's *System of Medicine*, gives 62% of mixed infection in the cases investigated by him. Broncho-pneumonia may occur as an acute primary affection in children, but is more usually secondary. It may be a sequence of infectious fevers, measles, diphtheria, whooping cough, scarlet fever and sometimes typhoid fever. In these it forms a frequent and often a fatal complication. The large majority of the fatal cases are those of early childhood. In adults it may follow influenza or complicate chronic Bright's disease or various other disorders. Broncho-pneumonia also may follow operations on the mouth or trachea, or the inhalation of foreign bodies into the trachea. It is a frequent complication of pulmonary tuberculosis.

The following changes take place in the lung: at first the affected patches are dense, non-crepitant, with a bluish red appearance tending to become grey or yellow. Under the microscope the air vesicles and finer bronchi are crowded with cells, the result of the inflammatory process, but there is no fibrinous exudation such as is present in croupous pneumonia. In favourable cases resolution takes place by fatty degeneration, liquefaction, and absorption of the cells, but on the other hand they may undergo caseous degenerative changes, abscesses may form, or a condition of chronic interstitial pneumonia be developed, in both of which cases the condition passes into one of pulmonary tuberculosis. Evidence of previous bronchitis is usually present in the lungs affected with catarrhal pneumonia. In the great majority of instances catarrhal pneumonia occurs as an accompaniment or sequel of bronchitis, either from the inflammation passing from the finer bronchi to the pulmonary air vesicles, or from its affecting portions of lung which have undergone collapse.

The symptoms characterizing the onset of catarrhal pneumonia in its more acute form are the occurrence during an attack of bronchitis or the convalescence from measles or whooping cough, of a sudden and marked elevation of temperature, together with a quickened pulse and increased difficulty in breathing. The cough becomes short and painful, and there is little or no expectoration. The physical signs are not distinct, being mixed up with those of the antecedent bronchitis; but, should the pneumonia be extensive, there may be an impaired percussion note with tubular breathing and some bronchophony. Dyspnoea may be present in a marked degree; and death frequently occurs from paralysis of the heart. Broncho-pneumonia is a serious disease, the death-rate in children under five has been estimated at 30 to 50%.

The treatment of broncho-pneumonia is mainly symptomatic. At the outset a mild purgative is given, and should the secretion accumulate in the bronchial tubes an emetic is useful. Inhalations are useful to relieve the cough, and circulatory stimulants such as strychnine are valuable, together with belladonna and oxygen. When orthopnoea and lividity are present, with distension of the right heart, venesection is necessary. The treatment of broncho-pneumonia by serum and vaccine is not so successful as in lobar pneumonia, owing to the difficulty of ascertaining the precise bacterial infection. The great danger of broncho-pneumonia is the subsequent development of pulmonary tuberculosis.

3. *Chronic Interstitial Pneumonia* (Cirrhosis of the Lung) is a fibroid change in the lung, chiefly affecting the fibrous stroma and may be either local or diffuse. The changes produced in the lung by this disease are marked chiefly by the growth of nucleated fibroid tissue around the walls of the bronchi and vessels, and in the intervesicular septa, which proceeds to such an extent as to invade and obliterate the air cells. The lung, which is at first enlarged, becomes shrunken, dense in texture and solid, any unaffected portions being emphysematous; the bronchi are dilated, the pleura thickened, and the lung substance often deeply pigmented, especially in the case of miners, who are apt to suffer from this disease. The other lung is always greatly enlarged and distended from emphysema; the heart becomes hypertrophied, particularly the right ventricle; and there may be marked atheromatous changes in the

Blood vessels. Later the lung becomes converted into a series of bronchiectatic cavities. This condition is usually present to a greater or less degree in almost all chronic diseases of the lungs and bronchi, but it is specially apt to arise in an extensive form from pre-existing catarrhal pneumonia, and not unfrequently occurs in connexion with occupations which necessitate the habitual inhalation of particles of dust, such as those of colliers, flax-dressers, stonemasons, millers, &c., to which the term pneumokoniosis is now applied (including anthracosis, siderosis, chalicosis and the so-called "grinder's rot").

The symptoms are very similar to those of chronic phthisis (see TUBERCULOSIS), especially increasing difficulty of breathing, particularly on exertion, cough either dry or with expectoration, sometimes copious and fetid. In the case of coal-miners the sputum is black from containing carbonaceous matter. The physical signs are deficient expansion of the affected side—the disease being mostly confined to one lung—increasing dullness on percussion, tubular breathing and moist sounds. As the disease progresses retraction of the side becomes manifest, and the heart and liver may be displaced. Ultimately the condition, both as regards physical signs and symptoms, takes the characters of the later stages of pulmonary phthisis with colliquative symptoms, increasing emaciation and death. Occasionally dropsy is present from the heart becoming affected in the course of the disease. The malady is usually of long duration, many cases remaining for years in a stationary condition and even undergoing temporary improvement in mild weather, but the tendency is on the whole downward.

See Allbutt and Rolleston, *System of Medicine* (1909); R. W. Allen, *Vaccine Therapy and the Opsonic Method of Treatment* (1908); Osler, *Practice of Medicine* (1909); *The Practitioner* (May 1908); *Clinical Journal* (Jan. 1908); *American Journal of the Medical Sciences* (Jan. 1908); W. C. Bosanquet and J. Eyre, *Serums, Vaccines and Toxines* (1909).

PNOM-PENH, a town of French Indo-China, capital, since 1866, of the protectorate of Cambodia and seat of the resident-superior. Pop. about 60,000, consisting of Cambodians, Annamese, Chinese, Malays, Indians and about 600 Europeans. It is situated on the Mekong about 173 m. from its mouth at the point where it divides into two arms and is joined by the branch connecting it with the Great Lake (Tonlé-Sap). Its position makes it the market for the products of Cambodia, Laos, Upper Burma and part of Siam (dried fish, rice, cotton, indigo, cardamoms, &c.). The town is lighted by electricity. The palace of the king of Cambodia occupies a large space in the Cambodian quarter. The town gets its name from the *PNOM*, a central hill surmounted by an ancient pagoda.

PO (anc. *Padus*, Gr. *Ἰλδός*), a river of northern Italy, and the largest in the whole country, with a total length of about 370 m. direct from the source to the mouth, but, including its many windings, of some 417 m. The navigable portion from Casale Monferrato to the mouth is 337 m.; the minimum width of this portion 656 ft., and its minimum depth 7 ft. Owing to the prevalence of shallows and sandbanks, navigation is difficult.

The *Po* is the dominating factor in north Italian geography, north Italy practically consisting of the *Po* basin, with the surrounding slopes of the Alps and Apennines. For a description of its course, and a list of its principal tributaries see *ITALY*. The area of its basin, which includes portions of Switzerland and Austria, is estimated at 26,798 sq. m.

In the first 21 m. of its course, down to Revello (west of Saluzzo), the *Po* descends no less than 5250 ft., or a fall of 47·3:1000, forming a very remarkable contrast to its fall lower down. From the confluence of the Ticino its fall is about 0·3:1000; from the beginning of the delta below Ferrara, 0·08:1000. At Turin it has an average width of 400 to 415 ft., a mean depth of 3½ to 5½ ft., and a velocity of 1 to 2 ft. in the second. The mean depth from the confluence of the Ticino (altitude 217 ft.) downwards is 6 to 15 ft. The river is embanked from Piacenza, and continuously from Cremona, the total length of the embankments exceeding 600 m. Owing to its confinement between these high banks, and to the great amount of sedimentary matter which the river brings down with it, its bed has been gradually raised, so that in its lower course it is in many places above the level of the surrounding country. A result of confining the stream between its containing banks is the rapid growth of the delta. Lombardini calculated that the annual increase in the area of the *Po* delta during the period 1300 to 1600 amounted to 127 acres; but during the period 1600 to 1830 it rose to 324 acres. Marinelli¹ estimated that between the years 1823

and 1893 the annual increase was at the average rate of 173 to 175 acres, and the total accretion at about 20 sq. m.; and the total area of inundated land north and south of the delta at nearly 60 sq. m.² He further estimated that the *Po* della Maestra advances 282 ft. annually, the *Po* delle Tolle 262 ft., the *Po* della Gnocca 111½ ft., and the *Po* di Gorozzo 259 ft. The low ground between the lower *Po* and the lower Adige and the sea is known as *Polesine*, a name the derivation of which is much discussed. It is generally applied only to the province of Rovigo, but is sometimes extended to the neighbourhood of Adria and Ferrara. All along its course from Chivasso (below Turin) down to the delta the river is connected with several of its tributaries by canals, and at the same time other canals connect the tributaries and carry off their waters and the waters of the *Po* purely for purposes of irrigation.

The researches of Helbig (*Die Italiker in der Po-Ebene*, Leipzig, 1879) show that the lower valley of the *Po* was at an early period occupied by people of the Palaeolithic and Neolithic stages of civilization, who built houses on piles along the swampy borders of the streams. It is possible that even they may have begun by crude dikes the great system by which the waters are now controlled; at least it is certain that these works date their origin from pre-Roman antiquity. Pliny refers them to the Etruscans. The reclaiming and protecting of the riparian lands went on rapidly under the Romans, and in several places the rectangular divisions of the ground, still remarkably distinct, show the military character of some of the agricultural colonies. During the time of the barbarian invasions much of the protective system was allowed to fall into decay; but the latter part of the middle ages saw the works resumed with great energy, so that the main features of the present arrangement were in existence by the close of the 15th century.

The earlier Roman writers speak of the region between the northern boundaries of Etruria and Umbria and the Alps as Gallia Cisalpina. It was separate from Italy proper, the Aesis first and then the Rubicon being the boundary on the east, and the Arnus the boundary on the west, so that, for example, Luca remained outside the boundaries of Italy proper even in 89 B.C. Romanization had, however, progressed considerably; the foundation of colonies and the construction of roads had gone on during the 2nd century, and the whole district as far as the *Padus* was given the Roman franchise in 89 A.C., while the Transpadanes received Latin rights, and were fully enfranchised forty years later. Cisalpine Gaul was apparently formed into a province by Sulla in 81 B.C. and continued to be so until the fall of the Republic.

The Ligurian name of the *Po* was *Bodincus* or *Bodencus*, i.e. the bottomless. The name *Padus* was taken from the Celts or the Veneti. Thus we find *Bodincomagus* as a town name (*Industria*) on the upper course, and *Παδός* (*Padua*, *Catull.* 95, 7) as a name of one of the mouths of the river. The name *Ἡπόδαριος* (*Eridanus*) of Greek poetry was identified with it at a comparatively late period.

POACH (probably from Fr. *poche*, bag, or Eng. "poke," thrust into), to trespass on private property in pursuit of game or fish; also, generally, to catch game or fish by means or at times not permitted by the law, or in an unsportsmanlike manner (see *GAME LAWS*). The etymology is rather obscure, but as used in the independent sense of "poaching" an egg, i.e. cooking by breaking into boiling water, the word appears to be from the same original.

POBEDONOSTSEV, CONSTANTINE PETROVICH (1827-1907). Russian jurist, state official, and writer on philosophical and literary subjects. Born in Moscow in 1827, he studied at the School of Law in St Petersburg, and entered the public service as an official in one of the Moscow departments of the senate. From 1860 to 1865 he was professor of Russian civil law in the Moscow University, and instructed the sons of Alexander II. in the theory of law and administration. In 1868 he became a senator in St Petersburg, in 1872 a member of the council of the empire, and in 1880 chief procurator of the Holy Synod. He always showed himself an uncompromising Conservative, and never shrank from expressing boldly his opinions. Consequently, in the so-called Liberal camp he was always denounced an "obscurantist" and an enemy of progress. In the early years of the reign of Alexander II. (1855-1881), *Pobedonostsev* maintained, though keeping aloof from the Slavophiles, that Occidental institutions were radically bad in themselves and totally inapplicable to Russia. Parliamentary methods of administration, modern judicial organization and procedure, trial by jury, freedom of the press, secular education—these were among the principal objects of his aversion. He

¹ See G. Marinelli, in *Atti Inst. Veneto sci.*, 8th series, vol. viii. (1896-1897); and "L'Accrescimento del Delta del *Po* nel Secolo XIX.," in *Riv. Geogr. Ital.* (1898), vol. v.

subjected all of them to a severe analysis in his *Reflections of a Russian Statesman* (English by R. C. Long, London, 1898). To these dangerous products of Occidental rationalism he found a counterpoise in popular *vis inertiae*, and in the respect of the masses for institutions developed slowly and automatically during the past centuries of national life. Among the practical deductions drawn from these premises is the necessity of preserving the autocratic power, and of fostering among the people the traditional veneration for the ritual of the national Church. In the sphere of practical politics he exercised considerable influence by inspiring and encouraging the Russification policy of Alexander III. (1881-1894), which found expression in an administrative Nationalist propaganda and led to a good deal of religious persecution. After the death of Alexander III. he lost much of his influence, for Nicholas II., while clinging to his father's Russification policy and even extending it to Finland, disliked the idea of systematic religious persecution, and was not wholly averse from the partial emancipation of the Russian Church from civil control. During the revolutionary tumult which followed the disastrous war with Japan Pobédonostsev, being nearly 80 years of age, retired from public affairs. He died on the 23rd of March 1907.

POCHARD, POKARD, or POKER, names properly belonging to the male of a species of duck (the female of which is known as the Dunbird), the *Anas ferina* of Linnaeus, and *Nyroca ferina* of later ornithologists—but names very often applied by writers in a general way to most of the group or sub-family *Fuligulinae*, commonly called Diving or Sea-Ducks (see Duck). The Pochard in full plumage is a very handsome bird, with a coppery-red head, on the sides of which sparkle the ruby irides of his eyes, relieved by the greyish-blue of the basal half of his broad bill, and the deep black of his breast, while his back and flanks appear of a light grey, being really of a dull white closely barred by fine undulating black lines. The tail-coverts both above and below are black, the quill feathers brownish-black, and the lower surface of a dull white. The Dunbird has the head and neck reddish-brown, with ill-defined whitish patches on the cheeks and chin; the back and upper tail-coverts are dull brown, and the rest of the plumage, except the lower tail-coverts, which are brownish-grey, resembles that of the Pochard. This species is very abundant in many parts of Europe, northern Asia, and North America, generally frequenting in winter the larger open waters, and extending its migrations to Barbary and Egypt, but in summer retiring northward and inland to breed. The American Pochard is slightly larger, has yellow eyes, and is now regarded as specifically distinct under the name of *Nyroca americana*; but America has a perfectly distinct though allied species in the celebrated canvas-back duck, *N. valisneria*, a much larger bird, with a longer, higher and narrower bill, which has no blue at the base, and, though the plumage of both, especially in the females, is very similar, the male canvas-back has a darker head, and the black lines on the back and flanks are much broken up and farther asunder, so that the effect is to give these parts a much lighter colour, and from this has arisen the bird's common though fanciful name. Its scientific epithet is derived from the fresh-water plant, a species of *Valisneria*, usually known as "wild celery," from feeding on which its flesh is believed to acquire the delicate flavour that is held in so great a repute. The Pochard and Dunbird in Europe are in much request for the table (as the German name of the species, *Tafelente*, testifies) when they frequent fresh-water; birds killed on the sea-coast are so rank as to be almost worthless.

Among other species nearly allied to the Pochard that frequent the northern hemisphere may be mentioned the Scaup-Duck, *Fuligula marila*, with its American representative *F. affinis*, in

¹ The derivation of these words, in the first of which the *ck* is pronounced hard (though Dr Johnson made it soft), and the *o* in all of them generally long, is very uncertain. Cotgrave has *pocheulier* (modern French *poche-cullier*), which he renders "Shoemaker," nowadays the name of a kind of duck, but in his time meaning the bird we commonly call Spoonbill (*g.v.*). Littré gives *pochard* as a popular French word signifying drunkard.

both of which the male has the head black, glossed with blue or green; but these are nearly always unobtainable from the nature of their food, which is mostly gathered at low tide on the "scaups" or "scalps,"—as the banks on which mussels and other marine molluscs grow are in many places termed. Then there are the Tufted Duck, *F. cristata*—black with a crest and white flanks—and its American equivalent *F. collaris*, and the White-eyed Pochard, *F. nyroca*, and the Red-crested Pochard, *F. rufigula*—both peculiar to the Old World, and well known in India. In the southern hemisphere the genus is represented by three species, *F. caspensis*, *F. australis* and *F. novae-zealandiae*, whose respective names indicate the country each inhabits, and in South America exists a somewhat divergent form which has been placed in a distinct genus as *Melopanax pepusaca*.

Generally classed with the *Fuligulinae* is the small group known as the Eiders, which differ from them in several respects: the bulb at the base of the trachea in the male, so largely developed in the members of the genus *Fuligula*, is here much smaller and wholly of bone; the males take a much longer time, two or even three years, to attain their full plumage, and some of the feathers on the head, when that plumage is completed, are always stiff, glistening and of a peculiar pale-green colour. This little group of hardly more than half a dozen species may be fairly considered to form a separate genus under the name of *Somateria*. Many authors indeed have—unjustifiably, as it seems to the present writer—broken it up into three or four genera. The well-known Eider, *S. mollissima*, is the largest of this group, and, beautiful as it is, is excelled in beauty by the King-Duck, *S. spectabilis*, and the little *S. stelleri*. A most interesting form generally, but obviously in error, placed among them, is the Logger-head, Racehorse or Steamer-Duck, *Micropterus* (or more probably *Tachyeres*) *cinerus* of Chile, the Falkland Islands and Straits of Magellan—nearly as large as a tame goose, and subject to the, so far as known, unique peculiarity of losing its power of flight after reaching maturity. Its habits have been well described by C. Darwin in his *Journal of Researches*, and its anatomy is the subject of an excellent paper in the *Zoological Society's Transactions* (vii. 493-501, pls. lviii.-lxi.) by R. O. Cunningham. (A. N.)

POCKET, a small bag, particularly a bag-like receptacle either fastened to or inserted in an article of clothing. As a measure of capacity "pocket" is now only used for hops; it equals 168 lb. The word appears in Mid. Eng. as *poket*, and is taken from a Norman diminutive of O. Fr. *poke*, *poynse*, mod. *poche*, cf. "pouch." The form "poke" is now only used dialectically, or in such proverbial sayings as "a pig in a poke," and possibly in the "poke-bonnet," the coal-scuttle bonnet fashionable during the first part of the 19th century, and now worn by the female members of the Salvation Army; more probably the name of the bonnet is connected with "poke," to thrust forward, dig. The origin of this is obscure. Dutch has *poken*, *poek*, a dagger; Swedish *påk*, a stick.

POCKET-GOPHER (*i.e.* pouched rat), the name of a group of, chiefly North, American rat-like rodents, characterized by the possession of large cheek-pouches, the openings of which are external to the mouth; while their inner surface is lined with fur. The cheek-teeth, which comprise two pairs of premolars and three of molars in each jaw, are in the form of simple prisms of enamel, which do not develop roots. The fore and hind limbs are of approximately equal length, but the second and third front-claws are greatly enlarged, and all the claws are furnished at the base with bristles. The eyes are small, and the external ears rudimentary.

Pocket-gophers, which typify a family, the *Geomysidae*, spend the whole of their time underground, and are specially organized for such a mode of existence, their powerful claws being adapted for digging, while the bristles on the toes prevent the earth from passing between them. The upper incisor teeth are employed to loosen the ground, like a fork; and the little rodents are able to move both backwards and forwards in their runs. The cheek-pouches are employed solely in carrying food, which consists largely of roots. In the typical genus *Geomys* the upper incisors are grooved, but in the allied *Thomomys* they are smooth. The common pocket-gopher, *Geomys bursarius*, of the Mississippi Valley measures about 8 in. in length, with a tail of between 2 and 3 in.; its colour being rufous brown and greyish beneath. A well-known representative of the second genus is *Thomomys talpoides*, which is considerably smaller than the former. To the farmer and the gardener pocket-gophers are an unmitigated source of annoyance. (See RODENTIA.)

POCKET-MOUSE, the name of a number of small jerboa-like, chiefly North, American rodents belonging to the family *Geomysidae*, and constituting the genus *Perognathus* and *Heteromys*. They are nearly allied to the American kangaroo-rats (see

KANGAROO-RAT), but differ in having rooted molar teeth. The typical pocket-mouse *P. fasciatus*, which is a native of Montana, Missouri, and Wyoming, is a sandy-coloured rodent marked with black lines above and with white beneath, and measuring about 6 in. in length, this length being equally divided between the head and body and the tail. (See **RODENTIA**.)

POCOCK, SIR GEORGE (1706-1792), British admiral, son of Thomas Pocock, chaplain in the navy, was born on the 6th of March 1706, and entered the navy under the protection of his maternal uncle, Captain Streynsham Master (1682-1724), in the "Superbe" in 1718. He became lieutenant in April 1725, commander in 1733, and post-captain in 1738. After serving in the West Indies he was sent to the East Indies in 1754 as captain of the "Cumberland" (58) with Rear-Admiral Charles Watson (1714-1757). Watson's squadron co-operated with Clive in the conquest of Bengal. In 1755 Pocock became rear-admiral, and was promoted vice-admiral in 1756. On the death of Watson he took the command of the naval forces in the eastern seas. In 1758 he was joined by Commodore Charles Stevens (d. 1761), but the reinforcement only raised the squadron to seven small line-of-battle ships. War being now in progress between France and England the French sent a naval force from their islands in the Indian Ocean into the Bay of Bengal to the assistance of Pondicherry. To intercept the arrival of these reinforcements for the enemy now became the object of Pocock. The French force was indeed of less intrinsic strength than his own. Count D'Aché (1700?-1775), who commanded, had to make up his line by including several Indiamen, which were only armed merchant ships. Yet the number of the French was superior and Pocock was required by the practice of his time to fight by the old official fighting instructions. He had to bring his ships into action in a line with the enemy, and to preserve his formation while the engagement lasted. All Pocock's encounters with D'Aché were indecisive. The first battle, on the 29th of April 1758, failed to prevent the Frenchmen from reaching Pondicherry. After a second and more severe engagement on the 3rd of August, the French admiral returned to the Mauritius, and when the monsoon set in Pocock went round to Bombay. He was back early in spring, but the French admiral did not return to the Bay of Bengal till September. Again Pocock was unable to prevent his opponent from reaching Pondicherry, and a well-contested battle between them on the 10th of September 1759 proved again indecisive. The French government was nearly bankrupt, and D'Aché could get no stores for his squadron. He was compelled to return to the islands, and the English were left in possession of the Coromandel and Malabar coasts. Pocock went home in 1760, and in 1761 was made Knight of the Bath and admiral. In 1762 he was appointed to the command of the naval forces in the combined expedition which took Havana. The siege, which began on the 7th of June, and lasted till the 13th of August, was rendered deadly by the climate. The final victory was largely attributable to the vigorous and intelligent aid which Pocock gave to the troops. His share in the prize money was no less than £122,697. On his return to England Pocock is said to have been disappointed because another officer, Sir Charles Saunders (1713-1775), was chosen in preference to himself as a member of the admiralty board, and to have resigned in consequence. It is certain that he resigned his commission in 1766. He died on the 3rd of April 1792. His monument is in Westminster Abbey.

POCOCKE, EDWARD (1604-1691), English Orientalist and biblical scholar, was born in 1604, the son of a Berkshire clergyman, and received his education at the free school of Thame in Oxfordshire and at Corpus Christi College, Oxford (scholar in 1620, fellow in 1628). The first fruit of his studies was an edition from a Bodleian MS. of the four New Testament epistles (2 Peter, 2 and 3 John, Jude) which were not in the old Syriac canon, and were not contained in European editions of the Peshito. This was published at Leiden at the instigation of G. Vossius in 1630, and in the same year Poccocke sailed for Aleppo as chaplain to the English factory. At Aleppo he made himself a profound Arabic

scholar, and collected many valuable MSS. At this time Wm. Laud was bishop of London and chancellor of the university of Oxford, and Poccocke became known to him as one who could help his schemes for enriching the university. Laud founded an Arabic chair at Oxford, and invited Poccocke home to fill it, and he entered on his duties on the 10th of August 1636; but next summer he sailed again for Constantinople to prosecute further studies and collect more books, and remained there for about three years. When he returned to England Laud was in the Tower, but had taken the precaution to place the Arabic chair on a permanent footing. Poccocke does not seem to have been an extreme churchman or to have meddled actively in politics. His rare scholarship and personal qualities raised him up influential friends among the opposite party, foremost among these being John Selden and John Owen. Through their offices he was even advanced in 1648 to the chair of Hebrew, though as he could not take the engagement of 1649 he lost the emoluments of the post soon after, and did not recover them till the Restoration. These cares seriously hampered Poccocke in his studies, as he complains in the preface to his *Eutyphius*; he seems to have felt most deeply the attempts to remove him from his parish of Childrey, a college living which he had accepted in 1643. In 1649 he published the *Specimen historiae arabum*, a short account of the origin and manners of the Arabs, taken from Barhebraeus (Abulfargius), with notes from a vast number of MS. sources which are still valuable. This was followed in 1655 by the *Porta Mosis*, extracts from the Arabic commentary of Maimonides on the Mishna, with translation and very learned notes; and in 1656 by the annals of *Eutyphius* in Arabic and Latin. He also gave active assistance to Brian Walton's polyglot bible, and the preface to the various readings of the Arabic Pentateuch is from his hand. After the Restoration Poccocke's political and pecuniary troubles were removed, but the reception of his *Magnum opus*—a complete edition of the Arabic history of Barhebraeus (*Greg. Abulfargii historia compendiosa dynastiarum*), which he dedicated to the king in 1663, showed that the new order of things was not very favourable to profound scholarship. After this his most important works were a *Lexicon heptaglotton* (1669) and English commentaries on Micah (1677), Malachi (1677), Hosea (1685) and Joel (1691), which are still worth reading. An Arabic translation of Grotius's *De veritate*, which appeared in 1660, may also be mentioned as a proof of Poccocke's interest in the propagation of Christianity in the East. This was an old plan, which he had talked over with Grotius at Paris on his way back from Constantinople. Poccocke married in 1646, and died in 1691. One of his sons, Edward (1648-1727), published several contributions to Arabic literature—a fragment of Abdallatif's description of Egypt and the *Philosophus autodidactus* of Ibn Tufail.

The theological works of Poccocke were collected, in two volumes, in 1740, with a curious account of his life and writings by L. Twells.

PODEBRAD, GEORGE OF (1420-1471), king of Bohemia, was the son of Victoria of Kunstat and Poděbrad, a Bohemian nobleman, who was one of the leaders of the "Orphans" or modern Taborites during the Hussite wars. George himself as a boy of fourteen took part in the great battle of Lipan, which marks the downfall of the more advanced Taborites. Early in life, as one of the leaders of the Calixtine party, he defeated the Austrian troops of the German King Albert II., son-in-law and successor of King Sigismund. He soon became a prominent member of the national or Calixtine party, and after the death of Ptáček of Pirkstein its leader. During the minority of Ladislav, son of Albert, who was born after his father's death, Bohemia was divided into two parties—the Romanist or Austrian one, led by Ulrich von Rosenberg (1403-1462), and the national one, led by Poděbrad. After various attempts at reconciliation, Poděbrad decided to appeal to the force of arms. He gradually raised an armed force in north-eastern Bohemia, where the Calixtine cause had most adherents and where his ancestral castle was situated. With this army, consisting of about 9000 men, he marched in 1448 from Kutna Hora to Prague, and obtained possession of the capital almost without resistance. Civil war, however, broke

out, but Poděbrad succeeded in defeating the Romanist nobles. In 1451 the emperor Frederick III., as guardian of the young king Ladislas, entrusted Poděbrad with the administration of Bohemia. In the same year a diet assembled at Prague also conferred on Poděbrad the regency. The struggle of the Bohemians against Rome continued uninterrupted, and the position of Poděbrad became a very difficult one when the young king Ladislas, who was crowned in 1453, expressed his sympathies for the Roman Church, though he had recognized the compacts and the ancient privileges of Bohemia. In 1457 King Ladislas died suddenly, and public opinion from an early period accused Poděbrad of having poisoned him. The Bohemian historian, Palacky, fifty years ago thoroughly disproved this accusation, and, though it has recently been revived by German historians, it must undoubtedly be considered as a calumny. On the 27th of February 1458 the estates of Bohemia unanimously chose Poděbrad as king; even the adherents of the Austrian party voted for him, not wishing at that moment to oppose the popular feeling, which demanded the election of a national sovereign. A year after the accession of Poděbrad Pius II. (Aeneas Sylvius) became pope, and his incessant hostility proved one of the most serious obstacles to Poděbrad's rule. Though he rejected the demand of the pope, who wished him to consent to the abolition of the compacts, he endeavoured to curry favour with the Roman see by punishing severely all the more advanced opponents of papacy in Bohemia. Poděbrad's persecution of the newly-founded community of the Bohemian brethren is certainly a blemish on his career. All Poděbrad's endeavours to establish peace with Rome proved ineffectual, and though the death of Pius II. prevented him from carrying out his planned crusade against Bohemia, his successor was a scarcely less bitter enemy of the country. Though the rule of Poděbrad had proved very successful and Bohemia had under it obtained a degree of prosperity which had been unknown since the time of Charles IV., the Calixtine king had many enemies among the Romanist members of the powerful Bohemian nobility. The malcontent nobles met at Zelena Hora (Grüneberg) on the 28th of November 1465, and concluded an alliance against the king, bringing forward many—mostly untrue—accusations against him. The confederacy was from its beginning supported by the Roman see, though Poděbrad after the death of his implacable enemy, Pius II., attempted to negotiate with the new pope, Paul II. These negotiations ended when the pontiff grossly insulted the envoys of the king of Bohemia. On the 23rd of December 1466 Paul II. excommunicated Poděbrad and pronounced his deposition as king of Bohemia, forbidding all Romanists to continue in his allegiance. The emperor Frederick III., and King Matthias of Hungary, Poděbrad's former ally, joined the insurgent Bohemian nobles. King Matthias conquered a large part of Moravia, and was crowned in the capital of that country, Brno (Brünn), as king of Bohemia on the 3rd of May 1469. In the following year Poděbrad was more successful in his resistance to his many enemies, but his death on the 22nd of March 1471 put a stop to the war. In spite of the misfortunes of the last years of his reign, Poděbrad's memory has always been cherished by the Bohemians. He was the only king of Bohemia who belonged to that nation, and the only one who was not a Roman Catholic.

See H. Markgraf, *Über das Verhältniss des Königs Georg von Poděbrad zu Papst Pius II.* (1867); Jordan, *Das Königthum Georgs von Poděbrad* (1861); A. Bachmann, *Ein Jahr böhmischer Geschichte* (1876), and *Urkunden zur österreichischen Geschichte im Zeitalter Georgs von Poděbrad* (1879); E. W. Kanter, *Die Ermordung König Ladislaus* (1906); Novotny, *Über den Tod König Ladislaus Postumus* (1906). All histories of Bohemia, particularly that of F. Palacky (1836-1867), contain detailed accounts of the career of King George of Poděbrad.

PODESTÀ (Lat. *potestas*, power), the name given during the later middle ages to a high official in many Italian cities. Podestàs or rectors were first appointed by the emperor Frederick I. when about 1198 he began to assert his Imperial rights over the cities of northern Italy. Their business was to enforce these rights; from the first they were very unpopular, and their

arbitrary behaviour was a factor in bringing about the formation of the Lombard league and the rising against Frederick in 1167.

Although the emperor's experiment was short-lived podestàs soon became general in northern Italy, making their appearance in most communes about 1200. These officials, however, were now appointed by the citizens or by their representatives. They exercised the supreme power in the city, both in peace and war, both in foreign and domestic matters, but they only held office for a period of a year. In order to avoid the intestine strife so common in Italian civic life, it soon became the custom to select a stranger to fill this position. Venetians were in special request for this purpose during the 12th and 13th centuries, probably because at this time, at least, they were less concerned than other Italians in the affairs of the mainland. Afterwards in a few cases the term of office was extended to cover a period of years, or even a lifetime.

During the later part of the 12th and the whole of the 13th century most of the Italian cities were governed by podestàs. Concerning Rome, Gregorovius says that in 1205 "the pope changed the form of the civic government; the executive power lying henceforward in the hand of a single senator or podestà, who, directly or indirectly, was appointed by the pope." In Florence soon after 1180 the chief authority was transferred from the consuls to the podestà, and Milan and other cities were also ruled by these officials. There were, moreover, podestàs in some of the cities of Provence. Gradually the podestàs became more despotic and more corrupt, and sometimes a special official was appointed to hear complaints against them; in the 13th century in Florence and some other cities a *capitano del popolo* was chosen to look after the interests of the lower classes. In other ways also the power of the podestàs was reduced; they were confined more and more to judicial functions until they disappeared early in the 16th century.

The officials who were sent by the Italian republics to administer the affairs of dependent cities were sometimes called podestàs. At the present day the cities of Trent and Trieste give the name of podestà to their chief magistrate.

The example of Italy in the matter of podestàs was sometimes followed by cities and republics in northern Europe in the middle ages, notably by such as had trade relations with Italy. The officers thus elected sometimes bore the title of *podestà* or *podestale*. Thus in East Friesland there were podestàs identical in name and functions with those of the Italian republics; sometimes each province had one, sometimes the federal diet elected a podestà-general for the whole country, the term of office being for a limited period or for life (see J. L. Motley, *Dutch Republic*, i. 44, ed. 1903).

Lists of the Italian podestàs are given in Stokvis, *Manuel d'histoire*, vol. iii. (Leiden, 1889). See also W. F. Butler, *The Lombard Communes* (1906).

PODGORITSA (Croatian, *Podgorica*), the largest town in Montenegro; on the left bank of the river Moracha, and in a fertile valley which strikes inland for 18 m. from the shores of Lake Scutari to the mountains of central and eastern Montenegro. Pop. (1900), about 5500. Spread out on a perfectly flat plain, Podgoritsa has two distinct parts: the picturesque Turkish quarter, with its mosques and ruined ramparts, and the Montenegrin quarter, built since 1877, and containing a prison and an agricultural college. These quarters are separated by the river Ribnitsa, a tributary of the Moracha. A fine old Turkish bridge crosses the main stream. Podgoritsa receives from the eastern plains and the north-eastern highlands a great quantity of tobacco, fruit, cereals, honey, silk, livestock and other commodities, which it distributes through Plavnitsa, its port on Lake Scutari, and through Riyeka to Cetigne and Cattaro. After being captured from Turkey in 1877, Podgoritsa was in 1878 recognized as Montenegrin territory by the Treaty of Berlin.

PODIUM (Gr. *πόδιον*, diminutive of *πῶς*, foot), the name in architecture for a continuous pedestal, or low wall on which columns are carried, consisting of a cornice or capping, a dado or die, and a moulded plinth. In the Etruscan and Roman temples

the whole structure was raised on a podium, with a slight step on the principal front, enclosed between the prolongation of the podium wall.

PODOLIA, a government of south-western Russia, having Volhynia on the N., Kiev and Kherson on the E. and S., Bessarabia on the S.W., and Galicia (Austria) on the W., from which it is separated by the Zbrucz, or Rodovoha, a tributary of the Dniester. It has an area of 16,219 sq. m., extending for 200 m. from N.W. to S.E. on the left bank of the Dniester. In the same direction the government is traversed by two ranges of hills separated by the Bug, ramifications of the Avratynsk heights. These hills nowhere exceed an elevation of 1185 ft. Two large rivers, which numerous tributaries, drain the government—the Dniester, which forms its boundary with Bessarabia and is navigable throughout its length, and the Bug, which flows almost parallel to the former in a higher, sometimes swampy, valley, and is interrupted at several places by rapids. The Dniester is an important channel for trade, corn, spirits and timber being exported from Mogilev, Kalus, Zhvanets, Porog and other Podolian river-ports. The rapid smaller tributaries of the Dniester supply numerous flour-mills with motive power. The soil is almost throughout "black earth," and Podolia is one of the most fertile governments of Russia. Forests cover nearly 15% of the total area. Marshes occur only beside the Bug. The climate is moderate, the average temperature of the year at Kamenets being 48.3° (24.5° in January, 60° in July).

The estimated population in 1906 was 3,543,700. It consists chiefly of Little Russians, Poles (33%), and Jews (12%). There are besides a few Armenians, some Germans, and 50,000 Moldavians. There are many Nonconformists (18,000) among the Russians, Tulchin being the seat of their bishops and a centre of propaganda. After Moscow, Podolia is the most densely inhabited government of Russia outside Poland. It is divided into twelve districts, the chief towns of which are Kamenets-Podolskiy, the capital, Balta, Bratslav, Gaisin, Letichev, Litin, Mogilev-on-Dniester, Novaya-Ushitsa, Olgopol, Proskurov, Vinnitsa and Yampol. The chief occupations of the people are agriculture and gardening. The principal crops are wheat, rye, oats, barley, maize, hemp, flax, potatoes, beetroot and tobacco. Podolia is famous for its cherries and mulberries, its melons, gourds and cucumbers. Nearly 67,000 gallons of wine are obtained annually. Large numbers of horses, cattle and sheep are bred, the cattle being famous. Bee-keeping is an important industry. Sugar factories, distilleries, flour-mills, woollen mills, tanneries, potteries, tobacco factories, breweries, candle and soap factories, have an annual output valued at £4,000,000. An active trade is carried on with Austria, especially through the Isakovets and Gusyatin custom-houses, corn, cattle, horses, skins, wool, linseed and hemp seed being exported, in exchange for wooden wares, linen, woollen stuffs, cotton, glass and agricultural implements. The trade with the interior is also carried on very briskly, especially at the twenty-six fairs, the chief of which are Balta and Yarmolintsy. Podolia is traversed by a railway which runs parallel to the Dniester, from Lemberg to Odessa, and has two branch lines, to Kiev (from Zhmerinka) and to Poltava (from Balta).

History.—The country has been inhabited since the beginning of the Neolithic period. Herodotus mentions it as the seat of the Græco-Scythian Alazones and the Scythian Neuri, who were followed by the Dacians and the Getae. The Romans left traces of their rule in the Wall of Trajan, which stretches through the modern districts of Kamenets, Ushitsa and Proskurov. During the great migrations many nationalities passed through this territory, or settled within it for some time, leaving traces in numerous archaeological remains. Nestor mentions that the Bujanes and Dulebes occupied the Bug, while the Tivertsai and Ugliches, apparently all four Slav tribes, were settled on the Dniester. These peoples were conquered by the Avars in the 7th century. Oleg, prince of Kiev, extended his rule over this territory—the *Polissie*, or "lowlands," which became later a part of the principalities of Volhynia, Kiev and Galicia. In the 13th century the Polissie was seized by the Mongols; a hundred

years afterwards Olgiard, prince of Lithuania, freed it from their rule, annexing it to his own territories under the name of Podolia, a word which has the same meaning as *Ponizie*. After the death (1430) of the Lithuanian prince Vitovt, Podolia was annexed to Poland, with the exception of its eastern part, the province of Bratslav, which remained under Lithuania until its union (1501) with Poland. The Poles retained Podolia until the third division of their country in 1793, when it was taken by Russia. (P. A. K.; J. T. Bk.)

PODOLSK, a town of Russia, in the government of Moscow, 26 m. S. of the city of Moscow, at the junction of the two main roads from Moscow to the Crimea and to Warsaw. Pop. (1881), 11,000; (1897), 3808. It is picturesquely built on the hilly banks of the Pakhra, here crossed by a suspension bridge for carriages as well as by the railway bridge. Down to 1781 the wealthy village of Podol was a dependency of the Danilov monastery in Moscow. Before the opening of the southern railway the caravans of wagons and sledges to and from Moscow used to halt here; the principal occupation of the inhabitants was inkeeping and supplying the caravans with provisions and other necessaries of travel. The limestone quarries, at the confluence of the Desna and the Pakhra, supply the capital with good building material; and there are a cement, lime and brick factory and a paper-mill.

PODOPHYLLIN, a drug obtained from the rhizome of the American mandrake or may apple, *Podophyllum peltatum*, an herbaceous perennial belonging to the natural order Berberidaceae, indigenous in woods in Canada and the United States. The plant is about 1 ft. high, bearing two peltate, deeply-divided leaves, which are about 5 in. in diameter, and bear in the axil a solitary, stalked, white flower, about the size and shape of the garden anemone, with six or more petals and twice as many hypogynous stamens. The fruit is ripe in July, and is an oval, yellowish, fleshy berry, containing twelve or more seeds, each surrounded by a pulpy outer coat or aril. The rhizome, as met with in commerce, occurs in cylindrical pieces 2 or 3 in. long and about ¼ in. in diameter, of a chocolate or purplish-brown colour, smooth, and slightly enlarged where the juncture of the leafy stem is indicated by a circular scar on the upper and a few broken rootlets on the under side. The odour is heavy and disagreeable, and the taste acrid and bitter.

Podophyllin is a resinous powder obtained by precipitating an alcoholic tincture of the rhizome by means of water acidulated with hydrochloric acid. It varies in colour from greyish to bright yellow or greenish-brown, the first-named being the purest. The powder is soluble in alcohol and strong solutions of alkalis, such as ammonia. Its composition is somewhat complex. There are certainly at least two resins in the powder (which is known officially as *Podophylli resina*), one of them being soluble and the other insoluble in ether. Each of these contains an active substance, which can be obtained in crystalline form, and is known as podophyllotoxin. It is soluble in alcohol, ether, chloroform and boiling water. Alkalis decompose it into picro-podophyllin acid and picro-podophyllin, minute traces of both of which occur in a free state in the rhizome. The acid is inert, but picro-podophyllin is the active principle. It is a crystalline body, soluble only in concentrated alcohol. Hence the inutility of the pharmacopoeial *tinctura podophylli*, which cannot be diluted before administration. The properties of podophyllin resin vary with the reaction of the tissue with which it is in contact; where this is acid the drug is inert, the picro-podophyllin being precipitated.

The resin does not affect the unbroken skin, but may be absorbed from a raw surface, and will then cause purging. When taken internally it is both a secretory and an excretory cholagogue, but so irritant and powerful that its use in cases of jaundice is generally undesirable. Its value, however, in certain cases of constipation of hepatic origin is undeniable. It is largely used in patent medicines, usually as an auxiliary to aloe. The best method of prescribing podophyllin is in pill form. In toxic doses podophyllin causes intense enteritis, with all its characteristic symptoms, and severe depression, which may end in death. The treatment is symptomatic, there being no specific antidote.

POE, EDGAR ALLAN (1809-1849), American poet, writer of fiction and critic, was born at Boston, Massachusetts, on the 19th of January 1809. The family was of English origin, but was settled in Ireland, whence the poet's great-grandfather emigrated to Maryland. His grandfather, David Poe, served with credit as a

soldier in the War of Independence, was known to Washington, and was the friend of Lafayette. His son David Poe was bred as a lawyer, but deeply offended his family by marrying an actress of English birth, Mrs Elizabeth Hopkins, *née* Arnold, and by himself going on the stage. In 1811 he and his wife died, leaving three children—William, Edgar, and a daughter Rosalie—wholly destitute. William died young, and Rosalie became mad. Edgar was adopted by John Allan, a tobacco merchant of Scottish extraction, seemingly at the request of his wife, who was childless. The boy was indulged in every way, and encouraged to believe that he would inherit Mr Allan's fortune. Mr Allan, having come to England in 1815, placed Edgar in a school at Stoke Newington, kept by a Dr Bransby. In 1820 Mr Allan returned to Richmond, Virginia, and Edgar was first placed at school in the town and then sent to the university of Virginia at Charlottesville in 1826. Here the effects of a very unwise training on a temperament of inherited neurotic tendency were soon seen. He was fond of athletics, and was a strong and ardent swimmer; but he developed a passion for gambling and drink. His disorders made it necessary to remove him, and he was taken away by Mr Allan, who refused to pay his debts of honour. He enlisted on the 26th of May 1827 at Boston, and served for two years in the United States army. As a soldier his conduct must have been exemplary, for he was promoted sergeant-major on the 1st of January 1829. It is to be noted that throughout his life, when under orders, Poe could be a diligent and capable subordinate. In May 1829 Mr Allan secured his discharge from the army, and in 1830 obtained a nomination for him to the West Point military academy. As a student he showed considerable faculty for mathematics, but his aloofness prevented him from being popular with his comrades, and he neglected his duty. When court-martialled he made no answer to the charges, and was expelled on the 6th of March 1831. Mr Allan's generosity was now exhausted. The death of his first wife in 1829 had doubtless removed an influence favourable to Poe. A second marriage brought him children, and at his death in 1834 he left his adopted son nothing. A last meeting between the two, shortly before Mr Allan's death, led only to a scene of painful violence.

In 1827 Poe had published his first volume of poetry, *Tamerlane and other Poems*, at Boston. He did not publish under his name, but as "A Bostonian." In 1831 he published a volume of *Poems* under his name at New York. His life immediately after he left West Point is very obscure, but in 1833 he was living at Baltimore with his paternal aunt, Mrs Clemm, who was throughout life his protector, and, in so far as extreme poverty permitted, his support. In 1833 he won a prize of \$100 offered for the best story by the Baltimore *Saturday Visitor*. He would have won the prize for the best poem if the judges had not thought it wrong to give both rewards to one competitor. The story, *MS. found in a Bottle*, is one of the most mediocre of his tales, but his success gave him an introduction to editors and publishers, who were attracted by his striking personal appearance and his fine manners, and were also touched by his manifest poverty. From 1833 till his death he was employed on different magazines at Richmond, New York and Philadelphia. His famous poem "The Raven" was published first in 1843, and soon became extraordinarily popular; but Poe only got £2 for it.

The facts of his life have been the subject of very ill-judged controversy. The acrimonious tone of the biography by Rufus Griswold, prefixed to the first collected edition of his works in 1850, gave natural offence, and attempts have been made to show that the biographer was wrong as to the facts. But it is no real kindness to Poe's memory to deny the sad truth that he was subject to chronic alcoholism. He was not a boon companion, and never became callous to his vice. When it seized him he drank raw spirits, and was disordered by a very little. But when he was free from the maddening influence of alcohol he was gentle, well-bred, and a hard worker on the staff of a magazine, willing and able to write reviews, answer correspondents, propound riddles or invent and solve cryptograms. His value as a contributor and sub-editor secured him successive engagements

on the *Southern Literary Messenger* of Richmond, on the *New York Quarterly Review*, and on *Grubbs's Magazine* at Philadelphia. It enabled him in 1843 to have a magazine of his own, the *Stylus*. His mania sooner or later broke off all his engagements and ruined his own venture. In 1835 he married his cousin, Virginia Clemm, a beautiful girl of fourteen years of age. A false statement as to her age was made at the time of the marriage. She died after a long decline in 1847. Poe made two attempts to marry women of fortune—Mrs Whitman and Mrs Shelton. The first of these engagements was broken off. The second was terminated by his death in hospital at Baltimore, Md., on the 7th of October 1849.

His life and death had many precedents, and will always recur among Bohemian men of letters and artists. What was individual in Poe, and what alone renders him memorable, was his narrow but profound and original genius (see *AMERICAN LITERATURE*). In the midst of much hack-work and not a few failures in his own field he produced a small body of verse, and a handful of short stories of rare and peculiar excellence. The poems express a melancholy sensuous emotion in a penetrating melody all his own. The stories give form to horror and fear with an exquisite exactness of touch, or construct and unravel mysteries with extreme dexterity. He was a conscientious literary artist who revised and perfected his work with care. His criticism, though often commonplace and sometimes ill-natured, as when he attacked Longfellow for plagiarism, was trenchant and sagacious at his best.

BIBLIOGRAPHY.—*The Life and Letters of Edgar Allan Poe*, by J. A. Harrison (New York, 1903) and *The Life of Edgar Allan Poe* (Boston, new ed. 1909), by G. E. Woodberry, are the best biographies. The standard edition of his *Works* is that published in 1894-1895 at Chicago, in ten volumes, by E. C. Stedman and G. E. Woodberry. There have been many partial reprints. For Poe's influence in France, which has been great, see C. Baudelaire, *Histoires extraordinaires* (Paris, 1896); S. Mallarmé, *Poèmes d'Edgar Poe* (Brussels, 1888); and *Les Névrosés*, by Arvéde Barine (Paris, 1899). (D. H.)

POERIO, ALESSANDRO (1802-1848), Italian poet and patriot, was descended from an old Calabrian family, his father, Baron Giuseppe Poerio, being a distinguished lawyer of Naples. In 1815 he and his brother Carlo accompanied their father, who had been identified with Murat's cause, into exile, and settled at Florence. In 1818 they were allowed to return to Naples, and on the proclamation of the constitution in 1820 the Poerios were among the stoutest defenders of the newly-won freedom. Alessandro fought as a volunteer, under General Guglielmo Pepe, against the Austrians in 1821, but when the latter reoccupied Naples and the king abolished the constitution, the family was again exiled and settled at Gratz. Alessandro devoted himself to study in various German universities, and at Weimar he became the friend of Goethe. In 1833 the Poerios returned to Naples, and Alessandro, while practising law with his father, published a number of lyrics. In 1848 he accompanied Pepe as a volunteer to fight the Austrians in northern Italy, and on the recall of the Neapolitan contingent Alessandro followed Pepe to Venice and displayed great bravery during the siege. He was severely wounded in the fighting round Mestre, and died on the 3rd of November 1848. His poetry "reveals the idealism of a tender and delicate mind which was diligent in storing up sensations and images that for others would have been at most the transient impressions of a moment." But he could also sound the clarion note of patriotism, as in his stirring poem *Il Risorgimento*.

His brother Carlo (1803-1867), after returning to Naples, practised as an advocate, and from 1837 to 1848 was frequently arrested and imprisoned; but when King Ferdinand, moved by the demonstration of the 27th of January of the latter year, promulgated a constitution, he was made minister of education. Discovering, however, that the king was acting in bad faith, he resigned office in April and returned to Naples to take his seat in parliament, where he led the constitutional opposition. The Austrian victory of Novara (March 1849) set the king free to dissolve parliament and trample on the constitution, and on the 19th of July 1849 Poerio was arrested, tried, and condemned to

nineteen years in irons. Chained in pairs, he and other political prisoners were confined in one small room in the bagno of Nisida, near the Isazaretto. The eloquent exposure (1851) of the horrors of the Neapolitan dungeons by Gladstone, who emphasized especially the case of Poerio, awakened the universal indignation of Europe, but he did not obtain his liberty till 1858. He and other exiles were than placed on board a ship bound for the United States, but the son of Settembrini, another of the exiles, who was on board in disguise, compelled the crew to land them at Cork, whence Poerio made his way to London. In the following year he returned to Italy, and in 1860 he was elected deputy to the parliament of Turin, of which he was chosen vice-president in 1861. He died at Florence on the 28th of April 1867.

See Baldachini, *Della Vita e de' tempi di Carlo Poerio* (1867); W. E. Gladstone, *Two Letters to the Earl of Aberdeen* (1851); *Carlo Poerio and the Neapolitan Police* (London, 1858); Vannucci, *I Martiri della libertà italiana*, vol. iii. (Milan, 1880); Imbriani, *Alessandro Poerio a Venezia* (Naples, 1884); Del Giudice, *I Fratelli Poerio* (Turin, 1899); Countess Martinengo Cesaresco, *Italian Characters* (London, 1901).

POETRY. In modern criticism the word poetry (*i.e.* the art of the poet, Gr. *ποίησις*, maker, from *ποιέω*, to make) is used sometimes to denote any expression (artistic or other) of imaginative feeling, sometimes to designate a precise literary art, which ranks as one of the fine arts. As an expression of imaginative feeling, as the movement of an energy, as one of those great primal human forces which go to the development of the race, poetry in the wide sense has played as important a part as science. In some literatures (such as that of England) poetic energy and in others (such as that of Rome) poetic art is the dominant quality. It is the same with individual writers. In classical literature Pindar may perhaps be taken as a type of the poets of energy; Virgil of the poets of art. With all his wealth of poetic art Pindar's mastery over symmetrical methods never taught him to "sow with the hand," as Corinna declared, while his poetic energy always impelled him to "sow with the whole sack." In English poetical literature Elizabeth Barrett Browning typifies, perhaps, the poets of energy; while Keats (notwithstanding all his unquestionable inspiration) is mostly taken as a type of the poets of art. In French literature Hugo, notwithstanding all his mastery over poetic methods, represents the poets of energy.

In some writers, and these the very greatest—in Homer, Aeschylus, Sophocles, Dante, Shakespeare, Milton, and perhaps Goethe—poetic energy and poetic art are seen in something like equipoise. It is of poetry as an art, however, that we have mainly to speak here; and all we have to say upon poetry as an energy is that the critic who, like Aristotle, takes this wide view of poetry—the critic who, like him, recognizes the importance of poetry in its relations to man's other expressions of spiritual force, claims a place in point of true critical sagacity above that of a critic who, like Plato, fails to recognize that importance. And assuredly no philosophy of history can be other than inadequate should it ignore the fact that poetry has had as much effect upon human destiny as that other great human energy by aid of which, from the discovery of the use of fire to that of the electric light, the useful arts have been developed.

With regard to poetry as an art, most of the great poems of the world are dealt with elsewhere in this work, either in connexion with the names of the writers or with the various literatures to which they belong; consequently these remarks must be confined to general principles. Under **VERSE** the detailed questions of prosody are considered; here we are concerned with the essential principles which underlie the meaning of poetry as such.

All that can be attempted is to inquire: (1) What is poetry? (2) What is the position it takes up in relation to the other arts? (3) What is its value and degree of expressional power in relation to these? and, finally, (4) What varieties of poetic art are the outcome of the two great kinds of poetic impulse, dramatic imagination and lyric or egoistic imagination?

1: *What is Poetry?*—Definitions are for the most part alike unsatisfactory and treacherous; but definitions of poetry are proverbially so. Is it possible to lay down invariable principles

of poetry, such as those famous "invariable principles" of William Lisle Bowles, which in the earlier part of the century awoke the admiration of Southey and the wrath of Byron? Is it possible for a critic to say of any metrical phrase, stanza or verse, "This is poetry," or "This is not poetry"? Can he, with anything like the authority with which the man of science pronounces upon the natural objects brought before him, pronounce upon the qualities of a poem? These are questions that have engaged the attention of critics ever since the time of Aristotle. Byron, in his rough and ready way, answered them in one of those letters to his publisher John Murray, which, rich as they are in nonsense, are almost as rich in sense. "So far are principles of poetry from being invariable," says he, "that they never were nor ever will be settled. These principles mean nothing more than the predilections of a particular age, and every age has its own and a different from its predecessor. It is now Homer and now Virgil; once Dryden and since Sir Walter Scott; now Corneille and now Racine; now Crébillon and now Voltaire." This is putting the case very strongly—perhaps too strongly. But if we remember that Sophocles lost the first prize for the *Oedipus tyrannus*; if we remember what in Dante's time (owing partly, no doubt, to the universal ignorance of Greek) were the relative positions of Homer and Virgil, what in the time of Milton were the relative positions of Milton himself, of Shakespeare, and of Beaumont and Fletcher; again, if we remember Jeffrey's famous classification of the poets of his day, we shall be driven to pause over Byron's words before dismissing them. Yet some definition, for the purpose of this essay, must be here attempted; and, using the phrase "absolute poetry" as the musical critics use the phrase "absolute music," we may, perhaps, without too great presumption submit the following:—

Absolute poetry is the concrete and artistic expression of the human mind in emotional and rhythmical language.

This at least will be granted, that no literary expression can, properly speaking, be called poetry that is not in a certain deep sense emotional, whatever may be its subject-matter, concrete in its method and its diction, rhythmical in movement, and artistic in form.

That the expression of all real poetry must be concrete in method and diction is obvious, and yet this dictum would exclude from the definition much of what is called didactic poetry. With abstractions the poet has nothing to do, save to take them and turn them into concretions; for, as artist, he is simply the man who by instinct embodies in concrete forms that "universal idea" which Gravina speaks of—that which is essential and elemental in nature and in man; as poetic artist he is simply the man who by instinct chooses for his concrete forms metrical language. And the questions to be asked concerning any work of art are simply these—Is that which is here embodied really permanent, universal and elemental? and, Is the concrete form embodying it really beautiful—acknowledged as beautiful by the soul of man in its highest moods? Any other question is an impertinence.

As an example of the absence of concrete form in verse take the following lines from George Eliot's *Spanish Gypsy*:—

"Speech is but broken light upon the depth
Of the unspoken; even your loved words
Float in the larger meaning of your voice
As something dimmer."

Without discussing the question of blank verse cadence and the weakness of a line where the main accent falls upon a positive hiatus, "of the unspoken," we would point out that this powerful passage shows the spirit of poetry without its concrete form. The abstract method is substituted for the concrete. Such an abstract phrase as "the unspoken" belongs entirely to prose.

As to what is called ratiocinative poetry, it might perhaps be shown that it does not exist at all. Not by syllogism, but *per saltum*, must the poet reach in every case his conclusions. We listen to the poet—we allow him to address us in rhythm or in rhyme—we allow him to sing to us while other men are only

allowed to talk, not because he argues more logically than they, but because he feels more deeply and perhaps more truly. It is for his listeners to be knowing and ratiocinative; it is for him to be gnomic and divinely wise.

That poetry must be metrical or even rhythmical in movement, however, is what some have denied. Here we touch at once the very root of the subject. The difference between all literature and mere "word-kneading" is that, while literature is alive, word-kneading is without life. This literary life, while it is only bipartite in prose, seems to be tripartite in poetry; that is to say, while prose requires intellectual life and emotional life, poetry seems to require not only intellectual life and emotional life but rhythmic life, this last being the most important of all according to many critics, though Aristotle is not among these. Here indeed is the "fork" between the old critics and the new. Unless the rhythm of any metrical passage is so vigorous, so natural, and so free that it seems as though it could live, if need were, by its rhythm alone, has that passage any right to exist? and should it not, if the substance is good, be forthwith demetricalized and turned into prose? Thoreau has affirmed that prose, at its best, has high qualities of its own beyond the ken of poetry; to compensate for the sacrifice of these, should not the metrical gains of any passage be beyond all cavil?

This argument might be pressed farther still. It might seem bold to assert that, in many cases, the mental value of poetry may actually depend upon form and colour, but would it not be true? The mental value of poetry must be judged by a standard not applicable to prose; but, even with regard to the different kinds of poetry, we must not compare poetry whose mental value consists in a distinct and logical enunciation of ideas, such as that of Lucretius and Wordsworth, and poetry whose mental value consists partly in the suggestive richness of passion or symbol latent in rhythm (such as that of Sappho sometimes, Pindar often, Shelley always), or latent in colour, such as that of some of the *Importance* Persian poets. To discuss the question, Which of these *Importance* two kinds of poetry is the more precious? would be *Importance* idle, but are we not driven to admit that certain *Importance* poems whose strength is rhythm, and certain other poems whose strength is colour, while devoid of any logical statement of thought, may be as fruitful of thoughts and emotions too deep for words as a shaken prism is fruitful of tinted lights? The mental forces at work in the production of a poem like the *Excursion* are of a very different kind from the mental forces at work in the production of a poem like Shelley's "Ode to the West Wind." In the one case the poet's artistic methods, like those of the Greek architect, show, and are intended to show, the solid strength of the structure. In the other, the poet's artistic methods, like those of the Arabian architect, contradict the idea of solid strength—make the structure appear to hang over our heads like the cloud pagentry of heaven. But, in both cases, the solid strength is, and must be, there, at the base. Before the poet begins to write he should ask himself which of these artistic methods is natural to him; he should ask himself whether his natural impulse is towards the weighty iambic movement whose primary function is to state, or towards those lighter movements which we still call, for want of more convenient words, anapaestic and dactylic, whose primary function is to suggest. Whenever Wordsworth and Keats pass from the former to the latter they pass at once *Importance* into doggerel. Nor is it difficult to see why English anapaestic and dactylic verse must suggest, and not state, as even so comparatively successful a *Importance* tour de force as Shelley's "Sensitive Plant" shows. Conciseness is a primary virtue of all statement. The moment the English poet tries to "pack" his anapaestic or dactylic line as he can pack his iambic line, his versification becomes rugged, harsh, pebbly—becomes so of necessity. Nor is this all: anapaestic and dactylic verse must in English be obtrusively alliterative, or the same pebbly effect begins to be felt. The anapaestic line is so full of syllables that in a language where the consonants dominate the vowels (as in English), these syllables grate against each other, unless their corners are artfully bevelled by one of the two smoothing processes at the command of an English versifier—obtrusive alliteration, or an obtrusive use of liquids. Now these demands of form may be turned by the perfect artist to good account if his appeal to the listener's soul is primarily that of suggestion by his sound or symbol, but if his appeal is that of direct and logical statement the diffuseness inseparable from good anapaestic and dactylic verse is a source of weakness such as the true artist should find intolerable.

Using the word "form" in a wider sense still, a sense that includes "composition," it can be shown that poetry, to be entitled to the name, must be artistic in form. Whether a poem be a Welsh *triban* or a *stornello* improvised by an Italian peasant girl,

whether it be an ode by Keats or a tragedy by Sophocles, it is equally a work of art. The artist's command over form may be shown in the peasant girl's power of spontaneously rendering in simple verse, in her *stornello* or *rispetto*, *Form and Matter.* her emotions through nature's symbols; it may be shown by Keats in that perfect fusion of all poetic elements of which he was such a master, in the manipulation of language so beautiful both for form and colour that thought and words seem but one blended loveliness; or it may be shown by Sophocles in a mastery over what in painting is called composition, in the exercise of that wise vision of the artist which, looking before and after, sees the thing of beauty as a whole, and enables him to grasp the eternal laws of cause and effect in art and bend them to his own wizard will. In every case, indeed, form is an essential part of poetry; and, although George Sand's saying that "L'art est une forme" applies perhaps more strictly to the plastic arts (where the soul is reached partly through mechanical means), its application to poetry can hardly be exaggerated.

Owing, however, to the fact that the word *poetry* (first used to designate the poetic artist by Herodotus) means *maker*, Aristotle seems to have assumed that the indispensable basis of poetry is invention. He appears to have thought that a poet is a poet more on account of the composition of the action than on account of the composition of his verses. Indeed he said as much as this. Of epic poetry he declared emphatically that it produces its imitations either by mere articulate words or by metre superadded. This is to widen the definition of poetry so as to include all imaginative literature, and Plato seems to have given an equally wide meaning to the word *poetry*. Only, while Aristotle considered *poetry* to be an imitation of the facts of nature, Plato considered it to be an imitation of the dreams of man. Aristotle ignored, and Plato slighted, the importance of versification (though Plato on one occasion admitted that he who did not know rhythm could be called neither musician nor poet).

Perhaps the first critic who tacitly revolted against the dictum that substance, and not form, is the indispensable basis of poetry was Dionysius of Halicarnassus, whose treatise upon the arrangement of words is really a very fine piece of literary criticism. In his acute remarks upon the arrangement of the words in the sixteenth book of the *Odyssey*, as compared with that in the story of Gyges by Herodotus, was perhaps first enunciated clearly the doctrine that poetry is fundamentally a matter of style. The Aristotelian theory as to invention, however, dominated all criticism after as well as before Dionysius. When Bacon came to discuss the subject (and afterwards) the only division between the poetical critics was perhaps between the followers of Aristotle and those of Plato as to what poetry should, and what it should not, imitate. It is curious to speculate as to what would have been the result had the poets followed the critics in this matter. Had not the instinct of the poet been too strong for the school, would poetry as an art have been lost and merged in such imaginative prose as Plato's? Or is not the instinct for form too strong to be stifled? By the poets themselves metre was always considered to be the one indispensable requisite of a poem, though, as regards criticism, even in the time of the appearance of the *Waverley Novels*, the *Quarterly Review* would sometimes speak of them as "poems"; and perhaps even later the same might be said of romances so concrete in method and diction, and so full of poetic energy, as *Wuthering Heights* and *Jane Eyre*, where we get absolutely all that Aristotle requires for a poem. On the whole, however, the theory that versification is not an indispensable requisite of a poem seems to have become nearly obsolete. Perhaps, indeed, many critics would now go so far in the contrary direction as to say with Hegel (*Aesthetics*, ii. 285) that "metre is the first and only condition absolutely demanded by poetry, yet even more necessary than a figurative picturesque diction." At all events this is at least may be said, that the division between poetical critics is not now between Aristotelians and Baconians; it is of a different kind altogether. While one group of critics may still perhaps say with Dryden that "a poet is a maker, as the name signifies," and that "he who cannot make,

that is, invent, has his name for nothing," another group contends that it is not the invention but the artistic treatment, the form, which determines whether an imaginative writer is a poet or a writer of prose—contends, in short, that emotion is the basis of all true poetic expression, whatever be the subject-matter, that thoughts must be expressed in an emotional manner before they can be brought into poetry, and that this emotive expression demands even yet something else, viz. style and form.

Although many critics are now agreed that "L'art est une forme," that without metre and without form there can be no poetry, there are few who would contend that poetry can exist by virtue of any one of these alone, or even by virtue of all these combined. Quite independent of verbal melody, though mostly accompanying it, and quite independent of "composition," there is an atmosphere floating around the poet through which he sees everything, an atmosphere which stamps his utterances as poetry; for instance, among all the versifiers contemporary with Donne there was none so rugged as he occasionally was, and yet such songs as "Sweetest love, I do not go for weariness of thee" prove how true a poet he was whenever he could master those technicalities which far inferior poets find comparatively easy. While rhythm may to a very considerable degree be acquired (though, of course, the highest rhythmical effects never can), the power of looking at the world through the atmosphere that floats before the poet's eyes is not to be learned and not to be taught. This atmosphere is what we call *poetic imagination*. But first it seems necessary to say a word or two upon that high temper of the soul which in truly great poetry gives birth to this poetic imagination.

The "message" of poetry must be more unequivocal, more thoroughly accented, than that of any of the other fine arts. With regard to modern poetry, indeed, it may almost be said that if any writer's verse embodies a message, true, direct and pathetic, we cannot stay to inquire too curiously about the degree of artistic perfection with which it is delivered, for Wordsworth's saying "That which comes from the heart goes to the heart" applies very closely indeed to modern poetry. The most truly passionate poet in Greece was no doubt in a deep sense the most artistic poet; but in her case art and passion were one, and that is why she has been so cruelly misunderstood. The most truly passionate nature, and perhaps the greatest soul, that in recent years has expressed itself in English verse is Elizabeth Barrett Browning; at least it is certain that, with the single exception of Hood in the "Song of the Shirt," no writer of the 19th century really touched English hearts with a hand so powerful as hers—and this notwithstanding violations of poetic form, or defective rhymes, such as would appal some of the contemporary versifiers of England and France "who lisp in numbers for the numbers [and nothing else] come." The truth is that in order to produce poetry the soul must for the time being have reached that state of exaltation, that state of freedom from self-consciousness, depicted in the lines:—

"I started once, or seemed to start, in pain,
Resolved on noble things, and strove to speak,
As when a great thought strikes along the brain,
And flushes all the cheek."

Whatever may be the poet's "knowledge of his art," into this mood he must always pass before he can write a truly poetic line. For, notwithstanding all that may be said upon poetry as a fine art, it is in the deepest sense of the word an "inspiration." No man can write a line of genuine poetry without having been "born again" (or, as the true rendering of the text says, "born from above"); and then the mastery over those highest reaches of form which are beyond the ken of the mere versifier comes to him as a result of the change. Hence, with all Mrs Browning's metrical blemishes, the splendour of her metrical triumphs at her best.

For what is the deep distinction between poet and proseman? A writer may be many things besides a poet; he may be a warrior like Aeschylus, a man of business like Shakespeare, a courtier

like Chaucer, or a cosmopolitan philosopher like Goethe; but the moment the poetic mood is upon him all the trappings of the world with which for years he may perhaps have been clothing his soul—the world's knowingness, its cynicism, its self-seeking, its ambition—fall away, and the man becomes an inspired child again, with ears attuned to nothing but the whispers of those spirits from the Golden Age, who, according to Hesiod, haunt and bless the degenerate earth. What such a man produces may greatly delight and astonish his readers, yet not so greatly as it delights and astonishes himself. His passages of pathos draw no tears so deep or so sweet as those that fall from his own eyes while he writes; his sublime passages overawe no soul so imperiously as his own; his humour draws no laughter so rich or so deep as that stirred within his own breast.

It might almost be said, indeed, that Sincerity and Conscience, the two angels that bring to the poet the wonders of the poetic dream, bring him also the deepest, truest delight of form. It might almost be said that by aid of sincerity and conscience the poet is enabled to see more clearly than other men the eternal limits of his own art—to see with Sophocles that nothing, not even poetry itself, is of any worth to man, invested as he is by the whole army of evil, unless it is in the deepest and highest sense good, unless it comes linking us all together by closer bonds of sympathy and pity, strengthening us to fight the foes with whom fate and even Nature, the mother who bore us, sometimes seem in league—to see with Milton that the high quality of man's soul which in English is expressed by the word *virtue* is greater than even the great poem he prized, greater than all the rhythms of all the tongues that have been spoken since Babel—and to see with Shakespeare and with Shelley that the high passion which in English is called *love* is lovelier than all art, lovelier than all the marble Mercuries that "await the chisel of the sculptor" in all the marble hills.

2. *What Position does Poetry take up in Relation to the other Arts?*—Notwithstanding the labours of Lessing and his followers, the position accorded by criticism to poetry in relation to the other arts has never been so uncertain Poetry in Relation to the other Arts. and anomalous as in recent years. On the one hand there are critics who, judging from their perpetual comparison of poems to pictures, claim her as a sort of handmaid of painting and sculpture. On the other hand the disciples of Wagner, while professing to do homage to poetry, have claimed her as the handmaid of music. With regard to the relations of poetry to painting and sculpture, it seems necessary to glance for a moment at the saying of Simonides, as recorded by Plutarch, that poetry is a speaking picture and that painting is a mute poetry. It appears to have had upon modern criticism as much influence since the publication of Lessing's *Laocoon* as it had before. Perhaps it is in some measure answerable for the modern vice of excessive word-painting. Beyond this one saying, there is little or nothing in Greek literature to show that the Greeks recognized between poetry and the plastic and pictorial arts an affinity closer than that which exists between poetry and music and dancing. Understanding artistic methods more profoundly than the moderns, and far too profoundly to suppose that there is any special and peculiar affinity between an art whose medium of expression is marble and an art whose medium of expression is a growth of oral symbols, the Greeks seem to have studied poetry not so much in its relation to painting and sculpture as in its relation to music and dancing. It is matter of familiar knowledge, for instance, that at the Dionysian festival it was to the poet as "teacher of the chorus" (*χοροδιδάσκαλος*) that the prize was awarded, even though the "teacher of the chorus" were Aeschylus himself or Sophocles. And this recognition of the relation of poetry to music is perhaps one of the many causes of the superiority of Greek to all other poetry in adapting artistic means to artistic ends. In Greek poetry, even in Homer's description of the shield of Achilles, even in the famous description by Sophocles of his native woods in the *Oedipus coloneus*, such word-painting as occurs seems, if not inevitable and unconscious, so alive with imaginative feeling as to become part and parcel of the

dramatic or lyric movement itself. And whenever description is so introduced the reader of Greek poetry need not be told that the scenery itself rises before the listener's imagination with a clearness of outline and a vigour of colour such as no amount of detailed word painting in the modern fashion can achieve. The picture even in the glorious verses at the end of the eighth book of the *Iliad* rises before our eyes—seems actually to act upon our bodily senses—simply because the poet's eagerness to use the picture for merely illustrating the solemnity and importance of his story lends to the picture that very authenticity which the work of the modern word-painter lacks.

That the true place of poetry lies between music on the one hand and prose, or loosened speech, on the other, was, we say, taken for granted by the one people in whom the artistic instinct was fully developed. No doubt they used the word music in a very wide sense, in a sense that might include several arts. But it is a suggestive fact that, in the Greek language, long before poetic art was called "making" it was called "singing." The poet was not ποιητής but ᾄδων. And as regards the Romans it is curious to see how every now and then the old idea that poetry is singing rather than making will disclose itself. It will be remembered for instance how Terence, in the prologue of *Phormio*, alludes to poets as musicians. That the ancients were right in this could well be shown by a history of poetry: music and the lyrical function of the poet began together, but here, as in other things, the progress of art from the implicit to the explicit has separated the two. Every art has its special function, has a certain work which it can do better than any one of its sister arts. Hence its right of existence. For instance, before the "sea of emotion" within the soul has become "curdled into thoughts," it can be expressed in inarticulate tone. Hence, among the fine arts, music is specially adapted for rendering it. It was perhaps a perception of this fact which made the Syrian Gnostics define life to be "moving music." When this sea of emotion has "curdled into thoughts," articulate language rhythmically arranged—words steeped in music and colour, but at the same time embodying ideas—can do what no mere wordless music is able to achieve in giving its expression, just as unrhythmical language, language mortised in a foundation of logic, that is to say prose, can best express these ideas as soon as they have cooled and settled and cleared themselves of emotion altogether. Yet every art can in some degree invade the domain of her sisters, and the nearer these sisters stand to each other the more easily and completely can this invasion be accomplished. Prose, for instance, can sometimes, as in the case of Plato, do some of the work of poetry (however imperfectly, and however trammelled by heavy conditions); and sometimes poetry, as in Pindar's odes and the waxes of the Greek chorus, can do, though in the same imperfect way, the work of music.

The poems of Sappho, however, are a good case in point. Here the poet's passion is expressed so completely by the mere sound of her verses that a good recitation of them to a person ignorant of Greek would convey something of that passion to the listener; and similar examples almost as felicitous might be culled from Homer, from Aeschylus and from Sophocles. Nor is this power confined to the Greek poets. The students of Virgil have often and with justice commented on such lines as *Aen.* v. 481 (where the sudden sinking of a stricken ox is rendered by means of rhythm), and such lines as *Georg.* ii. 441, where, by means of verbal sounds, the gusts of wind about a tree are rendered as completely as though the voice were that of the wind itself. In the case of Sappho the effect is produced by the intensity of her passion, in the case of Homer by the intensity of the dramatic vision, in the case of Virgil by a supreme poetic art. But it can also be produced by the mere ingenuity of the artist, as in Edgar Poe's "Uialume." The poet's object in that remarkable *tour de force* was to express dull and hopeless gloom in the same way that the mere musician would have expressed it—that is to say, by monotonous repetitions, by hollow and dreadful reverberations of gloomy sounds—though as an artist whose vehicle was articulate speech he was obliged to add gloomy ideas, in order to give to his work the intellectual coherence necessary for its existence as a poem. He evidently set out to do this, and he did it, and "Uialume" properly intoned would produce something like the same effect upon a listener knowing no word of English that it produces upon us.

On the other hand, music can trench very far upon the

domain of articulate speech, as we perceive in the wonderful instrumentation of Wagner. Yet, while it can be shown that the place of poetry is scarcely so close to sculpture and painting as to music on the one side and loosened speech on the other, the affinity of poetry to music must not be exaggerated. We must be cautious how we follow the canons of Wagner and the more enthusiastic of his disciples, who almost seem to think that inarticulate tone can not only suggest ideas but express them—can give voice to the *Verstand*, in short, as well as to the *Vernunft* of man. Even the Greeks drew a fundamental distinction between melic poetry (poetry written to be sung) and poetry that was written to be recited. It is a pity that, while modern critics of poetry have understood, or at least have given attention to painting and sculpture, so few have possessed any knowledge of music—a fact which makes Dante's treatise *De vulgari eloquio* so important. Dante was a musician, and seems to have had a considerable knowledge of the relations between musical and metrical laws. But he did not, we think, assume that these laws are identical.

If it is indeed possible to establish the identity of musical and metrical laws, it can only be done by a purely scientific investigation; it can only be done by a most searching inquiry into the subtle relations that we know must exist throughout the universe between all the laws of undulation. And it is curious to remember that some of the greatest masters of verbal melody have had no knowledge of music, while some have not even shown any love of it. All Greek boys were taught music, but whether Pindar's unusual musical skill was born of natural instinct and inevitable passion, or came from the accidental circumstance that his father was, as has been alleged, a musician, and that he was as a boy elaborately taught musical science by Lasus of Hermione, we have no means of knowing. Nor can we now learn how much of Milton's musical knowledge resulted from a like exceptional "environment," or from the fact that his father was a musician. But when we find that Shelley seems to have been without the real passion for music, that Rossetti disliked it, and that Coleridge's apprehension of musical effects was of the ordinary nebulous kind, we must hesitate before accepting the theory of Wagner.

The question cannot be pursued here; but if it should on inquiry be found that, although poetry is more closely related to music than to any of the other arts, yet the power over verbal melody at its very highest is so all-sufficing to its possessor, as in the case of Shelley and Coleridge, that absolute music becomes a superfluity, this would only be another illustration of that intense egoism and concentration of force—the impulse of all high artistic energy—which is required in order to achieve the rarest miracles of art.

With regard to the relation of poetry to prose, Coleridge once asserted in conversation that the real antithesis of poetry was not prose but science. If he was right the difference in kind lies, not between the poet and the prose writer, but between the literary artist (the man whose instinct is to manipulate language) and the man of facts and of action whose instinct impels him to act, or, if not to act, to inquire. One thing is at least certain, that prose, however fervid and emotional it may become, must always be directed, or seem to be directed, by the reins of logic. Or, to vary the metaphor, like a captive balloon it can never really leave the earth.

Indeed, with the literature of knowledge as opposed to the literature of power poetry has nothing to do. Facts have no place in poetry until they are brought into relation with the human soul. But a mere catalogue of ships may become poetical if it tends to show the strength and pride and glory of the warriors who invested Troy; a detailed description of the designs upon a shield, however beautiful and poetical in itself, becomes still more so if it tends to show the skill of the divine artificer and the invincible splendour of a hero like Achilles. But mere dry exactitude of imitation is not for poetry but for loosened speech. Hence, most of the so-called poetry of Hesiod is not poetry at all. The Muses who spoke to him about "truth" on Mt. Helicon made the common mistake of confounding fact with

truth. And here we touch upon a very important matter. The reason why in prose speech is loosened is that, untrammelled by the laws of metre, language is able with more exactitude to imitate nature, though of course speech, even when "loosened," cannot, when actual sensible objects are to be depicted, compete in any real degree with the plastic arts in accuracy of imitation, for the simple reason that its media are not colours nor solids but symbols—arbitrary symbols which can be made to indicate, but never to reproduce, colours and solids. Accuracy of imitation is the first requisite of prose. But the moment language has to be governed by the laws of metre—the moment the conflict begins between the claims of verbal music and the claims of colour and form—then prosaic accuracy has to yield; sharpness of outline, mere fidelity of imitation, such as is within the compass of prose, have in some degree to be sacrificed. But, just as with regard to the relations between poetry and music the greatest master is he who borrows the most that can be borrowed from music, and loses the least that can be lost from metre, so with regard to the relations between poetry and prose the greatest master is he who borrows the most that can be borrowed from prose and loses the least that can be lost from verse. No doubt this is what every poet tries to do by instinct; but some sacrifice on either side there must be, and, with regard to poetry and prose, modern poets at least might be divided into those who make picturesqueness yield to verbal melody, and those who make verbal melody yield to picturesqueness.

With one class of poets, fine as is perhaps the melody, it is made subservient to outline or to colour; with the other class colour and outline both yield to metre. The chief aim of the first class is to paint a picture; the chief aim of the second is to sing a song. Weber, in driving through a beautiful country, could only enjoy its beauty by translating it into music. The same may be said of some poets with regard to verbal melody. The supreme artist, however, is he whose pictorial and musical power are so interfused that each seems born of the other, as is the case with Sappho, Homer, Aeschylus, Sophocles, and indeed most of the great Greek poets. Among English poets (leaving the two supreme masters undiscussed) Keats and Coleridge have certainly done this. The colour seems born of the music and the music born of the colour. In French poetry the same triumph has been achieved in Victor Hugo's magnificent poem "En chantant la nuit dans un bois," which, as a rendering through verbal music of the witchery of nature, stands alone in the poetry of France. For there the poet conquers that crowning difficulty we have been alluding to, the difficulty of stealing from prose as much distinctness of colour and clearness of outline as can be imported into verse with as little sacrifice as possible of melody.

If poetry can in some degree invade the domain of prose, so on the other hand prose can at times invade the domain of poetry, and no doubt the prose of Plato—what is called poetical prose—is a legitimate form of art. Poetry, the earliest form of literature, is also the final and ideal form of all pure literature; and, when Landor insists that poetry and poetical prose are antagonistic, we must remember that Landor's judgments are mostly based on feeling, and that his hatred of Plato would be quite sufficient basis with him for an entire system of criticism upon poetical prose. As with Carlyle, there was a time in his life when Plato had serious thoughts of becoming a poet. And perhaps, like Carlyle, having the good sense to see his true function, he himself desisted from writing, and strictly forbade other men to write, in verse. If we consider this, and if we consider that certain of the great English masters of poetic prose of the 17th century were as incapable of writing in metre as their followers Richter and Carlyle, we shall hardly escape the conclusion on the one hand that the faculty of writing poetry is quite another faculty than that of producing work in the arts most closely allied to it, music and prose, but that on the other hand there is nothing antagonistic between these faculties.

3. *Comparative Value in Expressional Power.*—There is one great point of superiority that musical art exhibits over metrical art. This consists, not in the capacity for melody, but in the capacity for harmony in the musician's sense. The finest music of Aeschylus, of Pindar, of Shakespeare, of Milton, is after all only a succession of melodious notes, and, in endeavouring to catch the harmonic intent of strophe, antistrophe and epode in the Greek chorus and in the true ode (that

of Pindar), we can only succeed by pressing memory into our service. We have to recall by memory the waves that have gone before, and then to imagine their harmonic power in relation to the waves at present occupying the ear. Counterpoint, therefore, is not to be achieved by the metricist, even though he be Pindar himself; but in music this perfect ideal harmony was foreshadowed perhaps in the earliest writing. We know at least that as early as the 12th century counterpoint began to show a vigorous life, and the study of it is now a familiar branch of musical science. Now, inasmuch as "nature's own hymn" is and must be the harmonic blending of apparently independent and apparently discordant notes, among the arts whose appeal is through the ear that which can achieve counterpoint must perhaps rank as a pure art above one which cannot achieve it. We are of course speaking here of metre only. We have not space to inquire whether the counterpoint of absolute poetry is the harmony underlying apparently discordant emotions—the emotion produced by a word being more persistent than the emotion produced by an inarticulate sound. But if poetry falls behind music in rhythmic scope, it is capable of rendering emotion after emotion has become disintegrated into thoughts, and here, as we have seen, it enters into direct competition with the art of prose. It can use the emphasis of sound, not for its own sake merely, but to strengthen the emphasis of sense, and can thus give a fuller and more adequate expression to the soul of man than music at its highest can give. With regard to prose, no doubt such writing as Plato's description of the chariot of the soul, his description of the island of Atlantis, or of Er's visit to the place of departed souls, comes but a short way behind poetry in imaginative and even rhythmic appeal. It is impossible, however, here to do more than touch upon the subject of the rhythm of prose in its relation to the rhythm of poetry; for in this matter the genius of each individual language has to be taken into account.

Perhaps it may be said that deeper than all the rhythm of art is that rhythm which art would fain catch, the rhythm of nature; for the rhythm of nature is the rhythm of life itself. This rhythm can be caught by prose as well as by poetry, such prose, for instance, as that of the English Bible. Certainly the rhythm of verse at its highest, such, for instance, as that of Shakespeare's greatest writings, is nothing more and nothing less than the metre of that energy of the spirit which surges within the bosom of him who speaks, whether he speak in verse or in impassioned prose. Being rhythm, it is of course governed by law, but it is a law which transcends in subtlety the conscious art of the metricist and is only caught by the poet in his most inspired moods, a law which, being part of nature's own sanctions, can of course never be formulated but only expressed, as it is expressed in the melody of the bird, in the inscrutable harmony of the entire bird-chorus of a thicket, in the whisper of the leaves of the tree, and in the song or wail of wind and sea. Now is not this rhythm of nature represented by that "sense rhythm" which prose can catch as well as poetry, that sense rhythm whose finest expressions are to be found in the Bible, Hebrew and English, and in the biblical movements of the English Prayer Book, and in the dramatic prose of Shakespeare at its best? Whether it is caught by prose or by verse, one of the virtues of the rhythm of nature is that it is translatable. Hamlet's peroration about man and Raleigh's apostrophe to death are as translatable into other languages as are the Hebrew psalms, or as is Manu's magnificent passage about the singleness of man:—

"Single is each man born into the world; single he dies; single he receives the reward of his good deeds, and single the punishment of his evil deeds. When he dies his body lies like a fallen tree upon the earth, but his virtue accompanies his soul. Wherefore let man harvest and garner virtue, so that he may have an inseparable companion in traversing that gloom which is so hard to be traversed."

Here the rhythm, being the inevitable movement of emotion and "sense," can be caught and translated by every literature under the sun. While, however, the great goal before the poet is to compel the listener to expect his caesuristic effects, the great goal before the writer of poetic prose is in the very opposite direction; it is to make use of the concrete figures and impassioned

diction of the poet, but at the same time to avoid the recognized and expected metrical bars upon which the poet depends. The moment the prose poet passes from the rhythm of prose to the rhythm of metre the apparent sincerity of his writing is destroyed.

As compared with sculpture and painting the great infirmity of poetry, as an "imitation" of nature, is of course that the

medium is always and of necessity words—even when no words could, in the dramatic situation, have been spoken. It is not only Homer who is obliged sometimes to forget that passion when at white heat is never voluble, is scarcely even articulate; the dramatists also are obliged to forget that in love and in hate, at their tensest, words seem weak and foolish when compared with the silent and satisfying triumph and glory of deeds, such as the plastic arts can render. This becomes manifest enough when we compare the Niobe group or the Laocoon group, or the great dramatic paintings of the modern world, with even the finest efforts of dramatic poetry, such as the speech of Andromache to Hector, or the speech of Priam to Achilles, nay such as even the cries of Cassandra in the *Agamemnon*, or the wailings of Lear over the dead Cordelia. Even when writing the words uttered by Oedipus, as the terrible truth breaks in upon his soul, Sophocles must have felt that in the holiest chambers of sorrow and in the highest agonies of suffering reigns that awful silence which not poetry, but painting sometimes, and sculpture always, can render. What human sounds could render the agony of Niobe, or the agony of Laocoon, as we see them in the sculptor's rendering? Not articulate speech at all; not words but wails. It is the same with hate; it is the same with love. We are not speaking merely of the unpacking of the heart in which the angry warriors of the *Iliad* indulge. Even such subtle writing as that of Aeschylus and Sophocles falls below the work of the painter. Hate, though voluble perhaps, as Clytemnestra's when hate is at that red-heat glow which the poet can render, changes in a moment whenever that redness has been fanned to hatred's own last complexion—whiteness as of iron at the melting-point—when the heart has grown far too big to be "unpacked" at all, and even the bitter epigrams of hate's own rhetoric, though brief as the terrier's snap before he fleshes his teeth, or as the short snarl of the tigress as she springs before her cubs in danger, are all too slow and sluggish for a soul to which language at its tensest has become idle play. But this is just what cannot be rendered by an art whose medium consists solely of words.

It is in giving voice, not to emotion at its tensest, but to the variations of emotion, it is in expressing the countless shifting movements of the soul from passion to passion, that poetry shows in spite of all her infirmities her superiority to the plastic arts. *Hamlet* and the *Agamemnon*, the *Iliad* and the *Oedipus Tyrannus*, are adequate to the entire breadth and depth of man's soul.

Varieties of Poetic Art.—We have now reached the inquiry: What varieties of poetic art are the outcome of the two kinds of poetic impulse, dramatic imagination and lyric or egoistic imagination? It would be impossible here to examine fully the subject of poetic imagination. In order to do so we should have to enter upon the vast question of the effect of artistic environment upon the development of man's poetic imagination; we should have to inquire how the instinctive methods of each poet and of each group of poets have been modified and often governed by the methods characteristic of their own time and country. We should have to inquire, for instance, how far such landscape as that of Sophocles in the *Oedipus Coloneus* and such landscape as that of Wordsworth depends upon difference of individual temperament, and how far upon difference of artistic environment. That, in any thorough and exhaustive discussion of poetic imagination, the question of artistic environment must be taken into account, the case of the *Iliad* is alone sufficient to show. Ages before Phrynichus, ages before an acted drama was dreamed of, a dramatic poet of the first order arose, and, though he was obliged to express his splendid dramatic imagination through epic forms, he expressed it almost as fully as if he had inherited the method and the stage of Sophocles. And if

Homer never lived at all, then an entire group of dramatic poets arose in remote times whose method was epic instead of dramatic simply because there was then no stage. This, contrasted with the fact that in a single half-century the tragic art of Greece arose with Aeschylus, culminated with Sophocles, and decayed with Euripides, and contrasted also with the fact that in England at one time, and in Spain at one time, almost the entire poetic imagination of the country found expression in the acted drama alone, is sufficient to show that a poet's artistic methods are very largely influenced by the artistic environments of his country and time. So vast a subject as this, however, is beyond our scope, and we can only point to the familiar instance of the troubadours and the trouvères and then pass on.

With the trouvère (the poet of the *langue d'oïl*), the story or situation is always the end of which the musical language is the means; with the troubadour (the poet of the *langue d'oc*), the form is so beloved, the musical language so enrapturing, that, however beautiful may be the story or situation, it is felt to be no more than the means to a more beloved and beautiful end. But then nature makes her own troubadours and her own trouvères irrespective of fashion and of time—irrespective of *langue d'oc* and *langue d'oïl*. And, in comparing the troubadours with the trouvères, this is what strikes us at once—there are certain troubadours who by temperament, by original endowment of nature, ought to have been trouvères, and there are certain trouvères who by temperament ought to have been troubadours. Surrounding conditions alone have made them what they are. There are those whose impulse (though writing in obedience to contemporary fashions lyrics in the *langue d'oc*) is manifestly to narrate, and there are those whose impulse (though writing in obedience to contemporary fashions *fabliaux* in the *langue d'oïl*) is simply to sing. In other words, there are those who, though writing after the fashion of their brother-troubadours, are more impressed with the romance and wonderfulness of the human life outside them than with the romance and wonderfulness of their own passions, and who delight in depicting the external world in any form that may be the popular form of their time; and there are those who, though writing after the fashion of their brother-trouvères, are far more occupied with the life within them than with that outer life which the taste of their time and country calls upon them to paint—born rhythmists who must sing, who translate everything external as well as internal into verbal melody. Of the former class Pierre Vidal, of the latter class the author of *Le Lay de l'oiselet*, may be taken as the respective types.

That the same forces are seen at work in all literatures few students of poetry will deny—though in some poetical groups these forces are no doubt more potent than in others, as, for instance, with the great parable poets of Persia, in some of whom there is perpetually apparent a conflict between the dominance of the Oriental taste for allegory and subtle suggestion, as expressed in the Zoroastrian definition of poetry—"apparent pictures of unapparent realities"—and the opposite yearning to represent human life with the freshness and natural freedom characteristic of Western poetry.

Allowing, however, for all the potency of external influences, we shall not be wrong in saying that of poetic imagination there are two distinct kinds—(1) the kind of poetic imagination seen at its highest in Aeschylus, Sophocles, Shakespeare and Homer, and; (2) the kind of poetic imagination seen at its highest in Pindar, Dante and Milton, or else in Sappho, Heine and Shelley. The former, being in its highest dramatic exercise unconditioned by the personal or lyrical impulse of the poet, might perhaps be called *absolute dramatic vision*; the latter, being more or less conditioned by the personal or lyrical impulse of the poet, might be called *relative dramatic vision*. It seems impossible to classify poets, or to classify the different varieties of poetry, without drawing some such distinction as this, whatever words of definition we may choose to adopt.

For the achievement of all pure lyric poetry, such as the ode, the song, the elegy, the idyll, the sonnet, the stornello, it is

Absolute and Relative Vision.

evident that the imaginative force we have called relative vision will suffice. And if we consider the matter thoroughly, in many other forms of poetic art—forms which at first sight might seem to require absolute vision—we shall find nothing but relative vision at work.

Even in Dante, and even in Milton and Virgil, it might be difficult to trace the working of any other than relative vision. And as to the entire body of Asiatic poets it might perhaps be found (even in view of the Indian drama) that relative vision suffices to do all their work. Indeed the temper which produces true drama is, it might almost be said, a growth of the Western mind. For, unless it be Semitic, as seen in the dramatic narratives of the Bible, or Chinese, as seen in that remarkable prose story, *The Two Fair Cousins*, translated by Rémusat, absolute vision seems to have but small place in the literatures of Asia. The wonderfulness of the world and the romantic possibilities of fate, or circumstance, or chance—not the wonderfulness of the character to whom these possibilities befall—are ever present to the mind of the Asiatic poet. Even in so late a writer as the poet of the *Sháh Námeih*, the hero Irij, the hero Zal and the hero Zohreh are in character the same person, the virtuous young man who combines the courage of youth with the wisdom and forbearance of age. And, as regards the earlier poets of Asia, it was not till the shadowy demigods and heroes of the Asiatic races crossed the Caucasus, and breathed a more bracing air, that they became really individual characters. But among the many qualities of man's mind that were invigorated and rejuvenated by that great exodus from the dreamy plains of Asia is to be counted, above all others, his poetic imagination. The mere sense of wonder, which had formerly been an all-sufficing source of pleasure to him, was all-sufficing no longer. The wonderful adventure must now be connected with a real and interesting individual character. It was left for the poets of Europe to show that, given the interesting character, given the Achilles, the Odysseus, the Helen, the Priam, any adventure happening to such a character becomes interesting.

What then is this absolute vision, this true dramatic imagination which can hardly be found in Asia—which even in Europe cannot be found except in rare cases? Between relative and absolute vision the difference seems to be this, that the former only enables the poet, even in its very highest exercise, to make his own individuality, or else humanity as represented by his own individuality, live in the imagined situation; the latter enables him in its highest exercise to make special individual characters other than the poet's own live in the imagined situation.

"That which exists in nature," says Hegel, "is a something, purely individual and particular. Art, on the contrary, is essentially destined to manifest the general." And no doubt this is true as regards the plastic arts, and true also as regards literary art, save in the very highest reaches of pure drama and pure lyric, when it seems to become art no longer—when it seems to become the very voice of Nature herself. The cry of Priam when he puts to his lips the hand that slew his son is not merely the cry of a bereaved and aged parent; it is the cry of the individual king of Troy, and expresses above everything else that most naïve, pathetic and winsome character. Put the words into the mouth of the irascible and passionate Lear and they would be entirely out of keeping.

It may be said then that, while the poet of relative vision, even in its very highest exercise, can only, when depicting the

*Lyric, Epic
and
Dramatic
Singers.*

external world, deal with the general, the poet of absolute vision can compete with Nature herself and deal with both general and particular. If this is really so we may perhaps find a basis for a classification of poetry and of poets. That all poets must be singers has already been maintained. But singers seem to be divisible into three classes: first the pure lyricists, each of whom can with his one voice sing only one tune; secondly the epic poets, save Homer, the bulk of the narrative poets, and the quasi-dramatists, each of whom can with his one voice sing several tunes; and thirdly the true dramatists, who, having, like the nightingale of Gongora, many tongues, can sing all tunes.

It is to the first-named of these classes that most poets belong. With regard to the second class, there are not of course many poets left for it: the first absorbs so many. But, when we come to consider that among those who, with each his one voice, can sing many tunes, are Pindar, Firdausi, Jami, Virgil, Dante, Milton, Spenser, Goethe, Byron, Coleridge, Shelley, Keats, Schiller, Victor Hugo, the second class is so various that no generalization save such a broad one as ours could embrace its members. And now we come to class three, and must pause. The third class is necessarily very small. In it can only be placed such names as Shakespeare, Aeschylus, Sophocles, Homer and (hardly) Chaucer.

These three kinds of poets represent three totally different kinds of poetic activity.

With regard to the first, the pure lyricists, the impulse is pure egoism. Many of them have less of even relative vision at its highest than the mass of mankind. They are often too much engaged with the emotions within to have any deep sympathy with the life around them. Of every poet of this class it may be said that his mind to him "a kingdom is," and that the smaller the poet the bigger to him is that kingdom. To make use of a homely image—like the chaffinch whose eyes have been pricked by the bird-fancier, the pure lyricist is sometimes a warbler because he is blind. Still he feels that the Muse loves him exceedingly. She takes away his eyesight, but she gives him sweet song. And his song is very sweet, very sad, and very beautiful; but it is all about the world within his own soul—its sorrows, joys, fears and aspirations.

With regard to the second class the impulse here is no doubt a kind of egoism too; yet the poets of this class are all of a different temper from the pure lyricists. They have a wide imagination; but it is still relative, still egoistic. They have splendid eyes, but eyes that never get beyond seeing general, universal humanity (typified by themselves) in the imagined situation. Not even to these is it given to break through that law of centrality by which every "me" feels itself to be the central "me"—the only "me" of the universe, round which all other spurious "me's" revolve. This "me" of theirs they can transmute into many shapes, but they cannot create other "me's"—nay, for egoism, some of them scarcely would, perhaps, if they could.

The third class, the true dramatists, whose impulse is the simple yearning to create akin to that which made "the great Vishnu yearn to create a world," are "of imagination all compact"—so much so that when at work "the divinity" which Iamblichus speaks of "seizes for the time the soul and guides it as he will."

The distinction between the pure lyricists and the other two classes of poets is obvious enough. But the distinction between the quasi-dramatists and the pure dramatists *Examples of Relative and Absolute Vision.* requires a word of explanation before we proceed to touch upon the various kinds of poetry that spring from the exercise of relative and absolute vision.

Sometimes, to be sure, the vision of the true dramatists—the greatest dramatists—will suddenly become narrowed and obscured, as in that part of the *Oedipus tyrannus* where Sophocles makes Oedipus ignorant of what every one in Thebes must have known, the murder of Laius. And again, finely as Sophocles has conceived the character of Electra, he makes her, in her dispute with Chrysothemis, give expression to sentiments that, in another play of his own, come far more appropriately from the lofty character of Antigone in a parallel dispute with Ismene. And, on the other hand, examples of relative vision in its furthest reaches can be found in abundance everywhere, especially in Virgil, Dante, Calderon and Milton. Some of the most remarkable examples of that high kind of relative vision which may easily be mistaken for absolute vision may be found in those great prose epics of the North which Aristotle would have called poems. Here is one from the *Völsunga Saga*. While the brothers of Gudrun are about their treacherous business of murdering Sigurd, her husband, as he lies asleep in her arms, Brynhild, Sigurd's former love, who in the frenzy of

"love turned to hate" has instigated the murderers to the deed, hovers outside the chamber with Gunnar, her husband, and listens to the wail of her rival who is wailing in Sigurd's blood. At the sound of that wail Brynhild laughs:—

"Then said Gunnar to her, Thou laughest not because thy heart roots are gladdened, or else why doth thy visage wax so wan?"¹

This is of course very fine; but, as any two characters in that dramatic situation might have done that dramatic business, fine as it is—as the sagaman gives us the general and not the particular—the vision at work is not absolute but relative at its very highest exercise. But our examples will be more interesting if taken from English poets. In Coleridge's "Ancient Mariner" we find an immense amount of relative vision of so high a kind that at first it seems absolute vision. When the ancient mariner, in his narrative to the wedding guest, reaches the slaying of the albatross, he stops, he can proceed no farther, and the wedding guest exclaims:—

"God save thee, Ancient Mariner,
From the fiends that plague thee thus!
Why look'st thou so?" "With my cross-bow
I shot the albatross."

But there are instances of relative vision—especially in the great master of absolute vision, Shakespeare—which are higher still—so high indeed that not to relegate them to absolute vision seems at first sight pedantic. Such an example is the famous speech of Lady Macbeth in the second act, where she says:—

"Had he not resembled
My father as he slept, I had done 't."

Marvellously subtle as is this speech, it will be found, if analysed, that it expresses the general human soul rather than any one special human soul. Indeed Leigh Hunt records the case of a bargeman who, charged with robbing a sleeping traveller in his barge, used in his confession almost identical words—"Had he not looked like my father as he slept, I should have killed as well as robbed him." Again, the thousand and one cases (to be found in every literature) where a character, overwhelmed by some sudden surprise or terror, asks whether the action going on is that of a dream or of real life, must all, on severe analysis, be classed under relative rather than under absolute vision—even such a fine speech, for instance, as that where Pericles, on discovering Marina, exclaims:—

"This is the rarest dream that e'er dull sleep
Did mock sad souls withal";

or as that in the third act of *Titus Andronicus*, where Titus, beholding his mutilated and ruined daughter, asks:—

"When will this fearful slumber have an end?"

even here, we say, the humanity rendered is general and not particular, the vision at work is relative and not absolute. The poet, as representing the whole human race, throwing himself into the imagined situation, gives us what general humanity would have thought, felt, said or done in that situation, not what one particular individual and he alone would have thought, felt, said or done.

Now what we have called absolute vision operates in a very different way. So vividly is the poet's mere creative instinct at work that the ego sinks into passivity—becomes insensitive to all impressions other than those dictated by the vision—by the "divinity" which has "seized the soul." Shakespeare is full of examples. Take the scene in the first act of *Hamlet* where Hamlet hears for the first time, from Horatio, that his father's ghost haunts the castle. Having by short sharp questions elicited the salient facts attending the apparition, Hamlet says, "I would I had been there." To this Horatio makes the very commonplace reply, "It would have much amazed you." Note the marvellously dramatic reply of Hamlet

"Very like, very like! Stayed it long?" Suppose that this dialogue had been attempted by any other poet than a true dramatist; or by a true dramatist in any other mood than his very highest, Hamlet, on hearing Horatio's commonplace remarks upon phenomena which to Hamlet were more subversive

¹ Translation of Morris and Magnusson.

of the very order of the universe than if a dozen stars had fallen from their courses, would have burst out with: "Amazed me!" and then would have followed an eloquent declamation about the "amazing" nature of the phenomena and their effect upon him. But so entirely has the poet become Hamlet, so completely has "the divinity seized his soul," that all language seems equally weak for expressing the turbulence within the soul of the character, and Hamlet exclaims in a sort of meditative irony, "Very like, very like!" It is exactly this one man Hamlet, and no other man, who in this situation would have so expressed himself. Charles Knight has some pertinent remarks upon this speech of Hamlet; yet he misses its true value, and treats it from the general rather than from the particular side. Instances of absolute vision in Shakespeare crowd upon us; but we can find room for only one other. In the pathetic speech of Othello, just before he kills himself, he declares himself to be:—

"One not easily jealous, but, being wrought,
Perplexed in the extreme."

Consider the marvellous *timbre* of the word "wrought," as coming from a character like Othello. When writing this passage, especially when writing this word, the poet had become entirely the simple English soldier-hero, as the Moor really is—he had become Othello, looking upon himself "as not easily jealous," whereas he was "wrought" and "perplexed in the extreme" by tricks which Hamlet would have seen through in a moment.

While all other forms of poetic art can be vitalized by relative vision, there are two forms (and these the greatest) in which absolute vision is demanded, viz. the drama, and in *Dramatic Imagination*. This will be seen more plainly perhaps if we now vary our definitions and call relative vision *egoistic imagination*; absolute vision *dramatic imagination*.

Very much of the dramatist's work can be, and in fact is, effected by egoistic imagination, while true dramatic imagination is only called into play on comparatively rare occasions. Not only fine but sublime dramatic poems have been written, however, where the vitalizing power has been entirely that of lyrical imagination. We need only instance the *Prometheus Bound* of Aeschylus, the most sublime poem in the world. The dramas of Shelley too, like those of Victor Hugo and Calderon, are informed entirely by egoistic imagination. In all these splendid poems the dramatist places himself in the imagined situation, or at most he places there some typical conception of universal humanity. There is not in all Calderon any such display of dramatic imagination as we get in that wonderful speech of Priam's in the last book of the *Iliad*, to which we have before alluded. There is not in the *Cenci* such a display of dramatic imagination as we get in the sudden burst of anger from the spoilt child of gods and men, Achilles (anger which alarms the hero himself as much as it alarms Priam), when the prattle of the old man has carried him too far. It may seem bold to say that the drama of Goethe is informed by egoistic imagination only—assuredly the prison-scene in *Faust* is unsurpassed in the literatures of the world. Yet, perhaps, it could be shown of the passion and the pathos of Gretchen throughout the entire play that it betrays a female character general and typical rather than individual and particular.

The nature of this absolute vision or true dramatic imagination is easily seen if we compare the dramatic work of writers without absolute vision, such as Calderon, Goethe, Ben Jonson, Fletcher and others, with the dramatic work of Aeschylus and of Shakespeare. While of the former group it may be said that each poet skilfully works his imagination, of Aeschylus and Shakespeare it must be said that each in his highest dramatic mood does not work, but is worked by his imagination. Note, for instance, how the character of Clytemnestra grows and glows under the hand of Aeschylus. The poet of the *Odyssey* had distinctly said that Aegisthus, her paramour, had struck the blow, but the dramatist, having imagined the greatest tragic female in all poetry, finds it impossible to let a man like Aegisthus assist such a woman in a homicide so daring and so momentous. And

when in that terrible speech of hers she justifies her crime (ostensibly to the outer world, but really to her own conscience), the way in which, by the sheer magnetism of irresistible personality, she draws our sympathy to herself and her crime is unrivalled out of Shakespeare and not surpassed even there. In the Great Drama, in the *Agamemnon*, in *Othello*, in *Hamlet*, in *Macbeth*, there is an imagination at work whose laws are inexorable, are inevitable, as the laws by the operation of which the planets move around the sun. But in this essay our business with drama is confined entirely to its relations to epic.

Considering how large and on the whole how good is the body of modern criticism upon drama, it is surprising how poor is the modern criticism upon epic. Aristotle, comparing tragedy with epic, gives the palm to tragedy as being the more perfect art, and nothing can be more ingenious than the way in which he has marshalled his reasons. He tells us that tragedy as well as epic is capable of producing its effect even without action; we can judge of it perfectly, says he, by reading. He goes so far as to say that, even in reading as well as in representation, tragedy has an advantage over the epic, the advantage of greater clearness and distinctness of impression. And in some measure this was perhaps true of Greek tragedy, for as Müller in his *Dissertations on the Eumenides* has well said, the ancients always remained and wished to remain conscious that the whole was a Dionysian entertainment; the quest of a commonplace *δράμη* came afterwards. And even of Romantic Drama it may be said that in the time of Shakespeare, and indeed down through the 18th century, it never lost entirely its character of a recitation as well as a drama. It was not till melodrama began to be recognized as a legitimate form of dramatic art that the dialogue had to be struck from the dramatic action "at full speed"—struck like sparks from the roadster's shoes. The truth is, however, that it was idle for Aristotle to inquire which is the more important branch of poetry, epic or tragedy. Equally idle would it be for the modern critic to inquire how much romantic drama gained and how much it lost by abandoning the chorus.

Much has been said as to the scope and the limits of epic and dramatic poetry. If in epic the poet has the power to take the imagination of his audience away from the dramatic centre and show what is going on at the other end of the great web of the world, he can do the same thing in drama by the chorus, and also by the introduction into the dramatic circle of messengers and others from the outside world. But, as regards epic poetry, is it right that we should hear, as we sometimes do hear, the voice of the poet himself as chorus bidding us contrast the present picture with other pictures afar off, in order to enforce its teaching and illustrate its pathos? This is a favourite method with modern poets and a still more favourite one with prose narrators. Does it not give an air of self-consciousness to poetry? Does it not disturb the intensity of the poetic vision? Yet it has the sanction of Homer; and who shall dare to challenge the methods of the great father of epic? An instance occurs in *Iliad* v. 158, where, in the midst of all the stress of fight, the poet leaves the dramatic action to tell us what became of the inheritance of Phenops, after his two sons had been slain by Diomedes. Another instance occurs in iii. 243-244, where the poet, after Helen's pathetic mention of her brothers, comments on the causes of their absence, "criticizes life" in the approved modern way, generalizes upon the impotence of human intelligence—the impotence even of human love—to pierce the darkness in which the web of human fate is woven. Thus she spoke (the poet tells us); but the life-giving earth already possessed them, there in Lacedaemon, in their dear native land:—

ὅς φάτο· τοὺς δ' ἔβη κέρως φωνήσας αἰεὶ
 ἐν Λακεδαίμονι αἰθρῇ, φθῆν' ἐν πατρίδι γαίῃ.

This, of course, is "beautiful exceedingly," but, inasmuch as the imagination at work is egoistic or lyrical, not dramatic; inasmuch as the vision is relative, not absolute, it does not represent that epic strength at its very highest which we call specially "Homeric," unless indeed we remember that with Homer the

Muses are omniscient: this certainly may give the passage a deep dramatic value it otherwise seems to lack.

The deepest of all the distinctions between dramatic and epic methods has relation, however, to the nature of the dialogue. Aristotle failed to point it out, and this is remarkable until we remember that his work is but a fragment of a great system of criticism. In epic poetry, and in all poetry that narrates, whether the poet be Homer, Chaucer, Thomas the Rhymmer, Gottfried von Strassburg, or Turoldus, the action, of course, moved by aid partly of narrative and partly by aid of dialogue, but in drama the dialogue has a quality of suggestiveness and subtle inference which we do not expect to find in any other poetic form save perhaps that of the purely dramatic ballad. In ancient drama this quality of suggestiveness and subtle inference is seen not only in the dialogue, but in the choral odes. The third ode of the *Agamemnon* is an extreme case in point, where, by a kind of *double entendre*, the relations of Clytaemnestra and Aegisthus are darkly alluded to under cover of allusions to Paris and Helen. Of this dramatic subtlety Sophocles is perhaps the greatest master; and certain critics have been led to speak as though irony were heart-thought of Sophoclean drama. But the suggestiveness of Sophocles is pathetic (as Professor Lewis Campbell has well pointed out), not ironical. This is one reason why drama more than epic seems to satisfy the mere intellect of the reader, though this may be counterbalanced by the hardness of mechanical structure which sometimes disturbs the reader's imagination in tragedy.

When, for instance, a dramatist pays so much attention to the evolution of the plot as Sophocles does, it is inevitable that his characters should be more or less plot-ridden; they have to say and do now and then certain things which they would not say and do but for the exigencies of the plot. Indeed one of the advantages which epic certainly has over drama is that the story can be made to move as rapidly as the poet may desire without these mechanical modifications of character.

The only kind of epic for Aristotle to consider was Greek epic, between which and all other epic the difference is one of kind, if the *Iliad* alone is taken to represent Greek epic. The Greek epic seem to have upon the form in which the poetic energy of any time or country should express itself, we instanced the *Iliad* as a typical case. The imagination vivifying it is mainly dramatic. The characters represent much more than the mere variety of mood of the delineator. Notwithstanding all the splendid works of Calderon, Marlowe, Webster and Goethe, it is doubtful whether as a born dramatist the poet of the *Iliad* does not come nearer to Aeschylus and Shakespeare than does any other poet. His passion for making the heroes speak for themselves is almost a fault in the *Iliad* considered as pure epic, and the unconscious way in which each actor is made to depict his own character is the highest spirit of drama. It is owing to this speciality of the *Iliad* that it stands apart from all other epic save that of the *Odyssey*, where, however, the dramatic vision is less vivid. It is owing to the dramatic imagination displayed in the *Iliad* that it is impossible to say, from internal evidence, whether the poem is to be classified with the epics of growth or with the epics of art. All epics are clearly divisible into two classes, first those which are a mere accretion of poems or traditional ballads, and second, those which, though based indeed on tradition or history, have become so fused in the mind of one great poet, so stained, therefore, with the colour and temper of that mind, as to become new crystallizations—inventions, in short, as we understand that word. Each kind of epic has excellencies peculiar to itself, accompanied by peculiar and indeed necessary defects. In the one we get the freedom—apparently schemeless and motiveless—of nature, but, as a consequence, miss that "hard acorn of thought" (to use the picturesque definition in the *Völsunga Saga* of the heart of a man) which the mind asks for as the core of every work of art. In the other this great requisite of an adequate central thought is found, but accompanied by a constriction, a lack of freedom, a cold artificiality, the obtrusion of a pedantic scheme, which would be intolerable to the natural mind unsophisticated by literary study. The flow of the one is as that of a river, the flow of the other as that of a canal. Yet, as has been already hinted, though the great charm of Nature herself is that she never teases us with any obtrusive exhibitions of scheme, she doubtless has a scheme somewhere, she does somewhere hide a "hard acorn of thought" of which the poem of the universe is the expanded expression. And, this being so, art should have a scheme too; but in such a dilemma is she placed in this matter that the epic poet, unless he is evidently telling the

story for its own sake, scornful of purposes ethie or aesthetic, must sacrifice illusion.

Among the former class of epics are to be placed the great epics of growth, such as the *Mahabharata*, the Nibelung story, &c.; among the latter the *Odyssey*, the *Aeneid*, *Paradise Lost*, the *Jerusalemme liberata*, the *Lusiadas*.

But where in this classification are we to find a place for the *Iliad*? The heart-thought of the greatest epic in all literature is simply that Achilles was vexed and that the fortunes of the world depended upon the whim of a sulky hero. Yet, notwithstanding all the acute criticisms of Wolff, it remains difficult for us to find a place for the *Iliad* among the epics of growth. And why? Because throughout the *Iliad* the dramatic imagination shown is of the first order; and, if we are to suppose a multiplicity of authors for the poem, we must also suppose that ages before the time of Pericles there existed a group of dramatists more nearly akin to the masters of the Great Drama, Aeschylus, Sophocles and Shakespeare, than any group that has ever existed since. Yet it is equally difficult to find a place for it amongst the epics of art. In the matter of artistic motive the *Odyssey* stands alone among the epics of art of the world, as we are going to see.

It is manifest that, as the pleasure derived from the epic of art is that of recognizing a conscious scheme, if the epic of art fails through confusion of scheme it fails altogether. What is demanded of the epic of art (as some kind of compensation for that natural freedom of evolution which it can never achieve, that sweet *abandon*, which belongs to nature and to the epic of growth alike) is unity of impression, harmonious and symmetrical development of a conscious heart-thought or motive. This being so, where are we to place the *Aeneid*, and where are we to place the *Shah Námeh*? Starting with the intention, and as it seems, of fusing into one harmonious whole the myths and legends upon which the Roman story is based, Virgil, by the time he reaches the middle of his epic, forgets all about this primary intent, and gives us his own thoughts and reflections on things in general. Fine as is the speech of Anchises to Aeneas in Elysium (*Aen.* vi. 724-735), its incongruity with the general scheme of the poem as developed in the previous books shows how entirely Virgil lacked that artistic power shown in the *Odyssey* of making a story become the natural and inevitable outcome of an artistic idea.

In the *Shah Námeh* there is the artistic redaction of Virgil, but with even less attention to a central thought than Virgil exhibits. Firdausi relies for his effects upon the very qualities which characterize not the epic of art but the epic of growth—a natural and not an artificial flow of the story; so much indeed that, if the *Shah Námeh* were studied in connexion with the *Iliad* on the one hand and with the *Kalevala* on the other, it might throw a light upon the way in which an epic may be at one and the same time an aggregation of the national ballad poems and the work of a single artificer. That Firdausi was capable of working from a centre not only artistic but philosophic his *Yásuf and Zuleikha* shows; and if we consider what was the artistic temper of the Persians in Firdausi's time, what indeed has been that temper during the whole of the Mahomedan period, the subtle temper of the parable poet—the *Shah Námeh*, with its direct appeal to popular sympathies, is a standing wonder in poetic literature.

With regard, however, to Virgil's defective power of working from an artistic motive, as compared with the poet of the *Odyssey*, this is an infirmity he shares with all the poets of the Western world. Certainly he shares it with the writer of *Paradise Lost*, who, setting out to "justify the ways of God to man," forgets occasionally the original worker of the evil, as where, for instance, he substitutes chance as soon as he comes (at the end of the second book) to the point upon which the entire epic movement turns, the escape of Satan from hell and his journey to earth for the ruin of man:—

"At last his sail-broad vans
He spreads for flight, and, in the surging smoke
Uplifted, spurs the ground; thence many a league,
As in a cloudy char, ascending rides
Audacious; but, that seat soon failing, meets
A vast vacuity; all unawares,
Fluttering his pinions vain, plumb down he drops
Ten thousand fathoms deep, and to this hour
Down had been falling, had not, by THE CHANCE,
The strong rebuff of some tumultuous cloud,
Instinct with fire and nitre, hurried him
As many miles aloft."

In Milton's case, however, the truth is that he made the mistake of trying to disturb the motive of the story for artistic purposes—a fatal mistake, as we shall see when we come to speak of the *Nibelungenlied* in relation to the old Norse epic cycle.

Though Vondel's mystery play of *Lucifer* is, in its execution, rhetorical more than poetical, it did, beyond all question, influence Milton when he came to write *Paradise Lost*. The famous line which is generally quoted as the keynote of Satan's character—

"Better to reign in hell than serve in heaven"—

seems to have been taken bodily from Vondel's play, and Milton's entire epic shows a study of it. While Marlowe's majestic move-

ments alone are traceable in Satan's speech (written some years before the rest of *Paradise Lost*, when the dramatic and not the epic form had been selected), Milton's Satan became afterwards a splendid amalgam not of the Mephistopheles but of the *Faust* of Marlowe and the *Lucifer* of Vondel. Vondel's play must have possessed a peculiar attraction for a poet of Milton's views of human progress. Defective as the play is in execution, it is far otherwise in motive. This motive, if we consider it aright, is nothing less than an explanation of man's anomalous condition on the earth—spirit incarnate in matter created by God, a little lower than the angels—in order that he may advance by means of these very manacles which imprison him, in order that he may ascend by the staircase of the world, the ladder of fleshly conditions, above those cherubim and seraphim who, lacking the education of sense, have not the knowledge wide and deep which brings man close to God.

Here Milton found his own favourite doctrine of human development and self-education in a concrete and vividly artistic form. Much, however, as such a motive must have struck a man of Milton's instincts, his intellect was too much chained by Calvinism to permit of his treating the subject with Vondel's philosophic breadth. The cause of Lucifer's wrath had to be changed from jealousy of human progress to jealousy of the Son's proclaimed superiority. And the history of poetry shows that once begin to tamper with the central thought around which any-group of incidents has crystallized and the entire story becomes thereby rewritten, as we have seen in the case of the *Agamemnon* of Aeschylus. Of the motive of his own epic, after he had abandoned the motive of Vondel, Milton had as little permanent grasp as Virgil had of his. As regards the *Odyssey*, however, we need scarcely say that its motive is merely artistic, not philosophic. And now we come to philosophic motive.

The artist's power of thought is properly shown not in the direct enunciation of ideas but in mastery over motive. Here Aeschylus is by far the greatest figure in Western poetry—a proof perhaps among many proofs of the Oriental strain of his genius. (As regards pure drama, however, important as is motive, freedom, organic vitality in every part, is of more importance than even motive; and in this freedom and easy abandonment the concluding part of the *Orestes* is deficient as compared with such a play as *Othello* or *Lear*.) Notwithstanding the splendid exception of Aeschylus, the truth seems to be that the faculty of developing a poetical narrative from a philosophic thought is Oriental, and on the whole foreign to the genius of the Western mind. Neither in Western drama nor in Western epic do we find, save in such rare cases as that of Vondel, anything like that power of developing a story from an idea which not only Jami but all the parable poets of Persia show.

In modern English poetry the motive of Shelley's dramatic poem *Prometheus Unbound* is a notable illustration of what is here contended. Starting with the full intent of developing a drama from a motive—starting with a universalism, a belief that good shall be the final goal of ill—Shelley cannot finish his first three hundred lines without shifting (in the course of Prometheus) into a Manichaeism as pure as that of Manes himself:—

"Heap on thy soul, by virtue of this curse,
Ill deeds, then be thou damned, beholding good;
Both infinite as is the universe."

According to the central thought of the poem human nature, through the heroic protest and struggle of the human mind typified by Prometheus, can at last destroy that supernatural terror and tyranny (Jupiter) which the human mind had itself installed. But, after its dethronement (when human nature becomes infinitely perfectible), how can the supernatural tyranny exist apart from the human mind that imagined it? How can it be as "infinite as the universe"?

The motive of *Paradise Lost* is assailed with much vigour by Victor Hugo in his poem *Religions et Religion*. But when Hugo, in the after parts of the poem, having destroyed Milton's "God," sets up an entirely French "Dieu" of his own and tries "to justify" him, we perceive how ponderable was Milton's failure after all. Compare such defect of mental grip and such nebulousity of thought as is displayed by Milton, Shelley and Hugo with the strength of hand shown in the "Sälmanin" and "Absal" of Jami, and indeed by the Sufi poets generally.

There is, however, one exception to this rule that Western poetry is nebulous as to motive. There is, besides the *Iliad*, one epic that refuses to be classified, though for entirely different reasons. This is the Nibelung story, where we find unity of purpose and also entire freedom of movement. We find combined here beauties which are nowhere else combined—which are, in fact, at war with each other everywhere else. We find a scheme, a real "acorn of thought," in an epic which is not the self-conscious work of a single poetic artificer, but is as much the slow growth of various times and various minds as in the *Mahabharata*, in which the heart-thought is merely that the Kauravas defeated their relatives at dice and refused to disgorge their winnings.

This Northern epic-tree, as we find it in the Icelandic sagas, the Norms themselves must have watered; for it combines the virtues

of the epic of growth with those of the epic of art. Though not written in metre, it may usefully be compared with the epics of Greece and of India and Persia. Free in movement as the wind, which "bloweth where it listeth," it listeth to move by law. Its action is that of free will, but free will at play within a ring of necessity. Within this ring there throbs all the warm and passionate life of the world outside, and all the freedom apparently. Yet from that world it is enshled by a cordon of curses—by a zone of defiant flames more impregnable than that which girdled the beautiful Brynhild at Hindfell. Natural laws, familiar emotions, are at work everywhere in the story; yet the "Ring of Andvari," whose circumference is but that of a woman's finger, encircles the whole mimic world of the sagaman as the Midgard snake encircles the earth. For this artistic perfection in an epic of growth there are, of course, many causes, some of them traceable and some of them beyond all discovery—causes no doubt akin to those which gave birth to many of the beauties of other epics of growth. Originally Sinfliot and Sigurd were the same person, and note how vast has been the artistic effect of the separation of the two! Again, there were several different versions of the story of Brynhild. The sagamen, finding all these versions too interesting and too much beloved to be discarded, adopted them all—worked them up into one legend, so that, in the *Völsunga Saga* we have a heroine possessing all the charms of goddess, demi-goddess, earthly princess and amazon—a heroine surpassing perhaps in fascination all other heroines that have ever figured in poetry.

It is when we come to consider such imaginative work as this that we are compelled to pause before challenging the Aristotelian doctrine that metrical structure is but an accidental quality of epic.

In speaking of the Nibelung story we do not, of course, speak of the German version, the *Nibelungenlied*, a fine epic still, though a degradation of the elder form. Between the two the differences are fundamental in the artistic sense, and form an excellent illustration of what has just been said upon the disturbance of motive in epic, and indeed in all poetic art. It is not merely that the endings of the three principal characters, Sigurd (Siegfried), Gudrun (Kriemhild), and Brynhild are entirely different; it is not merely that the Icelandic version, by missing the blood-bath at Fafnir's lair, loses the pathetic situation of Gudrun's becoming afterwards an unwilling instrument of her husband's death; it is not merely that, on the other hand, the German version, by omitting the early love passages between Brynhild and Sigurd at Hindfell, misses entirely the tragic meaning of her story and the terrible hate that is love resulting from the breaking of the troth; but the conclusion of each version is so exactly the opposite of that of the other that, while the German story is called (and very properly) "Kriemhild's Revenge," the story of the *Völsunga Saga* might, with equal propriety, be called Gudrun's Forgiveness.

If it be said that, in both cases, the motive shows the same Titanic temper, that is because the Titanic temper is the special characteristic of the North-Western mind. The temper of revolt against authority seems indeed to belong to that energy which succeeds in the modern development of the great racial struggle for life. Although no epic, Eastern or Western, can exist without a struggle between good and evil—and a struggle upon apparently equal terms—it must not be supposed that the warring of conflicting forces which is the motive of Eastern epic has much real relation to the warring of conflicting forces which is the motive of Western epic.

And, as regards the machinery of epic, there is, we suspect, a deeper significance than is commonly apprehended in the fact that the Satan or Shaitan of the Eastern world becomes in *Vondel* and *Milton* a sublime Titan who attracts to himself the admiration which in Eastern poetry belongs entirely to the authority of heaven. In Asia, save perhaps among the pure Arabs of the desert, underlying all religious forms, there is apparent a temper of resignation to the irresistible authority of heaven. And as regards the Aryans it is probable that the Titanic temper—the temper of revolt against authority—did not begin to show itself till they had moved across the Caucasus. But what concerns us here is the fact that the farther they moved to the north-west the more vigorously this temper asserted itself, the prouder grew man in his attitude towards the gods, till at last in the Scandinavian cycle he became their equal and struggled alongside them, shoulder to shoulder, in the defence of heaven against the assaults of hell. Therefore, as we say, the student of epic poetry must not suppose that there is any real parallel between the attitude of Vishnu (as Rama) towards Ravana and the attitude of Prometheus towards Zeus, or the attitude of the human heroes towards Odin in Scandinavian poetry. Had Ravana been clothed with a properly constituted authority, had he been a legitimate god instead of a demon, the Eastern doctrine of recognition of authority would most likely have come in and the world would have been spared one at least of its enormous epics. Indeed, the Ravana of the *Ramayana* answers somewhat to the Fafnir of the *Völsunga Saga*; and to plot against demons is not to rebel against authority. The vast field of Indian epic, however, is quite beyond us here.

Nor can we do more than glance at the *Kalevala*. From one point of view that group of ballads might be taken, no doubt, as a simple record of how the men of Kalevala were skilful in capturing the

sisters of the Pöjola-men. But from another point of view the universal struggle of the male for the female seems typified in this so-called epic of the Finns by the picture of the "Lady of the Rainbow" sitting upon her glowing arc and weaving her golden threads, while the hero is doing battle with the malevolent forces of nature.

But it is in the Nibelung story that the temper of Western epic is at its best—the temper of the simple fighter, whose business it is to fight. The ideal Western fighter was not known in Greece till ages after Homer, when in the pass of Thermopylae the companions of Leonidas combed their long hair in the sun. The business of the fighter in Scandinavian epic is to yield to no power whatsoever, whether of earth or heaven or hell—to take a buffet from the Allfather himself, and to return it; to look Destiny herself in the face, crying out for quarter neither to gods nor demons nor Norns. This is the true temper of pure "heroic poetry" as it has hitherto flourished on this side the Caucasus—the temper of the fighter who is invincible because he feels that Fate herself falters when the hero of the true strain defies—the fighter who feels that the very Norns themselves must cringe at last before the simple courage of man standing naked and bare of hope against all assaults, whether of heaven or hell or doom. The proud heroes of the *Völsunga Saga* utter no moans and shed no Homeric tears, knowing as they know that the day prophesied is sure when, shoulder to shoulder, gods and men shall stand up to fight the entire brood of night and evil, storming the very gates of Asgard.

That this temper is not the highest from the ethical point of view is no doubt true. Against the beautiful resignation of Buddhism it may seem barbaric, and if moral suasion could supplant physical force in epic—if Siddhartha could take the place of Achilles or Sigurd—it might be better for the human race.

But we must now give undivided attention to pure egoistic or lyric imagination. This, as has been said, is sufficient to vitalize all forms of poetic art save drama and the *The Lyric Greek epic*. It would be impossible to discuss *Imaginative* adequately here the Hebrew poets, who have produced a lyric so different in kind from all other lyrics as to stand in a class by itself. As it is equal in importance to the Great Drama of Shakespeare, Aeschylus and Sophocles, we may perhaps be allowed to call it the "Great Lyric."

The Great Lyric must be religious—it must, it would seem, be an outpouring of the soul, not towards man but towards God, like that of the God-intoxicated prophets and psalmists of Scripture. Even the lyric fire of Pindar owes much to the fact that he had a childlike belief in the myths to which so many of his contemporaries had begun to give a languid assent. But there is nothing in Pindar, or indeed elsewhere in Greek poetry, like the rapturous song, combining unconscious power with unconscious grace, which we have called the Great Lyric. It might perhaps be said indeed that the Great Lyric is purely Hebrew. But, although we could hardly expect to find it among those whose language, complex of syntax and alive with self-conscious inflexions, bespeaks the scientific knowings of the Western mind, to call the temper of the Great Lyric broadly "Asiatic" would be rash. It seems to belong as a birthright to those descendants of Shem who, yearning always to look straight into the face of God and live, could (when the Great Lyric was sung) see not much else.

Though two of the artistic elements of the Great Lyric, unconsciousness and power, are no doubt plentiful enough in India, the element of grace is lacking for the most part. The Vedic hymns are both nebulous and unemotional, as compared with Semitic hymns. And as to the Persians, they, it would seem, have the grace always, the power often, but the unconsciousness almost never. This is inevitable if we consider for a moment the chief characteristic of the Persian imagination—an imagination whose wings are not so much "bright with beauty" as heavy with it—heavy as the wings of a golden pheasant—steeped in beauty like the "tiger-moth's deep damasked wings." Now beauty of this kind does not go to the making of the Great Lyric.

Then there comes that poetry which, being ethnologically Semitic, might be supposed to exhibit something at least of the Hebrew temper—the Arabian. But, whatever may be said of the oldest Arabic poetry, with its deep sense of fate and pain, it would seem that nothing can be more unlike than the Hebrew temper and the Arabian temper as seen in later poets. It is not with Hebrew but with Persian poetry that Arabian poetry can

be usefully compared. If the wings of the Persian imagination are heavy with beauty, those of the later Arabian imagination are bright with beauty—brilliant as an Eastern butterfly, quick and agile as a dragon-fly or a humming-bird. To the eye of the Persian poet the hues of earth are (as Firdausi says of the garden of Afrasiab) "like the tapestry of the kings of Ormuz, the air is perfumed with musk, and the waters of the brooks are the essence of roses." And to the later Arabian no less than to the Persian the earth is beautiful; but it is the clear and sparkling beauty of the earth as she "wakes up to life, greeting the Sabaeen morning"; we feel the light more than the colour. But it is neither the Persian's instinct for beauty nor the Arabian's quenchless wit and exhaustless animal spirits that go to the making of the Great Lyric; far from it. In a word, the Great Lyric, as we have said, cannot be assigned to the Asiatic temper generally any more than it can be assigned to the European temper.

In the poetry of Europe, if we cannot say of Pindar, devout as he is, that he produced the Great Lyric, what can we say of any other European poet? The truth is that, like the Great Drama, so straight and so warm does it seem to come from the heart of man in its highest moods that we scarcely feel it to be literature at all. Passing, however, from this supreme expression of lyrical imagination, we come to the artistic ode, upon which subject the present writer can only reiterate here what he has more fully said upon a former occasion. Whatever may have been said to the contrary, enthusiasm is, in the nature of things, the very basis of the ode; for the ode is a mono-drama, the actor in which is the poet himself; and, as Marmontel has well pointed out, if the actor in the mono-drama is not affected by the sentiments he expresses, the ode must be cold and lifeless. But, although the ode is a natural poetic method of the poet considered as prophet—although it is the voice of poetry as a fine frenzy—it must not be supposed that there is anything lawless in its structure. "Pindar," says the Italian critic Gravina, "launches his verses upon the bosom of the sea; he spreads out all his sails; he confronts the tempest and the rocks; the waves arise and are ready to engulf him; already he has disappeared from the spectator's view; when suddenly he springs up in the midst of the waters, and reaches happily the shore." Now it is this Pindaric discursiveness, this Pindaric unrestraint as to the matter, which has led poets to attempt to imitate him by adopting an unrestraint as to form. Although no two odes of Pindar exhibit the same metrical structure (the Aeolian and Lydian rhythms being mingled with the Doric in different proportions), yet each ode is in itself obedient, severely obedient, to structural law. This we feel; but what the law is no metricist has perhaps ever yet been able to explain.

It was a strange misconception that led people for centuries to use the word "Pindaric" and irregular as synonymous terms; whereas the very essence of the odes of Pindar (of the few, alas! which survive to us) is their regularity. There is no more difficult form of poetry than this, and for this reason: when in any poetical composition the metres are varied, there must, as the present writer has before pointed out, be a reason for such freedom, and that reason is properly subjective—the varying form must embody and express the varying emotions of the singer. But when these metrical variations are governed by no subjective law at all, but by arbitrary rules supposed to be evolved from the practice of Pindar, then that very variety which should aid the poet in expressing his emotion crystallizes it and makes the ode the most frigid of all compositions. Great as Pindar undoubtedly is, it is deeply to be regretted that no other poet survives to represent the triumphal ode of Greece—the digressions of his subject matter are so wide, and his volubility is so great.

In modern literature the ode has been ruined by theories and experiments. A poet like La Motte, for instance, writes execrable odes, and then writes a treatise to prove that all odes should be written on the same model. There is much confusion of mind prevalent among poets as to what is and what is not

an ode. All odes are, no doubt, divisible into two great classes: those which, following an arrangement in stanzas, are commonly called regular, and those which, following no such arrangement, are commonly called irregular.

We do not agree with those who assert that irregular metres are of necessity inimical to poetic art. On the contrary, we believe that in modern prosody the arrangement of the rhymes and the length of the lines in any rhymed metrical passage may be determined either by a fixed stanzaic law or by a law infinitely deeper—the law which impels the soul, in a state of poetic exaltation, to seize hold of every kind of metrical aid, such as rhyme, caesura, &c. for the purpose of accentuating and marking off each shade of emotion as it arises, regardless of any demands of stanza. But between the irregularity of makeshift, such as we find it in Cowley and his imitators, and the irregularity of the "fine frenzy" of such a poem, for instance, as Coleridge's *Kubla Khan*, there is a difference in kind. Strange that it is not in an ode at all but in this unique lyric *Kubla Khan*, descriptive of imaginative landscape, that an English poet has at last conquered the crowning difficulty of writing in irregular metres. Having broken away from all restraints of couplet and stanza—having caused his rhymes and pauses to fall just where and just when the emotion demands that they should fall, scorning the exigencies of makeshift no less than the exigencies of stanza—he has found what every writer of irregular English odes has sought in vain, a music as entrancing, as natural, and at the same time as inscrutable, as the music of the winds or of the sea.

The prearranged effects of sharp contrasts and antiphonal movements, such as some poets have been able to compass, do not of course come under the present definition of irregular metres at all. If a metrical passage does not gain immensely by being written independently of stanzaic law, it loses immensely; and for this reason, perhaps, that the great charm of the music of all verse, as distinguished from the music of prose, is inevitableness of cadence. In regular metres we enjoy the pleasure of feeling that the rhymes will inevitably fall under a recognized law of couplet or stanza. But if the passage flows independently of these, it must still flow inevitably—it must, in short, show that it is governed by another and a yet deeper force, the inevitableness of emotional expression. The lines must be long or short, the rhymes must be arranged after this or after that interval, not because it is convenient so to arrange them, but because the emotion of the poet inexorably demands these and no other arrangements. When, however, Coleridge came to try his hand at irregular odes, such as the odes "To the Departing Year" and "To the Duchess of Devonshire," he certainly did not succeed.

As to Wordsworth's magnificent "Ode on Intimations of Immortality," the sole impeachment of it, but it is a grave one, is that the length of the lines and the arrangement of the rhymes are not always inevitable; they are, except on rare occasions, governed neither by stanzaic nor by emotional law. For instance, what emotional necessity was there for the following rhyme-arrangement?

"My heart is at your festival,
My head hath its coronal,
The fulness of your bliss I feel—I feel it all.
Oh, evil day! if I were slain
While earth herself is adorning,
This sweet May morning,
And the children are culling,
On every side,
In a thousand valleys far and wide,
Fresh flowers."

Beautiful as is the substance of this entire passage, so far from gaining, it loses by rhyme—loses, not in perspicuity, for Wordsworth like all his contemporaries (except Shelley) is mostly perspicuous, but in that metrical emphasis the quest of which is one of the impulses that leads a poet to write in rhyme. In spite, however, of its metrical defects, this famous ode of Wordsworth's is the finest irregular ode in the language; for, although Coleridge's "Ode to the Departing Year" excels it in Pindaric fire, it is below Wordsworth's masterpiece in almost every other quality save rhythm. Among the writers of English irregular odes, next to Wordsworth, stands Dryden. The second stanza of the "Ode for St Cecilia's Day" is a great triumph.

Leaving the irregular and turning to the regular ode, it is natural to divide these into two classes: (1) those which are really Pindaric in so far as they consist of strophes, antistrophes, and epodes, variously arranged and contrasted; and (2) those which consist of a regular succession of regular stanzas. Perhaps all Pindaric odes tend to show that this form of art is in English a mistake. It is easy enough to write one stanza and call it a strophe, another in a different movement and call it an antistrophe, a third in a different movement still and call it an epode. But in modern prosody, disconnected as it is from musical and from terpsichorean science, what are these? No poet and no critic can say.

What is requisite is that the ear of the reader should catch a great metrical scheme, of which these three varieties of movement

are necessary parts—should catch, in short, that inevitableness of structure upon which we have already touched. In order to justify a poet in writing a poem in three different kinds of movement, governed by no musical and no terpsichorean necessity, a necessity of another kind should make itself apparent; that is, the metrical wave moving in the strophe should be metrically answered by the counter-wave moving in the antistrophe, while the epode—which, as originally conceived by Stesichorus, was merely a standing still after the balanced movements of the strophe and antistrophe—should clearly, in a language like ours, be a blended echo of these two. A mere metrical contrast such as some poets labour to effect is not a metrical answer. And if the reply to this criticism be that in Pindar himself no such metrical scheme is apparent, that is the strongest possible argument in support of our position. If indeed the metrical scheme of Pindar is not apparent, that is because, having been written for chanting, it was subordinate to the lost musical scheme of the musician. It has been contended, and is likely enough, that this musical scheme was simple—as simple, perhaps, as the scheme of a cathedral chant; but to it, whatever it was, the metrical scheme of the poet was subordinated. It need scarcely be said that the phrase "metrical scheme" is used here not in the narrow sense as indicating the position and movement of strophe and antistrophe by way of simple contrast, but in the deep metrical sense as indicating the value of each of these component parts of the ode, as a counter-wave balancing and explaining the other waves in the harmony of the entire composition. We touch upon this matter in order to show that the moment odes ceased to be chanted, the words strophe, antistrophe, and epode lost the musical value they had among the Greeks, and pretended to a complex metrical value which their actual metrical structure does not appear to justify. It does not follow from this that odes should not be so arranged, but it does follow that the poet's arrangement should justify itself by disclosing an entire metrical scheme in place of the musical scheme to which the Greek choral lyric was evidently subordinated. But even if the poet were a sufficiently skilled metrist to compass a scheme embracing a wave, an answering wave, and an echo gathering up the tones of each, i.e. the strophe, the antistrophe and the epode, the ear of the reader, unaided by the musical emphasis which supported the rhythms of the old choral lyric, is, it should seem, incapable of gathering up and remembering the sounds further than the strophe and the antistrophe, after which it demands not an epode but a return to the strophe. That is to say, an epode, as alternating in the body of the modern ode, is a mistake; a single epode at the end of a group of strophes and antistrophes (as in some of the Greek odes) has, of course, a different function altogether.

The great difficulty of the English ode is that of preventing the apparent spontaneity of the impulse from being marred by the apparent artifice of the form; for, assuredly, no writer subsequent to Coleridge and to Keats would dream of writing an ode on the cold Horatian principles adopted by Warton, and even by Collins, in his beautiful "Ode to Evening."

Of the second kind of regular odes, those consisting of a regular succession of regular stanzas, the so-called odes of Sappho are, of course, so transcendent that no other amatory lyrics can be compared with them. Never before these songs were sung and never since did the human soul, in the grip of a fiery passion, utter a cry like hers; and from the executive point of view, in directness, in lucidity, in that high imperious verbal economy which only nature herself can teach the artist, she has no equal, and none worthy to take the place of second—not even in Heine, nor even in Burns. Turning, however, to modern poetry, there are some magnificent examples of this simple form of ode in English poetry—Spenser's immortal "Epithalamion" leading the way in point of time, and probably also in point of excellence.

Fervour being absolutely essential, we think, to a great English ode, fluidity of metrical movement can never be dispensed with. The more billowy the metrical waves the better suited are they to render the emotions expressed by the ode, as the reader will see by referring to Coleridge's "Ode to France" (the finest ode in the English language, according to Shelley), and giving special attention to the first stanza—to the way in which the first metrical wave, after it had gently fallen at the end of the first quatrain, leaps up again on the double rhymes (which are expressly introduced for this effect), and goes bounding on, billow after billow, to the end of the stanza. Not that this fine ode is quite free from the great vice of the English ode, rhetoric. If we except Spenser and, in one instance, Collins, it can hardly be said that any English writer before Shelley and Keats produced odes independent of rhetoric and supported by pure poetry alone. But fervid as are Shelley's "Ode to the West Wind" and Keats's odes "To a Nightingale" and "On a Grecian Urn," they are entirely free from rhetorical flourish. Notwithstanding that in the "Ode on a Grecian Urn" the first stanza does not match in rhyme arrangement with the others, while the second stanza of the "Ode to a Nightingale" varies from the rest by running on four rhyme-sounds instead of five, veering the ear at first by disappointed expectation, these two odes are, after Coleridge's "France," the finest regular odes written in the English language.

With regard to the French ode, Malherbe was the first writer

who brought it to perfection. Malherbe showed also more variety of mood than it is the fashion just now to credit him with. This may be especially noted in his "Ode to Louis XIII." His disciple Racan is not of much account. There is certainly much vigour in the odes of Rousseau, but it is not till we reach Victor Hugo that we realize what French poetry can achieve in this line; and contemporary poetry can hardly be examined here. We may say, however, that some of Hugo's odes are truly magnificent. As a pure lyricist his place among the greatest poets of the world is very high. Here, though writing in an inferior language, he ranks with the greatest masters of Greece, of England, and of Germany. Had he attempted no other kind of poetry than lyrical, his would still have been the first name in French poetry. Whatever is defective in his work arises, as in the case of Euripides, from the importation of lyrical force where dramatic force is mainly needed.

The main varieties of lyrical poetry, such as the idyll, the satire, the ballad, the sonnet, &c., are treated in separate articles; but a word or two must be said here about the song. The Song, and the elegy. To write a good song requires that simplicity of grammatical structure which is foreign to many natures—that mastery over direct and simple speech which only true passion and feeling can give, and which "coming from the heart goes to the heart." Without going so far as to say that no man is a poet who cannot write a good song, it may certainly be said that no man can write a good song who is not a good poet. In modern times we have, of course, nothing in any way representing those choral dance-songs of the Greeks, which, originating in the primitive Cretan war-dances, became, in Pindar's time, a splendid blending of song and ballet. Nor have we anything exactly representing the Greek scolia, those short drinking songs of which Terpander is said to have been the inventor. That these scolia were written, not only by poets like Alcaeus, Anacreon, Praxilla, Simonides, but also by Sappho and by Pindar, shows in what high esteem they were held by the Greeks. These songs seem to have been as brief as the stornello of the Italian peasant. They were accompanied by the lyre, which was handed from singer to singer as the time for each scolon came round.

With regard to the stornello, many critics seem to confound it with the *rispetto*, a very different kind of song. The Italian *rispetto* consists of a stanza of inter-rhyming lines ranging from six to ten in number, but often not exceeding eight. The Tuscan and Umbrian *stornello* is much shorter, consisting, indeed, of a hemistich naming some natural object which suggests the motive of the little poem. The nearest approach to the Italian stornello appears to be, not the *rispetto*, but the Welsh trian.

Perhaps the mere difficulty of rhyming in English and the facility of rhyming in Italian must be taken into account when we inquire why there is nothing in Scotland—of course there could be nothing in England—answering to the nature-poetry of the Italian peasant. Most of the Italian *rispetti* and stornelli seem to be improvisations; and to improvise in English is as difficult as to improvise is easy in Italian. Nothing indeed is more interesting than the improvisational poetry of the Italian peasants, such as the canzone. If the peasantry discover who is the composer of a canzone, they will not sing it. The speciality of Italian peasant poetry is that the symbol which is mostly erotic is of the purest and most tender kind. A peasant girl will improvise a song as impassioned as "Come into the Garden, Maud," and as free from unwholesome taint.

With regard to English songs, the critic cannot but ask—Wherein lies the lost ring and charm of the Elizabethan song-writers? Since the Jacobean period at least, few have succeeded in the art of writing real songs as distinguished from mere book lyrics. Between songs to be sung and songs to be read there is in our time a difference as wide as that which exists between plays for the closet and plays for the boards.

Heartiness and melody—the two requisites of a song which can never be dispensed with—can rarely be compassed, it seems, by one and the same individual. In both these qualities the Elizabethan poets stand pre-eminent, though even with them the melody is not so singable as it might be made. Since their time heartiness has, perhaps, been a Scottish rather than an English endowment of the song-writer. It is difficult to imagine an Englishman writing a song like "Tullochgorum" or a song

like "Maggie Lauder," where the heartiness and impulse of the poet's mood conquer all impediments of close vowels and rugged consonantal combinations. Of Scottish song-writers Burns is, of course, the head; for the songs of John Skinner, the heartiest song-writer that has appeared in Great Britain (not excluding Herrick), are too few in number to entitle him to be placed beside a poet so prolific in heartiness and melody as Burns. With regard to Campbell's heartiness, this is quite a different quality from the heartiness of Burns and Skinner, and is in quality English rather than Scottish, though, no doubt, it is of a fine and rare strain, especially in "The Battle of the Baltic." His songs illustrate an infirmity which even the Scottish song-writers share with the English—a defective sense of that true song-warble which we get in the stornelli and rispetti of the Italian peasants. A poet may have heartiness in plenty, but if he has that love of consonantal effects which Donne displays he will never write a first-rate song. Here, indeed, is the crowning difficulty of song-writing. An extreme simplicity of structure and of diction must be accompanied by an instinctive apprehension of the melodic capabilities of verbal sounds, and of what Samuel Lover, the Irish song-writer, called "singing" words, which is rare in this country, and seems to belong to the Celtic rather than to the Saxon ear. "The song-writer," says Lover, "must frame his song of open vowels with as few guttural or hissing sounds as possible, and he must be content sometimes to sacrifice grandeur and vigour to the necessity of selecting singing words and not reading words." And he exemplifies the distinction between singing words and reading words by a line from one of Shelley's songs—

"The fresh earth in new leaves drest,"

"where nearly every word shuts up the mouth instead of opening it." But closeness of vowel sounds is by no means the only thing to be avoided in song-writing. A phrase may be absolutely unsingable, though the vowels be open enough, if it is loaded with consonants. The truth is that in song-writing it is quite as important, in a consonantal language like ours, to attend to the consonants as to the vowels; and perhaps the first thing to avoid in writing English songs is the frequent recurrence of the sibilant. But this applies to all the brief and quintessential forms of poetry, such as the sonnet, the elegy, &c.

As to the elegy—a form of poetic art which has more relation to the objects of the external world than the song, but less relation to these than the stornello—its scope seems to be wide indeed, as practised by such various writers as Tyrtæus, Theognis, Catullus, Tibullus, and our own Gray. It may almost be said that perfection of form is more necessary here and in the sonnet than in the song, inasmuch as the artistic pretensions are more pronounced. Hence even such apparent minutiae as those we have hinted at above must not be neglected here.

We have quoted Dionysius of Halicarnassus in relation to the arrangement of words in poetry. His remarks on sibilants are equally deserving of attention. He goes so far as to *Phœnicis* say that *s* is entirely disagreeable, and, when it often recurs, insupportable. The hiss seems to him to be more appropriate to the beast than to man. Hence certain writers, he says, often avoid it, and employ it with regret. Some, he tells us, have composed entire odes without it. But if sibilation is a defect in Greek odes, where the softening effect of the vowel sounds is so potent, it is much more so in English poetry, where the consonants dominate, though it will be only specially noticeable in the brief and quintessential forms such as the song, the sonnet, the elegy. Many poets only attend to their sibilants when these clog the rhythm. To write even the briefest song without a sibilant would be a *tour de force*; to write a good one would no doubt be next to impossible. It is singular that the only metrist who ever attempted it was John Theiwall, the famous "Citizen John," friend of Lamb and Coleridge, and editor of the famous *Champion* newspaper, where many of Lamb's epigrams appeared. Theiwall gave much attention to metrical questions, and tried his hand at various metres. Though "Citizen John's" supphics might certainly have been better, he had a very remarkable critical insight into the rationale of metrical effects, and his "Song without a Sibilant" is extremely neat and ingenious. Of course, however, it would be mere pedantry to exaggerate this objection to sibilants even in these brief forms of poetry.

(T. W. D.)

POGGENDORFF, JOHANN CHRISTIAN (1796–1877), German physicist, was born in Hamburg on the 29th of December 1796. His father, a wealthy manufacturer, having been all but ruined by the French siege, he had, when only sixteen, to apprentice himself to an apothecary in Hamburg, and when twenty-two began to earn his living as an apothecary's assistant at Itzehoe. Ambition and a strong inclination towards a scientific career led him to throw up his business and remove to Berlin, where he entered the university in 1820. Here his abilities were speedily recognized, and in 1823 he was appointed meteorological observer to the Academy of Sciences. Even at this early period he had conceived the idea of founding a physical and chemical scientific journal, and the realization of this plan was hastened by the sudden death of L. W. Gilbert, the editor of *Gilberts Annalen der Physik*, in 1824. Poggendorff immediately put himself in communication with the publisher, Barth of Leipzig, with the result that he was installed as editor of a scientific journal, *Annalen der Physik und Chemie*, which was to be a continuation of *Gilberts Annalen* on a somewhat extended plan. Poggendorff was admirably qualified for the post. He had an extraordinary memory, well stored with scientific knowledge, both modern and historical, a cool and impartial judgment, and a strong preference for facts as against theory of the speculative kind. He was thus able to throw himself into the spirit of modern experimental science. He possessed in abundant measure the German virtue of orderliness in the arrangement of knowledge and in the conduct of business. Further he had an engaging geniality of manner and much tact in dealing with men. These qualities soon made *Poggendorffs Annalen* the foremost scientific journal in Europe.

In the course of his fifty-two years' editorship of the *Annalen* Poggendorff could not fail to acquire an unusual acquaintance with the labours of modern men of science. This knowledge, joined to what he had gathered by historical reading of equally unusual extent, he carefully digested and gave to the world in his *Biographisch-literarisches Handwörterbuch zur Geschichte der exakten Wissenschaften*, containing notices of the lives and labours of mathematicians, astronomers, physicists, and chemists, of all peoples and all ages. This work contains an astounding collection of facts invaluable to the scientific biographer and historian. The first two volumes were published in 1863; after his death a third volume appeared in 1893, covering the period 1858–1883, and a fourth in 1904, coming down to the beginning of the 20th century.

Poggendorff was a physicist of high although not of the very highest rank. He was wanting in mathematical ability, and never displayed in any remarkable degree the still more important power of scientific generalization, which, whether accompanied by mathematical skill or not, never fails to mark the highest genius in physical science. He was, however, an able and conscientious experimenter, and was very fertile and ingenious in devising physical apparatus. By far the greater and more important part of his work related to electricity and magnetism. His literary and scientific reputation speedily brought him honourable recognition. In 1830 he was made royal professor, in 1834 Hon. Ph.D. and extraordinary professor in the university of Berlin, and in 1839 member of the Berlin Academy of Sciences. Many offers of ordinary professorships were made to him, but he declined them all, devoting himself to his duties as editor of the *Annalen*, and to the pursuit of his scientific researches. He died at Berlin on the 24th of January 1877.

POGGIO (1380–1450). Gian Francesco Poggio Bracciolini, Italian scholar of the Renaissance, was born in 1380 at Terranuova, a village in the territory of Florence. He studied Latin under John of Ravenna, and Greek under Manuel Chrysoloras. His distinguished abilities and his dexterity as a copyist of MSS. brought him into early notice with the chief scholars of Florence. Coluccio Salutati and Niccolò de' Niccoli befriended him, and in the year 1402 or 1403 he was received into the service of the Roman curia. His functions were those of a secretary; and though he profited by benefices conferred on him in lieu of salary, he remained a layman to the end of his life. It is noticeable

that, while he held his office in the curia through that momentous period of fifty years which witnessed the Councils of Constance and of Basel, and the final restoration of the papacy under Nicholas V., his sympathies were never attracted to ecclesiastical affairs. Nothing marks the secular attitude of the Italians at an epoch which decided the future course of both Renaissance and Reformation more strongly than the mundane proclivities of this apostolic secretary, heart and soul devoted to the resuscitation of classical studies amid conflicts of popes and antipopes, cardinals and councils, in all of which he bore an official part. Thus, when his duties called him to Constance in 1414, he employed his leisure in exploring the libraries of Swiss and Swabian convents. The treasures he brought to light at Reichenau, Weingarten, and above all St Gall, restored many lost masterpieces of Latin literature, and supplied students with the texts of authors whose works had hitherto been accessible only in mutilated copies. In one of his epistles he describes how he recovered Quintilian, part of Valerius Flaccus, and the commentaries of Asconius Pedianus at St Gall. MSS. of Lucretius, Columella, Silius Italicus, Manilius and Vitruvius were unearthed, copied by his hand, and communicated to the learned. Wherever Poggio went he carried on the same industry of research. At Langres he discovered Cicero's *Oration for Caecina*, at Monte Cassino a MS. of Frontinus. He also could boast of having recovered Ammianus Marcellinus, Nonius Marcellus, Probus, Flavius Caper and Eutyches. If a codex could not be obtained by fair means, he was ready to use fraud, as when he bribed a monk to abstract a Livy and an Ammianus from the convent library of Hersfeld. Resolute in recognising erudition as the chief concern of man, he sighed over the folly of popes and princes, who spent their time in wars and ecclesiastical disputes when they might have been more profitably employed in revivifying the lost learning of antiquity. This point of view is eminently characteristic of the earlier Italian Renaissance. The men of that nation and of that epoch were bent on creating a new intellectual atmosphere for Europe by means of vital contact with antiquity. Poggio, like Aeneas Sylvius Piccolomini (Pius II.), was a great traveller, and wherever he went he brought enlightened powers of observation trained in liberal studies to bear upon the manners of the countries he visited. We owe to his pen curious remarks on English and Swiss customs, valuable notes on the remains of antique art in Rome, and a singularly striking portrait of Jerome of Prague as he appeared before the judges who condemned him to the stake. It is necessary to dwell at length upon Poggio's devotion to the task of recovering the classics, and upon his disengagement from all but humanistic interests, because these were the most marked feature of his character and career. In literature he embraced the whole sphere of contemporary studies, and distinguished himself as an orator, a writer of rhetorical treatises, a panegyrist of the dead, a violent impugner of the living, a translator from the Greek, an epistolographer and grave historian and a facetious compiler of *fabliaux* in Latin. On his moral essays it may suffice to notice the dissertations *On Nobility*, *On Vicissitudes of Fortune*, *On the Misery of Human Life*, *On the Infelicity of Princes* and *On Marriage in Old Age*. These compositions belonged to a species which, since Petrarch set the fashion, were very popular among Italian scholars. They have lost their value, except for the few matters of fact embedded in a mass of commonplace meditation, and for some occasionally brilliant illustrations. Poggio's *History of Florence*, written in a vowed imitation of Livy's manner, requires separate mention, since it exemplifies by its defects the weakness of that merely stylistic treatment which deprived so much of Bruni's, Carlo Aretino's and Bembo's work of historical weight. A somewhat different criticism must be passed on the *Facetiae*, a collection of humorous and indecent tales expressed in such Latin as Poggio could command. This book is chiefly remarkable for its unsparring satires on the monastic orders and the secular clergy. It is also noticeable as illustrating the latinizing tendency of an age which gave classic form to the lightest essays of the fancy. Poggio, it may be observed, was a fluent and

copious writer in the Latin tongue, but not an elegant scholar. His knowledge of the ancient authors was wide, but his taste was not select, and his erudition was superficial. His translation of Xenophon's *Cyropaedia* into Latin cannot be praised for accuracy. Among contemporaries he passed for one of the most formidable polemical or gladiatorial rhetoricians; and a considerable section of his extant works are invectives. One of these, the *Dialogue against Hypocrites*, was aimed in a spirit of vindictive hatred at the vices of ecclesiastics; another, written at the request of Nicholas V., covered the anti-pope Felix with scurrilous abuse. But his most famous compositions in this kind are the personal invectives which he discharged against Filelfo and Valla. All the resources of a copious and uncian Latin vocabulary were employed to degrade the objects of his satire; and every crime of which humanity is capable was ascribed to them without discrimination. In Filelfo and Valla Poggio found his match; and Italy was amused for years with the spectacle of their indecent combats. To dwell upon such literary infamies would be below the dignity of the historian, were it not that these habits of the early Italian humanists imposed a fashion upon Europe which extended to the later age of Scaliger's contentions with Scoppius and Milton's with Salmasius. The greater part of Poggio's long life was spent in attendance to his duties in the papal curia at Rome and elsewhere. But about the year 1452 he finally retired to Florence, where he was admitted to the burghership, and on the death of Carlo Aretino in 1453 was appointed chancellor and historiographer to the republic. He had already built himself a villa in Valdarno, which he adorned with a collection of antique sculpture, coins and inscriptions. In 1435 he had married a girl of eighteen named Vaggia, of the famous Buondelmonte blood. His declining days were spent in the discharge of his honourable Florentine office and in the composition of his history. He died in 1459, and was buried in the church of Santa Croce. A statue by Donatello and a picture by Antonio del Pollajuolo remained to commemorate a citizen who chiefly for his services to humanistic literature deserved the notice of posterity.

Poggio's works were printed at Basel in 1538, "ex aedibus Henrici Petri." Dr Shepherd's *Life of Poggio Bracciolini* (1802) is a good authority on his biography. For his position in the history of the revival, see Voigt's *Wiederbelebung des classischen Alterthums*, and Symonds's *Renaissance in Italy*. (J. A. S.)

POGLIZZA (Serbo-Croatian, Poljica), a tract of mountainous land in Dalmatia, Austria; formerly the seat of an independent republic. The territories of Poglizza lay chiefly within the south-easterly curve made by the river Cetina before it enters the Adriatic at Almissa (Omilj). They also comprised the fastnesses of the Mosor range (4500 ft.) and the fertile strip of coast from Almissa to Stobrez, 10 m. W.N.W. The inhabitants lived in scattered villages, each ruled by its count, and all together ruled by the supreme count. These officers, with the three judges, were always of noble birth, though elected by the whole body of citizens. There were two orders of nobles; the higher, including about 20 families, claimed Hungarian descent; the lower, claiming kinship with the Bosnian aristocracy. Below these ranked the commoners and the serfs. At a very early date the warlike highlanders of Poglizza became the friends and allies of the Almissan corsairs, who were thus enabled to harass the seaborne trade of their neighbours without fear of a sudden attack by land. Almissa received a charter from Andrew II. of Hungary in 1207, and remained under the nominal protection of Hungary until 1444, when both Almissa and Poglizza accepted the suzerainty of Venice, while retaining their internal freedom. The population of Poglizza numbered 6566 in 1806. In the following year, however, the republic incurred the enmity of Napoleon by rendering aid to the Russians and Montenegrois in Dalmatia; and it was invaded by French troops, who plundered its villages, massacred its inhabitants, and finally deprived it of independence.

See the *Annuario Dalmatico* for 1885 (published at Zara); and A. Fortis; *Travels into Dalmatia* (London, 1778).

POINCARÉ, RAYMOND (1860-), French statesman, was born at Bar-le-duc on the 20th of August 1860, the son of Nicolas Antonin Hélène Poincaré, a distinguished civil servant and meteorologist. Educated at the university of Paris, Raymond was called to the Paris bar, and was for some time law editor of the *Voltaire*. He had served for over a year in the department of agriculture when in 1887 he was elected deputy for the Meuse. He made a great reputation in the Chamber as an economist, and sat on the budget commissions of 1890-1891 and 1892. He was minister of education, fine arts and religion in the first cabinet (April-Nov. 1893) of Charles Dupuy, and minister of finance in the second and third (May 1894-Jan. 1895). In the succeeding Ribot cabinet Poincaré became minister of public instruction. Although he was excluded from the Radical cabinet which followed, the revised scheme of death duties proposed by the new ministry was based upon his proposals of the previous year. He became vice-president of the chamber in the autumn of 1895, and in spite of the bitter hostility of the Radicals retained his position in 1896 and 1897. In 1906 he returned to the ministry of finance in the short-lived Sarrien ministry. Poincaré had retained his practice at the bar during his political career, and he published several volumes of essays on literary and political subjects.

His brother, Lucien Poincaré (b. 1862), famous as a physicist, became inspector-general of public instruction in 1902. He is the author of *La Physique moderne* (1906) and *L'Électricité* (1907). Jules Henri Poincaré (b. 1854), also a distinguished physicist, belongs to another branch of the same family.

POINSETTIA. The *Poinsettia pulcherrima* of gardens (*Euphorbia pulcherrima* of botanists), a native of Mexico and Central America, with its brilliant scarlet bracts, stands unrivalled amongst decorative plants. The white-bracted sort, var. *alba*, is not so effective, but the double-flowered, var. *plenisissima*, in which the brilliant inflorescence is branched, is as brilliant as the type, and keeps long in flower. They are increased by cuttings in spring, which when taken-off with a heel strike freely in brisk heat. They require good turfy loam, with an addition of one-sixth of leaf-mould and a little sand, and should be kept in a heat of from 65° to 70° at night, with a rise of 10° by day. To prevent their growing lanky, they should be kept with their heads almost touching the glass; and as the pots get filled with roots they must be shifted into others, 7 or 8 in. in diameter. About August they may be inured to a heat of 50° at night, and should be brought to bear air night and day whilst the weather is warm, or they may be placed out of doors for a month under a south wall in the full sun. This treatment matures and prepares them for flowering. In autumn they must be removed to a house where the temperature is 50° at night, and by the end of September some of them may be put in the stove, where they will come into flower, the remainder being placed under heat later for succession. When in bloom they may be kept at about 55° by night, and so placed will last longer than if kept in a higher temperature.

POINSON, LOUIS (1777-1859), French mathematician, was born at Paris on the 3rd of January 1777. In 1794 he became a scholar at the École Polytechnique, which he left in 1796 to act as a civil engineer. In 1804 he was appointed professor of mathematics at the Lycée, in 1809 professor of analysis and mechanics, and in 1816 examiner at the École Polytechnique. On the death of J. L. Lagrange, in 1813, Poinson was elected to his place in the Académie des Sciences; and in 1840 he became a member of the superior council of public instruction. In 1840 he was made an officer of the Legion of Honour; and on the formation of the senate in 1852 he was chosen a member of that body. He died at Paris on the 5th of December 1859.

Poinson's earliest work was his *Éléments de statique* (1803; 9th edition, 1848), in which he introduces the idea of statical couples and investigates their properties. In the *Théorie nouvelle de la rotation des corps* (1834) he treats the motion of a rigid body geometrically, and shows that the most general motion of such a body can be represented at any instant by a rotation about an axis combined with a translation parallel to this axis,

and that any motion of a body of which one point is fixed may be produced by the rolling of a cone fixed in the body on a cone fixed in space. The previous treatment of the motion of a rigid body had in every case been purely analytical, and so gave no aid to the formation of a mental picture of the body's motion; and the great value of this work lies in the fact that, as Poinson himself says in the introduction, it enables us to represent to ourselves the motion of a rigid body as clearly as that of a moving point. In addition to publishing a number of works on geometrical and mechanical subjects, Poinson also contributed a number of papers on pure and applied mathematics to *Lieutnant's Journal* and other scientific periodicals.

See J. L. F. Bertrand, *Discours aux funérailles de Poinson* (Paris 1860).

POINT PLEASANT, a town and the county-seat of Mason county, West Virginia, U.S.A., on the Ohio river, at the mouth of the Kanawha river, and about midway between Pittsburg and Cincinnati. Pop. (1900) 1931; (1910) 2045. It is served directly by the Baltimore & Ohio and the Kanawha & Michigan (controlled by the Hocking Valley) railways, and by the Hocking Valley railway on the opposite side of the Ohio river. The Kanawha river is navigable (by the use of locks and dams) for 90 m. above the town, and Point Pleasant is a re-shipping point for Kanawha coal. Coal and salt are mined in the vicinity, but the surrounding country is principally agricultural.

The battle of Point Pleasant, the only important engagement in "Lord Dunmore's War," was fought here on the 10th of October 1774 between about 1100 Virginia militiamen, under General Andrew Lewis (c. 1720-1781),¹ and about 1000 Shawnees and their allies, under their chief, Cornstalk (c. 1720-1777).² Lewis had been ordered to meet Lord Dunmore here with a body of militiamen (recruited from Botetourt, West Augusta and Fincastle counties), but when he reached the mouth of the Kanawha, after marching 160 m. from Fort Union (now Lewisburg, W. Va.), Dunmore's force, which was to have gone over the Braddock trail to Fort Pitt, and thence down the Ohio river, had not arrived. Early on the morning of the 10th the Indians suddenly attacked, and the battle continued fiercely throughout the day. At night the Indians crossed the Ohio river, leaving behind many of their dead. The whites lost about 144 in killed and wounded, Colonel Charles Lewis (1733-1774), a brother of the commanding officer, being among the former. In December Lord Dunmore concluded a treaty with the Indians, by which they surrendered their claim to lands south of the Ohio and agreed not to molest whites travelling to the western country. The battle, which overawed the Indians, and the treaty, which was not seriously broken for three years, made possible the rapid settlement of the western country, especially of Kentucky, during the early years of the War of Independence.³ Four years before the battle the Virginia House of Burgesses had awarded to General Lewis, for his earlier services in the French and Indian War, 9876 acres of land, including the

¹ General Lewis was born in Donegal, Ireland; served with Washington at Fort Mifflin and at Braddock's defeat; was commissioner from Virginia to conclude the treaty with the Six Nations at Fort Stanwix (1768); was a member of the Virginia House of Burgesses for several years; served as a brigadier-general in the War of Independence; and in 1776 forced Lord Dunmore to retire from Gwynn's Island, in Chesapeake Bay, where he had taken refuge.

² Cornstalk and his son were killed within the fort at Point Pleasant in November 1777 by Virginian soldiers (contrary to the protests of their commanding officers), who thus avenged the death of a comrade. He was at the time warning the garrison of his inability to hold the Shawnees to the terms of the treaty of 1774. There is a granite monument (erected in 1899) over his grave in the yard of the court-house.

³ Various American writers have asserted that Lord Dunmore incited the Indians to attack the frontier in order to divert the colonists from their opposition to Great Britain, and that he purposely refrained from effecting a junction with Lewis, so that Lewis might be defeated and Virginia thus be greatly crippled on the eve of the threatened war with the mother country; and the battle itself has accordingly frequently been referred to as the first battle of the War of Independence. The assertions with regard to Lord Dunmore, however, rest on circumstantial evidence alone, and have never been conclusively proved.

present site of Point Pleasant; the survey of this grant was made by George Washington. After the battle General Lewis sent a detachment to build a fort (called Fort Blair) here; in 1776 Fort Randolph (abandoned in 1779) was erected on the same site, and in 1785 (from which year the permanent settlement of the town may be dated) a third fort was built here. Daniel Boone lived here from 1788 until about 1799. In 1794 the village of Point Pleasant was platted; it was incorporated as a town in 1833. A granite monument (86 ft. high) commemorating the battle was unveiled on the 10th of October 1909.

See J. T. McAllister's article, "The Battle of Point Pleasant," in the *Virginia Magazine of History and Biography* (1901-1902), vol. x., and Virgil A. Lewis, *History of the Battle of Point Pleasant* (Charleston, W. Va., 1909).

POISON. An exact definition of the word "poison" (derived through Fr. from Lat. *poisio, poisonem*, a drink; i.e. a deadly draught) is by no means easy. There is no legal definition of what constitutes a poison, and the definitions usually proposed are apt to include either too much or too little. Generally, a poison may be defined to be a substance having an inherent deleterious property, rendering it capable of destroying life by whatever avenue it is taken into the system; or it is a substance which when introduced into the system, or applied externally, injures health or destroys life irrespective of mechanical means or direct thermal changes. In popular language a poison is a substance capable of destroying life when taken in small quantity; but a substance which destroys life by mechanical means as, e.g. powdered glass, is not, strictly speaking, a poison.

The subject of toxicology forms one of the most important branches of medical jurisprudence (*q.v.*). The medical jurist should be familiar with the nature and actions of poisons, the symptoms which they produce, the circumstances which modify their working, the pathological results of their action, and the methods of combating these.

Action of Poisons.—Poisons may exert a twofold action. This may be either local, or remote, or both local and remote. The local action of a poison is usually one of corrosion, inflammation, or a direct effect upon the sensory or motor nerves. The remote actions of poisons are usually of a specific character, though some writers group the remote effects of poisons under two heads, and speak of the common and the specific remote effects of a poison. The local action of a poison of the corrosive class is usually so well marked and obvious that the fact of the administration of a poison of this class is generally unmistakable. The same may be said, in a less degree, of the irritant poisons, especially the mineral irritants; but here the symptoms sometimes so closely simulate those of natural disease as to render the recognition of the administration of poison a matter of difficulty. Hence an accurate acquaintance with the remote specific effects of the various poisons is indispensable to the medical jurist. The class of poisons which has been administered or taken will thus be suggested to his mind by the observation of the symptoms; and not unfrequently the specific poison taken will be suspected. It is almost universally admitted that absorption of a poison is necessary for the production of its specific remote effects, and the old notion that a poison may kill, by its action through the nervous system, without absorption, is abandoned.

Modifying Circumstances.—The ordinary action of a poison may be greatly modified by the largeness of the dose, by the state of aggregation, admixture, or of chemical combination of the poison, by the part or membrane to which it is applied, and by the condition of the patient. Thus, for example, opium may be a medicine or a poison, according to the dose in which it is given; and a dose of the drug which may be beneficial to an adult in certain states of the system may be fatal to a child, or to an adult when suffering from some forms of disease. All barium salts, again, are poisonous, except the quite insoluble sulphate. The simple cyanides, and many double cyanides, are highly poisonous; but yellow prussiate of potash, which is a double cyanide of iron and potassium, is almost without action upon the system. The part or tissue to which a poison is applied

greatly affects the activity of a poison; owing to the varying rapidity with which absorption takes place through the cutaneous, mucous and serous surfaces, and by the other tissues of the body. Curare, an arrow poison, may be swallowed in considerable quantity without appreciable result, whilst a minute quantity of the same substance introduced into a wound is speedily fatal. Idiosyncrasy has an important bearing in toxicology. Pork, mutton, certain kinds of fish, more especially shell-fish so-called, and mushrooms have each produced all the symptoms of violent irritant poisoning, whilst other persons who have partaken of the same food at the same time have experienced no ill effects. Some persons are stated, on good authority, to be capable of taking with impunity such poisons as opium, corrosive sublimate, or arsenic, in enormous doses—and this irrespective of habit, which is known to have such an influence in modifying the effects of some poisons, notably the narcotics. A tolerance of poisons is sometimes engendered by disease, so that a poison may fail to produce its customary effect. Thus, opium is tolerated in large quantities in tetanus and in delirium tremens; and mercurial compounds may in some febrile affections fail to produce the usual constitutional effects of the metal. On the other hand, diseases which impede the elimination of a poison may intensify its effects.

The evidence that a poison has been administered is based upon the symptoms produced, on the appearances met with in the body after death, on the analysis of articles of food and drink, of excreta and ejecta, and of the organs of the body after death, and on physiological experiments made with substances extracted from the same articles. These physiological experiments are usually made upon animals, but in some cases, as for instance when aconite has to be searched for, the physiological experiments must be made also upon the human subject. The evidence obtained from one or more of these sources, as compared with the properties or effects of various known poisons, will enable the medical jurist to form an opinion as to the administration or non-administration of a poison.

The symptoms exhibited by the patient during life rarely fail to afford some clue to the poison taken. Persons may, however, be found dead of whose history nothing can be learned. Here post mortem appearances, chemical analysis, and, it may be, physiological experiments, are all-important for the elucidation of the nature of the case.

Poisoning may be *acute* or *chronic*. The general conditions which should arouse a suspicion of acute poisoning are the sudden onset of serious and increasingly alarming symptoms in a person previously in good health, especially if there be pain in the region of the stomach, or, where there is complete prostration of the vital powers, a cadaveric aspect, and speedy death. In all such cases the aid of the analytical chemist must be called in either to confirm well-founded or to rebut ill-founded suspicions.

The *mode of treatment* to be adopted in the case of poisoned persons varies greatly according to the nature of the poison. The first indication, when the poison has been swallowed, is to evacuate the stomach; and this may usually be done by means of the stomach-pump when the poison is not of the corrosive class; or the stomach may be gently washed out by means of a funnel and flexible siphon-tube. In many cases emetics are valuable. Antidotes and counter-poisons may then be given. The former are such substances as chalk to neutralize the mineral acids and oxalic acid; the latter have a physiological counter-action, and are such as atropine, which is a counter-poison to morphia. These may usually be administered most effectively by hypodermic injection. The stomach may to a certain degree be protected from the injurious effects of irritants by the administration of mucilaginous drinks; alkaloids may be rendered sparingly soluble by means of astringent substances containing tannin; and pain may be relieved by means of opium, unless contra-indicated by the nature of the poison. The effects of the convulsant poisons, such as strychnine, may be combated by means of the inhalation of chloroform.

The *classification* of poisons is a matter of difficulty. Various

attempts have been made to classify them scientifically, but with no signal success; and perhaps the best system is that which groups the various poisons according to the more obvious symptoms which they produce. Our knowledge of the more intimate action of poisons is still too imperfect to admit of any useful classification according to the manner in which they specifically affect the vital organs. Poisons may in the manner indicated be classified as (1) *Corrosives*, (2) *Irritants*, (3) *Neurotics*, and (4) *Gaseous Poisons*.

1. Corrosives.

The typical member of this class is corrosive sublimate, the soluble chloride of mercury. In it are included also the concentrated mineral acids (sulphuric, nitric and hydrochloric); oxalic acid; the alkalis (potash, soda, and ammonia) and their carbonates; acid, alkaline, and corrosive salts of the metals (such as bisulphate of potash, alum, butter of antimony and nitrate of silver); also carbolic acid.

The symptoms produced by the mineral acids and the alkalis are almost altogether referable to local action; but some corrosive poisons, such as carbolic acid, produce, besides a local action, remote and specific constitutional effects. The symptoms of corrosive poisoning are marked and unmistakable, except in infants. Immediately on swallowing the corrosive substance, an acid, caustic or metallic burning sensation is experienced in the mouth, fauces, gullet and region of the stomach, and this speedily extends over the whole belly; as a rule vomiting speedily follows. In the case of the mineral acids, and in oxalic acid poisoning, the vomit is so acid that if it falls upon a marble or concrete floor effervescence ensues. No relief follows the evacuation of the stomach. The ejected matters contain blood, and even fragments of the corroded walls of the alimentary canal. The belly becomes distended with gas and horribly tender. High fever prevails. The mouth is found to be corroded. Death usually ensues within a few hours; or, if the patient survives, he or she may perish miserably, months after the poison was taken, through starvation consequent upon the gradual contraction of the gullet, brought about by its corrosion and subsequent healing.

The treatment of corrosive poisoning consists in very gently emptying and washing out the stomach by means of a soft siphon-tube. The stomach-pump cannot be used with safety in consequence of the weakening of the walls of the stomach by corrosion. Demulcents and opiates may be subsequently administered. After death from corrosive poisoning the walls of the stomach are found corroded and even perforated.

1. *Corrosive Sublimate*.—Here all the signs and symptoms of corrosive poisoning are produced in their severest form. A grain or two of this poison may prove fatal. Fortunately there is an efficient antidote in white of egg, the albumen of which, if administered at once, renders the salt insoluble. The eggs should be divested of their yolks, beaten up with water, and given promptly, repeatedly, and abundantly, followed by emetics. Poisoning by corrosive sublimate may be followed by the specific toxic effects of mercury, such as salivation and tremor.

Workers in mercury, such as water-gilders, looking-glass makers, and the makers of barometers and thermometers, are apt to suffer from a peculiar form of shaking palsy, known as "the trembles," or mercurial tremor. This disease affects most frequently those who are exposed to mercurial fumes. The victim is affected with tremors when an endeavour is made to exert the muscles, so that he is unable, for instance, to convey a glass of water to the lips steadily, and when he walks he breaks into a dancing trot. The treatment consists in removal from the mercurial atmosphere, baths, fresh air, and the administration of iron and other tonics.

2. *Mineral Acids*.—These are oil of vitriol or sulphuric acid, aqua fortis or nitric acid, and spirit of salt or hydrochloric (muriatic) acid. These, when taken in a concentrated form, produce well-marked symptoms of corrosion. When they are diluted, the symptoms are those of an irritant poison. Nitric acid stains the mouth and skin of a yellow colour. The treatment consists in the administration of the alkalis or other carbonates, chalk, whitening, or even uncoloured plaster scraped off the walls or ceiling, with the view of neutralizing the acid.

3. *Oxalic acid* is a vegetable acid. When taken in the state of concentrated solution it acts as a corrosive, but when diluted as an irritant. But it also exerts a specific effect, killing the patient by cardiac syncope not unfrequently within a few minutes. When a person after taking a crystalline substance, tasting strongly acid, dies within 15 or 30 minutes, after the manifestation of great weakness, small pulse and failure of the heart's power, poisoning by oxalic acid is almost certain. The treatment consists in promptly administering an emetic followed by chalk, whitening, or any substance containing carbonate of calcium. The alkaline carbonates are valuable, for the alkaline oxalates are almost as poisonous as oxalic acid itself.

4. *The Alkalis*.—Caustic potash and caustic soda produce symptoms resembling those of the mineral acids, except that purging is a usual accompaniment.

5. *Carbolic acid* when taken in the form of a concentrated liquid acts as a corrosive, causing whitening and shrinking of all the animal membranes with which it comes in contact. The patient, however, becomes speedily comatose, the poison acting profoundly upon the great nervous centres. A curious phenomenon—black or dark green urine—is commonly observed after the administration of this poison. Saccharated lime-water, diluted and drunk freely, and a solution of sulphate of soda are perhaps the most useful remedies.

2. Irritant Poisons.

Irritant poisons are of two classes—metallic irritants and vegetable and animal irritants, these latter being for convenience grouped together. Perhaps none of the irritants act purely as such, the irritant symptoms being usually accompanied by well-marked effects upon the nervous system. An irritant is a substance which causes inflammation of the part to which it is applied—usually the alimentary canal. Arsenic is by far the most important of the metallic irritants. Other irritants are the moderately diluted acids, many metallic salts, such as those of antimony, lead, copper, zinc and chromium. Elaterium, gamboge, aloes, colocynthis and croton oil are good examples of vegetable irritants; and castor-oil of animal irritants. Animal and vegetable food when decomposed, or infested with certain organisms known as bacteria, may produce violent irritant symptoms. The symptoms produced by irritant poisons are usually more slow in their development than where a corrosive has been administered. Usually, after an interval, greater or less according to the specific nature of the irritant swallowed, a burning pain is felt in the mouth, throat and gullet, with a sense of constriction of the parts, and followed by burning pain in the region of the stomach. This is increased, and not alleviated, by pressure, a mark which serves to distinguish the attack from one of ordinary colic. Nausea, vomiting and thirst ensue, speedily followed by distension of the whole abdomen, which is exceedingly tender to the touch. Ordinarily the vomiting is followed by profuse diarrhoea. Should the poison not be speedily eliminated in the vomited and faecal matters, inflammatory fever sets in, followed by collapse; and death may ensue in a few hours.

There is danger of confounding irritant poisoning with some forms of natural disease, such as gastritis and gastric ulcer, colic, peritonitis, cholera and rupture of the intestines.

1. *Arsenic* is a specific irritant and poisonous. Almost all the compounds of this metal are poisonous. The term "arsenic" is, however, most commonly applied, not to the metal itself, but to its lower oxide, arsenious oxide, which is also known as *white arsenic*. By whatever channel arsenic is introduced into the system, it invariably affects specifically the stomach and intestines, causing congestion or inflammation. The common sources of arsenical poisoning are the taking of white arsenic, which causes acute poisoning, and the inhalation of dust from arsenical wall-papers and textile fabrics, whereby a chronic form of poisoning is induced.

The symptoms and treatment of arsenical poisoning are described under Arsenic (g.v.).

Arsenic-eating, or the ability of some persons to take relatively large doses of arsenic habitually, is a well-established fact. The cause of this singular immunity from the ordinary results of arsenic is unknown.

2. *Lead*.—The salts of lead, more especially the acetate (sugar of lead), are irritant poisons of no very great activity; and, though occasionally death ensues, recovery is the rule. Chrome yellow, or lead chromate, is a powerful irritant poison. All chromates are, indeed, irritant poisons. (See LEAD POISONING.)

3. *Copper*.—The soluble salts of copper, such as blue vitriol (the sulphate) and verdigris (subcarbonate and subacetate), are emetic and irritant salts. Their emetic effects usually, but not invariably, secure their prompt rejection by the stomach. Occasionally local effects have resulted from their administration. Copper becomes accidentally mixed with articles of dietary in a variety of modes. It is also used for improving the colour of preserved fruits and vegetables. Its deleterious properties when thus used in minute quantities have been both asserted and denied. There is, however, a large body of evidence in favour of the at all events occasional poisonous effects of minute quantities of copper.

4. *Zinc salts and barium salts*, except the quite insoluble barium sulphate, are irritant poisons; and barium compounds act also upon the central nervous system.

5. *Chromates*, e.g. bichromate of potash, are violent irritants. Chrome yellow, or lead chromate, has already been mentioned.

6. *Phosphorus*.—Of the two chief forms of the elements—the yellow or ordinary and the red or amorphous—the former only is poisonous. Rarely there is met with a chronic form of poisoning among workers in the material, arising from the inhalation of phosphorus vapours. Its special characteristic is a peculiar necrosis or death of the bony structure of the lower jaw. Acute phosphorus poisoning is more common. Phosphorus is used for tipping matches, and is also the basis of several vermin destroyers. (See PHOSPHORUS AND MATCH.)

7. *Vegetable Irritants*.—These produce drastic purgative effects. Frequently the nature of the illness may be ascertained by the discovery of portions of the vegetable substance—recognisable by the microscope—in the matters ejected by the patient.

8. *Cantharides*.—The administration of cantharides (s.s.) is followed by vomiting, purging, stranguary, or even entire inability to pass the urine. In the ejecta portions of the shining elytra or wing-cases of the fly may often be recognized. There is often great excitement of the sexual proclivities. The active principle of the fly, cantharidin, may be extracted from suspected matters by means of chloroform, and the residue left after the evaporation of this blisters the lip or any tender mucous surface to which it is applied. Demulcent remedies, with opiate enemata and injections, afford the best relief by way of treatment.

3. Neurotics.

1. *Prussic or Hydrocyanic Acid*.—Hydrocyanic acid is one of the best known poisons, and a very deadly one. In the pure state it is said to kill with lightning-like rapidity. It is met with in commerce only in a dilute state. In Great Britain two kinds of acid are commonly sold—the pharmacopoeial acid, containing 2% of anhydrous prussic acid, and Scheele's acid, containing 4 to 5%. Less than a teaspoonful of the 2% acid has caused death. Given in fatal doses, the symptoms of prussic-acid poisoning set in with great rapidity; and, in consequence of the readiness with which the poison is absorbed from the stomach and diffused through the circulation, the onset of symptoms is reckoned by seconds rather than by minutes. Occasionally the victim may be able to perform a few voluntary actions before alarming symptoms are developed. There is first a very brief stage of difficult breathing, and slow action of the heart, with a tendency for the organ to stop in the state of dilatation. With widely-dilated pupils of the eye, the patient is then seized with violent irregular convulsive movements. The rhythm of the respiratory movements is disturbed, and the countenance becomes of a bluish cast. The patient now sinks to the ground with complete loss of muscular power; and the third or apyhsial stage is reached, in which there are slow gasping respirations, loss of pulse, and paralysis of motion. Death is frequently preceded by muscular spasms. The *foudroyant* character of the illness, and the speedy death of the patient, coupled with the peculiar odour of the acid in the breath and atmosphere around the body, seldom leave any doubt as to the nature of the case. The treatment consists in inhalation of fumes of strong ammonia, drinks of warm and cold water alternately, friction of the limbs, and artificial respiration. The subcutaneous injection of atropine, which acts as a cardiac stimulant, may prove serviceable.

Other soluble cyanides, more especially cyanide of potassium, a salt largely used in photography and in the arts, are equally poisonous with hydrocyanic acid. (See PRUSSIC ACID.)

2. *Opium*.—In consequence of the extent to which opium, its preparations, and its active alkaloid morphia are used for the relief of pain, poisoning by opium is of frequent occurrence. It is largely used by suicides; and children, being very susceptible to its influence, frequently die from misadventure after administration of an overdose of the drug. The ordinary preparations of opium are the drug itself, which is the inspissated juice of the oriental poppy, and the tincture, commonly known as laudanum. Opium contains a variety of more or less active principles, the chief of which is the alkaloid morphia, which is present in good opium to the extent of about 10% in combination with meconic acid, which is physiologically inactive. Opium is largely used by Eastern nations for smoking, and there is great discrepancy of opinion as to the extent to which opium smoking is deleterious. The preponderance of opinion is in favour of the view that opium smoking is a demoralizing, degrading, and pernicious habit, and that its victims are sufferers both in body and mind from its use. (See OPIUM and MORPHINE.)

3. *Strychnine and Strychnine-yielding Plants*.—The alkaloids strychnine and brucine, as well as all the plants in which they are found, all act in the same manner, being highly poisonous, and causing death after spasms of a severe character. Many vermin-killers contain strychnine as their active ingredient.

Strychnine and all substances containing that alkaloid, produce their effects within a very few minutes—usually within ten or fifteen minutes. The patient complains of stiffness about the neck, and his aspect exhibits terror. There is an impression of impending calamity or death. Very speedily the head is jerked back, the limbs extended, the back arched (opisthotonos), so that the body may rest on the head and heels only. In a few moments these symptoms pass off, and there is complete relaxation of the spasm. The spasmodic condition speedily returns, and is brought about by the slightest touch or movement of the patient. Accessions and remissions of the tetanic state ensue rapidly till the patient succumbs, usually within half an hour of the administration of the poison. The best treatment is to put, and keep, the patient under the influence of chloroform till time is given for the excretion of the alkaloid, having previously given a full dose of chloral hydrate. (See STRYCHNINE.)

4. *Aconite Poisoning*.—The ordinary blue rocket, wolfsbane or monkshood, *Aconitum Napellus*, and an alkaloid extracted from it, aconitine, are perhaps the most deadly of known poisons. One-sixteenth of a grain of aconitine has proved fatal to a man. All the preparations of aconite produce a peculiar burning, tingling, and numbness of the parts to which they are applied. When given in

large doses they produce violent vomiting, as a rule, more or less paralysis of motion and sensation, and great depression of the heart, usually ending in death from syncope. Intelligence remains unaffected till almost the last. The treatment consists in the hypodermic injection of digitalin, which is a counter-poison in its action upon the heart. The root of aconite has been eaten in mistake for that of horse-radish.

5. *Belladonna*.—The belladonna or deadly nightshade, *Atropa Belladonna*, contains an alkaloid, atropine, which is largely used by oculists to procure dilatation of the pupils of the eye. The bright scarlet berries of the plant have been eaten by children, who are attracted by their tempting appearance. Belladonna produces dilatation of the pupils, rapid pulse, hot dry flushed skin, with an eruption not unlike that of scarlatina, soreness of the throat, with difficulty of swallowing, intense thirst, and gay, mirthful delirium. The treatment consists in evacuation of the poison by means of the stomach-pump, and the hypodermic injection of morphia as a counter-poison.

4. Gaseous Poisons.

The effects of these are varied—some of them acting as irritants, while others have a specific effect, apparently in consequence of their forming chemical compounds with the red pigment of the blood, and thus destroying its capability of acting as a carrier of oxygen.

1. *Chlorine and bromine* act as powerful irritants. They provoke spasm of the glottis when inhaled, and subsequently induce inflammation of the respiratory mucous membrane, which may prove speedily fatal. Inhalation of diluted ammonia vapour is the best remedy.

2. *Hydrochloric or muriatic acid gas and hydrofluoric or fluoric acid gas* are irritating and destructive to life. The former is more destructive to vegetable life than even chlorine. They are emitted in many processes of manufacture, and especially in the manufacture of carbonate of soda from common salt by Le Blanc's process, in the salt-glazing of earthenware, and in the manufacture of artificial manures.

3. *Sulphurous Acid Gas*.—The gas given off by burning sulphur is most suffocating and irritating. Its inhalation, even in a highly diluted state, may cause speedy death from spasmodic closure of the glottis.

4. *Nitrous vapours, or gaseous oxides of nitrogen* (except nitrous oxide), are given off from galvanic batteries excited by nitric acid; also in the process of etching on copper. They produce, when diluted, little immediate irritation, but are exceedingly dangerous, setting up extensive and fatal inflammation of the lungs.

5. *Ammonia gas* is highly irritant, but does not often prove fatal.

6. *Carbon dioxide gas* is heavier than atmospheric air, is totally irrespirable when pure, and is fatal when present in large quantities in respired air. It is given off from burning fuel, accumulates in pits and wells as choke-damp, and constitutes the deadly after-damp of coal-mines. It is also formed during alcoholic fermentation, and hence accumulates in partially filled vats in which fermented liquors are stored. When it is breathed in a concentrated state, death is almost instantaneous. Persons descending into wells foul with this gas sink down powerless, and are usually dead before they can be removed from the vitiated atmosphere. In these cases there is true asphyxia; but carbonic acid is also a narcotic gas. Persons exposed to an atmosphere partially composed of this gas, but not long enough to produce fatal results, are affected with stertorous breathings, oppression, flushed face, prominent eyes, swollen tongue and feeble pulse. The proper treatment is removal from the foul atmosphere, alternate cold and tepid douches to the chest, friction of the limbs and trunk, and artificial respiration. When animation is restored the patient should be put to bed and kept quiet, but should be carefully watched in case of relapse.

7. *Carbon monoxide gas* is given off by burning charcoal and other forms of fuel, mixed with carbonic acid. The poisonous effects of charcoal fumes are perhaps due rather to the more poisonous carbonic oxide than to the less poisonous carbonic acid. An atmosphere containing less than 1% of carbonic oxide would doubtless be fatal if breathed for many minutes. Carbonic oxide forms with haemoglobin, the red pigment of the blood, a bright scarlet compound. The compound is very stable, and the oxide cannot be displaced by atmospheric oxygen. Hence the blood after death from the inhalation of carbonic oxide is of a bright arterial hue, which it retains on exposure to air.

8. *Coal-gas* acts as an asphyxiant and narcotic. The appearances met with after death—more especially the fluid state of the blood—are similar to those observed after death from carbonic oxide gas, which is a constituent of coal-gas, and to which the chief effect of coal-gas may be due.

9. *Sulphuretted hydrogen gas* is highly poisonous by whatever channel it gains access to the body. In a concentrated form it produces almost instant death from asphyxia. Even in a diluted state it produces cold, nausea, vomiting and drowsiness. This may pass into insensibility with lividity and feeble respiration. The skin is cold and clammy; or bathed in perspiration. The red blood corpuscles are disintegrated. The treatment consists in removal from the contaminated atmosphere, friction to the surface

of the body, warmth, and the administration of stimulants. The inhalation of chlorine gas has been recommended on chemical grounds; but it must be remembered that chlorine is itself poisonous.

10. *Anesthetics*.—Nitrous oxide, or laughing gas, and the gases or vapours of other anæsthetic substances, such as chloroform, may, if improperly administered, produce death by asphyxia, and perhaps otherwise. Obviously, as a rule, medical assistance is at hand. The treatment consists in artificial respiration, and the use of galvanic current.

11. *Vapours of Hydrocarbons*.—The volatile vapours of the natural hydrocarbons known as benzoline, petroleum, &c., are poisonous when inhaled for lengthened periods. (T. S.)

POISSON, SIMÉON DENIS (1781-1840), French mathematician, was born at Pithiviers in the department of Loiret, on the 21st of June 1781. His father, Siméon Poisson, served as a common soldier in the Hanoverian wars; but, disgusted by the ill-treatment he received from his patrician officers, he deserted. About the time of the birth of his son, Siméon Denis, he occupied a small administrative post at Pithiviers, and seems to have been at the head of the local government of the place during the revolutionary period. Poisson was first sent to an uncle, a surgeon at Fontainebleau, and began to take lessons in bleeding and blistering, but made little progress. Having given promise of mathematical talent he was sent to the École Centrale of Fontainebleau, and was fortunate in having a kind and sympathetic teacher, M. Billy, who, when he speedily found that his pupil was becoming his master, devoted himself to the study of higher mathematics in order to follow and appreciate him, and predicted his future fame by the punning quotation from Lafontaine:—

"Petit Poisson deviendra grand
Pourvu que Dieu lui prête vie."

In 1798 he entered the École Polytechnique at Paris as first in his year, and immediately began to attract the notice of the professors of the school, who left him free to follow the studies of his predilection. In 1800, less than two years after his entry, he published two memoirs, one on E. Bezout's method of elimination, the other on the number of integrals of an equation of finite differences. The latter of these memoirs was examined by S. F. Lacroix and A. M. Legendre, who recommended that it should be published in the *Recueil des savants étrangers*, an unparalleled honour for a youth of eighteen. This success at once procured for Poisson an entry into scientific circles. J. L. Lagrange, whose lectures on the theory of functions he attended at the École Polytechnique, early recognized his talent, and became his friend; while P. S. Laplace, in whose footsteps Poisson followed, regarded him almost as his son. The rest of his career, till his death on the 25th of April 1840, was almost entirely occupied in the composition and publication of his many works, and in discharging the duties of the numerous educational offices to which he was successively appointed. Immediately after finishing his course at the École Polytechnique he was appointed *repetiteur* there, an office which he had discharged as an amateur while still a pupil in the school; for it had been the custom of his comrades often to resort to his room after an unusually difficult lecture to hear him repeat and explain it. He was made *professeur suppléant* in 1802, and full professor in succession to J. Fourier in 1806. In 1808 he became astronomer to the Bureau des Longitudes; and when the Faculté des Sciences was instituted in 1809 he was appointed *professeur de la mécanique rationnelle*. He further became member of the Institute in 1812, examiner at the military school at St Cyr in 1815, leaving examiner at the École Polytechnique in 1816, councillor of the university in 1820, and geometer to the Bureau des Longitudes in succession to P. S. Laplace in 1827. His father, whose early experiences led him to hate aristocrats, bred him in the stern creed of the first republic. Throughout the empire Poisson faithfully adhered to the family principles, and refused to worship Napoleon. When the Bourbons were restored, his hatred against Napoleon led him to become a Legitimist—a conclusion which says more for the simplicity of his character than for the strength or logic of his political creed. He was faithful to the Bourbons during the Hundred Days; in fact, was

¹ This prediction is sometimes attributed to Laplace

with difficulty dissuaded from volunteering to fight in their cause. After the second restoration his fidelity was recognized by his elevation to the dignity of baron in 1825; but he never either took out his diploma or used the title. The revolution of July 1830 threatened him with the loss of all his honours; but this disgrace to the government of Louis Philippe was adroitly averted by F. Arago, who, while his "revocation" was being plotted by the council of ministers, procured him an invitation to dine at the Palais Royale, where he was openly and effusively received by the citizen king, who "remembered" him. After this, of course, his degradation was impossible, and seven years later he was made a peer of France, not for political reasons, but as a representative of French science.

As a teacher of mathematics Poisson is said to have been more than ordinarily successful, as might have been expected from his early promise as a *repetiteur* at the École Polytechnique. As a scientific worker his activity has rarely if ever been equalled. Notwithstanding his many official duties, he found time to publish more than three hundred works, several of them extensive treatises, and many of them memoirs dealing with the most abstruse branches of pure and applied mathematics. There are two remarks of his, or perhaps two versions of the same remark, that explain how he accomplished so much: one, "La vie n'est bonne qu'à deux choses—à faire des mathématiques et à les enseigner;" the other, "La vie c'est le travail."

A list of Poisson's works, drawn up by himself, is given at the end of Arago's biography. A lengthened analysis of them would be out of place here, and all that is possible is a brief mention of the more important. There are few branches of mathematics to which he did not contribute something, but it was in the application of mathematics to physical subjects that his greatest services to science were performed. Perhaps the most original, and certainly the most permanent in their influence, were his memoirs on the theory of electricity and magnetism, which virtually created a new branch of mathematical physics. Next (perhaps in the opinion of some first) in importance stand the memoirs on celestial mechanics, in which he proved himself a worthy successor to P. S. Laplace. The most important of these are his memoirs "Sur les inégalités séculaires des moyens mouvements des planètes," "Sur la variation des constantes arbitraires dans les questions de mécanique," both published in the *Journal de l'École Polytechnique* (1809); "Sur la libration de la lune," in *Connaiss. d. temps* (1821), &c.; and "Sur la mouvement de la terre autour de son centre de gravité," in *Mém. d. l'Acad.* (1827), &c. In the first of these memoirs Poisson discusses the famous question of the stability of the planetary orbits, which had already been settled by Lagrange to the first degree of approximation for the disturbing forces. Poisson showed that the result could be extended to a second approximation, and thus made an important advance in the planetary theory. The memoir is remarkable inasmuch as it roused Lagrange, after an interval of inactivity, to compose in his old age one of the greatest of his memoirs, viz. that "Sur la théorie des variations des éléments des planètes, et en particulier des variations des grands axes de leurs orbites." So highly did he think of Poisson's memoir that he made a copy of it with his own hand, which was found among his papers after his death. Poisson made important contributions to the theory of attraction. His well-known correction of Laplace's partial differential equation for the potential was first published in the *Bulletin de la société philomatique* (1813). His two most important memoirs on the subject are "Sur l'attraction des sphéroïdes" (*Connaiss. d. temps*, 1820), and "Sur l'attraction d'un ellipsoïde homogène" (*Mém. d. l'Acad.*, 1835). In concluding our selection from his physical memoirs we may mention his memoir on the theory of waves (*Mém. d. l'Acad.*, 1825).

In pure mathematics, his most important works were his series of memoirs on definite integrals, and his discussion of Fourier's series, which paved the way for the classical researches of L. Dirichlet and B. Riemann on the same subject; these are to be found in the *Journal de l'École Polytechnique* from 1813 to 1823, and in the *Memoirs de l'Académie* for 1823. In addition we may also mention his essay on the calculus of variations (*Mém. d. l'Acad.*, 1833), and his memoirs on the probability of the mean results of observations (*Connaiss. d. temps*, 1827, &c.).

Besides his many memoirs Poisson published a number of treatises, most of which were intended to form part of a great work on mathematical physics, which he did not live to complete. Among these may be mentioned his *Traité de mécanique* (2 vols. 8vo, 1811 and 1833), which was long a standard work; *Théorie nouvelle de l'arcus capillaire* (4to, 1831); *Théorie mathématique de la chaleur* (4to, 1831); *Supplément* to the same (4to, 1837); *Recherches sur la probabilité des jugements en matières criminelles*, &c. (4to, 1837), all published at Paris. See F. Arago, *Biographie de Poisson*, read before the Académie des Sciences on the 16th of December 1850.

POISSY, a town of northern France, in the department of Seine-et-Oise, 17 m. W.N.W. of Paris, on the railway from Paris to Rouen. Pop. (1906), 6043. The church, supposed to have been built in the first half of the 12th century, and eventually restored under the direction of Viollet le Duc, is of special architectural interest, as affording one of the earliest and best examples of transition from the Romanesque to the Pointed style. The bridge of Poissy, a very ancient foundation, has been widened and modernized; of the mills which formerly bordered it one was known as Queen Blanche's. A statue of the painter J. L. E. Meissonier was erected in 1894, close to his house. Poissy supplied butchers' meat to Paris during six centuries, but in 1867 the market was removed to the metropolis. A handsome fountain stands in the old market-place. Distilling and the manufacture of chairs and flour-milling equipment are carried on and ragstone is quarried.

Poissy, the ancient *Pinciacum*, was the capital of the country of the Carnutes. In the time of Charlemagne it had a royal palace, where during the 9th century four national assemblies were held. Later it became a favourite residence of Blanche of Castille, and her son, afterwards St Louis, is supposed to have been born there. Philip the Fair gave the castle to the Dominicans, by whom it was completely transformed, and it was in the refectory of the abbey that the famous conference (see below) between the Roman Catholics and Protestants took place in 1561.

POISSY, COLLOQUY OF, a conference held in 1561 with the object of effecting a reconciliation between the Catholics and Protestants of France. It was initiated by Queen Catherine de' Medici, regent during the minority of her son Charles IX. In the policy of which it was the outcome she enjoyed the support of the Chancellor Michel de l'Hôpital and the lieutenant-general of the kingdom, Anthony of Navarre; while on the other hand the heads of the Catholic party had attempted to frustrate any form of negotiation. Theodore Beza from Geneva and Peter Martyr Vermigli from Zürich appeared at the colloquy; the German theologians to whom invitations had been despatched only arrived in Paris after the discussion was broken off. The conference was opened on the 9th of September in the refectory of the convent of Poissy, the king himself being present. The spokesman of the Reformed Church was Beza, who, in the first session, gave a lengthy exposition of its tenets, but excited such repugnance by his pronouncements on the Communion that he was interrupted by Cardinal Tournon. In the second session (Sept. 16) he was answered by the cardinal of Lorraine, who discharged his task with skill and moderation. On the motion, however, of Ippolito d'Este, the papal legate, exception was taken to the further conduct of the negotiations in full conclave; and a committee of twenty-four representatives, twelve from each party, was appointed—ostensibly to facilitate a satisfactory decision. On the Catholic side, as was speedily demonstrated, there existed no sort of tendency to conciliation. On the contrary, the cardinal of Lorraine, by his question whether the Calvinists were prepared to sign the Confession of Augsburg, attempted to sow dissension between them and the Lutheran Protestants of Germany, on whose continued support they calculated. The Catholic delegates, moreover, discovered a powerful auxiliary when Lainez, the general of the Jesuit order, which had been admitted into France a short time previously, entered the debate; and the acrimony with which he opposed the Protestants was of material service in clarifying the situation. Still a further reduction was made in the number of members, and a small residuum consisting of five Catholics and five Protestants undertook the task of devising a formula on which the two churches might unite with regard to the question of the Communion. Their difficult labours even seemed on the point of success when the assemblage of prelates refused assent, and the conference broke up on the 28th of October—a result which barred the way to a pacific understanding with the Huguenots.

See H. Küppfel, *Le Colloque de Poissy* (Paris, 1868); E. Lacheinmann in Herzog-Hauck, *Realencyclopædie f. protest. Theologie* (3rd ed., 1904), xv. 497.

POITIERS, a town of western France, formerly the capital of Poitou, and now the chief town of the department of Vienne, 61 m. S.S.W. of Tours on the railway to Bordeaux. Pop. (1906), town, 31,532; commune, 39,302. Poitiers is situated at the junction of the Boivre with the Clain (a tributary of the Loire by the Vienne), and occupies the slopes and summit of a plateau which rises 130 ft. above the level of the streams by which it is surrounded on three sides. The town is picturesque; and its streets are interesting for their remains of ancient architecture, especially of the Romanesque period, and the memories of great historical events. Blossac park, named after the intendant of the "generality" of Poitiers (1753-1786), and situated on the south side of the town, and the botanical garden on the north-east, are the two principal promenades. Till 1857 Poitiers contained the ruins of a Roman amphitheatre more extensive than that of Nîmes; remains of Roman baths, constructed in the 1st and demolished in the 3rd century, were laid bare in 1877; and in 1879 a burial-place and the tombs of a number of Christian martyrs were discovered on the heights to the south-east—the names of some of the Christians being preserved in paintings and inscriptions. Not far from these tombs is a huge dolmen (the "Pierre Levée"), 22 ft. long, 16 ft. broad and 6 or 7 ft. high, around which used to be held the great fair of St Luke.

The cathedral of St Peter, begun in 1162 by Henry II. of England and Eleanor of Guienne on the ruins of a Roman basilica, and well advanced by the end of the 12th century, is a building in the Romanesque and Early Gothic style, the latter predominating. It consists of three naves almost equal in height and width, both of which decrease towards the west, thus enhancing the perspective. Its length is 308 ft., and the keystone of the central vaulted roof is 89 ft. above the pavement. There is no apse, and the exterior generally has a heavy appearance. The principal front, the width of which is excessive in proportion to its height, has unfinished side-towers 105 and 110 ft. in height, begun in the 13th century. Most of the windows of the choir and the transepts preserve their stained glass of the 12th and 13th centuries; the end window, which is certainly the first in the order of time, contains the figures of Henry III. and Eleanor. The choir stalls, carved between 1235 and 1257, are among the oldest in France. The church of St Jean near the cathedral is the most ancient Christian monument in the country. Built as a baptistery in the first half of the 4th century, it was enlarged in the 7th century, since when it has suffered little structural alteration. It contains frescoes of the 12th century and a collection of tombs of the Merovingian period. The church of St Hilaire was erected at the close of the 4th century over the tomb of the celebrated bishop. At first an oratory, it was rebuilt on a larger scale by Clovis, and afterwards became, in the 10th, 11th and 12th centuries, a sumptuous collegiate church, of which the nave was flanked by triple aisles and surmounted by six cupolas. Great damage was done to it in the Wars of Religion and the French Revolution, and the façade was entirely rebuilt in the 19th century. The confessional oratory under the choir contains the relics of St Hilary and a Christian sarcophagus of the 4th century. The church of St Radegonde, a great resort of pilgrims, commemorates the consort of Clotaire (d. 587), and preserves in its crypt the tomb of Radegonde, who founded at Poitiers the abbey of the Holy Cross, and two others reputed to be those of St Agnes and St Disciola. The choir and tower above the entrance are of the 11th century, while the nave (late 12th century) is in the Angevin style. In a recess in the nave known as the *Chapelle du Pas de Dieu*, there is a footprint which tradition asserts to be that of Christ, who appeared in a vision to St Radegonde. Notre-Dame la Grande, which dates from the close of the 11th century, and represents a collegiate church of one or two hundred years older, has a sculptured Romanesque façade rivalled in richness only by that of St Pierre of Angoulême. The first stone of the church of Montierneuf (*Monasterium Novum*) was laid in 1077 by William VI., duke of Aquitaine and count of Poitiers, who is buried within its walls; and the choir (in the 13th century

modified by the erection of a "lantern") was solemnly consecrated by Urban II. in 1096. Mutilated about 1640 and during the Revolution, the building was partly restored between 1850 and 1860. The tower of St Porchaire, a precious remnant of 11th-century architecture, was restored in the 19th century under the auspices of the well-known *Société des antiquaires de l'ouest*.

Among the secular buildings the first place belongs to the law courts, formerly the palace of the dukes of Aquitaine and counts of Poitiers, and rebuilt between the 12th and the 15th century. The Salle des Pas Perdus forms a fine nave 160 ft. long by 56 ft. wide, with a vaulted wooden roof. The southern wall is the work of duke Jean de Berry (d. 1416), brother of Charles V.; above its three vast fireplaces are mullioned windows filled with stained glass. The Maubergeon tower attached to the palace by the same duke represented the feudal centre of all the lordships of the countship of Poitiers. The house known as the *présidit* or provost's mansion, built about 1500, has a fine façade flanked by turrets, and there are other houses of the 15th, 16th and 17th centuries. In the Hôtel de Ville, erected between 1869 and 1876, are museums of natural history and painting. The museum of the *Antiquaires de l'ouest* occupies the chapel and the great hall of the old university, adjoining the old Hôtel de Ville; it is a valuable collection comprising Roman antiquities, Merovingian sculptures, medals, a fine Renaissance fireplace, &c. The building devoted to the faculties also contains the library. The municipal records are very rich in charters of Eleanor of Guienne, Philip Augustus, Alphonse of Poitiers, &c.

Poitiers is the seat of a bishop, a prefect, a court of appeal and a court of assizes, and centre of an educational division (*académie*), and has tribunals of first instance and of commerce, a board of trade arbitration, a chamber of commerce and a branch of the Bank of France. Its educational institutions comprise a university with faculties of law, science and letters, and a preparatory school of medicine and pharmacy, a school of theology, training colleges for both sexes, a lycée for boys and a school of fine art. Trade is in farm produce, wine, cattle, wool, honey, goose-quills and leather. The industries include the preparation of goose-skims, printing, tanning, and the manufacture of brushes, paint and candles.

Poitiers, called *Limonum* at the time of the Roman Conquest, afterwards took the name of its Gallic founders, the Pictones or Pictavi. Christianity was introduced in the 3rd century, and the first bishop of Poitiers, from 350 to 367, was St Hilarius. Fifty years later the city had fallen into the hands of the Arian Visigoths, and became one of the principal residences of their kings. Alaric II., one of their number, was defeated by Clovis at Vouillé, not far from Poitiers, in 507, and the town became a part of the Frankish dominion. This was the first occasion on which the peoples of northern and southern Gaul met in conflict in the neighbourhood of the town which was destined to see them so frequently join battle. By his victory in 732 over the Mahomedans at Moussais-la-Bataille in this region, Charles Martel proved the saviour of Christendom. Eleanor of Guienne frequently resided in the city, which she embellished and fortified, and in 1199 entrusted with communal rights. Alphonse of Poitiers, at a plenary court held in 1241 in the great hall of the Palais de Justice, received the homage of his numerous vassals. After the battle of Poitiers in 1356 (see below), Poitou was recognized as an English possession by the treaty of Brétigny (1360); but by 1373 it was recovered by Bertrand Du Guesclin. It was at Poitiers that Charles VII. was proclaimed king (1432); and he removed thither the parlement and university of Paris, which remained in exile till the English withdrew from the capital in 1436. During this interval (1429) Joan of Arc was subjected to a formal inquest in the town. The university was founded in 1432. Calvin had numerous converts at Poitiers. Of the violent proceedings which attended the Wars of Religion the city had its share. In 1569 it was defended by Gui de Dailion, comte du Lude, against Gaspard de Coligny, who after an unsuccessful bombardment retired from the siege at the end of even weeks.

Counts of Poitiers.—In the time of Charlemagne the countship of Poitiers, which was then a part of the kingdom of Aquitaine, was represented by a certain Abbon. Renouf (Ranulph), who was created count of Poitiers by the emperor Louis the Pious in 839, was the ancestor of a family which was distinguished in the 9th and 10th centuries for its attachment to the Carolingian dynasty. One of his successors, Ebles the Bastard (d. 935), took the title of duke of Aquitaine; and his descendants, who bore the hereditary name of William, retained the same title. William IV., Flétrebrace, joined Hugh Capet, his brother-in-law, in 987. William V. the Great (993-1030) was a patron of letters, and received from the Italian lords the offer of the imperial crown after the death of the emperor Henry II. in 1024. William IX. (1086-1127) went on crusade in 1100, and had violent quarrels with the Papacy. His son William X. (1127-1137) sided with the anti-pope Anacletus against Innocent II. In accordance with the dying wishes of William X. his daughter Eleanor was married in 1137 to Louis, the son of Louis VI. of France. Sole heiress of her father, she brought her husband a large dowry, comprising Poitou, Saintonge, Anjou, a part of Touraine and Berry, Marche, Angoumois, Périgord, Auvergne, Limousin, Bordelais, Agenois and Gascony. After the dissensions between Louis VII. and Eleanor had resulted in a divorce in 1152, Eleanor married the count of Anjou, Henry Plantagenet, who became king of England as Henry II. The west of France thus passed into the hands of England, a transfer which gave rise to long wars between the two kingdoms. Philip Augustus reconquered Poitou in 1204, and the province became in succession an apanage of Alphonse, son of Louis VIII., in 1241; of Philip the Tall, son of Philip the Fair, in 1311; of John, son of Philip of Valois, in 1344; and of John, duc de Berry, son of John the Good, in 1356; and passed to the dauphin John (1416) and Charles (1417), sons of Charles VI. When Charles VII. ascended the throne he finally united the countship of Poitiers to the Crown.

See P. Guérin, *Recueil des documents concernant le Poitou* (Paris, 1880-1906); and A. Richards, *Histoire des comtes de Poitou* (Paris, 1903).

Battle of Poitiers.—This battle, fought on the 19th of September 1356 between the armies of King John of France and Edward the "Black Prince," was the second of the three great English victories of the Hundred Years' War. From Bordeaux the prince had led an army of his father's Guienne vassals, with which there was a force of English archers and men-at-arms, into central France and had amassed an enormous host. King John, hitherto engaged against the army of John of Gaunt duke of Lancaster, in Normandy, hurried south to intercept the raiding army and to bar its homeward road. The Black Prince, by forced marching, was able to slip past the French, but reaching Maupertuis, 7 m. south-east of Poitiers, with the king's army in chase, he found himself compelled to choose between fighting and abandoning his spoil. He chose the former course, in spite of the enemy's great superiority in numbers (16,000 to 6500), and in order to give his trains time to draw off took up a defensive position on the 18th of September, with a slight hollow in front and a wood behind, between the Poitiers-Bordeaux main road and the River Mausson.¹ John, instead of manoeuvring to envelop the English, allowed the Cardinal Talleyrand de Périgord to attempt to negotiate a peace. This proving vain, the French army attacked without any attempt at manoeuvre or reconnaissance, and on a front so narrow that the advantage of superior numbers was forfeit. Moreover, King John ordered all but the leading line to dismount and to attack on foot (tactics suggested by the success on the *defensive* of the dismounted English men-at-arms at Crecy and the Scots at Bannockburn), and thus condemned the best part of his army to a fatiguing advance on foot across difficult country in full armour.

The French artillasters, who might have crushed the relatively

¹ The view adopted is that of Professor Oman. *Art of War. Middle Ages*, p. 631.

few English archers present, were mingled with the 300 picked mounted men in first line, but, as the latter charged, their advance masked the fire of the arblasters in the first few seconds, besides leaving the other, dismounted, lines far in rear. Thus the first attack on the Black Prince's line, which was greatly strengthened by trees and hedges in front of it, was promptly brought to a standstill by the arrows of the archers lining a hedge which overlooked the hollow in front; and the earl of Oxford hastily drawing out a body of archers beyond the defenders' left, into the low-lying ground of the Maussion valley, completed their rout by firing up the hollow into their flank. But it was not so easy to deal with the second line of dismounted men-at-arms, led by the dauphin, which was the next to arrive on the French side. The hedge indeed was held, and the assailants, unable to advance beyond the hollow, gave way, but to achieve this the prince had to use all but 400 of his men. Had the third body of the French advanced with equal spirit the battle would probably have ended there and then, but the duke of Orleans, who commanded it, was so demoralized by the retirement of the dauphin's division that he led his whole force off the field without striking a blow. Thereupon the king himself advanced furiously with the fourth and last line, and as it came on the situation of the English seemed so desperate that the prince was advised to retreat. But his determined courage was unshaken; seeing that this was the last attack he put his reserve into line, and rallying around this nucleus all men who could still fight, he prepared not only to repulse but to counter-attack the French. He despatched a small force under the Captal de Buch to ride round the flank of the enemy and to appear in their rear at the crisis of the fight. Though a medieval knight, he knew as well as Napoleon at Arochs that when the moral force of both sides has passed its culminating point even a materially insignificant threat serves to turn the balance. And so it fell out. When both lines were fighting hand-to-hand, the fifty horsemen of the Captal de Buch appeared in rear of the French. The front ranks fought on, but the rear of the French melted away rapidly, and at last only a group of the bravest, with King John and his son Philip, a boy of fourteen, in their midst, were left. This band continued their hopeless resistance for a time, but in the end they were killed or captured to a man. The rest of the French army, totally dispersed, was pursued by the victors until nightfall. Two thousand five hundred of the French, 2000 of them knights and men-at-arms, were killed, including the constable, one of the marshals, the standard-bearer and six other great lords. The prisoners included the king and his son Philip, the other marshal and 25 great lords, and 1033 knights and men-at-arms as well as 500 others.

POITOU, one of the old provinces of France, which also formed one of the great military governments of the kingdom, was bounded on the N. by Brittany, Anjou and Touraine; on the S. by Angoumois and Aunis; on the E. by Touraine, Berri and Marche; and on the W. by the ocean. It was divided into Lower Poitou, which corresponded to the modern department of La Vendée, and Upper Poitou, now split into the departments of Deux-Sèvres and Vienne. The principal towns in Upper Poitou were Poitiers the capital, Mirebeau, Châtelleraut, Richelieu, Loudun, Thouars, Mauléon, Parthenay, Niort, &c.; and in Lower Poitou Fontenay-le-Comté, Maillezais, Luçon and Roche-sur-Yon. Île d'Yeu or Île-Dieu and Noirmoutier belonged to the province. Ecclesiastically, Poitou was a diocese which was broken up in 1317 to form two new dioceses of Luçon and Maillezais; the seat of the latter was transferred in the 17th century to La Rochelle. For the administration of justice, Poitou was attached to the parlement of Paris. After 778 it formed part of the domain of the counts of Poitiers (q.v.). Poitou (Poictou, Pictavia) takes its name from the Pictones or Pictavi, a Gallic nation mentioned by Caesar, Strabo and Ptolemy, and described by Strabo as separated from the Namnetes on the north by the Loire. It formed part of the territory known as Aquitaine (q.v.).

For the history see the *Mémoires* of the Société des Antiquaires de l'Ouest (1835 sqq.) and the documents published by the Archives

historiques du Poitou (1872 sqq.); also the *Dictionnaire topographique de la Vienne*, by L. Rédet (1881).

POKEBERRY, POKEWEEED (from the American-Indian *pocan*, applied to any plant yielding a red or yellow dye), in botany, the popular name of *Phytolacca decandra*, a strong-smelling perennial herb, a native of North America, with ovate-lanceolate sharp-pointed leaves, racemes of small greenish-white flowers and flattish berries nearly $\frac{1}{2}$ in. in diameter, which contain a crimson juice. The young asparagus-like shoots are sometimes used as a pot-herb, but the roots are poisonous. The plant is often cultivated in Europe, and has become naturalized in the Mediterranean region.

POKER, a game at cards. By most writers its origin has been ascribed to *Il Frusso*, an Italian game of the 15th century, from which the game of *Primiera*, called in Spain *Primera*, and *La Prima* in France, in which country it was elaborated into *L'Ambigo* or *Le Meid*. In England the game was played under the name of *Post and Pair*, of which the modern *Brag* is only a variation. But Mr R. F. Foster proves that, though poker is probably a descendant of *Primera*, and perhaps of a much more ancient Persian game called *As ras*, it is not a development of the English *Brag*, but was introduced from France into the colony of Louisiana, the name being merely an English mispronunciation of *Poque*, a game described as early as 1718 in the *Académie universelle des jeux*, and still played in Germany under the name *Pochen*. The earliest mention of the game in America is in G. B. Zieber's *Exposure of the Arts and Miseries of Gambling* (1843), and it is probable that poker was generally played on the Mississippi steamboats as early as 1830, twenty cards being used, "full-deck poker" with 52 cards being invented later. "Draw-poker" was introduced about 1860.

Poker is played for money stakes, markers or "chips" of different value being used. These are either divided equally among the players, or, more usually, one player acts as banker and sells chips to the other players, redeeming them at the end of the game. There are several varieties of the game, but *Draw Poker*, played by from 2 to 6 or even 7 persons with a pack of 52 cards, is the most popular. The player who wins the cut for deal shuffles the pack, which is then cut by the player at his right. He then deals five cards, one by one, to each player. If a card is faced during the deal the player must accept it; if two are exposed a new deal must ensue. Before the deal is complete the player at the dealer's left, who is said to *hold the ace*, and is called "the ace," places (or *puts up*) on the table in front of him half the stake for which he wishes to play. This is called *blind*. The player at the ace's left then looks at his hand and announces whether he will play. If his hand seems too weak he throws his cards away face-down and "drops out" of the game. If he elects to play he puts up his *ante*, which is twice the amount of the *blind*. The other players, including the dealer, then either come in, *i.e.* elect to play, each putting up his *ante*, or, deeming their hands worthless, drop out. The ace, who has the last say, may then himself drop out, forfeiting his half-stake already put up, or he may come in and *make good his ante*, *i.e.* put up his unpaid half of the *blind*. Each player in his turn has the privilege of increasing the stake to any amount not exceeding the limit,¹ which is always agreed upon before the game begins. Thus, if the limit is £1, and the ace has put up 6d. as his *blind*, any player may, when his turn comes to declare whether he will play, say, "I play and make it 10s. (or a sovereign) more to draw cards," at the same time placing the *ante* plus 10s. (or a sovereign) in the middle of the table. Thereupon all the other players, each in turn, must *see the raise*, *i.e.* pay in the additional sum, or drop out of the game, forfeiting what they have already paid into the pool. The "ace" being the last to complete, is in the best position to raise, as a player who has already completed is less likely to sacrifice his stake and withdraw from the game. On the other hand each player

¹ "Table stakes" means playing strictly for cash; "unlimited" explains itself, although even when this is the rule a certain high limit is pretty generally observed.

has the right, in his turn, after paying the extra stake called for, of raising it further on his own account, and this goes on until the players who have not dropped out have paid an equal sum into the pool and no one cares to raise further. Each player then throws away as many of his five cards as he chooses and receives from the dealer new ones in their place. In this supplementary deal no player may accept a faced card, but receives one in its place after all the other players have been served. The number of new cards taken by each one should be carefully noted by the other players, as it gives a valuable clue to the probable value of his hand. The following list shows the value of hands, beginning with the lowest.

1. *One Pair* (accompanied by three cards of different denominations). If two players each hold a pair, the higher wins; if similar pairs (e.g. a pair of kings each) then the next highest card wins.
 2. *Two Pairs*.
 3. *Triplets or Threes of a Kind* (e.g. three kings, accompanied by two other cards not forming a pair).
 4. *Straight*, a sequence of five cards, not all of the same suit. Sometimes, but very rarely, these straights are not admitted. An ace may either begin or end a straight. For example: ace, king, queen, knave and 10 is the highest straight; 5, 4, 3, 2, and ace is the lowest. An ace cannot be in the middle. For example, 3, 2, ace, king, queen is not a straight.
 5. *Flush*, five cards of the same suit, not in sequence. If two flushes are held, that containing the highest card wins; if the highest cards are similar, the next highest wins, &c.
 6. *Full, or Full House*, meaning three cards of the same denomination together with a pair; e.g. three sixes and a pair of fours. If more than one player holds a full, the highest triplet wins.
 7. *Fours*, or four cards of the same denomination; e.g. four queens, which beat four knaves and under.
 8. *Straight Flush*, a sequence of five cards all of the same suit; e.g. knave, 10, 9, 8, 7, of hearts.
 9. *Royal Flush*, the highest possible straight flush; e.g. ace, king, queen, knave and 10 of spades.
- If no player holds at least one pair, then the hand containing the highest card wins.

Each player having received the new cards called for, the betting is opened by the player sitting at the age's left, should he consider his hand worth it; otherwise he throws down his cards and is out of the game, and the next player (whom we will call C) makes the first bet, which may be of any amount up to the limit, but is usually a small one, with a view to later developments. The next player, D, either drops out, *trails*, i.e. puts up the amount bet by C (also called *seeing and calling*), or raises C's bet; in other words puts in the amount bet by C plus as much more (within the limit) as he cares to risk. This raise on D's part means either that he thinks he holds a better hand than C, or that he is trying to frighten C out. The last manoeuvre illustrates the principle of the *bluff*, the most salient characteristic of the game of Poker. If C, with two small pairs in the hand, bets half a crown, and D, with a hand of no value whatever, covers, or sees C's bet and raises it to a sovereign, it is very likely that C will throw down his cards rather than risk a sovereign on his own by no means strong hand. In this case C has been bluffed by D, who, without even having to show his cards, wins the pool, although intrinsically his hand was far inferior to C's. The ability to bluff successfully depends upon self-command, keen observation, judgment and knowledge of character, so as to attempt the bluff when the bluffer is sure that there are no very strong hands out against him. Other wise he will surely be called in his turn, and, having nothing of value, will lose the pool, besides suffering the ignominy of throwing away his money for nothing.

Two players with strong hands will often raise each other's bets repeatedly, until one of them calls the other, upon which the hands are shown and the stronger wins. The complete hands of the caller and the called must be shown. The common practice of throwing away unshown, for purposes of concealment, a losing hand that has called is illegal. No player who is not called is obliged to show his hand, so that the company is often in doubt whether or not the winner has bluffed. When two hands are of exactly equal value the pool is divided.

The game is often varied by a player going blind, i.e. raising the ante before the deal. Another variation is straddling the

blind. This is done by the player sitting next the age, who puts up twice the amount of the blind with the words "I straddle." This has the effect of doubling the stake, as every player must then pay twice the amount of the straddle (instead of the blind) in order to play. The straddle may be straddled again in its turn if the aggregate amount does not pass the limit. The straddle does not carry with it the privilege of betting last, but merely raises the amount of the stake.

The regular Draw-Poker game is usually varied by occasional *Jack-Pots*, which are played once in so many deals, or when all have refused to play, or when the player deals who holds the *luck*, a marker placed in the pool with every jack-pot. In a jack-pot each player puts up an equal stake and receives a hand. The pot must then be opened by a player holding a hand of the value of a pair of knaves (jacks) or better. If no player holds so valuable a hand the deal passes and each player adds a small sum to the pot or pool. When the pot is opened the opener does so by putting up any sum he chooses, within the limit, and his companions must pay in the same amount or "drop." They also possess the right to raise the opener. The new cards called for are then dealt and the opener starts the betting, the play proceeding as in the regular game. If *Progressive Jack-Pots* are played, the minimum value of the opening hand is raised one degree every deal in which the pot is not opened. Thus the opening hand must in the first deal be at least a pair of knaves; but if the pot is not opened the minimum for the second deal is a pair of queens, for the third a pair of kings, &c. Jack-Pots were introduced about 1870.

Straight Poker, or Bluff, is played without drawing extra cards. It was the only variety of the game played, although 52 cards are now used instead of 20, as formerly. The first dealer is provided with a marker called a *luck*, and having, before dealing, put up the antes of all the players, passes the *luck* to the next dealer, who must in his turn ante for all when he deals. The rules for betting, raising, &c., are the same as at Draw-Poker. The hands, of course, average smaller.

Stud-Poker is played like Draw-Poker, except that there is no draw and, in dealing, the first card only is dealt face down, the rest being exposed. Each player in turn looks at his turned card and makes his bet or raise. A common variation of Stud-Poker consists in stopping the deal after two cards, one face up and the other face down, have been dealt, and betting on those two cards. A third card is then dealt and betting again takes place, the process being repeated after the fourth and fifth cards have been dealt, the value of the different hands changing with each added card. A player failing to "stand" any raise must retire from that pot.

Whiskey-Poker is also played without a draw. An extra hand, called the *widow*, is dealt to the table face down. The first bettor then examines his hand and has the option of taking up the widow and placing his own hand on the table face up in its place, or of passing and allowing the following players in turn the choice. After an exposed hand has been laid on the table in place of the widow the next player may either take up one card from the new widow replacing it with one from his own hand, or he may exchange his entire hand for the widow, or he may knock on the table. If he knocks every other player in turn may exchange one card or his whole hand, and the betting then begins, or there may be an agreement that the best hand wins from all the rest, or that the poorest hand pays a chip to the pool.

Technical Terms.

Big Dog.—Ace high and nine low; not usually played. If played it beats a *Little Dog*.

Blaze.—Five court cards; not usually played. If played it beats any two pairs.

Bobtail.—Four cards of a flush or straight, the fifth card not filling.

Bone.—The smallest counter or chip.

Buck.—A marker, to show when a jack-pot is to be played, viz. when it is the holder's deal.

Burnt Card.—Card on the bottom of the pack turned up to prevent being seen.

Chips.—Counters.

Cold Feet.—Any excuse of a winner for leaving the game before the time agreed upon.

Deadwood.—The discard pile.

Deck.—Pack.

Fallen.—Adding chips and a jack-pot after a failure to open.

Freeze Out.—A game in which a player having lost a certain agreed capital must stop playing.

Inside Straight.—Intermediate straight, e.g. 2, 3, 5, 6

Killer.—Hand with no pair and no card above the nine; seldom played.

Kitty.—A fund, to pay for cards or refreshments, made by taking a chip from each jack-pot, or paid by a winner holding a valuable hand.

Little Dog.—Deuce low and seven high; not usually played. When played it beats a straight.

Milking.—Shuffling by taking a card from the top and one from the bottom of the pack with the same movement.

Misgris.—Poker with the joker added; the joker may be called any card the holder chooses.

Monkey Flush.—Three cards of a flush.

Natural Jacks.—Jack-pots played because there has been no ante in the previous deal.

Openers.—A hand on which a jack-pot may be opened.

Pat Hand.—A hand to which no card is drawn.

Pool.—The chips in the middle of the table.

Show-down.—Laying the hands face-up on the table after a call.

Show.—Part of a pool to which a player is entitled who has bet as long as his capital lasted but is not able to stand further raises. If his hand is the best he wins whatever was in the pool at the time when he put into it the last of his capital.

Sky.—Not having put up the jack-pot ante.

Spilling.—Having opened a jack-pot with one pair, and holding four other cards of one suit, to throw away one of the pair on the chance of making a flush.

Sweeten.—Chipping to a jack-pot after a failure to open.

Triplets.—Three of a kind.

Under the Gun.—The first player to bet.

Whangdoodle.—Compulsory round of jack-pots, usually agreed upon to follow a very large hand.

Widow.—An extra hand dealt to the table, as in Whiskey-Poker. See *Practical-Poker*, by R. F. Foster (1904), the most authoritative work.

A very important attribute of a successful poker player is sound judgment in discarding, and this is principally based on the following mathematical table of approximate chances.

To improve any hand in the draw, the chances are:—

Having in Hand	To make the Hand below.	The Chance is
1 pair	To get two pairs (3-card draw)	1 in 4½
1 pair	To get three of a kind (3-card draw)	1 in 9
1 pair	To improve either way average value	1 in 3
1 pair and 1 odd card	To improve either way by drawing two cards	1 in 7
2 pairs	To get a full hand drawing one card	1 in 12
3's	To get a full hand drawing two cards	1 in 15½
3's	To get four of kind drawing two cards	1 in 23½
3's	To improve either way drawing two cards	1 in 9½
3's and 1 odd card	To get a full hand by drawing one card	1 in 15½
3's and 1 odd card	To improve either way by drawing one card	1 in 11½
4 straight	To fill when open at one end only or in middle as 3 4 6 7, or A 2 3 4	1 in 11½
4 straight	To fill when open at both ends as 3 4 5 6	1 in 6
4 flush	To fill the flush drawing one card	1 in 5
4-straight flush	To fill the straight flush drawing one card	1 in 23½
3-card flush	To make a flush drawing two cards	1 in 24

Of course these chances are somewhat improved by the fact that, in actual play, pairs and threes are, on account of careless shuffling, apt to be together more or less.

POLA (Gr. Πόλις or Πόλις; Slovene, *Pulj*), a seaport of Austria, in Istria, 86 m. S. of Trieste by rail. Pop. (1900), 45,052. It is the principal naval harbour and arsenal of the Austro-

Hungarian monarchy, and is situated near the southern extremity of the peninsula of Istria. It lies at the head of the Bay of Pola, and possesses a safe and commodious harbour almost completely landlocked. An extensive system of fortifications, constructed on the hills, which enclose the harbour, defends its entrance, while it also possesses a good roadstead in the large channel of Fasana. This channel separates the mainland from the Brionian Islands, which dominate the entrance to the bay. The harbour has an area of 3.32 sq. m. and is divided into two basins by a chain of three small islands. The inner basin is subdivided by the large Olive Island into the naval harbour, lying to the south, and the commercial harbour, lying to the north. The Olive Island is connected with the coast by a chain-bridge, and is provided with wharfs and dry and floating docks. The town proper lies opposite the Olive Island, round the base of a hill formerly crowned by the Roman capitol and now by a castle from the 17th century. Besides the castle the chief buildings are the cathedral, dating from the 15th century; the new garrison church, completed in 1898 in the Basilica style, with a fine marble façade; the Franciscan convent dating from the 13th century, and now used as a military magazine; the huge infantry barracks; and the town-hall, dating from the beginning of the 14th century. To the south-west, along the coast, extends the marine arsenal, a vast and well-planned establishment possessing all the requisites for the equipment of a large fleet. It contains an interesting naval museum, and is supplemented by the docks and wharves of the Scoglio Olivii. The artillery laboratory and the powder magazine are on the north bank of the harbour. Behind the arsenal lies the suburb of San Policarpo, almost exclusively occupied by the naval population and containing large naval barracks and hospitals. In the middle of it is a pleasant park, with a handsome monument to the emperor Maximilian of Mexico, who had been a rear-admiral in the Austrian navy. To the north, between San Policarpo and the town proper, rises the Monte Zaro, surmounted by an observatory and a statue of Admiral Tegethoff. Pola has no

manufacture outside of its naval stores, but its shipping trade is now considerable, the exports consisting of fish, timber and quartz sand used in making Venetian glass, and the imports of manufactured and colonial wares. To many people, however, the chief interest of Pola centres in its fine Roman remains. The most extensive of these is the amphitheatre built in A.D. 198-211, in honour of the emperors Septimius Severus and Caracalla, which is 79 ft. high, 400 ft. long and 320 ft. wide, and could accommodate 20,000 spectators. It is remarkable as the only Roman amphitheatre of which the outer walls have been preserved intact; the interior, however, is now completely bare—though the arrangements for the naumachiae, or naval contests, can still be traced. The oldest Roman relic is the fine triumphal arch of the Sergii, in the Corinthian style, erected soon after the battle of Actium; and of not much later date is the elegant and well-preserved temple of Augustus and Roma erected in the year 19 B.C. Among the other antiquities are three of the old town gates and a fragment of a temple of Diana.

The foundation of Pola is usually carried back to the mythic period, and ascribed to the Colchian pursuers of Jason and the Argonauts. In all probability it was a Thracian colony, but its verifiable history begins with its capture by the Romans in 178 B.C. It was destroyed by Augustus on account of its espousal of the cause of Pompey, but was rebuilt on the intercession of his daughter Julia, and received (according to Pliny) the name of Pietas Julia. It became a Roman colony either

under the triumviri or under Octavian, and was mainly important as a harbour. It seems to have attained its greatest prosperity about the time of the emperor Septimius Severus (193-211 A.D.), when it was an important war harbour and contained 35,000 to 50,000 inhabitants. At a later period Pola became the capital of the margraves of Istria, and was captured by the Venetians in 1148. It was several times captured and plundered by the Genoese, and recaptured by the Venetians. In 1379 the Genoese, after defeating the Venetians in a great naval battle off the coast, took and destroyed Pola, which disappears from history for the next four hundred and fifty years. It remained under Venetian supremacy down to 1797, and has been permanently united with Austria since 1815. In 1848 a new era began for Pola in its being selected as the principal naval harbour of Austria.

See Th. Mommsen in *Corp. inscr. latin.* v. 3 sqq. (Berlin, 1883). T. G. Jackson, *Dalmatia, the Quarnero and Istria*, vol. iii. (Oxford, 1887).

POLABS (*Pol=on, .Laba=Elbe*), the Slavs (*q.v.*) who dwelt upon the Elbe and eastwards to the Oder. Their chief tribes were the Vagri in Holstein, the Bodrii or Obotritae in Mecklenburg, the Ljutiči or Wiltzi in western Pomerania, the Sprewans on the Spree and the Glomači or Dalemintsi in Saxony. Except the Lithuanians they were the last Europeans to be christianized; their chief sanctuary was at Arcona on the Isle of Rügen. They were converted and conquered by the 12th century and systematically germanized. By the 17th century Slavonic survived only in a tiny patch in the east of Hanover about Lüchow, where a few words were still understood at the beginning of the 19th century. The population of the district still goes by the name of Wends (*q.v.*). The chief remains of the language are a paternoster, a few phrases and a short vocabulary written down by Pastor Chr. Henning (*c.* 1700), and the diary of J. Paruns Schultze (*d.* 1734). These were edited by A. Hillerding (*St Petersburg*, 1856), and a grammar was published there by A. Schleichner (1871). M. Porzeinski and Fr. Lorentz are the chief later authorities. Polabian agrees mostly with Polish and Kašube with its nasalized vowels and highly palatalized consonants. It had, however, long vowels and a free accent. The remains of it are most corrupt, having been written down when the language was full of Low German by people who did not know Slavonic.

POLACCA, the Italian name for a three-masted merchant vessel, formerly common in the eastern waters of the Mediterranean. The masts were of one piece and the sails were square or lateen-shaped. The name appears in various forms in other languages, e.g. Fr. *polaque* or *polacre*, Sp. *polacra*, Du. *polaak* or Ger. *Polack*, and certainly means Polish, although there is no explanation to be found for any connexion between Poland and such a Mediterranean vessel.

POLAND (Polish *Polska*, Ger. *Polen*), (see POLAND, RUSSIAN, below), a country of Europe which till the end of the 18th century was a kingdom extending (with Lithuania) over the basins of the Warta, Vistula, Dwina, Dnieper and upper Dniester, and had under its dominion, besides the Poles proper and the Baltic Slavs, the Lithuanians, the White Russians and the Little Russians or Ruthenians.

We possess no certain historical data relating to Poland till the end of the 10th century. It would seem, from a somewhat obscure passage in the chronicle compiled from older sources by Nestor, a monk of Kiev (*d. c.* 1115), that the progenitors of the Poles, originally established on the Danube, were driven from thence by the Romans to the still wilder wilderness of central Europe, settling finally among the virgin forests and impenetrable morasses of the basin of the upper waters of the Oder and the Vistula. Here the Lechici, as they called themselves (a name derived from the mythical patriarch, Lech), seemed to have lived for centuries, in loosely connected communities, the simple lives of hunters, herdsmen and tillers of the soil, till the pressure of rapacious neighbours compelled them to combine for mutual defence. Of this infant state, the so-called kingdom of the Piasts (from

Piast its supposed founder), we know next to nothing. In origin, its territory, its institutions are so many insoluble riddles. The earliest Polish chroniclers, from Gallus in the early 12th century to Janko of Czarnkow¹ in the 14th, are of little help to us. The only facts of importance to be gleaned from them are that Prince Ziemovit, the great-grandfather of Mieszko (Mieczyslaw) I. (962-992), wrested from the vast but tottering Moravian Empire the province of Chrobacyja (extending from the Carpathians to the Bug), and that Christianity was first preached on the Vistula by Greek Orthodox missionary monks. Mieszko himself was converted by Jordan, the chaplain of his Bohemian consort, Dobrawa or Bona, and when Jordan became the first bishop of Posen, the people seem to have followed the example of their prince. But the whole movement was apparently the outcome not of religious conviction, but of political necessity. The Slavonic peoples, whose territories then extended to the Elbe, and embraced the whole southern shore of the Baltic, were beginning to recoil before the vigorous impetus of the Germans in the West, who regarded their pagan neighbours as much the same way as the Spanish Conquistadores regarded the Aztecs and the Incas. To accept Christianity, at least formally, was therefore a prudential safeguard on the part of the Slavonians. This was thoroughly understood by Mieszko's son Boleslaus I. (992-1025), who went a considerable step farther than his father. Mieszko had been content to be received on almost any terms into the Christian community, Boleslaus aimed at securing the independence of the Polish Church as an additional guarantee of the independence of the Polish nation. ^{to Christian-ity.}

It was Boleslaus who made the church at Gnesen ^{to Christian-ity.} in Great Poland a national shrine by translating thither the relics of the martyred missionary, St Adalbert of Prague. Subsequently he elevated Gnesen into the metropolitan see of Poland, with jurisdiction over the bishoprics of Cracow, Bresla and Kolberg, all three of these new sees, it is important to notice being in territory conquered by Boleslaus; for hitherto both Cracow and Bresla had been Bohemian cities, while Kolberg was founded to curb the lately subjugated Pomeranians. Boleslaus was also the first Polish prince to bear the royal title, which seems to have been conferred upon him by Otto III. in 1000, though as Boleslaus crowned himself king a second time in 1025, it is evident that he regarded the validity of his first coronation as somewhat doubtful. He was primarily a warrior, whose reign, an almost uninterrupted warfare, resulted in the formation of a vast kingdom extending from the Baltic to the Carpathians, and from the Elbe to the Bug. But this imposing superstructure rested on the flimsiest of foundations. In less than twenty years after the death of its founder, it collapsed before a combined attack of all Poland's enemies, and simultaneously a terrible pagan reaction swept away the poor remnants of Christianity and civilization. For a time Poland proper became a smoking wilderness, and wild beasts made their lairs in the ruined and desecrated churches. Under Boleslaus II. (1058-1075) and Boleslaus III. (1102-1139) some of the lost provinces, notably Silesia and Pomerania, were recovered and Poland was at least able to maintain her independence against the Germans. Boleslaus III., moreover, with the aid of St Otto, bishop of Bamberg, succeeded in converting the heathen Pomeranians (1124-1128), and making head against paganism generally.

The last act of Boleslaus III. was to divide his territories among his sons, whereby Poland was partitioned into no fewer than four, and ultimately into as many as eight, ^{partitions} principalities, many of which (Silesia and Great ^{partitions} Poland, for instance) in process of time split ¹¹²⁵⁻¹¹³⁵ up into still smaller fractions all of them more or less bitterly hostile to each other. This partitional period, as Polish historians generally call it, lasted from 1138 to 1305, during which Poland lost all political significance, and became an easy prey to her neighbours. The duke of Little Poland

¹ Archdeacon of Gnesen 1367: vice-chancellor of Poland; *d.* c. 1387.

who generally styled himself duke of Poland, or *dux totius Poloniarum*, claimed a sort of supremacy among these little states, a claim materially strengthened by the wealth and growing importance of his capital, Cracow, especially after Little Poland had annexed the central principality of Sieradia (Sieradz). But Masovia to the north, and Great Poland to the north-west, refused to recognize the supremacy of Little Poland, while Silesia soon became completely germanized. It was at the beginning of this period too, between 1216 and 1224, that Pomerania, under an energetic native dynasty, freed herself from the Polish suzerainty. Nearly a generation later (1241) the Tatar hordes, under Batu, appeared for the first time on the confines of Poland. The Polish princes opposed a valiant but ineffectual resistance; the towns of Sandomir and Cracow were reduced to ashes, and all who were able fled to the mountains of Hungary or the forests of Moravia. Pursuing his way to Silesia, Batu overthrew the confederated Silesian princes at Liegnitz (April 9), and, after burning all the Silesian towns, invaded Hungary, where he routed King Bela IV. on the banks of the Sajó. But this marked the limit of his triumph. Exhausted and diminished by the stout and successful opposition of the Moravians at Olmütz, the Tatars vanished as suddenly as they had appeared, leaving a smoking wilderness behind them.

Batu's invasion had an important influence upon the social and political development of Poland. The only way of filling up the gaps in the population of the ravaged land was to invite foreign immigrants of a superior class, chapmen and handicraftsmen, not only given to peaceful pursuits and accustomed to law and order, but capable of building and defending strong cities. Such immigrants could naturally be obtained only from the civilized west, and on their own terms. Thus it came about that the middle class element was introduced into Polish society for the first time. Immediately dependent upon the prince, from whom they obtained their privileges, the most important of which were self-government and freedom from taxation, these traders soon became an important factor in the state, counterpoising, to some extent, the influence of the gentry, enriching the land by developing its resources, and promoting civilization by raising the standard of comfort.

Most of these German citizens in process of time were absorbed by the Polish population, and became devoted, heart and soul, to their adopted country; but these were not the only Germans with whom the young Polish state had now to deal. In the first year of the 13th century, the Knights of the Sword, one of the numerous orders of crusading military monks, had been founded in Livonia to "convert" the pagan Letts, and, in 1208, the still more powerful Teutonic order was invited by Duke Conrad of Masovia to settle in the district of Kulm (roughly corresponding to modern East Prussia) to protect his territories against the incursions of the savage Prussians, a race closely akin to the Lithuanians. Conrad has been loudly blamed by Polish historians for introducing this foreign, and as it ultimately proved, dangerous element into Poland. But the unfortunate prince had to choose between dependence and extermination, for his unaided resources were powerless against the persistent attacks of the unconquerable Prussians. The Teutonic Order, which had just been expelled from Hungary by Andrew II., joyfully accepted this new domicile, and its position in the north was definitely established by the compact of Kruschwitz in 1230, whereby it obtained absolute possession of the maritime district between Pomerania and Courland, and southwards as far as Thorn. So far were the Poles from anticipating any danger from the Teutonic Order, that, from 1243 to 1255, they actually assisted it to overthrow the independent Pomeranian princes, the most formidable opponents of the Knights in the earlier years of their existence. A second Tatar raid in 1259, less dangerous, perhaps, but certainly more ruinous, than the first invasion—for the principalities of Little Poland and Sandomir were systematically ravaged for three months—still further

depressed the land, and, at this very time, another enemy appeared in the east—the Lithuanians.

This interesting people, whose origin is to this day the most baffling of ethnographical puzzles, originally dwelt amidst the forests and marshes of the Upper Niemen. Thanks to the impenetrability of their fastnesses, they preserved their original savagery longer than any of their neighbours, and this savagery was coupled with a valour so tenacious and enterprising as to make them formidable to all who dwelt near them. The Russians fled at the sight of them, "like hares before hunters." The Livs and Letts were as much the prey of the Lithuanians "as sheep are the prey of wolves." The German chroniclers describe them as the most terrible of all the barbarians. The Lithuanians first emerge into the light of history at the time of the settlement of the Teutonic Order in the North. Rumours of the war of extermination conducted against their kinsmen, the wild Prussians, by the Knights, first woke the Lithuanians to a sense of their own danger, and induced them to abandon their loose communal system in favour of a monarchical form of government, which concentrated the whole power of the state in a single hand. Fortunately, too, at this crisis of their history, the Lithuanians were blessed with an altogether exceptional series of great rulers, who showed themselves fully capable of taking care of themselves. There was, for instance, Mendogv (1240-1263), who submitted to baptism for purely political reasons, checkmated the Teutonic Knights by adroitly seeking the protection of the Holy See, and annexed the principality of Plock to his ever-widening grand duchy, which already included Black Russia, and formed a huge wedge extending southwards from Courland, thus separating Poland from Russia. A still greater prince was Gedymin (1315-1342) who did his utmost to civilize Lithuania by building towns, introducing foreigners, and tolerating all religions, though he himself remained a pagan for political reasons. Gedymin still further extended the limits of Lithuania by annexing Kiev, Chernigov and other old Russian principalities.

At the very time when Lithuania was thus becoming a compact, united, powerful state, Poland seemed literally to be dropping to pieces. Not even the exhortations of the popes could make her score of princes unite for mutual defence against the barbarians who envisioned them. For a time it seemed highly probable that Poland would be completely germanized, like Silesia, or become a part of the new Bohemian Empire which Wenceslaus II. (crowned king of Poland in 1300) had inherited from his father, Ottakar II. From this fate she was saved by the valour of Wladislaus Lokietek, duke of Great Poland (1306-1333), who reunited Great and Little Poland, revived the royal dignity in 1320, and saved the kingdom from annihilation by his great victory over the Teutonic Knights at Plowce in 1332. The whole reign of Wladislaus I. was indeed an unceasing struggle against all the forces of anarchy and disintegration; but the fruits of his labours were richly reaped by his son Casimir III, the Great (1333-1370), Poland's first great statesman in the modern sense of the word, who, by a most skillful system of matrimonial alliances, reintroduced isolated Poland into the European system, and gave the exhausted country an inestimably beneficial breathing space of thirty-seven years. A born ruler, Casimir introduced a whole series of administrative and economical reforms. He was the especial protector of the cities and the peasants, and, though averse from violent measures, punished aristocratic tyranny with an iron hand. Casimir's few wars were waged entirely for profit, not glory. It is to him that Poland owed the important acquisition of the greater part of Red Russia, or Galicia, which enabled her to secure her fair share of the northern and eastern trade. In default of male issue, Casimir left the Polish throne to his nephew, Louis of Hungary, who ruled the country (1370-1382) through his mother, Queen Elizabeth, Wladislaus Lokietek's daughter. Louis well deserved the epithet of "great" bestowed upon him by his contemporaries;

Tatar invasion.

Foreign immigrants.
Rise of Cities.

The Knights of the Sword.

The Teutonic Order.

Wladislaus I.
1296-1333.

the Great.
1333-1370.

The Lithuanians.

but Poland formed but a small portion of his vast domains, and Poland's interests were subordinated to the larger demands of an imperial policy which embraced half Europe within its orbit.

On the death of Louis there ensued an interregnum of two years marked by fierce civil wars, instigated by duke Ziemovit of Masovia, the northernmost province of Poland, which continued to exist as an independent principality alongside of the kingdom of Poland. Ziemovit aimed at the Polish crown, proposing to marry the infant princess Jadwiga of Hungary, who, as the daughter of Louis the Great and the granddaughter of Wladislaus Lokietek, had an equal right, by inheritance, to the thrones of Hungary and Poland. By an agreement with the queen mother of Hungary at Kassa in 1383, the Poles finally accepted Jadwiga as their queen, and, on the 18th of February 1386, greatly against her will, the young princess, already betrothed to William of Austria, was wedded to Jagiello, grand duke of Lithuania, who had been crowned king of Poland at Cracow, three days previously, under the title of Wladislaus II.

The union of Poland and Lithuania as separate states under one king had been brought about by their common fear of the Teutonic Order. Five years after the death of Gedymin, Olgerd, the most capable of his seven sons, had been placed upon the throne of Lithuania by his devoted brother Kiejstut, and for the next two-and-thirty years (1345-1377) the two princes still further extended the sway of Lithuania, principally at the expense of Muscovy and the Tatars. Kiejstut ruled the western portion of the land where the Teutonic Knights were a constant menace, while Olgerd drove the Tatar hordes out of the south-eastern steppes, and compelled them to seek a refuge in the Crimea. During Olgerd's reign the southern boundaries of Lithuania touched the Black Sea, including the whole tract of land between the mouth of the Bug and the mouth of the Dnieper. Olgerd was succeeded by his son Jagiello as grand duke in 1377, while Kiejstut was left in possession of Samogitia, Troki and Grodno; but the Teutonic Order, alarmed at the growth of Lithuania, succeeded in estranging uncle and nephew, and Kiejstut was treacherously assassinated by Jagiello's orders, at Krowo, on the 15th of August 1382. Three weeks later Jagiello was compelled to cede Samogitia, as far as the Dubissa, to the Knights, and, in the following year they set up against him Kiejstut's son Witowt. The eyes of Jagiello were now opened to the fact that the machiavellian policy of the Knights aimed at subjugating Lithuania by dividing it. He at once made peace with his cousin; restored him his patrimony; and, to secure Lithuania against the future vengeance of the Knights, Jagiello made overtures to Poland for the hand of Jadwiga, and received the Polish crown along with it, as already mentioned.

Before proceeding to describe the Jagiellonic period of Polish history, it is necessary to cast a rapid glance at the social and political condition of the country in the preceding Piast period.

The paucity and taciturnity of our sources make it impossible to give anything like an adequate picture of Old Poland during the first four centuries of its existence. A glimpse here and there of the political development of the country is the utmost that the most diligent scrutiny can glean from the scanty record of the early chronicles. External pressure, here as elsewhere, created a patriotic military caste, and the subsequent partitioned period, when every little prince had his own separate court, still further established the growing influence of the *szlachta*, or gentry, who were not backward in claiming and obtaining special privileges in return for their services. The first authentic *pacta conventa* made between the Polish nobility and the Crown dates from the compact of Kassa (September 17, 1374), when Louis of Hungary agreed to exempt the *szlachta* from all taxation, except two Polish groschen per hide of land, and to compensate them for the expenses of all military service rendered beyond the confines of the realm. The clergy received their chief

privileges much earlier. It was at the synod of Lecza, nearly a century before the compact of Kassa, that the property of the Church was first safeguarded against the encroachments of the state. The beneficial influence of the Church of Poland in these early times was incalculable. To say nothing of the labours of the Cistercians as colonists, pioneers and church-builders, or of the missions of the Dominicans and Franciscans (the former of whom were introduced into Poland by Ivo, bishop of Cracow, the personal friend of Dominic), the Church was the one stable and unifying element in an age of centrifugal particularism. The frequent synods represented the wish of Poland, and kept alive, as nothing else could, the idea of national solidarity. The Holy See had also a considerable share in promoting the political development of the land. In the 13th century alone no fewer than forty-nine papal legats visited Poland, and thirty provincial synods were held by them to regulate church affairs and promote good government. Moreover the clergy, to their eternal honour, consistently protected the lower from the tyranny of the upper class.

The growth of the towns was slower. During the heroic Boleslawic period there had been a premature outcrop of civil life. As early as the 11th century Kraschwitz, ^{now} the old Polish capital, and Gnesen, the metropolitan see, were of considerable importance, and played a leading part in public life. But in the ensuing anarchic period both cities were utterly ruined, and the centre of political gravity was transferred from Great Poland to Little Poland, where Cracow, singularly favoured by her position, soon became the capital of the monarchy, and one of the wealthiest cities in Europe. At the end of the 14th century we find all the great trade fairs established there, and the cloth manufactured at Cracow was eagerly sought after, from Prague to Great Novgorod. So wealthy did Cracow become at last that Casimir the Great felt it necessary to restrain the luxury of her citizens by summary ordinances. Towards the end of the 14th century the Polish towns even attained some degree of political influence, and their delegates sat with the nobles and clergy in the king's council a right formally conceded to them at Radom in March 1346. Even the peasants, who had suffered severely from the wholesale establishment of prisoners of war as serfs on the estates of the nobles, still preserved the rights of personal liberty and free transit from place to place, whence their name of *laszki*. The only portion of the community which had no privileges were the Jews, first introduced into Poland by Boleslaus the Pious duke of Great Poland, in 1264, when bitter persecutions had driven them northwards from the shores of the Adriatic. Casimir the Great extended their liberty of domicile over the whole kingdom (1334). From the first they were better treated in Poland than elsewhere, though frequently exposed to outbreaks of popular fanaticism.

The transformation of the pagan Lithuanian chieftain Jagiello into the catholic king of Poland, Wladislaus II., was an event of capital importance in the history of eastern Europe. Its immediate and inevitable consequence was the formal reception of the Lithuanian nations into the fold of the Church. What the Teutonic Order had vainly endeavoured to bring about by fire and sword, for two centuries, was peacefully accomplished by Jagiello within a single generation, the Lithuanians, for the most part, yielding to the arguments of a prince of their own blood, who promptly rewarded his converts with peculiar and exclusive privileges. The conversion of Lithuania menaced the very existence of the Teutonic Knights. Originally planted on the Baltic shore for the express purpose of christianizing the savage neighbours, these crusading monks had freely expended the wealth and the valour of the West, ostensibly in the name of religion, really for the purpose of founding a dominion of their own which, as time went on, lost more and more of its religious character, and was now little more than a German military forpost, extending from Pomerania to the Niemen which deliberately excluded the Slavs from the sea and their

¹ Archbishop of Gnesen 1219-1220. Died at Modona 1226

at their expense. The mere instinct of self-preservation had, at last, drawn the Poles and Lithuanians together against these ruthless and masterful intruders, and the coronation of Jagiello at Cracow on the 25th of February 1386, was both a warning and a challenge to the Knights. But if the Order had now become a superfluous anachronism, it had still to be disposed of, and this was no easy task. For if it had failed utterly as a mission *in partibus*, it had succeeded in establishing on the Baltic one of the strongest military organizations in Europe. In the art of war the Knights were immeasurably superior to all their neighbours. The pick of the feudal chivalry composed their ranks; with all Europe to draw upon, their resources seemed inexhaustible, and centuries of political experience made them as formidable in diplomacy as they were valiant in warfare. And indeed, for the next twenty years, the Teutonic Order more than held its own. Skilfully taking advantage of the jealousies of Poland and Lithuania, as they were accentuated by the personal antagonism of Jagiello and Witowt (q.v.), with the latter of whom the Knights more than once contracted profitable alliances, they even contrived (Treaty of Saln, 1378) to extend their territory by getting possession of the province of Samogitia, the original seat of the Lithuanians, where paganism still persisted, and where their inhuman cruelties finally excited the horror and indignation of Christian Europe. By this time, however, the prudent Jagiello had become convinced that Lithuania was too strong to be ruled by or from Poland, and yet not strong enough to stand alone, and by the compact of Vilna (January 18, 1401, confirmed by the compact of Radow, March 10) he surrendered the whole grand duchy to Witowt, on the understanding that the two states should have a common policy, and that neither of them should elect a new prince without the consent of the other. The wisdom of this arrangement was made manifest in 1410, when Jagiello and Witowt combined their forces for the purpose of delivering Samogitia from the intolerable tyranny of the Knights. The issue was fought out on the field of Tannenberg, or Grünwald (July 15, 1410), when the Knights sustained a crushing defeat, which shook their political organization to its very foundations. A few weeks after the victory the towns of Thorn, Elbing, Braunsberg and Danzig submitted to the Polish king, and all the Prussian bishops voluntarily offered to render him homage. But the excessive caution of Jagiello gave the Knights time to recover from the blow; the Polish levies proved unruly and incompetent; Witowt was suddenly recalled to Lithuania by a Tatar invasion, and thus it came about that, when peace was concluded at Thorn, on the 1st of February 1411, Samogitia (which was to revert to the Order on the death of Jagiello and Witowt), Dobrzyn, and a war indemnity of 100,000 marks payable in four instalments, were the best terms Poland could obtain from the Knights, whose territory practically remained intact. Jagiello's signal for the attack at the battle of Grünwald, "Cracow and Vilna" (the respective capitals of Poland and Lithuania) had eloquently demonstrated the solidarity of the two states. This solidarity was still further strengthened by the Union of Horodlo (October 2, 1413) which enacted that henceforth Lithuania was to have the same order of dignitaries¹ as Poland, as well as a council of state, or senate, similar to the Polish senate. The power of the grand-duke was also greatly increased. He was now declared to be the equal of the Polish king, and his successor could be elected only by the senates of Poland and Lithuania in conjunction. The Union of Horodlo also established absolute parity between the nobility of Poland and Lithuania, but the privileges of the latter were made conditional upon their profession of the Roman Catholic faith, experience having shown that difference of religion in Lithuania meant difference of politics, and a tendency Moscow-wards, the majority of the Lithuanian boyars being of the Greek Orthodox Confession.

¹ All the chief offices of state were consequently duplicated, e.g. the *hetman wielki koronny*, i.e. "grand hetman of the crown," as the Polish commander-in-chief was called, had his counterpart in Lithuania, who bore the title of *wielki hetman litewski*, i.e. "grand hetman of Lithuania," and so on.

During the remainder of the reign of Wladislaus II. the Teutonic Order gave Poland much trouble, but no serious anxiety. The trouble was due mainly to the repeated efforts of the Knights to evade the fulfilment of the obligations of the Treaty of Thorn. In these endeavours they were materially assisted by the emperor Sigismund, who was also king of Hungary. Sigismund, in 1422, even went so far as to propose a partition of Poland between Hungary, the empire and the Silesian princes, a scheme which foundered upon Sigismund's impetuosity and the reluctance of the Magyars to injure the Poles. More than once Wladislaus II. was even obliged to renew the war against the Knights, and, in 1422, he compelled them to renounce all claims upon Samogitia; but the long struggle, still undecided at his death, was fought mainly with diplomatic weapons at Rome, where the popes, generally speaking, listened rather to the victorious monarch who had added an ecclesiastical province to the Church than to the discomfited and turbulent Knights.

Had Wladislaus II. been as great a warrior as Witowt he might, perhaps, have subdued the Knights altogether. But by nature he was pre-eminently a diplomatist, and it must in fairness be admitted that his diplomacy in every direction was distinctly beneficial to Poland. He successfully thwarted all the schemes of the emperor Sigismund, by adroitly supporting the revolutionary party in Bohemia (q.v.). In return Hussite mercenaries fought on the Polish side at Tannenberg, and Czech patriots repeatedly offered the crown of Bohemia to Wladislaus. The Polish king was always ready enough to support the Czechs against Sigismund; but the necessity of justifying his own orthodoxy (which the Knights were for ever impugning) at Rome and in the face of Europe prevented him from accepting the crown of St Wenceslaus from the hands of heretics.

Wladislaus II. died at Lemberg in 1434, at the age of eighty-three. During his long reign of forty-nine years Poland had gradually risen to the rank of a great power, a result due in no small measure to the insight and sagacity of the first Jagiello, who sacrificed every other consideration to the vital necessity of welding the central Slavs into a compact and homogeneous state. The next ten years severely tested the stability of his great work, but it stood the test triumphantly. Neither a turbulent minority, nor the neglect of an absentee king; neither the revival of separatist tendencies in Lithuania, nor the outbreaks of aristocratic lawlessness in Poland, could do more than shake the superstructure of the imposing edifice. After the death at Varna, in 1444, of Jagiello's eldest son and successor, Wladislaus III. (whose history belongs rather to Hungary than to Poland), another great statesman, in no wise inferior to Wladislaus II., completed and consolidated his work. This was Wladislaus's second son, already grandduke of Lithuania, who ascended the Polish throne as Casimir IV. in 1447, thus reuniting Poland and Lithuania under one monarch.

Enormous were the difficulties of Casimir IV. He instinctively recognized not only the vital necessity of the maintenance of the union between the two states, but also the *Casimir IV. 1447-1492.* fact that the chief source of danger to the union lay in Lithuania, in those days a maelstrom of conflicting political currents. To begin with, Lithuania was a far less composite state than Poland. Two-thirds of the grandduchy consisted of old Russian lands inhabited by men who spoke the Ruthenian language and professed the Orthodox Greek religion, while in the north were the Lithuanians proper, semi-savage and semi-catholic, justly proud of their heroic forefathers of the house of Gedymin, and very sensitive of the pretensions of Poland to the provinces of Volhynia and Podolia, the fruits of Lithuanian valour. A Lithuanian himself, Casimir strenuously resisted the attempts of Poland to wrest these provinces from the grandduchy. Moreover, during the earlier years of his reign, he was obliged to reside for the most part in Lithuania, where his tranquilizing influence was needed. His supposed preference for Lithuania was the real cause of his unpopularity in Poland, where, to the very end of his reign, he was regarded

with suspicion, and where every effort was made to thwart his far-seeing and patriotic political combinations, which were beyond the comprehension of his self-seeking and narrow-minded contemporaries. This was notably the case as regards his dealings with the old enemy of his race, the Teutonic Order, whose destruction was the chief aim of his ambition.

The Teutonic Order had long since failed as a religious institution; it was now to show its inadequacy as a political organization. In the domain of the Knights the gentry, parochial clergy and townsmen, who, beneath its protection, had attained to a high degree of wealth and civilization, for long remained without the slightest political influence, though they bore nearly the whole burden of taxation. In 1414, however, intimidated by the growing discontent, which frequently took the form of armed rebellion, the Knights consented to the establishment of a diet, which was re-formed on a more aristocratic basis in 1430. But the old abuses continuing to multiply, the Prussian towns and gentry at last took their affairs into their own hands, and formed a so-called Prussian League, which demanded an equal share in the government of the country. This league was excommunicated by the pope, and placed under the ban of the empire almost simultaneously in 1453, whereupon it placed itself beneath the protection of its nearest powerful neighbour, the king of Poland, who (March 6, 1454) issued a manifesto incorporating all the Prussian provinces with Poland, but, at the same time, granting them local autonomy and free trade.

But provinces not conquered by manifestoes, and Casimir's acceptance of the homage of the Prussian League at once involved him in a war with the desperate Teutonic Knights, which lasted twelve years, but might easily have been concluded in a twelvemonth had he only been loyally supported by his own subjects, for whose benefit he had embarked upon this great enterprise. But instead of support, Casimir encountered obstinate obstruction at every point. No patriotic Pole, we imagine, can read the history of this miserable war without feeling heartily ashamed of his countrymen. The acquisition of the Prussian lands was vital to the existence of Poland. It meant the excision of an alien element which fed like a cancer on the body politic; it meant the recovery, at comparatively little cost, of the command of the principal rivers of Poland, the Vistula and the Niemen; it meant the obtaining of a seaboard with the corollaries of sea-power and world-wide commerce. Yet, except in the border province of Great Poland, which was interested commercially, the whole enterprise was regarded with such indifference that the king, in the very crisis of the struggle, could only with the utmost difficulty obtain contributions for war expenses from the half-dozen local diets of Poland, which extorted from the helplessness of their distracted and impetuous sovereign fresh privileges for every subsidy they grudgingly granted. Moreover Casimir's difficulties were materially increased by the necessity of paying for Czech mercenaries, the *pospolite ruszenie*, or Polish militia, proving utterly useless at the very beginning of the war. Indeed, from first to last, the Polish gentry as a body took good care to pay and fight as little as possible, and Casimir depended for the most part upon the liberality of the Church and the Prussian towns, and the valour of the Hussite infantry, 170,000 of whom, fighting on both sides, are said to have perished. Not till the victory of Puck (September 17, 1462), one of the very few pitched battles in a war of raids, skirmishes and sieges, did fortune incline decisively to the side of the Poles, who maintained and improved their advantage till absolute exhaustion compelled the Knights to accept the mediation of a papal legate, and the second peace of Thorn (October 14, 1466) concluded a struggle which had reduced the Prussian provinces to a wilderness.¹ By the second peace of Thorn, Poland recovered the provinces of Pomerelia, Kulm and Michalow, with the bishopric of Ermeland, numerous cities and fortresses, including Marien-

¹ 18,000 of their 21,000 villages were destroyed, 1000 churches were razed to the ground, and the population was diminished by more than a quarter of a million.

burg, Elbing, Danzig and Thorn. The territory of the Knights was now reduced to Prussia proper, embracing, roughly speaking, the district between the Baltic, the lower Vistula and the lower Niemen, with Königsberg as its capital. For this territory the grand-masters, within nine months of their election, were in future to render homage to the Polish king; but, on the other hand, the king undertook not to make war or engage in any important enterprise without the consent of the Prussian provinces, and vice versa. Thus Prussia was now confederated with Poland, but she occupied a subordinate position as compared with Lithuania, inasmuch as the grand-master, though still the first place in the royal council, was still a subject of the Polish crown. Thus the high hopes entertained by Casimir at the beginning of the war had not been realized. The final settlement with the Poles was of the nature of a compromise. Still the Knights had been driven beyond the Vistula, and Poland had secured a seaboard; and it was due entirely to the infinite patience and tenacity of the king that even as much as this was won at last.

The whole foreign policy of Casimir IV. was more or less conditioned by the Prussian question, and here also his superior diplomacy triumphantly asserted itself. At the beginning of the war both the empire and the pope were against him, but he neutralized their hostility by allying himself with George of Podvehrad, whom the Hussites had placed on the throne of Bohemia. On the death of George, Casimir's eldest son Wladislaus was elected king of Bohemia by the Ultraquist party, despite the determined opposition of Matthias Corvinus, king of Hungary, whose ability and audacity henceforth made him Casimir's most dangerous rival. Sure of the support of the pope, Matthias (*q.v.*) deliberately set about traversing all the plans of Casimir. He encouraged the Teutonic Order to rebel against Poland; he entertained at his court and Polish embassies from Moscow; he encouraged the Tatars to ravage Lithuania; he thwarted Casimir's policy in Moldavia. The death of the brilliant adventurer at Vienna in 1490 was therefore as a distinct relief to Poland, and all danger from the side of Hungary was removed in 1490 when Casimir's son Wladislaus, already king of Bohemia, was elected king of Hungary also.

It was in the reign of Casimir IV. that Poland first came into direct collision with the Turks. The Republic was even indeed, the "Buckler of Christendom." That glorious epithet belonged of right to Hungary, which had already borne the brunt of the struggle with the Ottoman power for more than a century. It is true the Wladislaus II. of Poland had fallen on the field of Varna, but it was as a Magyar king at the head of a Magyar army that the young monarch met his fate. Poland, indeed, was far less able to cope with the Turks than compact, wealthy Hungary, which throughout the 15th century was one of the most efficient military monarchies in Europe. The Jagiellons, as a rule prudently avoided committing themselves to any political system which might irritate the still distant but much-feared Turk, but when their dominions extended so far southward as to embrace Moldavia, the observance of a strict neutrality became exceedingly difficult. Poland had established a sort of suzerainty over Moldavia as early as the end of the 14th century; but at best it was a loose and vague overlordship which the Hospodars repudiated whenever they were strong enough to do so. The Turks themselves were too much occupied elsewhere to pay much attention to the Danubian principality till the middle of the 15th century. In 1478 Mahomet II. had indeed attempted their subjugation, with but indifferent success; but it was not till 1484 that the Ottomans became inconvenient neighbours to Poland. In that year a Turkish fleet captured the strongholds of Kilia and Akkerman, commanding respectively the mouths of the Danube and Dniester. The aggression seriously threatened the trade of Poland, and indeed Casimir IV. to accede to a general league against the Turk. In 1485, after driving the Turks out of Moldavia, the Polish king, at the head of 30,000 men, proceeded to Kolesman on the

Pruth, where Bayesid II., then embarrassed by the Egyptian war, offered peace, but as no agreement concerning the captured fortresses could be arrived at, hostilities were suspended by a truce. During the remainder of his reign the Turks gave no trouble.

It was a fortunate thing for Poland that, during the first century of her ascension to the rank of a great power, political exigencies compelled her to appropriate almost more territory than her primitive and centrifugal government could properly assimilate; it was fortunate that throughout this period of expansion her destinies should, with one brief interval, have been controlled by a couple of superior statesmen, each of whom ruled for nearly fifty years. During the fourteen years (1492-1506) which separate the reigns of Casimir IV. and Sigismund I. she was not so lucky. The controlling hand of Casimir IV. was no sooner withdrawn than the unruly elements, ever present in the Republic, and ultimately the cause of its ruin, at once burst forth. The first symptom of this lawlessness was the separation of Poland and Lithuania, the Lithuanians proceeding to elect Alexander, Casimir's fourth son, as their grand-duke, without even consulting the Polish senate, in flagrant violation of the union of Horodlo. The breach, happily, was of no very long duration. A disastrous war with Ivan III., the first Muscovite tsar, speedily convinced the Lithuanians that they were not strong enough to stand alone, and in 1499 they voluntarily renewed the union. Much more dangerous was the political revolution proceeding simultaneously in Poland,

John I. Albert, the third son of Casimir, had been elected king on the death of his father. The nature of this revolution will be considered in detail when we come to speak of the growth of the Polish constitution. Suffice it here to say that it was both anti-monarchical and anti-democratic, tending, as it did, to place all political authority in the hands of the *szlachta*, or gentry. The impecunious monarch submitted to the dictation of the diet in the hope of obtaining sufficient money to prosecute his ambitious designs. With his elder brother Wladislaus reigning over Bohemia and Hungary the credit of the Jagiellos in Europe had never been so great as it was now, and John Albert, bent upon military glory, eagerly placed himself at the head of what was to have been a great anti-Turkish league, but ultimately dwindled down to a raid upon Moldavia which ended in disaster. The sole advantage which John Albert reaped from his championship of the Christian cause was the favour of the Curia, and the ascendancy which that favour gave him over the Teutonic Knights, whose new grand-master, Albert of Saxony, was reluctantly compelled to render due homage to the Polish king.

Under Alexander (q.v.), who succeeded his brother in 1501, matters went from bad to worse. Alexander's election cemented, indeed, once for all, the union between Poland and Lithuania, inasmuch as, on the eve of it (Oct. 3, 1501) the senates of both countries agreed that, in future, the king of Poland should always be grand-duke of Lithuania; but this was the sole benefit which the Republic derived from the reign of Alexander, under whom the Polish government has been well described as a rudderless ship in a stormy sea, with nothing but the grace of God between it and destruction. In Lithuania the increasing pressure of the Muscovite was the chief danger. Till the accession of Ivan III.

in 1462 Muscovy had been a negligible factor in Polish politics. During the earlier part of the 15th century the Lithuanian princes had successfully contested Muscovite influence even in Pskov and Great Novgorod. Many Russian historians even maintain that, but for the fact that Witowt had simultaneously to cope with the Teutonic Order and the Tatars, that energetic prince would certainly have extinguished struggling Muscovy altogether. But since the death of Witowt (1430) the military efficiency of Lithuania had sensibly declined; single-handed she was no longer a match for her ancient rival. This was owing partly to the evils of an oligarchic government; partly to the weakness resulting from the natural attraction of the Orthodox-Greek element in Lithu-

ania towards Muscovy, especially after the fall of Constantinople; but chiefly to the administrative superiority of the highly centralized Muscovite government. During the reign of Alexander, who was too poor to maintain any adequate standing army in Lithuania, the Muscovites and Tatars ravaged the whole country at will, and were prevented from conquering it altogether only by their inability to capture the chief fortresses. In Poland, meanwhile, something very like anarchy prevailed. Alexander had practically surrendered his authority to an incapable aristocracy, whose sole idea of ruling was systematically to oppress and humiliate the lower classes. In foreign affairs a policy of drift prevailed which encouraged all the enemies of the Republic to raise their heads, while the dependent states of Prussia in the north and Moldavia in the south made strenuous efforts to break away from Poland. Fortunately for the integrity of the Polish state the premature death of Alexander in 1506 brought upon the throne his capable brother Sigismund, the fifth son of Casimir IV., whose long reign of forty-two years was salutary, and would have been altogether recuperative, had his statesmanship only been loyally supported by his subjects. Eminently practical Sigismund recognized that the first need of Poland was a standing army. The miserable collapse of the Polish chivalry during the Bukovinian campaign of 1497 had convinced every one that the *russenie hospolite* was useless for serious military purposes, and that Poland, in order to hold her own, must in future follow the example of the West, and wage her warfare with trained mercenaries. But professional soldiers could not be hired without money, and the difficulty was to persuade the diet to loose its purse-strings. All that the gentry contributed at present was two pence (groschen) per hide of land, and this only for defensive service at home. If the king led the *russenie hospolite* abroad he was obliged to pay so much per pike out of his own pocket, notwithstanding the fact that the heavily mortgaged crown lands were practically valueless. At the diet of 1510 the chancellor and primate, Adam Laski, proposed an income-tax of 50% at once, and 5% for subsequent years, payable by both the lay and clerical estates. In view of the fact that Poland was the most defenceless country in Europe, with no natural boundaries, and constantly exposed to attacks from every quarter, it was not unreasonable to expect even this patriotic sacrifice from the privileged classes, who held at least two-thirds of the land by military tenure. Nevertheless, the diet refused to consider the scheme. In the following year a more modest proposal was made by the Crown in the shape of a capitation of six gulden, to be levied on every nobleman at the beginning of a campaign, for the hiring of mercenaries. This also was rejected. In 1512 the king came forward with a third scheme. He proposed to divide the country into five circles, corresponding to the five provinces, each of which was to undertake to defend the realm in turn should occasion arise. Moreover, every one who so desired it might pay a commutation in lieu of personal service, and the amount so realized was to be re-used to levy troops. To this the dietes, or local diets, of Great Poland, and Little Poland, agreed, but at the last moment the whole project foundered on the question who was the proper custodian of the new assessment rolls, and the king had to be content with the renewal of former subsidies, varying from twelve to fifteen groats per hide of land for three years. Well might the disappointed monarch exclaim: "It is vain to labour for the welfare of those who do not care a jot about it themselves." Matters improved somewhat in 1527, when the *szlachta*, by a special act, placed the mightiest magnates on the same level as the humblest squire as regards military service, and proposed at the same time a more general assessment for the purpose, the control of the money so realized to be placed in the hands of the king. In consequence of this law the great lords were compelled to put forces in the field proportioned to their enormous fortunes, and Sigismund was able in 1529 to raise 300 foot and 3200 horse from the province of Podolia alone. But though the treasury was thus temporarily replenished and the army increased, the gentry who had been so generous at

the expense of their richer neighbours would hear of no additional burdens being laid on themselves, and the king only obtained what he wanted by sacrificing his principles to his necessities, and helping the *szlachta* to pull down the magnates. This fatal parsimony had the most serious political consequences, for it crippled the king at every step. Strive and scheme as he might, his needs were so urgent, his enemies so numerous, that, though generally successful in the end, he had always to be content with compromises, adjustments and semi-victories. Thus he was obliged, in 1525, to grant local autonomy to the province of Prussia instead of annexing it, he was unable to succour his unfortunate nephew, Louis of Hungary, against the Turkish peril, he was compelled to submit to the occupation of one Lithuanian province after the other by the Muscovites, and look on helplessly while myriads of Tatars penetrated to the very heart of his domains, wasting with fire and sword everything they could not carry away with them.

Again, it should have been the first duty of the Republic adequately to fortify the *dzikie pola*, or "savage steppe," as the vast plain was called which extended from Kiev to the Black Sea, and some feeble attempts to do so were at last made. Thus, in the reign of Alexander,

The Cossacks. the fugitive serfs whom tyranny or idleness had driven into this wilderness (they were subsequently known as Kazaki, or Cossacks, a Tatar word meaning freebooters) were formed into companies (c. 1504) and placed at the disposal of the frontier *starostas*, or lord marchers, of Kaniew, Kamenets, Czerkask on the Don and other places. But these measures proved inadequate, and in 1533 the lord marcher, Ostafi Daszkiewicz, the hero of Kaniew, which he had successfully defended against a countless host of Turks and Tatars, was consulted by the diet as to the best way of defending the Ukraine permanently against such inroads. The veteran expert advised the populating and fortifying of the islands of the Dnieper. Two thousand men would suffice, he said, and the Cossacks supplied excellent military material ready to hand. The diet unanimously approved of this simple and inexpensive plan; a special commission examined and approved of its details, and it was submitted to the next diet, which rejected it. So nothing at all was done officially, and the defence of the eastern Ukraine was left to providence. Oddly enough the selfish prudence of Sigismund's rapacious consort, Queen Bona, did more for the national defence than the Polish state could do. Thus, to defend her immense possessions in Volhynia and Podolia, she converted the castles of Bar and Krzemieniec into first-class fortresses, and placed the former in the hands of her Silesian steward, who acquitted himself so manfully of his charge that "the Tatars fell away from the frontier all the days of Pan Preticz," and a large population settled securely beneath the walls of Bar, henceforth known as "the bastion of Podolia." Nothing, perhaps, illustrates so forcibly the casual character of the Polish government in the most vital matters as this single incident.

The most important political event during the reign of Sigismund was the collapse of the ancient Hungarian monarchy at Mohacs in 1526. Poland, as the next neighbour of Hungary, was more seriously affected than any other European power by this catastrophe, but her politicians differed as to the best way of facing it. Immediately after the death of King Louis, who fell on the field of battle, the emperor Ferdinand and John Zapolya, voivode of Transylvania, competed for the vacant crown, and both were elected almost simultaneously. In Poland Zapolya's was the popular cause, and he also found powerful support in the influential and highly gifted Laski family, as represented by the Polish chancellor and his nephews John and Hieronymus. Sigismund, on the other hand, favoured Ferdinand of Austria. Though bound by family ties with both competitors, he regarded the situation from a purely political point of view. He argued that the best way to keep the Turk from Poland was for Austria to incorporate Hungary, in which case the Austrian dominion would be a strong and permanent barrier against a Mussulman invasion of Europe. History has

¹ Preticz won no fewer than 70 engagements over the Tatars.

more than justified him, and the long duel which ensued between Ferdinand and Zapolya (see HUNGARY. *History*) enabled the Polish monarch to maintain to the end a cautious but observant neutrality. More than once, indeed, Sigismund was seriously compromised by the diplomatic vagaries of Hieronymus Laski, who entered the service of Zapolya (since 1529 the protégé of the sultan), and greatly alarmed both the emperor and the pope by his disturbing philo-Turk proclivities. It was owing to Laski's intrigues that the new hospodar of Moldavia, Petrylo, after doing homage to the Porte, intervened in the struggle as the foe of both Ferdinand and Sigismund, and besieged the Grand Hetman of the Crown, Jan Tarnowski, in Obertyn, where, however, the Moldavians (August 22, 1531) sustained a crushing defeat, and Petrylo was slain. Nevertheless, so anxious was Sigismund to avoid a collision with the Turks, that he forbade the victorious Tarnowski to cross the Moldavian frontier, and sent a letter of explanation to Constantinople. On the death of John Zapolya, the Austro-Polish alliance was still further cemented by the marriage of Sigismund's son and heir, Sigismund Augustus, with the archduchess Elizabeth. In the reign of Sigismund was effected the incorporation of the duchy of Masovia with the Polish crown, after an independent existence of five hundred years. In 1526 the male line of the ancient dynasty became extinct, and on the 26th of August Sigismund received the homage of the Masovians at Warsaw, the capital of the duchy and ere long of the whole kingdom. Almost every acre of densely populated Masovia was in the hands of her sturdy, ultra-conservative squires, in point of culture far below their brethren in Great and Little Poland. The additional revenue gained by the Crown from Masovia was at first but 14,000 gulden *per annum*.

The four and twenty years of Sigismund II's reign was a critical period of Polish history. Complications with the Turk were avoided by the adroit diplomacy of the king, while the superior discipline and efficiency of the Polish armies under the great Tarnowski (*q.v.*) and his pupils overawed the Tatars and extruded the Muscovites, neither of whom were so troublesome as they had been during the last reign. All the more disquieting was the internal condition of the country, due mainly to the invasion of Poland by the Reformation, and the coincidence of this invasion with an internal revolution of a quasi-democratic character, which aimed at substituting the rule of the *szlachta* for the rule of the senate.

Hitherto the Republic had given the Holy See but little anxiety. Hussite influences, in the beginning of the 15th century, had been superficial and transitory. *The Reformation in Poland.* The Polish government had employed Hussite mercenaries, but rejected Hussite propagandists. The edict of Wicun (1424), remarkable as the first anti-heretical decree issued in Poland, crushed the new sect in its infancy. Lutheranism, moreover, was at first regarded with grave suspicion by the intensely patriotic Polish gentry, because of its German origin. Nevertheless, the extremely severe penal edicts issued during the reign of Sigismund I., though seldom applied, seem to point to the fact that heresy was spreading widely throughout the country. For a time, therefore, the Protestants had to be cautious in Poland proper, but they found a safe refuge in Prussia, where Lutheranism was already the established religion, and where the newly erected university of Königsberg became a seminary for Polish ministers and preachers.

While Lutheranism was thus threatening the Polish Church from the north, Calvinism had already invaded her from the west. Calvinism, indeed, rather recommended itself to the Poles as being of non-German origin, and Calvin actually dedicated his *Commentary on the Mass* to the young *krolowicz* (or crown prince) Sigismund Augustus, from whom protestantism, erroneously enough, expected much in the future. Meanwhile conversion to Calvinism, among the higher classes in Poland, became more and more frequent. We hear of crowded Calvinist conventicles in Little Poland from 1545 onwards, and Calvinism continued to spread throughout the kingdom during the latter

years of Sigismund I. Another sect, which ultimately found even more favour in Poland than the Calvinists, was that of the Bohemian Brethren. We first hear of them in Great Poland in 1548. A royal decree promptly banished them to Prussia, where they soon increased so rapidly as to be able to hold their own against the Lutherans. The death of the uncompromising Sigismund I. came as a great relief to the Protestants, who entertained high hopes of his son and successor. He was known to be familiar with the works of the leading reformers; he was surrounded by Protestant counsellors, and he was actually married to Barbara, daughter of Prince Nicholas Radziwill, "Black Radziwill," the all-powerful chief of the Lithuanian Calvinists. It was not so generally known that Sigismund II. was by conviction a sincere though not a bigoted Catholic; and nobody suspected that beneath his diplomatic urbanity lay a patriotic firmness and statesmanlike qualities of the first order. Moreover, they ignored the fact that the success of the Protestant propaganda was due rather to political than to religious causes. The Polish gentry's jealousy of the clerical estate, whose privileges even exceeded their own, was at the bottom of the whole matter. Any opponent of the established clergy was the natural ally of the *szlachta*, and the scandalous state of the Church herself provided them with a most formidable weapon against her. It is not too much to say that the condition of the Catholic Church in Poland was almost as bad as it was in Scotland during the same period. The bishops were, for the most part, elegant triflers, as pliant as reeds, with no fixed principles and saturated with a false humanism. Some of them were notorious evil-livers. "Pint-pot" Lutskuski, bishop of Posen, had purchased his office for 12,000 ducats from Queen Bona; while another of her creatures, Peter, popularly known as the "wencher," was appointed bishop of Przemysl with the promise of the reversion of the still richer see of Cracow. Moreover, despite her immense wealth (in the province of Little Poland alone she owned at this time 26 towns, 83 landed estates and 772 villages), the Church claimed exemption from all public burdens, from all political responsibilities, although her prelates continued to exercise an altogether disproportionate political influence. Education was shamefully neglected, the masses being left in almost heathen ignorance—and this, too, at a time when the upper classes were greedily appropriating the ripe fruits of the Renaissance and when, to use the words of a contemporary, there were "more Latinists in Poland than there used to be in Latium." The university of Cracow, the sole source of knowledge in the vast Polish realm, still moved in the vicious circle of scholastic formularies. The provincial schools, dependent upon so decrepit an *alma mater*, were suffered to decay. This criminal neglect of national education brought along with it its own punishment. The sons of the gentry, denied proper instruction at home, betook themselves to the nearest universities across the border, to Goldberg in Silesia, to Wittemberg, to Leipzig. Here they fell in with the adherents of the new faith, grave, earnest men who professed to reform the abuses which had grown up in the Church; and a sense of equity as much as a love of novelty moved them, on their return home, to propagate wholesome doctrines and clamour for the reformation of their own degenerate prelates. Finally the poorer clergy, neglected by their bishops, and excluded from all preferment, took part with the *szlachta* against their own spiritual rulers and eagerly devoured and imparted to their flocks, in their own language, the contents of the religious tracts which reached them by divers ways from Goldberg and Königsberg. Nothing indeed did so much to popularize the new doctrines in Poland as this beneficial revival of the long-neglected vernacular by the reformers.

Such was the situation when Sigismund II. began his reign. The bishops at once made a high bid for the favour of the new king by consenting to the coronation of his Calvinist consort (Dec. 7, 1550) and the king five days afterwards issued the celebrated edict in which he pledged his royal word to preserve intact the unity of the Church and to enforce the law of the land against heresy. Encouraged by this pleasing symptom of orthodoxy the bishops, instead

of first attempting to put their own dilapidated house in order, at once proceeded to institute prosecutions for heresy against all and sundry. This at once led to an explosion, and at the diet of Piotrkow, 1552, the *szlachta* accepted a proposition of the king, by way of compromise, that the jurisdiction of the clerical courts should be suspended for twelve months, on condition that the gentry continued to pay tithes as heretofore. Then began a religious *interim*, which was gradually prolonged for ten years, during which time Protestantism in Poland flourished exceedingly. Presently reformers of every shade of opinion, even those who were tolerated nowhere else, poured into Poland, which speedily became the battle-ground of all the sects of Europe. Soon the Protestants became numerous enough to form ecclesiastical districts of their own. The first Calvinist synod in Poland was held at Pinczow in 1550. The Bohemian Brethren evangelized Little Poland, but ultimately coalesced with the Calvinists at the synod of Kosminck (August 1555). In the diet itself the Protestants were absolutely supreme, and invariably elected a Calvinist to be their marshal. At the diet of 1555 they boldly demanded a national synod, absolute toleration, and the equalization of all the sects except the Anti-trinitarians. But the king intervened and the existing *interim* was indefinitely prolonged. At the diet of Piotrkow, 1558-1559, the onslaught of the *szlachta* on the clergy was fiercer than ever, and they even demanded the exclusion of the bishops from the senate. The king, however, perceiving a danger to the constitution in the violence of the *szlachta*, not only supported the bishops, but quashed a subsequent reiterated demand for a national synod. The diet of 1558-1559 indicates the high-water mark of Polish Protestantism. From this time forward it began to subside, very gradually but unmistakably. The chief cause of this subsidence was the division among the reformers themselves. From the chaos of creeds resulted a chaos of ideas on all imaginable subjects, politics included. The Anti-trinitarian proved to be the chief dissolvent, and from 1560 onwards the relations between the two principal Protestant sects, the Lutherans and the Calvinists, were fratricidal rather than fraternal. An auxiliary cause of the decline of Protestantism was the beginning of a Catholic reaction. The bulk of the population still held persistently, if languidly, to the faith of its fathers; the new bishops were holy and learned men, very unlike the creations of Queen Bona, and the Holy See gave to the slowly reviving zeal of both clergy and laity the very necessary impetus from without. For Poland, unlike Scotland, was fortunately, in those days of difficult inter-communication, not too far off, and it is indisputable that in the first instance it was the papal nuncios, men like Berard of Camerino and Giovanni Commendone, who reorganized the scattered and faint-hearted battalions of the Church militant in Poland and led them back to victory. At the diet of Piotrkow in 1562, indeed, the king's sore need of subsidies induced him, at the demand of the *szlachta*, to abolish altogether the jurisdiction of the ecclesiastical courts in cases of heresy; but, on the other hand, at the diet of 1564 he accepted from Commendone the Tridentine decrees and issued an edict banishing all foreign, and especially Anti-trinitarian, heretics from the land. At the diet of 1565 Sigismund went still farther. He rejected a petition for a national ⁷²⁰ pacificatory synod as unnecessary, inasmuch as the ⁷²⁰ Council of Trent had already settled all religious ⁷²⁰ Reformation in Poland. questions, and at the same time consented to the introduction into Poland of the most formidable adversaries of the Reformation, the Jesuits. These had already been installed at Pultusk, and were permitted, after the diet rose, to found establishments in the dioceses of Posen, Ermeland and Vilna, which henceforth became centres of a vigorous and victorious propaganda. Thus the Republic recovered her catholicity and her internal harmony at the same time.

With rare sagacity Sigismund II. had thus piloted the Republic through the most difficult internal crisis it had yet encountered. In purely political matters also both initiative and fulfilment came entirely from the Crown, and to the last of the Jagiello Poland owed the important acquisition of Livonia and the

welding together of her loosely connected component parts into a single state by the Union of Lublin.

In the middle of the 16th century the ancient order of the Knights of the Sword, whose territory embraced Esthonia, Livonia, Courland, Semgallen and the islands of Dagö and Oesel, was tottering to its fall. All the Baltic powers were more or less interested in the apportionment of this vast tract of land, whose geographical position made it not only the chief commercial link between east and west, but also the emporium whence the English, Dutch, Swedes, Danes and Germans obtained their corn, timber and most of the raw products of Lithuania and Muscovy. Matters were complicated by the curious political intricacies of this long-coveted domain, where the grand-master, the archbishop of Riga, and the estates of Livonia possessed concurrent and generally conflicting jurisdictions. Poland and Muscovy as the nearest neighbours of this moribund state, which had so long excluded them from the sea, were vitally concerned in its fate. After an anarchic period of suspense, lasting from 1546 to 1561, during which Sweden secured Esthonia, while Ivan the Terrible fearlessly ravaged Livonia, in the hope of making it valueless to any other potentate, Sigismund II., to whom both the grand-master and the archbishop had appealed more than once for protection, at length intervened decisively. Both he and his chancellor, Piotr Myszkowski (d. 1591), were well aware of the importance of securing a coast-land which would enable Poland to become a naval power. But the diet, with almost incredible short-sightedness, refused to waste a penny on an undertaking which, they argued, concerned only Lithuania, and it was not as king of Poland, but as grand-duke of Lithuania, and with purely Lithuanian troops, that Sigismund, in 1561, occupied Livonia. At his camp before Riga the last grand-master, Gotthard von Ketteler, who had long been at the head of the Polish party in Livonia, and William of Brandenburg, archbishop of Riga, gladly placed themselves beneath his protection, and by a subsequent convention signed at Vilna (Nov. 28, 1561), Livonia was incorporated with Lithuania in much the same way as Prussia had been incorporated with Poland thirty-six years previously. Ketteler, who had adopted Lutheranism during a visit to Germany in 1553, now professed the Augsburg Confession, and became the first duke of a new Protestant duchy, which he was to hold as a fief of the Polish crown, with local autonomy and absolute freedom of worship. The southern provinces of the ancient territory of the Order, Courland and Semgallen, had first been ceded on the 24th of June 1559 to Lithuania on similar conditions, the matter being finally adjusted by the compact of March 1562.

The apathy of Poland in such a vital matter as the Livonian question must have convinced so statesmanlike a prince as Sigismund II. of the necessity of preventing any possibility of cleavage in the future between the two halves of his dominions whose absolute solidarity was essential to their existence as a great power. To this patriotic design he devoted the remainder of his life. A personal union, under one monarch, however close, had proved inadequate. A further step must be taken—the two independent countries must be transformed into a single state. The great obstacle in the way of this, the only true solution of the difficulty, was the opposition of the Lithuanian magnates, who feared to lose the absolute dominancy they possessed in the grand-duchy if they were merged in the *szlachta* of the kingdom. But, at the last moment, the dread of another Muscovite invasion made them more pliable and, at a Polish diet held at Warsaw from November 1563 to June 1564, which the Lithuanians attended, the question of an absolute union was hotly debated. When things came to a deadlock the king tactfully intervened and voluntarily relinquished his hereditary title to Lithuania, thus placing the two countries on a constitutional equality and preparing the way for fresh negotiations in the future. The death, in 1565, of Black Radziwill, the chief opponent of the union, still further weakened the Lithuanians, and the negotiations were reopened with more prospect of success at the diet which met at Lublin on the 10th

of January 1569. But even now the Lithuanians were indispensed towards a complete union, and finally they quitted the diet, leaving two commissioners behind to watch their interests. Then Sigismund executed his master stroke. Knowing the sensitiveness of the Lithuanians as regards Volhynia and Podolia, he suddenly, of his own authority, formally incorporated both these provinces with the kingdom of Poland, whereupon, amidst great enthusiasm, the Volhynian and Podolian deputies took their places on the same benches as their Polish brethren. The hands of the Lithuanians were forced. Even a complete union on equal terms was better than mutilated independence. Accordingly they returned to the diet, and the ^{Complete} union was unanimously adopted on the 1st of July ^{Union of} 1569. Henceforth the kingdom of Poland and the ^{the Lithuanians} grand duchy of Lithuania were to constitute one ^{and Poland} inseparable and indivisible body politic, under one sovereign, elected in common, with one diet and one currency. All dependencies and colonies, including Prussia and Livonia, were to belong to Poland and Lithuania in common. The retention of the old duality of dignities was the one reminiscence of the original separation. No decision, however, could be come to as to the successor of the childless king, partly because of the multiplicity of candidates, partly because of Austrian intrigue, and this, the most momentous question of all, was still unsettled when Sigismund II. expired on the 6th of July 1572.

The Jagiellonic period (1386-1572) is the history of the consolidation and fusion into one homogeneous, political whole of numerous national elements, more or less akin ethnologically, but differing immensely in language, ^{Character} religion and, above all, in degrees of civilization. ^{of the} Out of the ancient Piast kingdom, mutilated by the ^{Jagiellonic} loss of Silesia and the Baltic shore, arose a republic ^{Period.} consisting at first of various loosely connected entities, naturally centrifugal, but temporarily drawn together by the urgent need of combination against a superior foe, who threatened them separately with extinction. Beneath the guidance of a dynasty of princes which, curiously enough, was supplied by the least civilized portion of this congeries of nationalities, the nascent republic gradually grew into a power which subjugated its former oppressors and, viewed externally, seemed to bear upon it the promise of empire. It is dangerous to prophesy, but all the facts and circumstances before us point irresistibly to the conclusion that had the Jagiellonic dynasty but endured this promise of empire might well have been realized. The extraordinary thing about the Jagiellons was the equable persistency of their genius. Not only were five of the seven great statesmen, but they were statesmen of the same stamp. We are disturbed by no such sharp contrasts as are to be found among the Plantagenets, the Vasas and the Bourbons. The Jagiellons were all of the same mould and pattern, but the mould was a strong one and the pattern was good. Their predominant and constant characteristic is a sober sagacity which instinctively judges aright and imperturbably realized its inspirations. The Jagiellons were rarely brilliant, but they were always perspicacious. Above all, they alone seem to have had the gift of guiding the most difficult of nations properly. Two centuries of Jagiellonic rule made Poland great despite her grave external difficulties. Had that dynasty been prolonged for another century, there is every reason to suppose that it would also have dealt satisfactorily with Poland's still more dangerous internal difficulties, and arrested the development of that anarchical constitution which was the ruling factor in the ruin of the Republic.

Simultaneously with the transformation into a great power of the petty principalities which composed ancient Poland, another and equally momentous political transformation was proceeding within the country itself.

The origin of the Polish constitution is to be sought in the *wiecs* or councils of the Polish princes, during the partitioned period (c. 1279-1370). The privileges conferred upon the magnates of which these councils were composed, especially upon the magnates of Little Poland, who brought the Jagiellons to

the throne, directed their policy, and grew rich upon their liberality, revolted the less favoured *szlachta*, or gentry, who, towards the end of the 14th century, combined for mutual defence in their *sejmiki*, or local diets, of which originally there were five, three in Great Poland, one in Little Poland and one in Posen-Kalisz.¹ In these *sejmiki* the deputies of the few great towns were also represented. The Polish towns, notably Cracow, had obtained their privileges, including freedom from tolls and municipal government, from the Crown in return for important services, such as warding off the Tatars, while the cities of German origin were protected by the Magdeburg law. Casimir the Great even tried to make municipal government as democratic as possible by enacting that one half of the town council of Cracow should be elected from the civic patriciate, but the other half from the commonalty. Louis the Great placed the burgesses on a level with the gentry by granting to the town council of Cracow jurisdiction over all the serfs in the extra-rural estates of the citizens. From this time forth deputies from the cities were summoned to the *sejmiki* on all important occasions, such, for instance, as the ratification of treaties, a right formally conceded to them by the *sejmik* of Radom in 1384. Thus at this period Poland was a confederation of half a dozen semi-independent states. The first general assembly of which we have certain notice is the *szlachta walny* which was summoned to Koszyce in November 1404, to relieve the financial embarrassments of Wladislaus, and granted him an extraordinary subsidy of twenty groats per hide of land to enable him to purchase Dobrzyn from the Teutonic Knights. Such subsidies were generally the price for the confirmation of ancient or the concession of new privileges. Thus at the diet of Brześć Kujawski, in 1425, the *szlachta* obtained its first habeas corpus act in return for acknowledging the right of the infant *krolewicz* Wladislaus to his father's throne. The great opportunity of the *szlachta* was, of course, the election of a new king, especially the election of a minor, an event always accompanied and succeeded by disorders. Thus at the election of the infant Wladislaus III., his guardians promised in his name to confirm all the privileges granted by his father. If, on attaining his majority, the king refused to ratify these promises, his subjects were *ipso facto* absolved from their obedience. This is the first existence of the mischievous principle *de prestanda obedientia*, subsequently elevated into a statute. It is in this reign, too, that we meet with the first *rokoss*, or insurrection of the nobility against the executive. The extraordinary difficulties of Casimir IV. were freely exploited by the *szlachta*, who granted that ever impetuous monarch as little as possible, but got full value for every penny they grudgingly gave. Thus by the Articles of Cerekwica presented to him by the *sejmik* or dietine of Great Poland in 1454 on the outbreak of the Teutonic War, he conceded the principle that no war should in future be begun without the consent of the local diets. A few months later he was obliged to grant the Privileges of Nieszawa, which confirmed and extended the operation of the Articles of Cerekwica. The *sejmiki* had thus added to their original privilege of self-taxation the right to declare war and control the national militia.² This was a serious political retrogression. A strongly centralized government had ever been Poland's greatest need, and Casimir the Great had striven successfully against all centrifugal tendencies. And now, eighty-four years after his death, Poland was once more split up into half a dozen loosely federated states in the hands of country gentlemen too ignorant and prejudiced to look beyond the boundaries of their own provinces. The only way of saving the Republic from disintegration was to concentrate all its political factors into a *sejm walny* or general diet. But to this the magnates and the *szlachta* were equally opposed, the former because they feared the rivalry of a national assembly, the latter because they were of more importance in their local diets than they could possibly hope to be in a

general diet. The first *sejm* to legislate for the whole of Poland was the diet of Piotrkow (1493), summoned by John Albert to grant him subsidies; but the mandates of its deputies were limited to twelve months, and its decrees were to have force for only three years. John Albert's second diet (1496), after granting subsidies the burden of which fell entirely on the towns and peasantry, passed a series of statutes benefiting the nobility at the expense of the other classes. Thus one statute permitted the *szlachta* henceforth to export and import goods duty free, to the great detriment of the towns and the treasury. Another statute prohibited the burgesses from holding landed property and enjoying the privileges attaching thereto. A third statute disqualified plebeians from being elected to canonries or bishoprics. A fourth endeavoured to bind the peasantry more closely to the soil by forbidding emigration. The condition of the serfs was subsequently (1520) still further deteriorated by the introduction of socage. In a word, this diet disturbed the equilibrium of the state by enfeebling and degrading the middle classes. Nevertheless, so long as the Jagiello dynasty lasted, the political rights of the cities were jealously protected by the Crown against the usurpations of the nobility. Deputies from the towns took part in the election of John Albert (1492), and the burgesses of Cracow, the most enlightened economists in the kingdom, supplied Sigismund I. with his most capable counsellors during the first twenty years of his reign (1506-1526). Again and again the nobility attempted to exclude the deputies of Cracow from the diet, in spite of a severe edict issued by Sigismund I. in 1509, threatening to prosecute for treason all persons who dared to infringe the liberties of the citizens. During Sigismund's reign, moreover, the Crown recovered many of the prerogatives of which it had been deprived during the reign of his feeble predecessor, Alexander, who, to say nothing of the curtailments of the prerogative, had been forced to accept the statute *nihil novi* (1505) which gave the *sejm* and the senate an equal voice with the Crown in all executive matters. In the latter years of Sigismund I. (1530-1548) the political influence of the *szlachta* grew rapidly at the expense of the executive, and the gentry in diet assembled succeeded in curtailing the functions of all the great officers of state. During the reign of Sigismund II. (1548-1572) they diverted their attention to the abuses of the Church and considerably reduced both her wealth and her privileges. In this respect both the Crown and the country were with them, so that their interference, if violent, was on the whole distinctly beneficial.

The childless Sigismund II. died suddenly without leaving any regulations as to the election of his successor. Fortunately for Poland the political horizon was absolutely unclouded. The Turks, still reeling from the shock of Lepanto, could with difficulty hold their own against the united forces of the pope, Spain and Venice; while Ivan the Terrible had just concluded a truce with Poland. Domestic affairs, on the other hand, were in an almost anarchical condition. The Union of Lublin, barely three years old, was anything but consolidated, and in Lithuania it continued to be extremely unpopular. In Poland proper the *szlachta* were fiercely opposed to the magnates; and the Protestants seemed bent upon still further castigating the clergy. Worst of all, there existed no recognized authority in the land to curb and control its jarring centrifugal political elements. It was nearly two hundred years since the Republic had suffered from an interregnum, and the precedents of 1382 were obsolete. The primate, on hearing of the demise of the Crown, at once invited all the senators of Great Poland to a conference at Lowicz, but passed over the *szlachta* altogether. In an instant the whole Republic was seething like a caldron, and a rival assembly was simultaneously summoned to Cracow by Jan Ferlej, the head of the Protestant party. Civil war was happily averted at the last moment, and a national convention, composed of senators and deputies from all parts of the country, assembled at Warsaw, in April 1573, for the purpose of electing a new king. Five candidates for the throne were already in the field. Lithuania favoured Ivan IV. In Poland the bishops and most of

¹ The Red Russian *sejmik* was of later origin, c. 1433.

² In view of the frequency of the Tatar incursions, the control of the militia was re-transferred to the Crown in 1501.

the Catholic magnates were for an Austrian archduke, while the strongly anti-German *szlachta* were inclined to accept almost any candidate but a German, so long as he came with a gift in his hand and was not a Muscovite. In these circumstances it was an easy task for the adroit and energetic French ambassador, Jean de Montluc (d. 1579), brother of the famous marshal, and bishop of Valence, to procure the election of the French candidate, Henry, duke of Anjou. Well provided with funds, he speedily bought over many of the leading magnates, and his popularity reached its height when he strenuously advocated the adoption of the mode of election by the gentry *en masse* (which the *szlachta* proposed to revive), as opposed to the usual and more orderly "secret election" by a congress of senators and deputies, sitting with closed doors. The religious difficulty, meanwhile, had been adjusted to the satisfaction of all parties by the compact of Warsaw (Jan. 28, 1573), which granted absolute religious liberty to all non-Catholic denominations (*dissidentes de religione*, as they now began to be called) without exception, thus exhibiting a far more liberal intention than the Germans had manifested in the religious peace of Augsburg eighteen years before. Finally, early in April 1573, the election diet assembled at Warsaw, and on the 11th of May, in the midst of intrigue, corruption, violence and confusion, Henry of Valois was elected king of Poland.

The election had, however, been preceded by a *correctura jurum*, or reform of the constitution, which resulted in the famous "Henrican Articles" which converted Henry of Valois, king of Poland from a limited monarchy into a republic 1573-1574, with an elective chief magistrate. Henceforward the king was to have no voice in the choice of his successor. He was not to use the word *haeres*, not being an hereditary sovereign. He was to marry a wife selected for him by the senate. He was neither to seek for a divorce nor give occasion for one. He was to be neutral in all religious matters. He was not to lead the militia across the border except with the consent of the *szlachta*, and then only for three months at a time. Every year the senate was to appoint sixteen of its number to be in constant attendance upon the king in rotas of four, which *sedecimvirs* were to supervise all his actions. Should the king fail to observe any one of these articles, the nation was *ipso facto* absolved from its allegiance. This constitutional reform was severely criticized by contemporary political experts. Some strongly condemned the clause justifying renunciation of allegiance, as tending to treason and anarchy. Others protested against the anomalous and helpless position of the so-called king, who, if he could do no harm, was certainly powerless for good. But such Cassandra prophesied to heedless ears. The Republic had deliberately cast itself upon the downward grade which was to lead to ruin.

The reign of Henry of Valois lasted thirteen months. The tidings of the death of his brother Charles IX., which reached him on the 14th of June 1574, determined him to exchange a thorny for what he hoped would be a flowery throne, and at midnight on the 18th of June 1574 he literally fled from Poland, pursued to the frontier by his indignant and bewildered subjects. Eighteen months later (Dec. 14, 1575), mainly through the influence of Jan Zamoyski, Stephen Báthory, prince of Transylvania, was elected king of Poland by the *szlachta* in opposition to the emperor Maximilian, who had been elected two days previously by the senate, after disturbances which would have rent any other state but Poland to pieces.

The glorious career of Stephen Báthory (1575-1586) is dealt with elsewhere (see STEPHEN, *King of Poland*). His example demonstrates the superiority of genius and valour over the most difficult circumstances. But his reign was too brief to be permanently beneficial.

The Vasa period of Polish history which began with the election of Sigismund, son of John III., king of Sweden, was the epoch of last and lost chances. The collapse of the Muscovite tsardom in the east, and the submersion of the German Empire in the west by the Thirty Years' War, presented Poland with an unprecedented oppor-

tunity of consolidating, once for all, her hard-won position as the dominating power of central Europe. Everywhere circumstances were favourable to her, and in Żółkiewski, Chodkiewicz and Koniecpolski she possessed three of the greatest captains of that or any other age. With all the means at her disposal cheerfully placed in the hands of such valiant and capable ministers, it would have been no difficult task for the Republic to have wrested the best part of the Baltic littoral from the Scandinavian powers, and driven the distracted Muscovites beyond the Volga. Permanent greatness and secular security were within her reach at the commencement of the Vasa period; how was it, then, that at the end of that period, only fifty years later, Poland had already sunk irredeemably into such the same position as Turkey occupies now, the position of a moribund state, existing on sufferance simply because there was yet quite prepared to administer the *coup de grâce*? There is only one answer; the principal cause of this complete and irretrievable collapse is to be sought for in the folly, egotism and selfishness of the Polish gentry, whose insane dislike of all discipline, including even the salutary discipline of regular government, converted Poland into something very like a primitive tribal community at the very time when every European statesman, including the more enlightened of the Poles themselves, clearly recognized that the political future belonged to the strongly centralized monarchies, which were everywhere rising on the ruins of feudalism. Of course there were other contributory causes. The tenacity with which Sigismund III. clung to his hereditary rights to the Swedish Crown involved Poland in a quite unnecessary series of wars with Charles IX. and Gustavus Adolphus, when her forces were sorely needed elsewhere. The adhesion of the same monarch to the League of the Catholic Reaction certainly added to the difficulties of Polish diplomacy, and still further divided the already distracted diet, besides alienating from the court the powerful and popular chancellor Zamoyski. Yet Sigismund III. was a far more designted statesman than any of his counsellors or contraditors. For instance, he was never misled by the successes of the late Demetrius in Muscovy, and wisely insisted on recovering the great eastern fortress of Smolensk rather than attempting the conquest of Moscow. His much-decried alliance with the emperor at the outbreak of the Thirty Years' War was eminently sagacious. He perceived at once that it was the only way of counteracting the restlessness of the sultan's protégés, the Protestant princes of Transylvania, whose undisciplined bands, scarcely less savage than their allies the Turks and Tatars, was a perpetual menace both to Austria and to Poland. Finally he was bent upon reforming the Polish constitution by substituting the decision of all matters by a plurality of votes for a unanimity impossible to count upon.

When we turn to the *szlachta* who absolutely controlled the diet, we find not the slightest trace, I will not say of political foresight—that they never possessed—but of common patriotism, or ordinary public spirit. The most urgent national necessities were powerless to stir their hearts or open their purses. The diets during the reign of Sigismund III. were even more niggardly than they had been under the Jagiells and on the single occasion when the terrors of an imminent Tatar invasion constrained them to grant extraordinary subsidies, they saw to it that such subsidies should rest entirely on the shoulders of the burghesses (who had in the meantime been deprived of the franchise) and the already overburdened peasantry. In the very crisis of the Swedish War, the diminished army of the victorious Chodkiewicz was left unpaid, with the result that the soldiers mutinied, and marched off *en masse*. Both Chodkiewicz and Żółkiewski frequently had to pay the expenses of their campaigns out of their own pockets, and were expected to conquer empires and defend hundreds of miles of frontier with armies of 3000 or 4000 men at most. When they retreated before overwhelming odds they were publicly accused of cowardice and incompetence. The determination to extend still further the power of the executive was at the bottom of this fatal parsimony, with the inevitable consequence that

while the king and the senate were powerless, every great noble or lord-marcher was free to do what he chose in his own domains, so long as he flattered his "little brothers," the *szlachta*. Incredible as it may seem, the expedition to place the false Demetrius on the Muscovite throne was a private speculation of a few Lithuanian magnates, and similar enterprises on the part of other irresponsible noblemen on the Dnieper or Dniester brought upon unhappy Poland retaliatory Tatar raids, which reduced whole provinces to ashes. Every attempt to improve matters, by reforming the impossible constitution, stranded on the opposition of the gentry. Take, for instance, the typical and highly instructive case of Zebrzydowski's rebellion. Nicholas Zebrzydowski, a follower of the chancellor Zamoyski, was one of the wealthiest and most respectable magnates in Poland. As palatine of Cracow he held one of the highest and most lucrative dignities in the state, and was equally famous for his valour, piety and liberality. Disappointed in his hope of obtaining the great seal on the death of Zamoyski, he at once conceived that the whole of the nobility had been insulted in his person, and proceeded to make all government impossible for the next three years. On the 7th of March 1606 Sigismund summoned a diet for the express purpose of introducing the principle of decision by majority in the diet, whereupon Zebrzydowski summoned a counter-confederation to Stenczyn in Little Poland, whose first act was to open negotiations with the prince of Transylvania, Stephen Bocskay, with the view of hiring mercenaries from him for further operations. At a subsequent confederation, held at Lublin in June, Zebrzydowski was reinforced by another great nobleman, Stanislaus Stadnicki, called the Devil, who "had more crimes on his conscience than hairs on his head," and was in the habit of cropping the ears and noses of small squires and chaining his serfs to the walls of his underground dungeons for months at a time. This champion of freedom was very eloquent as to the wrongs of the *szlachta*, and proposed that the assembly should proceed in a body to Warsaw and there formally renounce their allegiance. The upshot of his oratory was the summoning of a *rokosz*, or national insurrection, to Sandomir, which was speedily joined by the majority of the *szlachta* all over the country, who openly proclaimed their intention of dethroning the king and chastising the senate, and sent Stadnicki to Transylvania to obtain the armed assistance of Stephen Bocskay. Only the clergy, naturally conservative, still clung to the king, and Sigismund III., who was no coward, at once proceeded to Cracow to overawe the *rokoszanie*, or insurrectionists, by his proximity, and take the necessary measures for his own protection. By the advice of his senators he summoned a *szjad*, or armed convention, to Wislica openly to oppose the insurrection of Sandomir, which *szjad* was to be the first step towards the formation of a general confederation for the defence of the throne. Civil war seemed inevitable, when the *szlachta* of Red Russia and Sieradz suddenly rallied to the king, who at once ordered his army to advance, and after defeating the insurrectionists at Janowiec (in October), granted them a full pardon, on the sole condition that they should refrain from all such acts of rebellion in future. Despite their promises, Zebrzydowski and his colleagues a few months later were again in arms. In the beginning of 1607 they summoned another *rokosz* to Jendrzew, at the very time when the diet was assembling at Warsaw. The diet authorized the king to issue a proclamation dissolving the *rokosz*, and the *rokosz* retorted with a manifesto in which an insurrection was declared to be as much superior to a parliament as a general council was to a pope. In a second manifesto published at Jezierzna, on the 24th of June, the insurrectionists again renounced their allegiance to the king. Oddly enough, the diet before dissolving had, apparently in order to meet the *rokosz* half-way, issued the famous edict *De non prestanda obedientia*, whereby, in case of future malpractices by the king and his subsequent neglect of at least two solemn warnings there-against by the primate and the senate, he was to be formally deposed by the next succeeding diet. But even this was not enough for the insurrectionists. It was not the contingent but the actual deposition of the king

that they demanded, and they had their candidate for the throne ready in the person of Gabriel Bethlen, the new prince of Transylvania. But the limits of even Polish complacency had at last been reached, and Żolkiewski and Chodkiewicz were sent against the rebels, whom they routed at Oransk near Guzow, after a desperate encounter, on the 6th of July 1607. But, though driven from the field, the agitation simmered all over the country for nearly two years longer, and was only terminated, in 1609, by a general amnesty which excluded every prospect of constitutional reform.

Wladislaus IV., who succeeded his father in 1632, was the most popular monarch who ever sat on the Polish throne. The *szlachta*, who had had a "King Log" in Sigis-^{mund} Wladis-^{mund}, were determined that Wladislaus should be ^{King IV.} "a King Bee who will give us nothing but honey"—1632-1644. In other words they hoped to wheedle him out of even more than they had wrested from his predecessor. Wladislaus submitted to everything. He promised never to declare war or levy troops without the consent of the *sejm*, undertook to fill all vacancies within a certain time, and released the *szlachta* from the payment of income-tax, their one remaining fiscal obligation. This boundless complacency was due to policy, not weakness. The second Polish Vasa was a man of genius, fully conscious of his powers, and determined to use them for the benefit of his country. The events of the last reign had demonstrated the incompetence of the Poles to govern themselves. Any amelioration of the existing anarchy must be extra-parliamentary and proceed from the throne. But a reforming monarch was inconceivable unless he possessed the confidence of the nation, and such confidence, Wladislaus naturally argued, could only be won by striking and undeniable public services. On these principles he acted with brilliant results. Within three years of his accession he compelled the Muscovites (Treaty of Polyankova, May 28, 1634) to retrocede Smolensk and the eastern provinces lost by Sigismund II., overawed the Porte by a military demonstration in October of the same year, and, by the Truce of Stumdorf (Sept. 12, 1635), recovered the Prussian provinces and the Baltic seaboard from Sweden. But these achievements excited not the gratitude but the suspicion of the *szlachta*. They were shrewd enough to guess that the royal triumph might prejudice their influence, and for the next five years they deliberately thwarted the enlightened and far-reaching projects of the king for creating a navy and increasing the revenue without burdening the estates, by a system of tolls levied on the trade of the Baltic ports (see WLADISLAUS IV.), even going so far as to refuse for nine years to refund the expenses of the Muscovite War, which he had defrayed out of his privy purse. From sheer weariness and disgust the king refrained from any intervention in public affairs for nearly ten years, looking on indifferently while the ever shorter and stormier diets wrangled perpetually over questions of preferment and the best way of dealing with the extreme dissenters, to the utter neglect of public business. But towards the end of his reign the energy of Wladislaus revived, and he began to occupy himself with another scheme for regenerating his country, in its own despite, by means of the Cossacks. First, however, it is necessary to describe briefly the origin and previous history of these romantic freebooters who during the second half of the 17th century were the determining factor of Polish and Muscovite politics.

At the beginning of the 16th century the illimitable steppe of south-eastern Europe, extending from the Dnieper to the Urals, had no settled population. Hunters and ^{The} fisherman frequented its innumerable rivers, return-^{Comacks.} ing home laden with rich store of fish and pelts, while runaway serfs occasionally settled in small communities beneath the shelter of the fortresses built, from time to time, to guard the southern frontiers of Poland and Muscovy. Obligated, for fear of the Tatars, to go about with arms in their hands, these settlers gradually grew strong enough to raid their raiders, selling the booty thus acquired to the merchants of Muscovy and Poland. Moreover, the Turks and Tatars being the natural enemies of Christendom, a war of extermination

against them' was regarded by the Cossacks as a sacred duty. Curiously enough, these champions of orthodoxy borrowed the name, which has stuck to them ever since, from their "dog-headed" adversaries. The rank and file of the Tatar soldiery were known as *Kazaki*, or Cossacks, a word meaning "freebooters," and this term came to be applied indiscriminately to all the free dwellers in the *Ukraine*, or border-lands. As time went on the Cossacks multiplied exceedingly. Their daring grew with their numbers, and at last they came to be a constant annoyance to all their neighbours, both Christian and Mussulman, frequently involving Poland in dangerous and unprofitable wars with the Ottoman Empire. Indeed, it is not too much to say that, until the days of Sobieski, the Cossacks were invariably the chief cause of the breaches between the Porte and the Republic. We have seen how carefully the Jagiellos avoided participating in any of the crusades directed by the Holy See against the arch-enemies of the Cross. So successful was their prudential abstention that no regular war occurred between Turkey and Poland during the two centuries of their sway. The first actual collisions, the Cecora campaign of 1620 and the Khotin War of 1621 (for John Albert's Moldavian raid does not count), were due to the depredations of the Cossacks upon the dominions of the sultan by land and sea, and in all subsequent treaties between the two powers the most essential clause was always that which bound the Republic to keep its freebooters in order.

But in the meantime the Cossacks themselves had become a semi-independent community. The origin of the Cossack state is still somewhat obscure, but the germs of it are visible as early as the beginning of the 16th century. The union of Lublin, which led to the polonization of Lithuania, was the immediate occasion of a considerable exodus to the lowlands of the Dnieper of those serfs who desired to escape from the taxes of the Polish government and the tyranny of the Polish landlords. Stephen Báthory presently converted the pick of them into six registered regiments of 1000 each for the defence of the border. Ultimately the island of Horica, just below the falls of the Dnieper, was fixed upon as their headquarters; and on the numerous islands of that broad river there gradually arose the famous Cossack community known as the *Zaporozhskaya Szech*, or Settlement behind the Falls, whence the Dnieperian Cossacks were known, generally, as *Zaporozhians*, or Backfallsmen.¹ The Cossack *kosh*, or commonwealth, had the privilege of electing its *hetman*, or chief, and his chief officers, the *starshins*. The *hetman*, after election, received from the king of Poland direct the insignia of his office, viz. the *bulawa*, or bâton, the *bunchuk*, or horse-tail standard, and his official seal; but he was responsible for his actions to the *kosh* alone, and an inquiry into his conduct was held at the expiration of his term of office in the *obshchaya shkoda*, or general assembly. In time of peace his power was little more than that of the responsible minister of a constitutional republic; but in time of warfare he was a dictator, and disobedience to his orders in the field was punishable by death.

The Cossacks were supposed to be left alone as much as possible by the Polish government so long as they faithfully fulfilled their chief obligation of guarding the frontiers of the Republic from Tatar raids. But the relations between a community of freebooters, mostly composed of fugitive serfs and refugees, and a government of small squires who regarded the Cossacks as a mere rabble were bound to be difficult at the best of times, and political and religious differences presently supervened. The Cossacks, mostly of Lithuanian origin, belonged to the Orthodox religion, so far as they belonged to any religion at all, and the Jagiellos had been very careful to safeguard the religious liberties of their Lithuanian subjects, especially as the Poles themselves were indifferent on the subject. But, at the beginning of the 17th century, when the current of the Catholic reaction was running very strongly and the Jesuits, after subduing the Protestants, began to undermine the position of the Orthodox Church in Lithuania, a more intolerant spirit

¹ Cf. American, Backwoodsmen.

began to prevail. The old Calvinist nobility of Lithuania were speedily reconverted; a Uniate Church in connexion with Rome was established; Greek Orthodox congregations, if not generally persecuted, were at least depressed and straitened; and the Cossacks began to hate the *Pans*, or Polish lords, not merely as tyrants, but as heretics. Yet all these obstacles to a good understanding might, perhaps, have been surmounted if only the Polish diet had treated the Cossacks with common fairness and common sense. In 1619 the Polish government was obliged to prohibit absolutely the piratical raids of the Cossacks in the Black Sea, where they habitually destroyed Turkish property to the value of millions. At the same time, by the compact of Rastawica, the *sejm* undertook to allow the Cossacks, partly as wages, partly as compensation, 40,000 (raised by the compact of Kurukow to 60,000) *gulden* and 170 wagons of cloth per annum. These terms were never kept, despite the earnest remonstrances of the king, and the complaints of the aggrieved borderers. Parsimony prevailed, as usual, over prudence, and when the Cossacks showed unmistakable signs of restiveness, the Poles irritated them still further by ordering the construction of the strong fortress of Kudak at the confluence of the Dnieper and the Samara, to overawe the Zaporozhian community. This further act of repression led to two terrible Cossack risings, in 1635 and 1636, put down only with the utmost difficulty, whereupon the diet of 1638 deprived the Cossacks of all their ancient privileges, abolished the elective hetmanship, and substituted for it a commission of Polish noblemen with absolute power, so that the Cossacks might well declare that those who hated them were lords over them.

Such was the condition of affairs in the Ukraine when Wladislaus IV. proposed to make the Cossacks the pivot of his foreign policy and his domestic reforms. His far-reaching plans were based upon two facts, the absolute devotion of the Zaporozhians to himself personally, and the knowledge, secretly conveyed to him by Stanislaus Koniecpolaki (q.v.), that the whole of the Ukraine was in a ferment. He proposed to provoke the Tatars to a rupture by repudiating the humiliating tribute with which the Republic had so long and so vainly endeavoured to buy of their incessant raids. In case of such rupture he meant, at the head of 100,000 Cossacks, to fall upon the Crimea itself, the seat of their power, and exterminate the Khanate. This he calculated would bring about a retaliatory invasion of Poland by the Turks, which would justify him in taking the field against them also with all the forces of the Republic. In case of success he would be able to impose the will of a victorious king upon a discredited diet, and reform the constitution on an English or Swedish model. Events seemed at first to favour this audacious speculation. Almost simultaneously a civil war broke out in the Crimea and the Porte declared war against the Venetian republic, with which Wladislaus at once concluded an offensive and defensive alliance (1645). He then bade the Cossacks prepare their boats for a raid upon the Turkish galleys, and secured the co-operation of the tsar in the Crimean expedition by a special treaty. Unfortunately, Venice, for her own safety's sake, insisted on the publication of Wladislaus's anti-Turkish alliance; the Porte, well informed of the course of Polish affairs, remained strictly neutral despite the most outrageous provocations; and Wladislaus, bound by his coronation oath not to undertake an offensive war, found himself at the mercy of the diet which, full of consternation and rage, assembled at Warsaw on the 2nd of May 1647. It is needless to say that the Venetian alliance was repudiated and the royal power still further reduced. A year later Wladislaus died at his hunting-box at Merezec, at the very moment when the long-impending tempest which he himself had conjured up burst with overwhelming fury over the territories of the Republic.

The prime mover of the great rebellion of 1648, which shook the Polish state to its very foundations, was the Cossack Bohdan Chmielnicki (q.v.), who had been initiated in all the plans of Wladislaus IV. and, with good reason, feared to be the first victim of the Polish magnates when the king's designs were

unmasked and frustrated. To save himself he hit upon the novel and terrible expedient of uniting the Tatars and the Cossacks

Cossack in a determined onslaught upon the Republic, whose *Rebellion of inward weakness, despite its brave outward show, 1648.*

he had been quick to discern. On the 18th of April 1648, at the general assembly of the Zaporozhians, he openly expressed his intention of proceeding against the Poles and was elected hetman by acclamation; on the 19th of May he annihilated a small detached Polish corps on the banks of the river Zhehndya Vodui, and seven days later overwhelmed the army of the Polish grand-hetman, massacring 8500 of his 10,000 men and sending the grand-hetman himself and all his officers in chains to the Crimea. The immediate consequence of these victories was the outburst of a *khlopshaya sloba*, or "series' fury." Throughout the Ukraine the gentry were hunted down, flayed, burnt, blinded and sawn asunder. Every manor-house and castle was reduced to ashes. Every Uniate or Catholic priest who could be caught was hung up before his own high altar, along with a Jew and a hog. The panic-stricken inhabitants fled to the nearest strongholds, and soon the rebels were swarming over the palatinates of Volhynia and Podolia. Meanwhile the Polish army, 40,000 strong, with 100 guns, was assembling on the frontier. It consisted almost entirely of the noble militia, and was tricked out with a splendour more befitting a bridal pageant than a battle array. For Chmielnicki and his host these splendid cavaliers expressed the utmost contempt. "This rabble must be chased with whips, not smitten with swords," they cried. On the 23rd of September the two armies encountered near Pildawa, and after a stubborn three days' contest the gallant Polish pageant was scattered to the winds. The steppe for miles around was strewn with corpses, and the Cossacks are said to have reaped 10,000,000 guildens worth of booty when the fight was over. All Poland now lay at Chmielnicki's feet, and the road to the defenceless capital was open

John II. before him; but he wasted two precious months in Casimir's vain before the fortress of Zamosc, and then the newly elected king of Poland, John Casimir, Wladislaus IV.'s brother, privately opened negotiations with the rebel,

officially recognized him by sending him the *bulawa* and the other insignia of the *hetman's* dignity, and promised his "faithful Zaporozhians" the restoration of all their ancient liberties if they would break off their alliance with the Tatars and await the arrival of peace commissioners at Pereyaslav. But the negotiations at Pereyaslav came to nothing. Chmielnicki's conditions of peace were so extravagant that the Polish commissioners durst not accept them, and in 1649 he again invaded Poland with a countless host of Cossacks and Tatars. Again, however, he made the mistake of attacking a fortress, which delayed his advance for a month, and gave John Casimir time to collect an army for the relief of the besieged. By the compact of Zborow (Aug 21, 1649) Chmielnicki was recognized as *hetman* of the Zaporozhians, whose registered number was now raised from 6000 to 40,000; a general amnesty was also granted, and it was agreed that all official dignities in the Orthodox palatinates of Lithuania should henceforth be held solely by the Orthodox gentry. For the next eighteen months Chmielnicki ruled the Ukraine like a sovereign prince. He made Chigirin, his native place, the Cossack capital, subdivided the country into sixteen provinces, and entered into direct relations with foreign powers. His attempt to carve a principality for his son out of Moldavia led to the outbreak of a third war between suzerain and subject in February 1651. But fortune, so long Bohdan's friend, now deserted him, and at Beresteczko (July 1, 1651) the Cossack chieftain was utterly routed by Stephen Czarniecki. All hope of an independent Cossackdom was now at an end; yet it was not Poland but Muscovy which reaped the fruits of Czarniecki's victory.

Chmielnicki, by suddenly laying bare the nakedness of the Polish republic, had opened the eyes of Muscovy to the fact that her secular enemy was no longer formidable. Three years after his defeat at Beresteczko, Chmielnicki, finding himself unable to cope with the Poles single-handed, very reluctantly

transferred his allegiance to the tsar, and the same year the tsar's armies invaded Poland, still bleeding from the all but mortal wounds inflicted on her by the Cossacks. The war thus begun, and known in Russian history as the *The Russian Thirteen Years' War*, far exceeded even the *Thirty Years' War* in grossness and brutality. It resembled

nothing so much as a hideous scramble of ravening beasts and obscene fowls for the dismembered limbs of a headless carcass, for such did Poland seem to all the world before the war was half over. In the summer of 1655, moreover, while the Republic was still reeling beneath the shock of the Muscovite invasion, Charles X. of Sweden, on the flimsiest of pretexts, *invasion of Charles X. simply to gratify his greed of martial glory, and of Sweden, 1655.*

before the year was out his forces had occupied the capital, the coronation city and the best half of the land. King John Casimir, betrayed and abandoned by his own subjects, fled to Silesia, and profiting by the cataclysm which, for the moment, had swept the Polish state out of existence, the Muscovites, unopposed, quickly appropriated nearly everything which was not already occupied by the Swedes. At this crisis Poland owed her salvation to two events—the formation of a general league against Sweden, brought about by the apprehensive court of Vienna and an almost simultaneous popular outburst of religious enthusiasm on the part of the Polish people. The first of these events, to be dated from the alliance between the emperor Leopold and John Casimir, on the 27th of May 1657, led to a truce with the tsar and the welcome diversion of all the Muscovite forces against Swedish Livonia. The second event, which began with the heroic and successful defence of the monastery of Czenstochowa by Prior Kordecki against the Swedes, resulted in the return of the Polish king from exile, the formation of a national army under Stephen Czarniecki and the recovery of almost all the lost provinces from the Swedes, who were driven back headlong to the sea, where with difficulty they held their own. On the sudden death of Charles X. (Feb. 13, 1660), Poland gladly seized the opportunity of adjusting all her outstanding differences with Sweden. By the peace of Oliva (May 3, 1660), made under French mediation, John Casimir ceded Livonia, and renounced all claim to the Swedish crown. The war with Muscovy was then prosecuted with renewed energy and extraordinary success. In the autumn of 1661 the Russian commanders were routed at Zeromsk, and nearly all the eastern provinces were recovered. In 1664 a peace congress was opened at Andrusowich and the prospects of Poland seemed most brilliant; but at the very moment when she needed all her armed strength to sustain her diplomacy, the rebellion of one of her leading magnates, Prince Lubomirsky, involved her in a dangerous civil war, compelled her to reopen negotiations with the Muscovites, at Andrusowo, under far more unfavourable conditions, and after protracted negotiations practically to accept the Muscovite terms. By the truce of Andrusowo (Feb. 11, 1667) Poland received back *The Truce from Muscovy Vitebsk, Polotsk and Polish Livonia, of Andrusowo, 1667.* but ceded in perpetuity Smolensk, Sjevversk, Chernigov and the whole of the eastern bank of the Dnieper, including the towns of Konotop, Gadyach, Pereyaslavi, Mirgorod, Poltava and Izyum. The Cossacks of the Dnieper were henceforth to be under the joint dominion of the tsar and the king of Poland. Kiev, the religious metropolis of western Russia, was to remain in the hands of Muscovy for two years.

The "truce" of Andrusowo proved to be one of the most permanent paces in history, and Kiev, though only pledged for two years, was never again to be separated from the Orthodox Slavonic state to which it rightly belonged. But for the terrible and persistent ill-luck of Poland it is doubtful whether the "truce" of Andrusowo would ever have been signed. The war which it concluded was to be the last open struggle between the two powers. Henceforth the influence of Russia over Poland was steadily to increase, without any struggle at all, the Republic being already stricken with that creeping paralysis which ultimately left her a prey to her neighbours. Muscovy

had done with Poland as an adversary, and had no longer any reason to fear her ancient enemy.

Poland had, in fact, emerged from the cataclysm of 1648-1667 a moribund state, though her not unskilful diplomacy had enabled her for a time to save appearances. Her territorial losses, though considerable, were, in the circumstances, not excessive, and she was still a considerable power in the opinion of Europe. But a fatal change had come over the country during the age of the Vasas. We have already seen how the ambition of the oligarchs and the lawlessness of the *szlachta* had reduced the executive to impotence, and rendered anything like rational government impossible. But these demoralizing and disintegrating influences had been suspended by the religious revival due to the Catholic reaction and the Jesuit propaganda, a revival which reached its height towards the end of the 16th century. This, on the whole, salutary and edifying movement permeated public life, and produced a series of great captains who cheerfully sacrificed themselves for their country, and would have been saints if they had not been heroes. But this extraordinary religious revival had wellnigh spent itself by the middle of the 17th century. Its last manifestation was the successful defence of the monastery of Czenstochowa by Prior Kordecki against the finest troops in Europe, its last representative was Stephen Czarniecki, who brought the fugitive John Casimir back from exile and reinstated him on his tottering throne. The succeeding age was an age of unmitigated egoism,

Corruption in which the old ideals were abandoned and the old *Corruption* examples were forgotten. It synchronized with, and *in Poland*, was partly determined by, the new political system

which was spreading all over Europe, the system of dynastic diplomatic competition and the unscrupulous employment of unlimited secret service funds. This system, which dates from Richelieu and culminated in the reign of Louis XIV., was based on the secular rivalry of the houses of Bourbon and Habsburg, and presently divided all Europe into two hostile camps. Louis XIV. is said to have expended 50,000,000 livres a year for bribing purposes, the court of Vienna was scarcely less liberal, and very soon nearly all the monarchs of the Continent and their ministers were in the pay of one or other of the antagonists. Poland was no exception to the general rule. Her magnates, having already got all they could out of their own country, looked eagerly abroad for fresh El Dorados. Before long most of them had become the hirelings of France or Austria, and the value demanded for their wages was, not infrequently, the betrayal of their own country. To do them justice, the *szlachta* at first were not only free from the taint of official corruption, but endeavoured to fight against it. Thus, at the election diet of 1669, one of the deputies, Pieniaszek, moved that a new and hitherto unheard-of clause should be inserted in the agenda of the general confederation, to the effect that every senator and deputy should solemnly swear not to take bribes, while another *szlachta* proposed that the ambassadors of foreign Powers should be excluded permanently from the Polish elective assemblies. But the flighty and ignorant *szlachta* not only were incapable of any sustained political action, but they themselves unconsciously played into the hands of the enemies of their country by making the so-called *liberum veto* an integral part of the Polish constitution. The *liberum veto* was based on the assumption of the absolute political equality of every Polish gentleman, with the inevitable corollary that every measure introduced into the Polish diet must be adopted unanimously. Consequently, if any single deputy believed that a measure already approved of by the rest of the house might be injurious to his constituency, he had the right to rise and exclaim *nie pozwalam*, "I disapprove," when the measure in question fell at once to the ground. Subsequently this vicious principle was extended still further. A deputy, by interposing his individual veto, could at any time dissolve the diet, when all measures previously passed had to be re-submitted to the consideration of the following diet. The *liberum veto* seems to have been originally devised to cut short interminable debates in times of acute crisis, but it was generally used either by highly placed criminals, anxious to avoid an

inquiry into their misdeeds,¹ or by malcontents, desirous of embarrassing the executive. The origin of the *liberum veto* is obscure, but it was first employed by the deputy Wladislaus Siciński, who dissolved the diet of 1652 by means of it, and before the end of the 17th century it was used so frequently and recklessly that all business was frequently brought to a standstill. In later days it became the chief instrument of foreign ambassadors for dissolving inconvenient diets, as a deputy could always be bribed to exercise his veto for a handsome consideration.

The Polish crown first became an object of universal competition in 1573, when Henry of Valois was elected. In 1575, and again in 1587, it was put up for public auction, when the Hungarian Báthory and the Swede Sigismund respectively gained the prize. But at all three elections, though money and intrigue were freely employed, they were not the determining factors of the contest. The Polish gentry were still the rumpires as well as the stake-holders; the best candidates generally won the day; and the defeated competitors were driven out of the country by force of arms if they did not take their discomfiture, after a fair fight, like sportsmen. But with the election of Michael Wiśniowiecki in 1669 a new era began. In this case a native Pole was freely elected by the unanimous vote of his countrymen. Yet a few weeks later the Polish commander-in-chief formed

Election of Michael Wiśniowiecki, 1669-1672.

a whole series of conspiracies for the purpose of dethroning his lawful sovereign, and openly placed himself beneath the protection of Louis XIV. of France, just as the rebels of the 18th century placed themselves under the protection of Catherine II. of Russia. And this rebel was none other than John Sobieski, at a later day the heroic deliverer of Vienna! If heroes could so debase themselves, can we wonder if men who were not heroes lent themselves to every sort of villainy? We have come, in fact, to the age of utter shamelessness, when disappointed place-hunters openly invoked foreign aid against their own country. Sobieski himself, as John III. (he succeeded Michael in 1674), was to pay the penalty of his past lawlessness, to the uttermost farthing.

John III. Sobieski, 1674-1696.

Despite his brilliant military achievements (see JOHN III., KING OF POLAND), his reign of twenty-two years was a failure. His victories over the Turks were fruitless so far as Poland was concerned. His belated attempts to reform the constitution only led to conspiracies against his life and crown, in which the French faction, which he had been the first to encourage, took an active part. In his later years Lithuania was in a state of chronic revolt, while Poland was bankrupt both morally and materially. He died a broken-hearted man, prophesying the inevitable ruin of a nation which he himself had done so much to demoralize.

It scarcely seemed possible for Poland to sink lower than she had sunk already. Yet an era was now to follow, compared with which even the age of Sobieski seemed to be an age of gold. This was the Saxon period which, with occasional violent interruptions, was to drag on for nearly seventy years. By the time it was over Poland was irretrievably doomed. It only remained to be seen how that doom would be accomplished.

On the death of John III. no fewer than eighteen candidates for the vacant Polish throne presented themselves. Austria supported James Sobieski, the eldest son of the late king, France Francis Louis Prince of Conti (1664-1704, 1709), but the successful competitor was Frederick Augustus, elector of Saxony, who cheerfully renounced Lutheranism for the coveted crown, and won the day because he happened to arrive last of all, with fresh funds, when the agents of his rivals had spent all their money. He was crowned, as Augustus II., on the 15th of September 1697, and his first act was to expel from the country the prince of Conti, the elect of a respectable minority, directed by the cardinal primate Michal Radziejowski (1645-1705), whom Augustus II. subsequently bought over for 75,000 thalers.

Augustus II., 1697-1704.

¹ Thus the Sapiehas, who had been living on rapine for years, dissolved the diet of 1688 by means of the veto of one of their hirelings, for fear of an investigation into their conduct.

Good luck attended the opening years of the new reign. In 1699 the long Turkish War, which had been going on ever since 1683, was concluded by the peace of Karlowitz, whereby Podolia, the Ukraine and the fortress of Kamenets Podolskiy were retroceded to the Republic by the Ottoman Porte. Immediately afterwards Augustus was persuaded by the plausible Livonian exile, Johan Reinhold Patkul, to form a nefarious league with Frederick of Denmark and Peter of Russia, for the purpose of despoiling the youthful king of Sweden, Charles XII. (see SWEDEN: History). This he did as elector of Saxony, but it was the unfortunate Polish republic which paid for Charles XII hazardous speculation of its newly elected king. Throughout the Great Northern War (see SWEDEN: History), which wasted northern and central Europe for twenty years (1700-1720), all the belligerents treated Poland as if she had no political existence. Swedes, Saxons and Russians not only lived upon the country, but plundered it systematically. The diet was the humble servant of the conqueror of the moment, and the leading magnates chose their own sides without the slightest regard for the interests of their country, the Lithuanians for the most part supporting Charles XII, while the Poles divided their allegiance between Stanislaus Augustus and Stanislaus Leszczyński, whom Charles placed upon the throne in 1704 and kept there till 1709. At the end of the war Poland was ruined materially as well as politically. Augustus attempted to indemnify himself for his failure to obtain Livonia, his covenanted share of the Swedish plunder, by offering Frederick William of Prussia Courland, Polish Prussia and even part of Great Poland, provided that he were allowed a free hand in the disposal of the rest of the country. When Prussia declined this tempting offer for fear of Russia, Augustus went a step farther and actually suggested that "the four eagles" should divide the banquet between them. He died, however (Feb. 1, 1733) before he could give effect to this shameful design.

On the death of Augustus II., Stanislaus Leszczyński, who had, in the meantime, become the father-in-law of Louis XV., attempted to regain his throne with the aid of a small French army corps and 4,000,000 livres from Versailles. Some of the best men in Poland, including the Czartoryscy, were also in his favour, and on the 26th of August 1733 he was elected king for the second time. But there were many malcontents, principally among the Lithuanians, who solicited the intervention of Russia in favour of the elector of Saxony, son of the late king, and in October 1733 a Russian army appeared before Warsaw and compelled a phantom diet (it consisted of but 15 senators and Augustus 500 of the *szlachta*) to proclaim Augustus III. From the end of 1733 till the 30th of June 1734 Stanislaus and his partisans were besieged by the Russians in Danzig, their last refuge, and with the surrender of that fortress the cause of Stanislaus was lost. He retired once more to his little court in Lorraine, with the title of king, leaving Augustus III. in possession of the kingdom.

Augustus III. was disqualified by constitutional indolence from taking any active part in affairs. He left everything to his omnipotent minister, Count Heinrich Brühl, and Brühl entrusted the government of Poland to the Czartoryscy, who had intimate relations of long standing with the court of Dresden.

The Czartoryscy, who were to dominate Polish politics for the next half-century, came of an ancient Ruthenian stock which had intermarried with the Jagiellons at an early date, and had always been remarkable for their civic virtues and political sagacity. They had powerfully contributed to the adoption of the Union of Lublin; were subsequently received into the Roman Catholic Church; and dated the beginning of their influence in Poland proper from the time (1674) when Florian Czartoryski became primate there. Florian's nephews, Fryderyk Michal and Augustus, were now the principal representatives of "the Family," as their opponents sarcastically called them. The former, through the influence of Augustus's minister and favourite Brühl, had become, in his twenty-eighth year, vic-

¹ The fourth eagle was the White Eagle, *sc.* Poland.

chancellor and subsequently grand chancellor of Lithuania, was always the political head of the family. His brother and Augustus, after fighting with great distinction against the Turks both by land and sea (Prince Eugene decorated him with a sword of honour for his valour at the siege of Belgrade), had returned home to marry Sophia Sieniawska, whose fabulous dowry won for her husband the sobriquet of "the Family Croesus." Their sister Constantia had already married Stanislaus Poniatowski, the father of the future king. Thus wealth, position, court influence and ability combined gave the Czartoryscy a commanding position in Poland, and, to their honour be it said, they had determined from the first to save the Republic, whose impending ruin in existing circumstances they clearly foresaw, by a radical constitutional reconstruction which was to include the abolition of the *liberum veto* and the formation of a standing army.

Unfortunately the other great families of Poland were obstinately opposed to any reform or, as they called it, any "violation" of the existing constitution. The Potoccy, whose possessions in south Poland and the Ukraine covered thousands of square miles, the Radziwillowie, who were omnipotent in Lithuania and included half a dozen millionaires² amongst them, the Lubomirscy and their fellows, hated the Czartoryscy because they were too eminent, and successfully obstructed all their well-meant efforts. The castles of these great lords were the foci of the social and political life of their respective provinces. Here they lived like little princes, surrounded by thousands of retainers, whom they kept for show alone, making no attempt to organize and discipline this excellent military material for the defence of their defenceless country. Here congregated hundreds of the younger *szlachta*, fresh from their school benches, whence they brought nothing but a smattering of Latin and a determination to make their way by absolute subservience to their "elder brethren," the *pasns*. These were the men who, a little later, at the bidding of their "benefactors," dissolved one inconvenient diet after another; for it is a significant fact that during the reigns of the two Augustuses every diet was dissolved in this way by the hirings of some great lord or, still worse, of some foreign potentate. In a word constitutional government had practically ceased, and Poland had become an arena in which contending clans strove together for the mastery.

It was against this primitive state of things that the Czartoryscy struggled, and struggled in vain. First they attempted to abolish the *liberum veto* with the assistance of the Saxon court where they were supreme, but fear of foreign complications and the opposition of the Potoccy prevented anything being done. Then they broke with their old friend Brühl and turned to Russia. Their chief intermediary was their nephew Stanislaus Poniatowski, whom they sent, as Saxon minister, to the Russian court in the suite of the English minister Hanbury Williams, in 1755. The handsome and insinuating Poniatowski speedily won the susceptible heart of the grand-duchess Catherine, but he won nothing else and returned to Poland in 1759 somewhat discredited. Disappointed in their hopes of Russia, the Czartoryscy next attempted to form a confederation for the deposition of Augustus III.; but while the strife of factions was still at its height the absentee monarch put an end to the struggle by expiring, conveniently, on the 5th of October 1763.

The interregnum occurring on the death of Augustus III. befell at a time when all the European powers, exhausted by the Seven Years' War, earnestly desired peace. The position of Poland was, consequently, much more advantageous than it had been on every other similar occasion, and if only the contending factions had been able to agree and unite, the final catastrophe might, perhaps, even now, have been averted. The Czartoryscy, of all men, were bound by their principles and professions to set their fellow citizens an example of fraternal concord. Yet they rejected with scorn and derision the pacific overtures of their political opponents, the Potoccy, the Radziwillowie, and the Branisicy, Prince Michal openly declaring that of two tyrannies he preferred the tyranny of the Muscovite to the

² Michal Kazimierz Radziwill alone was worth thirty millions.

tyranny of his equals. He had in fact already summoned a Russian army corps to assist him to reform his country, which sufficiently explains his own haughtiness and the unwonted complacency of the rival magnates.

The simplicity of the Czartoryscy was even more mischievous than their haughtiness. When the most enlightened statesmen of the Republic could seriously believe in the benevolent intentions of Russia the end was not far off. Their naive expectations were very speedily disappointed. Catherine II. and Frederick II. had already determined (Treaty of St Petersburg, April 22, 1764) that the existing state of things in Poland must be maintained, and as early as the 18th of October 1763 Catherine had recommended the election of Stanislaus Poniatowski as "the individual most convenient for our common interests." The personal question did not interest Frederick: so long as Poland was kept in an anarchical condition he cared not who was called king. Moreover, the opponents of the Czartoryscy made no serious attempt to oppose the entry of the Russian troops. At least 40,000 men were necessary for the purpose, and these could have been obtained for 200,000 ducats; but a congress of magnates, whose collective fortunes amounted to hundreds of millions, having decided that it was impossible to raise this sum, there was nothing for it but to fight a few skirmishes and then take refuge abroad. The Czartoryscy now fancied themselves the masters of the situation. They at once proceeded to pass through the convocation diet a whole series of salutary measures. Four special commissions were appointed to superintend the administration of justice, the police and the finances. The extravagant powers of the grand *hetmans* and the grand marshals were reduced. All financial and economical questions before the diet were henceforth to be decided by a majority of

Stanislaus votes. Shortly afterwards Stanislaus Poniatowski *St. Paul-* was elected king (Sept. 7, 1764) and crowned (Nov. 25). But at the beginning of 1766 Prince Nicholas Repnin was sent as Russian minister to Warsaw with instructions which can only be described as a carefully elaborated plan for destroying the Republic. The first weapon employed was the dissident question. At that time the population of Poland was, in round numbers, 11,500,000, of whom about 1,000,000 were dissidents or dissenters. Half of these were the Protestants of the towns of Polish Prussia and Great Poland, the other half was composed of the Orthodox population of Lithuania. The dissidents had no political rights, and their religious liberties had also been unjustly restricted; but two-thirds of them being agricultural labourers, and most of the rest artisans or petty tradesmen, they had no desire to enter public life, and were so ignorant and illiterate that their new protectors, on a closer acquaintance, became heartily ashamed of them. Yet it was for these persons that Repnin, in the name of the empress, now demanded absolute equality, political and religious, with the gentlemen of Poland. He was well aware that an aristocratic and Catholic assembly like the *sejm* would never concede so preposterous a demand. He also calculated that the demand itself would make the *szlachta* suspicious of all reform, including the Czartoryscian reforms, especially as both the king and his uncles were generally unpopular, as being innovators under foreign influence. His calculations were correct. The *sejm* of 1766 not only rejected the dissident bill, but repealed all the Czartoryscian reforms and insisted on the retention of the *liberum veto* as the foundation of the national liberties. The discredit into which Stanislaus had now fallen encouraged the Saxon party, led by Gabriel Podoski (1710-1777), to form a combination for the purpose of dethroning the king. Repnin knew that the allied courts would never consent to such a measure; but he secretly encouraged the plot for his own purposes, with signal success. Early in 1767 the malcontents, fortified by the adhesion of the leading *Catherine II.* political refugees, formed a confederation at Radom, *of Russia* whose first act was to send a deputation to St *and Poland* Petersburg, petitioning Catherine to guarantee the liberties of the Republic, and allow the form of the Polish constitution to be settled by the Russian ambassador at

Warsaw. With this *carta blanche* in his pocket, Repnin proceeded to treat the diet as if it were already the slave of the Russian empress. But despite threats, wholesale corruption and the presence of Russian troops outside and even inside the *sejm*, or chamber of deputies, the patriots, headed by four bishops, Woclaw Hieronim Sierakowski (1699-1784) of Lemberg, Feliks Pawel TurSKI of Chelm (1729-1800), Kajetan Ignaty Soltyk of Cracow (1715-1788), and Józef Jędrzej Zaluski of Kiev (1702-1774), offered a determined resistance to Repnin's demands. Only when brute force in its extreme form had been ruthlessly employed, only when three senators and some deputies had been arrested in full session by Russian grenadiers and sent as prisoners to Kaluga, did the opposition collapse. The *liberum veto* and all the other ancient abuses were now declared unalterable parts of the Polish constitution, which was placed under the guarantee of Russia. All the edicts against the dissidents were, at the same time, repealed.

This shameful surrender led to a Catholic patriotic uprising, known as the Confederation of Bar, which was formed on the 20th of February 1768, at Bar in the Ukraine, by *Confeder-* a handful of small squires. It never had a chance *ation of Bar* of permanent success, though, feebly fed by French subsidies and French volunteers, it lingered on for four years, till finally suppressed in 1772. But, insignificant itself, it was the cause of great events. Some of the Bar confederates, scattered by the Russian regulars, fled over the Turkish border, pursued by their victors. The Turks, already alarmed at the progress of the Russians in Poland, and stimulated by Vergennes, at that time French ambassador at Constantinople, at once declared war against Russia. Seriously disturbed at the prospect of Russian aggrandizement, the idea occurred, almost simultaneously, to the courts of Berlin and Vienna that the best mode of preserving the equilibrium of Europe was for all three powers to readjust their territories at the expense of Poland. The idea of a partition of Poland was nothing new, but the vastness of the country, and the absence of sufficiently powerful and united enemies, had hitherto saved the Republic from spoliation. But now that Poland lay utterly helpless and surrounded by the three great military monarchies of Europe, nothing could save her. In February 1769 Frederick sent Count Rochus Friedrich Lynar (1708-1783) to St Petersburg to sound the empress as to the expediency of a partition, in August Joseph II. solicited an interview with Frederick, and in the course of the summer the two monarchs met, first at Neisse in Silesia and again at Neustadt in Moravia. Nothing definite as to Poland seems to have been arranged, but Prince Kaunitz, the Austrian chancellor, was now encouraged to take the first step by occupying, in 1770, the county of Zips, which had been hypothecated by Hungary to Poland in 1442 and never redeemed. This act decided the other confederates. In June 1770 Frederick surrounded those of the Polish provinces he coveted with a military cordon, ostensibly to keep out the cattle plague. Catherine's consent had been previously obtained by a special mission of Prince Henry of Prussia to the Russian capital. *First Part-* The first treaty of partition was signed at St Petersburg *ition of* between Prussia and Russia on the 6-17th of *Poland,* February 1772; the second treaty, which admitted *1772.* Austria also to a share of the spoil, on the 5-16th of August the same year. It is unnecessary to recapitulate the unheard-of atrocities by which the consent of the *sejm* to this act of brigandage was at last extorted (Aug. 18, 1773). Russia obtained the palatinates of Vitebsk, Polotsk Mscislaw: 1526 sq. m. of territory, with a population of 550,000 and an annual revenue of 920,000 Polish gulden. Austria got the greater part of Galicia, minus Cracow: 1720 sq. m., with a population of 816,000 and an annual revenue of 1,408,000 gulden. Prussia received the maritime palatinate minus Danzig, the palatinate of Kalm minus Thorn, Great Poland as far as the Nitz, and the palatinates of Marienburg and Ermeland 629 sq. m., with a population of 378,000, and an annual revenue of 534,000 thalers. In fine, Poland lost about one-fifth of her population and one-fourth of her territory.

In return for these enormous concessions the partitioning powers presented the Poles with a constitution superior to anything they had ever been able to devise for themselves. The most mischievous of the ancient abuses, the elective monarchy and the *liberum veto*, were of course retained. Poland was to be dependent on her despoilers, but they evidently meant to make her a servicable dependant. The government was henceforth to be in the hands of a *rada niestajaca*, or permanent council of thirty-six members, eighteen senators and eighteen deputies, elected biennially by the *sejm* in secret ballot, subdivided into the five departments of foreign affairs, police, war, justice and the exchequer, whose principal members and assistants, as well as all other public functionaries, were to have fixed salaries. The royal prerogative was still further reduced. The king was indeed the president of the permanent council, but he could not summon the diet without its consent, and in all cases of preferment was bound to select one out of three of the council's nominees. The annual budget was fixed at 30,000,000 Polish gulden,¹ out of which a regular army of 30,000² men was to be maintained. Sentiment apart, the constitution of 1775 was of distinct benefit to Poland. It made for internal stability, order and economy; and enabled her to develop and husband her resources, and devote herself uninterruptedly to the now burning question of national education. For the shock of the first partition was so far salutary that it awoke the public conscience to a sense of the national inferiority; stimulated the younger generation to extraordinary patriotic efforts; and thus went far to produce the native reformers who were to do such wonders during the great quadrennial diet.

It was the second Turkish War of Catherine II. which gave patriotic Poland her last opportunity of re-establishing her independence. The death of Frederick the Great (Aug. 17, 1786) completely deranged the balance of power in Europe. The long-standing accord between Prussia and Russia came to an end, and while the latter drew nearer to Austria, the former began to look to the Western powers. In August 1787 Russia and Austria provoked the Porte to declare war against them both, and two months later a defensive alliance was concluded between Prussia, England and Holland, as a counterpoise to the alarming preponderance of Russia. In June 1788 Gustavus III. of Sweden also attacked Russia, with 50,000 men, while in the south the Turks held the Muscovites at bay beneath the walls of Ochakov, and drove back the Austrian invaders into Transylvania. Prussia, emboldened by Russia's difficulties, now went so far as to invite Poland also to forsake the Russian alliance, and placed an army corps of 40,000 men at her disposal.

It was under these exceptional circumstances that the "four years' diet" assembled (Oct. 6, 1788). Its leaders, Stanislaw Malachowski, Hugo Kollontaj and Ignaty Potocki, were men of character and capacity, and its measures were correspondingly vigorous. Within a few months of its assembling it had abolished the permanent council; enlarged the royal prerogative; raised the army to 55,000 men; established direct communications with the Western powers; rejected an alliance which Russia, alarmed at the rapid progress of events, had hastened to offer; declared its own session permanent; and finally settled down to the crucial task of reforming the constitution on modern lines. But the difficulties of the patriots were commensurate with their energies, and though the new constitution was drafted so early as December 1789, it was not till May 1791 that it could safely be presented to the diet. Meanwhile Poland endeavoured to strengthen her position by an advantageous alliance with Prussia. Frederick William II. stipulated, at first, that Poland should surrender Danzig and Thorn, and Pitt himself endeavoured to persuade the Polish minister Michal Kleophas Oginski (1765-1833) that the protection of Prussia was worth the sacrifice. But the Poles proving obstinate, and Austria simultaneously displaying a disquieting interest in the welfare of the Republic, Prussia, on

the 20th of March 1791, concluded an alliance with Poland which engaged the two powers to guarantee each other's possessions and render mutual assistance in case either were attacked.

But external aid was useless so long as Poland was hampered by her anarchical constitution. Hitherto the proceedings of the diet had not been encouraging. The most indispensable reforms had been frantically opposed, the debate on the re-organization of the army had alone lasted six months. It was only by an audacious surprise that Kollontaj and his associates contrived to carry through the new constitution. Taking advantage of the Easter recess, when most of the malcontents were out of town, they suddenly, on the 3rd of May, brought the whole question before the diet and demanded urgency for it. Before the opposition could remonstrate; the marshal of the diet produced the latest foreign despatches, which unanimously predicted another partition, whereupon, at the solemn adjuration of Ignaty Potocki, King Stanislaus exhorted the deputies to accept the new constitution as the last means of saving their country, and himself set the example by swearing to defend it.

The revolution of the 3rd of May 1791 converted Poland into an hereditary³ limited monarchy, with ministerial responsibility and diennial parliaments. The *liberum veto* and all the intricate and obstructive machinery of the anomalous old system were for ever abolished. All invidious class distinctions were done away with. The franchise was extended to the towns. Serfdom was mitigated, preparatorily to its entire abolition; absolute religious toleration was established, and every citizen declared equal before the law. Frederick William II. officially congratulated Stanislaus on the success of "the happy revolution which has at last given Poland a wise and regular government;" and declared it should henceforth be his "chief care to maintain and confirm the ties which unite us." Cobenzl, the Austrian minister at St Petersburg, writing to his court immediately after the reception of the tidings at the Russian capital, describes the empress as full of consternation at the idea that Poland under an hereditary dynasty might once more become a considerable power. But Catherine, still in difficulties, was obliged to watch in silence the collapse of her party in Poland, and submit to the double humiliation of recalling her ambassador and withdrawing her army from the country. Even when the peace of Jassy (Jan. 9, 1792) finally freed her from the Turk, she waited patiently for the Polish malcontents to afford her a pretext and an opportunity for direct and decisive interference. She had not long to wait. The constitution of the 3rd of May had scarce been signed when Felix Potocki, Severin Rzewuski and Xavier Branicki, three of the chief dignitaries of Poland, hastened to St Petersburg, and there entered into a secret convention with the empress, whereby she undertook to restore the old constitution by force of arms, but at the same time promised to respect the territorial integrity of the Republic. On the 14th of May 1792 the conspirators formed a confederation, consisting, in the first instance, of only ten other persons, at the little town of Targowica in the Ukraine, protesting against the constitution of the 3rd of May as tyrannous and revolutionary, and at the same time the new Russian minister at Warsaw presented a formal declaration of war to the king and the diet. The diet met the crisis with dignity and firmness. The army was at once despatched to the frontier; the male population was called to arms, and Ignaty Potocki was sent to Berlin to claim the assistance stipulated by the treaty of the 19th of March 1791. The king of Prussia, in direct violation of all his oaths and promises, declined to defend a constitution which had never had his "concurrence." Thus Poland was left entirely to her own resources. The little Polish army of 46,000 ^{Russia overthrows the Constitution.} men, under Prince Joseph Poniatowski and Tadeusz Kosciusko, did all that was possible under the circumstances. For more than three months they kept back the invader, and, after winning three pitched battles, retired in perfect order on the capital (see PONIATOWSKI, and

¹ 1 Pol. gulden = 5 silber groschen.

² At the very next diet, 1776, the Poles themselves reduced the army to 18,000 men.

³ On the death of Stanislaus, the crown was to pass to the family of the elector of Saxony.

Koścuzsko). But the King, and even Kollontaj, despairing of success, now acceded to the confederation; hostilities were suspended; the indignant officers threw up their commissions; the rank and file were distributed all over the country; the reformers fled abroad; and the constitution of the 3rd of May was abolished by the Targowicians as "a dangerous novelty." The Russians then poured into eastern Poland; the Prussians, at the beginning of 1793, alarmed lest Catherine should appropriate the whole Republic, occupied Great Poland; and a diminutive, debased and helpless assembly met at Grodno in order, in the midst of a Russian army corps, "to come to an amicable understanding" with the partitioning powers. After every conceivable means of intimidation had been unscrupulously applied for twelve weeks, the second treaty of partition was signed at three o'clock on the morning of the 23rd of September 1793. By this *factum subjectionis*, as the Polish patriots called it, Russia got all the eastern provinces of Poland, extending from Livonia to Moldavia, comprising a quarter of a million of square miles, while Prussia got Dobrzyn, Kujavia and the greater part of Great Poland, with Thorn and Danzig. Poland was now reduced to one-third of her original dimensions, with a population of about three and a half millions.

The focus of Polish nationality was now transferred from Warsaw, where the Targowicians and their Russian patrons reigned supreme, to Leipzig, whither the Polish patriots, Kościuszko, Kollontaj and Ignaty Potocki among the number, assembled from all quarters. From the first they meditated a national rising, but their ignorance, enthusiasm and simplicity led them to commit blunder after blunder. The first of such blunders was Kościuszko's mission to Paris, in January 1794. He was full of the idea of a league of republics against the league of sovereigns; but he was unaware that the Jacobins themselves were already considering the best mode of detaching Prussia, Poland's worst enemy, from the anti-French coalition. With a hypocrisy worthy of the diplomacy of "the tyrants," the committee of public safety declared that it could not support an insurrection engineered by aristocrats, and Kościuszko returned to Leipzig empty-handed. The next blunder of the Polish refugees was to allow themselves to be drawn into a premature rising by certain Polish officers in Poland who, to prevent the incorporation of their regiments in the Russian army, openly revolted and led their troops from Warsaw to Cracow. Kościuszko himself condemned their hastiness; but, when the Russian troops began to concentrate, his feelings grew too strong for him, and early in April he himself appeared at Cracow. In an instant the mutiny became a revolution. The details of the heroic but useless struggle will be found elsewhere (see KOŚCZUSZKO, KOLLONTAJ, POTOCKI, IGNATY, DOMBROWSKI). Throughout April the Polish arms were almost universally successful. The Russians were defeated in more than one pitched battle; three-quarters of the ancient territory was recovered, and Warsaw and Vilna, the capitals of Poland and Lithuania respectively, were liberated. Kościuszko was appointed dictator, and a supreme council was established to assist him. The first serious reverse, at Szczekociny (June 5), was more than made up for by the successful defence of Warsaw against the Russians and Prussians (July 9 to Sept. 6); but in the meantime the inveterate lawlessness of the Poles had asserted itself, as usual, and violent and ceaseless dissensions, both in the supreme council and in the army, neutralized the superhuman efforts of the unfortunate but still undaunted dictator. The death-blow to the movement was the disaster of Maciejowice (Oct. 10), and it expired amidst the carnage of Praga (Oct. 20), though the last Polish army corps did not capitulate till the 18th of November. Yet all the glory of the bitter struggle was with the vanquished, and if the Poles, to the last, had shown themselves children in the science of government, they had at least died on the field of battle like men. The greed of the three partitioning powers very nearly led to a rupture between Austria and Prussia; but the tact and statesmanship of the empress of Russia finally adjusted all

difficulties. On the 24th of October 1795 Prussia acceded to the Austro-Russian partition compact of the 3rd of January, and the distribution of the conquered provinces was finally regulated on the 10th of October 1796. By the third treaty of partition Austria had to be content with Western Galicia and Southern Masovia; Prussia took Podlachia, and the rest of Masovia, with Warsaw; and Russia all the rest.

The immediate result of the third partition was an immense emigration of the more high-spirited Poles who, during the next ten years, fought the battles of the French Republic and of Napoleon all over Europe, but principally against their own enemies, the partitioning powers. They were known as the Polish legions, and were commanded by the best Polish generals, e.g. Joseph Poniatowski and Dombrowski. Only Kościuszko stood aloof. Even when, after the peace of Tilsit, the independent grand-duchy of Warsaw was constructed out of the central provinces of Prussian Poland, his distrust of Napoleon proved to be invincible. He was amply justified by the course of events. Napoleon's anxiety to conciliate Russia effectually prevented him from making Poland large and strong enough to be self-supporting. The grand-duchy of Warsaw originally consisted of about 1850 sq. m., to which Western Galicia and Cracow, about 900 sq. m. more, were added in 1809. The grand-duchy was, from first to last, a mere recruiting-ground for the French emperor. Its army was limited, on paper, to 30,000 men; but in January 1812 65,000, and in November the same year 97,000 recruits were drawn from it. The constitution of the little state was dictated by Napoleon, and, subject to the exigencies of war, was on the French model. Equality before the law, absolute religious toleration and local autonomy, were its salient features. The king of Saxony, as grand-duke, took the initiative in all legislative matters; but the administration was practically controlled by the French.

(R.N.B.)

The Congress Kingdom, 1813-1863.—The Grand Duchy of Warsaw perished with the Grand Army in the retreat from Moscow in 1812. The Polish troops had taken a prominent part in the invasion of Russia, and their share in the plundering of Smolensk and of Moscow had intensified the racial hatred felt for them by the Russians. Those of them who survived or escaped the disasters of the retreat fled before the tsar's army and followed the fortunes of Napoleon in 1813 and 1814. The Russians occupied Warsaw on the 18th of February 1813; and overran the grand duchy, which thus came into their possession, by conquest. Some of the Poles continued to hope that Alexander would remember his old favour for them, and would restore their kingdom under his own rule. Nor was the tsar unwilling to encourage their delusion. He himself cherished the desire to re-establish the kingdom for his own advantage. As early as the 13th of January 1813 he wrote to assure his former favourite and confidant, Prince Adam Czartoryski, that, "Whatever the Poles do now to aid in my success, will at the same time serve to forward the realization of their hopes." But the schemes of Alexander could be carried out only with the co-operation of other powers. They refused to consent to the annexation of Saxony by Prussia, and other territorial arrangements which would have enabled him to unite all Poland in his own hand. By the final act of the Congress of Vienna, signed on the 9th of June 1815, Poland was divided between Prussia, Austria and Russia, with one striking exception: Cracow with its population of 61,000 was erected into a republic embedded in Galicia. Posen and Gnesen, with a population of 810,000, were left to Prussia. Austria remained in possession of Galicia with its 1,500,000 inhabitants. Lithuania and the Ruthenian Palatinates, the spoil of former partitions, continued to be incorporated with Russia. The remnant was constituted as the so-called Congress Kingdom under the emperor of Russia as king (tsar) of Poland. It had been stipulated by the Final Act that the Poles under foreign rule should be endowed with institutions to preserve their national existence

according to such forms of political existence as the governments to which they belong shall think fit to allow them.

Alexander, who had a sentimental regard for freedom, so long as it was obedient to himself, had promised the Poles a

The New Polish Constitution, 1815. constitution in April 1815 in a letter to Ostrowski, the president of the senate at Warsaw. His promise was publicly proclaimed on the 25th of

May, and was reaffirmed in the Zamok or palace at Warsaw and the cathedral of St John on the 20th of June. The constitution thus promised was duly drafted, and was signed on the 30th of November. It contained 165 articles divided under seven heads. The kingdom of Poland was declared to be united to Russia, in the person of the tsar, as a separate political entity. The kingdom was the Congress Kingdom, for the vague promises of an extension to the east which Alexander had made to the Poles were never fulfilled. Lithuania and the Ruthenian Palatinates continued to be incorporated with Russia as the Western Provinces and were divided from the Congress Kingdom by a customs barrier till the reign of Nicholas I. The kingdom of Poland thus defined was to have at its head a lieutenant of the emperor (*namiestnik*), who must be a member of the Imperial house or a Pole. The first holder of the office, General Zajoncsek (1752-1826), was a veteran who had served Napoleon. Roman Catholicism was recognized as the religion of the state, but other religions were tolerated. Liberty of the Press was promised subject to the passing of a law to restrain its abuses. Individual liberty, the use of the Polish language in the law courts, and the exclusive employment of Poles in the civil government were secured by the constitution. The machinery of government was framed of a council of state, at which the Imperial government was represented by a commissioner plenipotentiary, and a diet divided into a senate composed of the princes of the blood, the palatines and councillors named for life, and a house of *nuntii* elected for seven years, 77 chosen by the "dietines" of the nobles, and 51 by the commons. The diet was to meet every other year for a session of thirty days, and was to be renewed by thirds every two years. Poland retained its flag, and a national army based on that which had been raised by and had fought for Napoleon. The command of the army was given to the emperor's brother Constantine, a man of somewhat erratic character, who did much to offend the Poles by violence, but also a good deal to please them by his marriage with Johanna Grudzinska, a Polish lady afterwards created Princess Lowicz, for whose sake he renounced his right to the throne of Russia (see CONSTANTINE PAVLOVICZ).

The diet met three times during the reign of Alexander, in 1818, in 1820 and in 1825, and was on all three occasions opened by the tsar, who was compelled to address his subjects in French, since he did not speak, and would not learn, their language. It is highly doubtful whether, with the best efforts on both sides, a constitutional government could have been worked by a Russian autocrat, and an assembly of men who inherited the memories and characters of the Poles. In fact the tsar and the diet soon quarrelled. The Poles would not abolish the jury to please the tsar, nor conform as he wished them to do to the Russian law of divorce. Opposition soon arose, and as Alexander could not understand a freedom which differed from himself, and would not condescend to the use of corruption, by which the ancient Polish diets had been managed, he was driven to use force. The third session of the diet—13th of May to 13th of June 1825—was a mere formality. All publicity was suppressed, and one whole district was disfranchised because it persisted in electing candidates who were disapproved of at court. On the other hand, the Poles were also to blame for the failure of constitutional government. They would agitate by means of the so-called National Masonry, or National Patriotic Society as it was afterwards called, for the restoration of the full kingdom of Poland. The nobles who dominated the diet did nothing to remove the most crying evil of the country—the miserable state of the peasants, who had been freed from personal serfdom by Napoleon in 1807, but were being steadily

driven from their holdings by the landlords. In spite of the general prosperity of the country due to peace, and the execution of public works mostly at the expense of Russia, the state of the agricultural class grew, if anything, worse.

Yet no open breach occurred during the reign of Alexander, nor for five years after his death in 1825. The Decembrist movement in Russia had little or no echo in Poland. On the death of Zajoncsek in 1826, the grand duke Constantine became Imperial lieutenant, and his administration, *The Grand Duke Constantine*, though erratic, was not unfavourable to displays of Polish nationality. The Polish army had no share in the Turkish War of 1829, largely, it is said, at the request of Constantine, who loved parades and thought that war was the ruin of soldiers. No attempt was made to profit by the embarrassments of the Russians in their war with Turkey. A plot to murder Nicholas at his coronation on the 24th of May 1829 was not carried out, and when he held the fourth diet on the 30th of May 1830, the Poles made an ostentatious show of their nationality which Nicholas was provoked to describe as possibly patriotic but certainly not civil. Nevertheless, he respected the settlement of 1815. In the meantime the Patriotic Society had divided into a White or Moderate party and a Red or Extreme party, which was subdivided into the Academics or Republicans and the Military or Terrorists. The latter were very busy and were supported by the Roman Catholic Church, which did little for the Prussian Poles and nothing for the Austrian Poles, but was active in harassing the schismatical government of Russia.

The outbreak of the French Revolution in 1830 and the revolt of Belgium produced a great effect in Poland. The spread of a belief, partly justified by the language of Nicholas, that the Polish army would be used to coerce the Belgians, caused great irritation. At last, on the 29th of November 1830, a military revolt took place in Warsaw accompanied by the murder of the minister of war, Hauke, himself a Pole, and other loyal officers. The extraordinary weakness of the grand duke allowed the rising to gather strength. He evacuated Warsaw and finally left the country, dying at Vitebsk on the 27th of June 1831 (see CONSTANTINE PAVLOVICZ). The war lasted from January till September 1831. The fact that the Poles possessed a well-drilled army of 23,800 foot, 6800 horse and 108 guns, which they were able to recruit to a total strength of 80,821 men with 138 guns, gave solidity to the rising. The Russians, who had endeavoured to overawe Europe by the report of their immense military power, had the utmost difficulty in putting 124,000 men into the field, yet in less than a year, under the leadership of Diebitsch, and then of Paskevich, they mastered the Poles. On the political and administrative side the struggle of the Poles was weakened by the faults which had been the ruin of their kingdom—faction pushed to the point of anarchy, want of discipline, intrigue and violence, as shown by the abominable massacre which took place in Warsaw when the defeat of the army was known. The Poles had begun by protesting that they only wished to defend their rights against the tsar, but they soon proceeded to proclaim his deposition. Their appeal to the powers of Europe for protection was inevitably disregarded.

When the Congress Kingdom had been reconquered it was immediately reduced to the position of a Russian province. No remnant of Poland's separate political existence remained save the minute republic of Cracow. Unable to acquiesce sincerely in its insignificance and even unable to enforce its neutrality, Cracow was a centre of disturbance, and, after Russia, Prussia, and Austria had in 1846 agreed to its suppression, was finally occupied by Austria on the 6th of November 1848, as a consequence of the troubles, more agrarian than political, which convulsed Galicia. The administration established by Nicholas I. in Russian Poland was harsh and aimed avowedly at destroying the nationality, and even the language of Poland. The Polish universities of Warsaw and Vilna were suppressed, and the students compelled to go to St Petersburg and Kiev. Polish

recruits were distributed in Russian regiments, and the use of the Russian language was enforced as far as possible in the civil administration and in the law courts. The customs barrier between Lithuania and the former Congress Kingdom was removed, in the hope that the influence of Russia would spread more easily over Poland. A very hostile policy was adopted against the Roman Catholic Church. But though these measures cowed the Poles, they failed to achieve their main purpose. Polish national sentiment was not destroyed, but intensified. It even spread to Lithuania. The failure of Nicholas was in good part due to mistaken measures of what he hoped would be conciliation. He supported Polish students at Russian universities on condition that they then spent a number of years in the public service. It was the hope of the emperor that they would thus become united in interest with the Russians. But these Polish officials made use of their positions to aid their countrymen, and were grasping and corrupt with patriotic intentions. The Poles in Russia, whether at the universities or in the public service, formed an element which refused to assimilate with the Russians. In Poland itself the tsar left much of the current civil administration in the hands of the nobles, whose power over their peasants was hardly diminished and was misused as of old. The Polish exiles who filled Europe after 1830 intrigued from abroad, and maintained a constant agitation. The stern government of Nicholas was, however, so far effective that Poland remained quiescent during the Crimean War, in which many Polish soldiers fought in the Russian army. The Russian government felt safe enough to reduce the garrison of Poland largely. It was not till 1863, eight years after the death of the tsar in 1855, that the last attempt of the Poles to achieve independence by arms was made.

The rising of 1863 may without injustice be said to be due to the more humane policy of the tsar Alexander II. Exiles were allowed to return to Poland, the Church was ^{the} ^{insurrection} ^{of 1862.} propitiated, the weight of the Russian administration was lightened, police rules as to passports were relaxed, and the Poles were allowed to form an agricultural society and to meet for a common purpose for the first time after many years. Poland in short shared in the new era of milder rule which began in Russia. In April 1856 Alexander II. was crowned king in the Roman Catholic cathedral of Warsaw, and addressed a flattering speech to his Polish subjects in French, for he too could not speak their language. His warning, "No nonsense, gentlemen" (*Point de roubles, Messieurs*), was taken in very ill part, and it was perhaps naturally, but beyond question most unhappily, the truth that the tsar's concessions only served to encourage the Poles to revolt, and to produce a strong Russian reaction against his liberal policy. As the Poles could no longer dispose of an army, they were unable to assail Russia as openly as in 1830. They had recourse to the so-called "unarmed agitation," which was in effect a policy of constant provocation designed to bring on measures of repression to be represented to Europe as examples of Russian brutality. They began in 1860 at the funeral of the widow of General Sobinski, killed in 1830, and on the 27th of February 1861 they led to the so-called Warsaw massacres, when the troops fired on a crowd which refused to disperse. The history of the agitation which culminated in the disorderly rising of 1863 is one of intrigue, secret agitation, and in the end of sheer terrorism by a secret society, which organized political assassination. The weakness of the Russian governor, General Gorchakov, in 1861 was a repetition of the feebleness of the Grand Duke Constantine in 1830. He allowed the Poles who organized the demonstration of the 27th of February to form a kind of provisional government. Alongside of such want of firmness as this were, however, to be found such measures of ill-timed repression as the order given in 1860 to the agricultural society not to discuss the question of the settlement of the peasants on the land. Concession and repression were employed alternately. The Poles, encouraged by the one and exasperated by the other, finally broke into the partial revolt of 1863-1864. It was a struggle of ill-armed partisans, who were never even numerous, against regular troops, and was

marked by no real battle. The suppression of the rising was followed by a return to the hard methods of Nicholas. The Polish nobles, gentry and Church—the educated classes generally—were crushed. It must, however, be noted that one class of the measures taken to punish the old governing part of the population of Poland has been very favourable to the majority. The peasants were freed in Lithuania, and in Poland proper much was done to improve their position. The Russian government has benefited by their comparative prosperity, and by the incurable hatred they continue to feel for the classes which were once their oppressors. The national history of Poland closes with the rising of 1863. (D. H.)

BIBLIOGRAPHY.—The best general history of Poland is still Józef Szujski's monumental *History of Poland according to the latest investigations* (4 vols., Pol., Lemberg, 1865-1866), a work which has all the authority of careful criticism and easy scholarship. It adopts, throughout, the conservative-monarchical standpoint. Szujski's book has superseded even Joachim Lelewel's learned *History of Poland* (Pol., Brussels, 1837), of which there are excellent French (Paris, 1844), and German (Leipzig, 1846) editions. The best contemporary general history is August Sokolowski's *Illustrated History of Poland* (Pol., Vienna, 1896-1900). The best independent German history of Poland is, on the whole, Roepell (Richard) and Cao's (Jakab) *Geschichte Polens* (Hamburg and Gotha, 1840-1888). Scholars desiring to explore for themselves the sources of Polish history from the 11th century to the 18th have immense fields of research lying open before them in the *Acta historica res gestas Poloniae illustrantia* (1878, &c.), the *Scriptores rerum polonicarum* (1872, &c.), and the *Historical Dissertations* (Pol., 1874, &c.), all three collections published, under the most careful editorship, by the University of Cracow. To the same order belong Ludwik Fialski's *Fomes rerum polonicarum* (Lemberg, 1901, &c.), and the innumerable essays and articles in *The Historical Quarterly Review of Poland* (Pol., Lemberg, 1887, &c.). The soundest history of Lithuania, before its union with Poland, is still Lelewel's *History of Lithuania* (Pol., Leipzig, 1839), of which a French translation was published at Paris in 1861. Proceeding to the earlier history of Poland, Lelewel's *Poland in the Middle Ages* (4 vols., Posen, 1846-1851) is still a standard work, though the greatest authority on Polish antiquities is now Tadeusz Wojciechowski, who unites astounding learning with a perfect style. His *Historical Sketches of the Eleventh Century* (Pol., Cracow, 1904) is a very notable work. Karol Szajnocha's great monograph, justly described as "a pearl of historical literature," *Jadwiga and Jagiello* (4 vols., Lemberg, 1861), the result of twelve years of exhaustive study, is our best authority on the first union between Poland and Lithuania. On the other hand, his *Baldassars the Bold, etc.* (Lemberg, 1859) would now be considered too romantic and picturesque. The relations between Poland, Prussia and Livonia are adequately dealt with by two sound German books, Theodor Schiemann's *Russland, Polen und Litland bis ins xviii. Jahrhundert* (Berlin, 1885-1887) and Max Perlbach's *Preussisch-polnische Studien* (Halle, 1886). A good guide to the history of the Jagiellonic period, 1386-1572, is also Adolf Pawinski's *Poland in the 15th Century* (Pol., Warsaw, 1883-1886). Of the numerous works relating to the reign of the heroic Stephen Balthory, 1572-1586, Ignaty Janicki's *Acta historica res gestas Stephani Balthori illustrantia* (Cracow, 1881), and Paul Pierling's *Un arbitrage politique entre la Pologne et la Russie 1581-1582* (Brussels, 1890) can be recommended. The best Polish work on the subject is Wacenty Zakrzewski's *The Reign of Stephen Balthory* (Pol., Cracow, 1887). Of the books relating to the Polish Vasa the most notable is Szajnocha's *Two Years of our History, 1640-1648* (Lemberg, 1864), which deals exhaustively with the little-known but remarkable attempt (the last practical attempt of its kind) of Ladislaus IV. to abolish the incurably vicious Polish constitution. Another first-class work, relating to the same period and dealing specifically with the mode of warfare of heroic Poland, is Józef Treliński's *History of the War of Chocim* (Pol., Lemberg, 1893). For works relating to the Sobieskian, Saxon and Partitional periods of Polish history, the reader is referred to the bibliographical notes appended to the biographies of John III., king of Poland, Michał Czartoryski, Stanislaus II., Tadeusz Andrzej Kościuszko, Józef Poniatowski, and the other chief actors of these periods. But the following additional authorities should also be noted: (1) Lelewel's *History of the Reign of Stanislaus Augustus* (Pol., Warsaw, 1831; Fr. ed., Paris, 1839); the book is important as being based on unpublished memoirs in the exclusive possession of the author's family. (2) *Materials for the History of the last century of the Republic*, by S. Korwin (Cracow, 1890). (3) *Die letzte polnische Königswahl*, by Szymon Askraszyn (Cracow, 1882-1886). (4) The extremely valuable *Princez Repnin in Poland* by Aleksander Kraushar (Warsaw, 1900), one of the most thorough of contemporary Polish historians. Innumerable are the works relating to the Partitional period. Perhaps the best of all is Wacenty Jan Kalinka's great work in four volumes, *Der vierjährige polnische Reichstag* (Berlin, 1896-1898). Kalinka is, however, far too severe upon the patriots and much too indulgent towards

King Stanislaus. Albert Sorel's *La Question d'Orient au XVIII^e siècle* (Paris, 1899) is lucid and accurate, but somewhat superficial. Wolfgang Michael's *Englands Stellung zur ersten Teilung Polens* (Hamburg, 1899) is of especial interest to Englishmen. Maryan Dubiecki's *Karol Proszar* (Pol., Cracow, 1897) shows with what self-sacrificing devotion the gentry and people supported Kościuszko's rising. For more complete bibliography see Józef Korzeniowski's *Catalogus actorum et documentarum res gestas Poloniae illustrantium* (Cracow, 1899), and Ludwik Finkel's *Bibliography of Polish History* (Pol., Lemberg, 1891). For the period 1815-1861, see also N. A. Day, *The Russian Government in Poland* (London, 1867); Theodor Schiemann, *Russland unter Kaiser Nikolaus I.*, vol. 1. (Berlin, 1904).

POLISH LITERATURE

The Polish language belongs to the western branch of the Slavonic tongues, and exhibits the closest affinities with the Czech or Bohemian and Lusatian Wendish. Unlike the people of other Slavonic countries, the Poles are comparatively poor in popular and legendary poetry, but such compositions undoubtedly existed in early times, as may be seen by the writings of their chroniclers; thus Gallus translated into Latin a poem written on Boleslaus the Brave, and a few old Polish songs are included in Wojcicki's *Library of Ancient Writers*. A great deal of the early literature written in Poland is in Latin. The earliest specimen of the Polish language is the so-called Psalter of Queen Margaret, discovered in 1826 at the convent of St Florian. The date of the manuscript appears to be the middle of the 14th century, and probably in its present form it is only a copy of a much older text, there is also a translation of the fiftieth psalm belonging to the 13th century.¹ The ancient Polish hymn of war song, *Pieśń Boga Rodzica*, was an address to the Virgin, sung by the Poles when about to fight. The oldest manuscript of this production is dated 1408, and is preserved at Cracow. By a legend which subsequently grew up the composition of it was assigned to St Adalbert. John Lodzia, bishop of Posen from 1335 to 1346, composed several religious songs in Latin.

The next monument of Polish literature to which we come is the Bible of Queen Sophia or Bible of Szarospatak. It is imperfect, and only contains the early books, viz. the Pentateuch, Joshua, Ruth and Kings; there are, however, fragments of three others. It is said to have been written for Sophia, the fourth wife of Jagiello, about the year 1455. It has been edited with great care by Malecki. Five religious songs in Polish dating from the 15th century have been preserved; they are ascribed to Andrew Słopuchowski, prior of the monastery of the Holy Cross on Lysa Góra. There is also the fragment of a hymn in praise of Wycliffe. To these fragments may be added the prayer-book of a certain Waclaw, a sermon on marriage, and some Polish glosses. These are all the existing memorials of the Polish language before the 16th century.

Perhaps a few words should be said concerning the writers in Latin. Martin Gallus lived in Poland between 1170 and 1135.

From his name he has been supposed by some to have been a Frenchman or Walloon, and we must remember that Poland swarmed at that time with foreign ecclesiastics. Lelewel, the Polish historian, considers that it is merely a translation into Latin of some such name as *Kura*, signifying "a fowl." Others suppose him to have been an Italian, or a monk from the convent of St Gall in Switzerland. He has plenty of legends to tell us, and writes altogether in a poetical style, so that his prose seems to fall into rhythm unconsciously. His quotations from the classics, Sallust, Lucan and others, show the extent of his reading. Gallus was followed by Matthew Cholewa and Vincent Kadlubek, two bishops of Cracow, and Bogufal or Boguchwal (Gottlob), bishop of Posen, who all used Latin. The work of Kadlubek is more ornate in diction than that of Bogufal, and for a long time enjoyed great popularity. He was born in 1160, educated at the university of Paris, and died in Poland in 1223 as a Cistercian monk. His Latin, like that of Gallus, is far from classical, but he writes with spirit and throws a good deal of light upon

¹The Psalter is called after Margaret, the first wife of King Louis, who died in 1349, by a mere conjecture. Caro thinks it more probable that the book belonged to Mary, his daughter.

the events of his time. The education of the country was wholly in the hands of the ecclesiastics, many of whom were foreigners. In this way we must explain the great prevalence of the Latin language. Such a system would be sure to stifle all national outgrowth, and accordingly we have among the Poles none of those early monuments of the language which other countries boast. For instance, there are no *ballads* or legendary poems, such as are found among the Russians, although many passages in the ancient chroniclers from their poetical colouring seem to be borrowed from old songs or legends, and the first verses of some of these compositions have been preserved. Mention may here be made of other chroniclers such as Martin the Pole (Polonus), who died in 1279 or 1280, and Jan of Czarnkow, who died in 1389; the latter was the historian and panegyrist of Casimir the Great. With the reign of Casimir III. (1333-1370) must be associated the statutes of Wislica. Jadwiga, the wife of Jagiello, was mainly instrumental in creating the university of Cracow, which received a charter in 1364, but did not come into effective existence till its reconstitution in 1400. In this institution for many years all the great men of Poland were trained—among others Gregory of Sanok, Długosz and Copernicus. Casimir the Great may be said to have laid the foundation of this university. Having obtained the consent of Pope Urban V., he established at Cracow a *studium generale* on the model of the university of Bologna. It consisted of three faculties—Roman law, medicine and philosophy. But the aristocratic youth still preferred frequenting the universities of Prague, Padua and Paris, and accordingly the newly founded *studium* languished. Jadwiga, however, obtained from Boniface IX. permission to create a new chair, that of theology; and the university of Cracow was remodelled, having been reorganized on the same basis as that of Paris. Another university was founded later at Vilna by Batory, and one at Zamość by the chancellor Zamoycki. There were also good schools in various places, such as the Collegium Lubranskiego of Posen and the school of St Mary at Cracow. In the year 1474 a press was set up in the latter city, where Günther Zainer printed the first book. The first press from which books in the Polish language appeared was that of Hieronymus Wietor, a Silesian, who commenced publishing in 1515. A few fragments printed in Polish had appeared before this, as the Lord's Prayer in the statutes of the bishops of Breslau in 1475, the story of Pope Urban in Latin, German and Polish in 1505, &c.; but the first complete work in the Polish language appeared from the press of this printer at Cracow in 1521, under the title, *Speeches of the Wise King Solomon*. The translation was executed by Jan Koszycki, as the printer informs us in the preface, and the work is dedicated to Anna Wojnicka, the wife of a castellan. In 1522, a Polish translation of Ecclesiastes appeared from that press, and before the conclusion of that year *The Life of Christ*, with woodcuts, translated into Polish by Balthasar Opec. Many other presses were soon established. Printers of repute at Cracow, during the 16th and beginning of the 17th century, were Sybeneicher and Piotrkowczyk.

Little as yet had been produced in Polish, as the chroniclers still adhered to Latin; and here mention must be made of Jan Długosz, who called himself Longinus. He was bishop of Lemberg, the capital of Galicia, and has left us a very valuable history which has merits of style and shows considerable research. So anxious was Długosz to make his work as perfect as he could that he learned Russian so as to be able to read the *Chronicle of Nestor*. The best part of his book is that which treats of the period between 1386 and 1480. About 1500 was written an interesting little work entitled "Memoirs of a Polish Janissary" (*Pamiętniki janczara polaka*). Although written in the Polish language, it was probably the production of a Serb, Michael Constantinovich of Ostrovitz. He was taken prisoner by the Turks in 1455 and served ten years among the Janissaries, after which he escaped into Hungary. About this time also flourished Nicholas Copernicus, a native of Thorn, one of the few Poles who have made themselves known beyond the limits of their country.

The Poles call the period between 1548 and 1606 their golden

age. Poland was the great land of eastern Europe, and owing to the universal toleration encouraged by the government, Protestantism was widely spread. Many of the chief nobility were Calvinists, and the Socini came to reside in the country. All this, however, was to pass away under the great Jesuit reaction. At Rakow in Poland was published the catechism of the Socinian doctrines in 1605. The Jesuits made their appearance in Poland in 1564, and soon succeeded in getting the schools of the country into their hands. Besides extirpating the various sects of Protestants, they also busied themselves with destroying the Greek Church in Lithuania. Latin poetry was cultivated with great success by Clement Janicki (1516-1543), but the earliest poet of repute who wrote in Polish is Rej of Naglowice (1505-1569). After a somewhat idle youth he betook himself to poetry. He was a Protestant, and among other religious works translated the Psalms. His best work was *Zwierciadło albo sygnat pocieszenia człowieka* (The Mirror or Life of an Honourable Man)—a somewhat tedious didactic piece. He was also the author of a kind of play—a mystery; we may term it, and productions of this sort seem to have been common in Poland from a very early time—entitled *Life of Joseph in Egypt*. This piece is interesting merely from an antiquarian point of view; there is but little poetry in it. It teems with anachronisms; thus we have mention of the mass and organs, and also of a German servant. Lucas Goinicki (1527-1603) wrote many historical works, and *Dworsianin polski*, an imitation of the *Corregiano* of Castiglione.

Jan Kochanowski (1530-1584), called the prince of Polish poets, came of a poetical family, having a brother, a cousin and a nephew who all enriched the literature of their country with some productions. Kochanowski studied for some time at the university of Padua, and also resided in Paris, where he made the acquaintance of Ronsard. Returning to Poland, he became in 1564 secretary to Sigismund Augustus. He has left *The Game of Chess*, an imitation of Vida, and *Proporzec albo hold pruski* (The Standard or Investiture of Prussia), where he describes the feat done by Albert of Brandenburg to Sigismund Augustus. He also executed a translation of the Psalms. He wrote a play—a piece of one act, with twelve scenes—*The Despatch of the Greek Ambassadors*. It is written in rhymeless five-foot iambics, and is altogether a product of the Renaissance, reminding us of some of the productions of George Buchanan. Rhyme is employed in the choruses only. It was acted on the marriage of the chancellor Jan Zamoyski with Christine Radziwill, in the presence of King Stephen and his wife, at Ujazdowo near Warsaw in 1578. The poet's most popular work, however, is his *Treść* or "Lamentations," written on the death of his daughter Ursula. These beautiful elegies have been justly praised by Mickiewicz; they are enough to raise Kochanowski far above the level of a merely artificial poet. Besides poems in Polish, he also wrote some in Latin. It will be observed that we get this double-sided authorship in many Polish writers. They composed for an exclusive and learned circle, certainly not for the Jew, the German trader of the town, or the utterly illiterate peasant. It may be said with truth of Kochanowski that, although the form of his poetry is classical and imitated from classical writers, the matter is Polish, and there is much national feeling in what he has left us. Mention must also be made of his epigrams, which he styled "Trißes" (*Fraski*); they are full of spirit and geniality. Stanislaus Grochowski (1554-1612) was a priest; but his poetry is of little merit, although he was celebrated in his time as a writer of panegyrics. His satire *Babis Kolo* (The Women's Circle) gave offence on account of its personalities. A great partisan of the Catholics in the time of Sigismund III. was Caspar Miaskowski, whose *Waleka Włoszonońska* (Farewell to his Native Country) deserves mention. Szczyński, who died young in 1581, deserves notice as having introduced the

¹ His collected works were printed in 1584; they were many times reprinted, the best edition being that of Warsaw (4 vols., 1804). His life was written by Przyborowski (Posen, 1857).

sonnet to the Poles. This species of poetry was afterward to be carried to great perfection by Mickiewicz and Gaszynski.

Szymonowicz (1554-1624) was a writer of good pastorals. Although they are imitated from classical writers, he has introduced many scenes of national life, which he describes with much vigour. Among the best are "The Lovers," "The Reapers," and "The Cake" (*Kolasa*). Mickiewicz is very loud in his praise, and considers him one of the best followers of Theocritus. The condition, however, of the Polish peasants was too miserable to admit of their being easily made subjects for bucolic poetry. There is an artificial air about the idylls of Szymonowicz which makes one feel too keenly that they are productions of the Renaissance; one of their best features is the humane spirit towards the miserable peasantry which they everywhere display. Another excellent writer of pastorals was Zimorowicz, a native of Lemberg, who died at the early age of twenty-five. Some of his short lyrics are very elegant, and remind us of Herrick and Carew—e.g. that beginning "Ukochana Lancello! Ciebie nie proszę o siło." Another writer of pastorals, but not of equal merit, was Jan Gawinski, a native of Cracow. Some good Latin poetry was written by Casimir Sarbiewski, better known in the west of Europe as Sarbievius (d. 1640). He was considered to have approached Horace more nearly than any other modern poet, and a gold medal was given him by Pope Urban VIII. Martin Kromer (1512-1589) wrote a history of Poland in thirty books, and another volume, giving a description of the country and its institutions—both in Latin. The history is written in an easy style and is a work of great merit. A poet of some importance was Sebastian Fabian Klonowicz (1545-1602), who latinized his name into *Acernus*, *Klon* being the Polish for maple, and wrote in both Latin and Polish, and through his inclination to reform drew down on himself the anger of the clergy. Sometimes he is descriptive, as in his Polish poem entitled *Fliś* ("The Boatman"), in which he gives a detailed account of the scenery on the banks of the Vistula. There is some poetry in this composition, but it alternates with very prosaic details. In another piece, *Rhoxolania*, in Latin, he describes the beauties of Galicia. Occasionally he is didactic, as in *Worek Judasow* (The Bag of Judas) and *Victoria deorum*, where, under the allegory of the gods of Olympus, he represents the struggles of parties in Poland, not without severely satirizing the nobility and ecclesiastics. A curious work called *Quincunx*, written by Orzechowski (1515-1566), is concerned with religious polemic. Andrew Modrzewski, a Protestant, in his work *De republica emendanda* (1551), recommended the establishment of a national church which should be independent of Rome, something upon the model of the Anglican.

A florid Jesuitical style of oratory became very popular in the time of Sigismund III., not without rhetorical power, but frequently becoming tawdry. The chief representative of this school was Piotr Skarga (1536-1612), one of the main agents in extirpating Calvinism in Poland and the Greek Church in Lithuania. Among his numerous writings may be mentioned *Lives of the Saints*, *Discourses on the Seven Sacraments*, and especially his sermons preached before the diet, in which he lashed the Poles for their want of patriotism and prophesied the downfall of the country. Mecherzyński, in his "History of Eloquence in Poland" (*Historia wyznawcy w Polsce*), especially praises his two funeral sermons on the burial of Anna Jagiellonka, widow of Stephen Bátor, and Anna of Austria, first wife of Sigismund III. Besides the Latin histories of Wapowski and Gwagnin (Guagnini, of Italian origin), we have the first historical work in Polish by Martin Bielski, a Protestant, viz. *Kronika polska*, which was afterwards continued by his son. The author was born in 1495 on his father's estate, Biala, and was educated, like so many other of his illustrious contemporaries, at the university of Cracow. He lived to the age of eighty; but, however great were the merits of his *Chronicle*, it was long considered a suspicious book on account of the leanings of the author to Calvinism. After his death his work was continued by

his son Joachim (1540-1599). There is also a *Chronicle* by Bartholomew Paprocki. In 1582 was also published the *Chronicle* of Strykowski, full of curious learning, and still of great use to the student of history. Five years later appeared the *Annales Poloniae* of Sarnicki. The last three works are in Latin.

A few words may be said here about the spread of Protestantism in Poland, which is so intimately mixed up with the development of the national language. The doctrines of Hus had entered the country in very early times, and we find Polish recensions of Bohemian hymns; even the hymn to the Virgin

previously mentioned is supposed to have a Czech basis. The bishops were soon active against those who refused to conform to the doctrines of the Roman church. Thus we find that Bishop Andrew of Bnin seized five Hussite priests and caused them to be burnt in the market of Posen in 1439. A hundred years afterwards a certain Katharina Malcher, on account of her Utraquist opinions, was condemned by Gamrat, the bishop of Cracow, to be burnt, which sentence was accordingly carried out in the ragmarket at Cracow. As early as 1530 Lutheran hymns were sung in the Polish language at Thorn. In Königsberg, John Seklucyan, a personal friend of Luther, published a collection of *Christian Songs*. He was born in Great Poland, and was at first a Roman Catholic priest in Posen, but afterwards embraced the Protestant faith and was invited by Duke Albert as a preacher to Königsberg, where he died in 1578. He executed the first translation of the New Testament in 1551. Four years afterwards appeared a complete Polish Bible published by Scharffenberg at Cracow. In 1553 appeared at Brześć the Protestant translation of the whole Bible made by a committee of learned men and divines, and published at the expense of Nicholas Radziwill, a very rich Polish magnate who had embraced the Protestant doctrines. This book is now of great rarity because his son Christopher, having been induced to become a Roman Catholic by the Jesuit Skarga, caused all copies of his father's Bible which he could find to be burnt. One, however, is to be seen in the Bodleian Library, and another in the library of Christ Church at Oxford. A Socinian Bible was issued by Simon Budny in 1570 at Niewiez, as he professed to find many faults in the version issued under the patronage of Radziwill; in 1597 appeared the Roman Catholic version of the Jesuit Wujek; and in 1632 the so-called Danzig Bible, which is in use among Protestants and is still the most frequently reprinted.

Up to this time Polish literature, although frequently rhetorical and too much tinged with classical influences, had still exhibited signs of genius. But now, owing to the frivolous studies introduced by the Jesuits, the so-called macaronic period supervened, which lasted from 1606 to 1764, and was a time of great degradation for the language and literature. The former was now mixed with Latin and classical expressions; much of the literature consists of fulsome panegyric, verses written on the marriages and funerals of nobles, with conceits and fantastic ideas, devoid of all taste, drawn from their coats of arms. The poets of this period are, as may be imagined, in most cases mere rhymesters; there are, however, a few whose names are worth recapitulating, such as Wladaw Potocki (c. 1622-c. 1696), now known to have been the author of the *Wojna Chocimska*, or "War of Khotin," the same campaign which afterwards formed the subject of the epic of Krasicki. At first the author was supposed to have been Andrew Lipki, but the real poet was traced by the historian Szajnoch. The epic, which remained in manuscript till 1850, is a genuine representation of Polish life; no picture so faithful appeared till the *Pan Tadeusz* of Mickiewicz. Moreover, Potocki had the good taste to avoid the macaronic style so much in vogue; his language is pure and vigorous. He does not hesitate to introduce occasionally satirical remarks on the luxury of the times, which he compares, to its disadvantage, with the simplicity of the old Polish life. There is also another poem attributed to Potocki called the *New Mercury*. In one

passage he censures King Michael for ceding Podolia to the Turks. Samuel Twardowski (1600-1660) was the most prolific poet of the period of the Vasas. His most important poem is *Wladystaw IV., King of Poland*, in which he sings in a very bombastic strain the various expeditions of the Polish monarch. A bitter satirist appeared in the person of Christopher Opalinski (1609-1656). His works were published under the title of *Jawenalis redimius*, and, although boasting but little poetical merit, give us very curious pictures of the times. Hieronymus Vespasian Kohcowski (1633-1699) was a soldier-poet, who went through the campaigns against the Swedes and Cossacks; he has left several books of lyrics full of vivacity, a Christian epic and a Polish psalmody. Another poet was Andrew Morstyn (born about 1620, died about the commencement of the 18th century), an astute courtier, who was finance minister (*podskarbi*) under John Casimir, and was a devoted adherent of the French party at court, in consequence of which, in the reign of Sobieski, he was compelled to leave his native country and settle in France. His poems are elegant and free from the conceits and pedantry of the earlier writers. In fact, he introduced into Poland the easy French manner of such writers as Voiture. He translated the *CV* of Corneille, and wrote a poem on the subject of Psyche, based upon the well-known Greek myth. History in the macaronic period made a backward step: it had been written in the Polish language in the golden age; it was now again to take a Latin form, as in the *Chronica Gestarum in Europa singularium* of the ecclesiastic Paul Piasecki (1580-1640), who is an authority for the reigns of Sigismund III. and Wladislaus IV., and Rudawski, who describes events from the accession of John Casimir to the peace of Oliva (1648-1660); and as valuable materials for history may be mentioned the five huge volumes of Andrew Chrysostom Zaluski (1711), bishop of Warmia. This work is entitled *Epistolae historico-familiares*. It would be impossible to recapitulate here the great quantity of material in the shape of memoirs which has come down, but mention must be made of those of John Chrysostom Pasek, a nobleman of Masovia, who has left us very graphic accounts of life and society in Poland; after a variety of adventures and many a well-fought battle, he returned to the neighbourhood of Cracow, where he died between 1699 and 1701. Some of the most characteristic stories illustrating Polish history are drawn from this book. A later period, that of the miserable epoch of Augustus III., is described very graphically in the memoirs of Matuszewicz, first edited by Pawinski at Warsaw in 1876. Relating to the same period are also the memoirs of Bartholomew Michalowski (*Pamiętniki Bartłomieja Michalowskiego*). A curious insight into the course of education which a young Polish nobleman underwent is furnished by the instructions which James Sobieski, the father of the celebrated John, gave to Orchowski, the tutor of his sons. This has been twice printed in comparatively recent times (*Instrukcja Jakkba Sobieskiego kasztelana Krakowskiego dana panu Orchowskiemu sw srony synow*, Vilna, 1840). The old gentleman in his aristocratic imperiousness frequently reminds us of the amusing directions given by Sir John Wynne to his chaplain, quoted in Pennant's *Tour in Wales*.

A *History of the Lithuanians* in Latin was published by the Jesuit Koialowicz; the first volume appeared at Danzig in 1650. A valuable work on the condition of Poland was written by Stanislaus Leszczyński, who was twice chosen king, entitled *Glos wolny wolności ubezpieczający* (A Free Voice Guaranteeing Freedom), where he tells the Poles some homely and perhaps disagreeable truths illustrating the maxim *Suumma Libertatis estiam perire solentibus*.

A notable man was Joseph Andrew Zaluski, bishop of Kiew, a Pole who had become thoroughly frenchified—so much so, that he preached in French to the fashionable congregations of Warsaw. He collected a splendid library of about 300,000 volumes and 15,000 manuscripts, which he bequeathed to the Polish nation; but it was afterwards carried off to St Petersburg, where it formed the foundation of the imperial public library. According to Nitschmann in his *Geschichte der polnischen*

Literature—a work which has been of service in the preparation of this article—the books were transported to Russia very carelessly, and many of them injured by the way. It was especially rich in works relating to Polish history. Konarski edited in six volumes a valuable work entitled *Volamina legum*, containing a complete collection of Polish laws from the time of the statute of Wislizza. He did much good also in founding throughout the country schools for the education of the sons of the upper classes, but as yet nothing had been done for popular education properly so-called. About the close of this period we have some valuable writers on Polish history, which now began to be studied critically, such as Hartknoch in his *Alt- und Neues Preussen* (1684), a work in which are preserved interesting specimens of the old Prussian language, and Lengnich (1689-1774), author of the valuable *Jus publicum regni Poloniae*, which appeared in 1742.

We now come to the reign of the last Polish king, Stanislaus Poniatowski, and the few quiet years before the final division of the country, during which the French taste was all-powerful. This is the second great period of the development of Polish literature, which has known nothing of medieval romanticism. The literature of the first or Renaissance period gives us some good poets, who although occasionally imitators are not without national feeling, and a goodly array of chroniclers, most of whom made use of Latin. In the second or French period we get verse-makers rather than poets, who long to be Frenchmen, and sigh over the barbarism of their country; but the study of history in a critical spirit is beginning under the influence of Naruszewicz, Alberttrandi and others. In the third period, that of modern romanticism, we get true nationalism, but it is too often the literature of exile and despair. Here may be mentioned, although living a little time before the reign of Stanislaus, a Polish poetess, Elizabeth Druzbacka (1695-1760), whose writings show a feeling for nature at a time when verse-making of the most artificial type was prevalent throughout the country. The portrait prefixed to the Leipzig edition of her works is a striking one, representing a handsome, intellectual-looking woman, dressed in the garb of some religious order. Her *Life of David* in verse appears tedious, but many of the descriptions in the *Seasons* are elegant. Unfortunately she introduces latinisms, so that her Polish is by no means pure. A national theatre was founded at Warsaw in 1765 under the influence of the court, but it was not till long afterwards that anything really national connected with the drama appeared in Poland. Thomas Kajetan Węgierski (1755-1787), who was chamberlain to the king, enjoyed a considerable reputation among his countrymen for his satirical writing. He was a kind of Polish Churchill, and like his English parallel died young. His life also appears to have been as irregular as Churchill's. In consequence of an attack on the empress of Russia, he was compelled to leave Poland, and accordingly made a tour in Italy, France, America, and England, dying at Marseilles at the early age of thirty-three. His poetry shows the influence of the French taste, then prevalent throughout Europe. In times of great national disasters he deserves to be remembered as a true patriot; but the spirit of his poetry is altogether unwholesome. It is the wailing cry of a moribund nation. The great laureate of the court of Stanislaus was Trembecki (1722-1812), whose sympathies were too much with the Russian invaders of his country. He was little more than a fluent poetaster, and is now almost forgotten. One of his most celebrated pieces was *Zaffonka*, written on the country seat of Felix Potocki, a Polish magnate, for this was the age of descriptive as well as didactic poetry. Perhaps the English gave the hint in such productions as "Cooper's Hill." The old age of Trembecki appears to have been ignoble and neglected; and had indeed "fallen upon evil days and evil tongues"; when he died at an advanced age all the gay courtiers of whom he had been the parasite were either dead or had submitted to the Muscovite yoke. He comes before us as a belated epicurean, whose airy trifles cannot be warbled in an atmosphere surcharged with tempests and gunpowder.

The end of the 18th century was not the period for a court poet in Poland.

The most conspicuous poet, however, of the time was Ignatius Krasicki, bishop of Warmia (1735-1801). He was the friend of Frederick the Great and a prominent member of Krasicki, the king's literary club at Sans Souci. Krasicki wrote an epic on the war of Khotin—the same as had furnished the subject of the poem of Potocki, of which Krasicki in all probability had never heard, and also that of the Dalmatian Gundulich. Krasicki's poem is at best but a dull affair, in fact a pale copy of a poor original, the *Henriade* of Voltaire. His mock heroics are, to say the least, amusing, and among these may be mentioned *Myseis*, where he describes how King Popiel, according to the legend, was eaten up by rats. His *Monachomachia* is in six cantos, and is a satire upon the monks. The bishop was also the writer of some pretty good comedies. In fact most styles of composition were attempted by him—of course satires and fables among the number. He presents himself to us much more like a transplanted French abbé than a Pole. In the year 1801 he travelled to Berlin, and died there after a short illness. Among his other works the bishop published in 1781-1782, in two volumes, a kind of encyclopaedia of *belles lettres* entitled *Zbiór Wiadomości*. His estimates of various great poets are not very accurate. Of course he finds Shakespeare a very "incorrect" author, although he is willing to allow him considerable praise for his vigour. E. Morawski (1783-1861) published some excellent *Fables* (1800) in the manner of Krasicki, and in 1851 an epic entitled *My Grandfather's Farm*. Adam Naruszewicz (1733-1796) was bishop and poet. The existence of so many ecclesiastical writers was a natural feature in Polish literature; they formed the only really cultured class in the community, which consisted besides of a haughty ignorant nobility living among their serfs, and (at a vast distance) those serfs themselves, in a brutalized condition. Burghers there were, properly speaking, none, for most of the citizens in the large towns were foreigners governed by the *Jus magdeburgicum*. Naruszewicz has not the happy vivacity of Krasicki; he attempts all kinds of poetry, especially satire and fable. He is at best but a mediocre poet; but he has succeeded better as a historian, and especially to be praised is his "History of the Polish Nation" (*Historja narodu polskiego*), which, however, he was not able to carry further than the year 1386. He also wrote an account of the Polish general Chodkiewicz, and translated Tacitus and Horace. Interesting memoirs have been published by Killinski, a Warsaw shoemaker, and Kosmian, state referendary, who lived about this time and saw much of the War of Independence and other political affairs. Among the smaller poets of this period may be mentioned Karpiński (1741-1828), a writer of sentimental elegies in the style then so very much in fashion, and Franciszek Dyonizy Kniaźnin (1750-1807), who nourished his muse on classical themes and wrote several plays. He was the court poet of Prince Adam Czartoryski at Pulawy, and furnished odes in commemoration of all the important events which occurred in the household. He lost his reason on the downfall of Poland, and died after eleven years' insanity in 1807. Julian Ursin Niemcewicz (1758-1841) was one of the most popular of Polish poets at the commencement of the present century (see NIEMCEWICZ). His most popular work is the "Collection of Historical Songs" (*Spiewy historyczne*), where he treats of the chief heroes of Polish history. Besides these he wrote one or two good plays, and a novel in letters, on the story of two Jewish lovers. John Paul Woronicz (1757-1825) born in Volhynia, and at the close of his life bishop of Warsaw and primate of Poland, was a very eloquent divine, and has been called the modern Skarga. A valuable worker in the field of Slavonic philology was Linde, the author of an excellent Polish dictionary in six volumes. For a long time the cultivation of Polish philology was in a low state, owing to the prevalence of Latin in the 17th century and French in the 18th. No Polish grammar worthy of the name appeared till that of Kopczynski at the close of the 18th century, but the reproach

has been taken away in modern times by the excellent works by Malecki and Malinowski. Rakowiecki, who edited the *Rousskaia Prawda*, and Maciejowski (who died in 1883, aged ninety), author of a valuable work on Slavonic law, may here be mentioned. Here we have a complete survey of the leading codes of Slavonic jurisprudence. At a later period (in 1856) appeared the work of Helcel, *Starodawne prawa polskiego pomniki* ("Ancient Memorials of Polish Law"). Aloysius Feliński (1771-1820) produced an historical tragedy, *Barbara Radziwiłł*, and some good comedies were written by Count *Polish* Alexander Fredro (1793-1876). In fact Fredro may be considered the most entertaining writer for the stage which Poland has produced. He introduced genuine comedy among his countrymen. The influence of Molière can be very clearly seen in his pieces; his youth was spent chiefly in France, where he formed one of the soldiers of the Polish legion of Napoleon and joined in the expedition to Russia. His first production was *Pan Geldhab*, written in 1819 and produced at Warsaw in 1821. From 1819 to 1835 he wrote about seventeen pieces and then abandoned publishing, having taken offence at some severe criticisms. At his death he left several comedies, which were issued in a posthumous edition. There is a good deal of local colouring in the pieces of Fredro; although the style is French, the characters are taken from Polish life. From him may be said to date the formation of anything like a national Polish theatre, so that his name marks an epoch. The Poles, like many of the other nations of Europe, had religious plays at an early period. They were originally performed in churches; but Pope Innocent II. finding fault with this arrangement, the acting was transferred to churchyards. Mention has already been made of plays written by Rej and Kochanowski; they are mere fruits of the Renaissance, and cannot in any way be considered national. The wife of John Casimir, a Frenchwoman, Marie Louise, hired a troop of French actors and first familiarized the Poles with something which resembled the modern stage. The Princess Franciszka Radziwiłł composed plays which were acted at her private residence, but they are spoken of as inartistic and long and tedious. The national theatre was really founded in the reign of Stanislaus Augustus; and good plays were produced by Bohomolec, Kamiński, Kropiński, Bogusławski, Zabłocki, and others. Perhaps, however, with the exception of the works of Fredro, the Poles have not produced anything of much merit in this line. A great statesman and writer of the later days of Polish nationality was Kollataj, born at Sandomir in 1750. He was a man of liberal sentiments, and, had his plans been carried out, Poland might have been saved. He wished to abolish serfdom and throw open state employments to all. The nobility, however, were too infatuated to be willing to adopt these wise measures. Like the French aristocrats with the reforms of Necker, they would not listen till ruin had overtaken them. During the last war of Poland as an independent country Kollataj betook himself to the camp of Kościuszko, but when he saw that there was no longer hope he went to Galicia, but was captured by the Austrians and imprisoned at Olmütz till 1803. He died in 1812. An active co-operator with Kollataj was Salesius Jezierski, who founded clubs for the discussion of political questions, and Stanislaus Staszic, who did much for education and improved the condition of the university of Warsaw.

The reputation of all preceding poets in Poland was now destined to be thrown into the shade by the appearance of Mickiewicz (1798-1855), the great introducer of romanticism into the country (see MICKIEWICZ).

Poland, as has been said before, is not rich in national songs and legendary poetry, in which respect it cannot compare with its sister Slavonic countries Russia and Servia. Collections have appeared, however, by Waclaw Zaleski, who writes under the pseudonyms of Wacław z Oleska, Wojcicki, Roger, Zegota Pauli, and especially Oskar Kolberg. Poland and Lithuania, however, abounded with superstitions and legends which only awaited the coming poet to put them into verse. In the year 1851 Romuald Zieliński published *Songs of the*

Peoples of Pólska, and collections have even appeared of those of the Kashobes, a remnant of the Poles living near Danzig. Mickiewicz had had a predecessor, but of far less talent, Casimir Brodzinski (1791-1835). He served under Napoleon in the Polish legion, and has left a small collection of poems, the most important being the idyl *Wiesław*, in which the manners of the peasants of the district of Cracow are faithfully portrayed. The second great poet of the romantic school who appeared in Poland after Mickiewicz was Julius Slowacki (1809-1849), born at Krzemieniec. In 1831 he left his native country and chose Paris as his residence, where he died. His writings are full of the fire of youth, and show great beauty and elegance of expression. We can trace in them the influence of Byron and Victor Hugo. He is justly considered one of the greatest of the modern poets of Poland. His most celebrated pieces are *Hugo*; *Mnich* ("The Monk"); *Lambro*, a Greek corsair, quite in the style of Byron; *Achelli*, a very Dantesque poem expressing under the form of an allegory the sufferings of Poland; *Krol Duch* ("The Spirit King"), another mysterious and allegorical poem; *Wacław*, on the same subject as the *Marya* of Malczewski, to be afterwards noticed; *Beniowski*, a long poem in ottava rima on this strange adventurer, something in the style of Byron's humorous poems; *Kordyan*, of the same school as the English poet's *Manfred*; *Lilla Weneta*, a poem dealing with the early period of Slavonic history. The life of Slowacki has been published by Professor Anton Malecki in two volumes.

Mickiewicz and Slowacki were both more or less mystics, but even more we may assign this characteristic to Sigismund Krasinski, who was born in 1812 at Paris, and died there in 1859. It would be impossible to analyse here his extraordinary poem *Nieboska komedja* ("The Undivine Comedy"), *Irydion*, and others. In them Poland, veiled under different allegories, is always the central figure. They are powerful poems written with great vigour of language, but enveloped in clouds of mysticism. The life of Krasinski was embittered by the fact that he was the son of General Vincent Krasinski, who had become unpopular among the Poles by his adherence to the Russian government; the son wrote anonymously in consequence, and was therefore called "The Unknown Poet." Among his latest productions are his "Psalms of the Future" (*Psalmi przyszlosci*), which were attacked by the democratic party as a defence of aristocratic views which had already ruined Poland. His friend Slowacki answered them in some taunting verses, and this led to a quarrel between the poets. One of the most striking pieces of Krasinski has the title "Resurrecturis." The sorrows of his country and his own physical sufferings have communicated a melancholy tone to the writings of Krasinski, which read like a dirge, or as if the poet stood always by an open grave—and the grave is that of Poland. He must be considered as, next to Mickiewicz, the greatest poet of the country. Other poets of the romantic school of considerable merit were Gorecki, Witwicki, Odyniec, and Gaszynski; the last named wrote many exquisite sonnets, which ought alone to embalm his name. Witwicki (1800-1847) was son of a professor at Krzemieniec. He was a writer of ballads and poems dealing with rural life, which enjoyed great popularity among his countrymen and had the good fortune to be set to music by Chopin. The works of Lelewel have separate mention (see LELEWEL); but here may be specified the labours of Narbutt, *Dzieje starozytnego arcydiekanatu litewskiego* ("Early History of the Lithuanian People"), published at Vilna in nine volumes, and the valuable *Monumenta Poloniae historica*, edited at Lemberg by Bielowski, of which several volumes have appeared, containing reprints of most of the early chroniclers. Bielowski died in 1876.

A further development of romanticism was the so-called Ukraine school of poets, such as Malczewski, Goszczynski, and Zaleski. Anton Malczewski (1793-1826) wrote one poem, *Marya*, a Ukrainian tale which passed unnoticed at the time of its publication, but after its author's death became very popular. Malczewski was one of Napoleon's officers; he led a wandering life and was intimate with Byron at Venice; he is said to have suggested to

the latter the story of Mazeppa. *Marya* is a narrative in verse in the manner of Byron. It is written with much feeling and elegance, and in a most harmonious metre. The chief poem is Severin Goszczyński (1803-1876) is *Zamek Kaniowski* ("The Tower of Kaniow"). The most interesting poem of Bogdan Zaleski is his "Spirit of the Steppe" (*Duch od stepu*). Other poets of the so-called Ukraine school, which has been so well inspired by the romantic legends of that part of Russia, are Thomas or Timko Padoura (who also wrote in the Malo-Russian, or Little-Russian, language), Alexander Groza, and Thomas Olszarowski. For many of the original songs and legends we must turn to the work of Messrs Antonovich and Dragomanov. Bogdan Joseph Zaleski was born in 1802 in the Ukraine village, Bohaterka. In 1820 he was sent to the university of Warsaw, where he had Goszczyński as a fellow student. Besides the longer poem previously mentioned, he is the author of many charming lyrics in the style of the Little Russian poems, such as Shevchenko has written in that language. He died at Villepreux, in France, in 1886, after more than fifty years of exile. Michael Grabowski (1805-1863) belongs also to this school by his fine *Melodies of the Ukraine* (1828). Maurice Goslawski also won fame by his *Poems of a Polish Outlaw* in the struggle of 1830-1831. A poet of great vigour was Stephen Garczynski (1806-1833), the friend of Mickiewicz, celebrated for his *War Sonnets* and his poem entitled *The Deeds of Waclaw*.

Wincenty Pol (1807-1872) was born at Lublin, and though of foreign extraction by both parents proved an ardent patriot. He wrote a fine descriptive work, *Obrazy z życia i podróży* ("Pictures of Life and Travel"), and also a poem, *Pieśń o ziemi naszej* ("Song of our Land"). For about three years from 1849 he was professor of geography in the university of Cracow. In 1855 he published *Mohor!*, a poem relating to the times of Stanislaw Poniatowski. Ludwik Władysław Kondratowicz (who wrote chiefly under the name of Syrokoma) was born in 1823 in the government of Minsk, and died on the 15th of September 1862 at Vilna. His parents were poor, and he received a meagre education, but made up for it by careful self-culture. One of his most remarkable poems is his *Jas Doborog*, in which, like Mickiewicz, he has well described the scenery of his native Lithuania. He everywhere appears as the advocate of the suffering peasants, and has consecrated to them many beautiful lyrics. In Kozłowski the Poles found a novelist who treated many periods of their history with great success. His sympathies, however, were mostly aristocratic, though modified by the desire of progress. An important writer of history is Karl Szajnocha (1818-1868), born in Galicia of Czech parents. He began his labours with *The Age of Casimir the Great* (1848), and *Boleslaw the Brave* (1849), following these with *Jadwiga and Jagiello*, in three volumes (1855-1856)—a work which Spasovich, in his Russian *History of Slavonic Literature*, compares in vigour of style and fullness of colour with Macaulay's *History of England* and Thierry's *Norman Conquest*. Our author was still further to resemble the latter writer in a great misfortune; from overwork he lost his sight in 1857. Szajnocha, however, like Thierry, and the American Prescott, did not abandon his studies. His excellent memory helped him in his affliction. In 1858 he published a work in which he traced the origin of Poland from the Varangians (*Lechicki początek polski*), thus making them identical in origin with the Russians. He began to write the history of John Sobieski, but did not live to finish it, dying in 1868, soon after completing a history of the Cossack wars, *Dwa lata dziejów naszych* ("Two Years of Our History"). A writer of romances of considerable power was Joseph Korzeniowski (1797-1863), tutor in early youth to the poet Krasinski, and afterwards director of a school at Kharkov. Besides some plays now forgotten, he was author of some popular novels, such as *Wedzianki oryginalna* ("Tours of an Original"), 1848; *Garbary* ("The Hunchback"), 1852, &c. But the most fertile of Polish authors was J. I. Kraszewski (q.v.). His works constitute a library in themselves; they are chiefly historical and political novels, some of which treat of early times in Poland, and some of its condition under the Saxon kings. As lyrical poets may also be mentioned Jachowicz, Jakowski, author of a fine poem, *The Beginning of Winter*; Edmund Wasilewski (1814-1846), the author of many popular songs; and Holowski, archbishop of Mogilev (1807-1855), author of religious poems. The style of poetry in vogue in the Polish parts of Europe at the present time is chiefly lyrical. Other writers deserving mention are Cornelius Ujejski (1823-1897), the poet of the last revolt of 1863; Theophilus Lenartowicz (born 1822), who wrote some very graceful poetry; Sigismund Milkowski (T. T. Też, born in 1820), author of romances drawn from Polish history, for the novel of the school of Sir Walter Scott still flourishes vigorously among the Poles. Among the very numerous writers of romances may be mentioned Henry Racwinski (1791-1866); Joseph Dzierzkowski wrote novels on aristocratic life, and Michael Czajkowski (1808-1876) romances of the

Ukraine; Valerius Wielogłowski (1865) gave pictures of country life.

In 1882 the Poles lost, in the prime of life, a very promising historian Szujski (born in 1835), and also Schmitt, who died in his sixty-sixth year. Szujski commenced his literary career in 1859 with poems and dramas; in 1860 appeared his first historical production, *Rzut oka na Historję Polski* ("A Glance at Polish History"), which attracted universal attention; and in 1862 he commenced the publication in parts of his work *Dzieje Polski* ("The History of Poland"), the printing of which ceased in 1866. The value of this book is great both on account of the research it displays and its philosophical and unprejudiced style. One of the last works of Szujski, written in German, *Die Polen und Ruthenen in Galizien*, attracted a great deal of attention at the time of its appearance. Schmitt got mixed up with some of the political questions of the day—he was a native of Galicia and therefore a subject of the Austrian emperor—and was sentenced to death in 1846, but the penalty was commuted into imprisonment in Spielberg, whence he was released by the revolution of 1848. In 1863 he took part in the Polish rebellion, and was compelled to fly to Paris, where he only returned in 1871. His chief works are *History of the Polish People from the Earliest Times to the year 1763* (1854), *History of Poland in the 15th and 19th Centuries* (1866), and *History of Poland from the time of the Partition* (1868), which he carried down to the year 1832. In opposition to the opinion of many historians, his contemporaries, that Poland fell through the nobility and the diets, Schmitt held (as did Lelewel) that the country was brought to ruin by the kings, who always preferred dynastic interests to those of the country, and by the pernicious influence of the Jesuits. Adalbert Ketrzyński, who succeeded Bielowski in 1877 in his post of director of the Ossolinski Institute at Lemberg, is the author of some valuable monographs on the history of Poland. He was born in 1838. Casimir Stadaicki has treated of the period of the Jagiellons; and Szaranczyński, professor at the university of Lemberg, has written on the early history of Galicia. Thaddeus Wojciechowski has published a clever work on Slavonic antiquities. Xavier Liske, born in 1838, professor of universal history at Lemberg, has published many historical essays of considerable value, and separate works by him have appeared in the German, Polish, Swedish, Danish and Spanish languages. The "Sketch of the History of Poland" (*Dzieje Polskie w zarysie*) by Michael Bobrzyński, born in 1849 in Cracow (professor of Polish and German law), is a very spirited work, and has given rise to a great deal of controversy on account of the opposition of many of its views to those of the school of Lelewel. Vincent Zakrzewski, professor of history at Cracow, has written some works which have attracted considerable attention, such as *On the Origin and Growth of the Reformation in Poland*, and *After the Flight of King Henry*, in which he describes the condition of the country during the period between that king's departure from Poland and the election of Stephen Batory. Smolka has published a history entitled *Miscar the Elder and his Age*. Władysław Wislocki has prepared a catalogue of manuscripts in the Jagiellon library at Cracow. Dr Joseph Casimir Plebański, besides editing the *Biblioteka warszawska*, a very valuable literary journal which stands at the head of all works of the kind in Poland, has also written a dissertation (in Latin) on the *liberum veto*, which puts that institution in a new light. Feliks Jezierski, the previous editor of the above-mentioned journal, published in it translations of parts of Homer, and is also the author of an excellent version of *Faust*.

The history of Polish literature has not been neglected. We first have the early history of Felix Bentkowski (1781-1852), followed by that of Michael Wiszniewski (1794-1865), which, however, only extends to the 17th century, and is at best but a quarry of materials for subsequent writers, the style being very heavy. A "History of Eloquence" (*Historja wymowy w Polsce*) was published by Karl Mecherzynski. An elaborate history of Polish literature has been written by Anton Malecki, who is the author of the best Polish grammar (*Gramatyka historyczno-porównawcza języka polskiego*, 2 vols., Lemberg, 1879). The Polish bibliography of Karl Estreicher, director of the Jagiellon library at Cracow, is a work of the highest importance. One of the most active writers on Polish philology and literature is Władysław Nehring, whose numerous contributions to the *Archiv für slavische Philologie* of Professor Jagic entitle him to the gratitude of all who have devoted themselves to Slavonic studies. Władimir Spasowicz, a lawyer of St. Petersburg, assisted Pipin in his valuable work on Slavonic literature. The lectures of Professor Cybulski (d. 1867) on Polish literature in the first half of the 19th century are written with much spirit and appreciation. The larger poetical works which appear during that time are carefully analysed.

In recent times many interesting geological and anthropological investigations have been carried on in Poland. In 1863 Count Constantine Tyszkiewicz published a valuable monograph on the *Tombs of Lithuania and Western Ruthenia*. And Professor Joseph Łepkowski, of Cracow, has greatly enriched the archaeological museum of his native city.

In philosophy the Poles (as the Slavs generally) have produced but few remarkable names. Goluchowski, the brothers Andrew and John Śniadecki, the latter of whom gained a reputation almost European, Bronisław Trentowski, Karol Liebelt and Joseph Krasuski

deserve mention. August Cieszkowski has written on philological and economic subjects. Moritz Straszewski, professor of philosophy at the university of Cracow, has also published some remarkable works.

Mention has already been made of the poetess Elizabeth Druzbacka. Female writers are not very common among Slavonic nations. Perhaps the most celebrated Polish authoress was Klementina Hoffmann, whose maiden name was Tanska, born at Warsaw in 1798. She married Karl Boromäus Hoffmann, and accompanied her husband, in 1831, to Passy near Paris, where she died in 1845. Her novels still enjoy great popularity in Poland. Of the poetesses of later times Gabriele Narzyssa Zmichowska (1825-1878), Maria Ilnicka, translator of Scott's *Lord of the Isles*, and Jadwiga Luszczevska may be mentioned.

A poet of considerable merit is Adam Asnyk (1838-1897). In his poetry we seem to trace the steps between romanticism and the modern realistic school, such as we see in the Russian poet Nekrasov. In some of the flights of his muse he reminds us of Slowacki, in the melody of his verse of Zaleski. Besides showing talent as a poet, he has also written some good plays, as "The Jew" (1862), *Cola di Rienzi*, and *Kiejstut*. Other poets worthy of mention are Zagorski, Czerwiński, and Maria Konopnicka, who has published two volumes of poems that have been very favourably noticed. Mention must also be made of Batucki (1837-1901), author of novels and comedies, and Narzymycki (1839-1872), who was educated in France, but spent part of his short life in Cracow, author of some very popular tales.

The four centres of Polish literature, which, in spite of the attempts which have been made to denationalize the country, is fairly active, are Cracow, Posen, Lemberg and Warsaw. A cheap edition of the leading Polish classics, well adapted for dissemination among the people, has been published, under the title of *Biblioteka Polska*, at Cracow. Not only are the professors of Cracow University some of the most eminent living Poles, but it has been chosen as a place of residence by many Polish literary men. The academy of sciences, founded in 1872, celebrated the bicentenary of the raising of the siege of Vienna by Sobieski by publishing the valuable *Acta Joannis III. regis Poloniae*. Some good Polish works have been issued at Posen. At Lemberg, the capital of Austrian Galicia, there is an active Polish press. Here appeared the *Monumenta Poloniae historica* of Bielowski, previously mentioned; but Polish in this province has to struggle with the Red-Russian or Ruthenian, a language or dialect which for all practical purposes is the same as the Southern or Little Russian. At Warsaw, since the last insurrection, the university has become entirely Russianized, and its *Transactions* are published in Russian; but Polish works of merit still issue from the press—among others the leading Polish literary journal, *Biblioteka warszawska*.

Perhaps the most popular modern writer in Poland is Eliza Orzeszko, of whose novels a complete "Jubilee" edition has appeared. Many of her tales—as, for instance, *Argonauci* ("The Argonauts")—have appeared in the *Tygodnik*, or weekly illustrated journal of Warsaw. *Meir Ezofowicz* has enjoyed great popularity. The object of this tale is to bridge over the gulf between the Jew and Christian in Poland. Adolf Dygasinski writes clever village tales of the "kail-yard" school, as it has been sometimes termed in England. Wacław Sieroszewski has written *Twelve Years in the Land of the Jakuts*, a contribution to the literature of folk-lore and ethnology such as only a real artist could produce. Among the latest poets we may mention Wyspianski, Kisilewski, Reymont, *Mme Zapolska*; the latter is the author of some powerful realistic novels and plays, and she has been called the Polish Zola. It is this kind of poetry and traces of the decadent school which we find in the later Polish poets. A pessimistic spirit is apparent, as in the writings of Wenceslaus Berent. Since the death of Asnyk and Ujejski the most prominent poet is Marya Konopnicka (1846). Some good critical work has been done in the leading reviews by Swietochowski and others. Historical work has been produced by Hirschberg, Pappé, Sobieski, Czermak and others, and the histories of Polish literature by Stanislaus Tarnowski and Piotr Chmielowski are of the highest value, the former dealing more with the aesthetic side of literature and the latter with the historical. The Poles are busy in reviving their great past. Hence the enthusiasm for historical studies, and the *Biblioteka pisarstwa polskiego*, which shows us what abundance of literature was produced in Poland in the 16th and beginning of the 17th century. In Henryk Sienkiewicz (*q.v.*), the historical novelist, Poland has a modern writer of European reputation.

BIBLIOGRAPHY.—Pipin and Spafovich, *Istoria slawianskikh Literatur* (in Russian; St Petersburg, 1879); *Geschichte der polnischen Literatur* von Dr A. Brückner (Leipzig, 1901; also written in Polish); Chmielowski, *History of Polish Literature* (in Polish, 3 vols.); Stanislaus Tarnowski, *History of Polish Literature* (in Polish); Grabowski, *Początek Polski po roku 1863* (Cracow, 1903); Heinrich Nitschmann, *Geschichte der polnischen Literatur* (Leipzig; sine anno). (W. R. M.)

POLAND, RUSSIAN, a territory consisting of ten governments which formerly constituted the kingdom of Poland (see above), but now are officially described as the "governments on the

Vistula," or occasionally as the "territory on the Vistula." It is bounded N. by the Prussian provinces of West and East Prussia, W. by those of Posen and Prussian Silesia, S. by the Austrian crownland of Galicia, and E. by the Russian governments of Volhynia, Vilna, Grodno, and Kovno.

Physical Features.—The territory consists for the most part of an undulating plain, 300 to 450 ft. above the sea, which connects the lowlands of Brandenburg on the west with the great plain of central Russia on the east. A low swelling separates it from the Baltic Sea; while in the south it rises gradually to a series

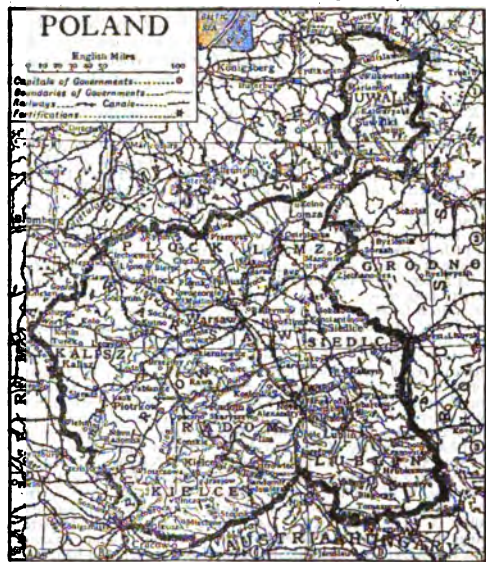

of plateaus, which merge imperceptibly into the northern spurs of the Carpathians. These plateaus, with an average elevation of 800 to 1000 ft., are mostly covered with forests of oak, beech and lime, and are deeply cut by river valleys, some being narrow and craggy, and others broad, with gentle slopes and marshy bottoms. Narrow ravines intersect them in all directions, and they often assume, especially in the east, the character of wild, impassable, woody and marshy tracts. In the south-eastern corner of Poland they are called podlasie, and are in a measure akin to the polyesie of the Pripet. The Vistula, which skirts them on the south-west, cuts its way through them to the great plain of Poland, and thence to the Baltic. Its valley divides the hilly tracts into two parts—the Lublin heights on the east, and the Sędomicz (Sandomir) or central heights on the west. These last are diversified by several ranges which run east-south-east, parallel to the Beskides of the Carpathian system, the highest of them being the Lysa Góra, which reach 1970 ft. and 2010 ft. above the sea. Another short ridge, the Chęcinski hills in Kielce, follows the same direction along the Nida river and reaches 1345 ft. south of the Nida; the Olkusz hills, linked on to the spurs of the Beskides, fill up the south-west corner of Poland, reaching 1620 ft., and containing the chief mineral wealth of the country; while a fourth range, 1000 to 1300 ft. high, runs north-west past Czenstochowa, separating the Oder from the Warta (Warthe). In the north, the plain of Poland is bordered by a flat, broad swelling, 600 to 700 ft. above the sea, dotted with lakes, and recalling the lacustrine regions of north-western Russia. Wide tracts of sand, marshes, peat-bogs, ponds, and small lakes, among which the streams lazily meander from one marsh to another, the whole covered with thin pine-forests and scanty vegetation, with occasional patches of fertile

soil—such are the general characters of the northern border-region of the great plain of central Poland. The rivers flow across the plain in broad, level valleys, only a few hundred or even only a few dozen feet lower than the watersheds; they separate into many branches, enclosing islands, forming creeks, and drowning wide tracts of land during inundations. Their basins, especially in the west, interpenetrate one another in the most intricate way, the whole bearing unmistakable evidences of having been in recent geological, and partly in historical times the bottom of extensive lakes, whose alluvial deposits now yield heavy crops. The fertility of the soil and the facility of communication by land and by water have made this plain the cradle of the Polish nationality. The very name of Poland is derived from it—Wielkopolska and Wielkoplane being the Slav terms for the great plain and its inhabitants.

Rivers and Canals.—Rusian Poland belongs mostly, though not entirely, to the basin of the Vistula—its western parts extending into the upper basin of the Warta, a tributary of the Oder, and its north-east spur (Suwalki) penetrating into the basin of the Memel, of which it occupies the left bank. For many centuries, however, the Poles have been driven back from the mouths of their rivers by the German race, maintaining only the middle parts of their basins. About Jozefow (51° N.) the Vistula enters the great central plain and flows north and west-north-west between low banks, with a breadth of 1000 yds. Its inundations, dangerous even at Cracow, become still more so in the plain, when the accumulations of ice in its lower course obstruct the outflow, or the heavy rains in the Carpathians raise its level. Embankments 20 to 24 ft. high are maintained for 60 m., but they do not always prevent the river from inundating the plains of Opole in Lublin and Kozienice in Radom, the waters sometimes extending for 150 m. to the east. Thousands of rafts and boats of all descriptions descend the stream every year with cargoes of corn, wool, timber and woaden wares, giving occupation to a large number of men. Steamers ply as far as Sandomir. The Wieprz (180 m.), a right-hand tributary of the Vistula, is the chief artery of the Lublin government; it is navigable for small boats and rafts for 105 m. from Krasnystaw. The Bug, another right-hand tributary of the Vistula, describes a wide curve concentric with those of the middle Vistula and the Narew, and separates the Polish governments of Lublin and Siedlce from the Russian governments of Volhynia and Grodno. Only light boats (*galary*) are floated down this broad, shallow stream, whose flat and open valley is often inundated. Its tributary, the Narew (250 m.), brings the forest-lands of Byelovezh in Grodno into communication with Poland, timber being floated down from Surazh and light boats from Tykocin in Lomza. The Pilica, which joins the Vistula from the left 30 m. above Warsaw, rises in the south-western corner of Poland, and flows for 200 m. north and east in a broad, flat, sandy and marshy valley, of evil repute for its unhealthiness.

The Warta (450 m.) rises in the Czarnostochowa hills, 900 ft. above the sea, and flows north and west past Sieradz and Kolo. Below Czarnostochowa it traverses a flat lowland, whose surface rises only 2 to 3 ft. above the level of the river, and the inhabitants have a constant struggle to keep it to its bed; every spring an immense lake is formed by the river at the mouth of the Ner, a little above Kolo.

The Memel flows along the north-east frontier of Poland, from Grodno to Yurburg, separating it from Lithuania. The yellowish sandy plains on its left will grow nothing except oats, buckwheat and some rye. The river often changes its bed, and notwithstanding repeated attempts to regulate it, offers great difficulties to navigation. Still, large amounts of corn, wool and timber are floated down, especially after its confluence with the Black Hancza.

Though navigable for a few months only, the rivers of Poland have always been of considerable importance for the traffic of the country, and their importance is further increased by several canals connecting them with the Russian and German rivers. The Memel is connected with the Dnieper by the Oginsky canal, situated in the Russian government of Minsk. The Dnieper and Bug canal in Grodno connects the Mukhavets, a tributary of the Bug, with the Pina in the basin of the Pripiet, that is, the Dnieper with the Vistula. The Vistula is connected also with the Oder by the Bromberg canal in Prussia, which links the Brahe, in the basin of the Vistula, with the Netze, a tributary of the Warta. All these canals are, however, beyond Russian Poland. In Poland proper, the Augustowo canal connects the Vistula with the Memel, by means of the rivers Black Hancza, Netza, Biebrz and Narew. Another canal, to the west of Łęczyca, connects the Bzura, a tributary of the Vistula, with the Ner and the Warta; and the bed of the former has been altered so as to obtain regular irrigation of the meadows along its banks.

Lakes.—Lakes are numerous in the government of Suwalki, but are all small and mostly hidden in thick coniferous or birch forests, and their waters penetrate with undefined banks amidst marshes, sandy tracts and accumulations of moss-grown boulders. Another

group of small lakes is situated in the basin of the Warta (north part of Kalisz), the largest being Goplo, 18 m. long and 100 ft. deep.

Climate.—With the exception of the Lysa Góra hilly tracts (Kielce and south Radom), which lie within the isotherms of 41° and 42°, Poland is situated between the isotherms of 42° and 46°. The isotherms and isotherms (i.e. lines of equal mean summer and winter temperature respectively) crossing one another at right angles, and the former running east-north-east, Poland is included between the isotherms of 64° and 61° and the isotherms of 35.7° and 39.2°. The prevailing winds are westerly, with north-north-east and south winds in autumn and winter, and east winds in spring. There is an average of 21.7 to 23.6 in. of rainfall in central Poland, and the quantity increases slowly towards the south on account of the proximity of the Carpathians, where it is 30.3 in. Owing to this distribution the snow-sheet in Poland is not very thick, and spring sets in early. Still, frosts of -4° to -22° Fahr. are not uncommon, and the rivers are generally icebound for two and a half to three months—the Warta being under ice for 70 to 80 days, the Vistula at Warsaw for 80 days and (exceptionally) even for 116, and the Memel for 100 (exceptionally for 140).

The following averages will serve to illustrate the climate of Poland:—

	Warsaw.	Vilna (in Russia).
Earliest frost	Oct. 18	Oct. 17
Latest frost	March 15	March 25
Absolute maximum temperature	95.5°	89.3°
Absolute minimum temperature	-37.6°	39.0°
Annual rainfall (total)	22.8 in.	7.6 in.

Flora.—The flora of Poland is more akin to that of Germany than to that of Russia, several middle European species finding their north-east limits in the basin of the Memel or in the marshes of Lithuania. Coniferous forests, consisting mostly of pine (*Pinus sylvestris*) and birch, cover large tracts in Mazovia in the north, extend across the Baltic lake-ridge southwards as far as the confluence of the Bug with the Narew, and join in the south-east the Polyzie of the Pripiet. The pine covers the Lysa Góra hills and the hills in the extreme south-west. The larch, which three centuries ago covered large tracts, has almost entirely disappeared. *Pinus cembra* is only remembered, as also *Taxus baccata*. *Pinus obovata* is cultivated.

Of deciduous trees, the common beech is the most typical; it extends from the Carpathians to 53° N. and reaches three degrees farther north in small groups or isolated specimens; the confluence of the Bug and the Narew may be regarded as its eastern limit. The white beech (*Carpinus betulus*), the aspen, and two elms (*Ulmus campestris*, *U. effusus*) are found nearly everywhere. The Elm appears in groves only in the east (Memel, Pripiet, Lublin). It is the most popular tree with the Poles, as the birch with the Russians; judgment of old was pronounced under its shade, and all the folk-songs repeat its name. The oak—a highly venerated tree in Poland, though not so much as in Lithuania—grows in forests only on the most fertile land, but it is of common occurrence in conjunction with the beech, elm, &c. The maples (*Acer platanoides* and *A. pseudo-platanus*) are somewhat rare; the black alder (*Alnus glutinosa*) lines the banks of the rivers and canals, and the *Alnus incana* is common. The willow and orchard trees—apple, pear, plum and cherry—are cultivated everywhere.

Fauna.—The fauna of Poland belongs to the middle European zoological group; within the historical period it has lost such species as formerly gave it a subarctic character. The reindeer now occurs only as a fossil; the sable, mentioned in the annals, has migrated eastwards; the wild horse, described by the annals as intermediate between the horse and the ass—probably similar to the *Equus przewalskii* of central Asia—is reputed to have been met with in the 13th century in the basin of the Warta, and two centuries later in the forests of Lithuania. The wild goat, ibex and elk have migrated to the Lithuanian forests. The lynx and beaver have disappeared. The brown bear continues to haunt the forests of the south, but is becoming rarer; the wolf, the wild boar, and the fox are most common throughout the great plain, as also the hare and several species of *Arvicola*. The mammals in Poland, however, do not exceed fifty species. The avi-fauna, which does not differ from that of central Europe, is represented by some one hundred and twenty species; among which the singing birds (*Dendroica* and *Corvinidae*) are the most numerous. On the whole, Poland lies to the westward of the most frequented route of the migratory birds, and is less visited by them than the steppes of south-west Russia. Numerous aquatic birds breed on the waters of the Baltic lake-region.

Population.—The population of Poland, 6,193,710 in 1871, reached 7,319,080 in 1881, and 10,500,000 in 1897. The estimated population in 1906 was 10,747,300. Details for 1897 are shown in the subjoined table.

Governments.	Area, sq. m.	Domiciled Population, 1897.	Urban Population.	Density per sq. m.
Kalisz	4,390	844,358	113,609	193
Kielce	3,896	765,212	57,814	196
Lomza	4,666	585,033	69,834	125
Lublin	6,500	1,165,122	148,196	179
Piotrków	4,728	1,406,427	509,699	297
Plock	4,199	557,229	69,821	133
Radom	4,768	1,048,044	94,318	171
Siedlce	5,533	775,326	110,995	140
Suwalki	4,845	610,154	73,308	126
Warsaw	5,605	1,929,200	791,746	344
Total	49,130	9,456,105	2,059,340	193

The non-domiciled population numbered about 1,000,000, and by 1904 the total was estimated to have increased to 12,000,000, the rate of increase between 1889 and 1904 having been 46.6. Poland, with 193 (domiciled) inhabitants or 213 inhabitants in all to the square mile in 1897, and 240 to the square mile in 1904, has a denser population than any other region in the Russian empire, the next to it being the governments of Moscow, with 189 inhabitants to the square mile, Podolia with 186, and Kiev with 181. The drift towards the rural population began in 1890, when the urban population amounted to only 18% of the whole, whereas in 1904 it reached 24%, as compared with 13% for the urban population of Russia as a whole. Of the towns of Poland 32 have a population each exceeding 10,000, the largest being Warsaw the capital, with 638,208 inhabitants in 1897 and 756,426 in 1901; Lodz, with 315,209 in 1897 and 351,570 in 1900; Czenstochowa, with 45,130 in 1897 and 53,650 in 1900; and Lublin, with 50,152 in 1897. According to nationalities, the population was made up as follows in 1897: 6,735,503 Poles, equal to 64.6% of the total; 1,267,194 Jews, equal to 12.1%; 631,844 Russians (6%); 391,440 Germans (4%); 310,386 Lithuanians and Letts (3%); with a few thousands each of Tatars, Bohemians, Rumanians, and Estonians, and a few Gypsies and Hungarians.

During prehistoric times the basin of the Vistula seems to have been inhabited by a dolichocephalic race, different from the brachycephalic Poles of the present day; but from the dawn of history Slavs (Poles), intermingled to some extent with Lithuanians, have to be found on the plains of the Vistula and the Warta. The purest Polish type exists in the basin of the middle Vistula and in Posen. The Poles extend but little beyond the limits of Russian Poland. In East Prussia they occupy the southern slope of the Baltic swelling (the Mazurs), and extend down the left bank of the lower Vistula to its mouth (the Kaszubes or Kassubians). Westward they stretch down the Warta as far as Birnbaum (100 m. east of Berlin); and in the south they extend along the right bank of the Vistula to the river San in western Galicia. In Russia they constitute, with Jews, Lithuanians, Ruthenians and White Russians, the town population, as also the landed nobility and the country gentry, in several governments west of the Dvina and the Dnieper.

According to the localities which they inhabit, the Poles take different names. They are called *Wielkopolanie* on the plains of middle Poland, while the name of *Malopolanie* is reserved for those on the Warta. The name of *Lęczyńanie* is given to the inhabitants of the marshes of the Ner, that of *Kurpie* to those of the Podlasie; *Kujawicy*, *Szłęcy* in the Silesia, and *Górale* in the Carpathians.

The Kaszubes, and especially the Mazurs, may be considered as separate stocks of the Polish family. The Mazurs are distinguished from the Poles by their lower stature, broad shoulders and massive frame, and still more by their national dress, which has nothing of the smartness of that of the southern Poles, and by their ancient customs; they have also a dialect of their own, containing many words now obsolete in Poland, and several grammatical forms bearing witness to Lithuanian influence. They submit without difficulty to German culture, and in Prussia are Lutherans. The language of the Kaszubes can also be considered as a separate dialect. The Poles proper are on the whole of medium stature (5 ft. 4-6 in.), finely built, dark in the south and fair in the north, richly endowed by nature, inclined to deeds of heroism, but perhaps deficient in that energy which characterizes the northern races of Europe, and in that sense of unity which has been the strength of their present rulers.

The German element is annually increasing both in number and in influence. The Lodz manufacturing district, the Polish Birmingham, is becoming more German than Polish; and throughout the governments west of the Vistula German immigration is going on at a steadily increasing rate, especially in the governments of Plock, Kalisz, Piotrków and Warsaw.

The Jews, who are found everywhere throughout Poland, are nowhere agricultural; in the larger towns many of them are artisans,

but in the villages they are almost exclusively engaged as shopkeepers, second-hand traders, dealers on commission, innkeepers and usurers. In the country, both commerce and agriculture are in the hands of their intimately connected trading associations. Their relations with Poles and Ruthenians are anything but cordial, and "Jew-baiting" is of frequent occurrence. They are increasing much more rapidly than the Slavs.

Agriculture.—From remote antiquity Poland has been celebrated for the production and export of grain. Both, however, greatly declined in the 18th century; and towards the beginning of the 19th, the peasants, ruined by their proprietors, or abandoned to the Jews, were in a more wretched condition than even their Russian neighbours. Serfdom was abolished in 1807; but the liberated peasants received no allotments of land, and the old patrimonial jurisdictions were retained. Compelled to accept the conditions imposed by the landlords, the peasants had to pay rack-rents and to give compulsory labour in various forms for the use of their land. Only a limited number were considered as permanent farmers, while nearly one-half of them became mere *proletaires*. Pursuing a policy intended to reconcile the peasantry to Russian rule and to break the power of the Polish nobility, the Russian government promulgated, during the outbreak in 1864, a law by which those peasants who were holders of land on estates belonging to private persons, institutions (such as monasteries and the like), or the Crown were recognized as proprietors of the soil—the state paying compensation to the landlords in bonds, and the peasants having to pay a yearly annuity to the state until the debt thus contracted had been cleared off. The valuation of these allotments was made at a rate much more advantageous than in Russia, and the average size of holding amounted to 15 acres per family. Of those who held no land a number received grants out of the confiscated estates of the nobility and monasteries. At the same time the self-government of the peasants was organized on democratic principles. The so-called "servitudes," however—that is, the right to pasture on and take wood from the landlord's estates—were maintained for political reasons. These reforms resulted in a temporary increase of prosperity, or at any rate an alleviation of the previous misery of the peasants. But whereas between 1864 and 1873 the peasantry as a whole purchased, in addition to the land granted to them by the government, 297,000 acres, in the period 1873-1893, they bought 550,000 acres and between 1893 and 1904 as much as 1,400,000 acres. Thus the process of breaking up the larger estates is proceeding rapidly and at an accelerated rate. In ten years (1864-1873) the area of cultivated soil increased by 1,350,000 acres, while during the fourteen years 1845-1859 its increase had been only 530,000 acres. But the maintenance of the "servitudes," the want of pasture-land, the lack of money for improvements, and the very rapid increase in the price of land, all helped to counteract the benefits of the agrarian measures of 1864.

In 1904 the village communities (peasantry) owned 43.8% of the total area; private owners, mostly nobles, 40.6%; the Crown and imperial family, 6%; and public bodies, such as towns and monasteries, 2.6%; while 3% was in the hands of the Jews. The holdings of the peasant families vary generally from 8 to 13 acres, the minimum in Russia being 16 to 22 acres. By a law of 1891 further subdivision below 8.5 acres is prohibited. But out of a total of some 7,000,000 peasants no fewer than 3,000,000 possess no land. In consequence of this every summer no fewer than 800,000 emigrate temporarily to Germany in quest of work.

Forests cover over 21.3% of the surface, of which nearly one-third belong to the Crown, and only 515,000 acres (7.7%) to the peasantry.

Agriculture in Poland is on the whole carried on according to more advanced methods than in Russia. The extensive cultivation of beetroot, of potatoes for distilleries, and of fodder crops has led to the introduction of a rotation of several years instead of the former "three-fields" system; and agricultural machinery is in more general use, especially on the larger estates of the west. Winter wheat is extensively cultivated, especially in the south, the Sandomir (Sedomiers) wheat having a wide repute. Of the land in the possession of the peasants no less than 70% is under crops, and of the land in the larger estates 52%; of the former category 11% and of the latter 8% is meadow. Altogether nearly 16 million acres of Russian Poland, or almost one-half of the total area, are under crops, principally rye, oats, wheat, barley, potatoes and hay, with some flax, hemp, peas, buckwheat and hops. After local wants are supplied, there remains every year a surplus of about 3½ million quarters of cereals for export. Beetroot is largely grown for the manufacture of sugar. Potatoes are extensively grown for use in the distilleries. The cultivation of tobacco is successfully carried on, especially in the governments of Warsaw, Plock and Lublin. The breeding of livestock (cattle, sheep and horses), is an important source of income. Fine breeds of horses and cattle are kept on the larger estates of the nobility, and cattle are exported to Austria. Bee-keeping is widely followed, especially in the south-east. Fishing is carried on remuneratively, more particularly on the Vistula and its tributaries.

Manufactures and Mines.—Since 1864, and more especially since 1875, there has been a remarkable development of manufacturing enterprise in Poland, the branch of industry which has shown the

greatest progress being the textile. Whereas in 1864 the annual production of all factories in Poland was valued at not more than 51 millions sterling, in 1875, when the workers numbered 27,000, the output was estimated at even less; but in 1905 the value of the industrial production reached 53 millions sterling. The principal industrial centres are Lodz (textiles), Warsaw (sugar, leather and miscellaneous) and Bendzin—Sosnowice—Dombrowa, in Piotrków (mining). The sugar factories and refineries, situated chiefly in the governments of Warsaw, Lublin and Plock, turn out approximately one million tons of sugar in the year, the Polish sugar industry being exceeded in Russia only by that of Kiev. Cotton is the principal product of the mills at Lodz and Lask, both in Piotrków; though woollen cloth, silk and linen are also produced. Tanning is centred in Warsaw and Radom; Polish (*z. Warsaw*) boots and shoes have a great reputation throughout the Russian empire. Other notable branches of manufacturing industry, besides those already named, are flour-mills, jute, hosiery, lace, paper, cement, hats, haberdashery, machinery, tobacco, soap and candle factories, iron and steel works, distilleries, breweries, potteries, vinegar, chocolate, varnish, furniture, clothing and brickworks. The cottage industries, such as pottery and basket-making, formerly of considerable importance, are gradually being replaced by the factory system of working.

Southern Poland possesses abundant minerals, especially in the Kielce mountains and the region adjacent to Prussian Silesia. The Devonian sandstones contain malachite ores near Kielce, and copper has been worked there since the 15th century, though the mines are now neglected. The brown iron ores of Kielce contain no less than 40% of iron. The zinc ores of the Olkusz district, more than 50 ft. thick, contain 8 to 14%, sometimes 25%, of zinc. The tin ores of Olkusz are still more important, and were extensively wrought as early as the 16th century. Brown iron ores, appearing in the neighbourhood of Bendzin as lenticular masses 55 ft. thick, and containing 25 to 33% of iron, accompany the zinc ores. Spherosiderites and brown iron ores are plentiful also in the "Keuper formation." Sulphur is wrought in the district of Pińczow; the deposits, which contain 25% of sulphur, reach a thickness of 7 to 70 ft. Coal occurs in south-west Poland over an area of 200 sq. m. in the districts of Bendzin and Olkusz. Brown coal, or lignite, which appears in the Olkusz district in beds 3 to 7 ft. thick, has been worked out. The output of coal is 4,000,000 to 6,000,000 tons in the year, the number of hands employed being 18,000 to 20,000. The yield of lignite is less than 100,000 tons annually; of zinc 10,000 to 12,000 tons; of copper and lead small. The production of iron and steel increased from 13,000 tons in 1862 to about 500,000 tons in 1905. Of other mineral produce, chalk, exported from Lublin, a few quarries of marble and many of building stones, are worthy of notice. Mineral waters are used medicinally at Ciechocinek in Plock and Nałecz in Lublin.

Communications.—The railways of Poland have an aggregate length of 1300 m. A line of great importance, connecting Vienna with St Petersburg, crosses the country from south-west to north-east, passing through the mining district and through Warsaw, and sending a short branch to Lodz. Another important line, connecting Danzig with Odessa, crosses Poland from north-west to south-east. A branch line, parallel to this last, connects Skierzniewice with Thorn and Bromberg; while a military railway connects the fortresses of Warsaw and Ivangorod with Brest-Litovsk, via Siedlce and Lukow. The line from Berlin to St Petersburg traverses the north of Suwalki for 54 m. between Eydektunen and Kovno.

Commerce.—The general trade of Poland is merged in that of Russia, under which heading it is treated. With the extension of the railways the fairs have lost much of their importance, but their aggregate yearly returns are still estimated at £3,000,000. The principal fairs are held at Warsaw (wool, hemp, hops), Łęczyca in Kalisz, Skaryszew in Radom, Ciechanowice in Lomza, and Lowicz in Warsaw.

Administration.—The entire administration of Poland is under the governor-general residing at Warsaw. He is at the same time the commander of the military forces of the "Warsaw military district." Justice is represented by the *gmina* tribunals, which correspond to those of the *mir* in Russia; the justices of the peace (nominated by government); the *syezd*, or "court" of the justices of the peace; the district tribunals (*assizes*) in each government; and the Warsaw courts of appeal and cassation. Poland has had no separate budget since 1867; its income and expenditure are included in those of the empire.

After the insurrection of 1863 all towns with less than 2000 inhabitants were deprived of their municipal rights, and were included, under the designation of *posady*, in the *gminas*. Viewed with suspicion by the Russian government, the Polish towns received no self-government like the villages. The elective municipal councils, which enjoyed *de jure* very large rights, including that of maintaining their own police, although in reality they were under the rule of the nobility, were practically abolished, and Russian officials were nominated in their place

and entrusted with all their rights. The municipal councils were, however, maintained to carry out the orders of the military chiefs. The new municipal law of 1870, first introduced at Warsaw, reduced the functions of the municipal council almost to nothing. The burgomaster is entirely dependent upon the police and the chief of the district, and has to discharge all sorts of functions (baillif, policeman, &c.) which have nothing to do with municipal affairs. In all official communications the Russian language is obligatory, and a gradual elimination of Poles from the administration has been effected.

Defence.—Poland contains the first line of defence of the Russian empire on its western frontier. The marshy lowlands, covered with forests on the western bank of the Vistula, are a natural defence against an army advancing from the west, and they are strengthened by the fortresses on that river. The centre of these latter is Warsaw, with Novogorogievsk, formerly Modlin, in the north, at the mouth of the Bug, and Ivangorod, formerly Demblin, in the south, at the mouth of the Wieprz. Novogorogievsk is a strongly fortified camp which requires a garrison of 12,000 men, and may shelter an army of 50,000 men. The town of Sierock, at the confluence of the Bug and the Narew, is fortified to protect the rear of Novogorogievsk. The Vistula line of fortresses labours, however, under the great disadvantage of being easily turned from the rear by armies advancing from East Prussia or Galicia. Brest-Litovsk, at the western issue from the marshes of the Pripiet, the towns of Dubno, Lutsk and Bobruisk constitute the second line of defence.

Religion and Education.—The prevalent religion is the Roman Catholic, to which over 75% of the total population belong. Protestants (mostly Lutherans) amount to 6%, while about 5% are members of the Orthodox Greek Church. After the insurrection of 1863, measures were taken to reduce the numbers of the Roman Catholic clergy in Poland. One diocese (Podlaskie) was abolished, and a new one established at Kielce, while several bishops were sent out of the country. Poland is now divided into four dioceses—Warsaw, Siedlce, Lublin and Plock.

The educational institutions of Poland are represented by a university at Warsaw, with 1500 students. Teaching has been carried on in Russian since 1873. There are excellent technical schools, an institute of agriculture and forestry at Nowa-Alexandrya, and several seminaries for teachers. At Warsaw there is a good musical conservatory. The Jewish children are mostly sent to the Jewish schools, but they receive almost no instruction at all. Although there has been a decided increase in the number of both the primary and the secondary schools, nevertheless the school accommodation has in neither category of school kept pace with the growth of the population. The proportion of primary schools has in fact been steadily decreasing, and the applications for admission to the secondary schools and colleges are on the average twice as great as the number of vacancies. All the same, Poland compares very favourably with Russia in the general level of education, for whereas those able to read and write in 1897 amounted in Poland to 30.5% of the population (only 9.3% in 1862), in Russia it was 19.8%.

(P. A. K.; J. T. Bx.)

POLARITY (Lat. *polaris*, *polus*, pole), having two poles or parts at which certain properties are the opposite to one another, as in a magnet the ends of which have opposite magnetic characters. The act of producing polarity is termed **polarization**. For electrolytic polarization see **BATTERY** and **ELECTROLYSIS**, and for optical see **POLARIZATION OF LIGHT** below.

POLARIZATION OF LIGHT. A stream of light coming directly from a natural source has no relation to space except that concerned in its direction of propagation, round which its properties are alike on all sides. That this is not a necessary characteristic of light was discovered by Christian Huygens, who found that, whereas a stream of sunlight in traversing a rhomb of spar in any but one direction always gives rise to two streams of equal brightness, each of these emergent streams is divided by a second rhomb into two portions having a relative intensity dependent upon the position with respect to one another of the principal planes of the faces of entry into the rhombs—the planes through the axes of the crystals perpendicular to the refracting surfaces. In certain cases, indeed, one portion vanishes entirely: thus the stream ordinarily refracted in the first rhomb gives an ordinary or an extraordinary stream alone in the second, according as the principal planes are parallel or perpendicular, the reverse being the case with the extraordinary stream of the first rhomb. In intermediate cases the intensities of the two beams are proportional to the squares of the cosines of the angles that the principal plane of the second rhomb makes with the positions in which they have the greatest intensity.

On the other hand, if the emergent streams overlap and the common part be examined, it is found to have all the properties of common light. To this phenomenon E. T. Malus gave the name of *polarisation*, as he attributed it, on the emission theory of light, to a kind of polarity of the light-corpuscles. This term has been retained and the ordinary stream is said to be plane polarized in the principal plane of the face of entry into the rhomb, and the extraordinary stream to be plane polarized in the perpendicular plane.

The phenomenon of polarization observed by Huygens remained an isolated fact for over a century, until Malus in 1808 discovered that polarization can be produced independently of double refraction, and must consequently be something closely connected with the nature of light itself. Examining the light reflected from the windows of the Luxembourg palace with a doubly refracting prism, he was led to infer (though more refined experiments have shown that this is not strictly the case) that light reflected at a certain angle, called the *polarising angle*, from the surface of transparent substances has the same properties with respect to the plane of incidence as those of the ordinary stream in Iceland spar with respect to the principal plane of the crystal. Thus in accordance with the definition, it is polarized in the plane of incidence. Further, if polarized light fall at the polarizing angle on a reflecting surface, the intensity of the reflected stream depends upon the azimuth of the plane of incidence, being proportional to the square of the cosine of the angle between this plane and the plane of the polarization. At angles other than the polarizing angle common light gives a reflected stream that behaves as a mixture of common light with light polarized in the plane of incidence, and is accordingly said to be partially polarized in that plane. The refracted light, whatever be the angle of incidence, is found to be partially polarized in a plane perpendicular to the plane of incidence, and D. F. J. Arago showed that at all angles of incidence the reflected and refracted streams contain equal quantities of polarized light. The polarizing angle varies from one transparent substance to another, and Sir David Brewster in 1815 enunciated the law that the tangent of the polarizing angle is equal to the refractive index of the substance. It follows then that if a stream of light be incident at the polarizing angle on a pile of parallel transparent plates of the same nature, each surface in turn will be met by the light at the polarizing angle and will give rise to a reflected portion polarized in the plane of incidence. Hence the total reflected light will be polarized in this plane and will of necessity have a greater intensity than that produced by a single surface. The polarization of the light transmitted by the pile is never complete, but tends to become more nearly so as the number of the plates is increased and at the same time the angle of incidence for which the polarization is a maximum approaches indefinitely the polarizing angle (Sir G. G. Stokes, *Math. and Phys. Papers*, iv. 145).

In order to isolate a polarized pencil of rays with a rhomb of Iceland spar, it is necessary to have a crystal of such a thickness that the emergent streams are separated, so that one may be stopped by a screen. There are, however, certain crystals that with a moderate thickness give an emergent stream of light that is more or less completely polarized. The polarizing action of such crystals is due to the unequal absorption that they exert on polarized streams. Thus a plate of tourmaline of from 1 mm. to 2 mm. in thickness with its faces perpendicular to the optic axis is nearly opaque to light falling normally upon it, and a plate of this thickness parallel to the axis permits of the passage of a single stream polarized in a plane perpendicular to the principal section. Such a plate acts in the same way on polarized light, stopping it or allowing it to pass, according as the plane of polarization is parallel or perpendicular to the principal section. Certain artificial salts, e.g. iodo-sulphate of quinine, act in a similar manner.

From the above instances we see that an instrumental appliance that polarizes a beam of light may be used as a means of detecting and examining polarization. This latter process is termed *analysis*, and an instrument is called a *polarizer*

or an *analyser* according as it is used for the first or the second of these purposes.

In addition to the above facts of polarization mention may be made of the partial polarization, in a plane perpendicular to that of emission, of the light emitted in an oblique direction from a white-hot solid, and of the polarization produced by diffraction. Experiments with gratings have been instituted by Sir G. Gabriel Stokes, C. H. A. Holtzmann, F. Eisenlohr and others, with the view of determining the direction of the vibrations in polarized light (*vide infra*), but the results have not been consistent, and H. Fizeau and G. H. Quincke have shown that they depend upon the size and form of the apertures and upon the state of the surface on which they are traced. The polarization of the light reflected from a glass grating has also been investigated by I. Fröhlich, while L. G. Gouy has studied the more simple case of diffraction at a straight edge. The polarization of the light scattered by small particles has been examined by G. Govi, J. Tyndall, L. Soret and A. Lallemand, and in the case of ultramicroscopic particles by H. Siedentopf and R. Zsigmondy (*Drude Ann.* 1903, x. 1); an interesting case of this phenomenon is the polarization of the light from the sky—a subject that has been treated theoretically by Lord Rayleigh in an important series of papers (See SKY, COLOUR OF, and Rayleigh, *Scientific Works*, i. 87, 104, 518; iv. 397).

An important addition to the knowledge of polarization was made in 1816 by Augustin J. Fresnel and D. F. J. Arago, who summed up the results of a searching series of experiments in the following laws of the interference of polarized light: (1) Under the same conditions in which two streams of common light interfere, two streams polarized at right angles are without mutual influence. (2) Two streams polarized in parallel planes give the same phenomena of interference as common light. (3) Two streams polarized at right angles and coming from a stream of common light can be brought to the same plane of polarization without thereby acquiring the faculty of interfering. (4) Two streams polarized at right angles and coming from a stream of polarized light interfere as common light, when brought to the same plane of polarization. (5) In calculating the conditions of interference in the last case, it is necessary to add a half wave-length to the actual difference of path of the streams, unless the primitive and final planes of polarization lie in the same angle between the two perpendicular planes.

The lateral characteristics of a polarized stream lead at once to the conclusion that the stream may be represented by a vector, and since this vector must indicate the direction in which the light travels as well as the plane of polarization, it is natural to infer that it is transverse to the direction of propagation. That this is actually the case is proved by experiments on the interference of polarized light, from which it may be deduced that the polarization-vector of a train of plane waves of plane polarized light executes rectilinear vibrations in the plane of the waves. By symmetry the polarization-vector must be either parallel or perpendicular to the plane of polarization: which of these directions is assumed depends upon the physical characteristic that is attributed to the vector. In fact, whatever theory of light be adopted, there are two vectors to be considered, that are at right angles to one another and connected by purely geometrical relations.

The general expressions for the rectangular components of a vector transverse to the direction of propagation (s) in the case of waves of length λ travelling with speed v are:—

$$s = a \cos (T - \alpha), \quad v = b \cos (T - \beta),$$

where $T = 2\pi(vt - s)/\lambda$. The path of the extremity of the vector is then in general an ellipse, traversed in a right-handed direction to an observer receiving the light when $\alpha - \beta$ is between 0 and π , or between $-\pi$ and $-\pi/2$, and in a left-handed direction if this angle be between π and $3\pi/2$, or between 0 and $-\pi$. In conformity with the form of the path, the light is said to be elliptically polarized, right- or left-handedly as the case may be, and the axes of the elliptic path are determined by the planes of

maximum and minimum polarization of the light. In the particular case in which $a=b$ and $\alpha-\beta = \pm(2n+1)\pi/2$, the vibrations are circular and the light is said to be circularly polarized.

These different types of polarization may be obtained from a plane polarized stream by passing it through a quarter-wave plate, i.e. a crystalline plate of such a thickness that it introduces a relative retardation of a quarter of a wave between the component streams within it. Such plates are generally made of mica or selenite, and the normal to the plane of polarization of the most retarded stream is called "the axis of the plate." If this axis be parallel or perpendicular to the primitive plane of polarization, the emergent beam remains plane polarized; it is circularly polarized if the axis be at 45° to the plane of polarization, and in other cases it is elliptically polarized with the axes of the elliptic path parallel and perpendicular to the axis of the plate. Conversely a quarter-wave plate may be employed for reducing a circularly or elliptically polarized stream to a state of plane polarization.

Two streams are said to be oppositely polarized when the one is, so far as relates to its polarization, what the other becomes when it is turned through an azimuth of 90° and has its character reversed as regards right and left hand. An analytical investigation of the conditions of interference of polarized streams of the most general type leads to the result that there will be no interference only when the two streams are oppositely polarized, and that when the polarizations are identical the interference will be perfect, the fluctuations of intensity being the greatest that the difference of intensity of the streams admits (Sir G. G. Stokes, *Math. and Phys. Papers*, iii. 233).

It remains to consider the constitution of common unpolarized light. Since a beam of common light can be resolved into plane polarized streams and these on recombination give a stream with properties indistinguishable from those of common light, whatever their relative retardation may be, it is natural to assume that an analytical representation of common light can be obtained in which no longitudinal vector occurs. On the other hand a stream of strictly monochromatic light with a polarization-vector that is entirely transversal must be (in general elliptically) polarized. Consequently it follows that common light cannot be absolutely monochromatic. The conditions that are necessary in order that a stream of light may behave as natural light have been investigated by Sir G. Gabriel Stokes (*loc. cit.*) and by E. Verdet (*Oscures*, i. 281), and it may be shown that two polarized streams of a definite character are analytically equivalent to common light provided that they are of equal intensity and oppositely polarized and that there is no common phase relation between the corresponding monochromatic constituents. Further a stream of light of the most general character is equivalent to the admixture of common and polarized light, the polarization being elliptical, circular or plane.

We see then that there are seven possible types of light: common light, polarized light and partially polarized light; the polarization in the two latter cases being elliptical, circular or plane. Common light, circularly polarized and partially circularly polarized light all have the characteristic of giving two streams of equal intensity on passing through a rhomb of Iceland spar, however it may be turned. They may, however, be distinguished by the fact that on previous transmission through a quarter-wave plate this property is retained in the case of common light, while with the two other types the relative intensity of the streams depends upon the orientation of the rhomb, and with circularly polarized light one stream may be made to vanish. Plane polarized light gives in general two streams of unequal intensity when examined with a rhomb, and for certain positions of the crystal there is only one emergent stream. Elliptically polarized, partially elliptically polarized and partially plane polarized light give with Iceland spar two streams of, in general, unequal intensity, neither of which can be made to vanish. They may be differentiated by first passing the light through a quarter-wave plate with its axis parallel or

perpendicular to the plane of maximum polarization: for elliptically polarized light thereby becomes plane polarized and one of the streams is extinguished on rotating the rhomb; but with the other two kinds of light this is not the case, and the light is partially plane or partially elliptically polarized according as the plane of maximum polarization remains the same or is changed.

Colours of Crystalline Plates.—It was known to E. T. Malin that the interposition of a doubly refracting plate between a polarizer and an analyser regulated for extinction has the effect of partially restoring the light, and he used this property to discover double refraction in cases in which the separation of the two refracted streams was too slight to be directly detected. D. F. J. Arago in 1811 found that in the case of white light and with moderately thin plates the transmitted light is no longer white but coloured, a variation of brightness but not of tint being produced when the polarizer and analyser being crossed are rotated together, while the rotation of the analyser alone produces a change of colour, which passes through white into the complementary tint. This phenomenon was subjected to a detailed investigation by Jean Baptiste Biot during the years 1812 to 1814, and from the results of his experiments Thomas Young, with his brilliant acumen, was led to infer that the colours were to be attributed to interference between the ordinary and extraordinary streams in the plate of crystal. This explanation is incomplete, as it leaves out of account the action of the polarizer and analyser, and it was with the purpose of removing this defect that Fresnel and Arago undertook the investigation mentioned above and thus supplied what was wanting in Young's explanation. In Biot's earlier experiments the beam of light employed was nearly parallel; the phenomena of rings and brushes that are seen with a conical pencil of light were discovered by Sir David Brewster in the case of uniaxial crystals in 1813 and in that of biaxial crystals in 1815.

Let α, β, ψ be the angles that the primitive and final phases of polarization and the plane of polarization of the quicker wave within the plate make with a fixed plane, and let ρ be the relative retardation of phase of the two streams on emergence from the plate for light of period τ . On entry into the crystal the original polarized stream is resolved into components represented by

$$a \cos(\psi - \alpha) \cos T, \quad a \sin(\psi - \alpha) \cos T, \quad T = 2\pi t/\tau,$$

and on emergence we may take as the expression of the waves

$$a \cos(\psi - \alpha) \cos T, \quad a \sin(\psi - \alpha) \cos(T - \rho).$$

Finally after traversing the analyser the sum of the two resolved components is

$$a \cos(\psi - \alpha) \cos(\psi - \beta) \cos T + a \sin(\psi - \alpha) \sin(\psi - \beta) \cos(T - \rho),$$

of which the intensity is

$$[a \cos(\psi - \alpha) \cos(\psi - \beta) + a \sin(\psi - \alpha) \sin(\psi - \beta) \cos \rho]^2 +$$

$$a^2 \sin^2(\psi - \alpha) \sin^2(\psi - \beta) \sin^2 \rho =$$

$$a^2 \cos^2(\beta - \alpha) - a^2 \sin 2(\psi - \alpha) \sin 2(\psi - \beta) \sin^2 \rho.$$

When the primitive light is white, this expression must be summed for the different monochromatic constituents. In strictness the angle ρ is dependent upon the frequency, but if the dispersion be weak relatively to the double refraction, the product $\sin 2(\psi - \alpha) \sin 2(\psi - \beta)$ has sensibly the same value for all terms of the summation, and we may write

$$I = \cos^2(\beta - \alpha) Z a^2 - \sin 2(\psi - \alpha) \sin 2(\psi - \beta) Z a^2 \sin^2 \rho.$$

This formula contains the whole theory of the colours of crystalline plates in polarized light. Since the first term represents a stream of white light, the plate will appear uncoloured whenever the plane of polarization of either stream transmitted by it coincides with either the primitive or final plane of polarization. In intermediate cases the field is coloured, and the tint changes to its complementary as the plate passes through one of these eight positions, since the second term in the above expression then changes sign. If, however, the primitive and final planes of polarization be parallel or crossed, the field exhibits only one colour during a complete revolution of the plates.

The crystalline plate shows no colour when it is very thin, and also when its thickness exceeds a moderate amount. In the former case the retardation of phase varies so little with the period that the intensity is nearly the same for all colours; in the latter case it alters so rapidly that for a small change in the period the intensity passes from a maximum or a minimum, and consequently so many constituents of the light are weakened and these are so close to one another in frequency, that the light presents to the eye the appearance of being white. The true character of the light in this case may be revealed by analysing it with a spectroscopie, when a spectrum is obtained traversed by dark bands corresponding to the constituents that are weakened or annulled. The phenomenon of colour may, however, be obtained with thick plates by superposing two of them in a suitable manner, the combination acting as a thicker or a thinner plate according as the planes of polarization of the quicker waves within them are parallel or crossed. In this way a delicate test for slight traces of double refraction is obtained. When the retardation of phase for light of mean period is τ or a small multiple of τ a crystalline plate placed between a crossed polarizer and analyser

exhibits in white light a distinctive greyish violet colour, known as a sensitive tint from the fact that it changes rapidly to blue or red, when the retardation is very slightly increased or diminished. If then the sensitive plate be cut in half and the two parts be placed side by side after the one has been turned through 90° in its own plane, the tint of the one half will be raised and that of the other will be lowered when the compound plate is associated with a second doubly refracting plate.

When light from an extended source is made to converge upon the crystal, the phenomenon of rings and brushes localized at infinity is obtained. The exact calculation of the intensity in this case is very complicated and the resulting expression is too unwieldy to be of any use, but as an approximation the formula for the case of a parallel beam may be employed, the quantities ψ and ρ therein occurring being regarded as functions of the angle and plane of incidence and consequently as variables. In monochromatic light, then, the interference pattern is characterized by three systems of curves: the curves of constant retardation $\rho = \text{const.}$; the lines of like polarization $\psi = \text{const.}$; the curves of constant intensity $I = \text{const.}$ When $\rho = 2\pi n$ and also when $\psi = \alpha$ or $\alpha + \pi/2$ or $\psi = \beta$ or $\beta + \pi/2$, that is at points for which the streams within the plate are polarized in planes parallel and perpendicular to the planes of primitive and final polarization, the intensity (called the fundamental intensity) is the same as when the plate is removed. These conditions define two systems of curves called respectively the principal curves of constant retardation and the principal lines of like polarization, these latter lines dividing the field into regions in which the intensity is alternately greater and less than the fundamental intensity. When, however, the planes of polarization and analysis are parallel or crossed, the two pairs of principal lines of like polarization coincide, and the intensity is at all points in the former case not greater than, and in the latter case not less than, it was before the introduction of the plate. The determination of the curves of constant retardation depends upon expressing the retardation in terms of the optical constants of the crystal, the angle of incidence and the azimuth of the plane of incidence. P. A. Bertin has shown that a useful picture of the form of these curves may be obtained by taking sections, parallel to the plate, of a surface that he calls the "isochromatic surface," and that is the locus of points on the crystal at which the relative retardation of two plane waves passing simultaneously through a given point and travelling in the same direction has an assigned value. But as this surface is obtained by assuming that the interfering streams follow the same route in the crystal, and by neglecting the refraction out of the crystal, it does not lend itself to accurate numerical calculations. To the same degree of accuracy as that employed in obtaining the expression for the intensity, the form of the lines of like polarization is given by the section, parallel to the plate, of a cone, whose generating lines are the directions of propagation of waves that have their planes of polarization parallel and perpendicular to a given plane: the cone is in general of the third degree and passes through the optic axes of the crystal. We must limit ourselves in this article to indicating the chief features of the phenomenon in the most important cases. (Reference should be made to the article CRYSTALLOGRAPHY for illustrations and for applications of these phenomena to the determination of crystal form.)

With an uniaxial plate perpendicular to the optic axis, the curves of constant retardation are concentric circles and the lines of like polarization are the radii; thus with polarizer and analyser regulated for extinction, the pattern consists of a series of bright and dark circles interrupted by a black cross with its arms parallel to the planes of polarization and analysis. In the case of a biaxial plate perpendicular to the bisector of the acute angle between the optic axes, the curves of constant retardation are approximately Cassini's ovals, and the lines of like polarization are equilateral hyperbolae passing through the points corresponding to the optic axes. With a crossed polarizer and analyser the rings are interrupted by a dark hyperbolic brush that cuts the plane of the optic axes at right angles, if this plane be at 45° to the planes of polarization and analysis—the so-called diagonal position—and that becomes a rectangular cross with its arms parallel and perpendicular to the plane of the optic axes when this plane coincides with the plane of primitive or final polarization—the normal position.

When white light is employed coloured rings are obtained, provided the relative retardation of the interfering streams be not too great. The isochromatic lines, unless the dispersion be excessive, follow in the main the course of the curves of constant retardation, and the principal lines of like polarization are with a crossed polarizer and analyser dark brushes, that in certain cases are fringed with colour. This state of things may, however, be considerably departed from if the axes of optical symmetry of the crystal are different for the various colours. The examination of dispersion of the optic axes in biaxial crystals (see REFRACTION, § Double) may be conveniently made with a plate perpendicular to the acute bisectrix placed in the diagonal position for light of mean period between a crossed polarizer and analyser. When the rings are coloured symmetrically with respect to two perpendicular lines the acute bisectrix and the plane of the optic axes are the same for all frequencies, and the colour for which the separation of the axes is the least is that on the concave side of the summit of the hyperbolic brushes.

Crossed, inclined and horizontal dispersion are characterized respectively by a distribution of colour that is symmetrical with respect to the centre alone, the plane of the optic axes, and the perpendicular plane.

The phenomenon of interference produced by crystalline plates is considerably modified if the light be circularly or elliptically polarized or analyzed by the interposition of a quarter-wave between the crystal and the polarizer or analyser. Thus in the two cases described above the brushes disappear and the rings are continuous when the light is both polarized and analyzed circularly. But the most important case, on account of its practical application to determining the sign of a crystal, is that in which the light is plane polarized and circularly analyzed or the reverse. Let us suppose that the light is circularly analyzed and that the primitive and final planes of polarization are at right angles. Then with an uniaxial plate perpendicular to the optic axis, the black cross is replaced by two lines, on crossing which the rings are discontinuous, expansion or contraction occurring in the quadrants that contain the axis of the quarter-wave plate, according as the crystal is positive or negative. With a biaxial plate perpendicular to the optic axis in the diagonal position, the hyperbolic brush becomes an hyperbolic line and the rings are expanded or contracted on its concave side, with a positive plate, according as the plane of the optic axes is parallel or perpendicular to the axis of the quarter-wave plate, the reverse being the case with a negative plate.

With a combination of plates in plane-polarized and plane-analyzed light the interference pattern with monochromatic light is generally very complicated, the dark curves when polarizer and analyser are crossed being replaced by isolated dark spots or segments of lines. When, however, the field is very small, or when the primitive light is white so that interference is only visible for small relative retardations, the problem becomes in many cases one of far less complexity. An instance of considerable importance is afforded by the combination known as Savart's plate. This consists of two plates of an uniaxial crystal of equal thickness, cut at the same inclination of about 45° to the optic axis and superposed with their principal planes at right angles. The interference pattern produced by this combination is, when the field is small, a system of parallel straight lines bisecting the angle between the principal planes of its constituents. These attain their maximum visibility when the plane of analysis is at 45° to these planes, and vanish when the plane of polarization is parallel to either of the principal planes.

The phenomena of chromatic polarization afford a ready means of detecting doubly refracting structure in cases, such as that produced in isotropic bodies by strain, in which its effects are very minute. Thus a bar of glass of sufficient thickness, placed in the diagonal position between a crossed polarizer and analyser and bent in a plane perpendicular to that of vision, exhibits two sets of coloured bands separated by a neutral line, the double refraction being positive on the dilated and negative on the compressed side. Again, a system of rings, similar to those of an uniaxial plate perpendicular to the axis, may be produced with a glass cylinder by transmitting heat from its surface to its axis by immersion in heated oil, and glass that has been raised to a red heat and then cooled rapidly at its edges gives in polarized light an interference pattern of a regular form dependent upon the shape of the contour.

Rotary Polarisation.—In general a stream of plane-polarized light undergoes no change in traversing a plate of an uniaxial crystal in the direction of its axis, and when the emergent stream is analyzed, the light, if originally white, is found to be colourless and to be extinguished when the polarizer and analyser are crossed. When, however, a plate of quartz is used in this experiment, the light is coloured and is in no case cut off by the analyser, the tint, however, changing as the analyser is rotated. This phenomenon may be explained, as D. F. J. Arago pointed out, by supposing that in passing through the plate the plane of polarization of each monochromatic constituent is rotated by an amount dependent upon the frequency—an explanation that may be at once verified either by using monochromatic light or by analysing the light with a spectroscope, the spectrum in the latter case being traversed by one or more dark bands, according to the thickness of the plate, that pass along the spectrum from end to end as the analyser is rotated. J. B. Biot further ascertained that this rotation of the plane of polarization varies as the distance traversed in the plate and very nearly as the inverse square of the wave-length, and found that with certain specimens of quartz the rotation is in a clockwise or right-handed direction to an observer receiving the light, while in others it is in the opposite direction, and that equal plates of the right- and left-hand varieties neutralize one another's effects.

A similar rotary property is possessed by other uniaxial crystals, such as cinnabar and the thiosulphates of potassium, lead and calcium, and as H. C. Pocklington (*Phil. Mag.* 1901 [6] li. 361) and J. H. Dufet (*Journ. de phys.*, 1904 [4], iii. 757) have shown by a few biaxial crystals, such as sugar and Rochelle salt, the rotation produced by a given thickness being in general different, and in some cases of opposite sign for the two optic axes. Further, certain cubic crystals, such as sodium chlorate and bromate, and also some liquids and even vapours, rotate the plane of polarization of the light that traverses them, whatever may be the direction of the stream.

In crystals the rotary property appears to be sometimes inherent

in the crystalline arrangement of the molecules, as it is lost on fusion or solution, and in several cases belongs to enantiomorphous crystals, the two correlated forms of which are the one right-handed and the other left-handed optically as well as crystallographically, this being necessarily the case if the property be retained when the crystal is fused or dissolved. In organic bodies the rotary property, as the researches of J. A. Le Bel, J. H. van't Hoff and others have established, corresponds to the presence of one or more asymmetric atoms of carbon—that is, atoms directly united to elements or radicals all different from one another—and in every case there exists an isomer that rotates the plane of polarization to the same degree in the opposite direction. Absence of rotary power when asymmetric carbon atoms are present, may be caused by an internal compensation within the molecule as with the inactive tartaric acid (meso-tartaric acid), or may be due to the fact that the compound is an equimolecular mixture of left- and right-hand varieties, this being the case with racemic acid that was broken by Louis Pasteur into laevo- and dextro-tartaric acid (see STEREO-ISOMERISM).

Substances that by reason of the structure or arrangement of their molecules rotate the plane of polarization are said to be structurally active, and the rotation produced by unit length is called their rotary power. If unit mass of a solution contain m grammes of an active substance and if d be the density and ρ be the rotary power of the solution, the specific rotary power is defined by ρ/m , and the molecular rotary power is obtained from this by multiplying by the hundredth part of the molecular mass. This quantity is not absolutely constant, and in many cases varies with the concentration of the solution and with the nature of the solvent. A mixture of two active substances, or even of an active and an inactive substance, in one solution sometimes produces anomalous effects.

Fresnel showed that rotary polarization could be explained kinematically by supposing that a plane-polarized stream is resolved on entering an active medium into two oppositely circularly polarized streams propagated with different speeds, the rotation being right- or left-handed according as the right- or left-handed stream travels at the greater rate.

The polarization-vector of the primitive stream being $\xi = a \cos nt$, the first circularly polarized stream after traversing a distance s in the medium may be represented by

$$\xi = a \cos (nt - ks), \quad \eta = a \sin (nt - ks),$$

and the second by

$$\xi = a \cos (nt - ks), \quad \eta = -a \sin (nt - ks).$$

The resultant of these is

$$\xi = 2a \cos \frac{1}{2} (k_1 - k_2)s \cos \left[nt - \frac{1}{2} (k_1 + k_2)s \right],$$

$$\eta = 2a \sin \frac{1}{2} (k_1 - k_2)s \cos \left[nt - \frac{1}{2} (k_1 + k_2)s \right],$$

which shows that for any fixed value of s the light is plane polarized in a plane making an angle $\frac{1}{2}(k_1 - k_2)s = \pi(\lambda_1^{-1} - \lambda_2^{-1})s$, with the initial plane of polarization, λ_1 and λ_2 being the wave-lengths of the circular components of the same frequency.

Since the two circular streams have different speeds, Fresnel argued that it would be possible to separate them by oblique refraction, and though the divergence is small, since the difference of their refractive indices in the case of quartz is only about 0.0007, he succeeded by a suitable arrangement of alternately right- and left-handed prisms of quartz in resolving a plane-polarized stream into two distinct circularly polarized streams. A similar arrangement was used by Ernst v. Fleischi for demonstrating circular polarization in liquids. This result is not, however, conclusive; for an application of Huygens's principle shows that it is a consequence of the rotation of the plane of polarization by an amount proportional to the distance traversed, independently of the state of affairs within the active medium. Not more convincing is a second experiment devised by Fresnel. If in the interference experiment with Fresnel's mirrors or biprism the slit be illuminated with white light that has passed through a polarizer and a quartz plate cut perpendicularly to the optic axis, it is found on analysing the light that in addition to the ordinary central set of coloured fringes two lateral systems are seen, one on either side of it. According to Fresnel's explanation the light in each of the interfering streams consists of two trains of waves that are circularly polarized in opposite direction and have a relative retardation of phase, introduced by the passage through the quartz; the central fringes are then due to the similarly polarized waves; the lateral systems are produced by the oppositely polarized streams, these on analysis being capable of interfering. A. Right has, however, pointed out that this experiment may be explained by the fact that the function of the quartz plate and analyser is to eliminate the constituents of the composite stream of white light that mask the interference actually occurring at the positions of the lateral systems of fringes, and that any other method of removing them is equally effective. In fact, the lateral systems are obtained when a plate of selenite is substituted for the quartz.

Sir G. B. Airy extended Fresnel's hypothesis to directions inclined to the axis of uniaxial crystals by assuming that in any such direction the two waves, that can be propagated without alteration of their state of polarization, are oppositely elliptically polarized with their planes of maximum polarization parallel and perpendicular to the principal plane of the wave, these becoming practically plane polarized at a small inclination to the optic axis. Several investigations

have been made to test the correctness of Airy's views, but it must be remembered that it is only possible to experiment on waves after they have left the crystal, and L. C. Gouy (*Journ. de phys.*, 1883 [3], iv. 149) has shown that the results deduced from Airy's waves of permanent type may be obtained by regarding the action of the medium as the superposition of the effects of ordinary double refraction and of an independent rotary power. As regards the course of the streams on refraction into the crystal, it is found that it is determined by the Huygenian law (see REFRACTION, § Double); as, however, the two streams in the direction of the axis have different speeds, the spherical and the spheroidal sheets of the wave-surface do not touch as in the case of inactive uniaxial crystals. On these principles Airy, by an elaborate mathematical investigation, successfully explained the interference patterns obtained with plates of quartz perpendicular to the optic axis. When the polarizer and analyser are parallel or crossed, the pattern is the same as with inactive plates, with the exception that the brushes do not extend to the centre of the field; but as the analyser is rotated a small cross begins to appear at the centre of the field, while the rings change their form and become nearly squares with rounded corners, when the planes of polarization and analysis are at 45° . With two plates of equal thickness and of opposite rotations, the pattern consists of a series of circles and of four similar spirals starting from the centre, each spiral being turned through 90° from that adjacent to it. When the light is circularly polarized or circularly analysed, a single plate gives two mutually inwrapping spirals, and similar spirals in circularly polarized light are obtained with plates of active biaxial crystal perpendicular to one of the optic axes. It was in this way that the rotary property of certain biaxial crystals was first established by Fockington.

F. E. Reusch has shown that a packet of identical inactive plates arranged in spiral fashion gives an artificial active system, and the behaviour of certain pseudosymmetric crystals indicates a formation of this character. On these results L. Sohncke (*Math. Ann.*, 1876, ix. 504) and E. Mallard (*Traité de cristallographie*, vol. II. ch. ix.) have built up a theory of the rotation of active media, but in the instances in which static spirality has been shown to be effective in producing optical rotation the coarse-grainedness of the structure is comparable with the wave-length of the radiation affected.

The rotary property may be induced in substances naturally inactive. Thus A. W. Evell (*Amer. Jour. of Science*, 1899 [4], viii. 89) has shown the existence of a rotational effect in twisted glass and gelatine, the rotation being opposite to the direction of the twist. But a far more important instance of induced activity is afforded by Michael Faraday's discovery of the rotary polarization connected with a magnetic field. There is, however, a marked difference between this magnetic rotation and that of a structurally active medium, for in the latter it is always right-handed or always left-handed with respect to the direction of the ray, while in the former the sense of rotation is determined by the direction of magnetization and therefore remains the same though the ray be reversed. This subject is treated in the article MAGNETO-OPTICS, to which the reader is also referred for John Kerr's discovery of the effect on polarization produced by reflection from a magnetic pole, and for the action of a magnetic field on the radiation of a source—the "Zeeman effect."

Reflection and Refraction.—Huygens satisfactorily explained the laws of reflection and refraction on the principles of the wave theory, so far as the direction of the waves is concerned, but his explanation gives no account of the intensity and the polarization of the reflected light. This was supplied by Fresnel, who, starting from a mechanical hypothesis, showed by ingenious but not strictly dynamical reasoning that if the incident stream have unit amplitude, that of the reflected stream will be

$$-\sin (\delta-r) / \sin (\delta+r) \text{ or } \tan (\delta-r) / \tan (\delta+r),$$

according as the incident light is polarized in or perpendicularity to the plane of incidence i, r , being the angles of incidence and refraction connected by the formula $\sin i = \mu \sin r$. At normal incidence the intensity of the reflected light, measured by the square of the amplitude, is $[(\mu-1)/(\mu+1)]^2$ in both cases; but whereas in the former the intensity increases uniformly with i to the value unity for $i=90^\circ$, in the latter the intensity at first decreases as i increases, until it attains the value zero when $i+r=90^\circ$, or $\tan i = \mu$ —the polarizing angle of Brewster—and then increases until it becomes unity at grazing incidence. If the incident light be polarized in a plane making an angle α with the plane of incidence, the stream may be resolved into two that are polarized in the principal axes, and these will be reflected in accordance with the above laws. Hence if β be the angle between the plane of incidence and that in which the reflected light is polarized

$$\tan \beta = -\tan \alpha \cos (\delta+r) / \cos (\delta-r).$$

The expressions for the intensity of the refracted light may be obtained from those relating to the reflected light by the principle of energy. In order to avoid the question of the measurements of the intensity in different media, it is convenient to suppose that the refracted stream emerges into a medium similar to the first by a transition so gradual that no light is lost by reflection. The intensities of the incident, reflected and refracted streams are then measured in the same way, and we have merely to express that

the square of the amplitude of the incident vibrations is equal to the sum of the squares of the amplitudes of the reflected and refracted vibrations.

Fresnel obtained his formulæ by assuming that the optical difference of media is due to a change in the effective density of the ether, the elasticity being the same—an assumption inconsistent with his theory of double refraction—and was led to the result that the vibrations are perpendicular to the plane of polarization. Franz Neumann and James MacCullagh, starting from the opposite assumption of constant density and different elasticities, arrived at the same formulæ for the intensities of the reflected light polarized in the principal azimuths, but in this case the vibrations must be regarded as parallel to the plane of polarization. The divergence of these views has led to a large number of experimental investigations, instituted with the idea of deciding between them. In the main such investigations have only an academic interest, as, whatever theory of light be adopted, we have to deal with two vectors that are parallel and perpendicular respectively to the plane of polarization. Thus certain experiments of Otto H. Waeber (*Wied. Ann.*, 1890, xl, 203) show that chemical action is to be referred to the latter of the vectors, but whether Fresnel's or Neumann's hypothesis be correct is only to be decided when we know if it be the mean kinetic energy or the mean potential energy that determines chemical action. Similarly on the electromagnetic theory the electric or the magnetic force will be perpendicular to the plane of polarization, according as chemical action depends upon the electric or the magnetic energy. Lord Rayleigh (*Scientific Papers*, i 104) has, however, shown that the polarization of the light from the sky can only be explained on the elastic solid theory by Fresnel's hypothesis of a different density, and from the study of Hertzian oscillations, in which the direction of the electric vibrations can be a priori assigned, we learn that when these are in the plane of incidence there is no reflection at a certain angle, so that the electric force is perpendicular to the plane of polarization.

It has been supposed in the above that the medium into which the light enters at the reflecting-surface is the more refracting. In the contrary case, total reflection commences as soon as $\sin i = \mu^{-1}$, μ being still the relative refractive index of the more highly refracting medium; and for greater angles of incidence r becomes imaginary. Now Fresnel's formulæ were obtained by assuming that the incident, reflected and refracted vibrations are in the same or opposite phases at the interface of the media, and since there is no real factor that converts $\cos T$ into $\cos(T+\pi)$, he inferred that the occurrence of imaginary expressions for the coefficients of vibration denotes a change of phase other than π , this being represented by a change of sign. If this be so, it is clear that the factor $\sqrt{-1}$ denotes a change of phase of $\pi/2$, since this twice repeated converts $\cos T$ into $\cos(T+\pi) = -\cos T$, and hence that the factor $a+ib\sqrt{-1}$ represents a change of phase of $\tan^{-1}(b/a)$. Applying this interpretation to the formulæ given above, it follows that when the incident light is polarized at an azimuth α to the plane of incidence and the second medium is the less refracting, the reflected light at angles of incidence exceeding the critical angle is elliptically polarized with a difference of phase Δ between the components polarized in the principal azimuths that is given by

$$\tan(\Delta/2) = \cot v \sqrt{1 - \mu^2 \cos^2 i}.$$

Thus Δ is zero at grazing incidence and at the critical angle, and attains its maximum value $\pi - 4 \tan^{-1}(1/\mu)$ at an angle of incidence given by $\sin^2 i = 2/(1+\mu^2)$.

It is of some interest to determine under what conditions it is possible to obtain a specified difference of phase. Solving for $\cot^2 i$ we obtain

$$2 \cot^2 i = (\mu^2 - 1)^2 \pm \sqrt{[(\mu^2 - \tan^2(\pi - \Delta/4))\{\mu^2 - \cot^2(\pi - \Delta/4)\}]},$$

and since $\tan\{(\pi - \Delta/4)\}$ is less than unity, μ must exceed $\cot\{(\pi - \Delta/4)\}$ if $\cot^2 i$ is to be real. Thus if $\Delta = \pi/2$, μ must exceed $\pi/8$ or 2.414 , that is, the substance must be at least as highly refracting as a diamond if $\Delta = \pi/4$, μ must be greater than $\pi/16$ or 1.4966, and when this is the case, it is possible by two reflections to convert into a circularly polarized stream a beam of light polarized at 45° to the plane of incidence. This is the principle of Fresnel's rhomb, that is sometimes employed instead of a quarter-wave plate for obtaining a stream of circularly polarized light. It consists of a parallelepiped glass so constructed that light falling normally on one end emerges at the other after two internal reflections at such an angle as to introduce a relative retardation of phase of $\pi/4$ between the components polarized in the principal azimuths.

Fresnel's formulæ are sufficiently accurate for most practical purposes, but that they are not an exact representation of the facts of reflection was shown by Sir David Brewster and by Sir G. B. Airy. Detailed investigations by J. C. Jamieson, G. H. Quincke, C. W. Wernicke and others have established that in general light polarized in any but the principal azimuths becomes elliptically polarized by reflection, the relative retardation of phase of the components polarized in these azimuths becoming $\pi/2$ at a certain angle of incidence, called the principal incidence. In some cases it is the component polarized in the plane of incidence that is most retarded and the reflection is then said to be positive; in the case of negative reflection the reverse takes place. It was at first supposed

that the defect of Fresnel's formulæ was due to the neglect of the superficial undulations that, on a rigorous elastic solid theory of the ether, are called into existence at reflection and refraction. But the result of taking these into account is far from being in accordance with the facts, and experiments of Lord Rayleigh and Paul Drude make it probable that we ought to assume that the transition from one medium to another, though taking place in a distance amounting to about one fiftieth of a wave-length, is gradual instead of abrupt. The effect of such a transition-layer can easily be calculated, at least approximately; but it is of little use to take account of it except in the case of a theory of reflection that gives Fresnel's formulæ as the result of an abrupt transition. Lord Rayleigh has pointed out that all theories are defective in that they disregard the fact that one at least of the media is dispersive, and that it is probable that finite reflection would result at the interface of media of different dispersive powers, even in the case of waves for which the refractive indices are absolutely the same.

A more pronounced case of elliptic polarization by reflection is afforded by metals. Formulæ for metallic reflection may be obtained from Fresnel's expressions by writing the ratio $\sin i/\sin r$ equal to a complex quantity, and interpreting the imaginary coefficients in the manner explained above. The optical constants (refractive index and co-efficient of extinction) of the metal may then be obtained from observations of the principal incidence and the elliptic polarization then produced. A detailed investigation of these constants has been made by Drude (*Wied. Ann.*, 1890, xxxix, 504), who has found the remarkable result that copper, gold, magnesium and silver have refractive indices less than unity, and this has been completely confirmed by observations with metallic prisms of small refracting angle. He further showed that except in the cases of copper, lead and gold the dispersion is abnormal—the index for red light being greater than that for sodium light. The higher the co-efficient of extinction for light of a given period, the more copious will be reflection of that constituent of a mixed pencil. This fact has been employed for separating waves of large wave-length, and in this way waves of length 0.061 mm. have been isolated by five successive reflections from the surface of sylvite.

The Study of Polarization.—The best method of obtaining a strong beam of polarized light is to isolate one of the streams into which a beam of common light is resolved by double refraction. This is effected in polarizing prisms of the earlier type, devised by A. M. de Rochon, H. H. de Sénarmont and W. H. Wollaston, by blocking off one of the streams with a screen, sufficient lateral separation being obtained by combining two equal crystalline prisms cut differently with respect to the optic axis—an arrangement that schramatizes more or less completely the pencil that is allowed to pass. In a second type, called Nicol's prisms, one stream is removed by total reflection. Theoretically the best construction for prisms of this class is the following: a rectangular block of Iceland spar, of length about four times the width and having its end and two of its side faces parallel to the optic axis, is cut in half by a plane parallel to the optic axis and making an angle of about 14° with the sides; the two halves are then reunited with a cement whose refractive index is between the ordinary and extraordinary indices of the spar and as nearly as possible equal to the latter. Thus constructed, the prism produces no lateral shift of the transmitted pencil; a conical pencil, incident directly, has nearly constant polarization over its extent, and consequently the error in determining the polarization of a parallel pencil, incident not quite normally, is a minimum. In a Nicol's prism it is the extraordinary stream that passes, in a prism suggested by E. Sang and sometimes called a Bertrand's prism, it is the ordinary stream that is utilized. This is made by fixing a thin crystalline plate between two glass prisms turned in opposite directions by a cement of the same refractive index as the glass. This refractive index should be equal to the greatest index of the plate, and with a biaxial plate the mean axis of optical symmetry should be parallel to its faces and in the normal section of the prisms, while with an uniaxial plate the optic axis should be in a plane perpendicular to this normal section. These prisms have the advantage of economy of material and of a greater field than the ordinary Nicol's prism, but a difficulty seems to be experienced in finding a suitable permanent cement.

For an accurate determination of the plane of polarization analysers that act by extinction are not of much practical use, and a different device has to be employed. Savart's analyser consists of a Savart's plate (see above) connected to a Nicol's prism, the principal section of which bisects the angle between the principal planes of the plate, the plane of polarization is determined by turning the analyser until the bands, ordinarily seen, disappear, in which case it is parallel to one of the principal planes of the plate. Half-shade analysers depend upon the facility with which the eye can distinguish slight differences in the intensities of two streams seen in juxtaposition, when the illumination is not too bright. The field is divided into two parts that for most positions of the analyser have different intensities, and the setting is effected by turning the analyser until both halves are equally dark. These instruments are very sensitive, but care must be taken to avoid errors caused by changes in the relative intensities of parts of the source of light—a precaution that is sometimes overlooked in furnishing polarimeters with these analysers. In J. H. Jellet's and M. A. Cornu's analysers

formed—the one from two parts of a rhomb of spar, the other from two portions of a Nicol's prism—the two halves of the field are analysed in slightly different planes, but these, though they have certain advantages, are now seldom employed, partly on account of a difficulty in their construction and partly because their sensitiveness cannot be adjusted. The more usual half-shade analyser is available for light of only one frequency, as it depends upon the action of a half-wave plate, in traversing which the plane of polarization is turned until it makes the same angle with the principal section as at first but on the opposite side: half the field is covered with the plate, to which is attached a Nicol's prism with its principal section inclined at a small angle to that of the plate. The eye must be focussed on the edge of the plate, and the two halves of the field will only be equally dark when the principal plane of the plate is parallel to the primitive plane of polarization. Another plan, due to J. H. Poynting, is before analysis to impress unequal rotations upon the plane of polarization of the two parts of the field, either by means of an active medium, or by oblique transmission through glass plates.

Elliptically polarized light is investigated by the reduction of the pencil to a state of plane polarization, and a determination of the resulting plane of polarization. One method consists in finding directly the elliptic constants of the vibration by means of a quarter-wave plate and an analyser; but the more usual plan is to measure the relative retardation of two rectangular components of the stream by a Babinet's compensator. This is a plate made of two equal wedges of quartz, that can be moved over one another so as to vary its thickness, and are cut so that the faces of the plate are parallel to the optic axis, which in the first wedge is perpendicular and in the second is parallel to the refracting edge. It is clear that direct transmission through the plate at a point where the thicknesses of the prisms are d_1 and d_2 will introduce a relative retardation of $(\mu - \mu_0)(d_1 - d_2)$ between streams polarized in planes parallel and perpendicular to the edges of the prisms, μ_0 and μ_0' being the ordinary and the extraordinary refractive indices; and it is hence possible by an adjustment of the thickness to reduce elliptically polarized to plane polarization at an assigned point marked off by two parallel lines. A subsequent determination of the plane of polarization gives the ratio of the amplitudes of the vibrations in the component streams.

For the observation and measurement of rings in crystals polariscopes are constructed on the following principle. Light from an extended source passes after polarization through two convex systems of lenses, between which the crystalline plate is placed, and is then received in an eyepiece furnished with an analyser. If measurements be required, the plate must have a motion round an axis perpendicular to that of the optical systems, and also about an axis normal to its faces; the polarizer and analyser must also be capable of adjustment. All the rays through a given point in the first principal focal plane of the anterior system of lenses traverse the plate as a parallel beam and re-ignite at the corresponding point of the second focal plane of the posterior system, each in its passage being divided into two by the plate having a given relative retardation. It is on this latter plane that the eyepiece must be focussed, and here the measuring web must be placed. The actual details of the systems of lenses depend upon the object for which the polariscopes is intended, and are given for some of the principal types of instruments in Th. Liebisch's *Physikalische Kristallographie*.

Of polarimeters for the study of rotary polarization there are three principal forms. In Wild's polaristrometer, light from a soda flame, rendered parallel by a lens, is polarized by a Nicol's prism, and after traversing the space into which the active substance is to be inserted, falls on a Savart's plate placed in front of an astronomical telescope of low power, that contains in its eyepiece a Nicol's prism, which with the plate forms a Savart's analyser. A web in the focal plane of telescope marks the point in the field at which the bands are to be made to disappear, this is effected by turning the polarizer by means of a rack and pinion worked by an arm from the observer's end of the instrument. The polarizing prism is fixed at the centre of a circular disk, that has a scale on its circumference, which with a fixed vernier determines the positions of the polarizer, for which the bands disappear at the assigned point of the field. Laurent's polarimeter is a half-shade instrument. Soda light, first sifted by passage through a plate of potassium bichromate, traverses in succession a lens, a Nicol's prism, and a glass plate half covered with a half-wave plate of quartz, that is cut parallel to the optic axis and has its principal section inclined at a small angle to that of the prism. This combination forms a half-shade polarizer, the sensitiveness of which can be varied by a slight adjustment that can be given to the Nicol. The light is finally received in a Galilean telescope, containing an analyser and carried at the centre of a circular plate, that is graduated on its rim and can be turned in front of a vernier by means of a rack and pinion. The telescope must be focussed on the edge of the quartz plate, and in order that all points of the field may be illuminated by the same part of the source, the flame must be so placed that its image is thrown by the lens on the diaphragm of the object glass of the telescope. The chief features of Soleil's saccharimeter are the biquartz and the compensator. The former consists of two semicircular plates of quartz, perpendicular to the optic axis and of opposite rotations,

placed so as to have a common diameter and having such a thickness that each rotates the plane of polarization of mean yellow light through the same multiple of 90° . If then a stream of polarized white light traverse the biquartz, it is possible by an analyser to cut off the mean yellow light from each half of the field, and the whole will then have the sensitive tint, but a small change in the plane of analysis will give the one half a red and the other half a blue tone. A rotation of the plane of polarization is not, however, measured by an adjustment of the analyser, but by annulling the rotation with a compensator. This is made of two plates of quartz, cut normally to the optic axis and of opposite rotations, placed the one in front of the other; the thickness of the one plate is fixed, while that of the other can be varied, as it is formed of two equal prisms that can be moved over one another along their common face. When the plates are of equal thickness, their combined effect is nil, but by adjusting the second, a rotation in the one or the other direction may be introduced, a scale attached to one prism and a vernier to the other giving the thickness of the resultant quartz plate. At one end of the instrument is placed a polarizer and the biquartz, and at the other a Galilean telescope, that must be focussed on the edge of biquartz, having in front of its object-glass the compensator and an analyser that is regulated for producing the sensitive tint, when the plates of the compensator have the same thickness. The sensitiveness of the instrument depends upon the exactness of the sensitive tint, when the colour of the two halves of the field are the same, and this is liable to be upset by absorption in the substance under investigation. In order to correct this, the light after analysis is passed through another plate of quartz and then the sensitive tint may be more or less restored by cutting off some colour, the same for the whole field, by a Nicol's prism placed in the eyepiece of the telescope. Soleil's saccharimeter, as its name implies, is designed for the study of solutions of sugar, and it is clear that it will only work satisfactorily with active media that have nearly the same rotary dispersion as quartz.

BIBLIOGRAPHY—A bibliography of the subjects treated in this article will be found at the end of the corresponding chapters of E. Verdet's *Leçons d'optique physique* (1869); this work has been brought to a later date in the German translation by Karl Exner (Braunschweig, 1861); references to later papers will be found in J. Walker's *The Analytical Theory of Light* (1904). In addition to the above the reader may consult for the general subject of polarization the following treatises: Th. Preston (3rd. ed. by C. J. Joly), *The Theory of Light* (1901), A. Schuster, *An Introduction to the Theory of Optics* (1904); R. W. Wood, *Physical Optics* (1905); E. Mascart, *Traité d'optique* (1889); and for the phenomena exhibited by crystals F. Pockel, *Lehrbuch der Kristallographie* (1906); Th. Liebisch, *Physikalische Kristallographie* (1891). (J. WAL.)

POLAR REGIONS, a general term for the regions about the North or South Pole, otherwise called the Arctic or Antarctic regions. The ancients had no actual knowledge of the history of the Polar regions. They had probably heard rumours of the light summer nights and the dark winter nights in the north, as is shown by Homer's description of the Laestrygonians having the short nights and the Cimærians living in perpetual darkness. By astronomical speculations the Greeks had come to the conclusion that north of the Arctic Circle there must be midnight sun at midsummer and no sun at midwinter. The general view was that the Polar regions, north and south, belonged to the uninhabitable frozen zones; while according to a less scientific notion there was a happy region north of the north wind (Boreas), where the sun was always shining and the Hyperboreans led a peaceful life. The first traveller of history who probably approached the Arctic Circle and reached the land of the midnight sun was the Greek Pytheas (q.v.), from Massalia (Marseilles), who about 325 B.C. made a voyage of discovery northwards along the west coast of Europe, which is one of the most remarkable in history. He visited England, Scotland, the Scottish Isles, and probably also northern Norway, which he called Thule. He moved the limits of the known world from the south coast of England northward to the Arctic Circle. It seems probable that he made two or perhaps several voyages. He also discovered the northern coasts of Germany as far east as Jutland.

We hear of no other voyages towards the Arctic regions before the Irish monk Dicuil, writing about 825, mentions the discovery by Irish monks of a group of small islands (the Irish Faeroes), and a greater island (Iceland), which he calls Thule, where there was hardly any night at midsummer. It is possible that Iceland and the Faeroes were inhabited by a small Celtic population before the Irish monks

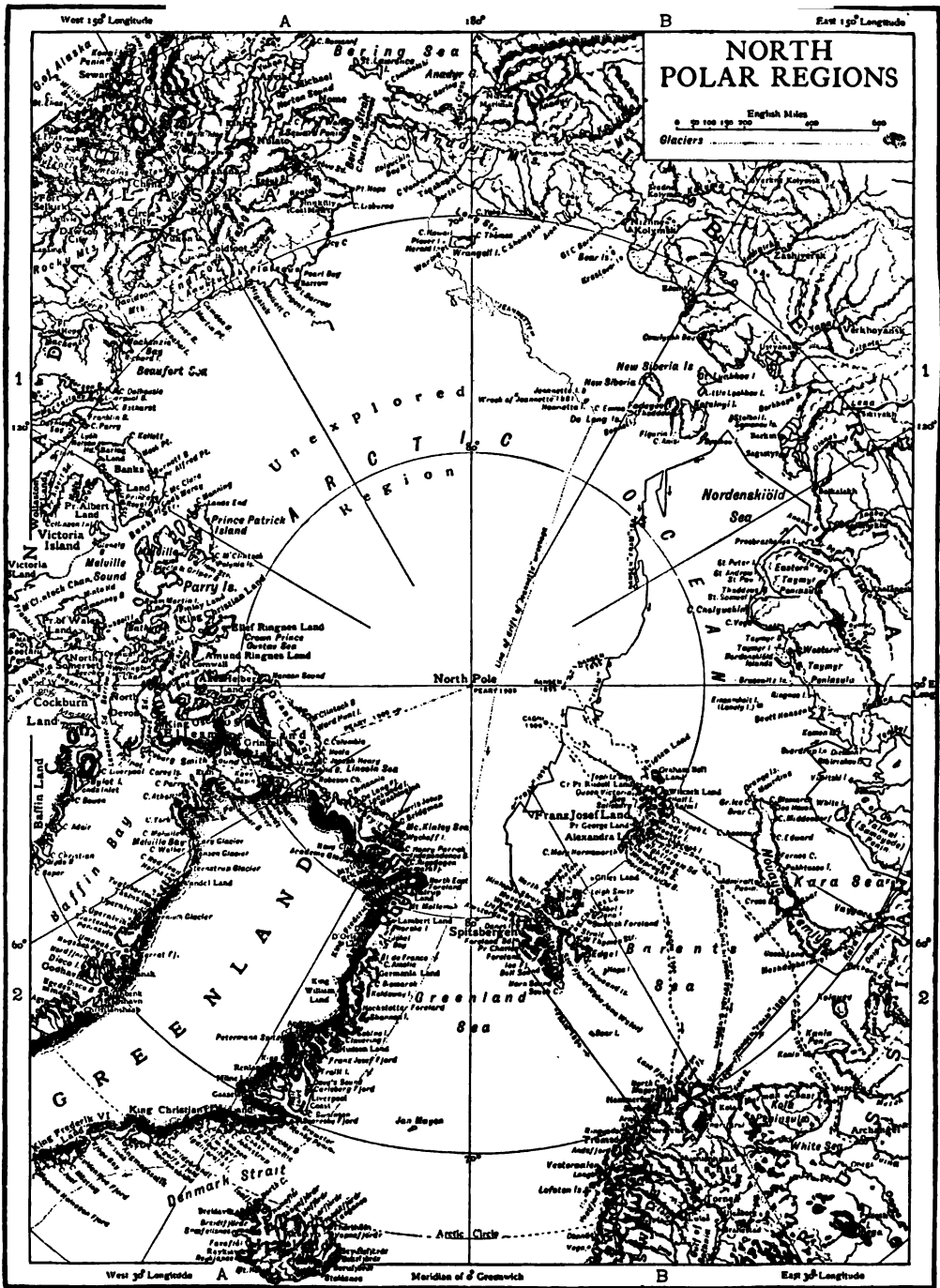

NORTH POLAR REGIONS

English Miles
 0 50 100 150 200 250 300
 Glaciers

Unexplored
 ARCTIC
 REGION

North Pole

GREENLAND

FRANZ JOSEF LAND

ARCTIC OCEAN

DENMARK STRAIT

Meridian of Greenwich

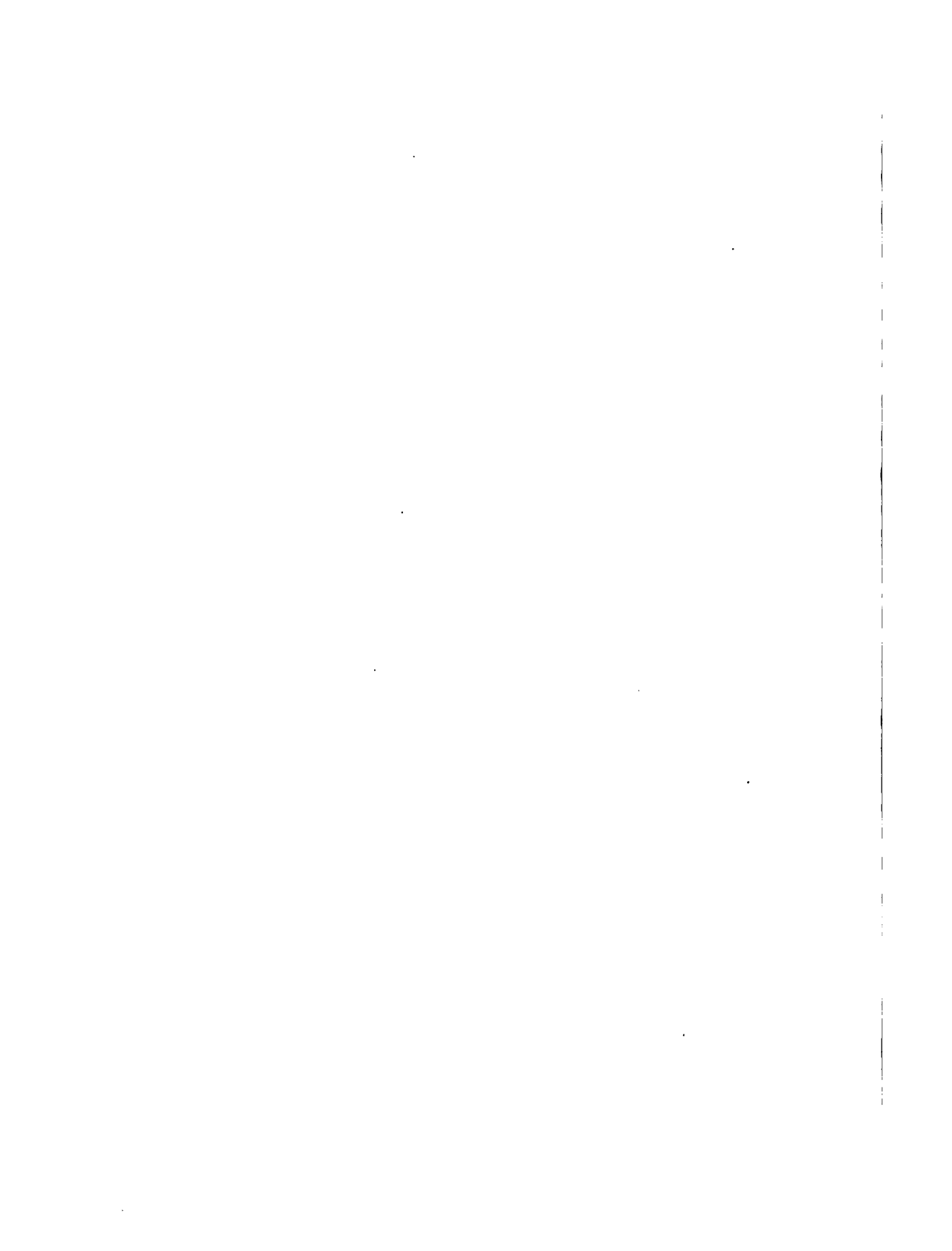

came thither. The fact that Irish monks lived in Iceland before the Norsemen settled there in the end of the 9th century is verified by the Icelandic sagas.

In his translation of Orosius, King Alfred inserts the interesting story of the first known really Arctic voyage, told him by the Norwegian Ottar (Alfred calls him Oththere), who about 870 rounded the North Cape, sailed eastwards along the Murman coast and discovered the White Sea, where he reached the south coast of the Kola Peninsula and the boundary of the land of the Biarmians (Boormas). Ottar told King Alfred that "he chiefly went thither, in addition to the seeing of the country, on account of the walruses."

After Ottar's time the king of Norway took possession of all land as far east as the White Sea and the land of the Biarmians, and the native "Finns" had to pay him tribute. Many voyages, mostly of hostile nature but also for trade purposes, were undertaken from Norway to the White Sea, and even kings went as far. It is told of King Eric, called Bloodaxe, who died as king of York in England, that he made such a voyage, and fought with the Biarmians, about 920, and about 965, his son Harold Graafeld defeated the Biarmians, and killed many people in a great battle near the river Dvina, where Archangel was built later.

After having settled in Iceland in the end of the 9th century, the Norsemen soon discovered Greenland and settled there. The first who is reported to have seen the coast of Greenland was a Norwegian, Gunnbjörn Ulfsson, who on his way to Iceland was storm-driven westwards. He came to some islands, afterwards called Gunnbjörnslíer, and saw a coast, but, without exploring the new land, he had evidently continued his way till he reached Iceland. The real discoverer and explorer of Greenland was the Norwegian, Eric the Red, who, with his father had settled in Iceland. As he and his men had there been declared outlaws for having killed several people they had to leave Iceland for three years, and he went westward to find the land which Gunnbjörn was reported to have seen. He explored the west coast of Greenland for three years, probably about 982-985. He then returned to Iceland, but founded the following year a colony in Greenland (977). Many colonists followed, and two Norse settlements were formed, viz. the *Eystrabýgd* (i.e. eastern settlement) on the south-eastern part of the Greenland west coast, between Cape Farewell and about 61° N lat., where Eric the Red had his house, Brattahlíð, at the Eiríkssjór, and the *Vestrabýgd* (i.e. western settlement) in the region of the present Godthaab district, between 63° and 66° N lat. The Norse settlers carried on their seal and whale-hunting still farther north along the west coast beyond the Arctic circle, and probably in the region of Disco Bay. A runic stone was found in a cairn on a small island in 72° 55' N lat. north of Upernivik, showing that Norsemen had been there. The stone probably dates from the 14th century. About 1267 an expedition was sent northwards along the west coast and may possibly have reached some distance north of Upernivik.

The last known communication between the Norse settlements in Greenland and Norway was in 1410, when some Icelanders returned, who four years previously had been storm-driven to Greenland. After that time we possess no reliable information about the fate of these settlements. When Greenland was rediscovered in the 16th century no descendants of the Norse settlers were found. The probability is that having gradually been cut off from all communications with Europe, the remaining settlers who had not returned to the motherland were obliged to adopt the Eskimó mode of life, which in those surroundings was far superior to the European, and by intermarriage they would then soon be absorbed amongst the more numerous natives. There is evidence to show that an expedition was probably sent from Denmark or Norway to Greenland in the latter part of the 15th century (perhaps about 1476) under Pining and Pothorn (by Purchas called "Punnus and Pothorne"), and perhaps with Johan Scolvus as pilot. It is probable that this expedition had intercourse with the natives of Greenland, and possibly even reached

Pining and Scolvus.

Labrador, but it is unknown whether any remains of the Norse settlements were found on the Greenland west coast.

It is reported by Adam of Bremen (about 1070) that the Norwegian king Harold Haardraade (in the 11th century) made an expedition into the Arctic Sea (probably northwards) in order to examine how far it extended, but we know nothing more about this voyage.

The Icelandic annals report that a land called *Svalbardi* was discovered in 1194. The name means the cold side or coast. The land was, according to the sagas, situated four days' sailing from north-eastern Iceland northwards in the *Hafsbjörn* (i.e. the northern termination of the sea, which was supposed to end as a bay). There can be no doubt that this land was Spitsbergen. The Norsemen carried on seal, walrus and whale hunting, and it is believed on good ground that they extended their hunting expeditions eastwards as far as Novaya Zemlya and northwards to Spitsbergen.

On his way to Greenland from Norway in the year 1000 Leif Ericsson found America, probably Nova Scotia, which he called Wineland the Good. A few years later Thorfinn Karlsefni sailed from Greenland with three ships to make a settlement in the land discovered by Leif. They first came to Labrador, which they called *Helthland*, then to Newfoundland, which was called *Markland* (i.e. woodland), and then to Cape Breton and Nova Scotia (*Vinland*, Wineland). After three years they had to give up the undertaking on account of hostilities with the natives, probably Red Indians, and they returned to Greenland about 1006. We know of no later expedition of the Norsemen that reached Greenland, it is stated that Eric Uppri, the first bishop of Greenland, went in 1121 to seek Vinland, but it is not related whether he ever reached it, and the probability is that he never returned.

The Icelandic annals state that in 1347 a small Greenland ship which had sailed to Markland (Newfoundland) was afterwards storm-driven to Iceland with seventeen men. This is the last known voyage made by the Norsemen of Greenland which with certainty reached America.

The discoveries of the old Norsemen extended over the northern seas from Novaya Zemlya in the east to Labrador, Newfoundland, and Nova Scotia in the west, they had visited all Arctic lands in these regions, and had explored the White Sea, the Barents Sea, the Spitsbergen and Greenland Sea, Davis Strait, and even some part of Baffin Bay. They were the first navigators in history who willingly left the coasts and sailed across the open ocean, and they crossed the Atlantic between Norway and America, thereby being the real discoverers of this ocean, as well as the pioneers in oceanic navigation. They were the teachers of the navigators of later centuries, and it is hardly an accident that the undertakings of England towards the west started from Bristol, where many Norwegians had settled, and which from the beginning of the 15th century had much trade with Iceland.

John Cabot, sent out by the merchants of Bristol, rediscovered the American continent in 1497. He came to Cape Breton and Nova Scotia, probably the same land where Leif Ericsson had landed 500 years before. John Cabot started on a new expedition towards the west in 1498, but no more is known of this expedition, not even whether Cabot returned or not. There is no reliable evidence to prove that John Cabot or his son Sebastian ever discovered Labrador, as has been generally believed.

The Portuguese Gaspar Corte-Real rediscovered Greenland in 1500. He sailed along its east coast without being able to land on account of the ice. Whether he visited the west coast is uncertain. In 1501 he made a new expedition when he also rediscovered Newfoundland. One of his ships returned home to Lisbon, but he himself and his ship disappeared. His brother went in search of him the following year, but was heard of no more.

Cabot's and Corte-Real's discoveries were followed by the development of the Newfoundland and Labrador fisheries,

and a whole fleet of English, Portuguese, Basque and Breton fishermen was soon met with in these waters, and they probably went along the Labrador coast northward as far as Hudson Strait, without having left any report of their discoveries.

It is believed, on good grounds, that expeditions (combined English-Portuguese) were sent out to the newly discovered regions from Bristol in 1501 and 1502. It is unknown what their discoveries were, but they may possibly have sailed along the coast of Labrador.

It is possible that John Cabot's son, Sebastian Cabot, made an Arctic expedition in 1508-1509, in search of a short passage to China towards the north-west, and later, in 1521, King Henry VIII. made an attempt to persuade the merchants of London to support him in sending out an expedition, under Sebastian Cabot, to the north-western countries. It is uncertain whether it ever started, but it is certain that it achieved nothing of importance.

John Rut sailed from Plymouth in 1577, in order to seek a passage to China through the Arctic seas towards the north-west, following the suggestion of Robert Thorne of Bristol. He met ice in 53° N. lat and returned to Newfoundland. Several other expeditions were sent out from various countries towards the north-west and west during this period, but no discoveries of importance are known to have been made in the Arctic regions.

There are rumours that the Portuguese, as early as 1484, under King John II, had sent out an expedition towards Novaya Zemlya in search of a north-east passage to India.

The Genovese Paolo Centurione probably proposed to King Henry VIII of England, in 1525, to make an expedition in search of such a passage to India north of Russia, and there is evidence to show that there had been much talk about an undertaking of this kind in England and at the English court during the following period, as it was hoped that a new market might be found for English merchandise, especially cloth. But it led to nothing until 1553, when Sebastian Cabot was one of the chief promoters. Three ships and 112 men under Sir

Hugh Willoughby sailed from Ratcliffe on the 10th (20th) May 1553. Richard Chancellor commanded one of the ships, which was separated from the two others in a gale off northern Norway on the 3rd (13th) August. Willoughby, after having sighted land in various places, probably Kolguev Island, where they landed, the coast near the Pechora river and Kanin Nos, came on the 14th (24th) September to a good harbour on the northern coast of the Kola Peninsula. His one ship being leaky, Willoughby resolved to winter there, but he and all his men perished.

Chancellor, after his separation from the two other ships, rounded the North Cape, to which he or his sailing-master, Stephen Borough, gave this name. He reached Vardöhus, and after having waited there in vain for Willoughby, he followed the route of the Norsemen to the White Sea and reached the bay of St Nicholas, with a monastery of this name, near the mouth of the Dvina river, where Archangel was built later. Chancellor undertook a journey to Moscow, made arrangements for commercial intercourse with Russia, and returned next year with his ship, which was, however, plundered by the Flemings, but he reached London safely with a letter from the tsar. In spite of the disaster of Willoughby and his men this expedition became of fundamental importance for the development of English trade. Chancellor's success and his so-called discovery of the passage to the White Sea, which was well known to the Norwegian traders in that region, proved to people in England the practical utility of polar voyages. It led to a charter being granted to the Association of Merchant Adventurers, also called the Muscovy or Russia Company, and gave a fresh impulse to Arctic discovery. Chancellor undertook a new expedition to the White Sea and Moscow in 1555, on his way home in the following year he was wrecked on the coast of Scotland and perished.

In 1556 Stephen Borough (Burrough), who had served with Chancellor was sent out by the Muscovy Company in a small pinnace called the "Search-thrift," in order to try to reach the

river Ob, of which rumours had been heard. Novaya Zemlya, Vaigach Island, and the Kara Strait leading into the Kara Sea, were discovered. Borough kept a careful journal of his voyage. In 1580 the company fitted out two vessels under Arthur Pet and Charles Jackman, with orders to sail eastwards north of Russia and Asia to the lands of the emperor of Cathay (China). They penetrated through the Kara Strait into the Kara Sea; they possibly saw the west coast of Yalmal, but met with much ice and were compelled to return. The two ships were separated on the way home, Pet reached London on December 26th in safety, Jackman wintered with his ship in Norway and sailed thence in February, but was never heard of again.

About 1574 the Portuguese probably made an attempt to find the north-west passage under Vasquesques Corte-Real. They reached "a great entrance," which may have been Hudson Strait, and they "passed above twelve leagues" into it, "without all impediment of ice," "but their victuals fayling them, . . . they returned backe agayne with loy."

After the expeditions in search of the north-east passage achieved the success of opening up a profitable trade with Russia, via the White Sea, new life was inspired in the undertakings of England on the sea, at the same time the power of the Hanseatic merchants, called the Easterlings, was much reduced. It was therefore only natural that the plan of seeking a north-west passage to China and India should again come to the front in England, and it was much discussed. It was Sir Martin Frobisher who opened that long series of expeditions all of which during three hundred years

were sent from England in search of the north-west passage until the last expedition, which actually accomplished it, sailed from Norway. "Being persuaded of a new and neerer passage to Cataya" (China) towards the north-west, Frobisher "determined and resolved wyth himselfe, to go make full prooffe thereof . . . or else never to retourne againe, knowing this to be the onely thing of the worlde that was left yet undone, whereby a notable mind mighte be made famous and fortunate." After having attempted in vain for fifteen years to find support for his enterprise, he at last obtained assistance from Ambrose Dudley, earl of Warwick, and through him the interest of Queen Elizabeth was also secured. The Muscovy Company was now obliged to give a licence for the voyage in 1574, and the necessary money was found by London merchants. Aided especially by Michael Lok, an influential merchant and diligent student of geography, Frobisher sailed, on the 7th (17th) of June 1576, from Deptford with two small vessels of 20 and 25 tons, called the "Gabriel" and "Michael," and a small pinnace of 10 tons; the crews amounted to 35 men all told. On the 8th (18th) of July they lost sight of the pinnace, which was seen no more. On the 11th (21st) of July they sighted a high, rugged land, but could not approach it for ice. This was the east coast of Greenland, but, misled by his charts, Frobisher assumed it to be the fictitious Frisland, which was the fabrication of a Venetian, Nicolo Zeno, who in 1558 published a spurious narrative and map (which he pretended to have found) as the work of an ancestor and his brother in the 14th century. The Zeno map was chiefly fabricated on the basis of a map by the Swede Olaus Magnus of 1537 and the map by the Dane Claudius Clavus of the 15th century. It was accepted at the time as a work of high authority, and its fictitious names and islands continued to appear on subsequent maps for at least a century, and have puzzled both geographers at home and explorers in the field. These islands had also been introduced on the charts of Mercator of 1569 and of Ortelius of 1570 which were probably used by Frobisher. Evidently frightened by the sight of the great quantities of ice off the Greenland coast, one ship, the "Michael," left him secretly, "and returned home wyth greate reporte that he was cast away." The gallant Frobisher continued his voyage towards the north-west in the "Gabriel" alone, although his mast was sprung, his topmast blown overboard, and his "mizen-mast" had had to be cut away in a gale. On the 29th of July (Aug. 8) he sighted high

land which he called Queen Elizabeth's Foreland. This was the southern part of Baffin Land (Resolution Island) in about 62° N. lat. He was stopped by ice, but nearly two weeks later he reached the coast and entered an inlet which he considered to be the strait of the north-west passage, and he gave it his own name (it is now Frobisher Bay on Baffin Land). The land was called "Meta Incognita." Frobisher was not well prepared for going much farther, and after his boat with five men had disappeared he returned home, where, unfortunately, some "gold-finders" in London took it into their heads that a piece of dark heavy stone brought back contained gold ore. This caused great excitement; it was now considered much more important to collect this precious ore than to find the north-west passage, and much larger expeditions were sent out in the two following years. As many as fifteen vessels formed the third expedition of 1578, and it was the intention to form a colony with a hundred men in the gold land, but this scheme was given up. Frobisher came into Hudson Strait, which was at first thought to be Frobisher Strait and therefore called Mistaken Strait. There was an open sea without any land or ice towards the west, and Frobisher was certain that he could sail through to the "Mare del Sur" (Pacific Ocean) and "Kathaya," but his first goal was the "gold mines," and the vessels returned home with full loads of the ore. One of them, a buss (small ship) of Bridgewater, called the "Emmanuel," reported that on her voyage home she had first sighted Frisland on the 8th (18th) of September, but four days later she had sighted another land in the Atlantic and sailed along it till the following day; they reckoned its southern end to be in about 57½° N. lat. This land soon found its place on maps and charts south-west of Iceland under the name of Buss Island, and as it was never seen again it was after 1745 called "the sunken land of Buss." The explanation is that, misled by the maps, Frobisher assumed Greenland to be Frisland of the Zeno map and Baffin Land was afterwards assumed to be the east coast of Greenland. When the buss on her way home sighted Greenland in about 62° N., she therefore thought it to be Frisland, but when she four days later again sighted land near Cape Farewell and her dead reckoning probably had carried her about two degrees too far south, she naturally considered this to be a new land, which puzzled geographers and navigators for centuries. Owing to a similar mistake, not by Frobisher, but by later cartographers and especially by Davis, it was afterwards assumed that Frobisher Strait (and also Mistaken Strait) was not in Baffin Land but on the east coast of Greenland, where they remained on the maps till the 18th century.

John Davis, who made the next attempt to discover a north-west passage, was one of the most scientific seamen of that age.

He made three voyages in three successive years aided and fitted out by William Sanderson and other merchants. Sailing from Dartmouth on the 7th (17th) of June 1585, with two ships, he sighted on the 20th (30th) of July "the most deformed, rocky and mountainous land, that ever we sawe." He named it the Land of Desolation, although he understood that he had rediscovered "the shore which in ancient time was called Greenland." It was its east coast. He visited the west coast, where Frobisher had also landed mistaking it for Frisland. Davis anchored in a place called Gilbert's Sound in 64° 10' (near the present Danish settlement of Godthaab) and had much intercourse with the Eskimo. He then, crossing the strait which bears his name, traced a portion of its western shore southwards from about 66° 40' N. lat. and came into Cumberland Sound, which he thought to be the strait of the north-west passage, but returned home on account of contrary winds. In the second voyage (with four ships) Davis traced the western shore of Davis Strait still farther southwards, and sailed along the coast of Labrador. In the third voyage (with three ships) in 1587 he advanced far up his own strait along the west coast of Greenland in a small leaky pinnace, the "Ellin," and reached a lofty granite island in 72° 41' N. lat., which he named Hope Sanderson. He met with ice in the sea west of this place, but

reported that there was not "any yce towards the north, but a great sea, free, large, very salt and blew, and of an unsearchable depth." By contrary winds, however, he was prevented from sailing in that direction. He sailed into Cumberland Sound, but now found that there was no passage. He also passed on his way southwards the entrance to Frobisher Strait, which he named Lunley Inlet, and Hudson Strait, without understanding the importance of the latter. When Davis came to Labrador, where his two larger ships were to have waited for him, they had sailed to England. The little "Ellin" now struck a sunken rock and sprung a leak, which was repaired, and he crossed the Atlantic in this small leaky craft. He still believed in the existence of a passage through Davis Strait, but could find no support for another Arctic voyage. Davis was not the first to discover this strait; it was well-known to the Norsemen. Gaspar Corte-Real had possibly also been there, and Frobisher had during his voyages crossed its southern part every year. The result of Davis's discoveries are shown on the Molyneux globe, which is now in the library of the Middle Temple; they are also shown on the "New Map" in Hakluyt's *Principal Navigations* (1598-1600). When Davis was trying to reconcile his discoveries with the previous ones, especially those of Frobisher, he made fatal mistakes as mentioned above.

As early as 1565, by the intervention of a certain Philip Winterkönig, an exile from Vardöhus in Norway, Dutch merchants formed a settlement in Kola, and in 1578 ^{Brunel} two Dutch ships anchored in the mouth of the river Dvina, and a Dutch settlement was established where Archangel was built a few years later. The leading man in these undertakings was Olivier Brunel, who is thus the founder of the White Sea trade of the Dutch; he was also their first Arctic navigator. He had travelled both overland and along the coast to Siberia and reached the river Ob; he had also visited Kostin Shar on Novaya Zemlya. He propounded plans for the discovery of the north-east passage to China, and in 1581 he went from Russia to Antwerp to prepare an expedition. He probably started with one ship in 1582, on the first Arctic expedition which left the Netherlands. Little is known of its fate except that it ended unsuccessfully with the wreck of the ship in the shallow Pechora Bay, possibly after a vain attempt to penetrate through the Yugor Strait into the Kara Sea. In 1583 we find Olivier Brunel in Bergen trying to organize a Norwegian undertaking, evidently towards the north-east, but it is uncertain whether it led to anything.

The Dutch, however, had begun to see the importance of a northern route to China and India, especially as the routes through the southern seas were jealously guarded by the Spaniards and Portuguese, and after 1584 all trade with Portugal, where the Dutch got Indian goods, was forbidden. By Brunel's efforts their attention had been directed towards the north-east passage, but it was not until 1594 that a new expedition was sent out, one of the promoters being Peter Plancius, the learned cosmographer of Amsterdam. Four ships sailed from Huysdunen on the 5th (15th) of June 1594. Two of these ships from Amsterdam were under the command of Willem Barents, who sighted Novaya Zemlya, north of ^{Barents and Nay} Matochkin Shar, on the 4th (14th) of July; and from that date until the 1st (11th) of August Barents continued perseveringly to seek a way through the ice-floes, and discovered the whole western coast as far as the Great Ice Cape, the latitude of which he, with his admirable accuracy, determined to be 77° N. Having reached the Orange Islands at the north-west extremity, he decided to return. The two other ships under the command of Cornelis Nay had discovered the Yugor Strait, through which they sailed into the Kara Sea on the 1st (11th) of August. They reached the west coast of Valmal; being sure that they had passed the mouth of the river Ob, and finding the sea open, they thought they had found a free passage to Japan and China, and returned home on the 11th (21st) of August. A new expedition was made the following year, 1595, with seven ships under the command of Cornelis Nay, as admiral, and Willem Barents as

chief pilot, but it merely made several unsuccessful attempts to enter the Kara Sea through the Yugor Strait. The third expedition was more important. Two vessels sailed from Amsterdam on the 10th (20th) of May 1596, under the command of Jacob van Heemskerck and Corneliszoon Rijp. Barents accompanied Heemskerck as pilot, and Gerrit de Veer, the historian of the voyage, was on board as mate. The masses of ice in the straits leading to the Sea of Kara, and the impenetrable nature of the pack near Novaya Zemlya, had suggested the advisability of avoiding the land and, by keeping a northerly course, of seeking a passage in the open sea. They sailed northwards, and on the 9th (19th) of June discovered Bear Island. Continuing on the same course they sighted a mountainous snow-covered land in about 80° N. lat., soon afterwards being stopped by the polar pack ice. This important discovery was named Spitsbergen, and was believed to be a part of Greenland. Arriving at Bear Island again on the 1st of July, Rijp parted company, while Heemskerck and Barents proceeded eastward, intending to pass round the northern extreme of Novaya Zemlya. On the 26th of August (Sept. 5) they reached Ice Haven, after rounding the northern extremity of the land. Here they wintered in a house built out of driftwood and planks from the 'tween decks and the deck-house of the vessel. In the spring they made their way in boats to the Lapland coast; but Barents died during the voyage. This was the first time that an arctic winter was successfully faced. The voyages of Barents stand in the first rank among the polar enterprises of the 16th century. They led to flourishing whale and seal fisheries which long enriched the Netherlands.

The English enterprises were continued by the Muscovy Company, and by associations of patriotic merchants of London; and even the East India Company sent an expedition *Waymouth* under Captain Waymouth in 1602 to seek for a passage by the opening seen by Davis, but it had no success.

The best servant of the Muscovy Company in the work of polar discovery was Henry Hudson. His first voyage was undertaken in 1607, when he discovered the most *Hudson* northern known point of the east coast of Greenland

in 73° N. named "Hold with Hope," and examined the ice between Greenland and Spitsbergen, probably reaching Hakluyt's Headland in 79° 50' N. On his way home he discovered the island now called Jan Mayen, which he named "Hudson's Tutches." In his second expedition, during the season of 1608, Hudson examined the edge of the ice between Spitsbergen and Novaya Zemlya. In his third voyage he was employed by the Dutch East India Company; he again approached Novaya Zemlya, but was compelled to return westwards, and he explored the coasts of North America, discovering the Hudson river. In 1610 he entered Hudson Strait, and discovered the great bay which bears and immortalizes his name. He was obliged to winter there, undergoing no small hardships. On his way home his crew mutinied and set him, his little son and some sick men adrift in a boat, and the explorer perished in the seas he had opened up.

The voyages of Hudson led immediately to the Spitsbergen whale fishery. From 1609 to 1612 Jonas Poole made four *Spitsbergen* voyages for the prosecution of this lucrative business, and he was followed by Fotherby, Baffin, Joseph *White* and Edge. These bold seamen, while in the pursuit *White* of whales, added considerably to the knowledge of the archipelago of islands known under the name of Spitsbergen, and in 1617 Captain Edge discovered an island to the eastward, which he named Wyche's Land.

About the same period the kings of Denmark began to send expeditions for the rediscovery of the lost Greenland colony. In 1605 Christian IV. sent out three ships, *Danish* under the Englishmen Cunningham and Hall and *Voyages* a Dane named Lindenov, which reached the western coast of Greenland and had much intercourse with the Eskimo. Other expeditions followed in 1606-1607.

Meanwhile, the merchant adventurers of London continued

to push forward the western discovery. Sir Thomas Button, in command of two ships, the "Resolution" and "Discovery," sailed from England in May 1612. He entered *Button* Hudson Bay, crossed to its western shore, and wintered at the mouth of a river in 57° 10' N. which was named Nelson river after the master of the ship, who died and was buried there. Next year Button explored the shore of Southampton Island as far as 65° N., and returned home in the autumn of 1613. An expedition under Captain Gibbons despatched in 1614 to Hudson Bay was a failure; but in 1615 Robert Bylot as master and William Baffin as pilot and navigator in the "Discovery" examined the coasts of Hudson Strait and to the north of Hudson Bay, and Baffin, who was the equal of Davis as a scientific seaman, made many valuable observa- *Baffin* tions. In 1616 Bylot and Baffin again set out in the "Discovery." Sailing up Davis Strait they passed that navigator's farthest point at Sanderson's Hope, and sailed round the great channel with smaller channels leading from it which has been known ever since as Baffin Bay. Baffin named the most northern opening Smith Sound, after the first governor of the East India Company, and the munificent promoter of the voyage, Sir Thomas Smith. Lancaster Sound and Jones Sound were named after other promoters and friends of the voyage. The fame of Baffin mainly rests upon the discovery of a great channel extending north from Davis Strait; but it was unjustly dimmed for many years, owing to the omission of Purchas to publish the navigator's tabulated journal and map in his great collection of voyages. It was two hundred years before a new expedition sailed north through Baffin Bay. It may be mentioned, as an illustration of the value of these early voyages to modern science, that Professor Hansteen of Christiania made use of Baffin's magnetic observations in the compilation of his series of magnetic maps. In 1619 Denmark sent out an expedition, under the command of Jens Munk, in search of the north-west passage, with two ships and 64 men. They reached the west coast of Hudson Bay, where they wintered near Churchill river, but all died with the exception of one man, a boy, and Munk himself, who managed to sail home in the smallest ship.

In 1631 two expeditions were despatched, one by the merchants of London, the other by those of Bristol. In the London ship "Charles" Luke Fox explored the western *Luke Fox;* side of Hudson Bay as far as the place called "Sir *James* Thomas Roe's Welcome." In August he encountered Captain James and the Bristol ship "Maria" in the middle of Hudson Bay, and went north until he reached "North-west Fox his farthest," in 66° 47' N. He then returned home and wrote an entertaining narrative. Captain James had to winter off Charlton Island, in James Bay, the southern extreme of Hudson Bay, and did not return until October 1632. Another English voyager, Captain Wood, attempted, without success, to discover a north-east passage in 1676 through the sea round the North Pole, but was wrecked on the coast of Novaya Zemlya.

The 16th and 17th centuries were the period of discovery and daring enterprise. Hudson Strait and Bay, Davis Strait and Baffin Bay, the icy seas from Greenland to Spitsbergen and from Spitsbergen to Novaya Zemlya had all been explored; but much more was not discovered than had been well known to the Norsemen five or six centuries earlier. The following century was rather a period of reaping the results of former efforts than of discovery. It saw the settlement of the Hudson Bay Territory and of Greenland, and the development of the whale and seal fisheries.

The Hudson's Bay Company was incorporated in 1670, and Prince Rupert sent out Zachariah Gillan, who wintered at Rupert river. At first very slow progress was made. A voyage undertaken by Mr Knight, nearly 80 years old, who had been appointed governor of the factory at Nelson river, was unfortunate, as his two ships were lost and the crews *Scroggs* perished. This was in 1719. In 1722 John Scroggs was sent from Churchill river in search of the missing ships, but merely entered Sir Thomas Roe's Welcome and returned. His reports were believed to offer decisive proofs of the existence

of a passage into the Pacific; and a naval expedition was despatched under the command of Captain Christopher Middleton, consisting of the "Discovery" pink and the "Fur-nace" bomb. Wintering in Churchill river, Middleton started in July 1742 and discovered Wager river and Repulse Bay. In 1746 Captain W. Moor made another voyage in the same direction, and explored the Wager Inlet.

Later in the century the Hudson's Bay Company's servants made some important land journeys to discover the shores of the American polar ocean. From 1769 to 1772 Samuel Hearne descended the Coppermine River to the polar sea; and in 1789 Alexander Mackenzie discovered the mouth of the Mackenzie river. (For the establishment of the modern Danish settlements in Greenland, see GREENLAND.)

The countrymen of Barents vied with the countrymen of Hudson in the perilous calling which annually brought fleets of ships to the Spitsbergen seas during the 17th and 18th centuries. The Dutch had their large summer station for boiling down blubber at Smecrenberg, near the northern extreme of the west coast of Spitsbergen. Captain Vlamingh, in 1664, advanced as far round the northern end of Novaya Zemlya as the winter quarters of Barents. In 1700 Captain Cornelis Roule is said by Witsen to have sailed north in the longitude of Novaya Zemlya and to have seen an extent of 40 m. of broken land, but Theunis Ys, one of the most experienced Dutch navigators, believed that no vessel had ever been north of the 82nd parallel. In 1671 Frederick Martens, a German surgeon, visited Spitsbergen, and wrote the best account of its physical features and natural history that existed previous to the time of Scoresby. In 1707 Captain Cornelis Gilles went far to the eastward along the northern shores of Spitsbergen, and saw land to the east in 80° N., which has since been known as Gilles Land. The Dutch geographical knowledge of Spitsbergen was embodied in the famous chart of the Van Keulens (father and son), 1700-1728. The Dutch whale fishery continued to flourish until the French Revolution, and formed a splendid nursery for training the seamen of the Netherlands. From 1700 to 1775 the whaling fleet numbered 100 ships and upwards. In 1719 the Dutch opened a whale fishery in Davis Strait, and continued to frequent the west coast of Greenland for upwards of sixty years from that time.

The most flourishing period of the British fishery in the Spitsbergen and Greenland seas was from 1752 to 1820. Bounties of 40s. per ton were granted by act of parliament; and in 1778 as many as 255 sail of whalers were employed. In order to encourage discovery £5000 was offered in 1776 to the first ship that should sail beyond the 89th parallel (16 Geo. III. c. 6). Among the numerous daring and able whaling captains, William Scoresby takes the first rank, alike as a successful whaler and a scientific observer. His admirable *Account of the Arctic Regions* is still a textbook for all students of the subject. In 1806 he succeeded in advancing his ship "Resolution" as far north as 81° 12' 42". In 1822 he forced his way through the ice which encumbers the approach to land on the east coast of Greenland, and surveyed that coast from 75° down to 60° N., a distance of 400 m. Scoresby combined the closest attention to his business with much valuable scientific work and no insignificant amount of exploration.

The Russians, after the acquisition of Siberia, succeeded in gradually exploring the whole of the northern shores of that vast region. In 1648 a Cossack named Simon Dezhneff is said to have equipped a boat expedition in the river Kolyma, passed through the strait since named after Bering, and reached the Gulf of Anadyr. In 1738 a voyage was made by two Russian officers from Archangel to the mouths of the Ob and the Yenisei. Efforts were then made to effect a passage from the Yenisei to the Lena. In 1735 Lieut. T. Chelyuskin got as far as 77° 25' N. near the cape which bears his name; and in 1743 he rounded that most northern point of Siberia in sledges, in 77° 41' N. Captain

Vitus Bering, a Dane, was appointed by Peter the Great to command an expedition in 1725. Two vessels were built at Okhotsk, and in July 1728 Bering ascertained the existence of a strait between Asia and America.

In 1740 Bering was again employed. He sailed from Okhotsk in a vessel called the "St Paul," with G. W. Steller on board as naturalist. Their object was to discover the American side of the strait, and they sighted the magnificent peak named by Bering Mt. St. Elias. The Aleutian Islands were also explored, but the ship was wrecked on an island named after the ill-fated discoverer, and scurvy broke out amongst his crew. Bering himself died there on the 8th of December 1741.

Thirty years after the death of Bering a Russian merchant named Liakhoff discovered the New Siberia or Liakhoff Islands, and in 1771 he obtained the exclusive right from the empress Catherine to dig there for fossil ivory. These islands were more fully explored by an officer named Hedenström, and seekers for fossil ivory annually resorted to them. A Russian expedition under Captain Chitschakoff, sent to Spitsbergen in 1764, was only able to attain a latitude of 80° 30' N.

From 1773 onwards to the end of the 19th century the objects of polar exploration were mainly the acquisition of knowledge in various branches of science. It was on these grounds that Daines Barrington and the Royal Society induced the British government to undertake arctic exploration once more. The result was that two vessels, the "Racehorse" and "Carcass" bombs, were commissioned, under the command of Captain J. C. Phipps. The expedition sailed from the Nore on the 2nd of June 1773, and was stopped by the ice to the north of Hakluyt Headland, the north-western point of Spitsbergen. Phipps reached the Seven Islands and discovered Waldey Island; but beyond this point progress was impossible. When he attained their highest latitude in 80° 48' N., north of the central part of the Spitsbergen group, the ice at the edge of the pack was 24 ft. thick. Captain Phipps returned to England in September 1773. Five years afterwards James Cook received instructions to proceed northward from Kamchatka and search for a north-east or north-west passage from the Pacific to the Atlantic. In accordance with these orders Captain Cook, during his third voyage, reached Cape Prince of Wales, the western extremity of America, on the 9th of August 1778. His ships, the "Resolution" and "Discovery," arrived at the edge of the ice, after passing Bering Strait, in 70° 41' N. On the 17th of August the farthest point seen on the American side was named Icy Cape. On the Asiatic side Cook's survey extended to Cape North. In the following year Captain Clerke, who had succeeded to the command, made another voyage, but his ship was beset in the ice, and so much damaged that further attempts were abandoned.

The wars following the French Revolution put an end to voyages of discovery till, after the peace of 1815, north polar research found a powerful and indefatigable advocate in Sir John Barrow. Through his influence a measure for promoting polar discovery became law in 1818 (58 Geo. III. c. 20), by which a reward of £20,000 was offered for making the north-west passage, and of £5000 for reaching 80° N., while the commissioners of longitude were empowered to award proportionate sums to those who might achieve certain portions of such discoveries. In 1817 the icy seas were reported by Captain Scoresby and others to be remarkably open, and this circumstance enabled Barrow to obtain sanction for the despatch of two expeditions, each consisting of two whalers—one to attempt discoveries by way of Spitsbergen and the other by Ruffin Bay. The vessels for the Spitsbergen route, the "Dorothea" and "Trent," were commanded by Captain David Buchan and Lieut. John Franklin, and sailed in April 1818. Driven into the pack by a heavy swell from the south, both vessels were severely nipped, and had to return to England. The other expedition, consisting of the "Isabella" and "Alexander," commanded by Captain John Ross and Lieut.

Edward Parry, followed in the wake of Baffin's voyage of 1616. Ross sailed from England in April 1818. The chief merit of his voyage was that it vindicated Baffin's accuracy as a discoverer. Its practical result was that the way was shown to a lucrative fishery in the "North Water" of Baffin Bay, which continued to be frequented by a fleet of whalers every year. Captain Ross thought that the inlets reported by Baffin were merely bays, while the opinion of his second in command was that a wide opening to the westward existed through the Lancaster Sound of Baffin.

Parry was selected to command a new expedition in the following year. His two vessels, the "Hecla" and "Griper," passed through Lancaster Sound, the continuation of which was named Barrow Strait, and advanced westward, with an archipelago on the right, since known as the Parry Islands. He observed a wide opening to the north, which he named Wellington Channel, and sailed onwards for 300 m. to Melville Island. He was stopped by the impenetrable polar pack of vast thickness which surrounds the archipelago to the north of the American continent, and was obliged to winter in a harbour on the south coast of Melville Island. Parry's hygienic arrangements during the winter were judicious, and the scientific results of his expedition were valuable. The vessels returned in October 1820; and a fresh expedition in the "Fury" and "Hecla," again under the command of Captain Parry, sailed from the Nore on the 8th of May 1821, and passed their first winter on the coast of the newly discovered Melville Peninsula in 66° 11' N. Still persevering, Parry passed his second winter among the Eskimo at Igloodik in 69° 20' N., and discovered a channel leading westward from the head of Hudson Bay, which he named Fury and Hecla Strait. The expedition returned in the autumn of 1823. Meantime Parry's friend Franklin had been employed in attempts to reach by land the northern shores of America, hitherto only touched at two points by Hearne and Mackenzie. Franklin went out in 1810, with Dr John Richardson, George Back and Robert Hood. They landed at York factory, and proceeded to the Great Slave Lake. In August of the following year they started for the Coppermine river, and, embarking on it, reached its mouth on the 18th of July 1821. From that point 550 m. of coast-line were explored, the extreme point being called Cape Turnagain. Great sufferings, from starvation and cold, had to be endured during the return journey; but eventually Franklin, Richardson and Back arrived safely at Fort Chippewyan.

It was thought desirable that an attempt should be made to connect the Cape Turnagain of Franklin with the discoveries made by Parry during his second voyage; but the first effort, under Captain Lyon in the "Griper," was unsuccessful. In 1824 three combined attempts were organized. While Parry again entered by Lancaster Sound and pushed down a great opening he had seen to the south named Prince Regent Inlet, Captain Beechey was to enter Bering Strait, and Franklin was to make a second journey by land to the shores of Arctic America. Parry was unfortunate, but Beechey entered Bering Strait in the "Blossom" in August 1826, and extended our knowledge as far as Point Barrow in 71° 23' 30" N. lat. Franklin, in 1825-1826, descended the Mackenzie river to its mouth, and explored the coast for 374 m. to the westward; while Dr Richardson discovered the shore between the mouths of the Mackenzie and Coppermine, and sighted land to the northward, named by him Wollaston Land, the dividing channel being called Union and Dolphin Strait. They returned in the autumn of 1826.

Work was also being done in the Spitsbergen and Barents Seas. From 1821 to 1824 the Russian Captain Litke was surveying the west coast of Novaya Zemlya as far as Cape Nassau, and examining the ice of the adjacent sea. In May 1823 the "Griper" sailed, under the command of Captain Clavering, to convey Captain Sabine to the polar regions in order to make pendulum observations. Clavering pushed through the ice in 75° 30' N.,

and succeeded in reaching the east coast of Greenland, where observations were taken on Pendulum Island. He charted the coast-line from 76° to 72° N.

In Parry's attempt to reach the pole from the northern coast of Spitsbergen by means of sledge-boats (see PARRY), the highest latitude reached was 82° 45' N., and the attempt was persevered in until it was found that the ice as a whole was drifting to the south more rapidly than it was possible to travel over it to the north.

In 1829 the Danes undertook an interesting piece of exploration on the east coast of Greenland. Captain Graah of the Danish navy rounded Cape Farewell in boats, with four Europeans and twelve Eskimo. He advanced as far as 65° 18' N. on the east coast, where he was stopped by an insurmountable barrier of ice. He wintered in 63° 22' N., and returned to the settlements on the west side of Greenland in 1830.

In the year 1829 Captain John Ross, with his nephew James Clark Ross, having been furnished with funds by a wealthy distiller named Felix Booth, undertook a private expedition of discovery in a small vessel called the "Victory." Ross proceeded down Prince Regent Inlet to the Gulf of Boothia, and wintered on the eastern side of a land named by him Boothia Felix. In the course of exploring excursions during the summer months James Ross crossed the land and discovered the position of the north magnetic pole on the western side of it, on the 1st of June 1831. He also discovered a land to the westward of Boothia which he named King William Land, and the northern shore of which he examined. The most northern point was called Cape Felix, and thence the coast trended south-west to Victory Point. The Rosses could not get their little vessel out of its winter quarters. They passed three winters there, and then fell back on the stores at Fury Beach, where they passed their fourth winter, 1832-1833. Eventually they were picked up by a whaler in Barrow Strait, and brought home. Great anxiety was naturally felt at their prolonged absence, and in 1833 Sir George Back, with Dr Richard King as a companion, set out by land in search of the missing explorers. Wintering at the Great Slave Lake, they left Fort Reliance on the 7th of June 1834, and descended the Great Fish river for 530 m. The mouth was reached in 67° 11' N., and then the want of supplies obliged them to return. In 1836 Sir George Back was sent, at the suggestion of the Royal Geographical Society, to proceed to Repulse Bay in his ship, the "Terror," and then to cross an assumed isthmus and examine the coast-line thence to the mouth of the Great Fish river; but the ship was obliged to winter in the drifting pack, and was brought home in a sinking condition.

The tracing of the polar shores of America was completed by the Hudson's Bay Company's servants. In June 1837 Thomas Simpson and P. W. Dease left Chippewyan, reached the mouth of the Mackenzie, and connected that position with Point Barrow, which had been discovered by the "Blossom" in 1826. In 1839 Simpson passed Cape Turnagain of Franklin, tracing the coast eastward so as to connect with Back's work at the mouth of the Great Fish river. He landed at Montreal Island in the mouth of that river, and then advanced eastward as far as Castor and Pollux river, his farthest eastern point. On his return he travelled along the north side of the channel, the south shore of the King William Island discovered by James Ross. The south-western point of this island was named Cape Herschel, and there Simpson built a cairn on the 26th of August 1839. Little remained to do in order to complete the definition of the northern shores of the American continent, and this task was entrusted to Dr John Rae, a Hudson's Bay factor, in 1846. He went in boats to Repulse Bay, where he wintered in a stone hut nearly on the Arctic Circle; and there he and his six Orkney men maintained themselves on the deer they shot. During the spring of 1847 Dr Rae explored on foot the shores of a great gulf having 700 m. of coast-line. He thus connected the work of Parry, at the mouth of Fury and Hecla

Straits, with the work of Ross on the coast of Boothia, proving that Boothia was part of the American continent.

While British explorers were thus working hard to solve some of the geographical problems relating to Arctic America, the

Russians were similarly engaged in Siberia. In 1821

Anjou. Lieut. P. F. Anjou made a complete survey of the New Siberia Islands, and came to the conclusion that it was not possible to advance far from them in a northerly direction,

owing to the thinness of the ice and to open water existing within 20 or 30 m. Baron Wrangell prosecuted similar investigations from the mouth of the Kolyma

between 1820 and 1823. He made four journeys with dog sledges, exploring the coast between Cape Chelagskoi and the Kolyma, and making attempts to extend his journeys to some distance from the land, but he was always stopped by thin ice.

In 1843 Middendorf was sent to explore the region

Middendorf. which terminates in Cape Chelyuskin. He reached Taimyr Bay in the height of the short summer, whence he saw open water and no ice blink in any direction. The whole arctic shore of Siberia had now been explored and delineated, but no vessel had yet rounded the extreme northern point.

The success of Sir James Ross's Antarctic expedition and the completion of the northern coast-line of America by the Hudson's

Bay Company's servants gave rise in 1845 to a fresh attempt to make the passage from Lancaster Sound to Bering Strait. The story of the unhappy expedition of Sir John Franklin, in the "Erebus" and "Terror," is told under FRANKLIN; but some geographical details may be given here.

The heavy polar ice flows south-east between Melville and Baring Islands, down M'Clintock Channel, and impinges on the north-west coast of King William Land. It was this branch from the "palaeocrystic" sea which finally stopped the progress of Franklin's expedition. On leaving the winter quarters at Beechey Island in 1846 Franklin found a channel leading south, along the western shore of the land of North Somerset discovered by Parry in 1819. If he could reach the channel on the American coast, he knew that he would be able to make his way along it to Bering Strait. This channel, now called Peel Sound, pointed directly to the south. He sailed down it towards King William Island, with land on both sides. But directly the southern point of the western land was passed and no longer shielded the channel, the great ice stream from Melville Island, pressing on King William Island, was encountered and found impassable. Progress might have been made by rounding the eastern side of King William Island, but its insularity was then unknown.

It was not until 1848 that anxiety began to be felt about the Franklin expedition. In the spring of that year Sir James Ross

Search Expedition. was sent with two ships, the "Enterprise" and "Investigator," by way of Lancaster Sound. He

Reps. wintered at Leopold Harbour, near the north-east point of North Devon. In the spring he made a long sledge journey with Lieut. Leopold M'Clintock along the northern and western coasts of North Somerset, but found nothing.

On the return of the Ross expedition without any tidings, the country became thoroughly alarmed. An extensive plan of search

was organized—the "Enterprise" and "Investigator" under Collinson and M'Clure proceeding by Bering Strait, while the "Assistance" and "Resolute," with two steam tenders, the "Pioneer" and "Intrepid," sailed on the 3rd of May 1850 to renew the search by Barrow Strait, under Captain Horatio Austin. Two brigs, the "Lady Franklin" and "Sophia," under William Penny, an energetic and able whaling captain, were sent by the same route. He had with him Dr Sutherland, a naturalist, who did much valuable scientific work. Austin and Penny entered Barrow Strait, and Franklin's winter quarters of 1845-1846 were discovered at Beechey Island; but there was no record of any kind indicating the direction taken by the ships. Stopped by the ice, Austin's expedition wintered (1850-1851) in the pack off Griffith Island, and Penny found refuge in a harbour on the south coast of Cornwallis Island. Austin, who had been with Parry during his third voyage, was

an admirable organizer. His arrangements for passing the winter were carefully thought out and answered perfectly. In concert with Penny he planned a thorough and extensive system of search by means of sledge-travelling in the spring, and Lieut. M'Clintock superintended every detail of this part of the work with unflinching forethought and skill. Penny undertook the search by Wellington Channel. M'Clintock advanced to Melville Island, marching over 770 m. in eighty-one days; Captain Ommanney and Sherard Osborn pressed southward and discovered Prince of Wales Island. Lieut. Brown examined the western shore of Peel Sound. The search was exhaustive; but, except the winter quarters at Beechey Island, no record was discovered. The absence of any record made Captain Austin doubt whether Franklin had ever gone beyond Beechey Island; so he also examined the entrance of Jones Sound, the next inlet from Baffin Bay north of Lancaster Sound, on his way home, and returned to England in the autumn of 1851. This was a thoroughly well conducted expedition, especially as regards the sledge-travelling, which M'Clintock brought to great perfection. So far as the search for Franklin was concerned, nothing remained to be done west or north of Barrow Strait.

In 1851 the "Prince Albert" schooner was sent out by Lady Franklin, under Captain Wm. Kennedy, with Lieut. Bellot of the French navy as second. They wintered on the east coast of North Somerset, and in the spring of 1852 the gallant Frenchman, in the course of a long sledgeing journey, discovered Bellot Strait, separating North Somerset from Boothia—thus proving that the Boothia coast facing the strait was the northern extremity of the continent of America.

The "Enterprise" and "Investigator" sailed from England in January 1850, but accidentally parted company before they reached Bering Strait. On the 6th of May 1851 the "Enterprise" passed the strait, and rounded Point

Collinson. Barrow on the 25th. Collinson then made his way up the narrow Prince of Wales Strait, between Banks and Prince Albert Islands, and reached Princess Royal Islands, where M'Clure had been the previous year. Returning southwards, the "Enterprise" wintered in a sound in Prince Albert Island in 71° 35' N. and 117° 35' W. Three travelling parties were despatched in the spring of 1852—one to trace Prince Albert Land in a southerly direction, while the others explored Prince of Wales Strait, one of them reaching Melville Island. In September 1852 the ship was free, and Collinson pressed eastward along the coast of North America, reaching Cambridge Bay (Sept. 26), where the second winter was passed. In the spring he examined the shores of Victoria Land as far as 70° 26' N. and 100° 45' W.: here he was within a few miles of Point Victory, where the fate of Franklin would have been ascertained. The "Enterprise" again put to sea on the 5th of August 1853, and returned westward along the American coast, until she was stopped by ice and obliged to pass a third winter at Camden Bay, in 70° 8' N. and 145° 29' W. In 1854 this remarkable voyage was completed, and Captain Collinson brought the "Enterprise" back to England.

Meanwhile M'Clure in the "Investigator" had passed the winter of 1850-1851 at the Princess Royal Islands, only 30 m. from Barrow Strait. In October M'Clure ascended

M'Clure. a hill whence he could see the frozen surface of Barrow Strait, which was navigated by Parry in 1819-1820. Thus, like the survivors of Franklin's crews when they reached Cape Herschel, M'Clure discovered a north-west passage. It was impossible to reach it, for the stream of heavily packed ice which stopped Franklin off King William Land lay athwart their northward course; so, as soon as he was free in 1851, M'Clure turned southwards, round the southern extreme of Banks Land, and commenced to force a passage to the northward between the western shore of that land and the enormous fields of ice which pressed upon it. The cliffs rose like walls on one side, while on the other the stupendous ice of the "palaeocrystic sea" rose from the water to a level with the "Investigator's" lower yards. After many hairbreadth escapes M'Clure took refuge in a bay on the northern shore of Banks Land, which he named the Bay of

Collinson then made his way up the narrow Prince of Wales Strait, between Banks and Prince Albert Islands, and reached Princess Royal Islands, where M'Clure had been the previous year. Returning southwards, the "Enterprise" wintered in a sound in Prince Albert Island in 71° 35' N. and 117° 35' W. Three travelling parties were despatched in the spring of 1852—one to trace Prince Albert Land in a southerly direction, while the others explored Prince of Wales Strait, one of them reaching Melville Island. In September 1852 the ship was free, and Collinson pressed eastward along the coast of North America, reaching Cambridge Bay (Sept. 26), where the second winter was passed. In the spring he examined the shores of Victoria Land as far as 70° 26' N. and 100° 45' W.: here he was within a few miles of Point Victory, where the fate of Franklin would have been ascertained. The "Enterprise" again put to sea on the 5th of August 1853, and returned westward along the American coast, until she was stopped by ice and obliged to pass a third winter at Camden Bay, in 70° 8' N. and 145° 29' W. In 1854 this remarkable voyage was completed, and Captain Collinson brought the "Enterprise" back to England.

Meanwhile M'Clure in the "Investigator" had passed the winter of 1850-1851 at the Princess Royal Islands, only 30 m. from Barrow Strait. In October M'Clure ascended

M'Clure. a hill whence he could see the frozen surface of Barrow Strait, which was navigated by Parry in 1819-1820. Thus, like the survivors of Franklin's crews when they reached Cape Herschel, M'Clure discovered a north-west passage. It was impossible to reach it, for the stream of heavily packed ice which stopped Franklin off King William Land lay athwart their northward course; so, as soon as he was free in 1851, M'Clure turned southwards, round the southern extreme of Banks Land, and commenced to force a passage to the northward between the western shore of that land and the enormous fields of ice which pressed upon it. The cliffs rose like walls on one side, while on the other the stupendous ice of the "palaeocrystic sea" rose from the water to a level with the "Investigator's" lower yards. After many hairbreadth escapes M'Clure took refuge in a bay on the northern shore of Banks Land, which he named the Bay of

Collinson then made his way up the narrow Prince of Wales Strait, between Banks and Prince Albert Islands, and reached Princess Royal Islands, where M'Clure had been the previous year. Returning southwards, the "Enterprise" wintered in a sound in Prince Albert Island in 71° 35' N. and 117° 35' W. Three travelling parties were despatched in the spring of 1852—one to trace Prince Albert Land in a southerly direction, while the others explored Prince of Wales Strait, one of them reaching Melville Island. In September 1852 the ship was free, and Collinson pressed eastward along the coast of North America, reaching Cambridge Bay (Sept. 26), where the second winter was passed. In the spring he examined the shores of Victoria Land as far as 70° 26' N. and 100° 45' W.: here he was within a few miles of Point Victory, where the fate of Franklin would have been ascertained. The "Enterprise" again put to sea on the 5th of August 1853, and returned westward along the American coast, until she was stopped by ice and obliged to pass a third winter at Camden Bay, in 70° 8' N. and 145° 29' W. In 1854 this remarkable voyage was completed, and Captain Collinson brought the "Enterprise" back to England.

Meanwhile M'Clure in the "Investigator" had passed the winter of 1850-1851 at the Princess Royal Islands, only 30 m. from Barrow Strait. In October M'Clure ascended

M'Clure. a hill whence he could see the frozen surface of Barrow Strait, which was navigated by Parry in 1819-1820. Thus, like the survivors of Franklin's crews when they reached Cape Herschel, M'Clure discovered a north-west passage. It was impossible to reach it, for the stream of heavily packed ice which stopped Franklin off King William Land lay athwart their northward course; so, as soon as he was free in 1851, M'Clure turned southwards, round the southern extreme of Banks Land, and commenced to force a passage to the northward between the western shore of that land and the enormous fields of ice which pressed upon it. The cliffs rose like walls on one side, while on the other the stupendous ice of the "palaeocrystic sea" rose from the water to a level with the "Investigator's" lower yards. After many hairbreadth escapes M'Clure took refuge in a bay on the northern shore of Banks Land, which he named the Bay of

Collinson then made his way up the narrow Prince of Wales Strait, between Banks and Prince Albert Islands, and reached Princess Royal Islands, where M'Clure had been the previous year. Returning southwards, the "Enterprise" wintered in a sound in Prince Albert Island in 71° 35' N. and 117° 35' W. Three travelling parties were despatched in the spring of 1852—one to trace Prince Albert Land in a southerly direction, while the others explored Prince of Wales Strait, one of them reaching Melville Island. In September 1852 the ship was free, and Collinson pressed eastward along the coast of North America, reaching Cambridge Bay (Sept. 26), where the second winter was passed. In the spring he examined the shores of Victoria Land as far as 70° 26' N. and 100° 45' W.: here he was within a few miles of Point Victory, where the fate of Franklin would have been ascertained. The "Enterprise" again put to sea on the 5th of August 1853, and returned westward along the American coast, until she was stopped by ice and obliged to pass a third winter at Camden Bay, in 70° 8' N. and 145° 29' W. In 1854 this remarkable voyage was completed, and Captain Collinson brought the "Enterprise" back to England.

Meanwhile M'Clure in the "Investigator" had passed the winter of 1850-1851 at the Princess Royal Islands, only 30 m. from Barrow Strait. In October M'Clure ascended

M'Clure. a hill whence he could see the frozen surface of Barrow Strait, which was navigated by Parry in 1819-1820. Thus, like the survivors of Franklin's crews when they reached Cape Herschel, M'Clure discovered a north-west passage. It was impossible to reach it, for the stream of heavily packed ice which stopped Franklin off King William Land lay athwart their northward course; so, as soon as he was free in 1851, M'Clure turned southwards, round the southern extreme of Banks Land, and commenced to force a passage to the northward between the western shore of that land and the enormous fields of ice which pressed upon it. The cliffs rose like walls on one side, while on the other the stupendous ice of the "palaeocrystic sea" rose from the water to a level with the "Investigator's" lower yards. After many hairbreadth escapes M'Clure took refuge in a bay on the northern shore of Banks Land, which he named the Bay of

Collinson then made his way up the narrow Prince of Wales Strait, between Banks and Prince Albert Islands, and reached Princess Royal Islands, where M'Clure had been the previous year. Returning southwards, the "Enterprise" wintered in a sound in Prince Albert Island in 71° 35' N. and 117° 35' W. Three travelling parties were despatched in the spring of 1852—one to trace Prince Albert Land in a southerly direction, while the others explored Prince of Wales Strait, one of them reaching Melville Island. In September 1852 the ship was free, and Collinson pressed eastward along the coast of North America, reaching Cambridge Bay (Sept. 26), where the second winter was passed. In the spring he examined the shores of Victoria Land as far as 70° 26' N. and 100° 45' W.: here he was within a few miles of Point Victory, where the fate of Franklin would have been ascertained. The "Enterprise" again put to sea on the 5th of August 1853, and returned westward along the American coast, until she was stopped by ice and obliged to pass a third winter at Camden Bay, in 70° 8' N. and 145° 29' W. In 1854 this remarkable voyage was completed, and Captain Collinson brought the "Enterprise" back to England.

Meanwhile M'Clure in the "Investigator" had passed the winter of 1850-1851 at the Princess Royal Islands, only 30 m. from Barrow Strait. In October M'Clure ascended

M'Clure. a hill whence he could see the frozen surface of Barrow Strait, which was navigated by Parry in 1819-1820. Thus, like the survivors of Franklin's crews when they reached Cape Herschel, M'Clure discovered a north-west passage. It was impossible to reach it, for the stream of heavily packed ice which stopped Franklin off King William Land lay athwart their northward course; so, as soon as he was free in 1851, M'Clure turned southwards, round the southern extreme of Banks Land, and commenced to force a passage to the northward between the western shore of that land and the enormous fields of ice which pressed upon it. The cliffs rose like walls on one side, while on the other the stupendous ice of the "palaeocrystic sea" rose from the water to a level with the "Investigator's" lower yards. After many hairbreadth escapes M'Clure took refuge in a bay on the northern shore of Banks Land, which he named the Bay of

Collinson then made his way up the narrow Prince of Wales Strait, between Banks and Prince Albert Islands, and reached Princess Royal Islands, where M'Clure had been the previous year. Returning southwards, the "Enterprise" wintered in a sound in Prince Albert Island in 71° 35' N. and 117° 35' W. Three travelling parties were despatched in the spring of 1852—one to trace Prince Albert Land in a southerly direction, while the others explored Prince of Wales Strait, one of them reaching Melville Island. In September 1852 the ship was free, and Collinson pressed eastward along the coast of North America, reaching Cambridge Bay (Sept. 26), where the second winter was passed. In the spring he examined the shores of Victoria Land as far as 70° 26' N. and 100° 45' W.: here he was within a few miles of Point Victory, where the fate of Franklin would have been ascertained. The "Enterprise" again put to sea on the 5th of August 1853, and returned westward along the American coast, until she was stopped by ice and obliged to pass a third winter at Camden Bay, in 70° 8' N. and 145° 29' W. In 1854 this remarkable voyage was completed, and Captain Collinson brought the "Enterprise" back to England.

Meanwhile M'Clure in the "Investigator" had passed the winter of 1850-1851 at the Princess Royal Islands, only 30 m. from Barrow Strait. In October M'Clure ascended

God's Mercy. Here the "Investigator" remained, never to move again. After the winter of 1851-1852 M'Clure had made a journey across the ice to Melville Island, and left a record at Parry's winter harbour. Abundant supplies of musk ox were fortunately obtained, but a third winter had to be faced. In the spring of 1853 M'Clure was preparing to abandon the ship with all hands, and attempt, like Franklin's crews, to reach the American coast; but succour arrived in time.

The Hudson Bay Company continued the search for Franklin. In 1848 Sir John Richardson and Dr Rae examined the American coast from the mouth of the Mackenzie to that of the *Rae's* Coppermine. In 1849 and 1850 Rae continued the *Journeys.* search; and by a long sledge journey in the spring of 1851, and a boat voyage in the summer, he examined the shores of Wollaston and Victoria Lands, which were afterwards explored by Captain Collinson in the "Enterprise."

In 1852 the British government resolved to despatch another expedition by Lancaster Sound. Austin's four vessels were recommissioned, and the "North Star" was sent out as a *Belcher's* ship at Beechey Island. Sir Edward Belcher commanded the "Assistance," with the "Pioneer" under Sherard Osborn as steam tender. He went up Wellington Channel to Northumberland Bay, where he wintered, passing a second winter lower down in Wellington Channel, and then abandoning his ships and coming home in 1854. But Sherard Osborn and Com. G. H. Richards did good work. They made sledge journeys to Melville Island, and thus discovered the northern side of the Parry group. Captain Kellett

Kellett received command of the "Resolute," with M'Clintock in the steam tender "Intrepid." Among Kellett's officers were the best of Austin's sledge-travellers, M'Clintock, Meham, and Vesey Hamilton, so that good work was sure to be done. George S. Nares, leader of the future expedition of 1874-1875, was also on board the "Resolute." Kellett pressed onwards to the westward and passed the winter of 1852-1853 at Melville Island. During the autumn Meham discovered M'Clure's record, and the position of the "Investigator" was thus ascertained. Lieut. Pim made his way to this point early in the following spring, and the officers and crew of the "Investigator," led by M'Clure, arrived safely on board the "Resolute" on the 17th of June 1853. They reached England in the following year, having not only discovered but traversed a north-west passage, though not in the same ship and partly by travelling over ice. For this great feat M'Clure received the honour of knighthood, and a reward of £10,000 was granted to himself, the other officers, and the crew, by a vote of the House of Commons.

The travelling parties of Kellett's expedition, led by M'Clintock, Meham and Vesey Hamilton, completed the discovery of the northern and western sides of Melville Island, and the whole outline of the large island of Prince Patrick, further west. M'Clintock was away from the ship with his sledge party for one hundred and five days, and travelled over 1328 m. Meham was away ninety-four days, and travelled over 1163 m. Sherard Osborn, in 1853, was away ninety-seven days, and travelled over 935 m. The "Resolute" was obliged to winter in the pack in 1853-1854, and in the spring of 1854 Meham made a remarkable journey in the hope of obtaining news of Captain Collinson at the Princess Royal Islands. Leaving the ship on the 3rd of April he was absent seventy days, out of which there were sixty-one and a half days of travelling. The distance gone over was 1336 statute miles. The average rate of the homeward journey was 231 m. a day, the average time of travelling each day nine hours twenty-five minutes.

Fearing detention for another winter, Sir Edward Belcher ordered all the ships to be abandoned in the ice, the officers and crews being taken home in the "North Star," and in the "Phoenix" and "Talbot," which had come out from England to communicate. They reached home in October 1854. In 1852 Captain Edward A. Inglefield, R.N., had made a voyage up Baffin Bay in the "Isabel" as far as the entrance of Smith Sound. In 1853 and 1854 he came out in the "Phoenix" to communicate with the "North Star" at Beechey Island.

The drift of the "Resolute" was a remarkable proof of the direction of the current out of Barrow Strait. She was abandoned in 74° 41' N. and 101° 11' W. on the 14th of May 1854. On the 10th of September 1855 an American whaler *Drift of the "Resolute."* sighted the "Resolute" in 67° N. lat. about twenty miles from Cape Mercy, in Davis Strait. She had drifted nearly a thousand miles, and having been brought into an American port, was purchased by the United States and presented to the British government.

In 1853 Dr Rae was employed to connect a few points which would quite complete the examination of the coast of America, and establish the insularity of King William Land. He went up Chesterfield Inlet and the river Quioich, *Rae's* wintering with eight men at Repulse Bay, where *Discovery.* venison and fish were abundant. In 1854 he set out on a journey which occupied fifty-six days in April and May. He succeeded in connecting the discoveries of Simpson with those of James Ross, and thus established the fact that King William Land was an island. Rae also brought home the first tidings and relics of Franklin's expedition gathered from the Eskimo, which decided the Admiralty to award him the £10,000 offered for definite news of Franklin's fate. Lady Franklin, however, sent out the "Fox" under the command of M'Clintock (see FRANKLIN). M'Clintock prosecuted an exhaustive search over part of the west coast of Boothia, the whole of the shores of King William Island, the mouth of the Great Fish River and Montreal Island, and Allen Young completed the discovery of the southern side of Prince of Wales Island.

The catastrophe of Sir John Franklin's expedition led to 7000 m. of coast-line being discovered, and to a vast extent of unknown country being explored, securing very considerable additions to geographical knowledge.

The American nation was first led to take an interest in Polar research through a noble and generous sympathy for Franklin and his companions. Mr Grinnell of New York gave *Grinnell's* practical expression to this feeling. In 1850 he *Expedition.* equipped two vessels, the "Advance" and "Rescue," to aid in the search, commanded by Lieuts. de Haven and Griffith, and accompanied by Dr E. K. Kane. They reached Beechey Island on the 27th of August 1850, and assisted in the examination of Franklin's winter quarters, but returned without wintering. In 1853 Dr Kane, in the little brig "Advance," of 120 tons, undertook to lead an American expedition up Smith Sound, the most northern outlet from Baffin Bay. *Kane.* The "Advance" reached Smith Sound on the 7th of August 1853, but was stopped by ice in 78° 45' N. only 17 m. from the entrance. Kane described the coast as consisting of precipitous cliffs 800 to 1200 ft. high, and at their base there was a belt of ice about 18 ft. thick, resting on the beach. Dr Kane adopted the Danish name of "ice-foot" (*is fod*) for this permanent frozen ledge. He named the place of his winter quarters Van Rensselaer Harbour. In the spring some interesting work was done. A great glacier was discovered with a sea face 45 m. long and named the Humboldt glacier. Dr Kane's steward, Morton, crossed the foot of this glacier with a team of dogs, and reached a point of land beyond named Cape Constitution. But sickness and want of means prevented much from being done by travelling parties. Scurvy attacked the whole party during the second winter, although the Eskimo-supplied them with fresh meat and were true friends in need. On the 17th of May 1855 Dr Kane abandoned the brig, and reached the Danish settlement of Upernivik on the 6th of August. Lieut. Hartsteele, who was sent out to search for Kane, reached the Van Rensselaer Harbour after he had gone, but took the retreating crew on board on his return voyage.

On the 10th of July 1860 Dr I. I. Hayes, who had served with Kane, sailed from Boston for Smith Sound, in the schooner "United States," of 130 tons and a crew of fifteen *Hayes.* men. His object was to follow up the line of research opened by Dr Kane. He wintered at Port Foulke, in 78° 17' N., but achieved nothing of importance, and his narrative is not to be depended on.

Charles Hall (q.v.), in his first journey (1860-1862), discovered remains of a stone house which Sir Martin Frobisher built on the

Countess of Warwick Island in 1578. In his second expedition (1864-1869) Hall reached the line of the retreat of the Franklin survivors, at Todd's Island and Peffer River, on the south coast of King William Island. He heard the story of the retreat and of the wreck of one of the ships from the Eskimo; he was told that seven bodies were buried at Todd Island; and he brought home some bones which are believed to be those of Lieut. Le Vescomte of the "Erebus." Finally, in 1871 he took the "Polaris" for 250 m. up the channel which leads northwards from Smith Sound. The various parts of this long channel are called Smith Sound, Kane Basin, Kennedy Channel and Robeson Channel. The "Polaris" was beset in $85^{\circ} 11'$ N. on the 30th of August; her winter quarters were in Thank God Harbour, $81^{\circ} 38'$ N., and here Hall died.

The Spitsbergen seas were explored during last century by Norwegian fishermen as well as by Swedish and German expeditions and by British yachtsmen. In 1827 the Norwegian geologist Keilhau made an expedition to Bear Island and Spitsbergen which was the first purely scientific Arctic expedition. The Norwegian Spitsbergen fishery dates from 1820, but it was only in the latter part of the century that Professor Mohn of Christiania carefully collected information from the captains who had taken part in the work when at its height. In 1863 Captain Carlsen circumnavigated the Spitsbergen group for the first time in a brig called the "Jan Mayen." In 1864 Captain Tobiesen sailed round North-East Land. In 1872 Captains Altmann and Nils Johnsen visited Wiche's Land, which was discovered by Captain Edge in 1671. In that year there were twenty-three sailing vessels from Tromsø, twenty-four from Hammerfest, and one from Vardø engaged in the Arctic sealing trade, averaging from 35 to 40 tons, and carrying a dozen men. Exploration went on slowly, in the course of the sealing and fishing voyages, the records of which are not very full. In 1869 Carlsen crossed the Kara Sea and reached the mouth of the Ob. In 1870 there were about sixty Norwegian vessels in the Barents Sea, and Captain Johannesen circumnavigated Novaya Zemlya. In 1873 Captain Tobiesen was unfortunately obliged to winter on the Novaya Zemlya coast, owing to the loss of his schooner, and both he and his young son died in the spring. Two years previously Captain Carlsen had succeeded in reaching the winter quarters of Barents, the first visitor since 1597, an interval of two hundred and seventy-four years. He landed on the 9th of September 1871, and found the house still standing and full of interesting relics, which are now in the naval museum at the Hague.

Between 1858 and 1872 the Swedes sent seven expeditions to Spitsbergen and two to Greenland, marking a new scientific era in Arctic exploration, of which Keilhau had been the pioneer. All returned with valuable scientific results. That of 1864 under A. E. Nordenskiöld and Duner made observations at 80 different places on the Spitsbergen shores, and fixed the heights of numerous mountains. In 1868, in an iron steamer, the "Sophia," the Swedes attained a latitude of $81^{\circ} 42'$ N. on the meridian of 18° E., during the month of September. In 1872 an expedition, consisting of the "Polhem" steamer and brig "Gladen," commanded by Professor Nordenskiöld and Lieut. Palander, wintered in Mossel Bay on the northern shore of Spitsbergen. In the spring an important sledging journey of sixty days' duration was made over North-East Land. The expedition was in some distress as regards supplies owing to two vessels, which were to have returned, having been forced to winter. But in the summer of 1873 they were visited by Mr Leigh Smith, in his yacht "Diana," who supplied them with fresh provisions.

Dr A. Petermann of Gotha urged his countrymen to take their share in the work of polar discovery, and at his own risk he fitted out a small vessel called the "Germania," which sailed from Bergen in May 1868, under the command of Captain Koldewey. His cruise extended to Hinlopen Strait in Spitsbergen, but was merely tentative; and in

1870 Baron von Heuglin with Count Zeil explored the Stor Fjord in a Norwegian schooner, and also examined Walter Thymen Strait. After the return of the "Germania" in 1868 a regular expedition was organized under the command of Captain Koldewey, provisioned for two years. It consisted of the "Germania," a screw steamer of 140 tons, and the brig "Hansa," commanded by Captain Hegemann. Lieut. Julius Payer, the future explorer of Franz Josef Land, gained his first Arctic experience on board the "Germania." The expedition sailed from Bremen on the 15th of June 1869, its destination being the east coast of Greenland. But in latitude $70^{\circ} 46'$ N. the "Hansa" got separated from her consort and crushed in the ice. The crew built a house of patent fuel on the floe, and in this strange abode they passed their Christmas. In two months the current carried them 400 m. to the south. By May they had drifted 1100 m. on their ice-raft, and finally, on the 14th of June 1870, they arrived safely at the Moravian mission station of Friedriksthal, to the west of Cape Farewell. Fairer fortune attended the "Germania." She sailed up the east coast of Greenland as far as $75^{\circ} 30'$ N., and eventually wintered at the Pendulum Islands of Clavering in $74^{\circ} 30'$ N. In March 1870 a travelling party set out under Koldewey and Payer, and reached a distance of 100 m. from the ship to the northward, when want of provisions compelled them to return. A grim cape, named after Prince Bismarck, marked the northern limit of their discoveries. As soon as the vessel was free, a deep branching fjord, named Franz Josef Fjord, was discovered in $73^{\circ} 15'$ N. stretching for a long distance into the interior of Greenland. The expedition returned to Bremen on the 11th of September 1870.

Lieut. Payer was resolved to continue in the path of polar discovery. He and the naval officer Weyprecht chartered a Norwegian schooner called the "Isbjörn," and examined the edge of the ice between Spitsbergen and Novaya Zemlya, in the summer of 1871. Their observations led them to select the route by the north end of Novaya Zemlya with a view to making the north-east passage. It was to be an Austro-Hungarian expedition, and the idea was seized with enthusiasm by the whole monarchy. Weyprecht was to command the ship, while Julius Payer conducted the sledge parties. The steamer "Tegethoff," of 300 tons, was fitted out in the Elbe, and left Tromsø on the 14th of July 1872. The season was severe, and the vessel was closely beset near Cape Nassau, at the northern end of Novaya Zemlya, in the end of August. The summer of 1873 found her still a close prisoner drifting, not with a current, but chiefly in the direction of the prevailing wind. At length, on the 31st of August, a mountainous country was sighted about 14 m. to the north. In October the vessel was drifted within 3 m. of an island lying off the main mass of land. Payer landed on it, and found the latitude to be $79^{\circ} 54'$ N. It was named after Count Wilczek, one of the warmest friends of the expedition. Here the second winter was passed. Bears were numerous and sixty-seven were killed, their meat proving to be an efficient preventive of scurvy. In March 1874 Payer made a preliminary sledge journey in intense cold (thermometer at -58° F.). On the 24th of March he started for a more prolonged journey of thirty days. Payer believed that the newly discovered country equalled Spitsbergen in extent, and described it as consisting of two or more large masses—Wilczek Land to the east, Zichy Land to the west, intersected by numerous fjords and skirted by a large number of islands. A wide channel, named Austria Sound, was supposed to separate the two main masses of land, and extend to 82° N. The whole country was named Franz Josef Land. Payer's large land-masses have by later discoveries been broken up into groups of islands and much of the land he thought he saw towards the east was found by Nansen not to exist. Payer returned to the "Tegethoff" on the 24th of April; and a third journey was undertaken to explore a large island named after M'Clintock. It then became necessary to abandon the ship and attempt a retreat in boats. This perilous voyage was commenced on the 20th of May. Three boats stored with provisions were placed on sledges. It was not until the 14th of August that they reached

the edge of the pack in $77^{\circ} 40' N.$, and launched the boats. Eventually they were picked up by a Russian schooner and arrived at Vardø on the 3rd of September 1874.

One of the most interesting problems connected with the physical geography of the polar regions is the actual condition of the vast elevated interior of Greenland, which is *Whympen*. one enormous glacier. In 1867 Mr Edward Whympen planned an expedition to solve the question, and went to Greenland, accompanied by Dr Robert Brown; but their progress was stopped, after going a short distance over the ice, by the breaking down of the dog-sledges. The expedition brought home geological and natural history collections of value. Dr H. Rink, for many years royal inspector of South Greenland and the most distinguished authority on all Greenlandic questions, also visited the inland ice. An important inland journey was undertaken by *Nordenskiöld in Greenland*. Professor A. E. Nordenskiöld in 1870, accompanied by Dr Berggren, professor of botany at Lund. The difficulty of traversing the inland ice of Greenland is caused by the vast ice-cap being in constant motion, advancing slowly towards the sea. This movement gives rise to huge crevasses which bar the traveller's way. The chasms occur chiefly where the movement of the ice is most rapid, near the ice streams which reach the sea and discharge icebergs. Nordenskiöld therefore chose for a starting-point the northern arm of a deep inlet called Auleitsivikfjord, which is 60 m. south of the discharging glacier at Jakobshavn and 240 north of that at Godthaab. He commenced his inland journey on the 19th of July. The party consisted of himself, Dr Berggren, and two Greenlanders; and they advanced 30 m. over the glaciers to a height of 2200 ft. above the sea.

The gallant enterprises of other countries rekindled the zeal of Great Britain for Arctic discovery; and in 1874 the prime *British Expedition of 1874*. minister announced that an expedition would be despatched in the following year. Two powerful steamers, the "Alert" and "Discovery," were selected for the service, and Captain George S. Nares was recalled from the "Challenger" expedition to act as leader. Commander Albert H. Markham, who had made a cruise up Baffin Bay and Barrow Strait in a whaler during the previous year, Lieut. Pelham Aldrich, an accomplished surveyor, and Captain Henry Wemyss Feilden, R.A., as naturalist, were also in the "Alert." The "Discovery" was commanded by Captain Henry F. Stephenson, with Lieut. Lewis A. Beaumont as first lieutenant. The expedition left Portsmouth on the 29th of May 1875, and entered Smith Sound in the last days of July. After much difficulty with drifting ice Lady Franklin Bay was reached in $81^{\circ} 44' N.$, where the "Discovery" was established in winter quarters. The "Alert" pressed onwards, and reached the edge of the heavy ice named by Nares the palaeocrystic sea, the ice-floes being from 80 to 100 ft. in thickness. Leaving Robeson Channel, the vessel made progress between the land and the grounded floe pieces, and passed the winter off the open coast and facing the great polar pack, in $82^{\circ} 27' N.$ Autumn travelling parties were despatched in September and October to lay out dépôts; and during the winter a complete scheme was matured for the examination of as much of the unknown area as possible, by the combined efforts of sledging parties from the two ships, in the ensuing spring. The parties started on the 3rd of April 1876. Captain Markham with Lieut. Parr advanced, in the face of great difficulties, over the polar pack to the latitude of $83^{\circ} 20' N.$ Lieut. Aldrich explored the coast-line to the westward, facing the frozen polar ocean, for a distance of 220 m. Lieut. Beaumont made discoveries of great interest along the northern coast of Greenland. The parties were attacked by scurvy, which increased the difficulty and hardships of the work a hundredfold. The expedition returned to England in October 1876. The "Alert" reached a higher latitude and wintered farther north than any ship had ever done before. The results of the expedition were the discovery of 300 m. of new coast line, the examination of part of the frozen polar ocean, a series of meteorological, magnetic and tidal observations at two points farther north than any such

observations had ever been taken before, and large geological and natural history collections.

In the same year 1875 Sir Allen Young undertook a voyage in his steam yacht the "Pandora" to attempt to force his way down Peel Sound to the magnetic pole, and if possible *Voyage of the Pandora* to make the north-west passage by rounding the eastern shore of King William Island. The "Pandora" entered Peel Sound on the 29th of August 1875, and proceeded down it much farther than any vessel had gone since it was passed by Franklin's two ships in 1846. Sir Allen reached a latitude of $72^{\circ} 14' N.$, and sighted Cape Bird, at the northern side of the western entrance of Bellot Strait. But here ice barred his progress, and he was obliged to retrace his track, returning to England on the 16th of October 1875. In the following year Sir Allen Young made another voyage in the "Pandora" to the entrance of Smith Sound.

Lieut. Koolemans Beynen, a young Dutch officer, who had shared Young's two polar voyages, on his return successfully endeavoured to interest his countrymen in polar discovery. It was wisely determined that the first *Dutch Expeditions*. expeditions of Holland should be summer reconnaissances on a small scale. A sailing schooner of 79 tons was built at Amsterdam, and named the "Willem Barents." In her first cruise she was commanded by Lieut. A. de Bruyne, with Koolemaas Beynen as second, and she sailed from Holland on the 6th of May 1878. Her instructions were to examine the ice in the Barents and Spitsbergen seas, take deep-sea soundings, and make natural history collections. She was also to erect memorials to early Dutch polar worthies at certain designated points. These instructions were ably and zealously carried out. Beynen died in the following year, but the work he initiated was carried on, the "Willem Barents" continuing to make annual polar cruises for many years.

In 1879 Sir Henry Gore-Booth and Captain A. H. Markham, R.N., in the Norwegian schooner "Isbjörn" sailed along the west coast of Novaya Zemlya to its most northern *Gore-Booth and Markham*. point, passed through the Matochkin Shar to the east coast, and examined the ice in the direction of Franz Josef Land as far as $78^{\circ} 24' N.$, bringing home collections in various branches of natural history, and making useful observations on the drift and nature of the ice in the Barents and Kara Seas.

In 1880 Mr B. Leigh Smith, who had previously made three voyages to Spitsbergen, reached Franz Josef Land in the polar steam yacht "Eira." It was observed that, while *Leigh Smith*. the Greenland icebergs are generally angular and peaked, those of Franz Josef Land are flat on the top, like the Antarctic bergs. The "Eira" sailed along the south side of Franz Josef Land to the westward and discovered 110 m. of coast-line of a new island named Alexandra Land, until the coast trended north-west. A landing was effected at several points, and valuable collections were made in natural history. In the following year the same explorer left Peterhead on the 14th of July; Franz Josef Land was sighted on the 23rd of July, and the "Eira" reached a point farther west than had been possible in her previous voyage. But in August the ship was caught in the ice, was nipped, and sank. A hut was built on shore in which Mr Leigh Smith and his crew passed the winter of 1881-1882, their health being well maintained, thanks to the exertions of Dr W. H. Neale. On the 21st of June 1882 they started in four boats to reach some vessels on the Novaya Zemlya coast. It was a most laborious and perilous voyage. They were first seen and welcomed by the "Willem Barents" on the 2nd of August, and soon afterwards were taken on board the "Hope," a whaler which had come out to search for them under the command of Sir Allen Young.

Professor A. E. Nordenskiöld, when he projected the achievement of the north-east passage, was a veteran polar explorer, for he had been in six previous expeditions to Greenland and Spitsbergen. In 1875 he turned his attention to the possibility of navigating the seas along the northern coast of Siberia. Captain Joseph Wiggins of Sunderland was a pioneer of this route,

and his voyages in 1874, 1875 and 1876 led the way for a trade between the ports of Europe and the mouth of the Yenisei River.

Norden-skiöld and the N.E. Passage. In June 1875 Professor Nordenskiöld sailed from Tromsø in the Norwegian vessel, the "Proven," reached the Yenisei by way of the Kara Sea, and discovered an excellent harbour on the eastern side of its mouth, which was named Port Dickson, in honour of Baron Oscar Dickson of Gothenburg, the munificent supporter of the Swedish expeditions. It having been suggested that the success of this voyage was due to the unusual state of the ice in 1875, Nordenskiöld undertook a voyage in the following year in the "Ymer," which was equally successful. By a minute study of the history of former attempts, and a careful consideration of all the circumstances, Professor Nordenskiöld convinced himself that the achievement of the north-east passage was feasible. The king of Sweden, Baron Oscar Dickson, and M. Sibirakoff, a wealthy Siberian proprietor, supplied the funds, and the steamer "Vega" was purchased. Nordenskiöld was leader of the expedition, Lieut. Palander was appointed commander of the ship, and there was an efficient staff of officers and naturalists, including Lieut. Hovgaard of the Danish and Lieut. Bove of the Italian navy. A small steamer called the "Lena" was to keep company with the "Vega" as far as the mouth of the Lena, and they sailed from Gothenburg on the 4th of July 1878. On the morning of the 10th of August they left Port Dickson, and on the 19th they reached the most northern point of Siberia, Cape Chelyuskin, in 77° 41' N. On leaving the extreme northern point of Asia a south-easterly course was steered, the sea being free from ice and very shallow. This absence of ice is to some extent due to the mass of warm water discharged by the great Siberian rivers during the summer. On the 27th of August the mouth of the river Lena was passed, and the "Vega" parted company with the little "Lena," continuing her course eastward. Professor Nordenskiöld very nearly made the north-east passage in one season; but towards the end of September the "Vega" was frozen in off the shore of a low plain in 67° 7' N. and 173° 20' W. near the settlements of the Chukchis. During the voyage very large and important natural history collections were made, and the interesting aboriginal tribe among whom the winter was passed was studied with great care. The interior was also explored for some distance. On the 18th of July 1879, after having been imprisoned by the ice for 204 days, the "Vega" again proceeded on her voyage and passed Bering Strait on the 20th. Sir Hugh Willoughby made his disastrous attempt in 1553. After a lapse of 326 years of intermittent effort, the north-east passage had at length been accomplished without the loss of a single life and without damage to the vessel. The "Vega" arrived at Yokohama on the 2nd of September 1879.

In 1879 an enterprise was undertaken in the United States, with the object of throwing further light on the sad history of the **Schwatka** retreat of the officers and men of Sir John Franklin's expedition, by examining the west coast of King William Island in the summer, when the snow is off the ground. The party consisted of Lieut. Schwatka of the United States army and three others. Wintering near the entrance of Chesterfield Inlet in Hudson Bay, they set out overland for the estuary of the Great Fish river, assisted by Eskimo and dogs, on the 1st of April 1879. They took only one month's provisions, their main reliance being upon the game afforded by the region to be traversed. The party obtained, during the journeys out and home, no less than 323 reindeer. After collecting various stories from the Eskimo at Montreal Island and at an inlet west of Cape Richardson, Schwatka crossed over to Cape Herschel on King William Land in June. He examined the western shore of the island with the greatest care for relics of Sir John Franklin's parties, as far as Cape Felix, the northern extremity. The return journey was commenced in November by ascending the Great Fish river for some distance and then marching over the intervening region to Hudson Bay. The cold of the winter months in that country is intense, the thermometer falling as low as -70° F., so that the return journey was most

remarkable, and reflects the highest credit on Lieut. Schwatka and his companions. As regards the search little was left to be done after M'Clintock, but some graves were found, as well as a medal belonging to Lieut. Irving of H.M.S. "Terror," and some bones believed to be his, which were brought home and interred at Edinburgh.

Mr Gordon Bennett, the proprietor of the *New York Herald*, having resolved to despatch an expedition of discovery at his own expense by way of Bering Strait, the "Pandora" was purchased from Sir Allen Young, and rechristened **De Long** the "Jeannette." Lieut. De Long of the United States navy was appointed to command, and it was made a national undertaking by special act of Congress, the vessel being placed under martial law and officered from the navy. The "Jeannette" sailed from San Francisco on the 8th of July 1879, and was last seen steaming towards Wrangell Land on the 3rd of September. This land had been seen by Captain Kellett, in H.M.S. "Herald" on the 17th of August 1879, but no one had landed on it, and it was shown on the charts by a long dotted line. The "Jeannette" was provisioned for three years, but as no tidings had been received of her by 1881, two steamers were sent up Bering Strait in search. One of these, the "Rodgers," under Lieut. Berry, anchored in a good harbour on the south coast of Wrangell Land, in 70° 57' N., on the 26th of August 1881. The land was explored by the officers of the "Rodgers" and found to be an island about 70 m. long by 28, with a ridge of hills traversing it east and west, the 71st parallel running along its southern shore. Lieut. Berry then proceeded to examine the ice to the northward, and attained a higher latitude by 21 m. than had ever been reached before on the Bering Strait meridian—namely, 73° 44' N. No news was obtained of the "Jeannette," but soon afterwards melancholy tidings arrived from Siberia. After having been beset in heavy pack ice for twenty-two months, the "Jeannette" was crushed and sunk on the 13th of June 1881, in 77° 15' N. lat., and 155° E. long. The officers and men dragged their boats over the ice to an island which was named Bennett Island, where they landed on the 29th of July. They reached one of the New Siberia Islands on the 10th of September, and on the 12th they set out for the mouth of the Lena. But in the same evening the three boats were separated in a gale of wind. A boat's crew with Mr Melville, the engineer, reached the Lena delta and searching for the other parties found the ship's books on the 14th of November, and resuming the search at the earliest possible moment in spring, Melville discovered the dead bodies of De Long and two of his crew on the 23rd of March 1882. They had perished from exhaustion and want of food. Three survivors of De Long's party had succeeded in making their way to a Siberian village; but the third boat's crew was lost. The "Rodgers" was burnt in its winter quarters, and one of the officers, W. H. Gilder (1838-1900), made a hazardous journey homewards through north-east Siberia.

The Norwegian geologist Professor Amund Helland made an expedition to Greenland in 1875 and discovered the marvellously rapid movements of the Greenland glaciers. **Holland**

The Danes have been very active in prosecuting discoveries and scientific investigations in Greenland, since the journey of Nordenskiöld in 1870. Lieut. Jensen made a gallant attempt to penetrate the inland ice in 1878, **Danes in Greenland.** collecting important observations, and Dr Steenstrup, with Lieut. Hammar, closely investigated the formation of ice masses at Omenak and Jacobshavn. In 1883 an expedition under Lieuts. Holm and Garde began to explore the east coast of Greenland. In the summer of 1879 Captain Mourier, of the Danish man-of-war "Ingolf," sighted the coast from the 6th to the 10th of July, and was enabled to observe and delineate it from 68° 10' N. to 65° 55' N., thus being the gap left between the discoveries of Scoresby in 1822 and those of Graah in 1829. Nansen sighted part of the same coast in 1882. Lieut. Hovgaard of the Danish navy, who accompanied Nordenskiöld in his discovery of the north-east passage, planned an expedition to ascertain if land existed to the north of

Cape Chelyuskin. He fitted out a small steamer called the "Dymphna" and sailed from Copenhagen in July 1882, but was unfortunately beset and obliged to winter in the Kara Sea. In 1883 Baron A. E. Nordenskiöld undertook another journey over the inland ice of Greenland. Starting from Auleitavikfjord on the 4th of July, his party penetrated 84 m. eastward, and to an altitude of 5000 ft. The Laplanders who were of the party were sent farther on snow-shoes, travelling over a desert of snow to a height of 7000 ft. Useful results in physical geography and biology were obtained.

On the 18th of September 1875 Lieut. Weyprecht, one of the discoverers of Franz Josef Land, read a paper before a large meeting of German naturalists at Graz on the scientific results to be obtained from polar research and the best means of securing them. He urged the importance of establishing a number of stations within or near the Arctic Circle, and also a ring of stations as near as possible to the Antarctic Circle, in order to record complete series of synchronous meteorological and magnetic observations. Lieut. Weyprecht did not live to see his suggestions carried into execution, but they bore fruit in due time. The various nations of Europe were represented at an international polar conference held at Hamburg in 1879 under the presidency of Dr Georg Neumayer, and at another at Berne in 1880; and it was decided that each nation should establish one or more stations where synchronous observations should be taken for a year from August 1882. This fine project was matured and successfully carried into execution. The stations arranged for in the North Polar region were at the following localities:—

Norwegians: *Boisekop*, Alven Fjord, Norway (M. Aksel S. Steca).
Sweden: *Ice Fjord*, Spitzbergen (Professor N. Ekholm).
Dutch: *Port Dickson*, mouth of Yenisei, Siberia (Dr M. Sællen).
Russians: { *Sogastyr Island*, mouth of Lena, Siberia (Lieut. Jürgens),
{ *Noraya Zemlya*, 72° 23' N. (Lieut. C. Andreief).
Finns: *Sodankyla*, Finland (Professor S. Leinström).
Americans: { *Point Barrow*, North America (Lieut. P. H. Ray, U.S.A.).
{ *Lady Franklin Bay*, 81° 44' N. (Lieut. A. W. Greely, U.S.A.).
British: *Great Slave Lake*, Dominion of Canada (Lieut. H. P. Dawson).
Germans: *Cumberland Bay*, west side of Davis Strait (Dr W. Gliese).
Danes: *Godthaab*, Greenland (Dr A. Paulsen).
Austrians: *Jan Mayen*, North Atlantic, 71° N. (Lieut. Wohlgenuth).

The whole scheme was successfully accomplished with the exception of the part assigned to the Dutch at Port Dickson. They started in the "Varna" but were beset in the Kara Sea and obliged to winter there. The "Varna" was lost, and the crew took refuge on board Lieut. Hovgaard's vessel, which was also forced to winter in the pack during 1882-1883. The scientific observations were kept up on both vessels during the time they were drifting with the ice.

The American stations commenced work in 1882 and one of these furnished a rare example of heroic devotion to duty in face of difficulties due to the fault of those who should have brought relief at the appointed time. Lieut. A. W. Greely's party consisted of two other lieutenants, twenty sergeants and privates of the United States army, and Dr Pavy, an enthusiastic explorer who had been educated in France and had passed the previous winter among the Eskimo of Greenland. On the 11th of August 1881 the steamer "Protosus" conveyed Lieut. Greely and his party to Lady Franklin Bay during an exceptionally favourable season; a house was built at the "Discovery's" winter quarters, and they were left with two years' provisions. The regular series of observations was at once commenced, and two winters were passed without accident. Travelling parties were also sent out in the summer, dogs having been obtained at Disco. Lockwood with twelve men and eleven sledges made a journey along the north coast of Greenland and reached Lockwood Island in 83° 24' N. and 42° 45' W., the highest latitude reached up to that time. From this island at a height of 2600 ft. on a clear day an unbroken expanse of ice was seen stretching to the northward, the view extending far beyond the 84th parallel. A promontory of the north coast of Greenland seen to the north-east in 83° 35' N. was named Cape Washington. Vegetation was found at the extreme position and animal life was represented by foxes, hares,

lemmings and ptarmigan. The party returned to Fort Conger on the 1st of June 1882 after an absence of 59 days. Greely made two journeys westward into the interior of Grinnell Land following up the northern branch of Chandler Fjord to a great sheet of frozen fresh water; Hazen Lake, with an area of about 500 sq. m. Beyond this, 175 m. from Fort Conger, he climbed Mt Arthur, 4500 ft., the highest summit of Grinnell Land, and saw distant mountains beyond a fjord to the southwest. In the spring of 1883 Lockwood made still more extensive journeys, crossing Grinnell Land to Greely Fjord, which entered the western sea. The central depression of Grinnell Land abounded in smelt and was free from ice, though the higher land to north and south lay under permanent ice-caps. Important as these geographical discoveries were, the main object of the expedition was the series of scientific observations at the headquarters, and these were carried out during the whole period with the most scrupulous exactness. As neither the relief ship which was to have been despatched in 1882, nor that in 1883, sent the expected relief to the station at Fort Conger, Lieut. Greely started from Lady Franklin Bay with his men in a steam launch and three boats on the 9th of August, expecting to find a vessel in Smith Sound. The boats were beset and had to be abandoned, the party reaching the shore across the ice with great difficulty, carrying their supplies of food, now rapidly diminishing. On the 21st of October 1883 they were obliged to encamp at Cape Sabine, on the western shore of Smith Sound, and build a hut for wintering. A few depôts were found, which had been left by Sir George Nares and Lieut. Beebe, but all supplies were exhausted before the spring. Then came a time of indescribable misery and acute suffering. The party proved insubordinate and the sternest measures were required to maintain military discipline. When the sun returned in 1884 the poor fellows began to die of actual starvation; but it was not until the 22nd of June 1884 that the relieving steamers "Thetis" and "Bear" reached Cape Sabine. Lieut. Greely and six suffering companions were found just alive, but with all their scientific records, their instruments in order and the great collections of specimens intact. The failure of the relief expeditions to overcome difficulties which were child's play to what Greely and his companions had come through only enhances the splendid courage and determination of the heroic survivors.

Danish expeditions under Lieut. G. Holm explored the east coast of Greenland from Cape Farewell northwards in Eskimo boats between 1863 and 1885, and at Angmagssalik they encountered a tribe of Eskimo who had never seen white men before. Lieut. Ryder and Lieut. T. V. Garde continued the exploration of East Greenland, and Ryder explored the great Scoresby Fjord. Captain Holm established a missionary and meteorological station at Angmagssalik Fjord in 1894, from which the Danish government take charge of the Eskimo of that region. In 1892-1893 an expedition sent out by the Berlin Geographical Society under Dr Erich von Drygalski studied the ice formations on the west of Greenland.

In July 1886 Lieut. Robert E. Peary, civil engineer, U.S. Navy, accompanied by the Dane Christian Malmgaard, made a journey on the inland ice of Greenland eastward from Disco Bay in about 69° 30' N. They reached a height of 7560 ft., when according to Peary's observations they were 100 m. from the coast, and then returned. Dr Fridtjof Nansen with Otto Sverdrup and five other companions, after overcoming great difficulties in penetrating the ice-floes, succeeded in landing on the east coast of Greenland in August 1888 in 64° 25' N. and reached a height of 8920 ft. on the inland ice, which was crossed on sled to the west coast. The interior was found to be a nearly flat plateau of snow resembling a frozen ocean, and at the high altitude of more than 8000 ft. the cold was intense. The crossing occupied more than two weeks, and the party not having dogs had themselves to haul all their gear on sledges. As they approached the western edge of the ice their progress was checked by dangerous crevasses; but on the 26th of September they succeeded in reaching the west coast at the head of the Ameralik Fjord in 64° 15' N., having

traversed 260 m. of glaciers. Nansen discovered that in that latitude the inland ice of Greenland has the form of a huge shield rising rather rapidly but regularly from the east coast to nearly 9000 ft., flat and even in the middle and falling again regularly toward the western side, completely enveloping the land. An important principle acted on for the first time in Arctic travel on this journey was that of starting from the less accessible side and pushing straight through with no possibility of turning back, and thus with no necessity for forming a base or traversing the same route twice over.

Peary spent the winter of 1891-1892 at Ingfield Gulf on the north-west coast of Greenland, Mrs Peary, Dr F. A. Cook, Eivind Astrup and a coloured servant Matthew Henson being in his party, and a large number of the Etah Eskimo in the vicinity. In April 1892 he set out for a journey across the inland ice to the north-eastward in the hope of reaching the east coast and also the northern extremity of the land. After getting well up on the ice-covered plateau a supporting party returned to winter quarters, while Peary and Astrup, with two companions and sixteen dogs, entered on the serious part of their work. The highest part of the inland ice was found to be about 5700 ft., and as usual after the first part of the descent, towards the north-east in this case, the surface was broken by numerous dangerous crevasses, progress amongst which was very slow. Great hardships were experienced from cold, insufficiency of food and the wearing out of sledges and clothes, but on the 4th of July, having left the ice and got on bare land in 87° 37' N., where musk oxen and other game were found and flowers were growing, Peary was rewarded by a glimpse of the sea to the north-eastward, and named it from the date Independence Bay. He also traced a channel to the north beyond which lay a new land largely free from snow, no doubt the southern part of the island along the north of which Markham and Lockwood had travelled to their farthest north. The return journey to Ingfield Gulf was a wonderful feat of endurance, which was completed on the 4th of August; the total distance marched on the whole journey out and home was 1300 m. Peary returned to northern Greenland in 1893, having spent the whole time between the two expeditions in writing and lecturing in order to raise funds, for he travelled at his own charges. He landed on the shore of Ingfield Gulf on the 3rd of August and wintered there with a party of thirteen, including Mrs Peary, and there their daughter was born. Astrup was taken ill after starting on the great journey in March 1894, which was to have extended the explorations of the previous year, and had to return; others were severely frost-bitten, disease broke out amongst the dogs, and a month after the start Peary was only 130 m. from his base and had to return. Peary with two of his party, Hugh J. Lee and Matthew Henson, remained at Ingfield Gulf for another winter, and on the 1st of April 1895, with deer and walrus meat in place of pemmican, the supply of which had been lost, set out for Independence Bay. They reached the ice-free land when their food was exhausted and fortunately fell in with a herd of musk oxen, the meat from which made it possible to get back to Ingfield Gulf, though without adding anything material to the results of 1892. The experience of ice-travel and of Eskimo nature gained in the four years' almost continuous residence in northern Greenland were however destined to bear rich fruit.

Dr Nansen, after making an exhaustive study of the winds and currents of the Arctic Sea, and influenced largely by the Nansen's occurrence of driftwood on the shores past which the drift of the ice-laden waters flowed southward between Greenland and Spitsbergen, satisfied himself that there was a general drift across the polar basin and perhaps across the Pole. He planned an expedition to take advantage of this drift on the principle which guided his crossing of Greenland, that of entering at the least accessible point and not turning back, thus having no line of retreat and making a relief expedition impossible. He planned a ship, the "Fram," which was immensely strong, to resist crushing, and of such a section that if nipped in the ice the opposing ice-masses would pass under her and lift her on to the surface. The plan of the expedition was based on scientific

reasoning, but the methods were totally at variance with those of previous explorers. Otto Sverdrup, who had been one of Nansen's party in crossing Greenland, was captain of the "Fram," and the party included eleven others, the whole ship's company of thirteen living together on terms of social equality. Nansen paid the greatest possible attention to the provisions, and all the arrangements for the health and happiness of those on board were carefully thought out. The clothing of the expedition was as original in design as the ship; instead of having furs, thick woollen underclothing was adopted, with a light wind-proof material for the outer dress. The "Fram" left Christiania in the summer of 1893, and made her way through the Kara Sea and along the north coast of Asia until on the 20th of September she was run into the ice in 77° 30' N., off the New Siberia Islands, and the great drift commenced. As anticipated, she rose to the pressure of the ice and was borne on an even keel high above the water for the whole duration of the drift. The movement of the ice was irregular, and on the 7th of November the "Fram" was back at her starting-point, but on the whole the movement was north-westward until the 15th of November 1895, when the highest latitude of the ship was attained, 85° 55' N. in 66° 31' E., the meridian of the east of Novaya Zemlya; then it was westward and finally southward until the ice was broken by blasting round the ship in June in 83° N. lat.; and after being afloat, though unable to make much progress until the middle of July, the "Fram" broke out of the ice off the north coast of Spitsbergen on the 13th of August 1896. No ship before or since has reached so high a latitude. In all her drift the "Fram" came in sight of no new land, but the soundings made through the ice proved that the Arctic Sea was of great depth, increasing towards the Pole, the greatest depth exceeding 2000 fathoms. The great mass of water filling the polar basin was comparatively warm, indicating free circulation with the Atlantic. It was established that the ice formed off the coast of Asia drifted across the polar basin in a period of from three to five years, and the hypothesis on the truth of which Nansen risked his success was abundantly verified by facts. The ship's company all returned in perfect health. After the second winter on the "Fram" at a time when the northward movement of the drift seemed to be checked, Nansen, accompanied by Lieut. Hjalmar Johansen, left the ship in order to explore the regions towards the Pole by travelling on ski with dog sledges carrying kayaks. It was obviously hopeless to attempt to find the drifting ship on their return, and Nansen intended to make for Spitsbergen in the hope of meeting one of the tourist steamers there. A more daring plan was never formed, and it was justified by success. Leaving the ship on the 14th of March 1895 in 84° N. 102° E., they made a fairly rapid march northward, reaching a latitude of 86° 5' N. on the 8th of April; the nearest approach to the Pole so far achieved. Turning south-westwards they travelled with much difficulty, sometimes on the ice, sometimes in kayaks in the open lanes of water, incurring great danger from the attacks of bears and walrus, but at length reaching a group of new islands east of Franz Josef Land. They travelled westward through this archipelago until the 28th of August, when they built a small stone hut roofed with their light silk tent, in which they passed the winter on a land since called Frederick Jackson Island. There they lived like Eskimo on bear and walrus meat cooked over a blubber lamp. The journey southward was resumed in the spring of 1896, and on the 15th of June they met Mr F. G. Jackson, in whose relief ship, the "Windward," they returned to Norway. Nansen and Johansen reached Vardø on the 13th of August 1896 full of anxiety for the fate of their old comrades, when by a coincidence unparalleled in the history of exploration, the "Fram" was on that very day breaking out of the ice off Spitsbergen and the original party of thirteen was reunited at Tromsø the following week and returned together to Christiania. On this remarkable expedition no life was lost and the ship came back undamaged under the skilled guidance of Sverdrup with a great harvest of scientific results.

Mr Frederick George Jackson planned an exploring expedition

to attain a high latitude by the Franz Josef Land route and was supported financially by Mr A. C. Harmsworth (Lord Northcliffe). He was accompanied by Lieut. Albert ^{Jackson-} Harmsworth Armitage, R.N.R., as second in command and six ^{Expedition.} scientific men, including Dr Reginald Koeltz; Dr W. S. Bruce also was one of the number in the second year. The Jackson-Harmsworth expedition sailed in 1894, and was landed at Cape Flora, where log houses were built. In the spring of 1895 Jackson made a journey northward to 81° 10' N., the highest latitude reached, and added considerably to our knowledge of the archipelago by discovering a channel between groups of islands west of the Austria Sound of Payer. He made numerous other journeys by land and in boats, and surveyed a considerable portion of the islands on which he landed, the most interesting being that of 1897, to the western portion of the group. The geological collections were of some value and the specimens secured indicated that Franz Josef Land and Spitsbergen were parts of an extensive land existing in Tertiary times. The expedition returned in 1897.

In 1897 and subsequent years a party led by Sir Martin Conway explored the interior of Spitsbergen. Dr A. G. Nathorst, the Swedish geologist, explored the eastern coast and off-lying islands, and made important observations on North-East Land, circumnavigating the Spitsbergen archipelago in 1898. In 1899 Nathorst visited the north-east coast of Greenland in search of Andrée's balloon expedition, and here he mapped Franz Josef Fjord and discovered the great King Oscar Fjord in waters that had never been navigated before.

In subsequent years valuable surveys and scientific observations were made by the Prince of Monaco in his yacht "Princess Alice," by Dr W. S. Bruce, notably on Prince Charles Foreland, and by others. Franz Josef Land was visited by the American explorer W. Wellman in 1898 and 1900, and his companion E. Baldwin in the former year made the discovery of several islands in the east of the archipelago. A wealthy American, W. Zeigler, also sent out expeditions to Franz Josef Land in 1901 and between 1903 and 1905, in the course of which A. Fiala reached the high latitude of 82° 4' N. in the "America," but the ship was afterwards lost in Teplitz Bay. These expeditions added little to our knowledge of polar geography, but some useful meteorological, magnetic and tidal observations were made.

The Italian expedition under the command of H.R.H. Prince Luigi, duke of the Abruzzi, was the most successful of all those which have attempted to reach high latitudes by the way of Franz Josef Land. Embarking in the summer of 1899 on the "Stella Polare" (formerly the Norwegian whaler "Jason" which had landed Nansen on the east coast of Greenland in 1888) the expedition put into Teplitz Bay in Rudolf Land, where they wintered and there the ship was seriously damaged by the ice. In the spring of 1900 a determined effort was made to reach the North Pole by sledging over the sea-ice. The duke of the Abruzzi having been disabled by frost-bite, the leadership of the northern party devolved upon Captain Umberto Cagni of the Italian navy, who started on the 11th of March 1900 with ten men (Alpine guides and Italian sailors) and nearly a hundred dogs. His plan was to sledge northward over the sea-ice, sending back two parties as the diminishing stores allowed the advance party to take on the whole of the supplies destined to support them on their way to the Pole and back. Before losing sight of Rudolf Island three men forming the first party started to return, but they never reached winter quarters and all must have perished. The second party went back from latitude 83° 10' N., and reached their base in safety. Cagni pushed on with three companions, determined if he could not reach the Pole at least to outdistance his predecessor Nansen, and on the 25th of April 1900 he succeeded in reaching 86° 34' N. in 65° 20' E. Diminishing food supplies made it necessary to turn at this point, and although he had reached it in 45 days it took Cagni 60 days to return. The advance of summer loosened the ice-floes, and the westward component of the drift of the pack became a more and more serious danger, threatening to carry the party past Franz Josef

Land without sighting it. Fortunately Cape Mill, a headland of characteristic outline, was sighted just in time, and with this as a guide the party succeeded in reaching Teplitz Bay, having eaten the last of their dogs and been reduced to great extremities. At the farthest north no land was visible, the rough sea-ice extending to the horizon on every side.

As early as 1895 a scheme for an exploring expedition in a balloon was put forward seriously, and in 1897 the Swedish aeronaut S. A. Andrée carried it out. He had ^{Andrée.} brought a balloon to Danes Island, in the north of Spitsbergen, the previous year, but the weather was unpropitious and the ascent had to be postponed. On the 11th of July 1897 he started in a new and larger balloon with about five tons of supplies and two companions. It was hoped that the balloon could be steered to some extent by the use of heavy guide ropes dragging over the ice, and Andrée had already made successful flights in this way. Rising at 2.30 p.m. the balloon was out of sight of Danes Island in an hour. At 10 p.m. Andrée threw out a buoy containing a message which was recovered, and this stated that the balloon was in 82° N. 25° E., moving towards the north-east at an altitude of 800 ft. above a rugged ice-field. This was the last news received, and although scarcely a year has passed without some rumour of the balloon having been found in Siberia or North America, nothing further has ever been ascertained.

In 1899 Admiral Makaroff of the Russian navy arranged for the trial trip of the great ice-breaker "Yermak," which he designed, to take the form of an expedition into ^{Makaroff.} the sea-ice off Spitsbergen. Though no high latitude was attained on this occasion he formed the opinion that a vessel of sufficient size and power could force a passage even to the Pole. The Russian-Japanese War put an end to the polar projects of this gifted man of science.

Captain Otto Sverdrup, who had been Nansen's companion on his two polar expeditions, planned an Arctic voyage for the circumnavigation of Greenland, and the "Fram" ^{Sverdrup.} was altered and refitted to suit her for the work. Starting in 1899, he was obliged to abandon the attempt to get northward through Smith Sound, and making his way westward into Jones Sound he spent three years in exploring and mapping the portion of the Arctic archipelago which lay to the north of the field of labour of the Franklin search expeditions. Ellesmere and Grinnell Lands were shown to be part of one large land mass called King Oscar Land, which is separated by a narrow channel, Eureka Sound, from an extensive island named Axel Heiberg Land. Two of his party (Isachsen and Hassel) discovered and explored two islands west of Heiberg Land, and Dr Schei made most valuable observations on the geology of the whole of the district examined. Sverdrup's journeys cleared up a great deal of uncertainty regarding the geography of the least known portion of the Arctic archipelago, and leave little more to be done in that quarter. He brought the "Fram" safely back to Norway in 1903.

Many American whalers working in the sea reached through Bering Strait believe that land of considerable extent lies farther west than the Arctic archipelago, north of the mouth of the Mackenzie River, but neither the English traveller A. H. Harrison in 1905, nor the Dane Einar Mikkelsen in 1907, was able to find any trace of it, though the latter sledged over the sea ice as far as 72° N., where in 150° W. he got a sounding of 339 fathoms with no bottom. This depth makes it somewhat improbable that land exists in that quarter.

Russian surveyors and explorers continued to map portions of the Siberian coast, and in 1886 Dr Bunge and Baron Toll visited the New Siberia Islands and made known ^{Baron Toll.} the remarkable remains of mammoths which exist there in great numbers. In 1893 Baron Toll made an important geological expedition to the islands, discovering many well-preserved remains of mammoths and other extinct mammals and finding evidence that in the mammoth period trees grew at least as far as 74° N. Indefatigable in the pursuit of his studies, Toll set out once more in 1901 on board the

"Zarya," hoping to reach Sannikoff Island, the most northern and still unvisited portion of the New Siberia group. In August 1903 he reached Bennet Island with the astronomer Seeberg and two men; he found the island to be a plateau about 1300 ft in elevation, and remained there until November studying the geological features. Nothing more was heard of the expedition, and a relief expedition in 1904, under Lieuts. Brusneff and Kolchak, failed to find any trace of the explorers beyond a record left on Bennet Island, which gave a summary of their movements up to the time of leaving the island.

In 1901 Captain Roald Amundsen, a Norwegian, who had been mate on the "Belgica" in her Antarctic voyage, planned an expedition to the area of the north magnetic pole visited by Sir James Ross in 1831, in order to re-locate it, and as a secondary object he had in view the accomplishment of the North-West Passage by water for the first time, McClure not having carried his ship through from sea to sea. A small Norwegian sealing sloop, the "Gjøa," the cabin of which measured only 9 ft by 6, was fitted with a petroleum motor engine of 39 h.p. for use in calm weather and strengthened to withstand ice-pressure. She left Christiania on the 17th of June 1903 with a total company of six men, second in command being Lieut. Godfred Hansen of the Danish navy. She passed through Lancaster Sound and worked her way down the west side of Boothia Felix in August, and took up winter quarters in Gjøa Harbour at the head of Petersen Bay in King William Land. Here the little vessel remained for two years while magnetic and meteorological observations were carried out, and sledging excursions were made to the magnetic pole and along the coasts of Victoria Land, which was charted up to 72° N. In August 1905 the "Gjøa" proceeded westward along the American coast but was frozen in off King Point for a third winter. On the 11th of July 1906 she got free, and after much difficulty with the ice reached Bering Strait on the 30th of August and entered the Pacific, the first ship to pass from ocean to ocean north of Patagonia.

Danish explorers have continued to concentrate their attention on the problems of Greenland, and especially the geography of the east coast. Lieut. G. D. Amstrup, in a series of expeditions between 1898 and 1900, charted the coast-line as far north as 70° 15' N., and made important scientific observations and collections. From time to time whalers reached the east Greenland coast at points in high latitudes. The duke of Orleans in the "Belgica," under the command of Captain Gerlache, made an important voyage in 1905, in the course of which he cruised along the coast of Germania Land between 76° and 78° N., and fixed the general outline of the land up to that latitude. This expedition did a large amount of scientific work, especially in oceanography. The stream of sea-ice which presses outwards from the polar basin every summer bears close against the east coast of Greenland, and exploration by sea has always proved exceedingly difficult and precarious, success depending very much on the occurrence of chance leads amongst the ice. Taking advantage of all previous experience, the most important of the Danish expeditions was planned by L. Mylius-Erichsen

in 1905, the expenses being partly raised by private subscriptions and partly provided by the Danish government. He sailed in the "Danmark" in June 1906 and found winter quarters in Danmarkshavn, 75° 43' N., where the ship remained for two years, while systematic magnetic and meteorological observations were kept up at the base and the main work of exploring to the northward was carried on by sledge. From existing maps it was believed that about 620 m. of coast separated the winter quarters from the northern point of Greenland, but when the sledge expedition went out in 1907 the coast was found to curve much farther to the eastward than had been anticipated, and the outward journey extended to 800 m. Having left the winter quarters on the 28th of March 1907, Mylius-Erichsen, with Captain Koch, Hagen, an educated Eskimo, Brönlund and two others, reached North-East Foreland, the eastern extremity of Greenland (81° 20' N., 11° 15' W.). Here they divided; Koch with Bertheisen and the Eskimo

Tobias went north-westward to explore the east coast of Peary Land, and succeeded in reaching the northernmost extremity of the land beyond Cape Bridgman in 83° 30' N. From this great journey he returned in safety to winter quarters, arriving on the 24th of June. Meanwhile Mylius-Erichsen, with Hagen and the Eskimo Brönlund, followed the coast westward into what was believed to be the Independence Bay seen from a distance by Peary, this turned out to be a deep inlet now named Danmark Fjord. Keeping to the coast, they entered the great channel separating the mainland of Greenland from Peary Land, and surveyed Hagen Fjord on the southern shore and Brönlund Fjord on the northern shore of the strait. They had pushed on to Cape Glacier in 82° N. and 35° W. by the 14th of June 1907, within sight of Navy Cliff, which had been Peary's farthest coming from the west side, and here the softness of the snow kept them all summer. When they could travel, more than a fortnight was wasted adrift on a floe in the effort to cross Danmark Fjord. Here the sun left them, while they were without food, almost worn out and more than 500 m. from the ship. It was impossible to attempt the long journey round the coast, and the only chance of safety, and that a very slender one, was to make a way southward over the inland ice and so cut off the eastern horn of Greenland which the expedition had discovered. Under the most terrible difficulties, with only four starved dogs, and their equipment going to pieces, they accomplished the feat of marching 160 m. in 26 days, and reached the east coast again in 79° N. Hagen died on the way, Mylius-Erichsen himself struggled on until he nearly reached the provisions left on Lambert Island on the northern journey, but he too perished, and only Brönlund reached the supplies. He was frost-bitten and unable to proceed further, and after recording the tragedy of the return journey in his diary, he died also alone in the Arctic night. His body and the records of the great journey were discovered in the following year by Koch, who started on a relief expedition as soon as travelling became possible. The results of this expedition are a splendid monument to the courage and devotion of the leader and his followers. The channel between Spitsbergen and Greenland was shown by their efforts to be far narrower than had previously been supposed, and the outline of Greenland itself was fixed for the first time, and that by an extremely accurate survey.

There only remains one further episode to bring the history of polar exploration up to 1910, but that is the crowning event of four hundred years of unceasing effort, the attainment of the Pole itself; and it was accomplished by the undaunted perseverance of one man who would never accept defeat. After the return of the Jackson-Harmsworth expedition, Lord Northcliffe presented the "Windward" to Lieut. Peary, who resumed in 1898 his systematic explorations of the Smith Sound region in the hope of finding a way to the Pole. He was not restrained by the precedents of earlier travellers and made some long sledge journeys in the winter of 1898-1899, having his feet badly frost-bitten and losing eight toes. Even this crippling did not stop his work. He wintered amongst the Etah Eskimo in 1899-1900 and next spring made a successful journey to the most northerly land north of Greenland in 83° 35' where the land had an abundant flora and fauna, and he pushed north over the sea-ice for twenty miles farther, reaching 83° 54' N. Peary wintered again at Fort Conger in 1900-1901, and for the fourth year in succession he went through the Arctic winter, 1901-1902, at Payer Harbour. In the spring of 1902 he made a great journey to Cape Hecla in the north of Grant Land and thence northward over the frozen sea to 84° 17' N. in 70° W. Frequent open leads of water and the moving of the ice-floes made further advance impossible, and after an unparalleled sojourn in the farthest north, Peary returned to the United States. The Peary Arctic Club of New York, formed to support this indomitable explorer, provided funds for a new expedition and a ship differing in some respects from those hitherto employed and named the "Roosevelt." In her he proceeded in the summer of 1905 through Smith Sound and the northern channels to Cape Sheridan on the north coast of Grant Land;

Captain Robert Bartlett being in command of the ship. From this point he advanced by sledge to Cape Hecla, whence he made a most strenuous attempt to reach the North Pole. Organizing his large following of trained Eskimo, whose confidence in him had been won by many years of friendship, and his few white companions in separate parties, each complete in itself and well furnished with dogs and food, he set off at the end of February 1906. A very broad lead of open water was encountered in $84^{\circ} 38' N.$, and as the party did not carry kayaks much time was lost in getting across. The floes had a marked eastward drift and it was difficult to make progress northward, however, Peary struggled on by forced marches to $87^{\circ} 6' N.$, which he reached on the 21st of April 1906, the most northerly point so far attained. His return journey was the most dangerous in his experience; many leads had to be crossed, sometimes on ice so thin that it bent beneath the weight of the explorers, provisions were exhausted and the men were reduced to eating their dogs before they made land at Cape Neumayer in the north of Greenland, where game was found, and whence the return to the ship was comparatively easy.

Returning to America, Peary prepared for a last attempt. The "Roosevelt" was overhauled and various defects made good, but not in time for the summer of 1907. Peary's *Journey to Leaving New York in July 1908 the "Roosevelt,"* again under the command of R. Bartlett, brought the party, with the Eskimo who were picked up on the way, to Cape Sheridan by the 9th of September. During the winter all supplies were transported to Cape Columbia, farther west on the coast of Grant Land. Here there were ready to start in the first light of the Arctic day seven explorers, 17 picked Eskimo and 133 of the best dogs in Greenland with 19 sledges. As the outcome of all Peary's experience the expedition was arranged to consist of a lightly equipped advance party to select the route and make the trail by clearing a way through rough ice, and a main party composed of units of four men each with sledges containing all their requirements marching one day behind the pioneer party. From this unit parties were to return southward at intervals with the empty sledges, leaving the diminished main party to push on fully provisioned. The "big lead" which marks the edge of the continental shelf in $84^{\circ} N.$ was crossed after some delay and here the sun appeared for the first time on the 5th of March 1909. Dr MacMillan with three Eskimo and three sledges returned along the outward trail after the 7th of March from $84^{\circ} 29' N.$ A sounding at this point showed the depth of the sea to be 825 fathoms. After five more marches G. Borup turned back in $85^{\circ} 23'$ with three Eskimo and three sledges, the best Eskimo and dogs remaining with the main party. From this point the advance was regular, the pioneer party started from the snow-houses they had built and slept in when the main party arrived, and while the latter slept the pioneers marched, selected a camp, built new snow-houses, and slept till the main party came up. At $86^{\circ} 38' N.$ Prof. R. G. Marvin turned back, as usual with the three worst Eskimo and the worst dogs. His party reached the ship, but he himself was drowned in recrossing the "big lead," the only casualty of the expedition. At $88^{\circ} N.$ Bartlett turned back on the 1st of April in accordance with the system with two Eskimo, one sledge and 18 dogs. Up to this point Peary had saved himself as much as possible, leaving the path-finding and the observations to his very competent colleagues; but now he put forth all his strength for the arduous 140 mi. which separated him from the Pole. He was accompanied by Henson and four Eskimo. The ice improved as he went on and it was possible to do 25 mi. in a daily march of 10 hours, and on one occasion 30 mi. in 12 hours. On the 6th of April an observation gave $89^{\circ} 57' N.$, and here a camp was made and observations taken throughout 24 hours to fix the position, as well as excursions a few miles farther on and a few miles to right and left so as to be sure of actually reaching the Pole. No land was to be seen, and a sounding through the ice gave a depth of 1500 fathoms with no bottom. The American flag was hoisted; the goal of all the ages of exploration had been reached.

The return journey was quick and easy. The tracks kept open by the passage of the various return parties were distinct enough to follow, the snow-houses stood ready for sheltering at the end of each march, and a northerly gale kept the ice pressed well together and the leads closed. On the 23rd of April Cape Columbia was reached and soon after the party was safe on board the "Roosevelt." Success was due to the accumulated experience of twenty-three years' constant Arctic work, and to the thorough acquaintance with the Eskimo and their dogs, which enabled the best work to be got out of them.

Dr F. A. Cook spent two years in the Arctic regions, 1907-1909, and claimed to have reached the Pole by sledging alone with two Eskimo a year before Peary. He submitted the evidence for this achievement to the university of Copenhagen, which failed to find it satisfactory, and Dr Cook did not appear to challenge this decision.

PHYSIOGRAPHY OF THE ARCTIC REGION

Geology—Although much remains to be done in the exploration of the North Polar area, the main features of the physical geography of the region have been determined beyond any reasonable doubt. Within the Arctic Circle the northern portions of Europe, Asia, America and Greenland surround a central area of deep sea, the southern margin of which forms a broad continental shelf bearing many islands. The ring of land and shallow sea is broken only by the broad channel between Greenland and Europe through which Atlantic water gains an entrance to the Arctic Sea. The physical conditions of this sea, which covers the greater part of the Arctic regions, are dealt with later in detail; but there is less to be said regarding the land.

In a climate which taxes human powers to the utmost to carry on the simplest route-surveys in the course of an exploring expedition, and in the presence of a snow covering which is permanent on all high ground and only disappears for a short time in summer, even on the shores and islands, it is obvious that any knowledge of the geology must be difficult to obtain. On the earlier Arctic expeditions enthusiastic collectors brought together quantities of specimens, many of which it was found impossible to bring home, and they have been found abandoned by later travellers. As Arctic exploration was usually carried out on the sea or over the sea-ice even those expeditions in which experienced geologists took part furnished few opportunities for making investigations. The result is that the geology of the Arctic lands has to be inferred from observations made at isolated points where the fortune of the ice stopped the ship, or where on land journeys a favourable exposure was found. Almost every geological formation is known to be represented, from the Archaean to the Quaternary, and there is a general resemblance in the known geological features of most of the great Arctic islands. The fundamental rock in all appears to be Archaean gneiss. In the extreme north-east Carboniferous strata have recently been discovered similar to the Carboniferous rocks of Spitsbergen. The Jurassic rocks farther south are in places capped by Cretaceous beds, and closely resemble the Jurassic rocks of Spitsbergen, Franz Josef Land and the northern parts of Norway and Russia. Cretaceous and Tertiary rocks are found on the west coast of Greenland covered over by great flows of basalt, probably of Tertiary age, at Disco Island, Nugsuaq Peninsula and various points farther north. The only mineral of economic value found in Greenland is cryolite, which is mined at Ivigtut in the south-west. Native iron occurs in considerable masses in several places, some of it undoubtedly of telluric origin, though some is probably meteoric.

The second "Fram" expedition confirmed and extended the geological observations of the Franklin search expeditions on the American Arctic archipelago, and showed the presence above the Archaean rocks of Cambrian, Silurian and Devonian strata, the Silurian being represented by a widespread brown limestone abounding in fossils. Carboniferous limestones also occur and less extensive beds of quartz sandstones, schists and limestones containing ammonites and other Mesozoic fossils. Tertiary

POLAR REGIONS

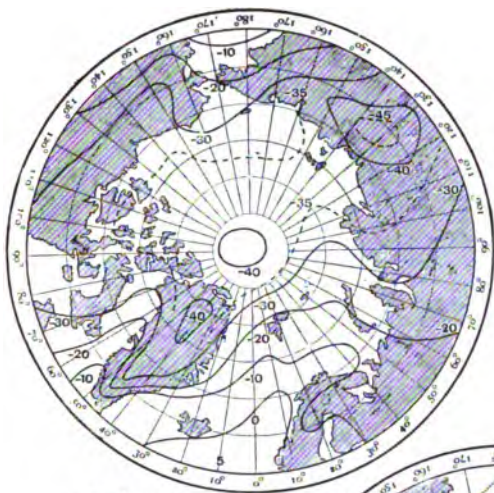

1. Isotherms, January.

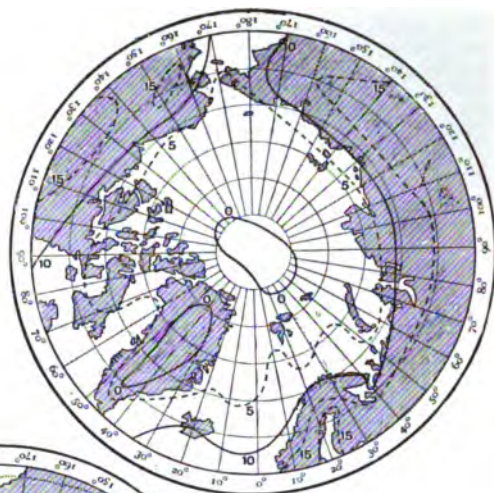

2. Isotherms, July.

ISOTHERMAL CHARTS.
Temperature in degrees Centi-
grade; $0^{\circ} = 32^{\circ} \text{F.}$, $-17.8^{\circ} = 0^{\circ} \text{F}$

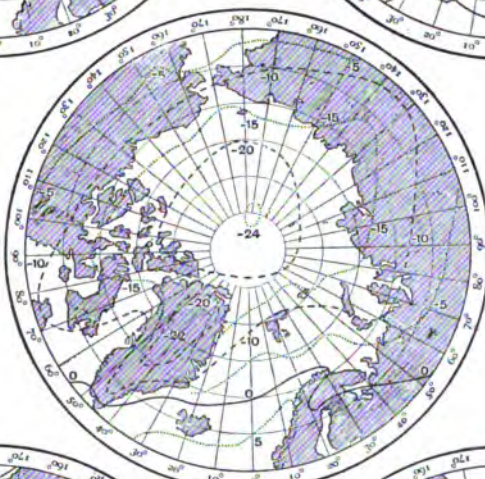

4. Isobars, January.

ISOBARIC CHARTS.
Pressure in millimetres, the
Figures indicating the addition
to 755. Thus on the charts 55
= 755 mm. = 29.7 in. to the
nearest tenth; 60 = 760 mm. =
29.9 in.; 65 = 765 mm. = 30.1 in.;
75 = 755 mm. = 30.5 in.

3. Mean Annual
Isotherms.

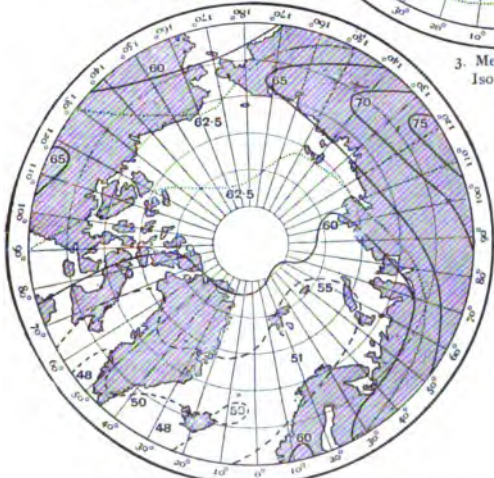

5. Isobars, July.

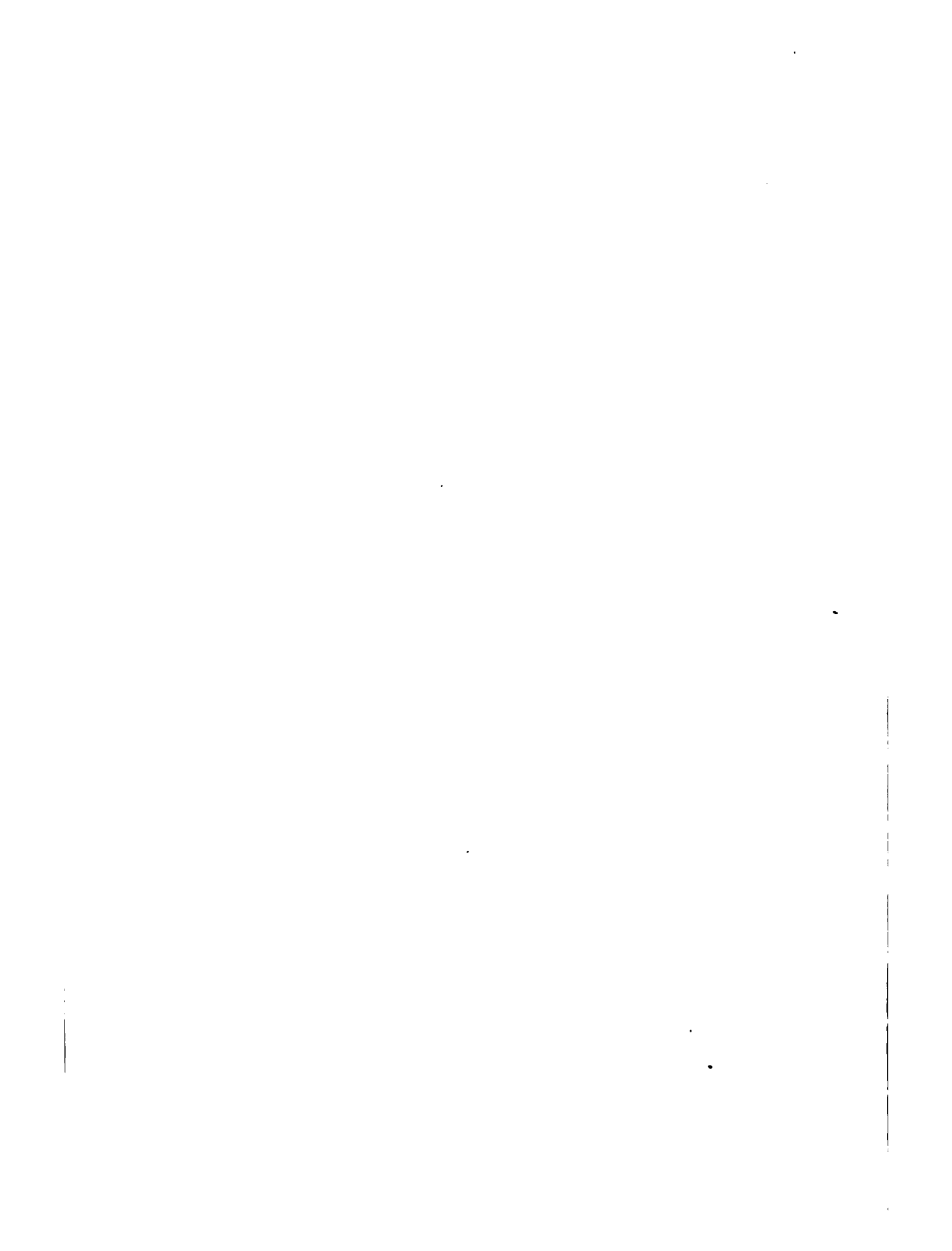

rocks including beds of lignite and plant fossils of Miocene age also occur, and they are interstratified and overspread with basalts and other eruptive rocks as in Greenland. In Grant Land Tertiary coal occurs in Lady Franklin Bay (81° 45' N.), the most northerly deposit of fossil fuel known. Arctic Canada consists of Archaean and Palaeozoic rocks worn down into plateaux or plains and bearing marks of glacial action, the absence of which is the most remarkable feature of the tundra region of Siberia. The Siberian coast is superficially formed to a large extent of frozen soil and gravel sometimes interbedded with clear ice, and in this soil the frozen bodies of mammoths and other Quaternary animals have been found preserved in a fresh condition by the low temperature. The absence of a glacial period in northern Siberia is probably indirectly due to the very low temperature which prevailed there, preventing the access of water vapour from without and so stopping the supply required to produce sufficient precipitation to form glaciers or ice-caps. On the New Siberia Islands Silurian and Tertiary rocks have been recognized, the latter with abundant deposits of fossil wood.

The geological evidence is complete as to the existence of a general climate in Tertiary times as far north as the present land extends, and of a climate less severe than that of to-day in the Quaternary period. The existence of raised sea margins in many Arctic lands and especially in the American Arctic archipelago bears evidence to a recent elevation of the land, or a withdrawal of the sea, which has been influential in forming some of the most prominent features of the present configuration.

It is noteworthy that no great mountain range runs into the Arctic region. The Rocky Mountains on the west and the Ural range on the east die down to insignificant elevations before reaching the Arctic Circle. The plateau of Greenland forms the loftiest mass of Arctic land, but the thickness of the ice cap is unknown. The one active volcano within the Arctic Circle is on the little island of Jan Mayen.

The Arctic Climate.—As the water of the Arctic Sea is free from ice around the margin only for a few months in summer, and is covered at all times over its great expanse with thick ice in slow uneasy motion, there is less contrast in climate between land and sea, especially in winter, than in other parts of the world. The climate of the polar area may be described as the most characteristic of all the natural features, and observations of temperature and pressure are more numerous and systematic than any other scientific observations. The Russian meteorological system includes Siberia, and long series of observations exist from stations up to and within the Arctic Circle. The Canadian Meteorological Service has secured like observations for the extreme north of North America, though the records are more fragmentary and of shorter duration. Norway and Iceland also yield many records on the margin of the Arctic Circle. The international circum-polar stations maintained during 1882 connected the Siberian, Norwegian and Canadian land stations with the more fragmentary work of the various polar expeditions which have wintered from time to time in high latitudes. The most valuable records and practically the only data available for the climate north of 84° are those of the first expedition of the "Fram" in her three years' drift across the polar basin. Later expeditions beyond the 84th parallel were merely dashes of a few weeks' duration, the records from which, however accurate, are of an altogether different order of importance. The data collected by the "Fram" were discussed in great detail by Professor H. Mohn in 1904, and that eminent authority combined them with all that had been known previously, and all that was ascertained by later explorers up to the return of Captain Sverdrup from the second "Fram" expedition, so as to give the completest account ever attempted of the climate of the North Polar regions, and on this we rely mainly for the following summary.

Temperature.—From Professor Mohn's maps of the isotherms north of 60° N. it is evident that the temperature reduced to sea-level is lowest in the winter months within an area stretching across the pole from the interior of Greenland to the middle of

Siberia, the long axis of this very cold area being in the meridian of 40° W. and 140° E. For every month from October to April the mean temperature of this cold area is below 0° F., and in the two coldest months there are three very cold areas or poles of cold with temperatures below -40° arranged along the axis. These are the interior of Greenland, an area around the North Pole and the centre of Northern Siberia. Professor Mohn is satisfied that these three poles of cold are separated by somewhat warmer belts, as observations on the north coast of Greenland show a temperature higher both than the temperature of the interior reduced to sea-level and the temperature on the frozen sea farther north. As summer advances the temperature rises to the freezing point most rapidly in North America, the mean temperature for June, July and August for the American coast and the Arctic archipelago being above the freezing point. In July and August the Arctic shores in America, Asia and Europe have a mean air-temperature of about 40° F., but the interior of Greenland and the area round the North Pole remain below 32°, those two poles of cold persisting throughout the year while the winter cold pole in Asia disappears in summer.¹ There is no reason to doubt that in winter the Asiatic area is the coldest part of the Arctic region, and as it is permanently inhabited it is plain that low temperature alone is no bar to the wintering of expeditions in any part of the North Polar region. The lowest temperature experienced during the drift of the "Fram" was -62° F., on the 12th of March 1894 in lat. 79° 41', long. 134° 17' E. The minimum temperatures recorded on Sir George Nares's expedition were -73.8° F. on the "Alert" in 82° 27' N. and -70.8° on the "Discovery" in 81° 44' N., both in March 1876, and the minimum on Sverdrup's expedition in Jones Sound in 76° 50' N. was -60° F. in January 1901. In February 1882 Greely recorded -66.2° at Fort Conger, 81° 44' N., and at Fort Constance in Canada (66° 40' N. 119° W.) a temperature of -72° F. was noted in January 1851. The lowest temperature ever recorded on the earth's surface was probably that experienced at Verkhoyansk in Siberia (67° 34' N.) where the absolute minimum in the month of February was -93.6°, and minima of -70° or more have been recorded in every winter month from November to March inclusive, and as the absolute maximum in July was +92.7° F. the total range experienced is no less than 186.3°, far exceeding that known in any other part of the world.

The normal monthly mean temperatures for various parallels of latitude are given as follows by Professor Mohn, the last column showing the calculated conditions at the North Pole itself expressed to the nearest degree.

	Normal Air Temperature for Latitudes in °F.			
	65° N.	70° N.	80° N.	90° N.
January . . .	- 9.4	-15.3	-26.0	-42
February . . .	- 6.7	-14.5	-26.5	-42
March . . .	+ 3.0	- 8.3	-23.1	-31
April . . .	19.0	+ 6.8	- 8.9	-18
May . . .	34.7	24.1	+14.0	+ 9
June . . .	48.6	37.9	30.0	28
July . . .	54.7	45.0	35.6	30
August . . .	50.6	43.2	32.7	27
September . . .	40.7	32.5	18.1	9
October . . .	24.6	15.3	- 2.4	-11
November . . .	5.8	- 0.6	-11.0	-27
December . . .	- 5.1	-10.5	-19.1	-36
Year . . .	21.7	12.9	1.1	- 9

The interior of Greenland is believed to be below the normal temperature for the latitude in all months and so is the region between Bering Strait and the Pole; the Norwegian Sea, and the region north of it as far as the Pole, has a temperature above the normal for the latitude in all months; while the temperature

¹ It must be remembered that for cartographical purposes temperature is reduced to its value at sea-level, allowing for a change of 1° F. in about 300 ft. Thus the actual temperature on the snowcap of Greenland at the height of 9000 ft. is 30° F. lower at all seasons than is shown on an isothermal map, and that of Verkhoyansk (500 ft.) is only 1.5° F. lower than is charted.

in the northern continents is below the normal in winter and above the normal in summer.

The "Fram" observations showed that while the ordinary diurnal range of temperature prevailed for the months when the sun was above the horizon during some part of the day, there was also a diurnal range in the winter months when the sun did not appear, the minimum then occurring about 2 p.m. and the maximum about 1 a.m., the "day" being colder than the "night." Except in July and August the temperature was always found to be lower with the weaker winds and higher with the stronger winds irrespective of direction. Extraordinarily rapid variations of temperature have been observed in the winter months, on one occasion in February 1896 (north of 84° N.) the thermometer rising within 24 hours from -45.4° to +22.3° F., a rise of 67.7°.

Cloud and Precipitation.—The amount of cloud in the far north is greater in the daytime than at night, the summer months being cloudy, the winter very clear, and the amount is greater with the stronger winds and less with the weaker winds. Precipitation is most frequent in the summer months, the "Fram" results showing an average of 20 days per month from May to September; while from October to April the average was only 1½ days per month. Rain was only observed in the months from May to September; but snow occurs in every month and is most frequent in May and June, least frequent in November and December, which are the months of minimum precipitation. It has never been possible to make satisfactory measurements of the amount of precipitation in the Arctic regions on account of the drifting of snow with high wind. Fogs occur most frequently in July and August (20 or 16 days per month); they are practically unknown between November and April.

Pressure.—The "Fram" observations enabled Professor Mohn to revise and extend the isobaric maps of Dr Buchan, the correctness of which was strikingly confirmed. The Atlantic and Pacific low pressure areas are found at all seasons on the margin of the Arctic area, the position shifting a little in longitude from month to month. The two low pressures are separated in the winter months by a ridge of high pressure (exceeding 30.00 in.) stretching from the Canadian to the Siberian side between the North Pole and Bering Strait; this ridge has been termed by Professor Supan "the Arctic wind divide." In April the high pressure over Asia gives way and an intense low pressure area takes its place during the summer, uniting in August with the less intense low-pressure area which develops later over Canada, and reducing the Arctic high pressure area to an irregular belt extending from North Greenland to Franz Josef Land on the Atlantic side of the Pole. The general pressure over the polar area is much higher in winter than in summer and the gradients are steeper also in the cold weather, giving rise to stronger winds. The isobaric conditions indicate light variable winds in summer along the route of the "Fram" from the New Siberia Islands to the north of Spitsbergen, and in winter south-easterly or easterly winds of greater force; this is in accord with the observations made during the drift. Professor Mohn believes that the maximum pressure at the North Pole takes place in April, when it is about 30.08 in., and the minimum pressure from June to September, when it is about 29.88 in., the annual range of monthly mean pressure being thus only 0.20 in., so that the Pole may be said to be in a region of permanently high atmospheric pressure. Cyclonic depressions crossed the region of the "Fram's" track with considerable frequency, 73 being experienced in the three years, the frequency being greatest in winter but the wind velocity in cyclones greatest in summer; the most common direction of movement was from west to east. The average velocity of the cyclonic winds encountered by the "Fram" was only about 29 m. per hour, the highest 40 m. per hour, the portion of the Arctic Sea she crossed being much less stormy than the coasts of the Arctic lands, where winds have been recorded of far greater severity, e.g. 45 m. per hour in Spitsbergen in 1882, 55 m. per hour in Teplitz Bay, Franz Josef Land, in 1900, 62 m. per hour on the Siberian coast in the "Vega" in 1870, and as much as 90 m. per hour at Karmakul

in Novaya Zemlya in 1883. There seems little doubt that the interior of the polar area is a fair weather zone as compared with its margins, where the contrast of the seasons is most marked.

Flora.—The land flora of the Arctic regions, although necessarily confined to the lower levels which are free from snow for some time every year, and greatly reduced in luxuriance and number of species as compared with the flora of the temperate zone, is still in its own way both rich and varied, and it extends to the most northerly land known. In some of the fjords of western Greenland and also of Ellesmere Land almost on the 80th parallel the prevailing colour of the landscape in summer is due to vegetation and not to rock. The plants which occur on the margin of the Arctic Sea and in the polar islands represent the hardier species of the North European, Asiatic and American flora, the total number of species amounting to probably about a thousand phanerogams and a still larger number of cryptogams. The habit of all is lowly, but some grasses grow to a height of 1 ft. 6 in., and the mosses, of which the Eskimo make their lamp-wicks, frequently form cushions more than a foot in depth. Trees are absent north of 73° N., which is the extreme point reached in Siberia, or they are dwarfed to the height of shrubs as in southern Greenland, or farther north to that of the prevailing herbage. The flowers of many Arctic species of phanerogams have an intensely brilliant colour. The plains and lower slopes of the plateaux of Ellesmere Land and Heiberg Land and the plain of Peary Land north of Greenland are sufficiently clothed with vegetation to support large numbers of rodents and ruminants, the plants occurring not as occasional curiosities, but as the normal summer covering of the ground, playing their full part in the economy of nature. The cold of winter is not sufficient to put a stop to plant life even at the pole of cold in northern Siberia; and there is no reason to doubt that if there were islands close to the North Pole they would bear vegetation.

Fauna.—Animal life is comparatively abundant in the waters of the Arctic Sea, though the whalebone whale, *Balæna mysticetus*, has become almost extinct by reason of the energy with which its pursuit has been carried on. The white whale and narwhal still abound in the open waters as far north as ships can go. The walrus and several species of seal prey on the marine life, and the polar bear, the king of Arctic beasts, probably roams the whole surface of the frozen sea in pursuit of seals and the larger fish. The other Arctic carnivora include the Arctic fox and wolf, the latter attacking all the land mammals except the polar bear and old musk-oxen. The wild reindeer is still found in all the circum-polar lands except Franz Josef Land; but its range does not extend so far to the north as that of the typical ruminant of the polar lands, the musk-ox (*Ovibos moschatus*), which now abounds only in Peary Land, north Greenland and in the American Arctic Archipelago, though it was formerly circum-polar in its distribution. The Arctic hare is almost equally characteristic and more abundant, and the lemming probably more common still. The ermine and other valuable fur-bearing animals also occur. The animals are either permanently white like the polar bear, or change their coats with the season, being brown in summer and white in winter like the hares and lemmings. The birds of the Arctic regions are all migrants, retreating southward in winter but nesting in incredible numbers on the Arctic coast-lands, and in summer probably finding their way as individuals to every part. They are mainly sea-birds, though the snow bunting, the Arctic owl and other land birds are amongst the summer visitors. It must be remembered that the elevated plateaux of the interior of Greenland and of many of the large islands are totally devoid of life of every kind on account of their unchanging covering of snow and the intensely rigorous climate due to their great altitude.

Arctic People.—The conditions of life in the continental parts of the Arctic regions are extremely severe as regards temperature in the winter, but it has been found possible for civilized people to live permanently both in the extreme north of North

America and in the north of Siberia. In the north of Norway where the winter is mild on account of the warm south-westerly winds from the open Atlantic, organized communities dwell within the Arctic Circle in free communication with the south by telegraph, telephone, steamer, and in some cases by rail also, all the year round. The climate on the coast of Norway is scarcely less favourable in the north than in the south except for the absence of light in winter when the sun never rises, and the absence of darkness in summer when the sun never sets. If there were natural products of sufficient value permanent settlements might arise in any part of the Arctic regions where there is land free from snow in summer; but as a rule Arctic land is poor in mineral wealth and the pursuit of whales and seals requires only a summer visit. The original people of the farthest north of Europe are now represented by the Lapps, who lead a migratory life, depending mainly on fishing and on their herds of reindeer. Farther east their place is taken by the Samoyedes who live along the coast of the Kara Sea and the Yalmal Peninsula; they have also a small settlement in Novaya Zemlya. The Samoyedes, like the Lapps, live on the produce of the sea in summer and on their herds of reindeer, moving rapidly over the frozen country in winter by means of reindeer and dog sledges. Spitsbergen and Franz Josef Land appear never to have had native inhabitants. Along the coast of Siberia there is no continuous population, except in the land of the Chukchis in the extreme east between the Kolyma river and Bering Strait; but small settlements of many tribes of pagan hyperboreans occur here and there. North American Indian tribes wander far to the north of the Arctic Circle in Canada and Alaska, keeping their hereditary enemies the Eskimo to the coast and islands. The Eskimo of the American coast are intermingling not only with the American whalers but also with the Polynesians who come north as part of the crew of the whalers, and the pure race is tending to disappear. The traces of Eskimo encampments in the Polar archipelago, where no Eskimo now live, may mark a former wider range of hunting grounds, or a greater extension of the population. The Greenland Eskimo are the most typical and the best known of their race. A few hundred live on the east coast, where they were formerly much more numerous. The greater part of the west coast Eskimo are now civilized members of the Danish colonies, and it is stated that whereas in 1855 only about 30% of the population were half-breeds, the blending of the Eskimo and Europeans is now so complete that no full-blooded Eskimo remain in Danish Greenland. The tribe of Eskimo living to the north of Melville Bay, the glaciers of which separate them from the people of Danish Greenland, was first described by Sir John Ross, who called them Arctic Highlanders. They have been fully studied by Commander Peary, who succeeded in utilizing them in his great series of journeys, and to their aid he attributes the success of his method of Arctic travelling.

The Arctic Sea.

According to its geographical position, the Arctic Sea might be described as the sea situated north of the Arctic Circle; but according to its natural configuration, it is better defined as the gulf-like northern termination of the long and relatively narrow Atlantic arm of the ocean which extends north between Europe on one side and America on the other. By this situation as the northern end of a long arm of the ocean its physical conditions are to a very great extent determined. This Arctic gulf is bounded by the northern coasts of Europe, Siberia, North America, the American Arctic archipelago, Greenland and Iceland. Its entrance is the opening between Europe and Labrador divided by Iceland, Greenland and the American Arctic islands; and its natural southern boundary would be the submarine ridge extending from Scotland and the Shetland Islands through the Faeroe Islands and Iceland to Greenland, and continuing on the other side of Greenland across Davis Strait to Baffin Land. This ridge separates the depression of the Arctic Sea, filled with cold water at the bottom, from the deep depression of the North Atlantic. The Arctic Sea communicates

with the Pacific Ocean through Bering Strait, which is, however, only 49 m. broad and 27 fathoms deep. The area of the Arctic Sea may be estimated to be about 3,600,000 sq. m., of which nearly two-thirds (or 2,300,000 sq. m.) is continuously covered by floating ice.

The Arctic Sea may be divided into the following parts: (1) The *North Polar Basin* (including the Siberian Sea), bounded by the northern coasts of Siberia (from Bering Strait to the western Taimyr Peninsula), Franz Josef Land, Spitsbergen, Greenland, Grinnell Land, Axel Heiberg Land, Ringnes Land, the Parry Islands and Alaska; (2) the *Kara Sea*, between Novaya Zemlya and the Siberian coast, south of a line from the north point of the former to Lonely Island (Ensohmeden) and Norden-skiöld Island; (3) the *Barents and Murman Sea*, bounded by Novaya Zemlya, Franz Josef Land, Spitsbergen, Bear Island and the northern coasts of Norway and Russia; (4) the *Norwegian Sea*, between Norway, Spitsbergen, Jan Mayen, Iceland and the Faeroes; (5) the *Greenland Sea*, between Spitsbergen, Jan Mayen, Iceland and Greenland; (6) *Baffin Bay and Davis Strait*, between Greenland, Ellesmere Land, North Devon and Baffin Land.

Depths.—The Arctic Sea forms an extended depression separating the two largest continental masses of the world—the European-Asiatic (Eurasia) and America. Along its centre this depression is deep, but around its whole margin, on both sides, it is unusually shallow—a shallow submarine plateau or drowned plain extending northward from both continents, forming the largest known continental shelf. North of Europe this shelf may be considered as reaching Spitsbergen and Franz Josef Land, extending over more than 10 degrees of latitude, although there is a somewhat deeper depression in between. North of Spitsbergen it reaches beyond 81° N., and north of Franz Josef Land probably somewhat north of 82° N. North of Siberia the shelf is 350 m. broad, or more, with depths of 50 to 80 fathoms, or less. In longitude 135° E. it reaches nearly 70° N., where the bottom suddenly sinks to form a deep sea with depths of 2000 fathoms or more. Farther east it probably has a similar northward extension. North of America and Greenland the shelf extends to about latitude 84° N. This shelf, or drowned plain, evidently marks an old extension of the continents, and its northern edge must be considered as the real margin of their masses, the coasts of which have probably been overflowed by the sea at some comparatively recent geological period. On this submarine plateau the Arctic lands are situated—Spitsbergen (with Seven Islands to the north, Bear Island and Hope Island to the south), Franz Josef Land, Novaya Zemlya, Lonely Island, the New Siberia Islands, Wrangel Island, the American Arctic archipelago. The depth of the shelf is, especially north of Siberia, very uniform, and usually not more than 50 to 80 fathoms. North of Europe it is intersected by a submarine fjord-like depression, or broad channel, extending eastward from the Norwegian Sea. Between Norway and Bear Island this depression is about 240 fathoms deep, and between Novaya Zemlya and Franz Josef Land 100 to 150 fathoms deep. It gives off several submerged fjords or channels towards the south-east into the shallow Murman Sea, e.g. one channel, more than 100 fathoms deep, along the Murman coast towards the entrance of the White Sea; another narrow channel, in parts 100 fathoms deep, along the south-west coast of Novaya Zemlya through Kara Strait. It also extends into the Kara Sea, rounding the north point of Novaya Zemlya and forming a narrow channel along its eastern coast. On the American side similar but much narrower submarine depressions, which may be called submarine fjords, extend from Baffin Bay into the continental shelf, northward through Smith Sound, Kane Basin and Kennedy Channel, and westward through Lancaster Sound. The greatest depths in the Arctic Sea have been found in the North Polar Basin, where depths of 2100 fathoms, in about 81° N. and 130° E., have been measured with certainty. It is deeper than 1650 fathoms along the whole route of the "Fram," from about 79° N. and 138° E. to near Spitsbergen. In 84½° N. and about 75° E. the depth is 2000 fathoms,

and in 83° N. and 13° E. it is 1860 fathoms. The northern and eastern extension of this deep basin is not known. Commander Peary reports a depth of 1500 fathoms with no bottom at 5 sea miles from the Pole (about 80° 55' N.), where he tried to obtain a sounding. It was formerly believed that still greater depths existed west of Spitsbergen, in the so-called Swedish deep, where 2600 fathoms had been sounded, but the Nathorst expedition in 1898 found no greater depths there than about 1700 fathoms. The Norwegian Sea, farther south, is 2000 fathoms deep midway between Iceland and Norway, in about 68° N. This so-called Norwegian deep is, as before stated, separated from the North Atlantic Basin by the Wyville Thomson ridge and the Faeroe-Iceland ridge. Farther north there is a low transverse ridge extending eastwards from Jan Mayen, in about 72° N., which is about 1300 fathoms deep. North of this the sea is again deeper—1985 fathoms in 75° N. From the north-west corner of Spitsbergen a submarine ridge extends in a north-westerly direction, with depths of about 430 fathoms in 81° N. and about 4° E. How far this ridge extends is unknown, but there is a probability that it reaches Greenland, and thus separates the Swedish and the Norwegian deep from the deep depression of the North Polar Basin. Baffin Bay forms, probably, a relatively deep basin of about 1000 or 1200 fathoms, which is separated from the West Atlantic Basin by the shallow submarine ridge from Greenland to Baffin Land in about 65° or 66° N.

The deposit composing the bottom of the Arctic Sea contains in its northern part, in the North Polar Basin, extremely little matter of organic origin. It is formed mainly of mineral material, sandy clay of very fine grain, to an extent which is hardly found in any other part of the ocean with similar depths. It contains only from 1 to 4% of carbonate of lime. Farther south, in the sea between Spitsbergen and Greenland, the amount of carbonate of lime gradually increases owing to the shells of foraminifera (especially bicolocinae); west of Spitsbergen the proportion rises to above 20 or even 30%, while in the direction of Greenland it is considerably lower.

The circulation of the Arctic Sea may be explained firstly by the vertical and horizontal distribution of temperature and salinity (i.e. density); secondly, by the influence of the winds, especially on the ice-covered surface. The currents in this sea may to some extent be considered as convection currents, caused by the cooling of the water near the surface, which becomes heavier, sinks, and must be replaced on the surface by warmer water coming from the south, which is also influenced by the prevailing winds. On account of the rotation of the earth the northward-running water on the surface, as well as the sinking water, will be driven in a north-easterly or easterly direction, while the southward-flowing water along the bottom, as well as the rising water, is driven south-west or westward. This very simple circulation, however, is to a great extent complicated on the one hand by the irregular configuration of the sea-bottom, especially the transverse submarine ridges—e.g. the Spitsbergen ridge, the Jan Mayen ridge, and the Scotland-Faeroe-Iceland ridge; and on the other hand by the circumstance that the upper water strata of the sea are comparatively light in spite of their low temperature. These strata, about 100 or 150 fathoms thick, are diluted by the addition of fresh water from the North European, Siberian, Canadian and Alaskan rivers, as well as by precipitation, while at the same time the evaporation from the surface of the mostly ice-covered sea is insignificant. The light surface strata will have a tendency to spread over the heavier water farther south, and thus the polar surface currents running southward along the east coasts of Greenland, Baffin Land and Labrador are formed, owing their westerly course to the rotation of the earth. These currents are certainly to a great extent helped and increased by the prevailing winds of the region. The winds get a firm hold on the rough surface of the floating ice, which, with its deep hummocks and ridges, gets a good grip of the water, transferring the movement of the surface immediately down to at least 5 or 10 fathoms.

The chief currents running into the Arctic Sea are the following—

1. The *Gulf Stream*, or Atlantic drift, passing north-eastward over the Scotland-Faeroe-Iceland ridge, along the west coast of Norway, with one arm branching off eastward round the North Cape into the Barents Sea, and another branch running northward along the margin of the shelf between Norway, Bear Island and Spitsbergen, passing as a very narrow current along the west coast of the latter, over the Spitsbergen ridge (at its north-west corner), and into the North Polar Basin, where it flows gradually northward and eastward (on account of the rotation of the earth) below the cold but lighter layer, 100 fathoms thick, of polar water, and fills the whole basin below 100 or 120 fathoms to the bottom with Atlantic water.

2. The *Irminger Current*, running north along the west coast of Iceland. One part branches off westward and southward again in Denmark Strait, following the Greenland Polar Current, while another smaller part runs northward, eastward and south-eastward to the north and east of Iceland.

3. An Atlantic current runs northward along the west coast of Greenland, passes the ridge across Davis Strait, and flows into Baffin Bay, forming it deeper strata below the polar water in a similar way to the Gulf Stream in the North Polar Basin. There is a possibility that some slight portion of this current even reaches the latter along the bottom of the deep channel through Smith Sound.

4. A small current running northward into the North Polar Basin through Bering Strait.

The Arctic Sea receives also a contribution of fresh water from the rivers of northern Europe, Siberia and America, as well as from the glaciers of Greenland and the precipitation over the whole area of the sea itself.

The chief currents running out of the Arctic Sea are: (1) The Greenland Polar Current, running southward along the east coast of Greenland, and dividing into two branches north of Iceland—(a) the east Greenland branch, passing south through Denmark Strait and rounding Cape Farewell; (b) the east Iceland branch, running south-eastward between Iceland and Jan Mayen, towards the Faeroes. It seems as if only a small portion of this current actually passes the Faeroe-Iceland ridge and reaches the Atlantic Ocean. The greater part is partly mixed with the water of the Gulf Stream and is turned by the latter in a north-easterly direction, forming a kind of eddy or vortex movement in the southern Norwegian Sea. (2) The Labrador Polar Current, formed by the water running south through Smith Sound, Lancaster Sound and Jones Sound, as well as water from Baffin Bay, and also from the east Greenland current rounding Cape Farewell and crossing Davis Strait. (3) Along the south-east coast of Spitsbergen a polar current also passes in a south-westerly or westerly direction past South Cape, where it meets the Gulf Stream. (4) A small current probably also runs out along the western side of Bering Strait.

Temperature and Salinity.—While the temperature is comparatively uniform, with small variations, the difference in salinity between the upper and lower strata is greater than in most other parts of the ocean. In the North Polar Basin the vertical distribution of temperature as well as salinity is very much the same in all places examined. Near the surface, from 0 down to 100 fathoms, the water is below the freezing point of fresh water—with a minimum of between 28.7° (−1.8° C.) and 28.6° (−1.9° C.) at a depth of about 30 fathoms—and is much diluted with fresh water (see above), the salinity gradually increasing downward from about 29 or 30 per mille near the surface to nearly 35 per mille in 100 fathoms. Below 100 fathoms the temperature as well as the salinity gradually increases, until they approach their maximum in about 160 or 200 fathoms, where the temperature varies between 32.5° (0.3° C.), north of the New Siberia Islands, and about 33.8° (1° C.) north of Franz Josef Land; and the salinity is about 35.1 per mille. From this depth the temperature gradually sinks downward; 32° (0° C.) is found at about 400 fathoms in the western part of the basin—e.g. between about 84° N. 15° E. and 85½° N. 58° E., while it is found in about 400 fathoms farther east—e.g. in 81½° N. and 123° E. In depths between 1400 and 1600 fathoms the temperature has a second minimum between 30.6° (−0.8° C.) and 30.4° (−0.9° C.), below which depth the temperature again rises slowly, a few tenths of a degree towards the bottom. In all depths below 200 fathoms the salinity of the water remains very much the same, about 35.1 per mille, with very slight variations. This comparatively warm and saline water evidently originates from the branch of the Gulf Stream passing north across the submarine ridge from north-west Spitsbergen. The vertical distribution of temperature and salinity is very much the same,

summer and winter, throughout the North Polar Basin, except near the surface, which in summer is covered by a layer of fresh water arising from the melting of the snow-covered surface of the floe-ice. This fresh-water layer may attain a thickness of 5 or 6 ft. between the floes. North of the Siberian coast the sea is, during summer, covered with a layer of warm water from the Siberian rivers, and the temperature of the surface may rise to several degrees above freezing-point.

In the Norwegian and Greenland Seas there are greater variations of temperature. Below a certain limit, which in the northern part (on the eastern side) is about 550 fathoms deep, and in the southern part between 300 and 400 fathoms deep, the whole basin of this sea is filled with water which has an unusually uniform salinity of about 34.92 per mille, and the temperature of which is below zero centigrade, gradually sinking downward from the above-mentioned limit, where it is 32° (0° C.); and down to 29.8° (-1.2° C.) or 29.6° (-1.3° C.) near the bottom in 1400 or 1600 fathoms. This cold underlying water of such a remarkably uniform and comparatively low salinity is formed chiefly in a small area between Jan Mayen and Spitsbergen, by the formation of ice and cooling down of the Atlantic surface water by radiation of heat during the winter. In this manner the surface water becomes heavier than the underlying water and gradually sinks to the bottom. This water seems to be distinctly different from the hitherto known water filling the deep of the North Polar Basin, as it has a lower salinity and lower temperature; the known bottom temperature of the North Polar Basin being between 30.7° (-0.7° C.) and 30.4° (-0.9° C.), and the salinity about 35.1 per mille. This fact seems to indicate that there can be no direct communication between the deep depression of the North Polar Basin and the Norwegian-Greenland Sea, which are probably separated by a submarine ridge running from the north-west corner of Spitsbergen to Greenland.

The above-mentioned layer of uniform cold water of the Norwegian-Greenland Sea is, along its eastern side, covered by the warm and saline water of the Gulf Stream flowing northward along the west coast of Norway, Bear Island and Spitsbergen, and forming the upper strata of the sea about 300 to 500 fathoms deep. The maximum temperature of this water is on the surface about 46° (8° C.) to 50° (10° C.) west of northern Norway, and about 37° (5° C.) to 39° (4° C.) west of Spitsbergen. The salinity is generally between 35.0 and 35.3 per mille.

Along the western side of this sea, towards the east coast of Greenland, the underlying cold water is covered by the less saline water of the polar current, which in the upper strata of the sea, from the surface down to about 100 fathoms, has very much the same temperature and salinity as in the upper cold and less saline strata of the North Polar Basin. Near the east coast of Greenland, a layer of comparatively warm and saline water, with a temperature of 32.7° (0.4° C.) and a salinity of 35.2 per mille, has been found (by the Ryder expedition in 1891) below the cold and lighter polar water in a depth of 70 to 90 fathoms. This warmer undercurrent is a continuation of the warm Spitsbergen current sending off a branch westward from Spitsbergen, and thus forming a great vortex movement in the Spitsbergen-Greenland Sea similar to the one mentioned farther south in the Norwegian Sea.

In *Barents Sea* the temperature and salinity are highest in the western part near Norway or between Norway and Bear Island, where the eastern branch of the Gulf Stream enters and where in summer the salinity generally is between 34.8 and 35 per mille from the surface down to the bottom, and the surface temperature generally is about 41° or 43° (5° C. or 6° C.), and the bottom temperature is above zero centigrade. The eastern part of Barents Sea is filled with water of a little lower salinity, the deeper strata of which are very cold, with temperature even as low as 28.9° (-1.7° C.), but often with salinity above 35.0 per mille. This cold and saline water is formed during the formation of ice on the sea-surface. The bottom temperature is everywhere in the eastern part below zero centigrade and generally below -1° C.

The *Kara Sea* is covered near the surface with a layer of cold

water much diluted by the fresh water from the Siberian rivers, especially the Ob and the Yenisei. The salinity varies between 29 and 34 per mille; near the mouth of the rivers it is naturally much lower.

The vertical distribution of temperature and salinity in *Baffin Bay* seems to be very similar to that of the North Polar Basin, with a cold but less saline upper stratum of water—with a minimum temperature of about 28.9° (-1.7° C.)—and a warmer and more saline deeper stratum from 100 to 200 fathoms downwards, with a maximum temperature of 33.6° (0.9° C.) in about 200 fathoms, and the temperature slowly decreasing towards the bottom.

Arctic Ice.—As before mentioned, at least two-thirds of the Arctic Sea is constantly covered by drifting ice. This ice is mostly formed on the surface of the sea itself by freezing, the so-called floe-ice or sea-ice. A small part is also river-ice, formed on the rivers, especially those of Siberia, and carried into the sea during the spring or summer. Another comparatively small part of the ice originates from the glaciers of the Arctic lands. These pieces of glacier-ice or icebergs are, as a rule, easily distinguished from the floe-ice by their size and structure. They occur almost exclusively in the seas round Greenland, where they originate from the glaciers descending into the sea from the inland ice of Greenland. Some small icebergs are also formed in Franz Josef Land, Spitsbergen, Novaya Zemlya, Grinnell Land, &c., but they are comparatively insignificant, and are not as a rule carried far from the coasts. Sea-ice or floe-ice is formed during the autumn, winter and spring, especially in the North Polar Basin, but also in the Kara Sea, the greater part of Barents Sea, the northernmost part of the Norwegian Sea (near Bear Island and towards Jan Mayen), Greenland Sea and Baffin Bay. The floe-ice does not, as a rule, grow thicker than 7 or 8 ft. in one year, but when it floats in the water for some years it may attain a thickness of 16 ft. or more directly by freezing. By the constant upheaval from pressure much greater thicknesses are attained in the piled-up hummocks and rubble which may be 20 to 30 ft. high above the water when floating. During the summer the floe-ice decreases again by melting partly on the surface owing to the direct radiation of heat from the sun, partly on the under side owing to the higher temperature of the water in which it floats. The first kind of melting is that which prevails in the North Polar Basin, which the second occurs in more southern latitudes. The floe-ice is constantly more or less in movement, carried by winds and currents. The changing wind, and also to a great extent the changing tidal current, causes diverging movements in the ice by breaking it into larger or smaller floes. When the floes separate, lanes and channels are formed; when they meet, ice-pressures arise, and the floes are piled up to form hummocks or ridges, and thus the uneven polar ice arises. In the North Polar Basin the floe-ice is slowly carried by the prevailing winds and the currents in an average direction from Bering Strait and the New Siberia Islands, north of Franz Josef Land and Spitsbergen, near the North Pole, towards the Greenland Sea and southward along the east coast of Greenland. Such a drift of an ice-floe from the sea north of Bering Strait to the east coast of Greenland probably takes, as a rule, four or five years, and the floes found in this part of the sea are not, therefore, generally older. What the drift of the ice is on the American side of the North Polar Basin is still little known. But there it is probably more or less blocked up in its southward movement by the islands of the American Arctic archipelago, and the ice-floes may thus grow very old and thick. Commander Peary found a strong easterly movement of the floes in the region north of Grant Land in 1907. The southward distribution of the drifting floe-ice (the pack ice) in Barents Sea, Norwegian-Greenland Sea and Davis Strait may differ much from one year to another, and these variations are evidently due to more or less periodical variations in the currents and also in the directions of the prevailing winds. In most places the ice has its most southerly distribution during the late winter and spring, while the late summer and autumn (end of August and September) is the most open season.

Biological Conditions.—The development of organic life is comparatively poor in those parts of the Arctic Sea which are continuously covered by ice. This is, amongst other things, proved by the bottom deposits, which contain exceptionally little carbonate of lime of organic origin. The reason is evidently that the thick ice prevents to a great extent the development of plant life on the surface of the sea by absorbing the light, and as the plant life forms the base for the development of animal life, this has also very unfavourable conditions. The result is that—e.g. in the interior of the North Polar Basin—there is exceptionally little plant life in the sea under the ice-covering, and the animal life both near the surface and in deeper strata is very poor in individuals, whilst it is comparatively rich in species. Near the outskirts of the Arctic Sea, where the sea is more or less open during the greater part of the year, the pelagic plant life as well as animal life is unusually rich, and, especially during the early summer, there is often here such a development of plankton (*i.e.* pelagic life) on the sea-surface as is hardly found in any other part of the ocean. It seems as if the polar water is specially favourable for the development of pelagic plant life, which makes the flora, and consequently also the fauna, flourish as soon as the ice-covering disappears and the water surface is exposed to the full sunlight of the long Arctic day. At the same time the temperature of the water rises, and thus the conditions for the chemical changes of matter and nutritive assimilation are much improved. The Arctic Sea, more especially the North Polar Basin, might thus be considered as a lung or reservoir in the circulation of the ocean where the water produces very little life, and thus, as it were, gets time to rest and accumulate those substances necessary for organic life, which are everywhere present only in quite minimal quantities. It is also a remarkable fact of interest in this connexion that the greatest fisheries of the world seem to be limited to places where waters from the Arctic Ocean and from more southern seas meet—e.g. Newfoundland, Iceland, Lofoten and Finnmarken in Norway.

The mammalian life is also exceptionally rich in individuals along the outskirts of the Arctic Sea. We meet in those waters, especially along the margin of the drifting ice, enormous quantities of seals of various kinds, as well as whales, which live on the plankton and the fishes in the water. A similar development of mammalian life is not met with anywhere else in the ocean, except perhaps in the Antarctic Ocean and Bering Sea, where, however, similar conditions are present. In the interior of the Arctic Sea or the North Polar Basin mammalian life is very poor, and consists mostly of some straggling polar bears which probably occasionally wander everywhere over the whole expanse of ice; some seals, especially *Phoca foetida*, which has been seen as far north as between 84° and 85° N.; and a few whales, especially the narwhal, which has been seen in about 85° N.

The bird life is also exceptionally rich on the outskirts of the Arctic Sea, and the coasts of most Arctic lands are every summer inhabited by millions of sea-birds, forming great colonies almost on every rock. These birds are also dependent for their living on the rich plankton of the surface of the sea. In the interior of the Arctic Sea the bird life is very poor, but straggling sea-birds may probably be met with occasionally everywhere, during summer-time, over the whole North Polar Basin.

BIBLIOGRAPHY.—For very full references to polar exploration see A. W. Greely, *Handbook of Polar Discovery* (4th ed., London and New York, 1910), and for a nearly complete bibliography of earlier polar literature see J. Chavanne and others, *The Literature of the Arctic Regions* (Vienna, 1878). W. Scoresby, *An Account of the Arctic Regions* (2 vols., Edinburgh, 1820); W. E. Parry, *Attempt to reach the North Pole* (London, 1828); S. Osborn, *The Discovery of the North-West Passage* (London, 1857); M. Clatock, *A Narrative of the Discovery of the Fate of Sir John Franklin*, &c. (London, 1859); G. S. Nares, *Voyage to the Polar Sea, 1875-1876* (2 vols., London, 1878); A. H. Markham, *The Great Frozen Sea* (London, 1878, &c.); J. Richardson, *The Polar Regions* (Edinburgh, 1861); A. v. Middendorff, "Der Golfstrom ostwärts vom Nordkap," *Petermanns Mitteilungen* (Gotha, 1871); A. Petermann, "Die Erschliessung eines Theiles des nördlichen Eismeres . . . im Karischen Meere, 1870," *Petermanns Mitteilungen* (1871); and numerous other papers in the same periodical; C. R. Markham, *The Threshold of the Unknown Region* (London, 1873); *Die zweite deutsche Nordpolfahrt*

unter Führung des Capt. K. Koldewey (2 vols., Leipzig, 1873-1874); *Manual of the Natural History, Geology, and Physics of Greenland and the neighbouring Regions*, published by the Admiralty (London, 1875); *Arctic Geology and Ethnology*, published by the Royal Geographical Society (London, 1875); C. Weyprecht, *Die Metamorphosen des Polareises* (Vienna, 1879); papers on the results of the Austro-Hungarian Expedition, 1872-1874, in *Petermanns Mitteilungen* (1875, and especially 1878); J. Payer, *New Lands within the Arctic Circle* (2 vols., London, 1876); E. Besocke, *Scientific Results of the U.S. Arctic Expedition, C. F. Hall commanding*, vol. I. (Washington, 1874); *Die amerikanische Nordpol-Expedition* (Leipzig, 1879); *The Norwegian North Atlantic Expedition, 1876-1878*, especially: H. Mohn, "The North Ocean: its Depths, Temperature and Circulation" (Christiania, 1887); and "Chemistry," by H. Torndal and L. Schmeelck (Christiania, 1886, 1882); A. E. Nordenskiöld, *The Voyage of the "Vega"* (London, 1881); several reports on the six voyages of the "Willem Barrens" in the summers of 1878 to 1883, published in Dutch (Amsterdam and Haarlem, 1879-1887); De Long, *The Voyage of the "Jeannette"; the Ship and Ice Journals of George W. De Long* (2 vols., London, 1883); Otto Pettersson, "Contributions to the Hydrography of the Siberian Sea," in *Vägo-Expeditionens vetenskapliga Iakttagelser*, vol. 2. (Stockholm, 1883); Axel Hamberg, "Hydrografisk Kerniska Iakttagelser under den svenska Expeditionen till Grönland, 1883," *Bihang till k. svenska vet.-akad. Handlingar*, vol. ix. No. 16 and vol. x. No. 13 (Stockholm, 1884 and 1885); O. Krümmel, *Handbuch der Ozeanographie* (2 vols., Stuttgart; 2nd ed., 1907, &c.); C. Ryder, "Den Ostgrönlandske Expedition," *Meddelelser om Grønland*, pt. xvii. (Copenhagen, 1895); *Isforholdene i Nordisøet 1877-1892*, with 10 charts (Copenhagen, 1896); O. Pettersson and G. Ekman, "Die hydrographischen Verhältnisse der obersten Wasserschichten des nördlichen Nordmeeres zwischen Spitzbergen, Grönland und der norwegischen Küste in den Jahren 1896 und 1897," *Bihang till k. svenska vet.-akad. handlingar*, vol. xxxi. pt. 2. No. 4; *The Danish Inghoff Expedition*; see especially M. Knudsen, "Hydrography," in vol. I. (Copenhagen, 1899); F. Nansen, *Ferðir Norð* (2 vols., London, 1897); *The Norwegian North Polar Expedition, 1893-1896. Scientific Results*; see especially F. Nansen, "The Oceanography of the North Polar Basin," in vol. ii. No. 9; "Some Results of the Norwegian Arctic Expedition, 1893-1896," *Geographical Journal* (London, May 1897). By V. Garde and others there are, since 1895, yearly reports with charts of the state of the ice of the Arctic seas, in the *Nautical-Meteorological Annual of the Danish Meteorological Institute* (Copenhagen). Several Russian papers in various Russian periodicals, e.g. N. Knipovitch, "Material concerning the Hydrology of the White Sea and the Murman Sea," *Bulletin de l'Académie imp. des sciences de St Pétersbourg* (October 1897); Prince B. Galitzin, "On the Extension of the Gulf Stream in the Arctic Ocean," *ibid.* (November 1898, both in Russian), &c.; N. Knipovitch, "Hydrologische Untersuchungen im europäischen Eismeer," *Ann. d. Hydr. u. marit. Meteorol.* (1905); Filip Akerblom, "Recherches océanographiques. Expedition de M. G. Nathorst en 1899," *Uppsala Universitets Årsskrift* (1903). *Math. och Naturvetenskap II.* (Uppsala, 1904); Axel Hamberg, "Hydrographische Arbeiten der von A. G. Nathorst geleiteten schwedischen Polarexpedition 1898," *Kongl. svenska vet.-akad. Handlingar*, vol. xli. No. 1 (Stockholm, 1906); F. Nansen, "Northern Waters," *Videnskabs Selskabets Skrifter*, vol. i. No. 3 (Christiania, 1906); B. Helland-Hansen and F. Nansen, "The Norwegian Sea," *Report on Norwegian Fishery and Marine Investigations*, vol. 2. No. 2 (Bergen, 1909); Duc d'Orléans, *Croisière océanographique dans la Mer du Groenland en 1905* (Brussels, 1909); see especially B. Helland-Hansen and E. Koelcoed, *Hydrographie*.

ANTARCTIC REGION

History of Antarctic Exploration.—Although the Antarctic region was not reached by the first explorer until the Arctic region had been for centuries a resort of adventurers, the south polar region was really the more direct outcome of the main stream of geographical exploration. It was early understood by the Greek geographers that the known world covered only a small portion of the northern hemisphere and that the whole southern hemisphere awaited exploration, with its torrid, temperate and frigid zones repeating the climatic regions familiar in the northern hemisphere, the habitable land of the south temperate zone being separated from the known world by the practically impassable belt of the torrid zone. During the middle ages the sphericity of the earth came to be viewed as contrary to Scripture and was generally discredited, and it was not until Prince Henry the Navigator began in 1418 to encourage the penetration of the torrid zone in the effort to reach India by circumnavigating Africa that the exploration of the southern hemisphere began. The doubling of the Cape of Good Hope in

1487 by Bartholomew Diaz first brought explorers within touch of the Antarctic cold, and proved that the ocean separated Africa from any Antarctic land that might exist. The passage of Magellan's Strait in 1520 showed that America and Asia also were separated from the Antarctic continent, which was then believed to extend from Tierra del Fuego southward. The doubling of Cape Horn by Drake in 1578 proved that the Tierra del Fuego archipelago was of small extent and that any continent

ever died a harder death. It is not to the purpose here to describe in detail how Schouten and Le Maire rediscovered the southern extremity of Tierra del Fuego and named Cape Horn in 1615, how Quiros in 1606 took possession for the king of Spain of all the lands he had discovered in Australia del Espiritu Santo (the New Hebrides) and those he would discover "even to the Pole," or how Tasman in 1642 showed that New Holland (Australia) was separated by sea from any continuous southern continent.

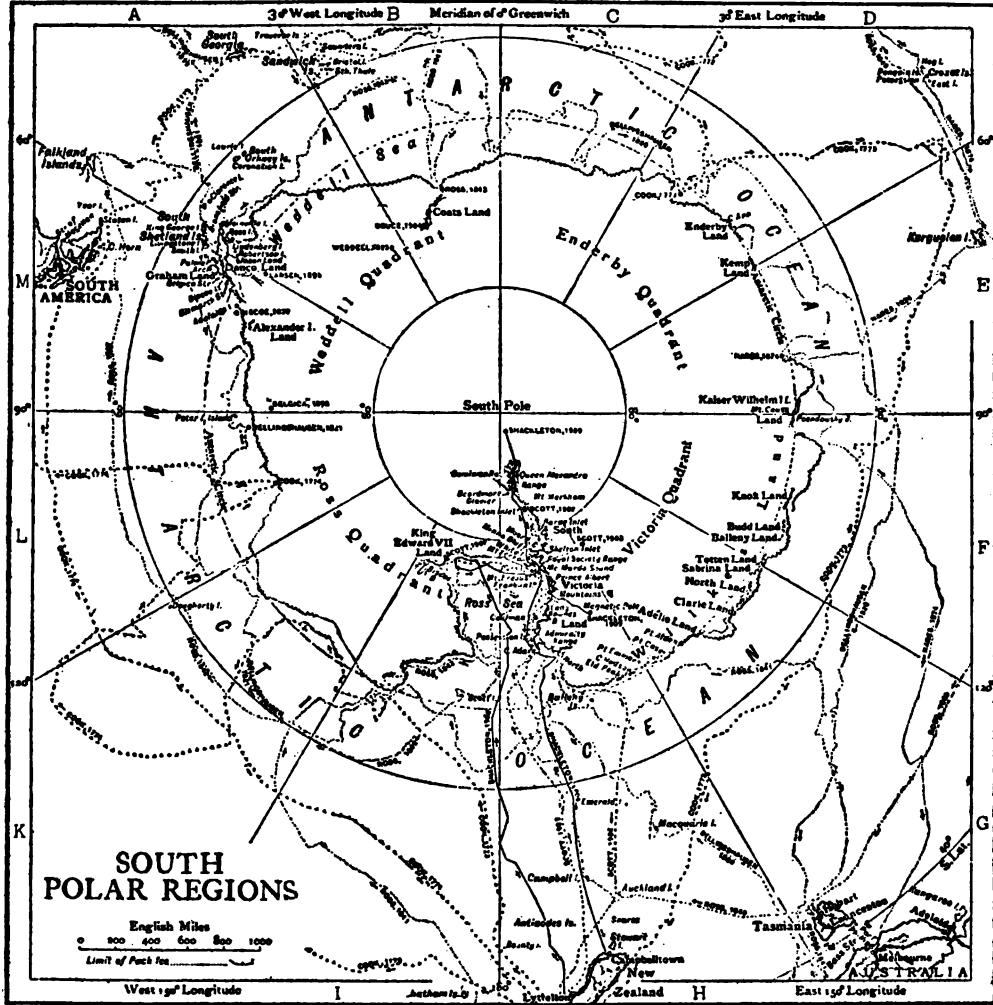

which lay to the south must be within the region of perpetual winter. Before this, however, vague reports of land to the south of the Malay archipelago had led European geographers to connect on their globes the coast of Tierra del Fuego with the coast of New Guinea, and allowing their imaginations to run riot in the vast unknown spaces of the south Atlantic, south Indian and Pacific oceans, they sketched the outlines of a vast continent stretching in parts into the tropics. The search for this great south land or Third World was a leading motive of explorers in the 16th and the early part of the 17th centuries, and no illusion

Voyagers round the Horn frequently met with contrary winds and were driven southward into snowy skies and ice-encumbered seas; but so far as can be ascertained none of them before 1770 reached the Antarctic circle, or knew it, if they did. The story of the discovery of land in 64° S. by Dirk Gerritsz on board the "Blijde Boedschap" in 1599 has recently been shown to be the result of the mistake of a commentator, Kasper Barlaeus, in 1622. Much controversy has arisen as to whether South Georgia was sighted in 1675 by La Roche, but the point is of no importance in the development of the history of exploration. It may

safely be said that all the navigators who fell in with the southern ice up to 1750 did so by being driven off their course and not of set purpose. An exception may perhaps be made in favour of Halley's voyage in H.M.S. "Paramour" for magnetic investigations in the South Atlantic when he met the ice in 52° S. in January 1700; but that latitude was his farthest south. A determined effort on the part of the French naval officer Pierre Bouvet to discover the South Land described by a half legendary sieur de Conneville resulted only in the discovery of Bouvet Island in 54° 10' S., and in the navigation of 48 degrees of longitude of ice-cumbered sea nearly in 55° S. in 1739. In 1771 Yves Joseph Kerguelen sailed from France with instructions to proceed south from Mauritius in search of "a very large continent." He lighted upon a land in 50° S. which he called South France, and believed to be the central mass of the southern continent. He was sent out again to complete the exploration of the new land, and found it to be only an inhospitable island which he named in disgust the Isle of Desolation, but in which posterity has recognized his courageous efforts by naming it Kerguelen Land. The obsession of the undiscovered continent culminated in the brain of Alexander Dalrymple, the brilliant and erratic hydrographer who was nominated by the Royal Society to command the Transit of Venus expedition to Tahiti in 1769, a post he coveted less for its astronomical interest than for the opportunity it would afford him of confirming the truthfulness of his favourite explorer Quiros. The command of the expedition was given by the admiralty to Captain James Cook, whose geographical results were criticized by Dalrymple with a force and persistence which probably had some weight in deciding the admiralty to send Cook out again with explicit instructions to solve the problem of the southern continent.

Sailing in 1772 with the "Resolution," a vessel of 462 tons under his own command and the "Adventure" of 336 tons under Captain Tobias Furneaux, Cook first searched in vain for Bouvet Island, then sailed for 20 degrees of longitude to the westward in latitude 58° S., and then 30° eastward for the most part south of 60° S. a higher southern latitude than had ever been voluntarily entered before by any vessel. On the 17th of January 1773 the Antarctic Circle was crossed for the first time in history and the two ships reached 67° 15' S. in 30° 35' E., where their course was stopped by ice. There Cook turned northward to look for South France, of the discovery of which he had received news at Cape Town, but from the rough determination of his longitude by Kerguelen, Cook reached the assigned latitude 10° too far east and did not see it. He turned south again and was stopped by ice in 61° 52' S. and 95° E. and continued eastward nearly on the parallel of 60° S. to 147° E. where on March 16th the approaching winter drove him northward for rest to New Zealand and the tropical islands of the Pacific. In November 1773 Cook left New Zealand, having parted company with the "Adventure," and reached 60° S. in 177° W., whence he sailed eastward keeping as far south as the floating ice allowed. The Antarctic Circle was crossed on the 20th of December and Cook remained south of it for three days, being compelled after reaching 61° 31' S. to stand north again in 135° W. A long detour to 47° 50' S. served to show that there was no land connexion between New Zealand and Tierra del Fuego, and turning south again Cook crossed the Antarctic circle for the third time in 109° 30' W., and four days later his progress was blocked by ice in 71° 10' S., 106° 54' W. This point, reached on the 30th of January 1774, was the farthest south attained in the 18th century. With a great detour to the east, almost to the coast of South America, the expedition regained Tahiti for refreshment. In November 1774 Cook started from New Zealand and crossed the South Pacific without sighting land between 53° and 57° S. to Tierra del Fuego, then passing Cape Horn on the 29th of December he discovered the Isle of Georgia and Sandwich Land, the only ice-clad land he had seen, and crossed the South Atlantic to the Cape of Good Hope between 55° and 60° S., thereby wiping out Dalrymple's continent from all the oceans and laying open the way for future Antarctic exploration by exploding the myth of a

habitable southern continent. Cook's most southerly discovery of land lay on the temperate side of the 60th parallel, and he convinced himself that if land lay farther south it was practically inaccessible and of no economic value.

Soon after Cook's return sealers set out on voyages to South Georgia both from England and America, but no clear account of the southern limits of their voyages before the Sealers year 1819 can now be obtained. In February of that year William Smith of the brig "Williams" trading between Monte Video and Valparaiso, rounding the Horn with a wide sweep to the south, saw land in 62° 40' S. Repeating the voyage in October he saw the land distinctly, and named it New South Shetland. The "Williams" was chartered by the British naval commander on the Pacific station, and in 1820 Edward Bransfield, master R.N., surveyed the group and went as far as 64° 30' among the islands. Meanwhile American sealers from Stonington, Connecticut, had begun operations on the newly discovered land, and one of these, Nathaniel B. Palmer, discovered the mountainous archipelago still farther south which now bears his name. In 1821-1822 George Powell, apparently a British sealer, discovered and surveyed the South Orkney Islands which, though typical Antarctic lands, lie outside the Antarctic region.

A voyage only second in importance to that of Cook was planned in Russia and sent out by the emperor Alexander I. under the command of Fabian von Bellingshausen in the "Vostok," with Lieut. Lazareff in the "Mirni" in company, both vessels being about 500 tons. The object of the expedition was to supplement that of Cook by circumnavigating the Antarctic archipelago, taking care to keep as far south as possible in those longitudes where Cook had made his northward detours. Bellingshausen entered on his exploring work by sighting South Georgia at the end of December 1819, discovered the Traverse Islands, sighted the Sandwich group and met a solid ice-pack in 60° S., to get round which he made a wide detour, sailing east to the south of Cook's track, and getting south of the 60th parallel in 8° W. On the 26th of January he crossed the Antarctic Circle in 3° W. and by February 1st had reached 67° 21' in 1° 11' W., a latitude which has never been surpassed on that meridian. Being stopped by ice, Bellingshausen turned northward and then continued to the east well to the south of Cook's track, getting south again as the ice permitted and reaching 69° 6' S. in 18° E. On this occasion he was able to sail for three degrees of longitude within the circle before being forced north of it by a succession of heavy gales. He still kept eastward south of 65° S. and crossed the circle once more in 41° E., where the number of birds seen suggested the proximity of land, and in fact Enderby Land was not very far off, though out of sight. A storm of unexampled violence drove the ships northward, but they still held to the east south of 60° S. as far as 87° E., having followed the edge of the ice through those meridians south of Kerguelen Land where Cook had made a great detour to the north. Bellingshausen now made for Sydney to rest and refit, arriving there on the 29th of March 1820, after 131 days under sail from his last port. At Sydney Bellingshausen heard of the discovery of the South Shetlands, and leaving early in November reached the sixtieth parallel a month later in longitude 143° W., and sailing eastward kept south of that parallel through 145 degrees of longitude during sixty-five days, never out of sight of the ice, keeping close along the pack edge through the great gap left by Cook south of New Zealand. He managed to cross the circle three times more, in 164° 30' W., in 120° W. and in 92° 10' W., where he reached 69° 52' S., the culminating point of the voyage. As the cruise was supplementary to Cook's, no attempt was made to get south of the meridian where that great navigator made his highest latitude. On the 22nd of January 1821, the day after reaching his highest latitude, Bellingshausen sighted the first land ever seen within the Antarctic Circle, the little island named after Peter I. A week later another and larger land, named after Alexander I., was seen at a distance of 40 m. and sketches made of its bold outline in which the black rock stood out in contrast to the snow.

Bellinghausen then made for the South Shetlands, where he met the American sealers, and thence returned to Russia. The voyage was a worthy pendant to that of Cook; it was carried out with a faithful devotion to instructions and consummate seamanship, and as a result it left only half the periphery of the Antarctic Circle within which land could possibly project beyond the Frigid Zone.

The next episode in the history of Antarctic exploration was the voyage of James Weddell, a retired master R.N., in 1823. Weddell was in command of the "Jane," a brig of 160 tons, with the cutter "Beaufoy" of 65 tons in company, and after cruising among the South Orkneys during January he started for the south on exploration, and as he was well equipped with chronometers his positions may be taken as of a far higher degree of accuracy than those of ordinary sealers. On the 20th of February he reached the highest latitude yet attained, $74^{\circ} 15' S.$ in $34^{\circ} 17' W.$, having seen much ice but no impenetrable pack, and at the farthest point the sea was clear and open, but the lateness of the season and the length of the return voyage decided him to go no farther. Weddell made interesting collections of Antarctic animals, including the type specimen of the seal which bears his name, and the book in which he describes his voyage testifies to the keenness of his observations and the soundness of his reasoning. The sea which he penetrated so far to the south he named after the reigning king, George IV., but it is now known as Weddell Sea.

In 1829 Captain Henry Foster, R.N., in H.M.S. "Chanticleer" spent some months in the South Shetlands carrying on pendulum and gravity observations at the most southerly harbour that could be found, and though he did not go south of $63^{\circ} 50' S.$ the careful observations which were made threw much light on the physical conditions of the Antarctic regions.

The firm of Enderby Brothers of London took a conspicuous part in the exploration of the Antarctic seas during the first four decades of the 19th century. They encouraged the masters of the whaling and sealing craft which they sent to the southern seas to take every opportunity that offered for exploration and to fix the position of any land seen with the greatest possible accuracy. The voyage of the Enderbys' brig "Tula," under the command of John Biscoe, R.N., with the cutter "Lively" in company, is worthy to rank with Cook's and Bellinghausen's expeditions, for it repeated and advanced upon their achievements with a mere fraction of their resources. Biscoe, who apparently had never heard of Bellinghausen's discoveries, was a keen explorer and a man given to thinking over and reasoning upon all that he saw, and in many of his conclusions he was far in advance of his time. At the beginning of January 1831 Biscoe, who had been hunting vainly for seals on the Sandwich group, started on a voyage easterly to look for new islands, and in trying to get south of $60^{\circ} S.$ he had to coast the impenetrable ice-pack as far as $10^{\circ} W.$, and continuing he got within the Antarctic Circle in $1^{\circ} E.$ on a track parallel to that of Bellinghausen but farther east. Contrary winds delayed the little vessels, no seal-bearing lands were to be found, but in spite of difficulties, constant danger from fogs and icebergs, and disappointed crews he held on eastward for five weeks far to the south of Cook's track, and, except at one or two points, to the south of Bellinghausen's also. Though his highest latitude was only $69^{\circ} S.$ in $10^{\circ} 43' E.$ on the 28th of January, he remained south of the Antarctic Circle, or within a few miles of it, for another month, when, in longitude $49^{\circ} 18' E.$, he was rewarded by the discovery of land. But just as he was entering on a clear lead of water running straight for a promontory which he named Cape Ann, a terrific storm descended on the vessels, damaged them seriously and drove them helpless before it with the driving ice. A fortnight's struggle with the wind and ice brought Cape Ann into sight again on the 16th of March but the weather was not to be conquered, the sea was beginning to freeze and half the crew were helpless with the effects of exposure, so Biscoe was compelled to give up the fight and reluctantly let the land—now known as Enderby Land—drop out of sight astern. With only three men able to

stand, Biscoe brought the "Tula" into Hobart Town, Tasmania, and the "Lively," with only the master, one man, and a wounded boy alive, just escaped shipwreck in Port Philip Bay. After recruiting their health and completing their crews the two captains put to sea again and spent some time in sealing on the shores of New Zealand and neighbouring islands. They started south once more, and crossed $60^{\circ} S.$ in $131^{\circ} W.$ on the 26th of January 1832. Biscoe kept between 60° and the Antarctic Circle, north of Bellinghausen's route, for he dared not risk the lives of his second crew, but he got south to $67^{\circ} S.$ in $72^{\circ} W.$, and here, on the 14th of February, he again sighted land, which, in ignorance of Bellinghausen's discoveries in the same region, he believed was the most southerly land yet known. He named it Adelaide Land after the queen. A few days later he passed a row of low ice-covered islands—the Biscoe Islands—running from W.S.W. to E.N.E. Beyond these islands lay the mountains of an extensive land of which Biscoe took possession in the name of King William IV., and to which the name of Graham Land was subsequently given. Biscoe returned home after an arduous two months' sealing in the South Shetlands, and the splendid results of his relentless determination as an explorer won for him the gold medals of the young Geographical Societies of London and Paris.

In 1833 another of Enderbys' captains named Kemp reported the discovery of land in $66^{\circ} S.$ and $60^{\circ} E.$ about 10° east of Enderby Land. The last of the great voyages of exploration due to Enderby Brothers was the cruise of the "Eliza Scott" under the command of John Balleny, with the cutter "Sabrina" in company. This voyage is interesting because it was the first attempted in high latitudes from east to west, and all those made in the opposite direction had suffered much from the buffeting of head winds. Balleny left Campbell Island south of New Zealand on the 17th of January 1839 and crossed the Antarctic Circle in $178^{\circ} E.$ on the 29th. Heavy pack ice stopped him in $69^{\circ} S.$, a higher latitude than had previously been reached in that region. On the 6th of February, after the little vessels had been working north-westward along the edge of the pack ice for more than a week, land was seen and found to be a group of mountainous islands—the Balleny Islands—one of which rose to a height of 12,000 ft., and another was an active volcano. Captain Freeman of the "Sabrina" made a momentary landing on one of the islands and was nearly drowned in the attempt, but secured a few stones which showed the rocks to be volcanic. The vessels held on their way westward between latitudes 63° and $65^{\circ} S.$, far south of any earlier voyager, and land, or an appearance of land, to which the name of the "Sabrina" was given, was reported in $121^{\circ} E.$ In $103^{\circ} 40' E.$ an iceberg was passed with a rock embedded in the ice, clear proof of land existing to the southward. A few days later the "Sabrina" was lost in a gale, but Balleny returned in safety.

About 1835 the importance of obtaining magnetic observations in the far south, and the scientific interest of the study of the south polar regions led to plans being put forward for expeditions in the United States, France and Great Britain. The French were first in the field; an expedition, equipped in the frigates "Astrolabe" and "Zélée" under Jules Dumont D'Urville for ethnographical research in the Pacific Islands, was instructed to make an attempt to surpass Weddell's latitude in the South Atlantic Ocean, and this D'Urville tried to do with conspicuous ill-success, for he never reached the Antarctic Circle though he spent the first two months of 1838 round the edge of the ice-pack south of the South Shetlands and the South Orkneys. Some portions of the land south of the South Shetlands were charted and named Joinville Island and Louis Philippe Land; but the addition to knowledge was not great. Two years later, after fulfilling the main purpose of his expedition in the Pacific, D'Urville resolved for the glory of France to attempt to reach the Magnetic Pole, towards which he was aware that a British and an American expedition were directing their course. He left Hobart Town on the 1st of January 1840, and on the 20th he crossed the 66th parallel in $140^{\circ} E.$ and discovered land 3000

or 4000 ft. high, which he named Adélie Land and took possession of by landing on a rocky islet off the icebound coast. Ten days later in 64° 30' S. D'Urville cruised westward along a high ice-barrier, which he believed to be connected with land, from longitude 131° E. and he named it the Clarie Coast. A few days later he left the Antarctic regions for the Pacific.

As early as 1836 the United States Congress had authorized an American Exploring Expedition in the programme of which Antarctic exploration had a leading place. Lieut. Wilkes.

Charles Wilkes was appointed to command the expedition of five vessels in August 1838, and his instructions, dated in that month, required him amongst other things (1) to follow Weddell's route as far as possible, (2) to visit the most southerly point reached by Cook in the Antarctic, and (3) to make an "attempt to penetrate within the Antarctic region, south of Van Diemen's Land, and as far west as longitude 45° E., or to Enderby Land." The ships were in bad repair and ill-adapted for navigation in the ice, and many of the officers were not devoted to their chief; but in spite of great difficulties Wilkes fulfilled his programme. In following Weddell's route Wilkes in March 1839 fared no better than D'Urville in the previous year, but the "Flying Fish" of 96 tons under Lieutenant Walker reached 70° S. in 105° W., thus nearly reaching Cook's position of 1774. The third item of the Antarctic programme was made the subject of the most strenuous endeavour. Wilkes sailed from Sydney in the "Vincennes" on the 26th of December 1839, accompanied by the "Peacock" under Lieut. William L. Hudson, the "Porpoise" under Lieut. Cadwaladar Ringgold, and the "Flying Fish" under Lieut. Pinkney. They went south to the west of the Balleny Islands, which they did not see, and cruised westward along the ice-barrier or as near it as the ice-pack allowed towards Enderby Land nearly on the Antarctic Circle. The weather was bad with fogs, snowstorms and frequent gales, and although land was reported (by each of the vessels) at several points along the route, it was rarely seen distinctly and the officers were not agreed amongst themselves in some cases. Unfortunate controversies have arisen at intervals during sixty years as to the reality of Wilkes's discoveries of land, and as to the justice of the claim he made to the discovery of the Antarctic continent. Some of the land claimed at the eastern end of his route has been shown by later expeditions not to exist; but there can be no doubt that Wilkes saw land along the line where Adélie Land, Kemp Land and Enderby Land are known to exist, even if the positions he assigns are not quite accurate. No one, however, could establish a claim to the discovery of a continent from sighting a discontinuous chain of high land along its coast, without making a landing. It seems no more than due to a gallant and much-persecuted officer, who did his best in most difficult circumstances, to leave the name of Wilkes Land on the map of the region he explored.

Unlike the other two expeditions, that equipped by the British government in 1839 was intended solely for Antarctic exploration and primarily for magnetic surveys in the south polar seas. There were two ships, the "Erebus" of 370 tons, and the "Terror" of 340, stoutly built craft specially strengthened for navigation in the ice. Captain James Clark Ross, R.N., was in command of the "Erebus" and of the expedition; Commander Francis Rawdon Moira Crozier of the "Terror." A young surgeon, Joseph Dalton Hooker, joined the Royal Navy in order to go on the expedition, and he lived to take a keen interest in every subsequent Antarctic expedition down to that of Captain Scott in 1910. Ross had intended to make straight for the meridian of the Magnetic Pole, but, finding that D'Urville and Wilkes had already entered on those seas he determined to try to make a high latitude farther east, and leaving Hobart Town on the 17th of November 1840 he crossed the Antarctic Circle on the 1st of January 1841 and entered the pack ice on the 5th in 174° E. Instead of proving an impenetrable obstacle, the pack let the two ships work through in five days, and they emerged into open sea. Sailing towards the Magnetic Pole they found a chain of great mountains rising from a coast which ran due south

from a prominent cape (Cape Adare) in 71° S. The continent was taken formal possession of for Queen Victoria by landing on Possession Island, the mainland being inaccessible, and the ships continued southward in sight of the coast of Victoria Land, where the loftiest mountain was named Mt Melbourne after the Prime Minister, until the twin volcanoes named Erebus and Terror were sighted in 78° S. on the 28th of January. From Cape Crozier, at the base of the mountains, a line of lofty cliffs of ice ran eastwards, the great ice-barrier, unlike any object in nature ever seen before, rising perpendicularly from the water to the height of 200 or 300 ft. and continuing unbroken for 250 m. Along the barrier the highest latitude of 78° 4' S. was attained, and the farthest point to the east was 167° W., whence Ross turned to look for a winter harbour in Victoria Land. Being desirous to winter near the South Magnetic Pole, Ross did not explore McMurdo Bay between Mt Erebus and the north-running coast, where, as we now know, a harbour could have been found, and as he could not reach the land elsewhere on account of ice extending out from it for 15 or 16 m., after sighting the Balleny Islands at a great distance, on the 2nd of March the ships returned to Hobart. This was the most remarkable Antarctic voyage for striking discoveries ever made.

In November 1841 the "Erebus" and "Terror" returned to Antarctic waters, steering south-east from New Zealand and entering the ice-pack in about 60° S. and 146° W., the idea being to approach the great barrier from the eastward, but by the end of the year they had just struggled as far as the Antarctic Circle and they, together with the pack, were several times driven far to the northward by heavy gales in which the ships were at the mercy of the floating ice. During a storm of terrible severity on the 18th of January the rudders of both ships were smashed, and not until the 1st of February did they break out of the pack in 67° 29' S., 159° W. The barrier was sighted on the 22nd and the ships reached 78° 10' S. in 161° 27' W., the highest latitude attained for 60 years. To the eastward the barrier surface rose to a mountainous height, but although Ross believed it to be land, he would only treat it officially as "an appearance of land," leaving the confirmation of its discovery as King Edward Land to the next century. No more work was done in this quarter; the "Erebus" and "Terror" turned the edge of the pack to the northward and on getting into clear water sailed eastward to Cape Horn, meeting the greatest danger of the whole cruise on the way by colliding with each other at night while passing between two icebergs in a gale.

After wintering in the Falkland Islands and making good the damage received, Ross made his third and last attack on the southern ice, and for six weeks he cruised amongst the pack off Joinville Island and Louis Philippe Land trying in vain to reach the Antarctic Circle. Failing in this attempt he turned to follow Weddell's route and skirted the pack eastward in 65° S. crossing Weddell's track on the 14th of February 1843, more than a degree farther south than D'Urville in his attempt four years before, but on the edge of an equally impenetrable pack. Coasting it eastward to 12° W. the "Erebus" and "Terror" at last rounded the pack and found the way open to the south, crossing the circle on the 1st of March. Four days later the pack was met with again and the ships were forced into it for 27 miles to latitude 71° 30' S. in 14° 51' W., nineteen degrees east of Weddell's farthest south. No sign of land was seen, a deep-sea sounding showed 4000 fathoms with no bottom, and although this was a mistake, for the real depth was later proved by Dr Bruce to be only 2600 fathoms, it showed at least that there was no land in the immediate neighbourhood.

This was Ross's last piece of Antarctic work, but the magnetic observations of his expedition were continued by Lieut. T. E. L. Moore, R.N., in the hired barque "Pagoda," which left Simon's Bay in January 1845 and proceeded south-east, crossing the Antarctic Circle in 30° 45' E. and reaching a farthest south of 67° 50', nine degrees farther east. An attempt to reach Enderby Land was frustrated by the weather, and Moore continued his

voyage to Australia in a high latitude beating against contrary gales, a condition to which all previous experience pointed as likely to occur.

No further attempt at South Polar exploration was made for nearly thirty years, except a short cruise by Mr Tapsell in the "Brisk," one of Enderby's ships which in February 1850, after passing the Balleny Islands, proceeded eastward to 143° E. at a higher latitude than Wilkes without sighting land. The first steamer to cross the Antarctic Circle was H.M.S. "Challenger," on the 16th of February 1874; she only penetrated to 66° 40' S., in 78° 30' E., south of Kerguelen Land; but she continued her course to Australia for some distance in a high latitude, passing within 15 m. of the position assigned to Wilkes's Termination Land without seeing any sign of land. Her dredgings and soundings yielded evidence as to the nature of the unknown region farther south. Sir John Murray believed that the soundings showed a general shoaling of the ocean towards the Antarctic ice, indicating the approach to a continent. By collecting and analysing all samples of deep-sea deposits which had been secured from the far south, he discovered a remarkable symmetry in the arrangement of the deposits. The globigerina ooze, or in deeper waters the red clay, carpeting the northern part of the Southern Oceans, merges on the southward into a great ring of diatom ooze, which gives place in turn, towards the ice, to a terrigenous blue mud. The fine rock particles of which the blue mud is composed are such as do not occur on oceanic islands, and the discovery of large blocks of sandstone dropped by icebergs proved the existence of sedimentary rocks within the Antarctic Circle.

During the southern summer in which the "Challenger" visited Antarctic waters, a German whale-ship, the "Grönländ," under Captain Dallmann, visited the western coast of the Antarctic land south of Tierra del Fuego, and modified the chart in several particulars. The chief discovery was a channel, named Bismarck Strait, in 65° S., which seemed to run between Palmer Land and Graham Land.

When the International Circumpolar observations were set on foot in 1882, two scientific stations were maintained for a year in the southern hemisphere in order to obtain data for comparison with the observations at twelve stations round the North Pole. One of these was occupied by French observers in Tierra del Fuego in 55° S., the other by German observers at Royal Bay on South Georgia in 54° 30' S. The magnetic and meteorological observations were of considerable importance.

In 1892 four steamers of the Dundee whaling fleet—the "Balaena," "Active," "Diana" and "Polar Star"—went out to test Ross's statement that the "right whale" inhabited Antarctic waters. The surgeons of two of the vessels—on the "Balaena" Dr W. S. Bruce, on the "Active" Dr C. W. Donald—were selected for their scientific tastes, and equipped with all requisite instruments for observations and collecting. The result of the experiment was disappointing. No whales were obtained, and the ships devoted their attention to sealing on the east of Joinville Island and Louis Philippe Land, not going farther south than 65° S. (*Geographical Journal*, 1896, vii. 502-521, 625-643).

A Norwegian sealer, the "Jason," Captain Larsen, also visited those seas in the same season, but the captain landed and collected fossils at several points north of 65° S. In 1893-1894 the "Jason," accompanied by two other Norwegian vessels, the "Hertha" and the "Castor," returned to the Antarctic and entered the ice-laden waters in November at the very beginning of summer. Captain Larsen in the "Jason" made his way as far south as 68° 10' in 60° W. on the eastern side of Graham Land, but several miles from the coast, which was bordered by a high ice-barrier. The land beyond this barrier was named Foyn Land, after a famous Norwegian whaleship owner. Returning northwards, two small islands, Lindenberg and Christensen, were discovered and found to be active volcanoes. Meanwhile the "Hertha," Captain Evensen, had reached the South Shetlands on the 1st of November 1893, and worked her way southward along the west side of Palmer Land and past the Biscoe Islands,

reaching the Antarctic Circle on the 9th of November without meeting ice. This was the first time the Antarctic Circle had been crossed since the "Challenger" did so twenty years before. Captain Evensen sighted Alexander Land, and without experiencing any trouble from ice-floes he reached his farthest south, 69° 10' S. in 76° 12' W. (*Mitteilungen der Geographischen Gesellschaft*, Hamburg, 1895, pp. 245-304).

In 1894 the well-known Norwegian whaler, Svend Foyn, sent out one of his vessels, the "Antarctic," Captain Christensen, to try his luck off the coast of Victoria Land. The "Antarctic" sailed from Melbourne in September, 1894, having on board Carstens Egeberg Borchgrevink, a young Norwegian resident in Australia, who, being determined to take part in a voyage he could join in no other way, shipped as an ordinary seaman. He made notes of the voyage, and published an account of it on his return to Europe (*Report of Sixth International Geographical Congress*, London, 1895, pp. 169-175). The "Antarctic" entered the pack in 62° 45' S., 171° 30' E., on the 8th of December 1894. The Balleny Islands were sighted on the 14th of December, and Cape Adare on Victoria Land two days later. On the 22nd of January 1895 the farthest point was reached at Coulman Island in 74° S.; the sea was then easily navigable to the south. On the 23rd of January a small party, including the captain and Mr Borchgrevink, landed on the mainland near Cape Adare, the first people to set foot on the Antarctic continent.

Efforts had been made from time to time, by Professor Georg von Neumayer in Germany and by Sir John Murray and others in Great Britain, to induce learned societies to inaugurate a new era of scientific Antarctic research under Government or at least under national auspices.

In 1895 Sir Clements Markham, as president of the Royal Geographical Society and of the International Geographical Congress, also took the matter up, and interest in the Antarctic regions began to be aroused in every civilized country. Captain Adrien de Gerlache organized and led a Belgian expedition, for which he raised the funds with difficulty. M. Georges Leconte, captain of the "Belgica," and Lieut. Danco, magnetic observer, were Belgians; Mr Roald Amundsen, the mate, a Norwegian; M. Arctowski, the geologist and physicist, a Pole; M. Racovitz, the biologist, a Rumanian; and Dr F. A. Cook, the surgeon, an American. On the 14th of January 1898, already long past midsummer, the "Belgica" left Staten Island for Antarctic waters. She sighted the South Shetlands on the 21st and proceeded to Hughes Gulf, from which a channel, Gerlache Strait, was explored leading south-westward between continuous land, named Danco Land, on the east (the northern extension of Graham Land), and Palmer Land on the west. Palmer Land was found to be a group of large islands. On the 12th of February the "Belgica" re-entered the open sea to the west at Cape Tuxen in 65° 15' S. Much fog was experienced, but on the 16th Alexander Land was sighted in the distance. Continuing on a westerly course, the "Belgica" made every effort to enter the pack, which was successfully accomplished after a heavy storm on the 28th. By taking advantage of the leads, the expedition advanced to 71° 30' S. in 85° 15' W. by the 2nd of March, but the ship was blocked next day by the growth of young ice soldering the pack into one continuous mass. For more than a year further independent movement was impossible; but the ship drifted with the ice between the limits of 80° 30' W. and 102° 10' W., and of 69° 40' and 71° 35' S., which was the highest latitude attained (May 31, 1898). The sun did not rise for seventy days, and all on board suffered severely from depression of spirits and disorders of the circulation, which Dr Cook attributed to the darkness and to improper food. Lieut. Danco died during the period of darkness. On the 13th of March 1899, when a second winter in the ice began to seem probable, the "Belgica" was released in 69° 50' S. and 102° 10' W. The geographical results of this expedition were insignificant so far as the discovery of land or penetration to a high latitude is concerned. The ship passed several times to the south and west of Peter I. Island, proving that the land seen by Bellingshausen at that

point is of very limited extent. During the drift in the ice the soundings were usually between 200 and 300 fathoms, which, compared with the great depths to the north, clearly indicated a continental shelf of considerable breadth, probably connected with land in the south. The scientific collections were of unique value and have been worked up and the results published at the expense of the Belgian government.

The Hamburg America Company's steamer "Valdivia," chartered by the German Government for a scientific voyage "Valdivia," under the leadership of Professor Carl Chun of Leipzig, with Dr Gerhard Schott as oceanographer, left Cape Town on the 13th of November 1898, and on the 25th was fortunate in rediscovering Bouvet Island (54° 26' S., 3° 24' E.), which had been searched for in vain by Cook, Ross, Moore and many other sailors. Steering south, the "Valdivia," although an unprotected steel vessel, followed the edge of the pack from 8° E. to 58° E., reaching 64° 15' S. in 54° 20' E. on the 16th of December. At this point a depth of 2541 fathoms was found, so that if Enderby Land occupies its assigned position, 102 nautical miles farther south, the sub-oceanic slope must be of quite unusual steepness. The rocks dredged up contained specimens of gneiss, granite and schist, and one great block of red sandstone weighing 5 cwt. was secured, confirming the theory of the continental nature of the land to the south.

On his return to England in 1895 Mr Borchgrevink made strenuous efforts to organize an Antarctic expedition under his own leadership, and in August 1898 he left the Thames on the "Southern Cross," in charge of a private expedition equipped by Sir George Newnes. His scientific staff included Lieut. Colbeck, R.N.R.; Mr Louis Bernacchi, a trained magnetic observer, and Mr N. Hanson, biologist. About fifty dogs were taken out, the intention being to land at Cape Adare and advance towards the magnetic, and perhaps also towards the geographical pole by sledge. The "Southern Cross" sighted one of the Balleny Islands on the 14th of January 1899, and after in vain attempting to get south about the meridian of 164° E., the ship forced her way eastward and emerged from the pack (after having been beset for forty-eight days) in 70° S., 174° E. She reached Cape Adare, and anchored in Robertson Bay on the 17th of February. The land party, consisting of ten men, was established in a house built on the strip of beach at the base of the steep ascent to the mountains, and the ship left on the 2nd of March. Mr Borchgrevink found it impossible to make any land journey of importance and the party spent the first year ever passed by man on Antarctic land in making natural history collections and keeping up meteorological and magnetic observations. The "Southern Cross" returned to Cape Adare on the 28th of January 1900, and after taking the winter party on board—diminished by the death of Mr Hanson—set out for the south on the 2nd of February. Landings were made on several islands, on the mainland at the base of Mt Melbourne, and on the 10th of February at the base of Mt Terror, near Cape Crozier. From this point the ship steamed eastward along the great ice-barrier to a point in 164° 10' W., where an inlet in the ice was found and the ship reached her highest latitude, 78° 34' S., on the 17th of February. The edge of the ice was found to be about 30 m. farther south than it had been when Ross visited it in 1842. Mr Borchgrevink was able to land on the ice with sledges and dogs, and advanced southward about 16 m., reaching 78° 50' S. He discovered that plant life existed in the shape of mosses and lichens in some of the rocky islands, a fact not previously known.

In the autumn of 1901 three well-equipped expeditions left Europe for Antarctic exploration. The British National Antarctic expedition was organized by a joint committee of the Royal Society and the Royal Geographical Society, and equipped under the superintendence of Sir Clements Markham. Most of the cost was borne by the government, the rest mainly by Mr L. W. Longstaff, who provided £30,000, the Royal Geographical Society, and Mr A. C. Harmsworth (afterwards Lord Northcliffe). A strong wooden ship of about 700 tons register (1700 tons displacement) was built at Dundee, and named the "Discovery."

She was made entirely non-magnetic amidships, so that magnetic observations might be carried on without interference from local attraction. The expedition sailed under ^{Scott,} "Discovery," the command of Commander R. F. Scott, R.N., with Lieut. Albert Armitage, R.N.R., as second in command, Lieuts. Royds and Barne, R.N., Lieut. Shackleton, R.N.R., and Engineer-Lieut. Skelton, R.N. The crew of forty men were almost entirely sailors of the Royal Navy. The scientific staff included Dr Koettlitz, who had shared with Mr Armitage in the Jackson-Harmsworth arctic expedition; Mr Louis Bernacchi, who had wintered with Mr Borchgrevink at Cape Adare; Dr E. A. Wilson, Mr Hodgson, biologist, and Mr Ferrar, geologist. The "Discovery" sailed from New Zealand on the 24th of December 1901, met the pack ice on the Antarctic circle and was through into the open sea in 175° E. on the 8th of January 1902. She made a quick run to Cape Crozier and cruised along the great ice barrier, confirming Borchgrevink's discovery that it lay 30 m. farther south than in 1842, and at the eastern end of the barrier Scott discovered and named King Edward Land where Ross had recorded as "appearance" only. The sea in the neighbourhood had shoaled to less than 100 fathoms and the ice-barrier in places was so low that the "Discovery" was able to lie alongside as at a quay. A captive balloon ascent was made from the barrier but nothing was seen to the south. Returning to McMurdo Bay the "Discovery" found that Mts Erebus and Terror were on an island, the "bay" being really a sound. The ship was secured in winter quarters in 77° 49' S. 166° E., and a hut erected on shore. From this base land-exploration in the Antarctic was initiated, and the history of exploration entered on a new phase. Although some symptoms of scurvy appeared during the winter they were checked by change of diet; and with the beginning of spring sledge journeys with dogs were commenced and a quantity of provisions was laid down in depots to assist the great journey which Scott had planned to the south. On the 2nd of November 1902 Captain Scott, with Lieut. E. H. Shackleton and Dr E. A. Wilson, set out with dog-sledges travelling south over the surface of the barrier in sight of a range of low mountains running parallel to their track on the west. The conditions of travelling were unlike those in the Arctic region, the weather being more inclement and the summer temperature much lower than in similar latitudes in the north. There were no bears to menace the safety of the travellers, and no wolves or foxes to plunder the depots; but on the other hand there was no game of any sort to be met with, and all food for men and dogs had to be carried on the sledges. The surface of the ice was so rough and much crevassed, especially near the western land, snow blizzards frequently occurred making travelling impossible and the heavy sledges had at first to be brought forward by relays, making it necessary to march three miles for every mile of slogging made. The dogs also weakened and had to be killed one by one to feed the rest. On the 30th of December they were in 82° 17' S. and Scott determined to try to reach the mountains to the west; but on approaching the land he found the ice so much crevassed and disturbed that the attempt had to be given up. Great peaks in 83° S. were named Mt Markham (15,100 ft.) and Mt Longstaff (9700 ft.) after the chief promoters of the expedition. The outward journey of 380 m. had taken 59 days, and was a splendid achievement, for the conditions to be encountered were totally unknown, and new methods had to be devised as the necessity arose, yet no previous polar explorer had ever advanced so far beyond his predecessor as Scott did. The return journey occupied 34 days and the ship was reached on the 3rd of February 1903, but Shackleton had broken down on the way and he had to return by the relief ship "Morning" on the 3rd of March, Lieut. Mulock, R.N., taking his place on the "Discovery." During the absence of the commander in the great southern journey Armitage and Skelton had found a way to ascend by a glacier in 78° S. to the summit of the vast snow-covered plateau beyond the granite summits of the western mountains. They reached a distance of 130 m. from the ship and an elevation of 9000 ft. Many shorter journeys were made; Ferrar studied the geology of the

mountains and Hodgson was indefatigable in collecting marine fauna, while Bernacchi kept up the physical and meteorological observations. The second winter was lightened by the use of acetylene gas for the first time, and the dark months were passed in better spirits and better health than in the case of any previous polar wintering. In the spring of 1903-1904 Scott undertook a great journey on the western plateau, starting on the 26th of October without dogs. By the 30th of November he had reached a point on the featureless plateau of dead-level snow, 300 m. due west from the ship, the position being $77^{\circ} 59' S.$, $146^{\circ} 33' E.$ and 9000 ft. above sea-level. The ship was reached again on the 25th of December, and on the 5th of January the "Morning" arrived accompanied by a larger vessel, the "Terra Nova," sent out by the Admiralty with orders to Captain Scott to abandon the "Discovery" and return at once. Fortunately, although all the stores and collections had been transferred to the relief ships, the "Discovery" broke out of the ice on the 16th of February 1904 and Captain Scott had the satisfaction of bringing her home in perfect order. The relief ships had provided so little coal that a most promising voyage to the westward of the Balleny Islands had to be abandoned in $155^{\circ} E.$; but it showed that the land charted by Wilkes east of that meridian did not exist in the latitude assigned.

Simultaneously with the "Discovery" expedition and in full co-operation with it as regards simultaneous meteorological and *Drygalski* magnetic observations, the German government "Gauss" equipped an expedition in the "Gauss" which was specially built for the occasion. The expedition was under the charge of Professor Erich von Drygalski and the scientific staff included Professor Vanhöffen as naturalist, Dr Emil Philipp as geologist and Dr Friedrich Bidlingmaier as meteorologist and magnetician. The ship was under the command of Captain Hans Ruser of the Hamburg-American line. A supplementary expedition set up a station for simultaneous observations on Kerguelen Land. The "Gauss" crossed the parallel of $66^{\circ} S.$ in $92^{\circ} E.$ early in February 1902 and got within 60 m. of the charted position of Wilkes's Termination Land, where a depth of 1730 fathoms was found with no sign of land. The pack made it necessary to turn south-westward and land was seen to the eastward on February 1902 on the Antarctic Circle in the direction of Termination Land. Soon afterwards the "Gauss" was beset and spent the winter in the ice. Land of considerable extent was seen to the south and was named Kaiser Wilhelm II. Land; the most conspicuous feature on it was a hill of bare black rock with an elevation of about 1000 ft., which was called the Gaussberg, and was situated in $67^{\circ} S.$, $90^{\circ} E.$ This was the only bare land seen, and its neighbourhood was thoroughly investigated by sledge parties, but no distant journey was undertaken. In February 1903 the "Gauss" was freed from the ice; but although Drygalski struggled for two months to thread the maze of floes to the eastward and south he could gain no higher latitude and was able to force his way only to $80^{\circ} E.$ before seeking the open sea. The scientific observations and collections were most extensive and of great value.

Two private expeditions organized by men of science were in the Antarctic region simultaneously with the British and *Nordenskiöld* German national expeditions, and the synchronous meteorological and magnetic observations added to the value of the scientific results of all the parties. Dr. Otto Nordenskiöld, nephew of the discoverer of the North-East Passage, led a Swedish party in the "Antarctic," with Captain C. A. Larsen in command of the ship, and reached the South Shetlands in January 1902, afterwards exploring on the east side of Joinville Island and Louis Philippe Land, and wintering on shore on Snow Hill Island in $64^{\circ} 25' S.$ From this point a long journey on ski over the flat sea ice bordering King Oscar Land was made to the south, but the Antarctic Circle was not reached. Meanwhile the "Antarctic" had succeeded in penetrating the pack in the Weddell Sea almost to the circle in $50^{\circ} W.$, where D'Urville and Ross had failed to get so far south. A second winter was spent at the base on Snow Hill Island, and, the ship having been

lost in the ice on her way to take them off, the party was rescued by a brilliant dash of the Argentine gunboat "Uruguay," under Captain Irizar, before the relief ship sent from Sweden arrived.

Meanwhile Dr W. S. Bruce, largely aided financially by Mr James Coats and Captain Andrew Coats, equipped a Scottish expedition in the "Scotia," with Captain Thomas Robertson in command of the ship, and a scientific staff including Mr R. C. Mossman as meteorologist, Mr R. N. Rudmose Brown as naturalist, and Dr J. H. H. Pirie as geologist. The principal object of the expedition was the exploration of the Weddell Sea. The "Scotia" sighted the South Orkneys on the 3rd of February 1903, and after a short struggle with the pack she found an open sea to $70^{\circ} 25' S.$, where she was beset on the sand in $18^{\circ} W.$, and whence she returned by a more westerly course, re-crossing the Antarctic Circle in $40^{\circ} W.$ This important voyage midway between the tracks of Weddell and Ross, who alone of all who tried had reached $70^{\circ} S.$ in this region, practically demonstrated the navigability of Weddell Sea in favourable conditions, and the oceanographical observations made were the most valuable yet carried out in the Antarctic region. The following year, starting from the Sandwich group, Bruce crossed the Antarctic Circle about $22^{\circ} W.$, and was able to make a straight run south to $74^{\circ} 1' S.$, where the "Scotia" was stopped by the ice in 159 fathoms of water, the sea having shoaled rapidly from a great depth. From the 3rd of March to the 13th the "Scotia" remained in shallow water, catching occasional glimpses of a great ice wall with snow-covered heights beyond it, along a line of 150 m., and dredging quantities of continental rocks. On this evidence the name Coats Land was given to the land within the barrier. The "Scotia" crossed the Antarctic Circle northward in $11^{\circ} W.$, having in the two years explored a totally unknown sea for a distance of thirty degrees of longitude. A meteorological station was established by Mr Mossman on Laurie Island, in the South Orkneys ($61^{\circ} S.$) in March 1903, and kept up by him for two years, when it was taken over by the Argentine government, and it now has the distinction of being the most southerly station at which continuous observations have ever been taken for over five years.

In January 1904 Dr Jean B. Charcot, a man of science and an accomplished yachtsman, left the Fuegian archipelago for the Antarctic in the "Français," in command of a French exploring expedition equipped at his own instance. He cruised through the islands of the Palmer Archipelago, and wintered in a cove of Wandel Island $65^{\circ} 5' S.$ near the southern entrance of Gerlache Strait. On the 25th of December 1904 the "Français" was free, and continued to cruise southward along the coast of Graham Land, to the south of which, on the 15th of January, when nearly in latitude 67° , a new coast appeared, mountainous and stretching to the south-west, but Charcot could not determine whether it was joined to Graham Land or to Alexander Land. While approaching the land the "Français" struck a rock, and was so much damaged that further exploration was impossible, and after naming the new discovery Loubet Land, the expedition returned. Charcot organized a second expedition in 1908 on board the "Pourquoi Pas?" and, leaving Punta Arenas in December, returned to the Palmer Archipelago, and during January 1909 made a detailed examination of the coast to the southward, finding that Loubet Land was practically continuous on the north with Graham Land and on the south with Alexander Land, which was approached within a mile at one point. Adelaide Island, reported by Biscoe as 8 m. long, was found to be a large island 70 m. in length; consisting of a series of summits rising out of an icefield. The Biscoe Islands were found to be much more numerous than was formerly supposed. The expedition wintered at Petermann Island in $65^{\circ} 10' S.$, and attempts were made to reach the interior of Graham Land, though with little success. After coaling from the whalers' depot at Deception

Island, the "Pourquoi Pas?" sailed on the 6th of January 1908 to the south-west, and reached 70° S. on the 11th, whence views of Alexander Land were obtained from a new position, and a new land discovered farther to the south-west. The highest latitude reached was about 70° 30' S., and Charcot was able to steam westward nearly along this parallel crossing the region of the "Belgica's" drift, passing close to Peter I. Island across the meridian of Cook's highest latitude, where the ice seemed to promise an easy way south if coal had permitted, and on to 128° W. through an absolutely unknown sea, from which point a direct course was made for Punta Arenas. Frequent soundings and dredgings were made, and Dr Charcot satisfied himself from all the appearances that along the 20 degrees of longitude west of Gerlache's farthest, and more than half-way from Graham Land to King Edward Land, land was probably not far distant to the south.

After his return invalidated from the "Discovery," Lieut. Shackleton planned a fresh expedition, which he equipped at **Shackleton**, his own expense, aided by his personal friends, and he started in the small whaler "Nimrod" from Lyttelton, New Zealand, on the 1st of January 1908, being towed by a steamer to the Antarctic Circle, in order to save coal. The plan was to land a shore party on King Edward Land and return to take them off in the following year, but although a strenuous effort was made to reach the land the floe ice was too heavy, and it would have been madness to establish winter-quarters on the barrier, the coast-line of which had altered greatly since 1902, and was obviously liable to break off in great ice-islands. On the 26th of January the "Nimrod" began to return from the extreme east of the barrier, and the landing of stores commenced on the 3rd of February at Cape Royds, at the base of Mt Erebus, 20 m. north of the "Discovery's" winter-quarters. The shore party included the leader and fifteen companions, amongst them Professor T. W. Edgeworth David, of Sydney University; Lieut. Jameson Boyd Adams, R.N.R.; Sir Philip Brocklehurst, Bart.; Mr James Murray, biologist; Mr Raymond E. Priestley, geologist; Dr Alistair Forbes Mackay; Dr Eric Marshall; Mr Douglas Mawson, geologist; and Ernest Joyce and Frank Wild of the Royal Navy, who had taken part in the "Discovery" expedition. No casualty occurred during the whole duration of the expedition, special care having been taken to supply the best provisions, including fresh bread baked daily and dried milk in unlimited quantity, while abundant artificial light was secured by the use of acetylene gas. A motor-car was taken in the hope that it might be used on the barrier surface, but this was found impracticable, although it did good work in laying dépôts on the sea-ice. Another and more successful experiment in traction was the use of Manchurian ponies. Eight of these extraordinarily hardy creatures were taken south in the "Nimrod," but four died in the first month after landing. The others did good service. Nine dogs were also taken, but the experience on the "Discovery" expedition did not lead to much dependence being placed on them. The "Nimrod" left for the north on the 22nd of February and the scientific staff at once began the observations and collections which were kept up to the end. The discovery of a considerable fresh-water fauna and of a poor but characteristic flora was one of the most unexpected results. Apart from many minor excursions and surveys, the expedition performed three journeys of the first importance, each of them surpassing any previous land work in the Antarctic regions. Before winter set in, Professor David, with five companions, made the ascent of Mt Erebus, starting from the winter quarters on the 5th of March, and gaining the summit at an altitude of 13,300 ft. on the 10th; this was found to be the edge of an active crater, the abyss within being 900 ft. deep, though rarely visible on account of the steam and vapours which rose in a huge cloud 1000 ft. above the summit.

The second achievement was the attainment of the South Magnetic Pole by Professor David, with Mr Douglas Mawson and Dr Mackay. They left winter-quarters on the 6th of October

1908, dragging two sledges over the sea-ice. Proceeding along the coast they were able to supplement their provisions and fuel by seal-meat and blubber, and on the 1st of December they reached the Drygalski ice barrier in 75° S., which proved very difficult to cross. Leaving this ice-tongue on the 19th, they proceeded to ascend the plateau with one sledge, and ran great risks from the crevasses into which they were constantly falling. On reaching the summit of the plateau travelling became easier, and on the 16th of January 1909 the magnetic dip was 90°, and the position of the magnetic pole was determined as 72° 25' S., 155° 16' E., at an altitude of 7260 ft. and 260 m. from the dépôt of provisions left at the Drygalski glacier. The return journey to this point was accomplished by forced marches on the 3rd of February, and next day the party was picked up by the "Nimrod," which was scouting for them along the coast.

The third and greatest achievement of this remarkable expedition was Shackleton's great southern journey. Dépôts had been laid out in advance on the barrier ice, and the main southern party, consisting of Messrs Shackleton, Adams, Marshall and Wild, started from winter-quarters on the 29th of October 1908, with the four ponies and four 11-ft. sledges; a supporting party of five men accompanied the main division for ten days. In order to avoid the disturbed and crevassed ice near the great south-running mountain range, Shackleton kept about 40 m. farther to the east than Scott had done. The ponies enabled rapid progress to be made, but after passing the 81st parallel on the 21st of November, one pony broke down and had to be shot, the meat being left in a dépôt for the return journey. In spite of cold weather and frequent high winds, progress was made at the rate of 15 m. per day, and on the 26th of November the farthest south of the "Discovery" expedition was passed, and Mts Markham and Longstaff were full in view. New mountains continued to appear beyond these, and the range changed its southerly to a south-easterly trend, so that the path to the Pole led through the mountains. On the 28th a second pony became used up and was shot, and a dépôt was formed with provisions and stores for the return in 82° 38' S., and progress was resumed with two sledges. The surface of the barrier ice formed great undulations of gentle slope. On the 1st of December a third pony had to be shot, in 83° 16' S., and horseflesh became the principal article of diet; the remaining pony hauled one sledge, the four men took the other. On the 4th of December the party left the barrier, passing over a zone of much disturbed ice, and commenced the ascent of a great glacier (the Beardmore glacier) which descended from the mountains between magnificent granite cliffs 2000 ft. high. On the 7th, when toiling amongst a maze of crevasses on the glacier, 2000 ft. above sea-level, the last pony fell into a crevasse and was lost, though the loaded sledge was saved; the pony was to have been shot that night as it could not work on the disturbed ice, but its loss meant so much less food, and as far as can be judged this alone made it impossible for the party to reach the Pole. For the next few days of laborious advance one or other of the party was continually falling into a crevasse, but the sledge harness saved them, and no serious harm resulted. After climbing upwards for 100 m. on the glacier, a dépôt was made at a height of 6100 ft. of everything that could possibly be left behind, including all the warm clothing, for it was found possible with Jaegers and wind-proof Burberrys to meet any weather in which exertion was possible. By Christmas Day the plateau surface was fairly reached at a level of 9500 ft., in latitude 85° 55' S., and there was no more difficulty to overcome as regarded the ground, but merely the effort of going on over a nearly level surface with insufficient food in a very low temperature, intensified by frequent blizzards. Rations were reduced in the hope of being able to push on to the Pole. Three days later the last crevasse was passed and the surface, now 12,200 ft. above sea-level, grew smoother, allowing 15 m. a day to be done with fair weather. At 4 a.m. on the 9th of January 1909 the four explorers left their sledge and

facing, half walking, half running, they reached 88° 23' S. in 162° E. at 9 a.m., the height above sea being 11,600 ft. The utmost had been done, though more food would have enabled the remaining 97 geographical miles to the South Pole to be accomplished. The camp was reached again at 3 p.m. The return journey of over 700 m. to the ship was one long nightmare of toil and suffering, but the length of the marches was unsurpassed in polar travel. Once and again all food was exhausted the day before the *dépôt*, on which the only hope of life depended, was picked up in the waste of snow. Snow-blindness and dysentery made life almost unendurable, but, despite it all, the ship was reached on the 1st of March, and the geological specimens from the southernmost mountains, which prevented the sledges of the exhausted men being lightened as they went on, were safely secured. Never in the history of polar exploration had any traveller outdistanced his predecessor by so vast a step towards either Pole.

During the return journey of the "Nimrod" Shackleton was able to do a little piece of exploration to the south of the Balleny Islands, tracing the coast of the mainland for 50 m. to the south-west beyond Cape North, thus indicating that the Antarctic continent has not a straight coast-line running from Cape Adare to Wilkes Land. The British government contributed £20,000 to the expenses of the expedition in recognition of the great results obtained, and the king conferred a knighthood on the explorer, the first given for Antarctic exploration since the time of Sir James Clark Ross.

Captain R. F. Scott left England in the summer of 1910 with a new expedition in the "Terra Nova," promoted by his *Expedition's* own exertions, aided by a government grant, and of 1910-1911. with a carefully selected crew and a highly competent scientific staff. He intended to arrange for two parties, one leaving King Edward Land, the other McMurdo Sound, to converge on the South Pole. A German expedition under Lieut. Wilhelm Filchner was announced to leave early in 1911 with the hope of exploring inland from a base in the western part of Weddell Sea, and Dr W. S. Bruce has announced for the same year an expedition to the eastern part of Weddell Sea mainly for oceanographical exploration. It appears that the greatest extension of knowledge would now be obtained by a resolute attempt to cruise round the south polar area: from east to west in the highest latitude which can be reached. This has never been attempted, and a modern Biscoe with steam power could not fail to make important discoveries on a westward circumnavigation.

Physiography of Antarctic Region.—In contrast to the Arctic region, the Antarctic is essentially a land area. It is almost certain that the South Pole lies on a great plateau, part of a land that must be larger and loftier than Greenland, and may probably be as large as Australia. This land area may be composed of two main masses, or of one continent and a great archipelago, but it can no longer be doubted that the whole is of continental character as regards its rocks, and that it is permanently massed into one surface with ice and snow, which in some parts at least unites lands separated by hundreds of miles of sea. But all round the land-mass there is a ring of deep ocean cutting off the Antarctic region from all other land of the earth and setting it apart as a region by itself, more unlike the rest of the world than any continent or island. The expedition of the "Scotia" showed the great depth of the Weddell Sea area, and the attention paid to soundings on other expeditions—notably that of the "Belgica"—has defined the beginning of a continental shelf which it cannot be doubted slopes up to land not yet sighted. In the Arctic region large areas within the Polar Circle belong to climatically temperate Europe, and to habitable lands of Asia and America; but in the Antarctic region extensive lands—Graham Land, Louis Philippe Land, Joinville Island and the Palmer archipelago outside the Polar Circle—partake of the typically polar character of the higher latitudes, and even the islands on the warmer side of the sixtieth parallel are of a sub-Antarctic nature, akin rather to lands of the frigid than to those of the temperate zone.

Geology—Definite information as to the geology of Antarctic land is available from three areas—Graham Land and the archipelago to the north of it, Kaiser Wilhelm Land and Victoria Land. In the Graham Land region there seems to be a fundamental rock closely resembling the Archaean. Palaeozoic rocks have not been discovered so far in this region, although a graptolite fossil, probably of Ordovician age, shows that they occur in the South Orkneys. Mesozoic rocks have been found in various parts of the archipelago, a very rich Jurassic fossil flora of ferns, conifers and cycads having been studied by Nordenskjöld, some of the genera found being represented also in the rocks of South America, South Africa, India and Australia. Cretaceous ammonites have also been found, and Tertiary fossils, both of land and of marine forms, bring the geological record down probably to Miocene times, the fauna including five genera of extinct penguins. Raised beaches show an emergence of the land in Quaternary times, and there is evidence of a recent glacial period when the inland ice on Graham Land was a thousand feet higher than it is now. The most prominent features of the scenery are due to eruptive rocks, which have been identified as belonging to the eruptive system of the Andes, suggesting a geologically recent connection between South America and the Antarctic lands. Volcanic activity is not yet extinct in the region.

As regards Kaiser Wilhelm Land, the Gausberg is a volcanic cone mainly composed of leucite-basalt, but its slopes are strewn with erratics presumably transported from the south and these include gneiss, mica-schist and quartzite, apparently Archaean.

Much more is known as to the geology of Victoria Land, and the results are well summarized by Professor David and Mr Priestley of Sir Ernest Shackleton's expedition, whom we follow. From Cape North (71° S.) to 86° S. a grand mountain range runs south curving to south-eastward, where it vanishes into the unknown; it is built up of gneiss and granite, and of horizontal beds of sandstone and limestone capped with eruptive rock, the peaks rising to heights of 8000, 10,000 and even 15,000 feet, the total length of the range so far as known being at least 1100 miles. This range rises abruptly from the sea, or from the ice of the Great Barrier, and forms a slightly higher edge to a vast snow plateau which has been traversed for several hundred miles in various directions, and may for aught we know extend farther for a thousand miles or more. The accumulated snows of this plateau discharge by the hugest glaciers in the world down the valleys between the mountains. About 78° S. a group of volcanic islands, of which Ross Island, with the active Mt Erebus is the largest, rise from the sea in front of the range, and at the northern extremity the volcanic peaks of the Balleny Islands match them in height. The composition of the volcanic rocks is similar to that of the volcanic rocks of the southern part of New Zealand. The oldest rocks of Victoria Land are apparently banded gneiss and gneissic granite, which may be taken as Archaean. Older Palaeozoic rocks are represented by greenish grey slates from the sides of the Beardmore glacier and by radiolarian cherts; but the most widespread of the sedimentary rocks occurring in vast beds in the mountain faces is that named by Ferrar the Beacon sandstones, which in the far south Shackleton found to be banded with seams of shale and coal amongst which a fossil occurred which has been identified as coniferous wood and suggests that the place of the formation is Lower Carboniferous or perhaps Upper Devonian. No Mesozoic strata have been discovered, but deposits of peat derived from fungi and moss are now being accumulated in the fresh-water lakes of Ross Island, and raised beaches show a recent change of level. The coast-line appears to be of the Atlantic, not the Pacific type, and may owe its position and trend to a great fault, or series of faults, in the line of which the range of volcanoes, Mt Melbourne, Mt Erebus, and Mt Discovery, stand. Boulders of gneiss, quartzite and sandstone have been dredged at so many points between the Balleny Islands and the Weddell Sea that there can be no doubt of the existence of similar continental land along the whole of that side, at least within the Antarctic Circle.

Antarctic Ice-Conditions.—It is difficult to decide whether the ice of the polar regions should be dealt with as a geological formation or a meteorological phenomenon, but in the Antarctic the ice is so characteristic a feature that it may well be considered by itself. So far as can be judged, the total annual precipitation in the Antarctic region is very slight, probably not more than the equivalent of 10 in. of rain, and perhaps less. It was formerly supposed that the immense accumulation of snow near the South Pole produced an ice-cap several miles in thickness which, creeping outward all round, terminated in the sea in vast ice-cliffs, such as those of Ross's Great Barrier, whence the huge flat-topped ice-islands broke off and floated away. Evidence, both in the Graham Land and in the Victoria Land areas, points to a former much greater extent of the ice-cap. Thus Shackleton found that the summit of Mt Hope, in 83° 30' S., which stands 2000 feet above the ice of the surrounding glaciers, was strewn with erratics which must have been transported by ice from the higher mountains to the south and west. In McMurdo Sound, as in Graham Land, evidence was found that the surface of the ice-sheet was once at least a thousand feet above its present level. These facts appear to indicate a period of greater snowfall in the geologically recent past—i.e. a period of more genial climate allowing the air to carry more water vapour to the southern mountains. Whatever may have been the case in the past the Antarctic glaciers are now greatly shrunken and many of them no longer reach the sea. Others project into the sea a tongue of hard ice, which in the case of the Drygalski glacier tongue is 30 m. long, and afloat probably for a considerable distance. Some of these glacier tongues of smaller size appear now to be cut off at their shoreward end from the parent glacier. At one time the Victoria Land glacier tongues may have been confluent, forming a great ice barrier along the coast similar to the small ice-barriers which clothe the lower slopes of some of the islands in Gerlache Strait. The Great Ice Barrier is in many ways different from these. Captain Scott showed that it was afloat for at least 400 m. of its extent from west to east. Sir Ernest Shackleton followed it for 400 m. from north to south, finding its surface in part thrown into long gentle undulations, but with no evidence of the surface being otherwise than level on the average. The all-but-forgotten experiments and cogitations of Biscoe convinced that shrewd observer that all Antarctic icebergs were sea-ice thickened with snow "accumulated with time." The recent expeditions seem to confirm this view to a great extent in the case of the Barrier, which, so far as the scientific men on the "Nimrod" could see, was formed everywhere of compressed névé, not of true glacier ice. Instances have been seen of tabular bergs floating with half their bulk above water, showing that they

are of very much less density than solid ice. The thrust of the glaciers which descend from the western mountains upon the Barrier throws it into sharp crevassed folds near the point of contact, the disturbance extending 20 m. from the tip of the Beardmore glacier, and the seaward creep of the whole surface of the Barrier is possibly due to this impulse, the rate of movement at the eastern side of the Barrier was found to be at the rate of 500 yds. per annum for the seven years between Scott's and Shackleton's expeditions.

Pack ice composed of broken-up sea-ice and fragments of icebergs appears to form a floating breakwater round the Antarctic area. It is penetrated by powerful steamers with ease or with difficulty according to the action of the wind which loosens the pack when it drives it towards the open sea, and closes it up when it drives it against a coast or a barrier of fast ice. At every point but one around the circumpolar area the pack, be it light or dense, appears to extend up to the southern permanent ice or land, though, as in the Weddell Sea, the pack seems at times to be driven bodily away. The exceptional region is the opening of the Ross Sea east of Cape Adare, where a comparatively narrow band of pack ice has always been penetrated by the resolute advance even of sailing ships and led to an extensive open sea to the south. No doubt the set of the ocean currents accounts for this, but how they act is still obscure. The great flat-topped ice-islands which in some years drift out from the Antarctic area in great numbers are usually met with in all parts of the Southern Ocean south of 50° S., and worn-down icebergs have been sighted in the Atlantic even as far north as 26° 30' S. The greater frequency of icebergs in the Southern Ocean in some years is attributed to earthquakes in the Antarctic breaking off masses of the floating edge of the Barrier.

Antarctic Climate.—Although a vast mass of observations has recently been accumulated, it is not yet possible to treat of the climate of the South Polar region in the same broad way as in the case of the North Polar region. The following table shows the mean temperatures of each month and of the year at all the stations at which, the Antarctic winter has been passed. The result is to show that while the winter is on the whole less severe at high latitudes than at equal latitudes in the north, the summer is very much colder, and has little relation to latitude. Even in the South Orkneys, in latitude 60°, in the three warmest months the air scarcely rises above the freezing point as an average, while in Shetland (60° N.) the temperature of the three summer months averages 54° F. But on the other hand, the warmest month of the year even in 77° S. has had a mean temperature as high as 30°. A study of the figures quoted in the accompanying table shows that until longer records

	Belgica 68° 70' S.		Cape Adare 77° S.		Snow Hill 64° 30' S.		Gauss 65° 2' S.		Discovery 77° 51' S.			Cape Royds 77° 37' S.		S. Orkneys 60° 44' S.		Wandel Island 65° S.		Petermann Island 65° 20' S.	
	1898.	1899.	1899.	1900.	1902.	1903.	1902.	1903.	1902.	1903.	1904.	1902.	1903.	1902.	1903.	1904.	1904.	1905.	1904.
Jan.		+20.8		+33.0		+30.0		+30.6		+26.1	+22.5		+26.1	+20.4	+21.3		+33.0		+24.0
Feb.		+30.2	(+26.4)			+24.4		(+25.0)	(+15.0)	+11.3	(+21.3)		+20.4	(+30.4)	+32.6		+31.2		+24.5
Mar.	+15.6		+17.7		+24.1	+11.0	+16.0		+ 8.0	- 0.8		+ 4.9		(+30.2)	+32.4	+29.8			+23.7
Apr.	+10.8		+10.3		+ 6.1	+ 6.7	+ 3.0		- 7.1	-16.9		-10.0		+20.6	+25.2	+22.6			+23.0
May	+20.3		- 4.6		+ 1.7	- 1.6	+ 6.8		-22.5	-26.0		- 5.5		+27.1	+20.3	+13.3			+22.7
June	+ 4.1		-11.8		- 0.4	- 6.8	+ 0.5		-26.0	-13.8		- 7.1		+ 0.5	+16.8	+11.8			+20.1
July	-10.3		- 8.6		-24.9	- 0.2	- 0.6		- 8.1	-21.1		-17.0		+16.0	+ 7.0	- 2.0			+19.7
Aug.	+11.7		-13.4		- 0.7	+ 3.8	- 7.4		-16.5	-16.5		-15.7		+18.8	+12.7	+20.5			+22.8
Sep.	- 1.3		-11.9		+ 5.3	+ 0.3	+ 0.1		-12.0	-18.6		- 5.7		+12.4	+20.3	+25.9			+27.4
Oct.	+17.8		- 8.8		+ 8.9	+19.0	+ 8.6		- 3.3	- 6.8		+ 4.5		+27.0	+18.4	+16.7			+27.7
Nov.	+26.6		+17.8				+10.0		+12.0	+15.4		+17.0		+20.3	+31.1	+31.5			+20.0
Dec.	+28.0		+37.8		+28.7		+30.0		+23.1	+25.7		+30.0		+21.3	+28.8	+21.2			(+23.0)
Year	+14.7		+ 7.0		+ 9.4		+11.3		+ 0.4		- 2.0		+ 3.4	+22.0	+22.4		+22.7		+26.0
Mar. 1 to Feb. 28			Feb. 1 to Jan. 31		Mar. 1 to Feb. 28		Feb. 29 to Feb. 18		Feb. 9 to Jan. 31		Feb. 1 to Jan. 31		Mar. 1 to Feb.				Feb. 1 to Jan.		Dec. 26 to Nov. 28

become available it is impossible to speak definitely as to the normal distribution of monthly temperature throughout the year, for even at the same station in consecutive years the months vary greatly. Thus at Snow Hill (65° S.) the mean temperature of August 1903 was 13.5° higher than that of August 1902, though June had been 7° colder; and at the "Discovery's" winter quarters July 1903 was 13° colder than July 1902 though June was 2° warmer, August having exactly the same mean temperature in each year. The mean temperature of the year is evidently higher in the position of the "Belgica's" drift than in Victoria Land at the same latitude; but it is noticeable that on the west side of Graham Land, where Charcot wintered, the average mean temperature was (taking the average of his two winterings) 15° higher than on the east side, where Nordenskjöld wintered in nearly the same latitude. The observations, however, were not synchronous, and it may not be right to compare them. We may perhaps say that along the whole of the known Antarctic coasts the temperature in the two midsummer months is within a degree or two of 32° F., and varies little from place to place or from year to year; but in the winter months the temperature is lower as the latitude increases and is subject to great variations from place to place and from year to year. It seems quite possible that at no place in the Antarctic region do the mean monthly sea-level winter temperatures fall so low as in the Arctic poles of cold, but data regarding winter temperatures in the interior are lacking. All the complete yearly series of temperature show that the winter six months from April to September have a low and nearly equal temperature, there being a very abrupt fall in February and March, and an equally abrupt rise in October and November. The warmest day experienced at the "Discovery's" winter-quarters had a mean temperature of 34.7°, and the coldest -45.7°, the extreme range of daily temperature being thus 80.4°.

The absolutely lowest temperature recorded in the Antarctic region was -66.8° on a journey southward from the "Discovery's" winter-quarters by Lieut. Barne on the 15th of September 1903; the lowest temperature at the winter-quarters was -58.5° on the 28th of September 1903. On Sir Ernest Shackleton's expedition the lowest temperature was -57°; but no other expedition met temperatures lower than -45.6° on the "Belgica," -43.1° at Cape Adare, and -41.4° on the "Gauss." Sudden rises of temperature during storms are common in the Antarctic region, from whichever quarter the wind blows.

During the ascent of Mt Erebus the temperature was found to fall as the height increased from 0° F. at sea-level to -24° at 5000 ft.; it remained stationary to 8600 ft., fell to -28° at 10,650 ft., and then rose to -22° at 11,500 ft., and fell a few degrees at the summit. It might appear as if the "isothermal layer" of the upper atmosphere had been reached at a remarkably low elevation; but the temperature variations may also be explained by differences in the temperature of the strong air currents which were passed through.

Pressure and Winds.—The normal fall of pressure southward, which gives rise to the strong westerly winds of the roaring forties, appears to be arrested about 65° S., and to be succeeded by a rise of pressure farther south. This view is supported by the frequency of south-easterly winds in the neighbourhood of the Antarctic Circle reported by all explorers, and the hypothesis of a south polar anticyclone or area of high pressure over the Antarctic continent has gained currency in advance of any observations to establish it. The complete data of Sir Ernest Shackleton's expedition are not available at the time of writing, but the yearly mean pressure as recorded at the "Discovery's" winter-quarters was 29.35 in. for 1902, and 29.23 in. for 1903. At Cape Adare it was 29.13 in. for 1899, in the "Belgica" 29.31 in. for 1898, and in the "Gauss" 29.13 in. for 1902. These figures, so far as they are comparable, show distinctly higher pressures in the higher latitudes, and the wind observations bear out the inference of a south-polar high pressure area, as at the "Discovery's" winter-quarters 80% of the winds had an easterly component, and only 3% a westerly component. It is bewildering,

however, to find that on the sledge journeys there was an equally marked preponderance of wind with a westerly component, and in discussing the result in the published records of the expedition Mr R. H. Curtis, of the Meteorological Office, felt compelled to ask whether the correction for variation of the compass (in that region about 145°) was possibly omitted in the case of the sledge journeys. The "Gauss" observations and those at Cape Adare bore out the frequency of easterly winds, and on the "Scotia" it was observed that practically all of the easterly winds met with were to the south of the Antarctic Circle. The "Belgica" found rather more westerly than easterly winds in her drift; easterly winds predominating in summer, westerly winds in winter. At Cape Royds Shackleton found easterly winds to predominate, the most frequent direction being south-east; but on the great southern journey, south-south-east winds prevailed, occasionally swinging round to south-south-west, and even at the farthest south (88° S.) the ridges into which the snow was blown, 10,000 ft. above the sea, showed that south-south-easterly winds predominated. On the journey to the Magnetic Pole Professor David found that along the coast the prevailing winds were south-westerly, with occasional blizzards from the south-east, but he noticed that the westerly winds were of the nature of a land breeze, springing up soon after midnight and continuing to blow fresh until about 10 a.m. Thus the balance of probability inclines towards the hypothesis of a south-polar high-pressure area. An upper current of air blowing from a north-westerly direction was usually indicated by the clouds and smoke on Mt Erebus, and on the occasion of a great eruption, when the steam column reached more than 20,000 ft. above the sea it entered a still higher stratum of wind blowing from the south-east.

The intensity of the blizzards is worthy of remark, for the velocity of the wind often reached 40 or even 60 m. an hour, and they were usually accompanied by a rapid rise of temperature.

Observations of sunshine made at the "Discovery's" winter-quarters yielded many records of continuous sunshine extending throughout 24 consecutive hours, and in the summer months about 50% of the possible sunshine was often recorded, the maximum being 490 hours, or 66% of the total possible for December 1903. Thus, although the sun was above the horizon only for 246 days, it shone sufficiently to yield more than 1725 hours of bright sunshine for the year, an amount exceeded in few parts of England, where the sun may shine on 305 days. The intensity of solar radiation in the clear weather of the Antarctic makes it feel exceedingly hot even when the air temperature is far below the freezing point. There is a great difference between the clear skies of 78° S. and the extremely frequent fogs which shroud the coast near the Antarctic Circle and render navigation and surveying exceedingly difficult. Heavy snowstorms are frequent on the coast, but inland during the snow blizzards it is impossible to say whether the whirling snow-dust is falling from the air or being swept from the ground. Professor David is inclined to believe that the surface of the snow-plains is being lowered more by the action of the wind sweeping the snow out to sea than it is raised by precipitation, the total amount of which appears to be very small.

Flora and Fauna.—Recent expeditions have discovered that, despite the low temperature of the summer, in which no month has a mean temperature appreciably above the freezing point, there are on the exposed Antarctic land patches of ground with a sparse growth of cryptogamic vegetation consisting of mosses, lichens, fungi and fresh-water algae. The richest vegetation discovered on the "Nimrod" expedition consisted of sheets of a lichen or fungoid growth, covering the bottom of the fresh-water lakes near Cape Royds, and visible through the clear ice throughout the many months when the water is frozen. No flowering plants occur within the Antarctic Circle or in the immediately adjacent lands.

The marine fauna is very rich and abundant. All the expeditions obtained many new species, and the resemblance which occurs between many of the forms and those which inhabit

the Arctic seas has given rise to the hypothesis that certain species have been able to pass from one frigid zone to the other. It is argued on the other hand that all the forms which resemble each other in the two polar areas are cosmopolitan, and occur also in the intermediate seas; but the so-called "problem of bipolarity" is still unsettled. Bird life on sea and land is fairly abundant, the most common forms being the skua gull, snary petrels, and the various species of penguins. The penguins are specially adapted for an aquatic life, and depend for their food entirely on marine animals. The largest species, the emperor penguin, inhabits the most southerly coast known on the edge of the Great Barrier, and there it breeds at mid-winter, very interesting specializations of structure and habit making this apparently impossible feat practicable. The social organization and habits of the various species of penguins have been carefully studied, and show that these birds have arrived at a stage of what might almost be called civilization worthy of the most intelligent beings native to their continent. The only mammalian life in the Antarctic is marine, in the form of various species of whales, but not the "right whale," and a few species of seals which live through the winter by keeping open blow-holes in the sea-ice. There is no trace of any land animal except a few species of minute wingless insects of a degenerate type. The fresh-water ponds teem with microscopic life, the tardigrada, or "water bears" and rotifers showing a remarkable power of resistance to low temperature, being thawed out alive after being frozen solid for months and perhaps for years.

AUTHORITIES.—H. R. Mill, *The Siege of the South Pole*, a history of Antarctic exploration with complete bibliography (London, 1903); K. Fricker, *Antarktis* (Berlin, 1898; trans. as *The Antarctic Regions* (London, 1900); A. Rainaud, *Le Continent austral* (Paris, 1893, historical); E. S. Balch, *Antarctica* (New York, 1902, historical); James Cook, *A Voyage Towards the South Pole and Round the World* (3 vols., London, 1777); H. Grævelius, *F. von Bellingshausen's Forschungsfahrt in südlichen Eismeer 1810-1821* (Leipzig, 1902); James Weddell, *A Voyage Towards the South Pole* (London, 1825); J. S. C. Dumont D'Urville, *Voyage au Pôle Sud et dans l'Océanie* (29 vols., Paris, 1841-1845); Charles Wilkes, *Narrative of the Exploring Expedition during 1838-1842* (6 vols., Philadelphia, 1845); J. C. Ross, *A Voyage of Discovery and Research in the Southern and Antarctic Regions* (2 vols., London, 1847); W. G. Burn-Murdoch, *From Edinburgh to the Antarctic* (London, 1894; an account of the voyage of the "Balaena," 1892-1893); H. J. Bull, *The Cruise of the "Antarctic" to the South Polar Regions* (London, 1896); the voyage to Victoria Land in 1894-1895); F. A. Cook, *Through the First Antarctic Night, 1898-1899* (New York and London, 1900); the voyage of the "Belgica"; A. de Gerlache, *Quinze mois dans l'Antarctique* (Paris, 1902); Georges Lecoq, *Au pays des Manchots* ("Belgica," Brussels, 1904); *Resultats du voyage du S. Y. "Belgica," Rapports scientifiques* (many vols., Brussels, v.d.); C. E. Borchgrevink, *First on the Antarctic Continent* (London, 1901); L. Bernacchi, *To the South Polar Regions* (London, 1901); the expedition of the "Southern Cross"; *Report on the Collections of the "Southern Cross"* (British Museum, London, 1902); G. Murray (editor), *The Antarctic Manual* (London, 1901); R. F. Scott, *The Voyage of the "Discovery"* (2 vols., London, 1905); A. B. Armitage, *Two Years in the Antarctic* (London, 1908); *National Antarctic Expedition 1901-1904* (scientific results published by the Royal Society, London, several vols., v.d.); G. von Neumayer, *Auf zum Südpol* (Berlin, 1901); E. von Dryzalski, *Zum Kontinent des eisigen Südens* (Berlin, 1904); Scientific Results of the "Gauss" expedition; Otto Nordenskjöld and J. G. Andersson, *Antarctica* (London, 1905); R. N. R. Brown, R. C. Mossman and J. H. H. Pirie, *The Voyage of the "Scotia"* (London, 1906); *Report on the Scientific Results of the Voyage of the "Scotia"* (several vols., Edinburgh, v.d.); J. B. Charcot, *Le Français au Pôle Sud* (Paris, 1906); E. H. Shackleton, *The Heart of the Antarctic* (2 vols., London, 1909); *British Antarctic Expedition 1907-1909, Reports on the Scientific Investigations* (several vols., London, v.d.). (H. R. M.)

POLDER, the Dutch name for a piece of low-lying, marshy land reclaimed from the sea or other water by drainage and diking (see HOLLAND).

POLE (FAMILY). The family of the Poles, earls and dukes of Suffolk, which, but for Richard III.'s defeat at Bosworth, might have given the next king to England, had its origin in a house of merchants at Kingston-upon-Hull. It has been said that these Poles were the first English peers whose fortunes had been founded upon riches gained in trade; but the Berkeleys, descendants of Robert fitz Harding, the rich burghers of Gloucester,

must perhaps be reckoned before them. Their pedigree begins with one William atte Pole (d. c. 1329), a merchant of Ravensrode who settled in Hull, where his widow became the wife of John Rotenhering, also a merchant. His sons, Sir Richard and Sir William atte Pole, were both famous for their wealth at a time when the Crown had great need of rich men's aid. Sir Richard (d. 1345), the king's butler in 1327, removed to London, and is styled a London citizen in his will. The male line of this, the elder branch of the Poles, failed with a grandson, John Pole, who by his marriage with Joan, daughter of John, Lord Cobham, was father of Joan, Lady of Cobham, the Keatish heiress whose lands brought her five knightly husbands, the fourth of them Sir John Oldcastle the Lollard.

Sir William atte Pole (d. 1366), the second son of William, joined his brother in advancing large sums to the government while keeping safely apart from politics. The first mayor of Hull, he sat for Hull in five parliaments, and was advanced to be knight banneret and a baron of the exchequer. He was counted "second to no merchant in England," but after his time his descendants left the counting-house, his four sons all serving in the French wars. The eldest son, Michael Pole, who had fought under the Black Prince and John of Gaunt, was summoned as a baron in 1366, before the father's death, and, as a stout supporter of the Crown, was appointed in 1381 governor of the person of the young king Richard II., whose marriage with the Lady Anne of Bohemia he had arranged on a visit to her brother the king of the Romans. In 1383, he became chancellor of England and thereafter, as the loyal servant and nearest counsellor of the king, he had to face the jealousy of the great lords and the hatred of the Commons. His wealth added to the envy of his enemies, for, to his inherited Yorkshire and Lincolnshire lands, his marriage with Catherine, daughter and heir of Sir John of Wingfield, added a great Suffolk estate, where, fortifying the manor-house of the Wingfields, he made his chief seat. In 1385 he was created earl of Suffolk, a grant from the Crown giving him the castle and honour of Eye with other East Anglian lands formerly held by the Usford earls. In 1386 the opposition, led by Gloucester, the king's uncle, pulled him down. He was dismissed from his chancellorship, and impeached by the Commons on charges which, insufficient upon the face of them, secured his conviction. Richard was forced to send his minister into ward at Windsor until the parliament was dissolved, when Suffolk once more appeared as the leader of the king's party. But the opposition was insistent, and Suffolk, after Richard had been compelled to give his word that those who had advised him ill should answer for it to the next parliament, fled over sea to Calais. One of the earliest of the many popular songs that bark against the Poles tells joyfully of this flight of the detested "Jake." Sentence of death by the gallows was passed in his absence. The over-zealous governor of Calais who found him at his gates, clad as a poor Fleming, his chin shaved, packed him back to England, whence he escaped again, doubtless with the king's aid, reaching his native town of Hull, where he saw for the last time his "goodly house of brick." Old friends found him a ship that landed him in the Low Countries, and he died an exile in Paris in 1389.

The exile's son Michael, who had married Catherine, daughter of the earl of Stafford, was restored to the earldom in 1397, and, although his father's attainder was revived by the act of the first parliament of Henry IV., the earldom was restored once again in 1399, together with the castle and honour of Eye. His life was that of a soldier, and he was with the host before Harfleur in 1415, when he died of a violent dysentery. Michael, the eldest son and heir, marched from his father's deathbed to Agincourt, where he fell, Drayton's ballad recalling how he plied his axe on the great day. By his wife, a daughter of the first duke of Norfolk, he had three daughters, but no one of them marrying, his lands passed with the earldom to his brother William.

This William (1396-1450), the fourth earl of his name, had sailed with his father and elder brother to Harfleur, but had

been sent home sick after the siege. He returned with the "viage" of 1417, leading thirty men-at-arms and ninety archers. Henry V. made him admiral of Normandy, and until the crowning of Henry VI. in Paris in 1431 he served in France without, by his own account, coming home or seeing England. He held the chief command before Orleans after Salisbury had fallen to a cannon-shot from the city, but was forced to surrender to Joan of Arc at Jargeau, where his brother Alexander was killed, another brother, John, being taken prisoner with the earl. A fourth brother, Thomas, a clerk, became hostage to Dunois until the vast ransom of the earl was paid down. After 1431 Suffolk turned to English politics. Like his grandfather, he found a king's uncle, another Gloucester, the chief of his enemies. Defeating Gloucester's project of an Armagnac match, Suffolk arranged for the young king's marriage with Margaret of Anjou, and brought home the bride to Portsmouth in 1445. In the year before he had been created marquis of Suffolk, being the fourth Englishman to take the style of marquis. His party and the queen's were on the point of overthrowing their opponent, Gloucester, when the "good duke" died suddenly in the hands of those who had arrested him. This death, followed by that of Cardinal Beaufort, left the field to Suffolk. Under a patent of 1443 Suffolk became earl of Pembroke at Duke Humphrey's death. His honours were capped in 1448 with a dukedom of Suffolk, he being then admiral of England, governor of Calais, constable of Dover, and warden of the Cinque Ports. But it seemed that long service in the foreign wars had not purged the offence of the name of Pole. All the old enmity which had driven his grandfather into exile was gathering against Suffolk. His peace policy had cost the cession of Maine and Anjou, while the blunders of his ally, Somerset, as lieutenant in France, lost Normandy to England. Early in 1450 the Commons, in spite of Suffolk's appeal to his years of loyal service, accused him of treason and he was sent to the Tower. A long indictment was reinforced by new accusations, and the king could do no more for his minister than set him free under a sentence of five years' banishment. He sailed from Ipswich on the May Day of 1450, but before he could enter the port of Calais he was cut off by a royal ship, the "Nicholas," whose master had him put overboard into the cock-boat, where his head was hacked off by an Irish knave's rusty sword. His body, cast headless upon Dover beach, was carried by the king's orders to the Poles' vault in Wingfield church, where his effigy may still be seen. Who sent out the "Nicholas," and by whose orders Suffolk died, are questions which remain unanswered. He was the third husband of Alice Chaucer, whom he married as the widow of Thomas, Earl of Salisbury, slain before Orleans. She was the daughter and heiress of Thomas Chaucer, of Ewelme, and, although direct evidence is wanting, the granddaughter, without doubt, of Geoffrey Chaucer, the poet. She lies at Ewelme, under a magnificent tomb.

John Polé (1442-1491), only son of the murdered duke, should have succeeded to the dukedom, his father having died unattainted. But the honours were apparently regarded as forfeited, and the dukedom was formally restored to the boy in 1455, the earldom of Pembroke being allowed to lapse. Although three generations of warrior lords lay between him and the Hull warehouses, the origin of his house was still fresh in men's memories. John Paston, writing in 1465, could tell every name in the duke's pedigree back to "William Pool of Hull," who had been "first a merchant and after a knight," and "what the father of the said William was" John Paston knew "right well." The duke's father was an upstart for the crowd, whose ballads pelted him with the name of "Jac Napes," suggested by his familiar badge of the ape's clog and chain. Nevertheless a wife of royal blood was found for the young duke, King Edward IV.'s own sister Elizabeth. The marriage confirmed him a partisan of the White Rose. The son of Margaret's faithful minister rode against her man at the second battle of St. Albans. Before he was of age he was steward of England at his brother-in-law's crowning, and at

Queen Elizabeth's crowning he bore her sceptre. Having held many offices under Edward IV. he was ready to bear a sceptre at Richard's coronation, and, after Bosworth, to swear fealty to the Tudor dynasty and to bear another sceptre for another Queen Elizabeth. He died in 1491, having safely kept his lands, his dukedom, and his head through perilous years.

But each advance in rank had brought danger and misfortune to the Poles. Before the death of the second duke they had begun to pay the price of their matching with the royal house. In the next generation their name was blotted out. John Pole, eldest son of Duke John and the Lady Elizabeth, had been created Earl of Lincoln by his uncle, Edward IV. Before he followed Richard to Bosworth, the young man had been chosen as heir to the throne, Clarence's son Warwick being put aside. He survived Richard and Henry VII. spared him. But he egged on Simnel's plot, joined the rebels in Ireland, and was killed at Stoke in 1487, leaving no issue by his wife, the daughter of the earl of Arundel. Edmund, his younger brother, (c. 1472-1513) should have succeeded in 1491 as duke of Suffolk, but on coming of age he agreed to satisfy himself with the title of earl of Suffolk, the king grudgingly restoring some portion of the estates forfeited by his brother. In 1499 he suddenly left the kingdom, but was persuaded to return. But the death of the imprisoned earl of Warwick may have suggested to him that Henry's court was a dangerous place for those of the blood of York, and in 1501 he found his way to the emperor Maximilian in Tirol with a scheme for the invasion of England. Although the kaiser at first promised him men for the adventure, nothing came of his promises. Maximilian, persuaded by a gift of English money, bound himself not to succour English rebels. Suffolk, who had reassumed the ducal style, was attainted in 1504, and in the same year was seized by the duke of Guelders. From the duke's hands the prisoner was taken by Philip, king of Castile, who surrendered him to England on a promise that his life should be spared. But in 1513, when Richard, his brother, was in arms in the French service, Edmund Pole was taken from his prison in the Tower to the block.

Richard Pole, who in 1501 escaped from England with Edmund, had been received by the king of Hungary, and afterwards by Louis of France, who assigned him a pension. Commanding German Lanzknechts in the French service, he was the friend and companion in arms of the chevalier Bayard. At the death of his brother Edmund, he took the title of the duke of Suffolk, claiming the throne of England. In 1514 Louis gave him the leading of 12,000 riotous German mercenaries to essay the conquest of England. The treaty of peace stayed the adventure, but Louis refused to surrender Richard, and allowed him to depart for the imperial city of Metz. Francis I. continued the payment of his allowance, and gave him employment. In 1522 the anonymous writer of a journal describes the coming to Paris of "Richard de la Poulle, soydisant duc de Suffort et la Blanche Rose." In 1525 the White Rose was killed by the French king's side at Pavia. With him died the last descendant in the male line of William Pole, the Hull merchant.

By one of the strange chances of history, another family of the name of Pole, having no kinship with the house of Suffolk, owed, like the Suffolks, their advancement and their fall to a match with a princess of the royal house. Sir Richard Pole, a Buckinghamshire knight, was the son of Geoffrey Pole, a squire whose wife, Edith St John, was sister of the half-blood to the mother of Henry VII. About 1490 or 1491 he married the Lady Margaret, daughter of George, duke of Clarence. He died in 1505, and in 1513 King Henry VIII. created the widow countess of Salisbury, as some amends for the judicial murder of her brother, the Earl of Warwick. Four years later, the barony of Montague was revived for her eldest son Henry. Until the king's marriage with Anne Boleyn, the countess of Salisbury was about the court as governess of her godchild, the Lady Mary. When her son, the famous Cardinal Pole, published his treatise,

De unitate ecclesiastica, the whole family fell under the displeasure of the king, who resolved to make an end of them. The Lord Montague was the first victim, beheaded in 1539 on a charge of treasonable conversations, evidence having been wrung from his unhappy brother, Sir Geoffrey Pole. In 1541 the aged countess, attainted with her son Montague, met her death at the barbarous hands of an unskilful headsmen. Sir Geoffrey Pole, seeing that his house was doomed, fled the country, and joined the cardinal in exile. He returned with him at Mary's accession, both dying in 1558. His sons Arthur and Edmund, taken in 1562 as plotters against Queen Elizabeth, were committed to the Tower of London, where they died after eight years of imprisonment.

See T. Rymer's *Foedera*; C. Frost, *History of Hull* (1827); *Chronicon de Melsa* (Rolls Series); G. E. C., *Complete Peerage*; *Testamentis Eboracensis* (Surtees Soc.); Hon. and Rev. H. A. Napier, *Swinscombe and Ewelme* (1858); *Dict. Nat. Biog.*, s.v. "Pole"; E. Foss, *Judges of England* (1848-1864); *Chronicon Angliæ* (Rolls Series); *Paston Letters*, edited by J. Gairdner; Sir J. H. Ramsay, *Lancaster and York* (1892); *Letters and Papers of Richard III.* and *Henry VII.* (Rolls Series); *Inquests post mortem*, Close and Patent Rolls, Rolls of Parliament. (O. BA.)

POLE, REGINALD (1500-1558), English cardinal and archbishop of Canterbury, born at Stourton Castle, Staffordshire, was the third son of Sir Richard Pole, Knight of the Garter, and Margaret, countess of Salisbury, a daughter of George, duke of Clarence, and therefore niece of Edward IV. He was intended for the church from his youth; and when seven years old was sent for five years to the grammar school which Colet had founded near the Carthusian monastery at Sheen. Here he had Linacre and William Latimer as teachers. In his thirteenth year he went to Magdalen College, Oxford, and two years after took his degree in arts. In 1517 Henry VIII. appointed his young kinsman to a prebend in Salisbury, and soon afterwards to the deaneries of Wimborne and Exeter. He was a friend of Sir Thomas More, who says that Pole was as learned as he was noble and as virtuous as he was learned. In 1519, at the king's expense, he went to Padua, the Athens of Europe, according to Erasmus; and there, where Colet and Cuthbert Tunstall had also been educated, the "nobleman of England" as he was called, came into contact with the choicest minds of the later Italian Renaissance, and formed the friendships that influenced his life.

In 1525 he went to Rome for the Jubilee, and two years after returned to England and was initiated by Thomas Cromwell into the mysteries of statesmanship, that master telling him that the main point consisted in discovering and following the will of princes, who are not bound by the ordinary code of honour. When the divorce question arose, Pole, like many other excellent men, seems at first to have been in his favour. He probably took the same view that Wolsey had, viz. that the dispensation of Julius II. was insufficient, as of two existing diriment impediments only one had been dispensed. When however the king raised the theological argument which ended in disaster, Pole could not accept it; and, after the failure of Campeggio's mission, when the king asked him for his opinion, he excused himself on the score of inexperience, but went by Henry's order to Paris (1530) to obtain the judgment of the Sorbonne, making the condition that another should be joined with him to do the necessary business. At this time, he says, the more he saw into the case the less he knew how to act as he was desired. On his return to England he spoke strongly against the project to the king, who seems to have dealt gently with him in the hope of using him for his own ends. He offered him the sees of York or Winchester, and kept them vacant for ten months for his acceptance. There was a stormy interview at York Place; but Pole succeeded in mollifying the king's rage so far that Henry told him to put into writing his reasons against the divorce. This was done, and, recognizing the difficulties of the situation, the king gave him leave to travel abroad, and allowed him still to retain his revenues as dean of Exeter. In 1535, which saw by the deaths of Bishop Fisher and Sir Thomas More a change in Henry's policy, Pole received orders to send

a formal opinion on the royal supremacy, and the king promised to find him suitable employment in England, even if the opinion were an adverse one. The parting of the ways had been reached. Pole's reply, which took a year to write, and was afterwards published with additions under the title *Pro unitate ecclesiæ*, was sent to England (May 25, 1536) and was meant for the king's eye alone. It contained a vigorous and severe attack upon the royal policy, and did not shrink from warning Henry with temporal punishment at the hands of the emperor and the king of France if he did not repent of his cruelties and return to the Church. He was again summoned to return to England to explain himself, but declined until he could do so with honour and safety; but he was on the point of going at all risks, when he heard from his mother and brother that the whole family would suffer if he remained obstinate. Paul III. who had prepared a bull of excommunication and deposition against Henry, summoned Pole to Rome in October, and two months after created him cardinal. In January 1537 he received a sharp letter of rebuke from the king's council, together with the suggestion that the differences might be discussed with royal deputies either in France or Flanders, provided that Pole would attend without being commissioned by any one. He replied that he was willing and had the pope's leave to meet any deputies anywhere. Paul III. in the early spring of that year named him legate *a latere* to Charles V. and Francis I., for the purpose of securing their assistance in enforcing the bull by helping a projected rising in England against Henry's tyranny. The mission failed, as the mutual jealousy of the sovereigns would not allow either to begin operations. Moreover, the fear of Henry was sufficient to make the French king refuse to allow one who was attainted by act of parliament to remain in the kingdom; so Pole passed over to Flanders, to wait for the possible arrival of any royal deputies. The proposed conference never took place, and in August 1537 the cardinal returned to Rome. There he was appointed to the famous commission which Paul III. established for considering the reforms necessary for the church and Roman curia. The report *Consilium delectarium cardinalium* is, in its plain-spoken directness, one of the most noteworthy documents of the history of the period. Towards the end of 1539, after Henry had destroyed the shrine of St Thomas Becket, another attempt was made to launch the bull of deposition, and Pole again was sent to urge Charles V. to assist. Once more his efforts were in vain, and he retired to his friend Sadoleto at Carpentras. As Pole had escaped Henry's power the royal vengeance now fell on his mother, who was executed as a traitor on the 27th of May 1541. When the news came to the cardinal he said to his secretary Beccatelli that he had received good tidings: "Hitherto I have thought myself indebted to the divine goodness for having received my birth from one of the most noble and virtuous women in England; but henceforth my obligation will be much greater, as I understand I am now the son of a martyr. We have one patron more added to those we already have in heaven"; and returning to his oratory Pole found peace in his sorrow.

On the 21st of August 1541 the cardinal was appointed legate at Viterbo, and for a few years passed a happy and congenial life amid the friends that gathered round him. Here he came into close relations with Vittoria Colonna, Contarini, Sadoleto, Bembo, Morone, Marco Antonio, Flaminio, and other scholars and leaders of thought; and many of the questions raised by the Reformation in Germany were eagerly discussed in the circle of Viterbo. The burning question of the day, justification by faith, was a special subject of discussion. The "dolce libricino," the famous *Trattato utilissimo del beneficio di Gesù Christo crocifisso verso i christiani*, which was the composition of a Sicilian Benedictine and had been touched up by the great latinist Flaminio, just appeared at Mantua in 1542 under the auspices of Morone, and had a wide circulation (over 40,000 copies of the second edition, Venice 1543, were sold). Containing extracts from the Hundred and Ten Divine Considerations of Juan Valdes (q.v.),

it was soon regarded with the utmost horror by many. But at Viterbo it was in favour, and the orthodox interpretation was regarded rather than the other which might be taken in the Lutheran sense. Pole's own attitude to the question of justification by faith is given by Vittoria Colonna, to whom he said that she ought to set herself to believe as though she must be saved by faith alone and to act as though she must be saved by works alone. In the excited temper of the times any defender of justification by faith was looked upon by the old school as heretical; and Pole, with the circle at Viterbo, was denounced to the Inquisition, with all sorts of crimes imputed to him. Though the process went on from the pontificate of Paul III. to that of Paul IV., nothing was done against the cardinal until the time of the latter pope, who was his personal enemy. It is by no means certain that Pole ever knew about the process begun against him; and immediate subsequent events show that no credence was given to the charges.¹

While at Viterbo his rule was firm but mild; and no charge of persecuting heretics is made against him. He regained many, such as his friend Flaminio, by patience and kindness, to a reconsideration of their errors. During this time also he was still engaged in furthering a proposed armed expedition to Scotland to aid the papal party, and in 1545 he was again asking help from Charles V. But the Council of Trent (q.v.), first summoned in 1536, was at last on the point of meeting, and this required all his attention. In 1542 he had been appointed one of the presiding legates and had written in preparation his work *De concilio*; and now in 1545, after a brief visit to Rome, he went secretly, on account of fear of assassination by Henry's agents, to Trent, where he arrived on the 4th of May 1545. At the council he took a high spiritual line, and his learning and devout life made him a great leader in that assembly. He advocated that dogmatic decrees should go together with those on reform as affording the only stable foundation. His views on the subject of original sin, akin as it is to that of justification, were accepted and embodied in the decree. He was present when the latter subject was introduced, and he entreated the fathers to study the subject well before committing themselves to a decision. On the 28th of June 1546 he left Trent on account of ill-health and went to Padua. While he was there frequent communications passed between him and the council and the draft of the decree on justification was sent to him. His suggestions and amendments were accepted, and the decree embodies the doctrines that Pole had always held of justification by a living faith which showed itself in good works. This effectually disproves the story that he left the Council of Trent so as to avoid taking part in an adverse decree.

On the death of Henry (Jan. 28, 1547), Pole, by name, was left out of the general pardon; and in the subsequent rising in the West the insurgents demanded that he should be sent for and made the first on the record in the council. He wrote several times to England to prepare a conference, but only received a rude reply from Somerset, who sent him a copy of the Book of Common Prayer. At the conclave of 1549 Pole received two-thirds of the votes, but by a delay, caused by his sense of responsibility, he lost the election and Julius III. succeeded. He then retired to Magazzano on the Lake of Garda and occupied himself by editing his book *Pro unitate ecclesie*, with an intended dedication to Edward VI.

The accession of Mary opens the third period of his life. On the 5th of August 1553 he was appointed legate to the new queen and began his negotiations. But many difficulties were put in the way of return. He was still under attainder; and the temper of England was not yet ripe for the presence of a cardinal.

¹ See, however, Herzog-Hauck, *Realencyklopädie* (ed. 3) § "Pole," where it is said that "only his procrastination, and then his death saved him from appearing before the Inquisition." Within the institution of the Inquisition his name continued to be regarded as that of a heretic and misleader of others, as is proved by the mass of evidence accumulated against him in the *Compendium Inquisitionum* (v. *archivio della società di storia patria*, Rome, 1880), p. 283, &c.—(Ed.)

The project of the queen's marriage was also an obstacle. A marriage between her and Pole, who was then only a deacon, was proposed by some, but this did not at all meet the views of the emperor, who therefore hindered him the more from setting out for England. The marriage with Philip, of which Pole did not approve, having taken place (July 25, 1554), and Rome yielding on the practical difficulties of the lay holders of Church lands, a parliament favourable to the proposed reunion now assembled, and Pole was allowed to return to England as cardinal. On his landing he was informed that the attainder had been reversed; and he received the royal patent authorizing his performance of the legatine duties within the realm. Arriving at Whitehall, where he was received with joy by Mary and Philip on the 30th of November, he proceeded to parliament and there absolved the kingdom and accepted in the pope's name the demands respecting ecclesiastical property. He entered wisely on his work of reformation, for which he was well prepared. One of the most important matters he had to deal with was to rectify the canonical position of those who had been ordained or consecrated since the breach with Rome. Acting according to the instructions he had received from Rome, where the matter had been fully gone into, he made an investigation, and divided the clergy ordained after that period into two classes; one consisting of those ordained in schism, indeed, but according to the old Catholic rite, and the other of those who had been ordained by the new rite drawn up by Cranmer and enforced by act of parliament 1st of April 1550. The first class, after submission, were absolved from their irregularity, and, receiving penance, were reinstated; the second class were simply regarded as laymen and dismissed without penance or absolution. At his first convocation he exhorted the bishops to use gentleness rather than rigour in their dealings with heretics; and Pole, in himself, was true to his principle. He was not responsible for the cruel persecution by which the reign was disfigured. On the 4th of November 1555 Pole opened, in the chapel royal at Westminster, a legatine synod, consisting of the united convocations of the two provinces, for the purpose of laying the foundations of wise and solid reforms. In the *Reformatio Angliæ* which he brought out in 1556, based on his Legatine Constitutions of 1555, he ordered that every cathedral church should have its seminary, and the very words he uses on this subject seem to have been copied by the Council of Trent in the twenty-third session (1563). He also ordered that the Catechism of Caranza, who, like him, was to suffer from the Inquisition for this very book, should be translated into English for the use of the laity. On Cranmer's deprivation, Pole became archbishop of Canterbury; and, having been ordained priest two days before, he was consecrated on the 22nd of March 1556, the day after Cranmer suffered at Oxford.

Soon afterwards the clouds began to gather round him. His personal enemy Caraffa had become pope under the name of Paul IV. and was biding his time. When Rome quarrelled with Spain, and France, on behalf of the pope, took up arms, England could no longer observe neutrality. To injure Spain and heedless of England's need, Paul IV. deprived Pole of his power both as legate *a latere* and *legatus natus* as archbishop of Canterbury (June 14, 1557); he also reconstituted the process of the Inquisition against the cardinal and summoned him to Rome to answer to the crime and heresies imputed to him. No remonstrances on the part of the queen, of Pole or the English clergy could induce the pope to withdraw his sentence except to declare that the cardinal still held the position of *legatus natus* inherent in the primatial see. In a dignified but strong letter Pole says: "As you are without example in what you have done against me, I am also without an example how I ought to behave to your Holiness"; and he drew up a paper containing an account of the various acts of hostility he had experienced from the pope, but on second thoughts he burnt the document, saying it were not well to discover the shame of his father. Mary, who had been warned by her ambassador to the pope that prison awaited Pole, prevented the breve ordering the cardinal to proceed to Rome from being delivered,

and so Pole remained in England. Broken down as much by the blow as by ill-health the cardinal died at Lambeth on the 17th of November 1558, twelve hours after Mary's death and under the unmerited disgrace of the papacy in defence of which he had spent his life. He was buried at Canterbury near the spot where the shrine of St Thomas Becket once stood.

The chief sources for Pole's biography are his life written in Italian by his secretary Beccatelli, which was translated into Latin by Andrew Dudith as *Vita Poli cardinalis* (Venice, 1563), and his letters (*Epistolae Reginaldi Poli*) edited by Girolamo Quirini and published in 5 volumes (Brescia, 1744-1757), a new edition of which is in preparation at Rome with additions from the Vatican Archives. See also the State Papers (foreign and domestic) of Henry VIII., Edward VI. and Mary; the Spanish and Venetian State Papers; vol. i. of A. Theiner's *Acta genuina S.S. Oecumenici Concilii Tridentini* (1874); the *Compendio dei processi del santo ufficio di Roma da Paolo III. a Paolo IV.* (Società romana di storia patria, Archivio, iii. 261 seq.); T. Philipp's *History of the Life of R. Pole* (Oxford, 1764-1767); Athanasius Zimmermann, S.J., *Kardinal Pole sein Leben und seine Schriften* (Regensburg, 1893); Martin Haile, *Life of Reginald Pole* (1910); and F. G. Lee, *Reginald Pole*. (E. N.)

POLE, RICHARD DE LA (d. 1525), pretender to the English crown, was the fifth son of John de la Pole (1442-1491), 2nd duke of Suffolk, and Elizabeth, second daughter of Richard, duke of York and sister of Edward IV. His eldest brother John de la Pole, earl of Lincoln (c. 1464-1487), is said to have been named heir to the throne by his uncle Richard III., who gave him a pension and the reversion of the estates of Lady Margaret Beaufort. On the accession of Henry VII., however, Lincoln took the oath of allegiance, but in 1487 he joined the rebellion of Lambert Simnel, and was killed at the battle of Stoke. The second brother Edmund (c. 1472-1513), succeeded his father while still in his minority. His estates suffered under the attainer of his brother, and he was compelled to pay large sums to Henry VII. for the recovery of part of the forfeited lands, and also to exchange his title of duke for that of earl. In 1501 he sought the German King Maximilian in Tirol, and received from him a promise of substantial assistance in case of an attempt on the English crown. In consequence of these treasonable proceedings Henry seized his brother William de la Pole, with four other Yorkist noblemen. Two of them, Sir James Tyrell and Sir John Wyndham, were executed, William de la Pole was imprisoned and Suffolk outlawed. Then in July 1502 Henry concluded a treaty with Maximilian by which the king bound himself not to countenance English rebels. Presently Suffolk fell into the hands of Philip, king of Castile, who imprisoned him at Namur, and in 1506 surrendered him to Henry VII. on condition that his life was spared. He remained a prisoner until 1513, when he was beheaded at the time his brother Richard took up arms with the French king. Richard de la Pole joined Edmund abroad in 1504, and remained at Aix as surety for his elder brother's debts. The creditors threatened to surrender him to Henry VII., but, more fortunate than his brother, he found a safe refuge at Buda with King Ladislas VI. of Hungary. He was exempted from the general pardon proclaimed at the accession of Henry VIII., and when Louis XII. went to war with England in 1512 he recognized Pole's pretensions to the English crown, and gave him a command in the French army. In 1513, after the execution of Edmund, he assumed the title of earl of Suffolk. In 1514 he was given 12,000 German mercenaries ostensibly for the defence of Brittany, but really for an invasion of England. These he led to St Malo, but the conclusion of peace with England prevented their embarkation. Pole was required to leave France, and he established himself at Metz, in Lorraine, and built a palace at La Haute Pierre, near St Simphorien. He had numerous interviews with Francis I., and in 1523 he was permitted, in concert with John Stewart, duke of Albany, the Scottish regent, to arrange an invasion of England, which was never carried out. He was with Francis I. at Pavia, and was killed on the field on the 24th of February 1525.

See *Letters and Papers Illustrative of the Reigns of Richard III. and Henry VII.*, edited by J. Gairdner (2 vols., "Kolls Series," 24, 1861);

Calendar of Letters and Papers, Foreign and Domestic, of the Reign of Henry VIII.; and Sir William Dugdale, *The Baronage of England* (London, 1675).

POLE, WILLIAM (1814-1900), English engineer, was born at Birmingham on the 22nd of April 1814. He was a man of many accomplishments. Having spent his earlier years in various engineering occupations in England, he went out to India in 1844 as professor of engineering at Elphinstone College, Bombay, where he had to first organize the course of instruction for native students, but his health obliged him to return to England in 1848. For the next ten years he worked in London under James Simpson and J. M. Rendel, and the high reputation he achieved as a scientific engineer gained his appointment in 1859 to the chair of civil engineering in University College, London. He obtained a considerable amount of official work from the government. He served on the committees which considered the application of armour to ships and fortifications (1861-1864), and the comparative advantages of Whitworth and Armstrong guns (1863-1865). He was secretary to the Royal Commission on Railways (1865-1867), the duke of Richmond's Commission on London Water (1867-1869), also taking part in the subsequent proceedings for establishing a constant supply, the Royal Commission on the Disposal of London Sewage (1882-1884), and the departmental committee on the science museums at South Kensington in 1885. In 1871 he was employed by the War Office to report on the Martini-Henry rifle, and in the same year was appointed consulting engineer in London to the Japanese government, a position through which he exercised considerable influence on the development of the Japanese railway system. He was elected a fellow of the Royal Society in 1861, in recognition of some investigations on colour-blindness. Music was also one of his chief interests. At the age of twenty-two he was appointed organist of St Mark's, North Audley Street, in open competition, the next selected candidate being Dr E. J. Hopkins (1818-1901), who subsequently was for fifty years organist of the Temple Church. He took the degree of Bachelor of Music at Oxford in 1860, proceeding to his doctor's degree in 1867, and in 1879 published his *Philosophy of Music*. He was largely concerned in the institution of musical degrees by the University of London in 1877, and for many years acted as one of the examiners. His mathematical tastes found congenial occupation in the study of whist, and as an exponent of the scientific principles of that game he was even earlier in the field than "Cavendish." His literary work included treatises on the steam-engine and on iron construction, biographical studies of famous engineers, including Robert Stephenson and I. K. Brunel, Sir William Fairbairn and Sir W. Siemens, several books on musical subjects and on whist, and many papers for reviews and scientific periodicals. He died on the 30th of December 1900. His son, William Pole (1852-), became known as an actor and writer under the stage-name of William Poel, more especially for his studies in Shakespearian drama and his work in connexion with the Elizabethan Stage Society.

POLE (1) (O. Eng. *þal*, cf. Ger. *Fahle*, Du. *paal*, from Lat. *palus*, stake), a tapering cylindrical post or stake of some considerable length, used as a support in scaffolding, for telegraph or telephone wires, hops, &c., and as a means for taking jumps (see **POLE-VAULTING**), and also as a single shaft for a vehicle drawn by two or more horses. As a measure of length a "pole" also called "rod" or "perch" is equal to 5½ yds. (16½ ft.), as a measure of area it is equal to 30½ sq. yds. (2) (Lat. *polus*, adapted from Gr. *πόλος*, pivot, axis), one or other of the extremities of the axis of the earth; the "celestial pole" is one or other of the points in the heavens to which the earth's axis points; in the northern hemisphere this point is near the star *Ursae minoris*, better known as the Pole-star or *Polaris* (see **URSA MAJOR**). For the regions lying about the north and south poles of the earth see **POLAR REGIONS**.

In mathematics the word pole has several meanings. In spherical trigonometry the "pole" of a circle on a sphere is the point where the diameter of the sphere perpendicular to the plane of the circle intersects the sphere. In crystallography (q.v.) the "pole" of a face is the intersection of a line perpendicular to the face with

the sphere of projection. The term is also applied to a point from which lines radiate, as, for instance, the origin in a system of polar co-ordinates, or the common point of a pencil of rays. In the geometry of conic sections the "pole" of a line, termed the "polar" of the point, is the intersection of the tangents (either real or imaginary) at the points where the line meets the conic (see GEOMETRY: § *Projective*). The "magnetic poles" of the earth are the points on the earth's surface where the dipping needle is vertical (see TERRESTRIAL MAGNETISM); and the "poles" of a magnet are the points of the magnet where the magnetic intensity is greatest. In electricity, the term is applied to the elements of a galvanic battery (q.v.), or to the terminals of a frictional electrical machine.

POLECAT, the common name given to any member of the Musteline genus *Putorius* (see CARNIVORA). The polecats form a small group confined to the northern hemisphere, of which the best known and most widely distributed is the common polecat of Europe (*P. foetidus* or *P. putorius*). This animal, at least so far as its disposition, size and proportions are concerned, is well known in its domesticated condition as the ferret, which is but a tamed albino variety of the true polecat. The colour of the latter, however, instead of the familiar yellowish-white of the ferret, is of a dark brown tint above and black below, the face being variegated with dark brown and white markings. Its skull is rough, strongly ridged, and altogether of a far more powerful type than those of the stoats, weasels or martens; the skull of the female is very much smaller and lighter than that of the male. The fur is long, coarse, and of comparatively small value, and changes its colour very little, if at all, at the different seasons of the year.



The Common Polecat.

The polecat ranges over the greater part of Europe, reaching northwards into southern Sweden and in Russia to the region of the White Sea. It does not occur in the extreme south, but is common everywhere throughout central Europe. In the Alps it ranges far above the tree-line during the summer, but retreats in winter to lower ground. It is confined to the northern counties of England and Scotland, where it is becoming very rare, owing to persecutions from game-keepers, and in Ireland it appears to be extinct. In fine weather it lives either in the open air, in holes, fox-earths, rabbit-warrens, under rocks or in wood-stacks; while in winter it seeks the protection of deserted buildings, barns or stables. During the day it sleeps in its hiding place, sallying forth at night to plunder dovescots and hen-houses. It climbs but little, and shows far less activity than the marten. It feeds ordinarily on small mammals, such as rabbits, hamsters, rats and mice, on such birds as it can catch, especially poultry and pigeons, and also on snakes, lizards, frogs, fish and eggs. Its prey is devoured only in its lair; but, even though it can carry away but a single victim, it commonly kills everything that comes in its way, often destroying all the inhabitants of a hen-house in order to gratify its passion for slaughter. The pairing time is towards the end of the winter, and the young, from three to eight in number, are born in April or May, after a period of gestation of about two months. The young, if taken early, may be easily

trained, like ferrets, for rabbit-catching. The polecat is very tenacious of life and will bear many severe wounds before succumbing; it is also said to receive with impunity the bite of the adder. Its fetid smell has become proverbial. To this it is indebted for its generic name *Putorius* (derived, as are also the low Lat. *putacius*, Fr. *putois*, and Ital. *putoia*, from *puteo*), as well as the designation fowmart (i.e. foul marten) and its other English names, fitchet, fitchew. Attempts to account for the first syllable of the word polecat rest entirely on conjecture.

The Siberian polecat (*Putorius ovserrmanni*) is very like the European in size, colour and proportions, but with head and back both nearly or quite white, and skull more heavily built and sharply constricted behind the orbits, at least in fully adult individuals. It inhabits the greater part of south-western Siberia, extending from Tibet into the steppes of south-eastern European Russia.

The black-footed or American polecat (*Putorius nigripes*) is a native of the central plateau of the United States, and extends southwards into Texas. It is often called the prairie-dog hunter, as it is nearly always found in the warrens of that animal. The fur is cream-yellow, the legs are brown, and the feet and tail-tip black.

The mottled polecat (*Putorius sarmaticus*), a species occurring in southern Russia and south-western Asia, and extending from eastern Poland to Afghanistan, differs from other polecats both by its smaller size and its remarkable coloration, the whole of the upper-parts being marbled with large irregular reddish spots on a white ground, while the under-side, limbs and tail are deep shining black. Its habits appear to be much like those of the common polecat. (R. L.')

POLENTA, DA, the name of a castle in Romagna, from which came the noble and ancient Italian family of Da Polenta. The founder of the house is said to have been Guido, surnamed l'Antico or the Elder, who wielded great authority in Ravenna in the 13th century. His grandson Guido Novello upheld the power of the house and was also *capitano del popolo* at Bologna; he was overthrown in 1322 and died the following year. His chief claim to renown lies in the fact that in 1321 he gave hospitality to the poet Dante, who immortalized the tragic history of Guido's daughter Francesca, unhappily married to Malatesta, lord of Rimini, in an episode of the *Inferno*. Guido's kinsman Ostasio I. was lord of Cervia and Ravenna from 1322 to 1329, and, after being recognized as a vassal of the Holy See, again became independent and went over to the house of Este, whom he served faithfully in their struggles with the Church until his death in 1346. His son Bernardino, who succeeded him as lord of Ravenna in 1346, was deposed in 1347 by his brothers, Pandolfo and Lamberto II., but was reinstated a few months later and ruled until his death in 1359; he was famous for his profligacy and cruelty. His son Guido III. ruled more mildly and died in 1390. Then followed Ostasio II. (d. 1396), Obizzo (d. 1431), Pietro (d. 1404), Aldobrandino (d. 1406), all sons of Guido III. Ostasio III. (or V.), son of Obizzo, was at first allied with the Venetians; later he went over to the Milanese, and, although he again joined the Venetians, the latter never forgave his intrigue with their enemies, and in 1441 they deprived him of his dominions. He died in a monastery in 1447.

POLE-VAULTING, the art of springing over an obstacle with the aid of a pole or staff. It is probable that an exercise of the kind was a feature of Greek gymnastics, but with this exception there is no record of its ancient practice as a sport. As a practical means of passing over such natural obstacles as canals and brooks it has been made use of in many parts of the world, for instance in the marshy provinces along the North Sea and the great level of the fens of Cambridgeshire, Huntingdonshire, Lincolnshire and Norfolk. The artificial draining of these marshes brought into existence a network of open drains or canals intersecting each other at right angles. In order to cross these dryshod, and at the same time avoid tedious round-about journeys over the bridges, a stack of jumping poles was

kept at every house, which were commonly used for vaulting over the canals.

As a sport, pole-vaulting made its appearance in Germany in the first part of the 19th century, when it was added to the gymnastic exercises of the *Turner* by Johann C. F. GutsMuths and Frederick L. Jahn. In Great Britain it was first commonly practised at the Caledonian games. It is now an event in the athletic championships of nearly all nations. Although strength and good physical condition are essential to efficiency in pole-vaulting, skill is a much more important element. Broad-jumping with the pole, though the original form of the sport, has never found its way into organized athletics, the high jump being the only form recognized. The object is to clear a bar or lath supported upon two uprights without knocking it down. The pole, of hickory or some other tough wood, is from 13 to 15 ft. long and 1½ in. thick at the middle, tapering to 1½ in. at the ends, the lower of which is truncated to prevent sinking into the earth and shod with a single spike to avoid slipping. A hole in which to place the end of the pole is often dug beneath the bar. In holding the pole the height of the cross-bar is first ascertained, and the right hand placed, with an undergrip, about 6 in. above this point, the left hand, with an over-grip, being from 14 to 30 in. below the right. The vaulter then runs towards the bar at full speed, plants the spiked end of the pole in the ground about 18 in. in front of the bar and springs into the air, grasping the pole firmly as he rises. As he nears the bar he throws his legs forward, and, pushing with shoulders and arms, clears it, letting the pole fall backwards. In Great Britain the vaulter is allowed to climb the pole when it is at the perpendicular. Tom Ray, of Ulverston in Lancashire, who was champion of the world in 1887, was able to gain several feet in this manner. In the United States climbing is not allowed. Among the best British vaulters, using the climbing privilege, have been Tom Ray, E. L. Stones, R. Watson and R. D. Dickinson; Dickinson having cleared 11 ft. 9 in. at Kildermister in 1891. The record pole-vault is 12 ft. 6½ in., made by W. Dray of Yale in 1907.

POLICE (Fr. *police*, government, civil administration, a police force, Gr. *polireia*, constitution, condition of a state; *polis*, city, state), a term used of the enforcement of law and order in a state or community, of the department concerned with that part of the civil administration, and of the body or force which has to carry it into execution. The word was adopted in English in the 18th century and was disliked as a symbol of foreign oppression. The first official use appears, according to the *New English Dictionary*, in the appointment of "Commissioners of Police" for Scotland in 1714. A police system has been devised for the purpose of preventing evils and providing benefits. In its first meaning it protects and defends society from the dissidents, those who decline to be bound by the general standard of conduct accepted by the larger number of the law-abiding, and in this sense it is chiefly concerned with the prevention and pursuit of crime. It has a second and more extensive meaning as applied to the regulation of public order and enforcing good government.

United Kingdom.—The establishment of a systematic police force was of slow growth in England, and came into effect long after its creation abroad. A French king, Charles V., is said to have been the first to invent a police, "to increase the happiness and security of his people." It developed into an engine of horrible oppression, and as such was repugnant to the feelings of a free people. Yet as far back as the 13th century a statute, known as that of "Watch and Ward," was passed in the 13th year of Edward I. (1285), aimed at the maintenance of peace in the city of London. Two centuries later (1585) an act was passed for the better government of the city and borough of Westminster, and this act was re-enacted with extended powers in 1737 and soon succeeded by another (1777) with wider and stricter provisions. The state of London at that date, and indeed of the whole country at large, was deplorable. Crime was rampant, highwaymen terrorized the

roads, footpads infested the streets, burglaries were of constant occurrence, river thieves on the Thames committed depredations wholesale. The watchmen appointed by parishes were useless, inadequate, inefficient and untrustworthy, acting often as accessories in aiding and abetting crime. Year after year the shortcomings and defects were emphasized and some better means of protection were constantly advocated. At the commencement of the 19th century it was computed that there was one criminal to every twenty-two of the population. The efforts made at repression were pitifully unequal. In the district of Kensington, covering 15 sq. m., the protection afforded was dependent on three constables and three headboroughs. In the parish of Tottenham nineteen attempts at burglary were made in six weeks, and sixteen were entirely successful. In Spitalfields gangs of thieves stood at the street corners and openly rifled all who came near. In other parishes there was no police whatever, no defence, no protection afforded to the community but the voluntary exertions of individuals and "the honesty of the thieves." In those days victims of robberies constantly compounded with felonies and paid blackmail to thieves, promising not to prosecute on the restitution of a portion of the stolen property.

The crying need for reform and the introduction of a proper police was admitted by the government in 1829, when Sir Robert Peel laid the foundation of a better system. Much opposition was offered to the scheme, which was denounced as an insidious attempt to enslave the people by arbitrary and tyrannical methods. The police were to be employed, it was said, as the instruments of a new despotism, the enlisted members of a new standing army, under the centralized authority, riding roughshod over the peaceable citizens. But the guardians of order, under the judicious guidance of such sensible chiefs as Colonel Rowan and Sir Henry Maine, soon lived down the hostility first exhibited, and although one serious and lamentable collision occurred between the mob and the police in 1833, it was agreed two years later that the unfavourable impression at one time existing against the new police was rapidly diminishing, and that it had fully answered the purpose for which it was formed. Crime had already diminished; it was calculated that the annual losses inflicted on the public by the depredations of the dangerous classes had appreciably fallen and a larger number of convictions had been secured.

The formation of the metropolitan police was in due course followed by the extension of the principle to the provinces. Borough constabulary forces were established by the Municipal Corporation Act (1835), which entrusted their administration to the mayor and a watch committee, and this act was revised in 1882, when the general powers of this authority were defined. Acts of 1839 and 1840 permitted the formation by the justices of a paid county police force. Action in this case was optional, but after an interval of fifteen years the Police Act of 1856 made the rule compulsory, it being found that an efficient police force throughout England and Wales was necessary for the more effectual prevention and detection of crime, the suppression of vagrancy and the maintenance of good order. Local acts had already endowed Scotland with a police system, and in 1857, and again in 1862, counties were formed into police districts, and the police of towns and populous places was generally regulated. Ireland has two police forces; the Dublin metropolitan police originated in 1808, and in 1829 the provisions of Sir Robert Peel's act for London were embodied in the Police Law for Ireland.

The extent to which the metropolitan police has developed will best be realized by contrasting its numbers on first creation and the nature of the duties and functions that then appertained to it. The first act (the Metropolitan Police Act 1829) appointed to the metropolis, exclusive of the city of London, and constituted a police area having a radius of 12 m. from Charing Cross. Two justices of the peace were appointed, presently named commissioners of police, to administer the act under the immediate direction of the secretary of state for the home department. The first police office was located in Whitehall in Scotland Yard, from which it was removed in the autumn of 1890 to the new and imposing edifice on the Embankment, in which all branches are now concentrated, known as New Scotland Yard. The first constables

appointed were 3000 in number, who, when sworn in, enjoyed all the powers of the old constables under the common law, for preserving the peace, preventing robberies and other felonies, and apprehending offenders. The subdivision of the district into divisions, on much the same lines as now existing, was at once made for administrative convenience, and a proportion of officers was allotted to each in the various grades then first constituted and still preserved, comprising in ascending order, constables, sergeants, inspectors and superintendents. Some time later the grade of district superintendent was created, held by gentlemen of superior status and intelligence, to each of whom the control of a large section of the whole force, embracing a wide area, was entrusted. This grade has since been merged in that of chief constable, of whom there are four exercising powers of disciplinary supervision in the metropolitan districts, and a fifth who is assistant in the branch of criminal investigation. The supreme authority is vested in the home secretary, but the immediate command and control is exercised by the chief commissioner, with three assistants, replacing the two commissioners provided for in 1829.

After various parliamentary reports and some legislation by way of extension, an important act was passed in 1839 reciting that the system of police established had been found very inefficient and might be yet further improved (Metropolitan Police Act 1839). The metropolitan police district was extended to 15 m. from Charing Cross. The whole of the river Thames (which, in its course through London, so far as related to police matters, had been managed under distinct acts) was brought within it, and the collateral but not exclusive powers of the metropolitan police were extended to the royal palaces and 10 m. round, and to the counties adjacent to the district. Various summary powers for dealing with street and other offences were conferred. When the police was put on a more complete footing and the area enlarged, provision was made for the more effectual administration of justice by the magistrates of the metropolis (Metropolitan Police Courts Act 1839). The changes that occurred in magisterial functions are scarcely less remarkable than the transition from the parish constable to the organized police. The misdirected activity of the civil magistrate in the 17th century is illustrated by the familiar literature of Butler, Bunyan and others. The zeal of that age was succeeded by apathetic reaction, and it became necessary in the metropolis to secure the services of paid justices. At the beginning of the 19th century, outside of the city of London (where magisterial duties were, as now, performed by the lord mayor and aldermen), there were various public offices besides the Bow Street and Thames police offices where magistrates attended. To the Bow Street office was subsequently attached the "horse patrol"; each of the police offices had a fixed number of constables attached to it, and the Thames police had an establishment of constables and surveyors. The horse patrol was in 1836, as previously intended, placed under the new police. It became desirable that the horse patrol and constables allotted to the several police offices not interfered with by the Act of 1828 should be incorporated with the metropolitan police force. This was effected, and thus magisterial functions were completely separated from the duties of the executive police; for although the jurisdiction of the two justices, afterwards called commissioners, as magistrates extended to ordinary duties (except at courts of general or quarter sessions), from the first they took no part in the examination or committal for trial of persons charged with offences. No prisoners were brought before them. Their functions were in practice confined to the discipline of the force and the prevention and detection of offences, their action limited to having persons arrested or summoned to be dealt with by the ordinary magistrates, whose courts were not interfered with.

The aim and object of the police force remain the same as when first created, but its functions have been varied and extended in scope and intention. To secure obedience to the law is a first and principal duty; to deal with breaches of the rules made by authority, to detect, pursue and arrest offenders. Next comes the preservation of order, the protection of all reputable people, and the maintenance of public peace by checking riot and disturbance or noisy demonstration, by enforcing the observance of the thousand and one regulations laid down for the general good. The police have become the ministers of a social despotism resolute in its watchful care and control of the whole community, well-meaning and paternal, although when carried to extreme length the tendency is to diminish self-reliance and independence in the individual. The police are necessarily in close relation with the state; they are the direct representatives of the supreme government, the servants of the Crown and legislature. In England every constable when he joins the force makes a declaration and swears that he will serve the sovereign loyally and diligently, and to acquire the rights and privileges of a peace officer of and for the Crown.

The state employs police solely in the interests of the public welfare. No sort of espionage is attempted, no effort made to penetrate privacy; no claim to pry into the secret actions of law-abiding persons is or would be tolerated; the agents of authority must not seek information by underhand or unworthy means. In other countries the police system has been worked more arbitrarily; it has been used to check free speech, to interfere with the right of public meetings, and condemn the expression of opinion hostile to or critical of the ruling powers. An all-powerful police, minutely organized, has in some foreign states grown into a terrible engine of oppression and made daily life nearly intolerable. In England the people are free to assemble as they please, to march in procession through the streets, to gather in open spaces, to listen to the harangues, often forcibly expressed, of mob orators, provided always that no obstruction is caused or that no disorder or breach of the peace is threatened.

The strength of the metropolitan police in 1908 was 18,167, comprising 32 superintendents, 572 inspectors, 2378 sergeants and 15,185 constables. At the head is a commissioner, appointed by the home office; he is assisted by four assistant commissioners, one of whom was appointed under the Police Act 1909, in accordance with the recommendation of the Royal Commission on the Metropolitan Police 1906, his duty especially being to deal with complaints made by the public against the police. The metropolitan police are divided into 21 divisions, to which letters of the alphabet are assigned for purposes of distinction. There is in addition the Thames division, recruited mostly from sailors, charged with the patrol of the river and the guardianship of the shipping. To the metropolitan police also are assigned the control and guardianship of the various naval dockyards and arsenals.

The city of London has its own distinct police organization under a commissioner and assistant commissioner, and its functions extend over an area of 673 statute acres containing two courts of justice, those of the Guildhall and Mansion House, where the lord mayor and the aldermen are the magistrates. Although the area is comparatively small the rateable value is enormous. The force comprises 2 superintendents, 48 inspectors, 86 sergeants and 865 constables; also some 60 constables on private service duty.

The total police force of England and Wales in 1908 was 30,376, almost equally divided between counties and boroughs; that of Scotland numbered 5575. In Ireland the Royal Irish Constabulary is a semi-military force, numbering over 10,500; they police the whole of Ireland, except the city of Dublin, which is under the Dublin metropolitan police, a particularly fine body.

The most active and by no means the least efficient branch of the modern English police is that especially devoted to criminal investigation or the detection of crime. The detective is the direct descendant of the old "Bow Street runners" or "Robin Redbreasts"—so styled from their scarlet waistcoats—officers in attendance upon the old-fashioned police offices and despatched by the sitting magistrates to follow up any very serious crime in the interests of the public or at the urgent request of private persons. The "runners" had disappeared when the police organization introduced by Sir Robert Peel came into force in 1829, and at first no part of the new force was especially attributed to the detection of crime. They were much missed, but fifteen years elapsed before Sir James Graham (then home secretary) decided to allot a few constables in plain clothes for that purpose as a tentative measure. The first "detectives"—appointed numbered only a dozen, three inspectors and nine sergeants, to whom, however, six constables were shortly added as "auxiliaries," but the number was gradually enlarged as the manifold uses of the system became more and more obvious.

OTHER COUNTRIES.—*British India* is divided into police districts, the general arrangements of the system of the regular police, which dates from the disappearance of the East India Company, resembling in most respects those of the English police, but differing in details in the different presidencies. All are in uniform, trained to the use of firearms and drilled, and may be called upon to perform military duties. The superior officers are nearly all Europeans and many of them are military officers. The rest are natives, in Bombay chiefly Mahomedans. The organization of the police was not dealt with by the criminal code which came into force in 1863, but the code is full of provisions tending to make the force efficient. By that code as well as by the former code the police have a legal sanction for doing what by practice they do in England; they take evidence for their own information and guidance in the investigation of cases and are clothed with the power to compel the attendance of witnesses and question them. The smallness of the number of European magistrates, and other circumstances, make the police more important and relatively far more powerful in India than in England (Stephen). The difficulties in the way of ascertaining the truth and investigating false statements and

suppressed cases are very great. As regards the rural police of India every village headman and the village watchman as well as the village police office are required by the code to communicate to the nearest magistrate or the officer in charge of the nearest police station, whichever is nearest, any information respecting offenders. On the whole the system is very efficient. The police, which has numerous duties over and above those of the prevention and detection of crime, greatly aids a government so paternal as that of India in keeping touch with the widely extended masses of the population.

France.—It is a matter of history that under Louis XIV., who created the police of Paris, and in succeeding times, the most unpopular and unjustifiable use was made of police as a secret instrument for the purposes of despotic government. Napoleon availed himself largely of police instruments, especially through his minister Fouché. On the restoration of constitutional government under Louis Philippe, police action was less dangerous, but the danger revived under the second empire. The ministry of police, created by the act of the Directory in 1796, was in 1818 suppressed as an independent office, and in 1852 it was united with the ministry of the interior. The regular police organization, which preserves order, checks evil-doing, and "runs in" malefactors, falls naturally and broadly into two grand divisions, the administrative and the active, the police "in the office" and the police "out of doors." The first attends to the clerical business, voluminous and incessant. An army of clerks in the numerous bureaux, hundreds of patient government employés, the *ronde de nuit*, as they are contemptuously called, because they sit for choice on round leather cushions, are engaged constantly writing and filling in forms for hours and hours, day after day. The active army of police out of doors, which constitutes the second half of the whole machine, is divided into two classes: that in uniform and that in plain clothes. Every visitor to Paris is familiar with the rather theatrical-looking policeman, in his short frock-coat or cape, smart *béni* cocked on one side of his head, and with a sword by his side. The first is known by the title of *agent, sergent de ville, gardien de la paix*, and is a very useful public servant. He is almost invariably an old soldier, a *sergent* who has left the army with a first-class character, honesty and sobriety being indispensable qualifications.

These uniformed police are not all employed in the streets and arrondissements, but there is a large reserve composed of the six central brigades, as they are called, a very smart body of old soldiers, well drilled, well dressed and fully equipped; armed, moreover, with rifles, with which they mount guard when employed as sentries at the doors or entrance of the prefecture. In Paris *argot* the men of these six central brigades are nicknamed "*saissieux*" (vessels), because they carry on their collars the badge of the city of Paris—an ancient ship—while the sergeants in the town districts wear only numbers, their own individual number, and that of the quarter in which they serve. These *saissieux* claim to be the *élite* of the force; they come in daily contact with the *Garde de Paris*, horse and foot, a fine corps of city gendarmery, and, as competing with them, take a particular pride in themselves. Their comrades in the quarters resent this pretension and declare that when in contact with the people the *saissieux* make bad blood by their arrogance and want of tact. The principal business of four at least of these central brigades is to be on call when required to reinforce the out-of-door police at special times.

Of the two remaining central brigades one controls public carriages, the other the Halles, the great central market by which Paris is provided with a large part of its food. Every cab-stand is under the charge of its own policeman, who knows the men, notes their arrival and departure, and marks their general behaviour. Other police officers of the central brigades superintend the street traffic.

So much for the police in uniform. That in plain clothes, *en bourgeois*, as the French call it, is not so numerous, but fulfils a higher, or at least a more confidential mission. Its members are styled inspectors, not agents, and their functions fall under four principal heads. There is, first of all, the service of the *Sûreté*—in other words, of public safety—the detective department, employed entirely in the pursuit and capture of criminals; next comes the police, now amalgamated with the *Sûreté*, that watches over the morals of the capital and possesses arbitrary powers under the existing laws of France; then there is the *brigade de garnis*, the police charged with the supervision of all lodging-houses, from the commonest "sleep-sellers" shop, as it is called, to the grandest hotels. Last of all there is the brigade for enquiries, whose business it is to act as the eyes and ears of the prefecture.

The pay of the *gardiens de la paix* is from 1400 to 1700 francs; brigadiers get 2000 francs; *sous-brigadiers* 1800 francs; *officiers de paix* 3000 to 6000 francs. The proportion of police to inhabitants is one in 352.

Germany.—Taking the Berlin force as illustrative of the police system in the German Empire, police duties are as various as in France; the system includes a political police, controlling all matters relating to the press, societies, clubs and public and social amusements.

Police duties are carried out under the direction of the royal police presidency, the executive police force comprising a police colonel, with, besides commissaries of criminal investigations,

captains, lieutenants, acting-lieutenants, sergeant-majors and a large body of constables (*schutzmänner*).

It is computed that the proportion of population to police in Berlin is between 350 and 400 to each officer. The pay of the police is principally provided from fiscal sources and varies in an ascending scale from 1125 marks and lodging allowance for the lowest class of constable.

Austria.—Taking Vienna in the same way as illustrative of the Austrian police, it is to be observed that there are three branches: (1) administration; (2) public safety and judicial police; and (3) the government police. At the head of the police service in Vienna there is a president of police and at the head of each of the three branches there is an *Ober-polmeister* or chief commissary. The head of the government branch sometimes fills the office of president. Each of the branches is subdivided into departments, at the head of which are *Polmeister*. Passing over the subdivisions of the administrative branch, the public safety and judicial branch includes the following departments: the office for public safety, the central inquiry office and the record or *Erkenntnis*. The government police branch comprises three departments: the government police office, the press office, and the *Verordnungs* or office for the registration of societies. The proportion of police constables to the inhabitants is one to 436.

Belgium.—In Belgian municipalities the burgomasters are the heads of the force, which is under their control. The administrator of public safety is, however, specially under the minister of justice, who sees that the laws and regulations affecting the police are properly carried out, and he can call on all public functionaries to act in furtherance of that object. The administrator of public safety is specially charged with the administration of the law in regard to aliens, and this law is applied to persons stirring up sedition. The duty of the gendarmery, who constitute the horse and foot police, is generally to maintain internal order and peace. In Brussels as elsewhere the burgomaster is the head, but for executive purposes there is a chief commissary (subject, however, to the orders of the burgomaster), with assistant commissaries, and commissaries of divisions and other officers and central and other bureaux, with a body of agents (police constables) in each.

There are two main classes of police functions recognized by law, the administrative and the judicial police, the former engaged in the daily maintenance of peace and order and so preventing offences, the latter in the investigation of crime and tracing offenders; but the duties are necessarily performed to a great extent by the same agents. The two other functions of the judicial police are, however, limited to the same classes of officers, and they perform the same duties as in Paris—the law in practice there being expressly adopted in Brussels.

In **Switzerland**, which is sometimes classed with Belgium as among the least-policed states of Europe, the laws of the cantons vary. In some respects they are stricter than in Belgium or even in France. Thus a *permis de séjour* is sometimes required where none is in practice necessary in Paris or Brussels.

Russia will till lately the most police-ridden country in the world; not even in France in the worst days of the monarchy were the people so much in the hands of the police. To give some idea of the wide-reaching functions of the police the power assumed in matters momentous and quite insignificant, we may quote from the list of circulars issued by the minister of the interior to the governors of the various provinces during four recent years. The governors were directed to regulate religious instruction in secular schools, to prevent horse-stealing, to control subscriptions collected for the holy places in Palestine, to regulate the advertisements of medicines and the printing on cigarette papers, to examine the quality of quinine soap and overlook the cosmetics and other toilet articles—such as soap, starch, brillantine, tooth-brushes and insect-powder—provided by chemists. They were to issue regulations for the proper construction of houses and villages, to exercise an active censorship over published price-lists and printed notes of invitation and visiting cards, as well as seals and rubber stamps. All private meetings and public gatherings, with the expressions of opinion and the class of subjects discussed, were to be controlled by the police.

The political or state police was the invention of Nicholas I. Alexander I. had created a ministry of the interior, but it was Nicholas who devised the second branch, which he designed for his own protection and the security of the state. After the insurrection of 1865, he created a special bulwark for his defence, and invented that secret police which grew into the notorious "Third Section" of the emperor's own chancery, and while it lasted, was the most dreaded power in the empire. It was practically supreme in the state, a ministry independent of all other ministries, placed quite above them and responsible only to the tsar himself.

United States.—The organization of police forces in the United States differs more or less in the different states of the Union. As a rule the force in cities is under municipal control, but to this rule there are numerous exceptions. In Boston, for instance, the three commissioners at the head of the force are appointed by the governor of Massachusetts. The force in New York City, alike from the standpoint of numbers and of the size and character

of the city, is the most important in the United States. It included in 1910 a commissioner appointed by the mayor and exercising a wide range of authority; four deputy commissioners; a chief inspector, who has immediate charge of the force and through whom all orders are issued; he is assisted by 18 inspectors, who are in charge of different sections of the city, and who carry out the orders of the chief; 87 captains, each of whom is in direct charge of a precinct; 583 sergeants; and last of all, the ordinary policemen; or patrolmen, as they are often called from the character of their duties. There is a separate branch, the detective bureau, composed of picked men, charged with the investigation and, still more, the prevention of crime. The total number of patrol men in 1909 was 8562. Appointments are for life, with pensions in case of disability and after a given number of years of service.

LITERATURE.—Patrick Colquhoun, *Treatise on the Police of the Metropolis* (1796); Pierre Clement, *La Police sous Louis XIV.* (1866); Maxime Du Camp, *Paris, ses organes, ses fonctions et sa vie* (1869-1875); Dr Norman Chevers, *Indian Medical Jurisprudence* (Calcutta, 1870); A. T. Crawford, *Reminiscences of an Indian Police Officer* (1894); C. R. W. Hervey, *Records of Indian Crime* (1892); Arthur Griffiths, *Mysteries of Police and Crime* (1903); Captain W. L. Melville Lee, *A History of Police in England* (Methuen, 1901); Sidney and Beatrice Webb, *English Local Government* (Longmans, 1906-1908); article by H. B. Simpson, "The Office of Constable," in the *English Historical Review* (October 1895); F. W. Maitland, *Justice and Police* (Macmillan, 1885); L. F. Fuld, *Police Administration* (New York, 1910). (A. G.)

POLICE COURTS, courts of summary jurisdiction, held in London and certain large towns of the United Kingdom by specially appointed and salaried magistrates. They were originally called "public offices" (Middlesex Justices Act 1792), but after the establishment of the police force, in 1829, they came to be called "police offices," although no change had taken place in their nature. They are so described in a report of a select committee which inquired into the system in 1837 and 1838; in the same report the magistrates who presided in the courts were first described as "police magistrates." Police offices were first officially described by their modern title in the Metropolitan Police Courts Act 1839. In 1839 there were nine police courts; since 1792 there had been three magistrates to each court, and the act of 1839 retained twenty-seven as the maximum number at any time (s. 2). In 1835 unsalaried justices ceased to sit in the police courts along with the paid magistrates. The Metropolitan Police Courts Act 1840 gave power to map out the whole of the metropolitan police district into police court divisions, and to establish police courts wherever necessary, the artificial limit of twenty-seven magistrates being at the same time preserved. Additional courts have from time to time been established by orders in council, and in 1910 there were in London fourteen courts with twenty-five magistrates. Their divisions are regulated by orders in council of 1903 and 1905; the nine original courts are Bow Street, Westminster, Marylebone, Marlborough Street, Worship Street, Clerkenwell, Thames, Tower Bridge and Lambeth.

The courts are held every day from 10 a.m. to 5 p.m. except on Sunday, Christmas Day, Good Friday or any day appointed for a public fast or thanksgiving or bank holiday. The Greenwich and Woolwich court, which comprises one division, is held at Greenwich in the morning and at Woolwich in the afternoon. The chief magistrate (sitting at Bow Street) receives a salary of £1800 a year and the other magistrates £1500 each. The magistrates are appointed by the Crown; they must have been practising barristers for seven years or stipendiary magistrates for some place in England or Wales. One police magistrate has the same powers as two justices, but may not act in anything which has to be done at special or petty sessions of all the justices acting in the division or at quarter sessions. He can do alone when sitting in a police court any act which any justice or justices can do under the Indictable Offences Act 1848, or under the Summary Jurisdiction Act; he has special powers under the Metropolitan Police Courts Act 1839, and is also given special powers under certain other acts. The Bow Street court has jurisdiction in extradition. The precedent of appointing salaried magistrates was followed for certain towns in the provinces by particular acts, and in 1863 the Stipendiary Magistrates Act gave power to towns and boroughs of 25,000 inhabitants and upwards to obtain a stipendiary magistrate.

POLIGNAC, an ancient French family, which had its seat in the Cevennes near Puy-en-Velay (Haute Loire). Its authentic pedigree can be traced to the 9th century, but in 1421 the male line became extinct. The heiress married Guillaume, sire de

Chalancon (not to be confused with the barons of Chalançon in Vivarais), who assumed the name and arms of Polignac. The first member of the family who was of any historical importance was Cardinal Melchior de Polignac (1661-1742), a younger son of Armand XVI., marquis de Polignac, who at an early age achieved distinction as a diplomatist. In 1695 he was sent as ambassador to Poland, where he contrived to bring about the election of the prince of Conti as successor to John Sobieski (1697). The subsequent failure of this intrigue led to his temporary disgrace, but in 1702 he was restored to favour, and in 1712 he was sent as the plenipotentiary of Louis XIV. to the Congress of Utrecht. During the regency he became involved in the Cellamare plot, and was relegated to Flanders for three years. From 1725 to 1732 he acted for France at the Vatican. In 1726 he received the archbishopric of Auch, and he died at Paris in 1742. He left unfinished a metrical refutation of Lucretius which was published after his death by the abbé de Rothelin (*Anti-Lucretius*, 1745), and had considerable vogue in its day. Count Jules de Polignac (d. 1817), grandnephew of the preceding, was created duke by Louis XVI. in 1780, and in 1782 was made postmaster-general. His position and influence at court were largely due to his wife, Gabrielle de Polastron, the bosom friend of Marie Antoinette; the duke and duchess alike shared the unpopularity of the court, and were among the first to "emigrate" in 1789. The duchess died shortly after the queen, but her husband, who had received an estate from Catherine II. in the Ukraine, survived till 1817. Of their three sons the second, Prince Jules de Polignac (1780-1847), played a conspicuous part in the clerical and ultra-royalist reaction after the Revolution. Under the empire he was implicated in the conspiracy of Cadoudal and Pichegru (1804), and was imprisoned till 1813. After the restoration of the Bourbons he held various offices, received from the pope his title of "prince" in 1820, and in 1823 was made ambassador to the English court. On the 8th of August 1829 he was called by Charles X. to the ministry of foreign affairs, and in the following November he became president of the council. His appointment was taken as symbolical of the king's intention to overthrow the constitution, and Polignac, with the other ministers, was held responsible for the policy which culminated in the issue of the Four Ordinances which were the immediate cause of the revolution of July 1830. On the outbreak of this he fled for his life, but, after wandering for some time among the wilds of Normandy, was arrested at Granville. His trial before the chamber of peers resulted in his condemnation to perpetual imprisonment (at Ham), but he benefited by the amnesty of 1836, when the sentence was commuted to one of exile. During his captivity he wrote *Considerations politiques* (1832). He afterwards spent some years in England, but finally was permitted to re-enter France on condition that he did not take up his abode in Paris. He died at St Germain on the 29th of March 1847.

POLIGNY, a town of eastern France, capital of an arrondissement in the department of Jura, 18 m. N.N.E. of Lons-le-Saunier on the Paris-Lyons railway. Pop. (1906), 3756. The town lies in the valley of the Glatine at the base of a hill crowned by the ruins of the old castle of Grimont, once the repository of the archives of the county of Burgundy. The church of Montivillard, its most remarkable building, dates in the oldest portions from the 12th century, its chief features being a Romanesque tower and reredos of the Renaissance period. Amongst the other old buildings of the town, the church of St Hippolyte, of the first half of the 15th century, and a convent-church serving as corn market are of some interest. The tribunal of first instance belonging to the arrondissement is at Arbois. Poligny has a sub-prefecture, a communal college and a school of daisy instruction. Under the name of *Polemniacum* the town seems to have existed at the time of the Roman occupation.

POLISH SUCCESSION WAR (1733-1735), the name given to a war which arose out of the competition for the throne of Poland between the elector August of Saxony, son of August II. (the Strong), and Stanislaus Leszcynski, the king of Poland installed thirty years before by Charles XII. of Sweden and displaced by

August the Strong when Charles's projects collapsed. The claims of Stanislaus were supported by France, Spain and Sardinia, those of the Saxon prince by Russia and the empire, the local quarrel being made the pretext for the settlement of minor outstanding claims of the great powers amongst themselves. The war was therefore a typical 18th century "war with a limited object," in which no one but the cabinets and the professional armies were concerned. It was fought on two theatres, the Rhine and Italy. The Rhine campaigns were entirely unimportant, and are remembered only for the last appearance in the field of Prince Eugene and Marshal Berwick—the latter was killed at the siege of Philippsburg—and the baptism of fire of the young crown prince of Prussia, afterwards Frederick the Great. In Italy, however, there were three hard-fought—though indecisive—battles, Parma (June 29, 1734), Luzzara (Sept. 19, 1734) and Bitonto (May 25, 1735), the first and last won by the Austrians, the second by the French and their allies. In Poland itself, Stanislaus, elected king in September 1733, was soon expelled by a Russian army and was afterwards besieged in Danzig by the Russians and Saxons (Feb.-June 1733).

POLITIAN (1454-1494). Angelo Ambrogini, known in literary annals as Angelo Poliziano or Politianus from his birth-place, was born at Montepulciano in Tuscany on the 14th of July 1454. His father, Benedetto, a jurist of good family and distinguished ability, was murdered by political antagonists for adopting the cause of Piero de' Medici in Montepulciano; and this circumstance gave his eldest son, Angelo, a claim on the family of Medici. At the age of ten the boy came to prosecute his studies at Florence, where he learned Latin under Cristoforo Landino, and Greek under Argyropoulos and Andronicos Kallistos. From Marsilio Ficino he imbibed the rudiments of philosophy. The precocity of his genius for scholarship and poetry was early manifested. At thirteen years of age he began to circulate Latin letters; at seventeen he sent forth essays in Greek versification; at eighteen he published an edition of Catullus. In 1470 he won for himself the title of *Homericus juvenis* by translating four books of the *Iliad* into Latin hexameters. Lorenzo de' Medici, who was then the autocrat of Florence and the chief patron of learning in Italy, took Poliziano into his household, made him the tutor of his children, and secured him a distinguished post in the university of Florence. Before he reached the age of thirty, Poliziano expounded the humanities with almost unexampled lustre even for that epoch of brilliant professors. Among his pupils could be numbered the chief students of Europe, the men who were destined to carry to their homes the *spolia optima* of Italian culture. Not to mention Italians, it will suffice to record the names of the German Reuchlin, the English Grocyn and Linacre, and the Portuguese Tessiras.

Poliziano had few advantages of person to recommend him. He was ungainly in form, with eyes that squinted, and a nose of disproportionate length. Yet his voice was rich and capable of fine modulation; his eloquence, ease of utterance and copious stream of erudition were incomparable. It was the method of professors at that period to read the Greek and Latin authors with their class, dictating philological and critical notes, emending corrupt passages in the received texts, offering elucidations of the matter, and pouring forth stores of acquired knowledge regarding the laws, manners, religious and philosophical opinions of the ancients. Poliziano covered nearly the whole ground of classical literature during the years of his professorship, and published the notes of his courses upon Ovid, Suetonius, Statius, the younger Pliny, Quintilian, and the writers of Augustan histories. He also undertook a recension of the text of the *Pandects* of Justinian, which formed the subject of one of his courses; and this recension, though it does not rank high in the scale of juristic erudition, gave an impulse to the scholarly criticism of the Roman code. At the same time he was busy as a translator from the Greek. His versions of Epictetus, Herodian, Hippocrates, Galen, Plutarch's *Eroticus* and Plato's *Charmides* delighted contemporaries by a certain limpid fluency of Latin style and grace of manner which distinguished him also

as an original writer. Of these learned labours the most universally acceptable to the public of that time were a series of discursive essays on philology and criticism, first published in 1489 under the title of *Miscellanea*. They had an immediate, a lasting and a wide renown, encouraging the scholars of the next century and a half to throw their occasional discoveries in the field of scholarship into a form at once so attractive and so instructive. Poliziano was not, however, contented with these simply professorial and scholastic compositions. Nature had endowed him with literary and poetic gifts of the highest order. These he devoted to the composition of Latin and Greek verses, which count among the best of those produced by men of modern times in rivalry with ancient authors. The *Mantua*, in which he pronounced a panegyric of Virgil; the *Ambra*, which contains a beautiful idyllic sketch of Tuscan landscape, and a studied eulogy of Homer; the *Rusticus*, which celebrated the pleasures of country life in no frigid or scholastic spirit; and the *Nesticus*, which was intended to serve as a general introduction to the study of ancient and modern poetry—these are the masterpieces of Poliziano in Latin verse, displaying an authenticity of inspiration, a sincerity of feeling, and a command of metrical resources which mark them out as original productions of poetic genius rather than as merely professorial lucubrations. Exception may be taken to their style, when compared with the best work of the Augustan or even of the Silver age. But what renders them always noteworthy to the student of modern humanistic literature is that they are in no sense imitative or conventional, but that they convey the genuine thoughts and emotions of a born poet in Latin diction and in metre moulded to suit the characteristics of the singer's temperament.

Poliziano was great as a scholar, as a professor, as a critic, and as a Latin poet at an age when the classics were still studied with the passion of assimilative curiosity, and not with the scientific industry of a later period. He was the representative hero of that age of scholarship in which students drew their ideal of life from antiquity and fondly dreamed that they might restore the past as to compete with the classics in production and bequeath a golden age of resuscitated paganism to the modern world. Yet he was even greater as an Italian poet. Between Boccaccio and Ariosto, no single poet in the mother tongue of Italy deserves so high a place as Poliziano. What he might have achieved in this department of literature had he lived at a period less preoccupied with humanistic studies, and had he found a congenial sphere for his activity, can only be guessed. As it is, we must reckon him as decidedly the foremost and indubitably the most highly gifted among the Italian poets who obeyed Lorenzo de' Medici's demand for a resuscitation of the vulgar literature. Lorenzo led the way himself, and Poliziano was more a follower in his path than an initiator. Yet what Poliziano produced, impelled by a courtly wish to satisfy his patron's whim, proves his own immeasurable superiority as an artist. His principal Italian works are the stanzas called *La Giostra*, written upon Giuliano de' Medici's victory in a tournament; the *Orfeo*, a lyrical drama performed at Mantua with musical accompaniment; and a collection of fugitive pieces, reproducing various forms of Tuscan popular poetry. *La Giostra* had no plan, and remained imperfect; but it demonstrated the capacities of the octave stanza for rich, harmonious and sonorous metrical effect. The *Orfeo* is a slight piece of work, thrown off at a heat, yet abounding in unpremeditated lyrical beauties, and containing in itself the germ both of the pastoral play and of the opera. The Tuscan songs are distinguished by a "roseate fluency," an exquisite charm of half romantic, but humorous abandonment to fancy, which mark them out as improvisations of genius. It may be added that in all these departments of Italian composition Poliziano showed how the taste and learning of a classical scholar could be engrained on the stock of the vernacular, and how the highest perfection of artistic form might be attained in Italian without a sacrifice of native spontaneity and natural flow of language.

It is difficult to combine in one view the several aspects presented to us by this many-sided man of literary genius. At

a period when humanism took the lead in forming Italian character and giving tone to European culture, he climbed with facility to the height of achievement in all the branches of scholarship which were then most seriously prized—in varied knowledge of ancient authors, in critical capacity, in rhetorical and poetical exuberance. This was enough at that epoch to direct the attention of all the learned men of Europe on Poliziano. At the same time, almost against his own inclination, certainly with very little enthusiasm on his part, he lent himself so successfully to Lorenzo de' Medici's scheme for resuscitating the decayed literature of Tuscany that his slightest Italian effusions exercised a potent influence on the immediate future. He appears before us as the dictator of Italian culture in a double capacity—as the man who most perfectly expressed the Italian conception of humanism, and brought erudition into accord with the pursuit of noble and harmonious form, and also as the man whose vernacular compositions were more significant than any others of the great revolution in favour of Italian poetry which culminated in Ariosto. Beyond the sphere of pure scholarship and pure literature Poliziano did not venture. He was present, indeed, at the attack made by the Pazzi conspirators on the persons of Lorenzo and Giuliano de' Medici, and wrote an interesting account of its partial success. He also contributed a curious document on the death of Lorenzo de' Medici to the students of Florentine history. But he was not, like many other humanists of his age, concerned in public affairs of state or diplomacy, and he held no office except that of professor at Florence. His private life was also uneventful. He passed it as a house-friend and dependant of the Medici, as the idol of the learned world, and as a simple man of letters for whom (with truly Tuscan devotion to the Saturnian country) rural pleasures were always acceptable. He was never married; and his morals incurred suspicion, to which his own Greek verses lend a certain amount of plausible colouring. In character Poliziano was decidedly inferior to the intellectual and literary eminence which he displayed. He died, half broken-hearted by the loss of his friend and patron Lorenzo de' Medici, on the 24th of September 1494, just before the wave of foreign invasion which was gathering in France swept over Italy.

For the life and works of Politian, see F. O. Mencken (Leipzig, 1736), a vast repository of accumulated erudition; Jac. Mähly, *Agapetus Politianus* (Leipzig, 1864); Carducci's edition of the Italian poems (Florence, Barbera, 1863); Del Lungo's edition of the Italian prose works and Latin and Greek poems (Florence, Barbera, 1867); the *Opera omnia* (Basel, 1534); Groswell's English *Life of Politian* (1805); Roscoe's *Lorenzo de' Medici* (10th ed., 1851); J. Addington Symonds's *Renaissance in Italy*, and translations from Poliziano's Italian poems in Symonds's *Sketches and Studies in Italy*, which include the *Orfeo*. (J. A. S.)

POLK, JAMES KNOX (1795-1849), eleventh president of the United States, was born in Mecklenburg county, North Carolina, on the 2nd of November 1795. In 1806 he crossed the mountains with his parents and settled in what is now Maury county, Tennessee. He graduated from the university of North Carolina in 1818, studied law in the office of Felix Grundy (1777-1840) at Nashville in 1819-1820, was admitted to the bar in 1820, and began to practise in Columbia, the county-seat of Maury county. After two years of service (1823-1825) in the state House of Representatives, he represented the sixth Tennessee district in the National House of Representatives from 1825 to 1839. In the party conflicts which succeeded the presidential election of 1824 he sided with the Jackson-Van Buren faction, and soon became recognized as leader of the Democratic forces. He was speaker from 1835 until 1839, when he retired from Congress to become governor of Tennessee. His administration (1839-1841) was successful, but he was unable to overcome the popular Whig movement of that period, and was defeated in 1841 and again in 1843. When the Democratic national convention met in Baltimore in 1844 he was mentioned as a possible candidate for the vice-presidency, but was suddenly brought forward as a "dark horse" and selected to head the ticket. Finding it impossible under the two-thirds rule to nominate their candidate, the followers of Van Buren brought forward Polk, who was popular

in the South, in order to defeat Lewis Cass and James Buchanan. George Bancroft, the historian, has asserted that this suggestion came originally from him, and Gideon J. Pillow, Polk's intimate friend, did much to bring about the nomination.

The unequivocal stand of Polk and his party in favour of the immediate annexation of Texas and the adoption of a vigorous policy in Oregon contrasted favourably with the timid vacillations of Henry Clay and the Whigs. Polk was elected, receiving 170 electoral votes to 105 for his opponent Clay. In forming his cabinet he secured the services of James Buchanan of Pennsylvania; as secretary of state, Robert J. Walker of Mississippi, as secretary of the treasury, William L. Marcy of New York, as secretary of war, and George Bancroft, then of Massachusetts, as secretary of the navy.¹ There is no doubt that each of these men, and Bancroft in particular, influenced the policy of the administration, yet the historian James Schouler, who has made a careful study of the Polk papers, is doubtless correct in saying that the president himself was "the framer of the public policy which he carried into so successful execution, and that instead of being led (as many might have imagined) by the more famous statesmen of his administration and party who surrounded him, he in reality led and shaped his own executive course." Bancroft's opinion is that Polk was "prudent, far-sighted, bold, exceeding any Democrat of his day in his undeviatingly correct exposition of Democratic principles."

The four chief events of President Polk's administration were the final establishment of the independent treasury system, the reduction of the tariff by the Walker Bill of 1846, the adjustment of the Oregon boundary dispute with Great Britain by the treaty concluded on the 15th of June 1846, and the war with Mexico and the consequent acquisition of territory in the south-west and west. The first three of these were recommended in his first annual message, and he privately announced to Bancroft his determination to seize California. The independent treasury plan originated during Van Buren's administration as a Democratic measure; it had been repealed by the Whigs in 1841, and was now re-enacted. Protectionists contend that the tariff legislation of 1846 was in direct violation of a pledge given to the Democrats of Pennsylvania in a letter written by Polk during the campaign to John K. Kane of Philadelphia. Briefly summarized, this letter approves of a tariff for revenue with incidental protection, whereas the annual message of the 2nd of December 1845 criticizes the whole theory of protection and urges the adoption of a revenue tariff just sufficient to meet the needs of the government conducted on an economical basis. It is difficult to determine whether this was always his idea of incidental protection, or whether his views were changed after 1844 through the influence of Walker and the example set by Sir Robert Peel in Great Britain, or whether he was simply "playing politics" to secure the protectionist vote in Pennsylvania.

The one overshadowing issue of the time, however, was territorial expansion. Polk was an ardent expansionist, but the old idea that his policy was determined entirely by a desire to advance the interests of slavery is no longer accepted. As a matter of fact, he was personally in favour of insisting upon 54° 40' as the boundary in Oregon, and threw upon Congress the responsibility for accepting 49° as the boundary, and he approved the acquisition of California, Utah and New Mexico, territory from which slavery was excluded by geographical and climatic conditions. Furthermore a study of his manuscript diary now shows that he opposed the efforts of Walker and Buchanan in the Cabinet, and of Daniel S. Dickinson (1800-1866) of New York and Edward A. Hannegan (d. 1859) of Indiana, in the Senate, to retain the whole of Mexico, territory in which slavery might have thrived. At the close of his term (March 4, 1849) Polk retired to his home in Nashville, Tennessee, where he died on the 15th of the following June.

¹ Bancroft served until September 1846, when he was appointed minister to England. He was succeeded as secretary of the navy by John J. Mason, who had previously held the office of attorney-general.

See John S. Jenkins, *James Knox Polk* (Auburn and Buffalo, 1850), and L. B. Chase, *History of the Polk Administration* (New York, 1850), both of which contain some documentary material, but are not discriminating in their method of treatment. George Bancroft contributed a good short sketch to J. G. Wilson's *Presidents of the United States* (New York, 2d ed., 1894). He made copies of the Polk manuscripts and was working upon a detailed biography at the time of his death in 1891. These copies, now deposited in the Lenox Library, New York City, contain a diary in 24 typewritten volumes, besides some correspondence and other private papers. They have been used by James Schouler in his *Historical Briefs* (New York, 1896), and by E. G. Bourne in an article entitled "The Proposed Absorption of Mexico in 1847-1848," published in the *Annual Report of the American Historical Association for 1890*, i. 157-169 (Washington, 1900). Bourne discusses the part which Polk took in preventing the complete absorption of Mexico. See also the *Diary of James K. Polk . . . 1845 to 1849* (Chicago, 4 vols., 1910), edited by M. M. Quaife.

(W. R. S. *)

POLK, LEONIDAS (1806-1864), American soldier, was born at Raleigh, North Carolina, on the 10th of April 1806, and was a cousin of James Knox Polk, president of the United States. He was educated at West Point, but afterwards studied theology and took orders in the Protestant Episcopal Church in 1831. In 1838 he became missionary bishop of the South-West, Arkansas, Indian Territory, Louisiana, Alabama and Mississippi, and in 1841 he was consecrated bishop of Louisiana. His work in the Church was largely of an educational kind, and he played a prominent part in movements for the establishment of higher

educational institutions in the South. At the outbreak of the Civil War in 1861 he resigned his bishopric and, like many other clergymen and ministers of religion, entered the army which was raised to defend the Confederacy. His rank in the hierarchy and the universal respect in which he was held in the South, rather than his early military education, caused him to be appointed to the important rank of major-general. He fortified the post of Columbus, Kentucky, the foremost line of defence on the Mississippi, against which Brigadier-General U. S. Grant directed the offensive reconnaissance of Belmont in the autumn. In the following spring, the first line of defence having fallen, Polk commanded a corps at Shiloh in the field army commanded by Albert Sidney Johnston and Beauregard. In October 1862 he was promoted lieutenant-general, and thenceforward he commanded one of the three corps of the army of Tennessee under Bragg and afterwards was in charge of the Department of Alabama, Mississippi and East Louisiana. He was killed in the fighting in front of Marietta, while reconnoitring near Pine Mountain, Georgia, on the 14th of June 1864.

See *Life*, by his son W. M. Polk. (1893).

POLKA (either from the Czech *půlka*, half, with an allusion to the short steps characteristic of the dance, or from the Polish *Polka*, feminine of *Polak*, a Pole), a lively dance of Bohemian origin, danced to music written in $\frac{3}{4}$ time. (See DANCE.)

END OF TWENTY-FIRST VOLUME

1
2
3
4
5
6
7
8
9
10
11
12
13
14
15
16
17
18
19
20
21
22
23
24
25
26
27
28
29
30
31
32
33
34
35
36
37
38
39
40
41
42
43
44
45
46
47
48
49
50
51
52
53
54
55
56
57
58
59
60
61
62
63
64
65
66
67
68
69
70
71
72
73
74
75
76
77
78
79
80
81
82
83
84
85
86
87
88
89
90
91
92
93
94
95
96
97
98
99
100

Stanford University Libraries



3 6105 024 854 338

CECIL H. GREEN LIBRARY
STANFORD UNIVERSITY LIBRARIES
STANFORD, CALIFORNIA 94305-6004
(650) 723-1493

gncirc@sulmail.stanford.edu

All books are subject to recall.

DATE DUE

--	--